



When you installing AGP card, please make sure the following notice is fully understood and practiced. If your AGP card has "AGP 4X notch"(show below), please make sure your AGP card is AGP 4X (1.5V).



Do not use AGP 2X card (3.3V) in this motherboard. It will burn and damage the motherboard due to Intel® 845(E/G) / 850(E) chipset can't support AGP 2X(3.3V).



Example 1: Diamond Vipper V770 golden finger is compatible with 2X/4X mode AGP slot. It can be switched between AGP 2X(3.3V) or 4X (1.5V) mode by adjusting the jumper. The factory default for this card is 2X (3.3V). If you install this card in GA-8IHPX(or any AGP 4X only) motherboards without switching the jumper to 4X mode (1.5V), it will burn the motherboard.

Example 2: Some ATi Rage 128 Pro graphics cards made by "Power Color", the graphics card manufacturer & some SiS 305 cards, their golden finger is compatible with 2X/4X mode AGP slot, but they support 2X(3.3V) only. If you install this card in GA-8IHPX (or any AGP 4X only) motherboards, it will burn the motherboard.

Note : Although Gigabyte's AG32S(G) graphics card is based on ATi Rage 128 Pro chip, the design of AG32S(G) is compliance with AGP 4X (1.5V) specification. Therefore, AG32S(G) will work fine with Intel® 845(E/G) / 850(E) based motherboards.



- ☛ The author assumes no responsibility for any errors or omissions that may appear in this document nor does the author make a commitment to update the information contained herein.
- ☛ Third-party brands and names are the property of their respective owners.
- ☛ Please do not remove any labels on motherboard, this may void the warranty of this motherboard.
- ☛ Due to rapid change in technology, some of the specifications might be out of date before publication of this booklet.



WARNING: Never run the processor without the heatsink properly and firmly attached. PERMANENT DAMAGE WILL RESULT!

Mise en garde : Ne faites jamais tourner le processeur sans que le dissipateur de chaleur soit fixé correctement et fermement. UN DOMMAGE PERMANENT EN RÉSULTERA !

Achtung: Der Prozessor darf nur in Betrieb genommen werden, wenn der Wärmeleiter ordnungsgemäß und fest angebracht ist. DIES HAT EINEN PERMANENTEN SCHADEN ZUR FOLGE!

Advertencia: Nunca haga funcionar el procesador sin el dissipador de calor instalado correcto y firmemente. ¡SE PRODUCIRÁ UN DAÑO PERMANENTE!

Aviso: Nunca execute o procesador sem o dissipador de calor estar adequado e firmemente conectado. O RESULTADO SERÁ UM DANO PERMANENTE!

警告: 將散熱板牢固地安裝到處理器上之前，不要運行處理器。過熱將永遠損壞處理器！

警告: 將散熱器牢固地安裝到處理器上之前，不要運行處理器。過熱將永遠損壞處理器！

경고: 히트싱크를 제대로 또 단단히 부착시키지 않은 채 프로세서를 구동시키지 마십시오. 영구적 고장이 발생할 수 있습니다!

警告: 永久的な損傷を避くため、ヒートシンクを正しくしっかりと取り付けるまでは、プロセッサを動作させないようにしてください。

Declaration of Conformity

We, Manufacturer/Importer
(full address)

G.B.T. Technology Trading GmbH
Ausschlager Weg 41, 1F, 20537 Hamburg, Germany

declare that the product
(description of the apparatus, system, installation to which it refers)

Mother Board

GA-81HXP

is in conformity with

(reference to the specification under which conformity is declared)
in accordance with 89/336 EEC-EMC Directive

- | | | | |
|---|--|--|--|
| <input type="checkbox"/> EN 55011 | Limits and methods of measurement of radio disturbance characteristics of industrial, scientific and medical (ISM) high frequency equipment | <input type="checkbox"/> EN 61000-3-2*
<input checked="" type="checkbox"/> EN 60555-2 | Disturbances in supply systems cause by household appliances and similar electrical equipment "Harmonics" |
| <input type="checkbox"/> EN 55013 | Limits and methods of measurement of radio disturbance characteristics of broadcast receivers and associated equipment | <input type="checkbox"/> EN 61000-3-3*
<input checked="" type="checkbox"/> EN 60555-3 | Disturbances in supply systems cause by household appliances and similar electrical equipment "Voltage fluctuations" |
| <input type="checkbox"/> EN 55014 | Limits and methods of measurement of radio disturbance characteristics of household electrical appliances, portable tools and similar electrical apparatus | <input checked="" type="checkbox"/> EN 50081-1
<input checked="" type="checkbox"/> EN 50082-1 | Generic emission standard Part 1:
Residual commercial and light industry

Generic immunity standard Part 1:
Residual commercial and light industry |
| <input type="checkbox"/> EN 55015 | Limits and methods of measurement of radio disturbance characteristics of fluorescent lamps and luminaries | <input type="checkbox"/> EN 55081-2 | Generic emission standard Part 2:
Industrial environment |
| <input type="checkbox"/> EN 55020 | Immunity from radio interference of broadcast receivers and associated equipment | <input type="checkbox"/> EN 55082-2 | Generic emission standard Part 2:
Industrial environment |
| <input checked="" type="checkbox"/> EN 55022 | Limits and methods of measurement of radio disturbance characteristics of information technology equipment | <input type="checkbox"/> ENV 55104 | Immunity requirements for household appliances tools and similar apparatus |
| <input type="checkbox"/> DIN VDE 0855
<input type="checkbox"/> part 10
<input type="checkbox"/> part 12 | Cabled distribution systems; Equipment for receiving and/or distribution from sound and television signals | <input type="checkbox"/> EN50091-2 | EMC requirements for uninterruptible power systems (UPS) |

CE marking



(EC conformity marking)

The manufacturer also declares the conformity of above mentioned product with the actual required safety standards in accordance with LVD 73/23 EEC

- | | | |
|-----------------------------------|---|-------------------------------------|
| <input type="checkbox"/> EN 60065 | Safety requirements for mains operated electronic and related apparatus for household and similar general use | <input type="checkbox"/> EN 60950 |
| <input type="checkbox"/> EN 60335 | Safety of household and similar electrical appliances | <input type="checkbox"/> EN 50091-1 |

Manufacturer/Importer

Date : May. 31, 2002

(Stamp)

Signature:

Timmy Huang

Name:

Timmy Huang

DECLARATION OF CONFORMITY

Per FCC Part 2 Section 2.1077(a)



Responsible Party Name: G.B.T. INC. (U.S.A.)

**Address: 17358 Railroad Street
City of Industry, CA 91748**

Phone/Fax No: (818) 854-9338/ (818) 854-9339

hereby declares that the product

Product Name: Motherboard

Model Number: GA-8IHX P

Conforms to the following specifications:

FCC Part 15, Subpart B, Section 15.107(a) and Section 15.109
(a), Class B Digital Device

Supplementary Information:

This device complies with part 15 of the FCC Rules. Operation is subject to the following two conditions: (1) This device may not cause harmful and (2) this device must accept any interference received, including that may cause undesired operation.

Representative Person's Name: ERIC LU

Signature: *Eric Lu*

Date: May 31, 2002

GA-8IHP
P4 Titan-RDRAM Motherboard

USER'S MANUAL

Pentium®4 Processor Motherboard
Rev. 2101
12ME-8IHP-2101

Table Of Content

Item Checklist	4
WARNING!	4
Chapter 1 Introduction	5
Summary of Features	5
GA-8IHX Motherboard Layout	7
Chapter 2 Hardware Installation Process	8
Step 1: Install the Central Processing Unit (CPU)	9
CPU Installation	9
CPU Heat Sink Installation	10
Step 2: Install memory modules	11
Introduce RIMM (Rambus In-line Memory Module)	12
Step 3: Install expansion cards	13
Step 4: Connect ribbon cables, cabinet wires, and power supply	14
Step 4-1: I/O Back Panel Introduction	14
Step 4-2: Connectors Introduction	16
Step 4-3: ATX 12V Power Supply Introduction	23
Chapter 3 BIOS Setup	24
The Main Menu (For example: BIOS Ver. :F1)	26
Standard CMOS Features	28
Advanced BIOS Features	31
Advanced Chipset Features	33
Integrated Peripherals	37

Power Management Feature	43
PNP/PCI Configurations	47
PC Health Status	49
Set Supervisor / User Password	51
Load Optimized Defaults	52
Load Fail-Safe Defaults	53
Save & Exit Setup	54
Exit Without Saving	55
Chapter 4 Technical Reference	56
Block Diagram	56
Dual BIOS / Q-Flash Introduction	57
Four Speaker & SPDIF Introduction	66
@ BIOS Introduction	70
Easy Tune™ 4 Introduction	71
Chapter 5 Appendix	72

Item Checklist

- | | |
|---|---|
| <input checked="" type="checkbox"/> The GA-8IHX motherboard | <input checked="" type="checkbox"/> GA-8IHX User's manual |
| <input checked="" type="checkbox"/> I/O Shield | <input checked="" type="checkbox"/> CRIMM x 2 |
| <input checked="" type="checkbox"/> Quick PC Installation Guide | <input checked="" type="checkbox"/> Floppy cable x 1 |
| <input checked="" type="checkbox"/> IDE cable x 3 | <input checked="" type="checkbox"/> USB cable x 2 |
| <input checked="" type="checkbox"/> CD for motherboard driver & utility | <input checked="" type="checkbox"/> SPD-KIT x 1 |

WARNING!



Computer motherboards and expansion cards contain very delicate Integrated Circuit (IC) chips. To protect them against damage from static electricity, you should follow some precautions whenever you work on your computer.

1. Unplug your computer when working on the inside.
2. Use a grounded wrist strap before handling computer components. If you do not have one, touch both of your hands to a safely grounded object or to a metal object, such as the power supply case.
3. Hold components by the edges and try not touch the IC chips, leads or connectors, or other components.
4. Place components on a grounded antistatic pad or on the bag that came with the components whenever the components are separated from the system.
5. Ensure that the ATX power supply is switched off before you plug in or remove the ATX power connector on the motherboard.

Installing the motherboard to the chassis...

If the motherboard has mounting holes, but they don't line up with the holes on the base and there are no slots to attach the spacers, do not become alarmed you can still attach the spacers to the mounting holes. Just cut the bottom portion of the spacers (the spacer may be a little hard to cut off, so be careful of your hands). In this way you can still attach the motherboard to the base without worrying about short circuits. Sometimes you may need to use the plastic springs to isolate the screw from the motherboard PCB surface, because the circuit wire may be near by the hole. Be careful, don't let the screw contact any printed circuit write or parts on the PCB that are near the fixing hole, otherwise it may damage the board or cause board malfunctioning.

Chapter 1 Introduction

Summary of Features

Form Factor	<ul style="list-style-type: none"> • 30.5cm x 24.4cm ATX size form factor, 6 layers PCB.
CPU	<ul style="list-style-type: none"> • Socket 478 for Intel® Micro FC-PGA2 Pentium® 4 processor • Intel Pentium®4 400/533MHz FSB • Support Intel® Pentium® 4 (Northwood, 0.13 μm) processor • 2nd Level cache depend on CPU
Chipset	<ul style="list-style-type: none"> • Chipset 82850E HOST/AGP/Controller • ICH4 I/O Controller Hub
Memory	<ul style="list-style-type: none"> • 4 184-pin RIMM Sockets • Supports 4 x PC800 RIMM or 4 x PC1066 RIMM DIMM • Dual direct RDRAM channel • Supports up to 2GB (Max)
I/O Control	<ul style="list-style-type: none"> • Winbond W83627HF
Slots	<ul style="list-style-type: none"> • 1 CNR(Communication and Networking Riser) Slot • 1 AGP support 4X(1.5V) device • 6 PCI slot supports 33MHz & PCI 2.2 compliant
On-Board IDE	<ul style="list-style-type: none"> • 2 IDE bus master (DMA33/ATA66/ATA100) IDE ports for up to 4 ATAPI devices • IDE3 and IDE4 Compatible with RAID, Ultra ATA133/100.
On-Board Peripherals	<ul style="list-style-type: none"> • 1 Floppy port supports 2 FDD with 360K, 720K, 1.2M, 1.44M and 2.88M bytes. • 1 Parallel port supports Normal/EPP/ECP mode • 2 Serial ports (COMA&COMB) • 6 x USB 2.0/1.1 by ICH4 • 4 x USB 2.0/1.1by NEC D720100AS1 • 1 IrDA connector for IR/CIR
Hardware Monitor	<ul style="list-style-type: none"> • CPU/Power/System Fan Revolution detect • CPU Overheat Warning • System Voltage Detect
On-Board LAN	<ul style="list-style-type: none"> • Build in RTL8100BL Chipset
On-Board USB 2.0	<ul style="list-style-type: none"> • NEC D720100AS1 Chipset

to be continued.....

On-Board MS,SD,SC	<ul style="list-style-type: none">• Winbond SMART @I/O Chipset (Memory Stick , Security Digital and SC header)
On-Board Sound	<ul style="list-style-type: none">• Creative CT5880 Sound Chipset + Sigmatel 9708T CODEC• 4 channel audio CODEC• Line In/Line Out/Mic In/Game Port/CD In/AUX IN/SPDIF (5.1 channel)
On-Board RAID	<ul style="list-style-type: none">• Onboard Promise PDC20276• Support data striping (RAID 0) or mirroring (RAID 1)• Supports concurrent dual IDE controller operation• Supports IDE bus master operation• Displays status and error checking messages during boot-up• Mirroring supports automatic background rebuilds• Features LBA and Extended Interrupt13 drive translation in controller onboard BIOS
PS/2 Connector	<ul style="list-style-type: none">• PS/2 Keyboard interface and PS/2 Mouse interface
BIOS	<ul style="list-style-type: none">• Licensed AMI BIOS, 4M bit FWH• Supports Dual BIOS / Q-Flash / Multi Language
Additional Features	<ul style="list-style-type: none">• PS/2 Keyboard power on by password• PS/2 Mouse power on• External Modem wake up• STR(Suspend-To-RAM)• Wake on LAN• AC Recovery• USB KB/Mouse wake up from S3• Supports @BIOS• Supports EasyTune4• Supports Face Wizard
Special Features	<ul style="list-style-type: none">• Over Voltage (RIMM/AGP/CPU)• Over Clock (CPU/PCI/AGP)

- Please set the CPU host frequency in accordance with your processor's specifications. We don't recommend you to set the system bus frequency over the CPU's specification because these specific bus frequencies are not the standard specifications for CPU, chipset and most of the peripherals. Whether your system can run under these specific bus frequencies properly will depend on your hardware configurations, including CPU, Chipsets, SDRAM, Cards....etc.

GA-8IHX motherboard layout

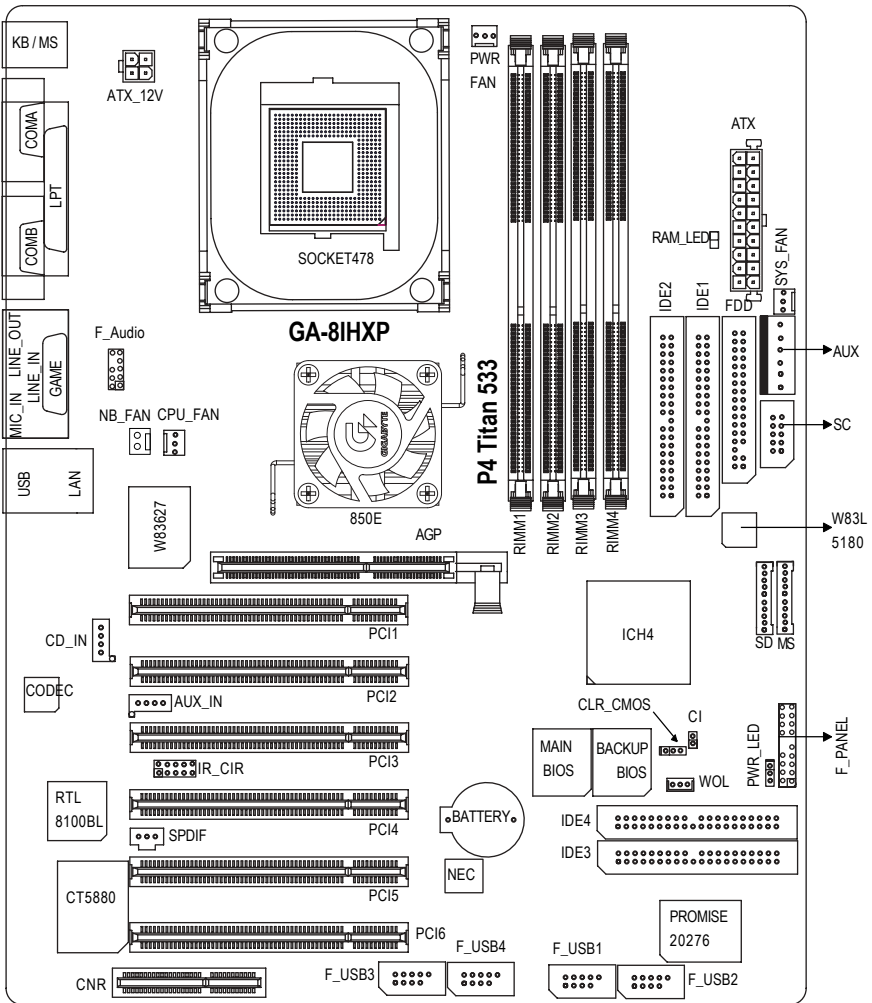

Chapter 2 Hardware Installation Process

To set up your computer, you must complete the following setups:

- Step 1- Install the Central Processing Unit (CPU)
- Step 2- Install memory modules
- Step 3- Install expansion cards
- Step 4- Connect ribbon cables, cabinet wires, and power supply
- Step 5- Setup BIOS software
- Step 6- Install supporting software tools

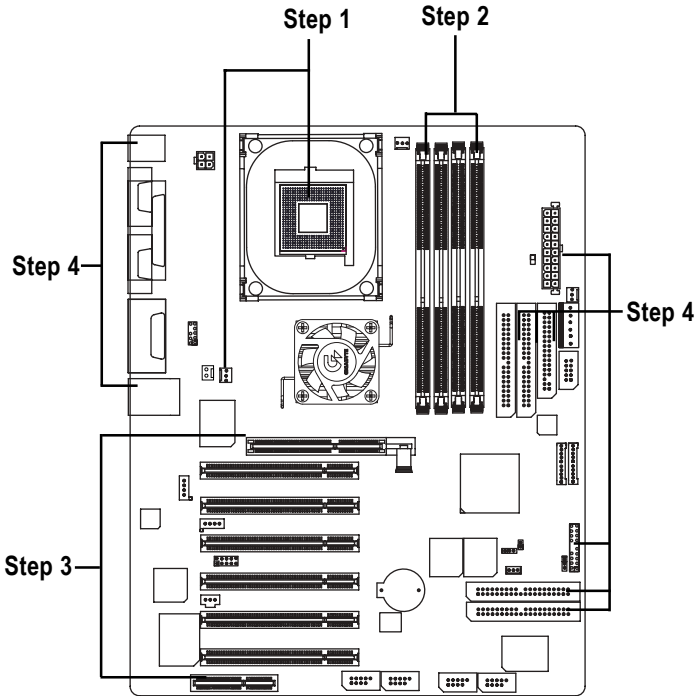

Step 1: Install the Central Processing Unit (CPU)

CPU Installation



CPU Top View

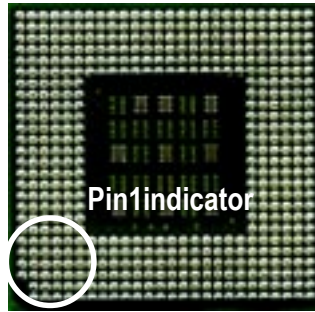

CPU Bottom View

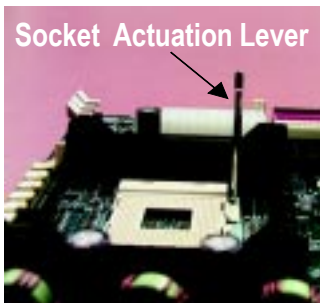

1. Pull up the CPU socket level and up to 90-degree angle.
2. Locate Pin 1 in the socket and look for a (golden) cut edge on the CPU upper corner. Then insert the CPU into the socket.
3. Press down the CPU socket lever and finish CPU installation.

⚠ Please make sure the CPU type is supported by the motherboard.

CPU Heat Sink Installation



1. Fasten the heatsink supporting-base onto the CPU socket on the main-board.

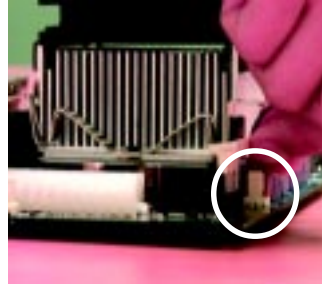

2. Make sure the CPU fan is plugged to the CPU fan connector, than install complete.

●* Please use Intel approved cooling fan.

●* We recommend you to apply the thermal tape to provide better heat conduction between your CPU and heatsink.

(The CPU cooling fan might stick to the CPU due to the hardening of the thermal paste. During this condition if you try to remove the cooling fan, you might pull the processor out of the CPU socket along with the cooling fan, and might damage the processor. To avoid this from happening, we suggest you to either use thermal tape instead of thermal paste, or remove the cooling fan with extreme caution.)

●* Make sure the CPU fan power cable is plugged in to the CPU fan connector, this completes the installation.

●* Please refer to CPU heat sink user's manual for more detail installation procedure.

Step 2: Install memory modules

The motherboard has 4 Rambus In-line Memory Module (RIMM) sockets. The BIOS will automatically detect memory type and size. To install the memory module, just push it vertically into the RIMM Slot. The RIMM module can only fit in one direction due to the two notches. Please note; Both RIMM modules inserted on RIMM1 and RIMM2 slots are recommended to have the same size, frequency. If not, the larger sized module will be automatically re-sized by BIOS to match the smaller sized module. The same rule applies to both RIMM3 and RIMM4 slots.

You can insert two RIMMs or four RIMMs into RIMM slots, but C-RIMM (Continuity RIMM) modules must be inserted into the empty slots.



RIMM



CRIMM

Check RIMM module if it is supported by the M/B.

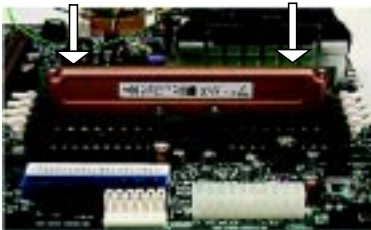

Insert the RIMM module into the slot.



Push the ejector tab towards the RIMM.

●[※] When STR/RIMM LED is ON, you do not install / remove RDRAM from socket.

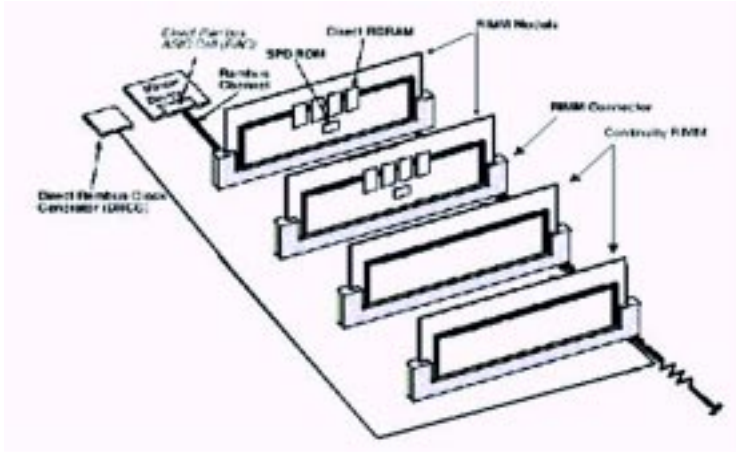

Introduce RIMM (Rambus In-line Memory Module)

Direct Rambus Memory Controller

⇒ Directly support a Dual Direct Rambus * Channel

- ◆ Supports 300&400 MHz Direct Rambus * Channel @ 100MHz host bus frequency.
- ◆ Maximum memory array size up to 256MB using 64Mb/72Mb, 512MB using 128Mb/144Mb, 1GB using 256Mb/288Mb DRAM technology

⇒ Supports up to 32 Direct Rambus devices per channel

⇒ Supports a maximum DRAM address decode space of 4GB

⇒ Configurable optional ECC operation

- ◆ ECC with single bit Error Correction and multiple bit Error Detection
- ◆ Single bit errors corrected and written back to memory (auto-scrubbing)
- ◆ Parity mode not supported

APIC memory space in hardware. It is the BIOS or system designer's responsibility to limit DRAM population so that adequate PCI, AGP, High BIOS, and APIC memory space can be allocated.

Step 3: Install expansion cards

1. Read the related expansion card's instruction document before install the expansion card into the computer.
2. Remove your computer's chassis cover, screws and slot bracket from the computer.
3. Press the expansion card firmly into expansion slot in motherboard.
4. Be sure the metal contacts on the card are indeed seated in the slot.
5. Replace the screw to secure the slot bracket of the expansion card.
6. Replace your computer's chassis cover.
7. Power on the computer, if necessary, setup BIOS utility of expansion card from BIOS.
8. Install related driver from the operating system.

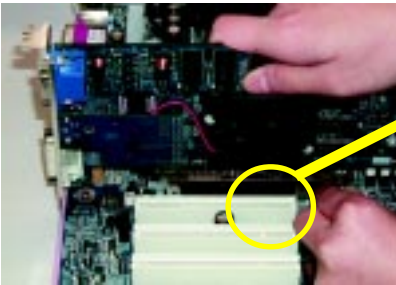

AGP Card

Please carefully pull out the small white-drawable bar at the end of the AGP slot when you try to install/ Uninstall the AGP card. Please align the AGP card to the onboard AGP slot and press firmly down on the slot. Make sure your AGP card is locked by the small white-drawable bar.

Issues To Beware Of When Installing CNR

Please use standard CNR card like the one in order to avoid mechanical problem.



Standard CNR Card

Step 4: Connect ribbon cables, cabinet wires, and power supply

Step 4-1: I/O Back Panel Introduction

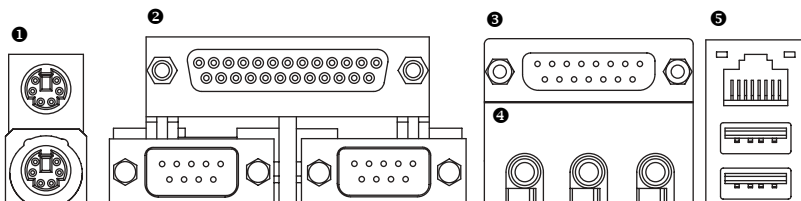

❶ PS/2 Keyboard and PS/2 Mouse Connector

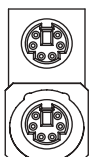

PS/2 Mouse Connector
(6 pin Female)

PS/2 Keyboard Connector
(6 pin Female)

➤ This connector supports standard PS/2 keyboard and PS/2 mouse.

❷ Parallel Port and Serial Ports (COMA/COMB)

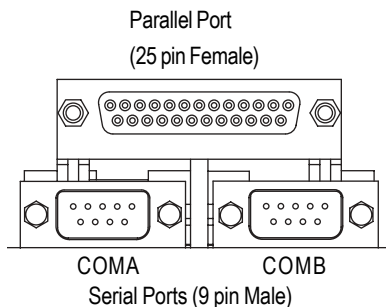

Parallel Port
(25 pin Female)

COMA COMB
Serial Ports (9 pin Male)

➤ This connector supports 2 standard COM ports and 1 Parallel port. Device like printer can be connected to Parallel port ; mouse and modem etc can be connected to Serial ports.

3 Game /MIDI Ports

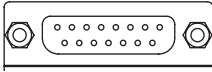

Joystick/ MIDI (15 pin Female)

➤ This connector supports joystick, MIDI keyboard and other relate audio devices.

4 Audio Connectors

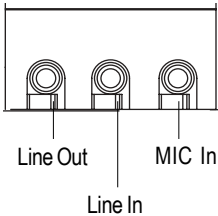

➤ After install onboard audio driver, you may connect speaker to Line Out jack, micro phone to MIC In jack. Device like CD-ROM , walkman etc can be connected to Line-In jack.

5 USB/LAN Connector

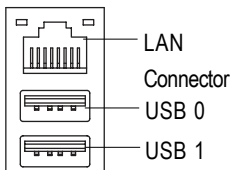

➤ Before you connect your device(s) into USB connector(s), please make sure your device(s) such as USB keyboard, mouse, scanner, zip,speaker..etc. Have a standard USB interface. Also make sure your OS (Win 95 with USB supplement, Win98, Windows 2000, Windows ME, Win NT with SP 6) supports USB controller. If your OS does not support USB controller, please contact OS vendor for possible patch or driver upgrade. For more information please contact your OS or device(s) vendors.

Step 4-2: Connectors Introduction

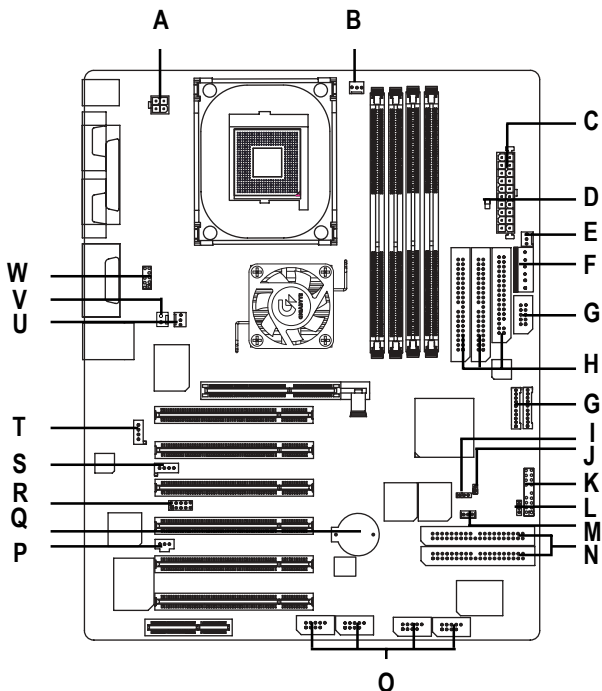

A	ATX_12V	L	PWR_LED
B	PWR_FAN	M	WOL
C	ATX	N	IDE3/IDE4
D	RAM_LED	O	F_USB1~4
E	SYS_FAN	P	SPDIF
F	AUX	Q	BATTERY
G	MS/SD/SC	R	IR_CIR
H	FDD/IDE1/IDE2	S	AUX_IN
I	CLR_CMOS	T	CD_IN
J	CI	U	CPU_FAN
K	F_Panel	V	NB_FAN
		W	F_Audio

B / E / U : PWR_FAN / SYS_FAN / CPU_Fan Connector

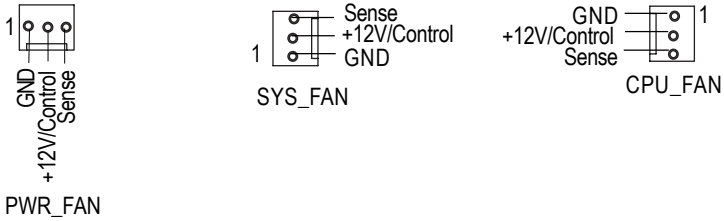

- Please note, a proper installation of the CPU cooler is essential to prevent the CPU from running under abnormal condition or damaged by overheating. The CPU fan connector supports Max. current up to 600 mA.

D: RAM_LED



- Do not remove memory modules while RAM LED is on. It might cause short or other unexpected damages due to the 2.5V stand by voltage. Remove memory modules only when STR function is disabled by jumper and AC Power cord is disconnected.

C: ATX (ATX Power)

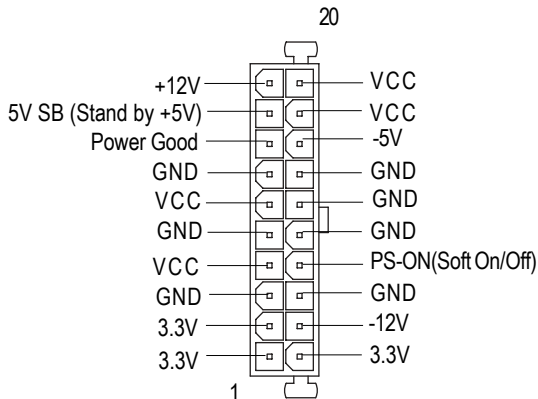

- AC power cord should only be connected to your power supply unit after ATX power cable and other related devices are firmly connected to the mainboard.

F: AUX

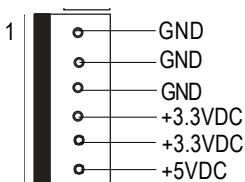

- The 6-pin Aux. Power connector provides additional current to meet the board's +3.3VDC and +5VDC requirements. Please refer to the detail on P.23

A: ATX_12V Power Connector

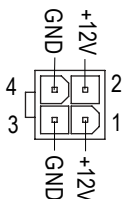

- This connector (ATX_12V) supplies the CPU operation voltage (Vcore). If this "ATX_12V connector" is not connected, system cannot boot.

H : Floppy / IDE1 / IDE2 Connector (Primary/Secondary)

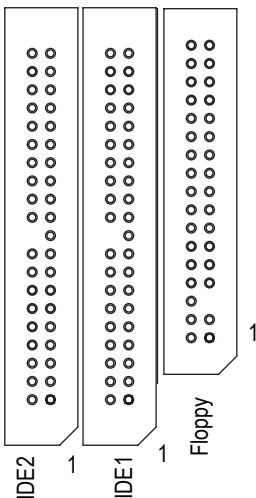

N: IDE3 / IDE4 Connector (RAID / ATA133)

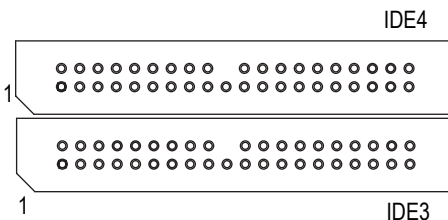

- Important Notice:
If you wish to use IDE3 and IDE4, please use it in unity with BIOS(P.42). Then, install the correct driver to have proper operation. For details, please refer to the RAID manual inside the CDRROM.

- Important Notice:
Please connect first harddisk to IDE1 and connect CDRROM to IDE2.

R: IR_CIR

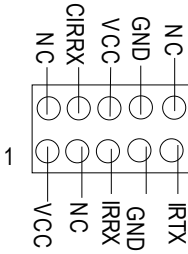

- Make sure the pin 1 on the IR device is aligning with pin one the connector. To enable the IR/CIR function on the board, you are required to purchase an option IR/ CIR module. For detail information please contact your authorized Giga-Byte distributor.
- To use IR function only, please connect IR module to Pin1 to Pin5.

M: WOL (Wake On Lan)

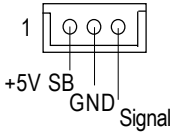

L: PWR_LED

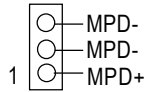

P: SPDIF

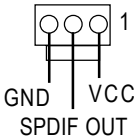

- The SPDIF output is capable of providing digital audio to external speakers or compressed AC3 data to an external Dolby Digital Decoder. Use this feature only when your stereo system has digital output function.

J: CI (CASE_OPEN)



T: CD_IN (CD Audio Line In)

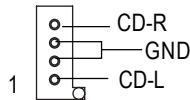

- This 2 pin connector allows your system to enable or disable the system alarm if the system case begin remove.

S: AUX_IN

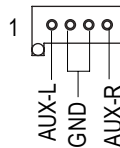

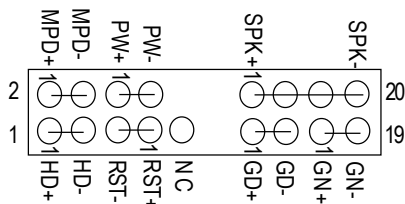
K: F_PANEL (2x10 pins jumper)

GN (Green Switch)	Open: Normal Operation Close: Entering Green Mode
GD (Green LED)	Pin 1: LED anode(+) Pin 2: LED cathode(-)
HD (IDE Hard Disk Active LED)	Pin 1: LED anode(+) Pin 2: LED cathode(-)
SPK (Speaker Connector)	Pin 1: VCC(+) Pin 2- Pin 3: NC Pin 4: Data(-)
RE (Reset Switch)	Open: Normal Operation Close: Reset Hardware System
P+P-P-(Power LED)	Pin 1: LED anode(+) Pin 2: LED cathode(-) Pin 3: LED cathode(-)
PW (Soft Power Connector)	Open: Normal Operation Close: Power On/Off
MPD(Message LED/Power/ Sleep LED)	Pin 1: LED anode(+) Pin 2: LED cathode(-)

- Please connect the power LED, PC speaker, reset switch and power switch etc of your chassis front panel to the front panel jumper according to the pin assignment above.

O: F_USB1~ F_USB4 (Front USB Connector)

(F_USB1 ~ F_USB4 connector in yellow are for USB 2.0)

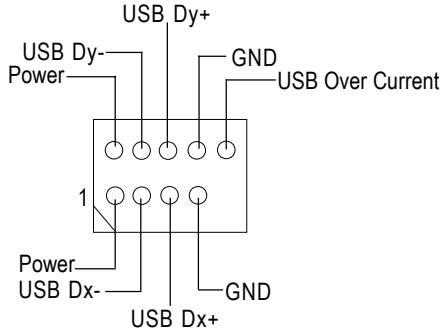

- Be careful with the polarity of the front panel USB connector. Check the pin assignment while you connect the front panel USB cable. Please contact your nearest dealer for optional front panel USB cable.

W: F_AUDIO (Front Audio)

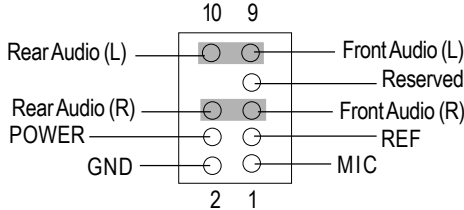

- If you want to use "Front Audio" connector, you must move 5-6, 9-10 Jumper. In order to utilize the front audio header, your chassis must have front audio connector. Also please make sure the pin assignment on the cable is the same as the pin assignment on the MB header. To find out if the chassis you are buying support front audio connector, please contact your dealer.

Q : Battery

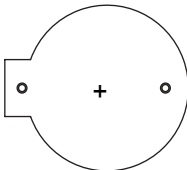

CAUTION

- ❖ Danger of explosion if battery is incorrectly replaced.
- ❖ Replace only with the same or equivalent type recommended by the manufacturer.
- ❖ Dispose of used batteries according to the manufacturer's instructions.

I : CLR_CMOS (Clear CMOS Function)#

1  1-2 close: Clear CMOS

➤ Please note: You may clear the CMOS data to its default values by this jumper.

1  2-3 close: Normal

Default doesn't include the "Shunter" to prevent from improper use this jumper. To clear CMOS, temporarily short 1-2 pin.

G: SC(Smart Card Interface), SD (Secure Digital Memory Card Interface) , MS (Memory Stick Interface)

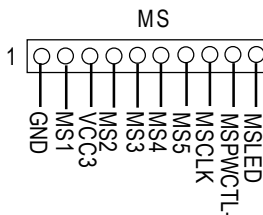
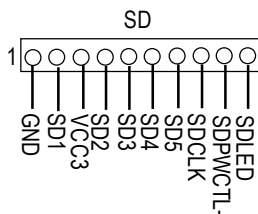
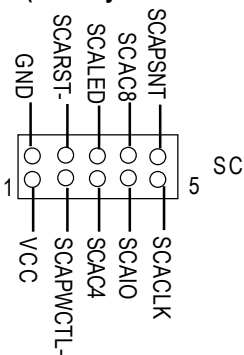

The device could be expanded for reading Flash Memory, such as SD(Security Digital),MS (Memory Stick) and Smart Card Reader Connector. The Smart IC Card could increase security in authenticating online transactions; the card reader device (inquire local distributor) made by Third Party could be purchased by users.

V) NB_FAN

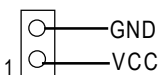

➤ If you installed wrong direction, the Chip Fan will not work. Sometimes will damage the Chip Fan. (Usually black cable is GND)

Step 4-3: ATX 12V Power Supply Introduction

- Additional 4 pin connector for 12V voltage
- Backward compatibility maintained with load sharing capability
- Support 12V or 5V CPU VRs

Check power supply if it is supported by ATX12V Power Supply.

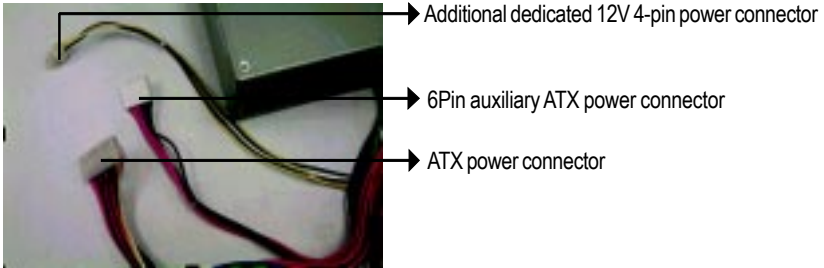

6 Pin Aux. Power Connector

Step1: In a 45° angle position, align the tooth of aux. Power cable onto the gird of aux. Power socket.



Figure 1



Figure 2

Step3: Properly installed shown below.



Figure 3

Chapter 3 BIOS Setup

BIOS Setup is an overview of the BIOS Setup Program. The program that allows users to modify the basic system configuration. This type of information is stored in battery-backed CMOS RAM so that it retains the Setup information when the power is turned off.

ENTERING SETUP

Press <F8> to enter Boot Menu during POST (Power On Self Test); press <F12> to enter Network boot function, press to enter CMOS Setup.

a. Boot Screen

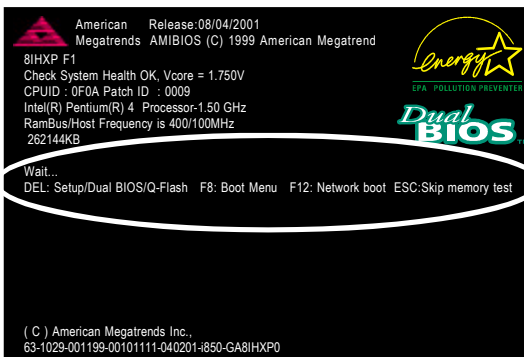

b. Press <F8> to enter Boot Menu

Select First Boot Device	
Floppy	: 1.44MB 3 ^{1/2}
USB RMD-FDD	: Apacer HandyDrive
IDE-0	: ST320420A
CD/DVD	: IDE/ATAPI DVD-ROM 10X
BBS-0(Network)	: Realtek Boot Agent
[Up/Dn] Select	[RETURN] Boot [ESC] Cnancel

Boot order depends on the devices you use, for example: Floppy, HDD, CD-ROM...

c. Press<F12> to boot from Network.

d. After power on the computer, pressing immediately during POST (Power On Self Test) it will allow you to enter AMI BIOS CMOS SETUP.

CONTROLKEYS

<↑>	Move to previous item
<↓>	Move to next item
<←>	Move to the item in the left hand
<→>	Move to the item in the right hand
<Esc>	Main Menu - Quit and not save changes into CMOS Status Page Setup Menu and Option Page Setup Menu - Exit current page and return to Main Menu
<+/PgUp>	Increase the numeric value or make changes
<-/PgDn>	Decrease the numeric value or make changes
<F1>	General help, only for Status Page Setup Menu and Option Page Setup Menu
<F2>	Reserved
<F3>	Select Language
(Shift)F3	Select Language
<F4>	Reserved
<F5>	Restore the previous CMOS value from CMOS, only for Option Page Setup Menu
<F6>	Load the default CMOS value from BIOS default table, only for Option Page Setup Menu
<F7>	Load the Setup Defaults
<F8>	Dual BIOS/Q-Flash
<F9>	System Information
<F10>	Save all the CMOS changes, only for Main Menu

GETTINGHELP

Main Menu

The on-line description of the highlighted setup function is displayed at the bottom of the screen.

Status Page Setup Menu / Option Page Setup Menu

Press F1 to pop up a small help window that describes the appropriate keys to use and the possible selections for the highlighted item. To exit the Help Window press <Esc>.

Select Language

You can press <F3> or Shift-F3 to select multi language. There are 7 languages available, include English, Japanese, French, Spanish, Germany, Simplified Chinese, Traditional Chinese.

The Main Menu (For example: BIOS Ver. :F1)

Once you enter AMI BIOS CMOS Setup Utility, the Main Menu (Figure 1) will appear on the screen. The Main Menu allows you to select from eight setup functions and two exit choices. Use arrow keys to select among the items and press <Enter> to accept or enter the sub-menu.

AMI NEW SETUP UTILITY-VISION 3.31a	
▶Standard CMOS Features	Set Supervisor Password
▶Advanced BIOS Features	Set User Password
▶Advanced Chipset Features	Load Optimized Defaults
▶Integrated Peripherals	Load Fail Safe Defaults
▶Power Management Features	Save & Exit Setup
▶PnP/PCI Configurations	Exit Without Saving
▶PC Health Status	
ESC:Quit ↑↓→←:Select Item (Shift)F3:Select Language F8:Dual BIOS/Q-Flash F5:Old Values F6:Fail-Safe Values F7:Optimized Values F10: Save & Exit	
Set Time, Date, Hard Disk Type...	

Figure 1: Main Menu

- **Standard CMOS Features**

This setup page includes all the items in standard compatible BIOS.
- **Advanced BIOS Features**

This setup page includes all the items of AMI special enhanced features.
- **Advanced Chipset Features**

This setup page includes all the adjustable items of chipset special features.
- **Integrated Peripherals**

This setup page includes all onboard peripherals.
- **Power Management Features**

This setup page includes all the items of Green function features.
- **PnP/PCI Configurations**

This setup page includes all the configurations of PCI & PnP ISA resources.
- **PC Health Status**

This setup page is the System auto detect Temperature, voltage, fan, speed.
- **Set Supervisor password**

Change, set, or disable password. It allows you to limit access to the system and Setup, or just to Setup.
- **Set User password**

Change, set, or disable password. It allows you to limit access to the system.
- **Load Optimized Defaults**

Optimized Defaults indicates the value of the system parameters which the system would be in best performance configuration.
- **Load Fail-Safe Defaults**

Fail-Safe Defaults indicates the value of the system parameters which the system would be in safe configuration.
- **Save & Exit Setup**

Save CMOS value settings to CMOS and exit setup.
- **Exit Without Saving**

Abandon all CMOS value changes and exit setup.

Standard CMOS Features

AMI NEW SETUP UTILITY-VISION 3.31a

Standard CMOS Features		Setup Help	
System Time	22:31:24	Menu Level ►	
System Date	Mon, Feb 21 2002		
Current Language	English		
Boot Sector Virus Protection	Disabled		
Floppy Drive A	1.44M, 3.5 in.		
Floppy Drive B	Not Installed		
►IDE Primary Master	None		
►IDE Primary Slave	None		
►IDE Secondary Master	None		
►IDE Secondary Slave	None		
ESC :Previous Menu ↑↓ : Select Item PU/PD/+/-:Modify F8:Dual BIOS/Q-Flash F5: Old Values F6:Fail-Safe Values F7:Optimized Values F10:Save & Exit			

Figure 2: Standard CMOS Features

☞ SystemTime

The times format in <hour> <minute> <second>. The time is calculated base on the 24-hour military-time clock. For example, 1 p.m. is 13:00:00.

☞ SystemDate

The date format is <month>, <day>, <year>, <week>.

- ▶▶ Month The month, Jan. Through Dec.
- ▶▶ Day The day, from 1 to 31 (or the maximum allowed in the month)
- ▶▶ Year The year, from 1990 through 2099
- ▶▶ Week The week, from Sun to Sat, determined by the BIOS and is display only

☞ **Current Language**

There are 7 languages available, include English, Japanese, French, Spanish, Germany, Simplified Chinese, Traditional Chinese.

☞ **Boot Sector Virus Protection**

If it is set to enable, the category will flash on the screen when there is any attempt to write to the boot sector or partition table of the hard disk drive. The system will halt and the following error message will appear in the mean time. You can run anti-virus program to locate the problem.

- ▶▶ Enabled Activate automatically when the system boots up causing a warning message to appear when anything attempts to access the boot sector or hard disk partition table

- ▶▶ Disabled No warning message to appear when anything attempts to access the boot sector or hard disk partition table (Default Value)

☞ **Floppy Drive A / Drive B**

The category identifies the types of floppy disk drive A or drive B that has been installed in the computer.

- ▶▶ None No floppy drive installed
- ▶▶ 360K, 5.25 in. 5.25 inch PC-type standard drive; 360K byte capacity.
- ▶▶ 1.2M, 5.25 in. 5.25 inch AT-type high-density drive; 1.2M byte capacity
(3.5 inch when 3 Mode is Enabled).
- ▶▶ 720K, 3.5 in. 3.5 inch double-sided drive; 720K byte capacity
- ▶▶ 1.44M, 3.5 in. 3.5 inch double-sided drive; 1.44M byte capacity.
- ▶▶ 2.88M, 3.5 in. 3.5 inch double-sided drive; 2.88M byte capacity.

If a hard disk has not been installed select NONE and press <Enter>.

☞ Primary Master, Slave / Secondary Master, Slave

The category identifies the types of hard disk from drive C to F that has been installed in the computer. There are two types: auto type, and manual type. Manual type is user-definable; Auto type which will automatically detect HDD type.

Note that the specifications of your drive must match with the drive table. The hard disk will not work properly if you enter improper information for this category.

If you select User Type, related information will be asked to enter to the following items. Enter the information directly from the keyboard and press <Enter>. Such information should be provided in the documentation from your hard disk vendor or the system manufacturer.

- ▶▶ CYLS. Number of cylinders
- ▶▶ HEADS number of heads
- ▶▶ PRECOMP write precomp
- ▶▶ LANDZONE Landing zone
- ▶▶ SECTORS number of sectors

Advanced BIOS Features

AMI NEW SETUP UTILITY-VISION 3.31a

Advanced BIOS Features	Setup Help
Boot Device Priority 1st Floppy : 1.44MB 3 ^{1/2} 2nd Disabled 3rd Disabled	
BIOS Flash Protection Auto Show Full Screen Logo Enabled Floppy Drive Seek Disabled BootUp Num-Lock On Password Check Setup S.M.A.R.T. for Hard Disks Disabled Interrupt Mode APIC	
ESC :Previous Menu ↑↓: Select Item PU/PD/+/-:Modify F8:Dual BIOS/Q-Flash F5: Old Values F6:Fail-Safe Values F7:Optimized Values F10:Save & Exit	

Figure 3: Advanced BIOS Features

☞ 1st / 2nd / 3rd Boot device

- ☞ Floppy:1.44MB 3^{1/2} Select your boot device priority by Floppy.
- ☞ BBS-0(Network):Realtek Boot Agent Select your boot device priority by Network.
- ☞ Disabled Disabled this function.
- ☞ IDE-0:ST320420A Select your boot device priority by IDE Device.
- ☞ USB RMD-FDD:Apacer Handy Drive Select your boot device priority by USB Device.

Boot order depends on the devices you use, for example: Floppy, HDD, CD-ROM...

☞ BIOS Flash Protection

- ☞ Auto Will be automatically detected by BIOS. (Default value)
- ☞ Enabled Enable BIOS Flash Protection. This will prevent BIOS Flash write after POST.

☞ Show Full Screen Logo

- ☞ Disabled Disabled show full screen logo.
- ☞ Enabled Enable show full screen logo(Default value)

Floppy Drive Seek

During POST, BIOS will determine the floppy disk drive installed is 40 or 80 tracks. 360 K type is 40 tracks 720 K, 1.2 M and 1.44 M are all 80 tracks.

- ▶▶ Enabled BIOS searches for floppy disk drive to determine it is 40 or 80 tracks. Note that BIOS can not tell from 720 K, 1.2 M or 1.44 M drive type as they are all 80tracks.
- ▶▶ Disabled BIOS will not search for the type of floppy disk drive by track number. Note that there will not be any warning message if the drive installed is 360 K. (Default value)

Boot Up Num-Lock

- ▶▶ On Keypad is number keys. (Default value)
- ▶▶ Off Keypad is arrow keys.

Password Check

Please refer to the detail on P.51

- ▶▶ Always The user must enter correct password in order to access the system and/or BIOS Setup.
- ▶▶ Setup The user must enter correct password in order to access BIOS setup utility. (Default Value)

HDD S.M.A.R.T Capability

- ▶▶ Enabled Enable HDD S.M.A.R.T. Capability.
- ▶▶ Disabled Disable HDD S.M.A.R.T. Capability. (Default value)

Interrupt Mode

- ▶▶ APIC Through IOAPIC generate more IRQ for system use.(Default value)
- ▶▶ PIC Use AT stantard IRQ controller to generate IRQ.

When you already have IOAPIC enable system and want to upgrade the system please note, since running an IOAPIC enabled OS (like Windows NT, Windows 2000, Windows XP...) system with none IOAPIC HW support will cause the system to hang. Following are some situations users might run into:
1.An IOAPIC enabled OS and change the BIOS setting from IOAPIC to PIC, this will cause your system to hang.

Advanced Chipset Features

AMI NEW SETUP UTILITY-VISION 3.31a

Advanced Chipset Features		Setup Help
Front Side Bus Clock (MHz)	By Hardware	
CPU Frequency Ratio	8.0x(Safe)	
RDRAM Bus Frequency	Auto	
Vcore Voltage	Original	
Over RIMM Voltage	Disabled	
Over AGP Voltage	1.5V	
Memory ECC Mode	Disabled	
Graphics Aperture Size	64MB	
ICH Delayed Transaction	Enabled	
DMA Collection Buffer	Enabled	
ESC :Previous Menu ↑↓: Select Item PU/PD/+/-:Modify		F8:Dual BIOS/Q-Flash
F5: Old Values F6:Fail-Safe Values F7:Optimized Values		F10:Save & Exit

Figure 4: Advanced Chipset Features

☞ Front Side Bus Clock (MHz)

When set to "By Hardware", the FSB clock frequency will be set to 100MHz. You may also set FSB clock by BIOS. For power End-User use only.

- ☞ By Hardware Set Front Side Bus Clock (MHz) to By Hardware. (Default Value)
- ☞ 100.00 Set Front Side Bus Clock (MHz) to 100.00.
- ☞ 103.00 Set Front Side Bus Clock (MHz) to 103.00.
- ☞ 105.00 Set Front Side Bus Clock (MHz) to 105.00.
- ☞ 108.00 Set Front Side Bus Clock (MHz) to 108.00.
- ☞ 110.00 Set Front Side Bus Clock (MHz) to 110.00.
- ☞ 112.00 Set Front Side Bus Clock (MHz) to 112.00.
- ☞ 115.00 Set Front Side Bus Clock (MHz) to 115.00.
- ☞ 118.00 Set Front Side Bus Clock (MHz) to 118.00.
- ☞ 120.00 Set Front Side Bus Clock (MHz) to 120.00.
- ☞ 122.00 Set Front Side Bus Clock (MHz) to 122.00.
- ☞ 125.00 Set Front Side Bus Clock (MHz) to 125.00.
- ☞ 130.00 Set Front Side Bus Clock (MHz) to 130.00.
- ☞ 133.33 Set Front Side Bus Clock (MHz) to 133.33.

- ▶▶ 133.66 Set Front Side Bus Clock (MHz) to 133.66.
- ▶▶ 136.00 Set Front Side Bus Clock (MHz) to 136.00.
- ▶▶ 138.00 Set Front Side Bus Clock (MHz) to 138.00.
- ▶▶ 140.00 Set Front Side Bus Clock (MHz) to 140.00.
- ▶▶ 142.00 Set Front Side Bus Clock (MHz) to 142.00.
- ▶▶ 144.00 Set Front Side Bus Clock (MHz) to 144.00.
- ▶▶ 145.00 Set Front Side Bus Clock (MHz) to 145.00.
- ▶▶ 148.00 Set Front Side Bus Clock (MHz) to 148.00.
- ▶▶ 150.00 Set Front Side Bus Clock (MHz) to 150.00.
- ▶▶ 152.00 Set Front Side Bus Clock (MHz) to 152.00.
- ▶▶ 154.00 Set Front Side Bus Clock (MHz) to 154.00.
- ▶▶ 156.00 Set Front Side Bus Clock (MHz) to 156.00.

☞ CPU Frequency Ratio

This setup option will automatically assign by CPU detection.

For Willamette CPU:

8X~23X default: 14X

For C-Stepping P4:

8X,10X~24X default: 15X

For Northwood CPU:

12X~24X default: 16X

The option will display "Locked" and read only if the CPU ratio is not changeable.

☞ RDRAM Bus Frequency

for FSB(Front Side Bus) frequency=100MHz,

- ▶▶ Auto Set RDRAM Bus Frequency automatically.
- ▶▶ PC800 Set RDRAM Bus Frequency to PC800.(Default Value)
- ▶▶ PC600 Set RDRAM Bus Frequency to PC600.

for FSB(Front Side Bus) frequency=133MHz,

- ▶▶ Auto Set RDRAM Bus Frequency automatically.
- ▶▶ PC800 Set RDRAM Bus Frequency to PC800.(Default Value)
- ▶▶ PC1066 Set RDRAM Bus Frequency to PC1066.

Vcore Voltage

- ▶▶ Original Original Vcore Voltage. (Default Value)
- ▶▶ +0.025V Original Vcore Voltage +0.025V.
- ▶▶ +0.050V Original Vcore Voltage +0.050V.
- ▶▶ +0.075V Original Vcore Voltage +0.075V.
- ▶▶ +0.100V Original Vcore Voltage +0.100V.

Over RIMM Voltage

- ▶▶ Disabled Disable this function. (Default Value)
- ▶▶ Enabled Enable Over RIMM Voltage function.

Over AGP Voltage

- ▶▶ 1.5V Set Over AGP Voltage to 1.5V.(Default Value)
- ▶▶ 1.6V Set Over AGP Voltage to 1.6V.
- ▶▶ 1.7V Set Over AGP Voltage to 1.7V.
- ▶▶ 1.8V Set Over AGP Voltage to 1.8V.

Memory ECC Mode

- ▶▶ Enabled Enable Memory Data Check ECC Mode.
- ▶▶ Disabled Disable this function. (Default Value)

Graphics Aperture

- ▶▶ 4 MB Display Graphics Aperture Size is 4MB.
- ▶▶ 8 MB Display Graphics Aperture Size is 8MB.
- ▶▶ 16 MB Display Graphics Aperture Size is 16MB.
- ▶▶ 32 MB Display Graphics Aperture Size is 32MB.
- ▶▶ 64 MB Display Graphics Aperture Size is 64MB. (Default Value)
- ▶▶ 128 MB Display Graphics Aperture Size is 128MB.
- ▶▶ 256 MB Display Graphics Aperture Size is 256MB.

ICH Delayed Transaction

- ▶▶ Enabled Enable PCI 2.1 features including release and delayed transaction for the chipset.(Default Value)
- ▶▶ Disabled Disable this function.

DMA Collection Buffer

- ▶▶ Enabled Enable DMA collection buffer for LPC I/F and PC/PCI DMA.(Default Value)
- ▶▶ Disabled Disable this function.

Integrated Peripherals

AMI NEW SETUP UTILITY-VISION 3.31a

Integrated Peripherals		Setup Help
OnBoard IDE	Both	
IDE1 Conductor Cable	Auto	
IDE2 Conductor Cable	Auto	
OnBoard FDC	Auto	
OnBoard Serial Port A	Auto	
OnBoard Serial Port B	Auto	
Serial Port B Mode	Normal	
IR Duplex Mode	Half Duplex	
OnBoard CIR Port	Disabled	
CIR IRQ Select	10	
OnBoard Parallel Port	Auto	
Parallel Port Mode	ECP	
EPP Version	N/A	
Parallel Port IRQ	Auto	
Parallel Port DMA	Auto	
Mouse PowerOn Function	Disabled	
Keyboard PowerOn Function	Disabled	
Specific Key for PowerOn	N/A	
OnBoard SC Interface	Enabled	
Smart Card IRQ Select	10	
OnBoard MS/SD Interface	Memory Stick	
MS/SD Card IRQ Select	11	
USB Controller	6 USB Ports	
USB Legacy Support	Disabled	
AC97 Audio	Auto	
AC97 Modem	Auto	
Onboard USB2.0 Chip	Enabled	
Onboard Lan Chip	Enabled	

Onboard Sound Chip	Enabled
Onboard Promise Chip	ATA
ESC :Previous Menu ↑↓: Select Item PU/PD/+/-:Modify F8:Dual BIOS/Q-Flash	
F5: Old Values F6:Fail-Safe Values F7:Optimized Values F10:Save & Exit	

Figure 5: Integrated Peripherals

☞ OnBoard IDE

- ▶▶ Disabled Disable OnBoard IDE.
- ▶▶ Both Both Primary & Secondary IDE channel will be enabled. (Default Value)
- ▶▶ Primary Only Primary IDE channel is enabled.
- ▶▶ Secondary Only Secondary IDE channel is enabled.

☞ IDE1 Conductor Cable

- ▶▶ Auto Will be automatically detected by BIOS. (Default Value)
- ▶▶ ATA66/100 Set IDE1 Conductor Cable to ATA66/100 (Please make sure your IDE device and cable is compatible with ATA66/100).
- ▶▶ ATA33 Set IDE1 Conductor Cable to ATA33 (Please make sure your IDE device and cable is compatible with ATA33).

☞ IDE2 Conductor Cable

- ▶▶ Auto Will be automatically detected by BIOS. (Default Value)
- ▶▶ ATA66/100 Set IDE2 Conductor Cable to ATA66/100 (Please make sure your IDE device and cable is compatible with ATA66/100).
- ▶▶ ATA33 Set IDE2 Conductor Cable to ATA33 (Please make sure your IDE device and cable is compatible with ATA33).

☞ OnBoard FDC

- ▶▶ Disabled Disable this function.
- ▶▶ Enabled Enable on board floppy disk controller.
- ▶▶ Auto Set the floppy disk controller automatically. (Default Value)

☞ Onboard Serial Port A

- ▶▶ Auto BIOS will automatically setup the port A address. (Default Value)
- ▶▶ 3F8/COM1 Enable onboard Serial port A and address is 3F8.
- ▶▶ 2F8/COM2 Enable onboard Serial port A and address is 2F8.
- ▶▶ 3E8/COM3 Enable onboard Serial port A and address is 3E8.
- ▶▶ 2E8/COM4 Enable onboard Serial port A and address is 2E8.
- ▶▶ Disabled Disable onboard Serial port A.

☞ Onboard Serial Port B

- ▶▶ Auto BIOS will automatically setup the port B address. (Default Value)
- ▶▶ 3F8/COM1 Enable onboard Serial port B and address is 3F8.
- ▶▶ 2F8/COM2 Enable onboard Serial port B and address is 2F8.
- ▶▶ 3E8/COM3 Enable onboard Serial port B and address is 3E8.
- ▶▶ 2E8/COM4 Enable onboard Serial port B and address is 2E8.
- ▶▶ Disabled Disable onboard Serial port B.

☞ Serial Port B Mode

(This item allows you to determine which Infra Red(IR) function of Onboard I/O chip)

- ▶▶ ASKIR Set onboard I/O chip UART to ASKIR Mode.
- ▶▶ IrDa Set onboard I/O chip UART to IrDa Mode.
- ▶▶ Normal Set onboard I/O chip UART to Normal Mode. (Default Value)

☞ IR Duplex Mode

- ▶▶ Half Duplex IR Function Duplex Half. (Default Value)
- ▶▶ Full Duplex IR Function Duplex Full.

☞ OnBoard CIR Port

- ▶▶ Disabled Disable this function. (Default Value)
- ▶▶ Enabled Enable Onboard CIR port.

☞ CIR IRQ Select

- ▶▶ IRQ 3 / 4 / 9 / 10 (Default Value) / 11

☞ Onboard Parallel Port

- ▶▶ 378 Set On Board LPT port and address to 378.
- ▶▶ 278 Set On Board LPT port and address to 278.
- ▶▶ 3BC Set On Board LPT port and address to 3BC.
- ▶▶ Auto Set On Board LPT port Automatically. (Default Value)
- ▶▶ Disabled Disable onboard Serial port A.

Note:3BC will not available if Parallel Port Mode=EPP.

☞ **Parallel Port Mode**

- ☞ EPP Using Parallel port as Enhanced Parallel Port.
- ☞ ECP Using Parallel port as Extended Capabilities Port. (Default Value)
- ☞ Normal Normal Operation.

Note: EPP will not available if Parallel Port Address=3BC.

☞ **EPP Version**

- ☞ N/A Disable this function. (Default Value)
- ☞ 1.9 Compliant with EPP 1.9 version.
- ☞ 1.7 Compliant with EPP 1.7 version.

Display "N/A" (Read Only) if Parallel Port Mode is not set to "EPP". "1.9" is the default for EPP mode.

☞ **Parallel Port IRQ**

- ☞ 7 Set Parallel Port IRQ to 7.
- ☞ 5 Set Parallel Port IRQ to 5.
- ☞ Auto Set Parallel Port IRQ automatically. (Default Value)

☞ **Parallel Port DMA**

- ☞ 3 Set Parallel Port DMA to 3.
- ☞ 1 Set Parallel Port DMA to 1.
- ☞ 0 Set Parallel Port DMA to 0.
- ☞ Auto Set Parallel Port DMA automatically. (Default Value)

Display "N/A" (Read Only) if Parallel Port Mode is not set to "ECP".

☞ **Mouse PowerOn Function**

- ☞ Disabled Disable this function. (Default Value)
- ☞ Right -button Double Click right-button to power on the system.
- ☞ Left-button Double Click Left-button to power on the system.

☞ **Keyboard PowerOn Function**

- ☞ Disabled Disable this function. (Default Value)
- ☞ Specific key Set password key to power on by keyboard.
- ☞ Power Key Set "Power key" to power on the system.

☞ Specific Key for PowerOn

- ▶▶ N/A Disable this function. (Default Value)
- ▶▶ Password ↵ Input password (from 1 to 5 characters) and press Enter to set the Key board Power On Password.

☞ OnBoard SC Interface

- ▶▶ Disabled Disable onboard SC Interface.
- ▶▶ Enabled Enabled onboard SC Interface.(Default Value)

☞ Smart Card IRQ Select

- ▶▶ IRQ 3 / 4 / 5 / 10 /11 (Default Value: 10)

☞ OnBoard MS/SD Interface

- ▶▶ Memory Stick Set MS/SD Interface to Memory Stick.(Default value)
- ▶▶ Secure Digital Set MS/SD Interface to Secure Digital.
- ▶▶ Disabled Disabled MS/SD Interface.

☞ MS/SD Card IRQ Select

- ▶▶ IRQ 3 / 4 / 5 / 10 /11 (Default Value: 11)

☞ USB Controller

- ▶▶ Disabled Disable this function.
- ▶▶ 2 USB Ports Set USB Controller to 2USB Ports.
- ▶▶ 4 USB Ports Set USB Controller to 4USB Ports.
- ▶▶ 6 USB Ports Set USB Controller to 6USB Ports.(Default Value)

☞ USB Legacy Support

- ▶▶ Enabled Enable USB Legacy Support.
- ▶▶ Disabled Disable this function.(Default Value)

☞ AC97 Audio

- ▶▶ Auto Enable onboard AC'97 audio function. (Default Value)
- ▶▶ Disabled Disable this function.

☞ **AC97 Modem**

- ▶▶ Auto BIOS will search MC97 Codec (CNR Modem Card). If found, MC97 function will be enabled. If no MC97 Codec found, MC97 function will be disabled. (Default Value)
- ▶▶ Disabled Disable this function.

☞ **Onboard USB2.0 Chip**

- ▶▶ Disabled Disable this function.
- ▶▶ Enabled Enable Onboard USB2.0 Chip function. (Default Value)

☞ **Onboard Lan Chip**

- ▶▶ Disabled Disable this function.
- ▶▶ Enabled Enable Onboard Lan Chip function. (Default Value)

☞ **Onboard Sound Chip**

- ▶▶ Disabled Disable this function.
- ▶▶ Enabled Enable Onboard Sound Chip function. (Default Value)

☞ **Onboard Promise Chip**

- ▶▶ Disabled Disable this function.
- ▶▶ ATA Enable Onboard ATA function. (Default Value)
- ▶▶ RAID Enable Onboard RAID function.

Power Management Feature

AMI NEW SETUP UTILITY-VISION 3.31a

Power Management Feature	Setup Help	
ACPI Sleep Type	S1/POS	
USB Dev Wakeup From S3	Disabled	
PS/2 Dev Wakeup From S3	Disabled	
Power LED in S1 State	Blinking	
Suspend Time Out (Minute)	Disabled	
Throttle Slow Clock Ratio	50.0%	
Soft-Off by Power Button	Instant Off	
System After AC Back	Off	
ModemRingOn/WakeOnLan	Enabled	
PME Event Wake Up	Enabled	
Resume by RTC Alarm	Disabled	
RTC Alarm Date	Event Day	
RTC Alarm Hour	00	
RTC Alarm Minute	00	
RTC Alarm Second	00	
KB & PS/2 Mouse Access	Monitor	
FDC/LPT/COM Ports Access	Monitor	
Pri. Master IDE Access	Monitor	
Pri. Slave IDE Access	Ignore	
Sec. Master IDE Access	Monitor	
Sec. Slave IDE Access	Ignore	
PIRQ[A] IRQ Active	Ignore	
PIRQ[B] IRQ Active	Ignore	
PIRQ[C] IRQ Active	Ignore	
PIRQ[D] IRQ Active	Ignore	
ESC :Previous Menu ↑↓ : Select Item PU/PD/+/-/:Modify F8:Dual BIOS/Q-Flash F5: Old Values F6:Fail-Safe Values F7:Optimized Values F10:Save & Exit		

Figure 6: Power Management Feature

☞ **ACPI Sleep Type**

- ▶▶ S1/POS Set ACPI Sleep Type to S1/POS (Power On Suspend). (Default value)
- ▶▶ S3/STR Set ACPI Sleep Type to S3/STR (Suspend To RAM).

☞ **USB Dev Wakeup From S3**

- ▶▶ Enabled Enable USB Device Wakeup From S3.
- ▶▶ Disabled Disable USB Device Wakeup From S3. (Default value)

☞ **PS/2 Dev Wakeup From S3**

- ▶▶ Enabled Enable PS/2 Device Wakeup From S3.
- ▶▶ Disabled Disable PS/2 Device Wakeup From S3. (Default value)

☞ **Power LED in S1 state**

- ▶▶ Blinking In standby mode(S1), power LED will blink. (Default Value)
- ▶▶ Dual/Off In standby mode(S1):
 - a. If use single color LED, power LED will turn off.
 - b. If use dual color LED, power LED will turn to another color.

☞ **Suspend Time Out**

- ▶▶ Disabled Disable the timer to enter suspend mode. (Default Value)
- ▶▶ 1Minute ~ 60 Minute Set the timer to enter suspend mode.

☞ **Throttle Slow Clock Ratio**

- ▶▶ 12.5%/25.0%/37.5%/50.0% (Default Value)/62.5%/75.0%/87.5%

☞ **Soft-off by Power Button**

- ▶▶ Instant off The user press the power button once, he can turn off the system. (Default Value)
- ▶▶ Suspend The user press the power button once, then the system will enter suspend mode.

☞ **System after AC Back**

- ▶▶ Off When AC-power back to the system, the system will be in "Off" state. (Default Value)
- ▶▶ On When AC-power back to the system, the system will be in "On" state.
- ▶▶ Last State When AC-power back to the system, the system will return to the Last state before AC-power off.

☞ **ModemRingOn/WakeOnLan**

- ▶▶ Disabled Disable Modem Ring On / Wake On LAN function.
- ▶▶ Enabled The modem ring / LAN wake up will bring the system out of soft-off or suspend state if this option is set "Enabled". (Default Value)

☞ **PME Event Wake up**

- ▶▶ Disabled Disable PME event wake up function.
- ▶▶ Enabled The PME event wake up will bring the system out of soft-off or suspend state if this option is set "Enabled". (Default Value)

☞ **Resume by RTC Alarm**

You can set "Resume by RTC Alarm " item to enabled and key in Data/time to power on system.

- ▶▶ Disabled Disable this function. (Default Value)
- ▶▶ Enabled Enable alarm function to POWER ON system.

If Resume by RTC Alarm is Enabled.

- ▶▶ RTC Alarm Date: Every Day, 1~31
- ▶▶ RTC Alarm Hour: 0~23
- ▶▶ RTC Alarm Minute: 0~59
- ▶▶ RTC Alarm Second: 0~59

☞ **KB & PS/2 Mouse Access**

- ▶▶ Monitor Monitor Keyboard & PS/2 Mouse Access. (Default Value)
- ▶▶ Ignore Ignore Keyboard & PS/2 Mouse Access.

☞ **FDC/LPT/COM Ports Access**

- ▶▶ Monitor Monitor FDC/LPT/COM Ports Access. (Default Value)
- ▶▶ Ignore Ignore FDC/LPT/COM Ports Access.

☞ **Pri. Master IDE Access**

- ▶▶ Monitor Monitor Primary Master IDE Access. (Default Value)
- ▶▶ Ignore Ignore Primary Master IDE Access.

☞ **Pri. slave IDE Access**

- ▶▶ Monitor Monitor Primary slaveIDE Access.
- ▶▶ Ignore Ignore Primary slave IDE Access. (Default Value)

☞ **Sec. Master IDE Access**

- ▶▶ Monitor Monitor Secondary Master IDE Access. (Default Value)
- ▶▶ Ignore Ignore Secondary Master IDE Access.

☞ **Sec. slave IDE Access**

- ▶▶ Monitor Monitor Secondary slave IDE Access.
- ▶▶ Ignore Ignore Secondary slave IDE Access.(Default Value)

☞ **PIRQ[A] IRQ Active**

- ▶▶ Monitor Monitor PIRQ[A] IRQ Active.
- ▶▶ Ignore Ignore PIRQ[A] IRQ Active. (Default Value)

☞ **PIRQ[B] IRQ Active**

- ▶▶ Monitor Monitor PIRQ[B] IRQ Active.
- ▶▶ Ignore Ignore PIRQ[B] IRQ Active. (Default Value)

☞ **PIRQ[C] IRQ Active**

- ▶▶ Monitor Monitor PIRQ[C] IRQ Active.
- ▶▶ Ignore Ignore PIRQ[C] IRQ Active. (Default Value)

☞ **PIRQ[D] IRQ Active**

- ▶▶ Monitor Monitor PIRQ[D] IRQ Active.
- ▶▶ Ignore Ignore PIRQ[D] IRQ Active. (Default Value)

PNP/PCI Configurations

AMI NEW SETUP UTILITY-VISION 3.31a

PNP/PCI Configurations		Setup Help
VGA Boot From	AGP	
PCI Slot 1/5 IRQ Priority	Auto	
PCI Slot 2/6 IRQ Priority	Auto	
PCI Slot 3 IRQ Priority	Auto	
PCI Slot 4 IRQ Priority	Auto	
IRQ3	PCI/PnP	
IRQ4	PCI/PnP	
IRQ5	PCI/PnP	
IRQ7	PCI/PnP	
IRQ9	PCI/PnP	
IRQ10	PCI/PnP	
IRQ11	PCI/PnP	
IRQ14	PCI/PnP	
IRQ15	PCI/PnP	
ESC :Previous Menu ↑↓: Select Item PU/PD/+/-:Modify F8: Dual BIOS/Q-Flash F5: Old Values F6: Fail-Safe Values F7: Optimized Values F10: Save & Exit		

Figure 7: PNP/PCI Configurations

☞ **VGA Boot From**

- ▶▶ AGP Set VGA Boot from AGP VGA Card. (Default Value)
- ▶▶ PCI Set VGA Boot from PCI VGA Card.

☞ **PCI Slot1/5, 2/6, 3, 4 IRQ Priority**

- ▶▶ Auto The system will reserved a free IRQ for PCI slot 1/5, 2/6, 3, 4 device.
(Default Value)
- ▶▶ 3 The system will reserved IRQ3 for PCI slot 1/5, 2/6, 3, 4 device if no legacy ISA device using IRQ3.
- ▶▶ 4 The system will reserved IRQ for PCI slot 1/5, 2/6, 3, 4 device if no legacy ISA device using IRQ4.
- ▶▶ 5 The system will reserved IRQ5 for PCI slot 1/5, 2/6, 3, 4 device if no legacy ISA device using IRQ5.
- ▶▶ 7 The system will reserved IRQ7 for PCI slot 1/5, 2/6, 3, 4 device if no legacy ISA device using IRQ7.
- ▶▶ 9 The system will reserved IRQ9 for PCI slot 1/5, 2/6, 3, 4 device if no legacy ISA device using IRQ9.
- ▶▶ 10 The system will reserved IRQ10 for PCI slot 1/5, 2/6, 3, 4 device if no legacy ISA device using IRQ10.
- ▶▶ 11 The system will reserved IRQ11 for PCI slot 1/5, 2/6, 3, 4 device if no legacy ISA device using IRQ11.

☞ **IRQ (3,4,5,7,9,10,11,14,15)**

- ▶▶ ISA The resource reserved for Legacy ISA device.
- ▶▶ PCI / PnP The resource can be assigned to PCI/ PnP device.

PC Health Status

AMI NEW SETUP UTILITY-VISION 3.31a

PC Health Status		Setup Help
CPU Temperature Alarm	Disabled	
CPU Fan Fail Alarm	No	
Power Fan Fail Alarm	No	
System Fan Fail Alarm	No	
Reset Case Open Status	No	
Case Status	Opened	
CPU Temperature	35°C/ 95°F	
System Temperature	33°C/ 91°F	
CPU Fan Speed	5273 RPM	
System Fan Speed	0 RPM	
Power Fan Speed	0 RPM	
CPU VID	1.700 V	
Vcore	+1.632V	
Vcc18	+1.840V	
Vio	+3.344V	
+5.000V	+5.080V	
+12.000V	+11.840V	
Battery	+3.020V	
+5V SB	+4.972V	
ESC :Previous Menu ↑↓: Select Item PU/PD/+/-:Modify F8:Dual BIOS/Q-Flash F5: Old Values F6:Fail-Safe Values F7:Optimized Values F10:Save & Exit		

Figure 8: PC Health Status

CPU Temperature Alarm

- ▶▶ 60°C / 140°F Monitor CPU Temp. at 60°C / 140°F.
- ▶▶ 70°C / 158°F Monitor CPU Temp. at 70°C / 158°F.
- ▶▶ 80°C / 176°F Monitor CPU Temp. at 80°C / 176°F.
- ▶▶ 90°C / 194°F Monitor CPU Temp. at 90°C / 194°F.
- ▶▶ Disabled Disable this function. (Default Value)

Fan Fail Alarm

CPU / Power / System

- ▶▶ No Fan Fail Alarm Function Disable. (Default Value)
- ▶▶ Yes Fan Fail Alarm Function Enable.

Reset Case Open Status

Case Opened

If the case is closed, "Case Opened" will show "No".

If the case have been opened, "Case Opened" will show "Yes".

If you want to reset "Case Opened" value, set "Reset Case Open Status" to "Enabled" and save CMOS, your computer will restart.

CPU Temperature

- ▶▶ Detect CPU Temp. automatically.

System Temperature

- ▶▶ Detect System Temp. automatically.

CPU Fan / System Fan / Power Fan Speed (RPM)

- ▶▶ Detect Fan speed status automatically.

CPU VID / Vcore / Vcc18 / Vio /+12 / +5V / Battery / +5VSB

- ▶▶ Detect system's voltage status automatically.

Set Supervisor / User Password

When you select this function, the following message will appear at the center of the screen to assist you in creating a password.

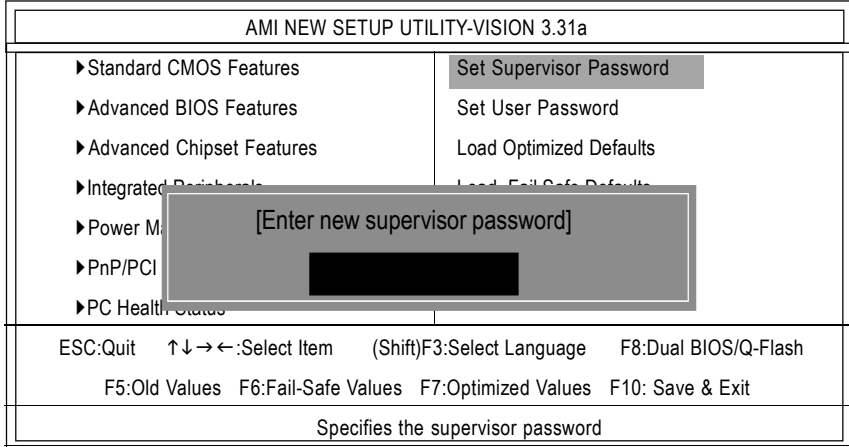

Figure 9: Password Setting

Type the password, up to 8 characters, and press <Enter>. You will be asked to confirm the password. Type the password again and press <Enter>. You may also press <Esc> to abort the selection and not enter a password.

To disable password, just press <Enter> when you are prompted to enter password. A message "PASSWORD DISABLED" will appear to confirm the password being disabled. Once the password is disabled, the system will boot and you can enter Setup freely.

The BIOS Setup program allows you to specify two separate passwords: a SUPERVISOR PASSWORD and a USER PASSWORD. When disabled, anyone may access all BIOS Setup program function. When enabled, the Supervisor password is required for entering the BIOS Setup program and having full configuration fields, the User password is required to access only basic items.

If you select "Always" at "Password Check" in BIOS Features Setup Menu, you will be prompted for the password every time the system is rebooted or any time you try to enter Setup Menu.

If you select "Setup" at "Password Check" in BIOS Features Setup Menu, you will be prompted only when you try to enter Setup.

Load Optimized Defaults

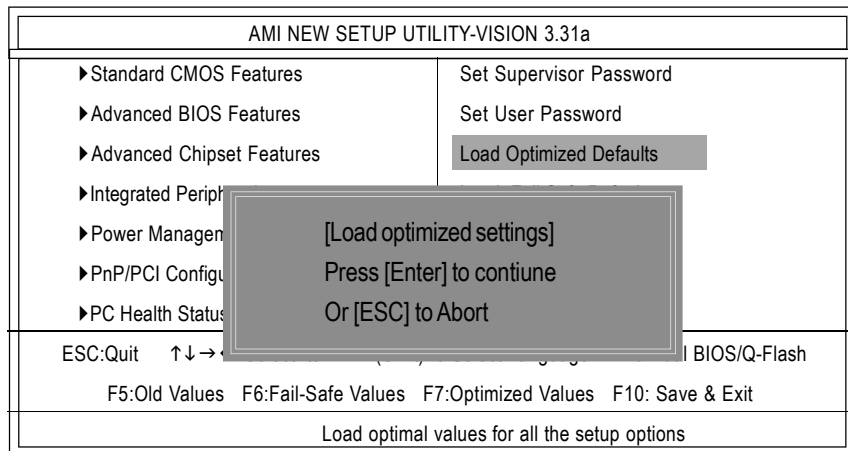

Figure 10: Load Optimized Defaults

Load Optimized Defaults

Optimized defaults contain the most appropriate system parameter values to configure the system to achieve maximum performance.

Load Fail-Safe Defaults

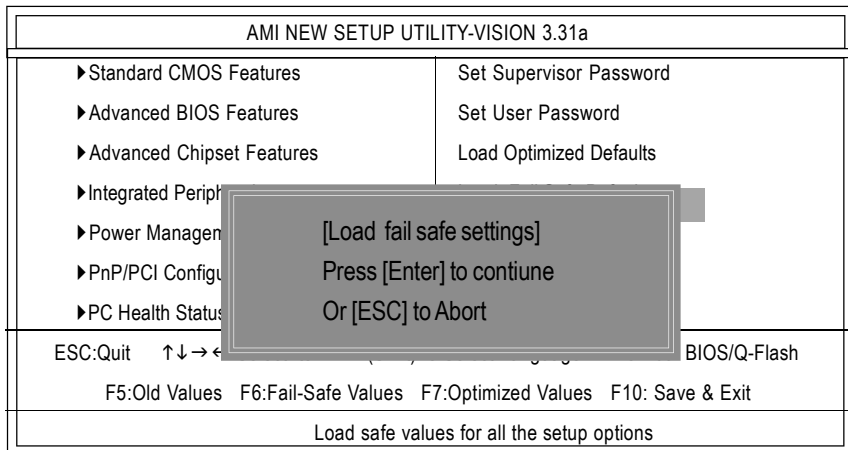

Figure 11: Load Fail-Safe Defaults

☞ Load Fail-Safe Defaults

Fail-Safe defaults contain the most appropriate system parameter values of to configure the system to achieve maximum stability.

Save & Exit Setup

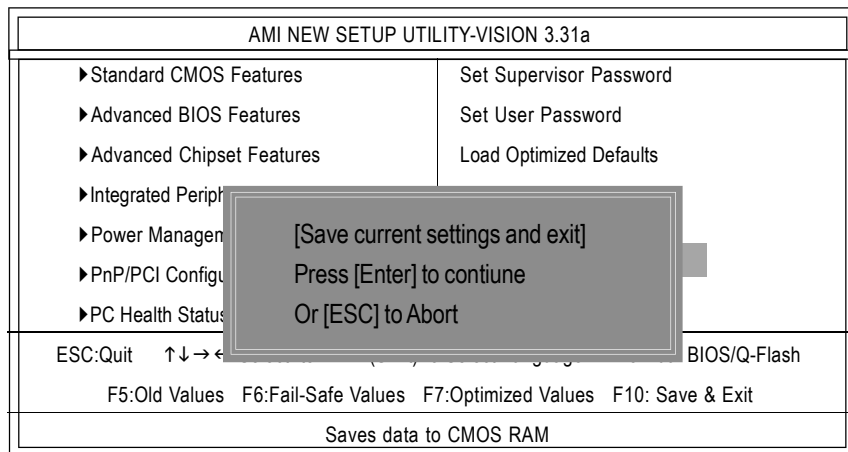

Figure 12: Save & Exit Setup

Type "Enter" will quit the Setup Utility and save the user setup value to RTC CMOS.

Type "ESC" will return to Setup Utility.

Exit Without Saving

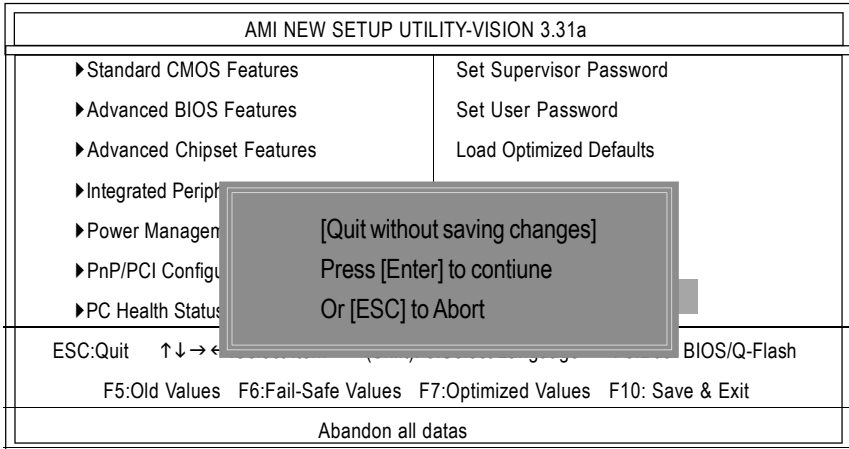

Figure 13: Exit Without Saving

Type "Enter" will quit the Setup Utility without saving to RTC CMOS.

Type "ESC" will return to Setup Utility.

Chapter 4 Technical Reference

Block Diagram

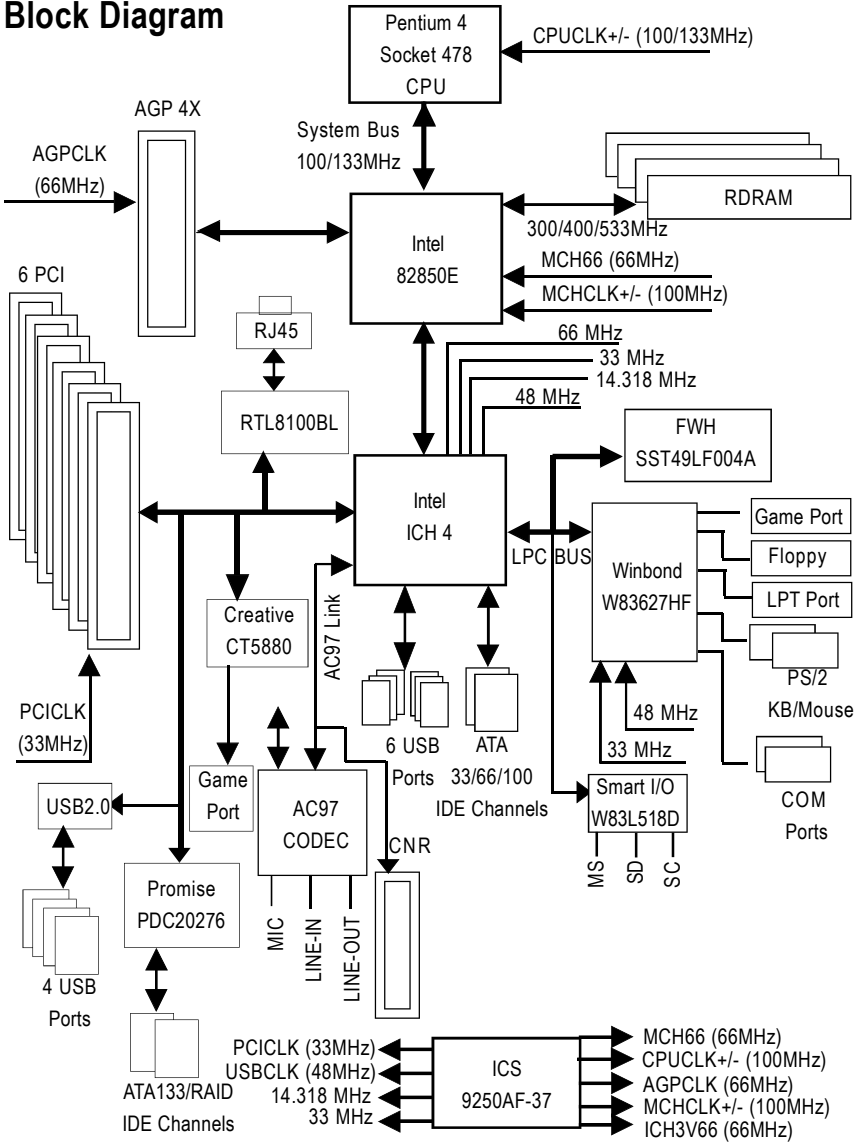

Dual BIOS / Q-Flash Introduction

A. What is Dual BIOS Technology?

Dual BIOS means that there are two system BIOS (ROM) on the motherboard, one is the Main BIOS and the other is Backup BIOS. Under the normal circumstances, the system works on the Main BIOS. If the Main BIOS is corrupted or damaged, the Backup BIOS can take over while the system is powered on. This means that your PC will still be able to run stably as if nothing has happened in your BIOS.

B. How to use Dual BIOS and Q-Flash Utility?

a. After power on the computer, pressing immediately during POST (Power On Self Test) it will allow you to enter AMI BIOS CMOS SETUP, then press <F8> to enter Flash utility.

AMI NEW SETUP UTILITY-VISION 3.31a	
▶Standard CMOS Features	Set Supervisor Password
▶Advanced BIOS Features	Set User Password
▶Advanced Chipset Features	Load Optimized Defaults
▶Integrated Peripherals	Load Fail Safe Defaults
▶Power Management Features	Save & Exit Setup
▶PnP/PCI Configurations	Exit Without Saving
▶PC Health Status	
ESC:Quit ↑↓→←:Select Item (Shift)F3:Select Language F8: Dual BIOS/Q-Flash	
F5:Old Values F6:Fail-Safe Values F7:Optimized Values F10: Save & Exit	
Set Time, Date, Hard Disk Type...	

b. Dual BIOS Utility

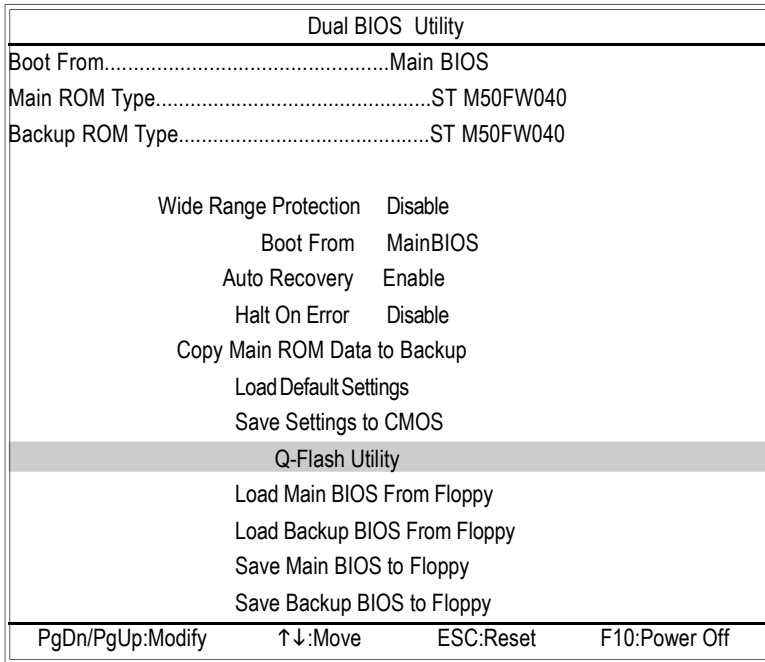

c. Dual BIOS Item explanation:

BIOS will auto detect:

Boot From : Main BIOS

Main ROM Type : ST M50FW040

Backup ROM Type : ST M50FW040

Wide Range Protection: Disable(Default), Enable

Status 1:

If any failure (ex. Update ESCD failure, checksum error or reset...) occurs in the Main BIOS , just before the Operating System is loaded and after the power is on, and that the Wide Range Protection is set to "Enable", the PC will boot from Backup BIOS automatically.

Status 2:

If the ROM BIOS on peripherals cards(ex. SCSI Cards, LAN Cards,...) emits signals to request restart of the system after the user make any alteration on it, the boot up BIOS will not be changed to the Backup BIOS.

Boot From : Main BIOS (Default), Backup BIOS

Status 1:

The user can set to boot from main BIOS or Backup BIOS.

Auto Recovery : Enabled(Default), Disabled

When one of the Main BIOS or Backup BIOS occurs checksum failure, the working BIOS will automatically recover the BIOS of checksum failure.

(In the Power Management Setup of the BIOS Setting, if ACPI Suspend Type is set to Suspend to RAM, the Auto Recovery will be set to Enable automatically.)

(If you want to enter the BIOS setting, please press "Del" key when the boot screen appears.)

Halt On Error : Disable(Default), Enable

If the BIOS occurs a checksum error or the Main BIOS occurs a WIDE RANGE PROTECTION error and Halt On BIOS Defects set to Enable, the PC will show messages on the boot screen, and the system will pause and wait for the user's instruction.

If Auto Recovery: Disable, it will show <or the other key to continue.>

If Auto Recovery: Enable, it will show <or the other key to Auto Recover.>

Copy Main ROM Data to Backup

Backup message:

Are you sure to copy BIOS?

[Enter] to continue or [Esc] to abort...

The means that the Main BIOS works normally and could automatically recover the Backup BIOS. Or the means that the Backup BIOS works normally and could automatically recover the Main BIOS.



(This auto recovery utility is set by system automatically and can't be changed by user.)

C. What is Q-Flash Utility?

Q-Flash utility is a pre-O.S. BIOS flash utility enables users to update its BIOS within BIOS mode, no more fooling around any OS.

D. How to use Q-Flash?

Load Main (Backup) BIOS From Floppy

-  In the A:drive, insert the "BIOS" diskette, then Press Enter to Run.
-  You can use the light bar to select item. then Press "Enter".
-  For Example: BIOS File name: 7VRXP.E8

Dual BIOS Utility

Boot From.....Main BIOS
 Main ROM Type.....SST 39SF020
 Backup ROM Type.....SST 39SF020

3 file(s) found

COMMAND.COM	92.8K
FLASH848.EXE	472.16K
7VRXP.E8	256K
Total size: 1.39M	
Free size:316k	
F5:Refresh	DEL:Delete

Q-Flash Utility

Load Main BIOS From Floppy
 Load Backup BIOS From Floppy
 Save Main BIOS to Floppy
 Save Backup BIOS to Floppy



PgDn/PgUp:Modify ↑↓:Move ESC:Reset F10:Power Off

Reading BIOS file from Floppy
 Don't Turn Off Power or RESET System...

CHECKSUM=78B7
Are you sure to update BIOS?
 [Enter] to continue or [Esc] to abort.....

!!COPY BIOS Complete-Pass!!
Please press any key to continue

Save Main (Backup) BIOS to Floppy

-  In the A:drive, insert the "BIOS" diskette, then Press Enter to Run.
-  You can use the light bar to select item. then Press "Enter".

Dual BIOS Utility																			
Boot From.....Main BIOS																			
Main ROM Type.....SST 39SF020																			
Backup ROM Type.....SST 39SF020																			
<table border="1" style="width: 100%; border-collapse: collapse;"> <thead> <tr> <th colspan="2" style="text-align: center;">TYPE FILE NAME</th> </tr> </thead> <tbody> <tr> <td colspan="2">File name:</td> </tr> <tr> <td colspan="2" style="text-align: center;">3 file(s) found</td> </tr> <tr> <td>COMMAND.COM</td> <td style="text-align: right;">92.8K</td> </tr> <tr> <td>FLASH848.EXE</td> <td style="text-align: right;">472.16K</td> </tr> <tr> <td>7VRXP.E8</td> <td style="text-align: right;">256K</td> </tr> <tr> <td colspan="2">Total size: 1.39M</td> </tr> <tr> <td colspan="2" style="text-align: right;">Free size:316k</td> </tr> <tr> <td>F5:Refresh</td> <td style="text-align: right;">DEL:Delete</td> </tr> </tbody> </table>		TYPE FILE NAME		File name:		3 file(s) found		COMMAND.COM	92.8K	FLASH848.EXE	472.16K	7VRXP.E8	256K	Total size: 1.39M		Free size:316k		F5:Refresh	DEL:Delete
TYPE FILE NAME																			
File name:																			
3 file(s) found																			
COMMAND.COM	92.8K																		
FLASH848.EXE	472.16K																		
7VRXP.E8	256K																		
Total size: 1.39M																			
Free size:316k																			
F5:Refresh	DEL:Delete																		
Load Backup BIOS From Floppy																			
Save Main BIOS to Floppy																			
Save Backup BIOS to Floppy																			
PgDn/PgUp:Modify ↑↓:Move ESC:Reset F10:Power Off																			

Saving BIOS to floppy
Don't Turn Off Power or RESET System...



DualBIOS™ Technology FAQ

GIGABYTE Technology is pleased to introduce DualBIOS technology, a hot spare for your system BIOS. This newest “Value-added” feature, in a long series of innovations from GIGABYTE, is available on this motherboard. Future GIGABYTE motherboards will also incorporate this innovation.

What’s DualBIOS™?

On GIGABYTE motherboards with DualBIOS there are physically two BIOS chips. For simplicity we’ll call one your “Main BIOS” and the other we’ll call your “Backup” BIOS (your “hot spare”). If your Main BIOS fails, the Backup BIOS almost automatically takes over on your next system boot. Almost automatically and with virtually zero down time! Whether the problem is a failure in flashing your BIOS or a virus or a catastrophic failure of the Main BIOS chip, the result is the same - the Backup BIOS backs you up, almost automatically.

I. Q: What is DualBIOS™ technology?**Answer:**

DualBIOS technology is a patented technology from Giga-Byte Technology. The concept of this technology is based on the redundancy and fault tolerance theory. DualBIOS™ technology simply means there are two system BIOSes (ROM) integrated onto the motherboard. One is a main BIOS, and the other is a backup BIOS. The mainboard will operate normally with the main BIOS, however, if the main BIOS is corrupt or damaged for various reasons, the backup BIOS will be automatically used when the system powered-On. Your PC will operate as before the main BIOS was damaged, and is completely transparent to the user.

II. Q: Why does anyone need a motherboard with DualBIOS™ technology?**Answer:**

In today's systems there are more and more BIOS failures. The most common reasons are virus attacks, BIOS upgrade failures, and/or deterioration of the BIOS (ROM) chip itself.

1. New computer viruses are being found that attack and destroy the system BIOS. They may corrupt your BIOS code, causing your PC to be unstable or even not boot normally.
2. BIOS data will be corrupted if a power loss/surge occurs, or if a user resets the system, or if the power button is pressed during the process of performing a system BIOS upgrade.
3. If a user mistakenly updates their mainboard with the incorrect BIOS file, then the system may not be able to boot correctly. This may cause the PC system hang in operation or during boot.
4. A flash ROM's life cycle is limited according to electronic characteristics. The modern PC utilizes the Plug and Play BIOS, and is updated regularly. If a user changes peripherals often, there is a slight chance of damage to the flash ROM.

With Giga-Byte Technology's patented DualBIOS™ technology you can reduce the possibility of hangs during system boot up, and/or loss BIOS data due to above reasons. This new technology will eliminate valuable system down time and costly repair bills cause by BIOS failures.

III. Q: How does DualBIOS™ technology work?

Answer:

1. DualBIOS™ technology provides a wide range of protection during the boot up procedure. It protects your BIOS during system POST, ESCD update, and even all the way to PNP detection/assignment.
2. DualBIOS™ provides automatic recovery for the BIOS. When the first BIOS used during boot up does not complete or if a BIOS checksum error occurs, boot-up is still possible. In the DualBIOS™ utility, the “Auto Recovery” option will guarantee that if either the main BIOS or backup BIOS is corrupted, the DualBIOS™ technology will use the good BIOS and correct the wrong BIOS automatically.
3. DualBIOS™ provides manual recovery for the BIOS. DualBIOS™ technology contains a built-in flash utility, which can flash your system BIOS from backup to main and/or visa versa. There is no need for an OS-dependent flash utility program.
4. DualBIOS™ contains a one-way flash utility. The built-in one-way flash utility will ensure that the corrupt BIOS is not mistaken as the good BIOS during recovery and that the correct BIOS (main vs. backup) will be flashed. This will prevent the good BIOS from being flashed.

IV. Q: Who Needs DualBIOS™ technology?

Answer:

1. Every user should have DualBIOS™ technology due to the advancement of computer viruses.

Everyday, there are new BIOS-type viruses discovered that will destroy your system BIOS. Most commercial products on the market do not have solutions to guard against this type of virus intrusion. The DualBIOS™ technology will provide a state-of-the-art solution to protect your PC:

Case I.) Vicious computer viruses may wipe out your entire system BIOS. With a conventional single system BIOS PC, the PC will not be functional until it is sent for repairs.

Case II.) If the “Auto Recovery” option is enabled in the DualBIOS™ utility, and if a virus corrupts your system BIOS, the backup BIOS will automatically reboot the system and correct the main BIOS.

Case III.) A user may override booting from the main system BIOS. The DualBIOS™ utility may be entered to manually change the boot sequence to boot from the backup BIOS.

2. During or after a BIOS upgrade, if DualBIOS™ detects that the main BIOS is corrupt, the backup BIOS will take over the boot-up process automatically. Moreover, it will verify the main and backup BIOS checksums when booting-up. DualBIOS™ technology examines the checksum of the main and backup BIOS while the system is powered on to guarantee your BIOS operates properly.
3. Power Users will have the advantage of having two BIOS versions on their mainboard. The benefit is being able to select either version BIOS to suit the performance system needs.
4. Flexibility for high-end desktop PCs and workstation/servers. In the DualBIOS™ utility, the option can be set, "Halt On When BIOS Defects," to be enabled to halt your system with a warning message that the main BIOS has been corrupted. Most workstation/servers require constant operation to guarantee services have not been interrupted. In this situation, the "Halt On When BIOS Defects" message may be disabled to avoid system pauses during normal booting. Another advantage you gain from Giga-Byte's DualBIOS™ technology is the ability to upgrade from dual 2 Mbit BIOS to dual 4 Mbit BIOS in the future if extra BIOS storage is need.

Four Speaker & SPDIF Introduction

Four Speaker Introduction

A. What is Four Speaker?

The Creative CT5880 audio chip can support up to 4 speaker output. If you select "Four speaker out", Line In will be reconfigured as another line out to support a second pair of speakers.

B. How to use Four Speaker?

Microsoft Windows 98 Second Edition setup procedure:

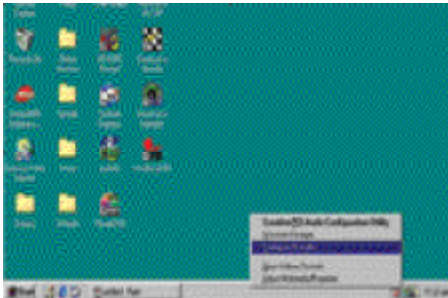

Click the audio icon along the task bar and select "Configure 3D Audio"



Select two speaker (Default)



Select "Four speaker" item.

Microsoft Windows Me setup procedure:



Go to "Control Panel" and double click "Sounds and Multimedia".

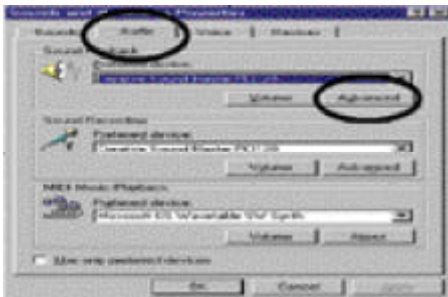

Select "Audio" Page, and click "Advanced" button.

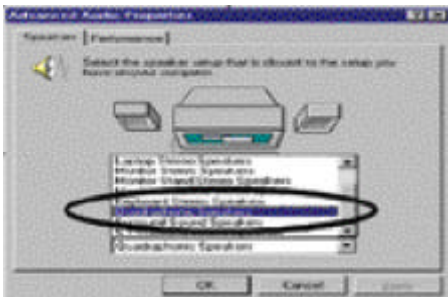

Select "Quadraphonic Speakers" and click ok.

C. Four Speaker Application

The four speaker function will only be supported in application softwares that use Microsoft DirectX and Creative EAX, for example, the game titles, software DVD player and MP3 player.

SPDIF Introduction

A. What is SPDIF?

The SPDIF output is capable of providing digital signal to AC3 decoder which can support upto 5.1 speakers.

B. How to use SPDIF?



Click your mouse right button in "My Computer" and select the "Properties" item.

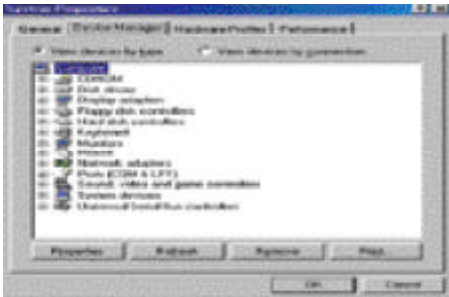

Click "Device Manager" item.

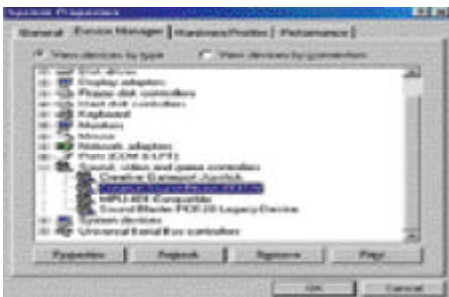

Click "Sound, video and game controllers" item and select the "Creative Sound Blaster PCI128" item.

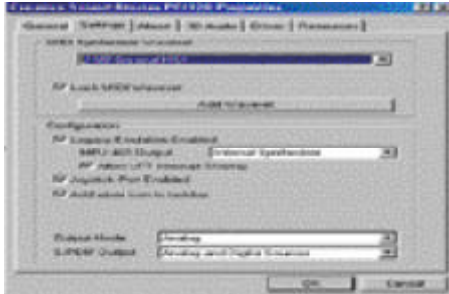

Click "Settings" item and select the "Output Mode" item.

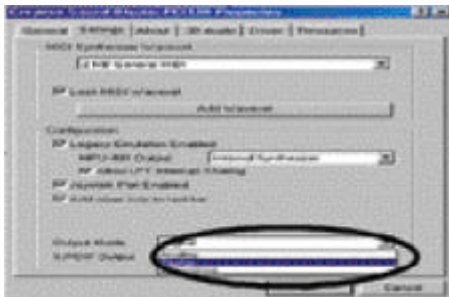

Click "Digital" item, Line Out will be reconfigure to SPDIF Out.

Recommend you to select "Autosense", It will automatically detect the type (mono or stereo) of the audio connector that you plug into Line Out audio jack, then configure Line Out to either SPDIF or Speaker accordingly.

@ BIOS Introduction

Gigabyte announces @ BIOS Windows BIOS live update utility



Have you ever updated BIOS by yourself? Or like many other people, you just know what BIOS is, but always hesitate to update it? Because you think updating newest BIOS is unnecessary and actually you don't know how to update it.

Maybe not like others, you are very experienced in BIOS updating and spend quite a lot of time to do it. But of course you don't like to do it too much. First, download different BIOS from website and then switch the operating system to DOS mode. Secondly, use different flash utility to update BIOS. The above process is not a interesting job. Besides, always be carefully to store the BIOS source code correctly in your disks as if you update the wrong BIOS, it will be a nightmare.

Certainly, you wonder why motherboard vendors could not just do something right to save your time and effort and save you from the lousy BIOS updating work? Here it comes! Now Gigabyte announces @BIOS—the first Windows BIOS live update utility. This is a smart BIOS update software. It could help you to download the BIOS from internet and update it. Not like the other BIOS update software, it's a Windows utility. With the help of "@BIOS", BIOS updating is no more than a click.

Besides, no matter which mainboard you are using, if it's a Gigabyte's product*, @BIOS help you to maintain the BIOS. This utility could detect your correct mainboard model and help you to choose the BIOS accordingly. It then downloads the BIOS from the nearest Gigabyte ftp site automatically. There are several different choices; you could use "Internet Update" to download and update your BIOS directly. Or you may want to keep a backup for your current BIOS, just choose "Save Current BIOS" to save it first. You make a wise choice to use Gigabyte, and @BIOS update your BIOS smartly. You are now worry free from updating wrong BIOS, and capable to maintain and manage your BIOS easily. Again, Gigabyte's innovative product erects a milestone in mainboard industries.

For such a wonderful software, how much it costs? Impossible! It's free! Now, if you buy a Gigabyte's motherboard, you could find this amazing software in the attached driver CD. But please remember, connected to internet at first, then you could have a internet BIOS update from your Gigabyte @BIOS.

Easy Tune™ 4 Introduction

Gigabyte announces *EasyTune™ 4*

Windows based Overclocking utility

EasyTune 4 carries on the heritage so as to pave the way for future generations.



"Overclock" might be one of the most common issues in computer field. But have many users ever tried it? The answer is probably "no". Because "Overclock" is thought to be very difficult and includes a lot of technical know-how, sometimes "Overclock" is even considered as special skills found only in some enthusiasts. But as to the experts in "Overclock", what's the truth? They may spend quite a lot of time and money to study, try and use many different hard-

ware or BIOS tools to do "Overclock". And even with these technologies, they still learn that it's quite a risk because the safety and stability of an "Overclock" system is unknown. Now everything is different because of a Windows based overclocking utility "EasyTune 4" --announced by Gigabyte. This windows based utility has totally changed the gaming rule of "Overclock". This is the first windows based overclocking utility is suitable for both normal and power users. Users can choose either "Easy Mode" or "Advanced Mode" for overclocking at their convenience. For users who choose "Easy Mode", they just need to click "Auto Optimize" to have autoed and immediate CPU overclocking. This software will then overdrive CPU speed automatically with the result being shown in the control panel. If users prefer "Overclock" by them, there is also another choice. Click "Advanced Mode" to enjoy "sport drive" class Overclocking user interface. "Advanced Mode", allows users to change the system bus / AGP / Memory working frequency in small increments to get ultimate system performance. It operates in coordination with Gigabyte motherboards. Besides, it is different from other traditional over-clocking methods, EasyTune 4 doesn't require users to change neither BIOS nor hardware switch/ jumper setting; on the other hand, they can do "Overclock" at easy step . Therefore, this is a safer way for "Overclock" as nothing is changed on software or hardware. If user runs EasyTune 4 over system's limitation, the biggest lost is only to restart the computer again and the side effect is then well controlled. Moreover, if one well-performed system speed has been tested in EasyTune 4, user can "Save" this setting and "Load" it in next time. Obviously, Gigabyte EasyTune 4 has already turned the "Overclock" technology toward to a newer generation. This wonderful software is now free bundled in Gigabyte motherboard attached in driver CD. Users may make a test drive of "EasyTune 4" to find out more amazing features by themselves.

*Some Gigabyte products are not fully supported by EasyTune 4. Please find the products supported list in the web site.

*Any "Overclocking action" is at user's risk, Gigabyte Technology will not be responsible for any damage or instability to your processor, motherboard, or any other components.

Chapter 5 Appendix

Picture below are shown in Windows XP (IUCD driver version 2.02)

Insert the driver CD-title that came with your motherboard into your CD-ROM driver, the driver CD-title will auto start and show the installation guide. If not, please double click the CD-ROM device icon in "My computer", and execute the setup.exe.

A. Installing Intel 850 Chipset Driver

Please install this driver as the first priority. this item installs the chipset driver utility that enables Plug-n-Plug INF support for Intel chipset component.

B. Installing Sound Driver

Click this item to install sound driver.

C. Installing LAN Driver

Click this item to install LAN driver.



Appendix A: Intel 850 Chipset Driver Installation

Follow the setup that showing on the screen to install the Utility.



In order to install the driver successfully, please refer to the following installation procedures.

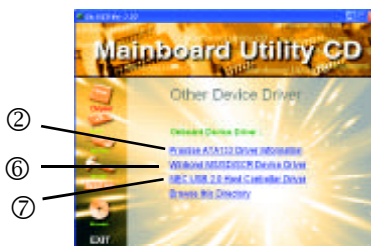

A-1. Intel Chipset Software Installation Utility

Insert the driver CD-title that came with your motherboard into your CD-ROM driver, the driver CD-title will auto start and show the installation guide. If not, please double click the CD-ROM device icon in "My computer", and execute the setup.exe.



(1)



(2)

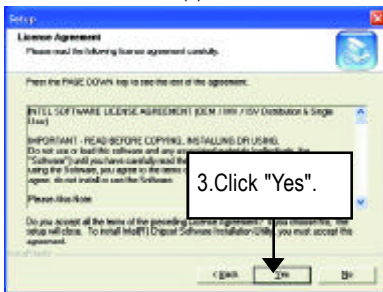

(3)

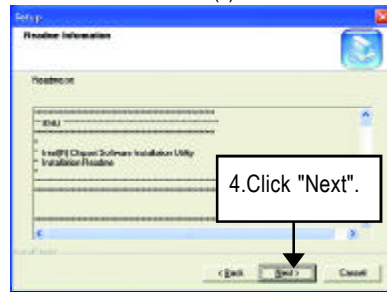

(4)

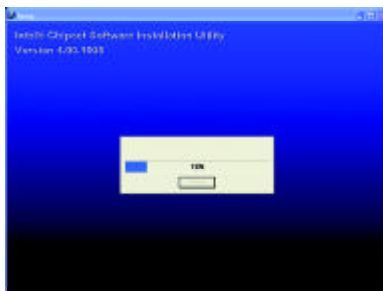

(5)

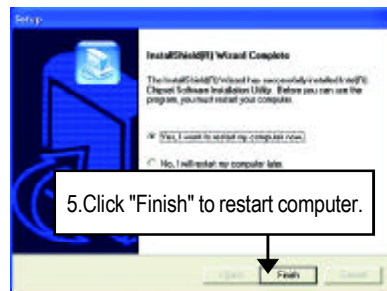

(6)

A-2. Intel Application Accelerator

Insert the driver CD-title that came with your motherboard into your CD-ROM driver, the driver CD-title will auto start and show the installation guide. If not, please double click the CD-ROM device icon in "My computer", and execute the setup.exe.



(1)

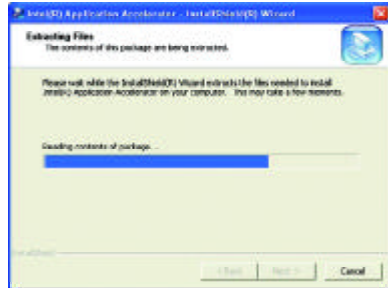

(2)

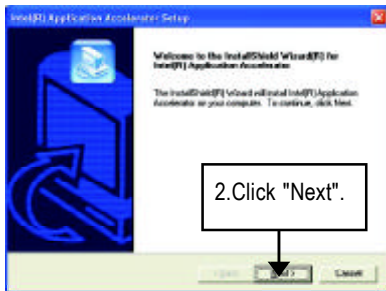

(3)

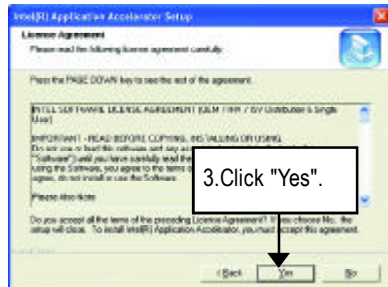

(4)

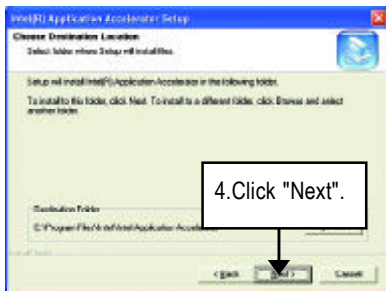

(5)

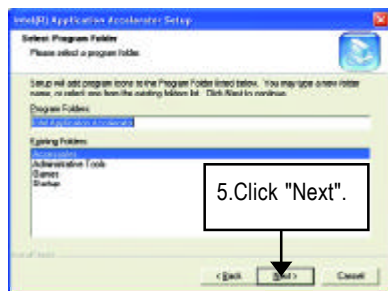

(6)

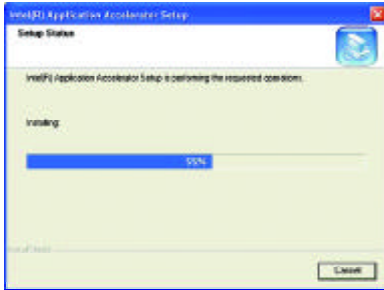

(7)

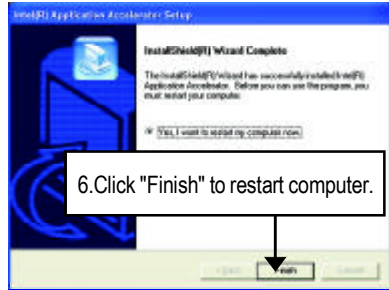

(8)

A-3. USB Patch Driver

Insert the driver CD-title that came with your motherboard into your CD-ROM driver, the driver CD-title will auto start and show the installation guide. If not, please double click the CD-ROM device icon in "My computer", and execute the setup.exe.



(1)

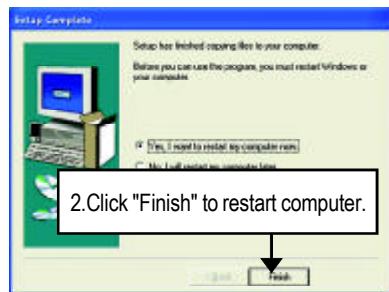

(2)

A-4: USB 2.0 Driver for ICH4 (Expiry date: 6/1/2002)

USB2.0 Driver Installation for ICH4 is the same with "NEC 2.0 Host Controller Driver", please go to the gigabyte's website (<http://www.gigabyte.com.tw>) and download the latest ICH4 USB2.0 driver version after expiry date (6/1/2002).

Appendix B: Creative CT5880 Audio Driver

Insert the driver CD-title that came with your motherboard into your CD-ROM driver, the driver CD-title will auto start and show the installation guide. If not, please double click the CD-ROM device icon in "My computer", and execute the setup.exe.

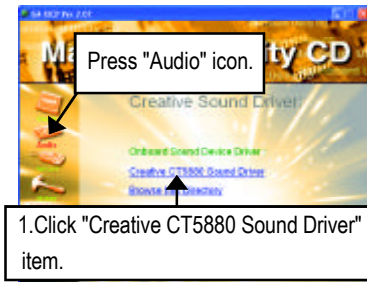

(1)



(2)



(3)

Appendix C: RealTek 8139/8130/8100 Network Driver

Insert the driver CD-title that came with your motherboard into your CD-ROM driver, the driver CD-title will auto start and show the installation guide. If not, please double click the CD-ROM device icon in "My computer", and execute the setup.exe.



(1)

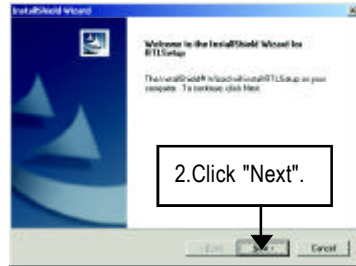

(2)

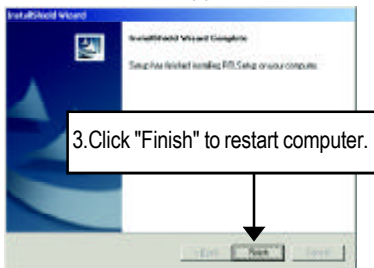

(3)

Appendix D: Other Device Driver

D-1. Promise ATA133 Driver information

(This manual assumes that your CD-ROM device drive letter is D:).

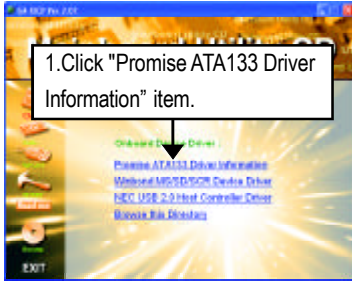

(1)



(2)

If you want to install ATA133 Driver, go to "Control Panel-->System-->Device Manager" and install driver by manually. Please refer to the following procedure:

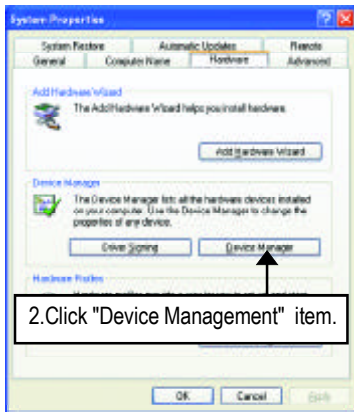

(3)

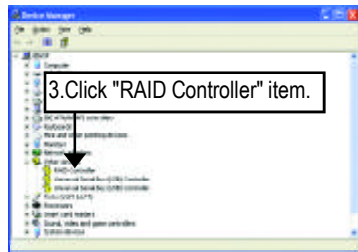

(4)



(5)

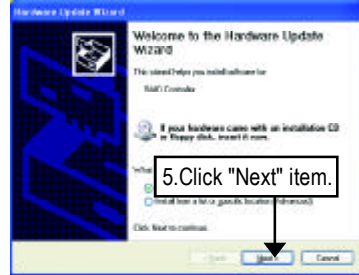

(6)

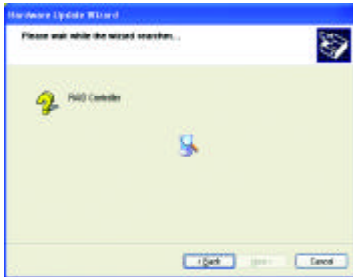

(7)

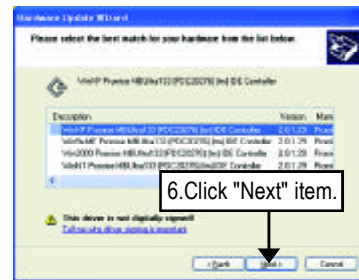

(8)

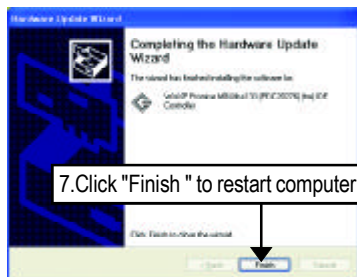

(9)

D-2. Winbond MS/SD/SCR Device Driver

Insert the driver CD-title that came with your motherboard into your CD-ROM driver, the driver CD-title will auto start and show the installation guide. If not, please double click the CD-ROM device icon in "My computer", and execute the setup.exe.

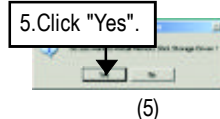
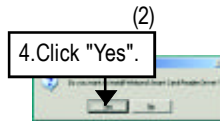
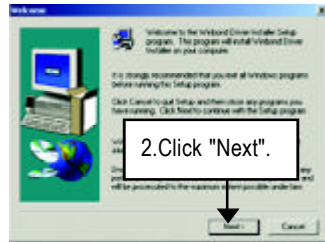
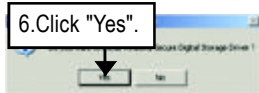
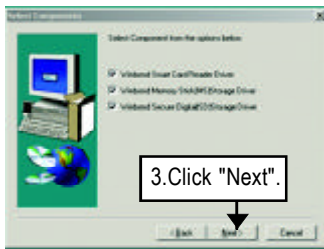

D-3.NEC USB 2.0 Host Controller Driver

(This manual assumes that your CD-ROM device drive letter is D:).

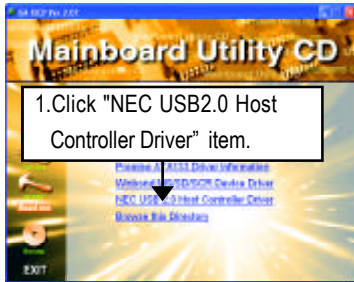

(1)



(2)

If you want to install USB 2.0 Driver, go to "Control Panel-->System-->Device Manager" and install driver by manually. Please refer to the following procedure:

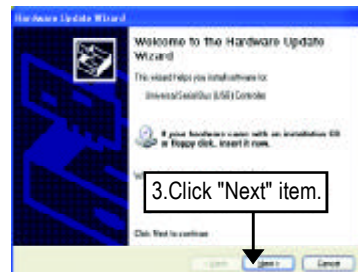
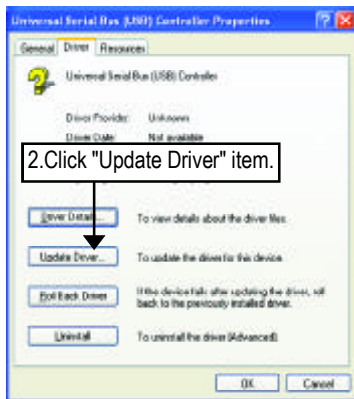

Appendix E: EasyTune 4 Utilities Installation

Insert the driver CD-title that came with your motherboard into your CD-ROM driver, the driver CD-title will auto start and show the installation guide. If not, please double click the CD-ROM device icon in "My computer", and execute the setup.exe.

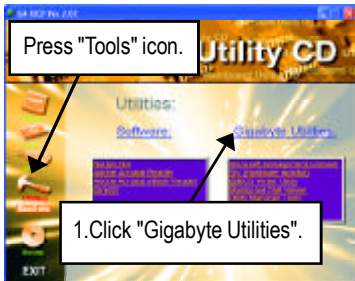

(1)



(2)

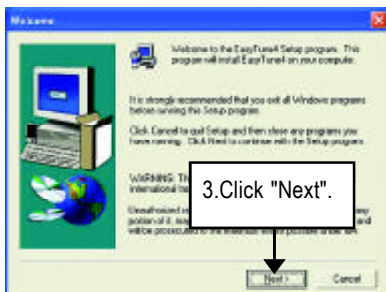

(3)



(4)

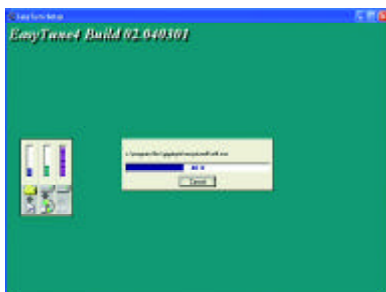

(5)

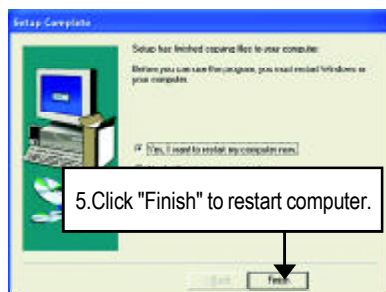

(6)

Appendix F: Face-Wizard Utilities Installation

What is Face-Wizard™?

Face-Wizard™ is a windows based utility with user-friendly interface that allows users to change the boot-up logo with picture from Gigabyte Logo Gallery on web site or other compatible picture you have.

How does it work?

Face-Wizard™ allows user to select BIOS on board or file in hard drive, floppy disk , zip, MO or other storage devices and combine the compatible picture you prefer into BIOS. And not only this, Face-Wizard™ also helps user to update BIOS in windows mode.

What's benefit for using Face-Wizard™?

It can personalize boot-up logo to show your unique style from others, and never again looking at the black and white boot up screen.



(1)



(2)



(3)

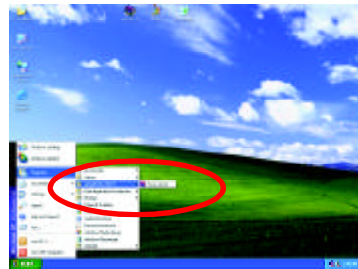

(4)

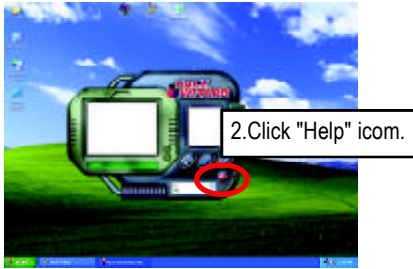

(5)



(6)

Appendix G: BIOS Flash Procedure

BIOS update procedure:

Method 1:

If your OS is Win9X, we recommend that you used Gigabyte @BIOS™ Program to flash BIOS.

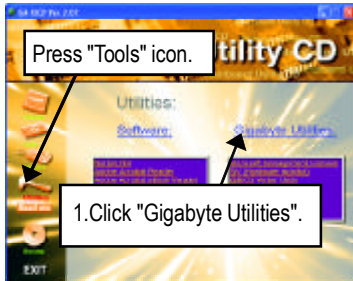

(1)

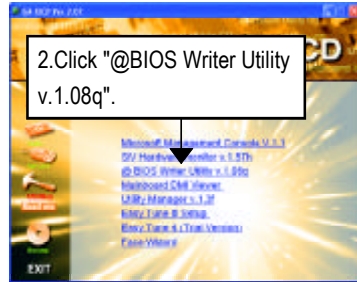

(2)

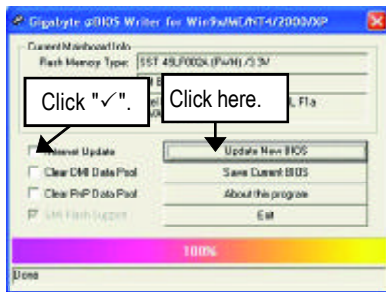

(3)

Methods and steps:

I. Update BIOS through Internet

- a. Click "Internet Update" icon
- b. Click "Update New BIOS" icon
- c. Select @BIOS™ sever ("Gigabyte @BIOS™ sever 1 in Taiwan" and "Gigabyte @BIOS™ sever 2 in Taiwan" are available for now, the others will be completed soon)
- d. Select the exact model name on your motherboard
- e. System will automatically download and update the BIOS.

II. Update BIOS NOT through Internet:

- a. Do not click "Internet Update" icon
- b. Click "Update New BIOS"
- c. Please select "All Files" in dialog box while opening the old file.
- d. Please search for BIOS unzip file, downloading from internet or any other methods (such as: 8IHPX.F1).
- e. Complete update process following the instruction.

III. Save BIOS

In the very beginning, there is "Save Current BIOS" icon shown in dialog box. It means to save the current BIOS version.

IV. Check out supported motherboard and Flash ROM:

In the very beginning, there is "About this program" icon shown in dialog box. It can help you check out which kind of motherboard and which brand of Flash ROM are supported.

Note:

- a. In method I, if it shows two or more motherboard's model names to be selected, please make sure your motherboard's model name again. Selecting wrong model name will cause the system unbooted.
- b. In method II, be sure that motherboard's model name in BIOS unzip file are the same as your motherboard's. Otherwise, your system won't boot.
- c. In method I, if the BIOS file you need cannot be found in @BIOS™ server, please go onto Gigabyte's web site for downloading and updating it according to method II.
- d. Please note that any interruption during updating will cause system unbooted

Method 2:

We use GA-7VTX motherboard and Flash841 BIOS flash utility as example.

Please flash the BIOS according to the following procedures if you are now under the DOS mode.

Flash BIOS Procedure:

STEP 1:

- (1) Please make sure your system has installed the extraction utility such as winzip or pkunzip.

Firstly you have to install the extraction utility such as winzip or pkunzip for unzip the files. Both of these utilities are available on many shareware download pages like <http://www.shareware.cnet.com>

STEP 2: Make a DOS boot diskette. (See example: Windows 98 O.S.)

Beware: Windows ME/2000 are not allowed to make a DOS boot diskette.

- (1) With an available floppy disk in the floppy drive. Please leave the diskette "UN-write protected" type. Double click the "My Computer" icon from Desktop, then click "3.5 diskette (A)" and right click to select "Format (M)"

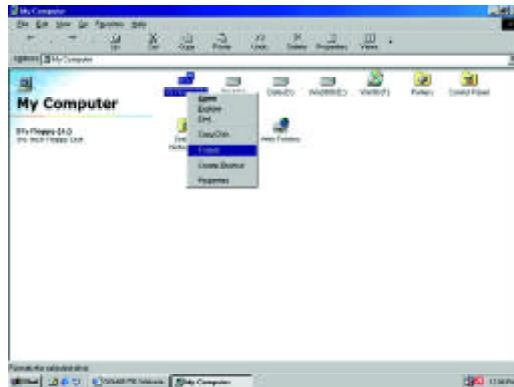

- (2) Select the "Quick (erase)" for Format Type, and pick both "Display summary when finished" and "Copy system files", after that press "Start". That will format the floppy and transfer the needed system files to it.

Beware: This procedure will erase all the prior data on that floppy, so please proceed accordingly.

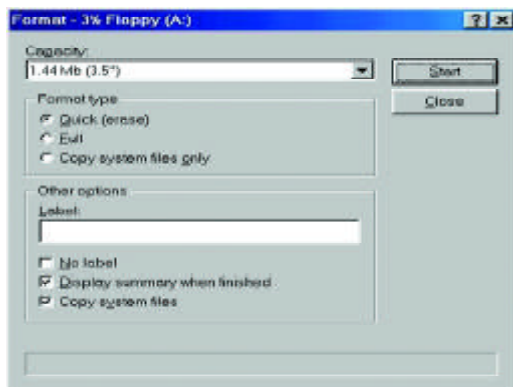

- (3) After the floppy has been formatted completely, please press "Close".

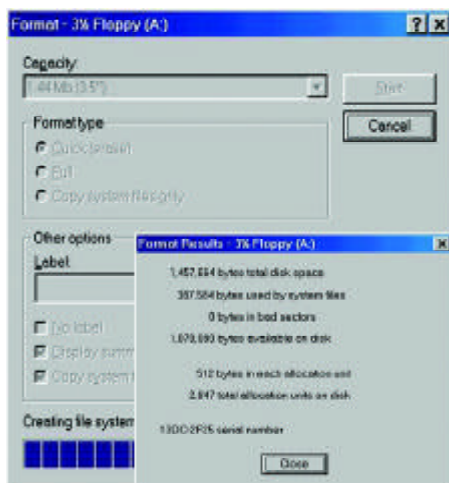

STEP 3: Download BIOS and BIOS utility program.

(1) Please go to Gigabyte website <http://www.gigabyte.com.tw/index.html>, and click "Support".



(2) From Support zone, click the "Motherboards BIOS & Drivers".



- (3) We use GA-7VTX motherboard as example. Please select GA-7VTX by Model or Chipset optional menu to obtain BIOS flash files.

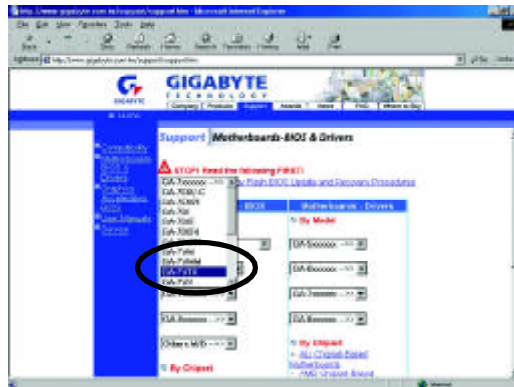

- (4) Select an appropriate BIOS version (For example: F4), and click to download the file. It will pop up a file download screen, then select the "Open this file from its current location" and press "OK".



- (5) At this time the screen shows the following picture, please click "Extract" button to unzip the files.

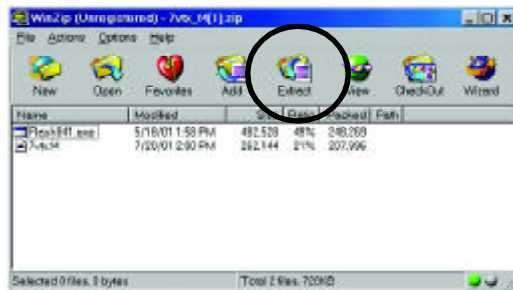

- (6) Please extract the download files into the clean bootable floppy disk A mentioned in STEP 2, and press "Extract".

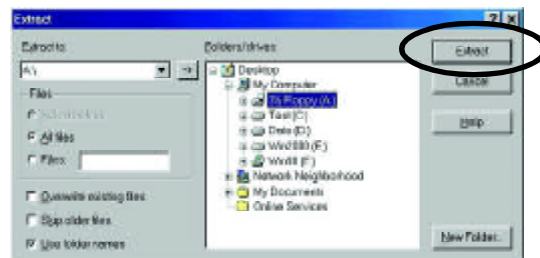

STEP 4: Make sure the system will boot from the floppy disk.

- (1) Insert the floppy disk (contains bootable program and unzip file) into the floppy drive A. Then, restart the system. The system will boot from the floppy disk. Please press key to enter BIOS setup main menu when system is boot up.

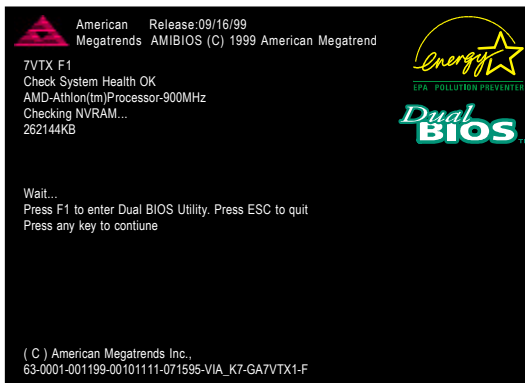

- (2) Once you enter the BIOS setup utility, the main menu will appear on the screen. Use the arrows to highlight the item "BIOS FEATURES SETUP".

AMIBIOS SIMPLE SETUP UTILITY - VERSION 1.24b (C) 1999 American Megatrends, Inc. All Rights Reserved	
STANDARD CMOS SETUP BIOS FEATURES SETUP CHIPSET FEATURES SETUP POWER MANAGEMENT SETUP PNP / PCI CONFIGURATION LOAD BIOS DEFAULTS LOAD SETUP DEFAULTS	INTEGRATED PERIPHERALS HARDWARE MONITOR & MISC SETUP SUPERVISOR PASSWORD USER PASSWORD IDE HDD AUTO DETECTION SAVE & EXIT SETUP EXIT WITHOUT SAVING
ESC: Quit ↑↓←→ : Select Item (Shift)F2 : Change Color F5: Old Values F6: Load BIOS Defaults F7: Load Setup Defaults F10: Save & Exit	
Time, Date , Hard Disk Type...	

- (3) Press "Enter" to enter "BIOS FEATURES SETUP" menu. Use the arrows to highlight the item "1st Boot Device", and then use the "Page Up" or "Page Down" keys to select "Floppy".

AMIBIOS SETUP - BIOS FEATURES SETUP	
(C.) 2001 American Megatrends, Inc. All Rights Reserved	
1st Boot Device : Floppy	
2nd Boot Device : IDE-0	
3rd Boot Device : CDROM	
S.M.A.R.T. for Hard Disks : Disabled	
BootUp Num-Lock : On	ESC: Quit ↑↓←→: Select Item
Floppy Drive Seek : Disabled	F1 : Help PU/PD/+/- : Modify
Password Check : Setup	F5 : Old Values (Shift)F2: Color
	F6 : Load BIOS Defaults
	F7 : Load Setup Defaults

- (4) Press "ESC" to go back to previous screen. Use the arrows to highlight the item "SAVE & EXIT SETUP" then press "Enter". System will ask "SAVE to CMOS and EXIT (Y/N)?" Press "Y" and "Enter" keys to confirm. Now the system will reboot automatically, the new BIOS setting will be taken effect next boot-up.

AMIBIOS SIMPLE SETUP UTILITY - VERSION 1.24b	
(C) 2001 American Megatrends, Inc. All Rights Reserved	
STANDARD CMOS SETUP	INTEGRATED PERIPHERALS
BIOS FEATURES SETUP	HARDWARE MONITOR & MISC SETUP
CHIPSET FEATURES SETUP	SUPERVISOR PASSWORD
POWER MANAGEMENT SETUP	USER PASSWORD
PNP / PCI CONF	Save to CMOS and EXIT (Y/N)? Y
LOAD BIOS DEFAULTS	SAVE & EXIT SETUP
LOAD SETUP DEFAULTS	EXIT WITHOUT SAVING
ESC: Quit ↑↓←→ : Select Item (Shift)F2 : Change Color F5: Old Values	
F6: Load BIOS Defaults F7: Load Setup Defaults F10: Save & Exit	
Save Data to CMOS & Exit SETUP	

STEP 5: BIOS flashing.

- (1) After the system boot from floppy disk, type "A:\> dir/w" and press "Enter" to check the entire files in floppy A. Then type the "BIOS flash utility" and "BIOS file" after A:\>. In this case you have to type "A:\> Flash841 7VTX.F4" and then press "Enter".

```
Starting Windows 98...

Microsoft(R) Windows98
  © Copyright Microsoft Corp 1981-1999

A:\> dir/w
  Volume in drive A has no label
  Volume Serial Number is 16EB-353D
  Directory of A:\
COMMAND.COM      7VTX.F4  FLASH841.EXE
      3 file(s)    838,954 bytes
      0 dir(s)    324,608 bytes free

A:\> Flash841 7VTX.F4
```

- (2) Now screen appears the following Flash Utility main menu. Press "Enter", the highlighted item will locate on the model name of the right-upper screen. Right after that, press "Enter" to start BIOS Flash Utility.

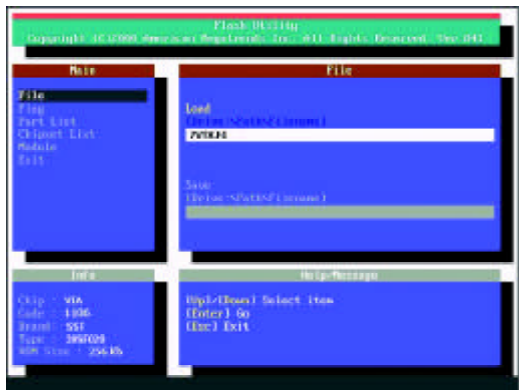

- (3) It will pop up a screen and asks "Are you sure to flash the BIOS?" Press [Enter] to continue the procedure, or press [ESC] to quit.

Beware: Please do not turn off the system while you are upgrading BIOS. It will render your BIOS corrupted and system totally inoperative.

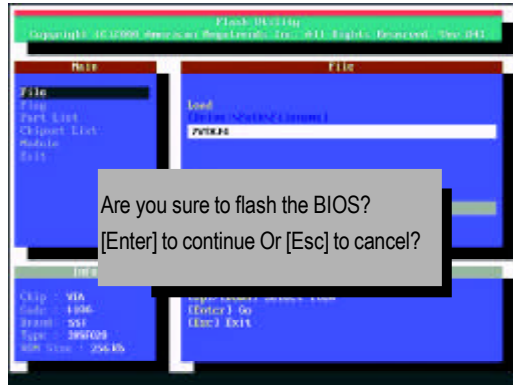

- (4) The BIOS flash completed. Please press [ESC] to exit Flash Utility.

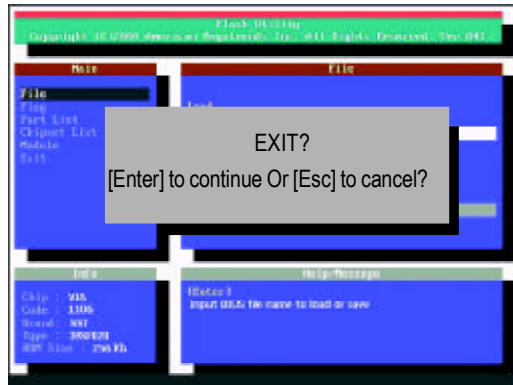

STEP 6: Load BIOS defaults.

Normally the system redetects all devices after BIOS has been upgraded. Therefore, we highly recommend reloading the BIOS defaults after BIOS has been upgraded. This important step resets everything after the flash.

- (1) Take out the floppy diskette from floppy drive, and then restart the system. The boot up screen will indicate your motherboard model and current BIOS version.



- (2) Don't forget to press key to enter BIOS setup again when system is boot up. Use the arrows to highlight the item "LOAD SETUP DEFAULTS" then press "Enter". System will ask "Load Setup Defaults (Y/N)?" Press "Y" and "Enter" keys to confirm.

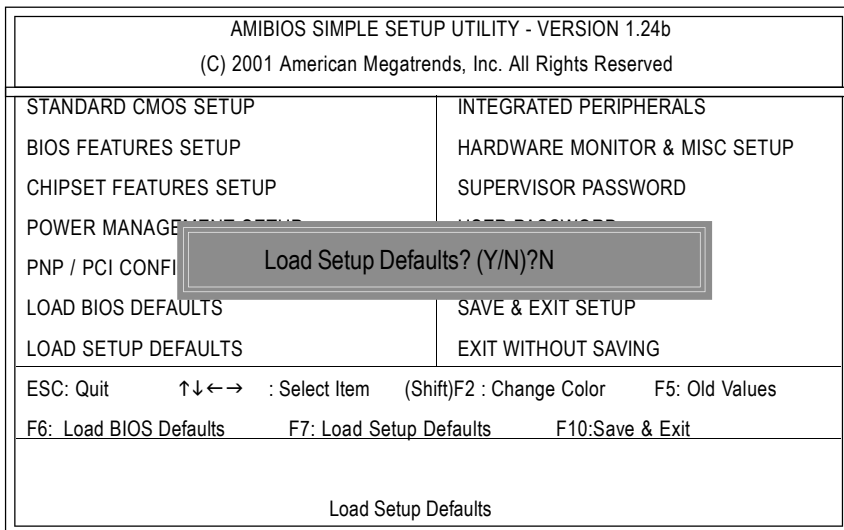

- (3) Use the arrows to highlight the item "SAVE & EXIT SETUP" and press "Enter". System will ask "SAVE to CMOS and EXIT (Y/N)?" Press "Y" and "Enter" keys to confirm. Now the system will reboot automatically, the new BIOS setting will be taken effect next boot-up.

AMIBIOS SIMPLE SETUP UTILITY - VERSION 1.24b	
(C) 2001 American Megatrends, Inc. All Rights Reserved	
STANDARD CMOS SETUP	INTEGRATED PERIPHERALS
BIOS FEATURES SETUP	HARDWARE MONITOR & MISC SETUP
CHIPSET FEATURES SETUP	SUPERVISOR PASSWORD
POWER MANAGEMENT SETUP	USER PASSWORD
PNP / PCI CONF	↓
LOAD BIOS DEFAULTS	SAVE & EXIT SETUP
LOAD SETUP DEFAULTS	EXIT WITHOUT SAVING
ESC: Quit ↑↓←→ : Select Item (Shift)F2 : Change Color F5: Old Values	
F6: Load BIOS Defaults F7: Load Setup Defaults F10: Save & Exit	
Save Data to CMOS & Exit SETUP	

- (4) Congratulate you have accomplished the BIOS flash procedure.

Appendix H: Acronyms

Acronyms	Meaning
ACPI	Advanced Configuration and Power Interface
APM	Advanced Power Management
AGP	Accelerated Graphics Port
AMR	Audio Modem Riser
ACR	Advanced Communications Riser
BIOS	Basic Input / Output System
CPU	Central Processing Unit
CMOS	Complementary Metal Oxide Semiconductor
CRIMM	Continuity RIMM
CNR	Communication and Networking Riser
DMA	Direct Memory Access
DMI	Desktop Management Interface
DIMM	Dual Inline Memory Module
DRM	Dual Retention Mechanism
DRAM	Dynamic Random Access Memory
DDR	Double Data Rate
ECP	Extended Capabilities Port
ESCD	Extended System Configuration Data
ECC	Error Checking and Correcting
EMC	Electromagnetic Compatibility
EPP	Enhanced Parallel Port
ESD	Electrostatic Discharge
FDD	Floppy Disk Device
FSB	Front Side Bus
HDD	Hard Disk Device
IDE	Integrated Dual Channel Enhanced
IRQ	Interrupt Request
I/O	Input / Output
IOAPIC	Input Output Advanced Programmable Input Controller
ISA	Industry Standard Architecture
LAN	Local Area Network

to be continued.....

Acronyms	Meaning
LBA	Logical Block Addressing
LED	Light Emitting Diode
MHz	Megahertz
MIDI	Musical Instrument Digital Interface
MTH	Memory Translator Hub
MPT	Memory Protocol Translator
NIC	Network Interface Card
OS	Operating System
OEM	Original Equipment Manufacturer
PAC	PCI A.G.P. Controller
POST	Power-On Self Test
PCI	Peripheral Component Interconnect
RIMM	Rambus in-line Memory Module
SCI	Special Circumstance Instructions
SECC	Single Edge Contact Cartridge
SRAM	Static Random Access Memory
SMP	Symmetric Multi-Processing
SMI	System Management Interrupt
USB	Universal Serial Bus
VID	Voltage ID

Technical Support/RMA Sheet

Customer/Country:	Company:	Phone No.:
Contact Person:	E-mail Add. :	

Model name/Lot Number:	PCB revision:
BIOS version:	O.S./A.S.:

Hardware Configuration	Mfs.	Model name	Size:	Driver/Utility:
CPU				
Memory				
Brand				
Video Card				
Audio Card				
HDD				
CD-ROM / DVD-ROM				
Modem				
Network				
AMR / CNR				
Keyboard				
Mouse				
Power supply				
Other Device				

Problem Description:
