



- ☛ The author assumes no responsibility for any errors or omissions that may appear in this document nor does the author make a commitment to up date the information contained herein.
- ☛ Third-party brands and names are the property of their respective owners.
- ☛ Please do not remove any labels on motherboard, this may void the warranty of this motherboard.
- ☛ Due to rapid change in technology, some of the specifications might be out of date before publication of this booklet.



**Mise en garde:** Ne faites jamais tourner le processeur sans que le dissipateur de chaleur soit fixé correctement et fermement. UN DOMMAGE PERMANENT EN RÉSULTERA!

**Anleitung:** Der Prozessor darf nur in Betrieb genommen werden, wenn der W-resubstituter ordnungsgemäß und fest angebracht ist. DIES HAT EINEN PERMANENTEN SCHADEN ZUR FOLGE!

**Advertència:** Nunca haga funcionar el procesador sin el dissipador de calor instalado correcta y firmemente. (SE PRODUCIRÁ UN DAÑO PERMANENTE)

**Atenção:** Nunca execute o processador sem o dissipador de calor estar adequadamente e firmemente conectado. O RESULTADO SERÁ UM DANO PERMANENTE!

**警告:** 将散热器正确地安装到处理器上之前，不要运行处理器，否则将永远损坏处理器！

**警告:** 散热器正确地安装到处理器上之前，不要运行处理器，否则将永远损坏处理器！

**경고:** 칩셋을 제대로 보정하지 부주의하게 같은 세 프로세서를 작동시키지 마십시오. 영구적 고장이 발생할 수 있습니다!

**警告:** 永久的な損傷を防ぐため、ヒートシンクを正しくしっかりと取り付けるまでは、プロセッサを動作させないようご注意ください。

# Declaration of Conformity

We, Manufacturer/Importer  
(full address)

**G.B.T. Technology Trading GmbH**  
**Ausschlagler Weg 41, 1F, 20537 Hamburg, Germany**

declare that the product  
( description of the apparatus, system, installation to which it refers)

## **Mother Board**

GA-8ILMT4

is in conformity with

(reference to the specification under which conformity is declared)  
in accordance with 89/336 EEC-EMC Directive

<input type="checkbox"/> EN 55011	Limits and methods of measurement of radio disturbance characteristics of industrial, scientific and medical (ISM) high frequency equipment	<input type="checkbox"/> EN 61000-3-2* <input checked="" type="checkbox"/> EN 60555-2	Disturbances in supply systems cause by household appliances and similar electrical equipment "Harmonics"
<input type="checkbox"/> EN 55013	Limits and methods of measurement of radio disturbance characteristics of broadcast receivers and associated equipment	<input type="checkbox"/> EN 61000-3-3* <input checked="" type="checkbox"/> EN 60555-3	Disturbances in supply systems cause by household appliances and similar electrical equipment "Voltage fluctuations"
<input type="checkbox"/> EN 55014	Limits and methods of measurement of radio disturbance characteristics of household electrical appliances, portable tools and similar electrical apparatus	<input checked="" type="checkbox"/> EN 50081-1  <input checked="" type="checkbox"/> EN 50082-1	Generic emission standard Part 1: Residual commercial and light industry  Generic immunity standard Part 1: Residual commercial and light industry
<input type="checkbox"/> EN 55015	Limits and methods of measurement of radio disturbance characteristics of fluorescent lamps and luminaries	<input type="checkbox"/> EN 55081-2	Generic emission standard Part 2: Industrial environment
<input type="checkbox"/> EN 55020	Immunity from radio interference of broadcast receivers and associated equipment	<input type="checkbox"/> EN 55082-2	Generic emission standard Part 2: Industrial environment
<input checked="" type="checkbox"/> EN 55022	Limits and methods of measurement of radio disturbance characteristics of information technology equipment	<input type="checkbox"/> ENV 55104	Immunity requirements for household appliances tools and similar apparatus
<input type="checkbox"/> DIN VDE 0855 <input type="checkbox"/> part 10 <input type="checkbox"/> part 12	Cabled distribution systems; Equipment for receiving and/or distribution from sound and television signals	<input type="checkbox"/> EN50091-2	EMC requirements for uninterruptible power systems (UPS)

CE marking



(EC conformity marking)

**The manufacturer also declares the conformity of above mentioned product with the actual required safety standards in accordance with LVD 73/23 EEC**

<input type="checkbox"/> EN 60065	Safety requirements for mains operated electronic and related apparatus for household and similar general use	<input type="checkbox"/> EN 60950
<input type="checkbox"/> EN 60335	Safety of household and similar electrical appliances	<input type="checkbox"/> EN 50091-1

**Manufacturer/Importer**

(Stamp)

Date : May, 26, 2002

Signature:  
Name:

Timmy Huang  
Timmy Huang

# DECLARATION OF CONFORMITY

Per FCC Part 2 Section 2.1077(a)



**Responsible Party Name: G.B.T. INC. (U.S.A.)**

**Address: 17358 Railroad Street  
City of Industry, CA 91748**

**Phone/Fax No: (818) 854-9338/ (818) 854-9339**

hereby declares that the product

**Product Name: Motherboard**

**Model Number: GA-8ILMT4**

Conforms to the following specifications:

FCC Part 15, Subpart B, Section 15.107(a) and Section 15.109  
(a), Class B Digital Device

## **Supplementary Information:**

This device complies with part 15 of the FCC Rules. Operation is subject to the following two conditions: (1) This device may not cause harmful and (2) this device must accept any inference received, including that may cause undesired operation.

Representative Person's Name: ERIC LU

Signature: Eric Lu

Date: May. 26,2002

GA-8ILMT4  
P4 Titan-DDR Motherboard

# USER'S MANUAL

Pentium®4 Processor Motherboard

Rev. 1001

12ME-8ILMT4-1001

# Table of Content

Item Checklist .....	4
WARNING! .....	4
Chapter 1 Introduction .....	5
Features Summary .....	5
GA-8ILMT4 Motherboard Layout .....	7
Chapter 2 Hardware Installation Process .....	8
Step 1: Install the Central Processing Unit (CPU) .....	9
Step1-1 CPU Installation .....	9
Step1-2 CPU Heat Sink Installation .....	10
Step 2: Install memory modules .....	11
Step 3: Connect ribbon cables, cabinet wires, and power supply .....	13
Step3-1 I/O Back Panel Introduction .....	13
Step3-2 Connectors Introduction .....	15
Chapter 3 BIOS Setup .....	22
The Main Menu (For example: BIOS Ver. :F1) .....	23
Standard CMOS Features .....	25
Advanced BIOS Features .....	28
Integrated Peripherals .....	31

Power Management Setup .....	35
PnP/PCI Configurations .....	38
PC Health Status .....	39
Frequency/Voltage Control .....	41
Top Performance .....	43
Load Fail-Safe Defaults .....	44
Load Optimized Defaults .....	45
Set Supervisor/User Password .....	46
Save & Exit Setup .....	47
Exit Without Saving .....	48
Chapter 4 Technical Reference .....	49
Block Diagram .....	49
Q-Flash Introduction .....	50
@ BIOS Introduction .....	52
Easy Tune 4™ Introduction .....	53
Chapter 5 Appendix .....	54

## Item Checklist

- The GA-8ILMT4 motherboard
- IDE cable x 1/ Floppy cable x 1
- CD for motherboard driver & utility (IUCD)
- GA-8ILMT4 user's manual
- I/O Shield



### WARNING!

Computer motherboards and expansion cards contain very delicate Integrated Circuit (IC) chips. To protect them against damage from static electricity, you should follow some precautions whenever you work on your computer.

1. Unplug your computer when working on the inside.
2. Use a grounded wrist strap before handling computer components. If you do not have one, touch both of your hands to a safely grounded object or to a metal object, such as the power supply case.
3. Hold components by the edges and try not touch the IC chips, leads or connectors, or other components.
4. Place components on a grounded antistatic pad or on the bag that came with the components whenever the components are separated from the system.
5. Ensure that the ATX power supply is switched off before you plug in or remove the ATX power connector on the motherboard.

### Installing the motherboard to the chassis...

If the motherboard has mounting holes, but they don't line up with the holes on the base and there are no slots to attach the spacers, do not become alarmed you can still attach the spacers to the mounting holes. Just cut the bottom portion of the spacers (the spacer may be a little hard to cut off, so be careful of your hands). In this way you can still attach the motherboard to the base without worrying about short circuits. Sometimes you may need to use the plastic springs to isolate the screw from the motherboard PCB surface, because the circuit wire may be near by the hole. Be careful, don't let the screw contact any printed circuit write or parts on the PCB that are near the fixing hole, otherwise it may damage the board or cause board malfunctioning.

# Chapter 1 Introduction

## Features Summary

Form Factor	<ul style="list-style-type: none"> <li>• 21.0cm x 24.3cm Micro ATX size form factor, 4 layers PCB.</li> </ul>
CPU	<ul style="list-style-type: none"> <li>• Socket 478 for Intel® Micro FC-PGA2 Pentium® 4 processor</li> <li>• Support Intel® Pentium® 4 (Northwood, 0.13µm) processor</li> <li>• Intel Pentium®4 400MHz FSB</li> <li>• 2nd cache depends on CPU</li> </ul>
Chipset	<ul style="list-style-type: none"> <li>• Chipset 82845GL HOST/AGP/Controller</li> <li>• ICH4 I/O Controller Hub</li> </ul>
Memory	<ul style="list-style-type: none"> <li>• 2 184-pin DDR DIMM sockets</li> <li>• Supports PC1600 DDR or PC2100 DDR SDRAM</li> <li>• Supports up to 2GB DRAM (Max)</li> <li>• Supports only 2.5V DDR SDRAM</li> </ul>
I/O Control	<ul style="list-style-type: none"> <li>• ITE8712</li> </ul>
Slots	<ul style="list-style-type: none"> <li>• 3 PCI slot supports 33MHz &amp; PCI 2.2 compliant</li> </ul>
On-Board IDE	<ul style="list-style-type: none"> <li>• 2 IDE controller on the Intel ICH4 PCI chipset provides IDE HDD/CD-ROM with PIO, Bus Master (Ultra DMA33/ATA66/ATA100) operation modes.</li> <li>• Can connect up to four IDE devices</li> </ul>
On-Board Peripherals	<ul style="list-style-type: none"> <li>• 1 Floppy port supports 2 FDD with 360K, 720K, 1.2M, 1.44M and 2.88M bytes.</li> <li>• 1 Parallel port supports Normal/EPP/ECP mode</li> <li>• 1 Serial ports (COMA), 1 VGA port</li> <li>• 6 x USB 2.0/1.1 (2x Rear, 4 Front by cable)</li> <li>• 1 Front Audio connector</li> </ul>
On-Board VGA	<ul style="list-style-type: none"> <li>• Built in Intel 845GL Chipset</li> </ul>
On-Board Sound	<ul style="list-style-type: none"> <li>• Sigmatel 9721 CODEC</li> <li>• 1 Buzzer</li> <li>• Line In/Line Out/Mic In/CD In/AUX In/Game Port</li> </ul>
On-Board LAN	<ul style="list-style-type: none"> <li>• Built in RTL8100BL Chipset</li> <li>• 1 RJ 45 port</li> </ul>

to be continued.....



---

Hardware Monitor	<ul style="list-style-type: none"><li>• CPU/System Fan Revolution detect</li><li>• CPU/System Fan Control</li><li>• CPU Overheat Warning</li><li>• System Voltage Detect</li></ul>
PS/2 Connector	<ul style="list-style-type: none"><li>• PS/2 Keyboard interface and PS/2 Mouse interace</li></ul>
BIOS	<ul style="list-style-type: none"><li>• Licensed AWARD BIOS, 2M bit FWH</li></ul>
Additional Features	<ul style="list-style-type: none"><li>• External Modem wake up</li><li>• PS/2 Keyboard password power on</li><li>• PS/2 Mouse power on</li><li>• AC Recovery</li><li>• USB KB/Mouse wake up from S3</li><li>• Poly fuse for keyboard,USB,game port over-current protection</li><li>• Supports @BIOS</li><li>• Supports EasyTune4</li></ul>

---



Please set the CPU host frequency in accordance with your processor's specifications. We don't recommend you to set the system bus frequency over the CPU's specification because these specific bus frequencies are not the standard specifications for CPU, chipset and most of the peripherals. Whether your system can run under these specific bus frequencies properly will depend on your hardware configurations, including CPU, Chipsets,SDRAM,Cards....etc.

# GA-8ILMT4 Motherboard Layout

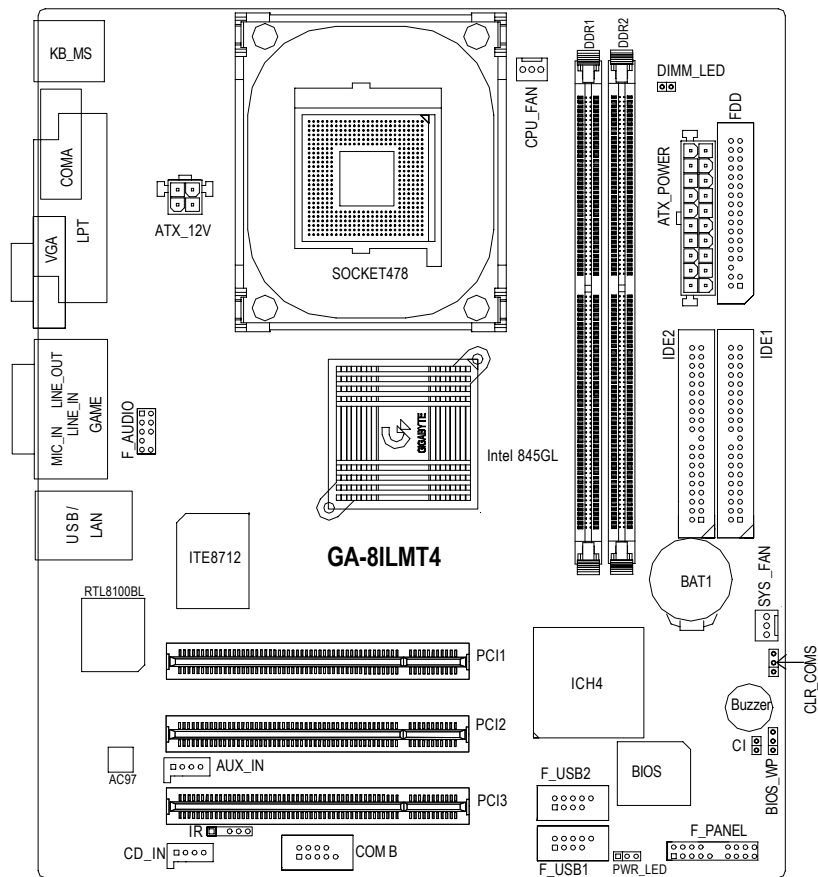

## Chapter 2 Hardware Installation Process

To set up your computer, you must complete the following steps:

- Step 1- Install the Central Processing Unit (CPU)
- Step 2- Install memory modules
- Step 3- Connect ribbon cables, cabinet wires, and power supply
- Step 4- Setup BIOS software
- Step 5- Install supporting software tools

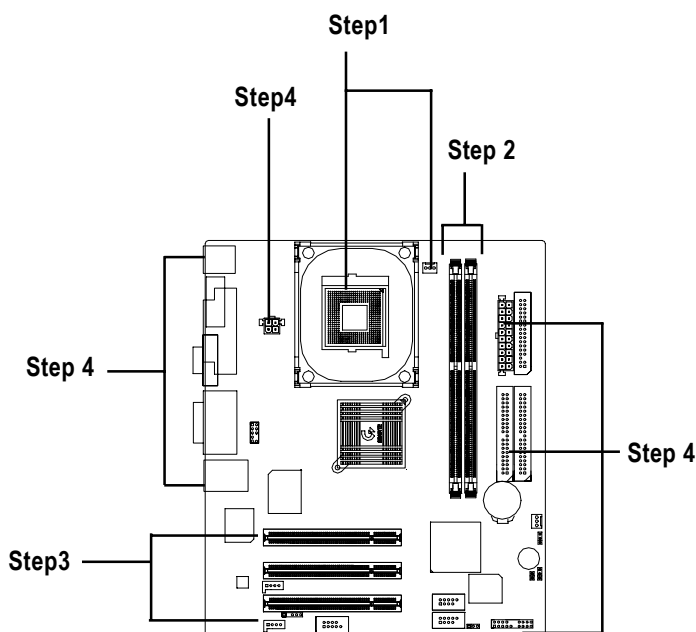

# Step 1: Install the Central Processing Unit (CPU)

## Step 1-1 : CPU Installation



CPU Top View

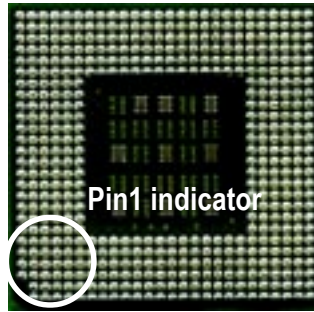

CPU Bottom View

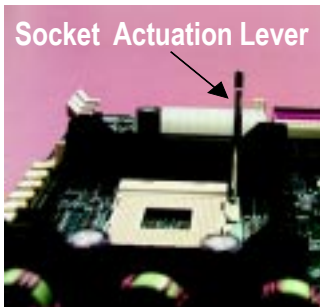

1. Pull up the CPU socket lever and up to 90-degree angle.
3. Press down the CPU socket lever and finish CPU installation.



2. Locate Pin 1 in the socket and look for a (golden) cut edge on the CPU upper corner. Then insert the CPU into the socket.

- ⚠ Please make sure the CPU type is supported by the motherboard.
- ⚠ If you do not match the CPU socket Pin 1 and CPU cut edge well, it will cause improper installation. Please change the insert orientation.

## Step 1-2 : CPU Heat Sink Installation



1. Hook one end of the cooler bracket to the CPU socket first.

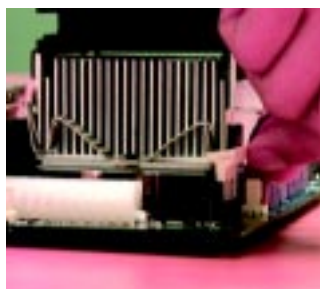

2. Hook the other end of the cooler bracket to the CPU socket.

- \* Please use Intel approved cooling fan.
- \* We recommend you to apply the thermal tape to provide better heat conduction between your CPU and heatsink.  
(The CPU cooling fan might stick to the CPU due to the hardening of the thermal paste. During this condition if you try to remove the cooling fan, you might pull the processor out of the CPU socket along with the cooling fan, and might damage the processor. To avoid this from happening, we suggest you to either use thermal tape instead of thermal paste, or remove the cooling fan with extreme caution.)
- \* Make sure the CPU fan power cable is plugged in to the CPU fan connector, this completes the installation.
- \* Please refer to CPU heat sink user's manual for more detail installation procedure.

## Step 2: Install memory modules

The motherboard has 2 dual inline memory module (DIMM) sockets. The BIOS will automatically detects memory type and size. To install the memory module, just push it vertically into the DIMM Slot .The DIMM module can only fit in one direction due to the notch. Memory size can vary between sockets.

### Total Memory Sizes With Unbuffered DDR DIMM

Devices used on DIMM	1 DIMM x 64 / x 72	2 DIMMs x 64 / x 72
64 Mbit (2Mx8x4 banks)	128 MBytes	256 MBytes
64 Mbit (1Mx16x4 banks)	32 MBytes	64 MBytes
128 Mbit(4Mx8x4 banks)	256 MBytes	512 MBytes
128 Mbit(2Mx16x4 banks)	64 MBytes	128 MBytes
256 Mbit(8Mx8x4 banks)	512 MBytes	1 GBytes
256 Mbit(4Mx16x4 banks)	128 MBytes	256 MBytes
512 Mbit(16Mx8x4 banks)	1 GBytes	2 GBytes
512 Mbit(8Mx16x4 banks)	256 MBytes	512 MBytes

Notes: Double-sided x16 DDR memory devices are not support by Intel 845E/G chipset.



DDR



1. The DIMM slot has a notch, so the DIMM memory module can only fit in one direction.
  2. Insert the DIMM memory module vertically into the DIMM slot. Then push it down.
  3. Close the plastic clip at both edges of the DIMM slots to lock the DIMM module.
- Reverse the installation steps when you wish to remove the DIMM module.

● When STR/DIMM LED is ON, you do not install / remove DDR from socket.

## DDR Introduction

Established on the existing SDRAM industry infrastructure, DDR (Double Data Rate) memory is a high performance and cost-effective solution that allows easy adoption for memory vendors, OEMs and system integrators.

DDR memory is a sensible evolutionary solution for the PC industry that builds on the existing SDRAM infrastructure, yet makes awesome advances in solving the system performance bottleneck by doubling the memory bandwidth. DDR SDRAM will offer a superior solution and migration path from existing SDRAM designs due to its availability, pricing and overall market support. PC2100 DDR memory (DDR266) doubles the data rate through reading and writing at both the rising and falling edge of the clock, achieving data bandwidth 2X greater than PC133 when running with the same DRAM clock frequency. With peak bandwidth of 2.1GB per second, DDR memory enables system OEMs to build high performance and low latency DRAM subsystems that are suitable for servers, workstations, high-end PC's and value desktop SMA systems. With a core voltage of only 2.5 Volts compared to conventional SDRAM's 3.3 volts, DDR memory is a compelling solution for small form factor desktops and notebook applications.

# Step 3: Connect ribbon cables, cabinet wires, and power supply

## Step3-1 : I/O Back Panel Introduction

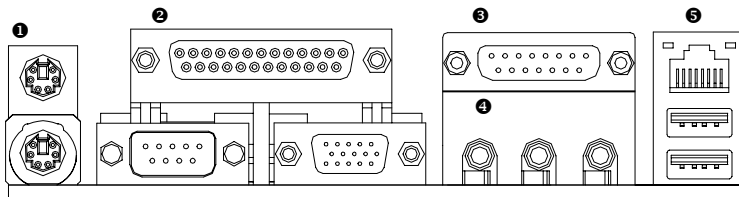

### 1 PS/2 Keyboard and PS/2 Mouse Connector

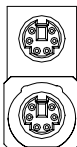

PS/2 Mouse Connector  
(6 pin Female)

PS/2 Keyboard Connector  
(6 pin Female)

➤ This connector supports standard PS/2 keyboard and PS/2 mouse.

### 2 Parallel Port and Serial Ports (COM1/COM2)

Parallel Port  
(25 pin Female)

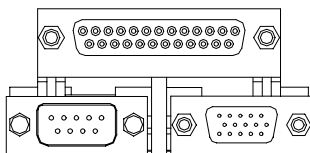

COMA  
Serial Port  
(9 pin Male)

VGA  
VGA Port  
(15 pin Female)

➤ This mainboard supports 1 standard COM port, 1 VGA port and 1 LPT port. Device like printer can be connected to LPT port ; mouse and modem etc can be connected to COM port.



### ③ Game /MIDI Ports

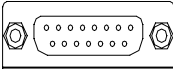

Joystick/ MIDI (15 pin Female)

- This connector supports joystick, MIDI keyboard and other relate audio devices.

### ④ Audio Connectors

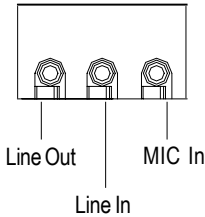

- After install onboard audio driver, you may connect speaker to Line Out jack, micro phone to MIC In jack. Device like CD-ROM , walkman etc can be connected to Line-In jack.

### ⑤ USB/LAN Connector

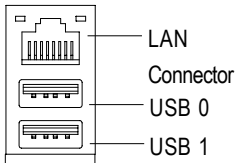

- Before you connect your device(s) into USB connector(s), please make sure your device(s) such as USB keyboard, mouse, scanner, zip, speaker..etc. Have a standard USB interface. Also make sure your OS (Win 95 with USB supplement, Win98, Windows 2000, Windows ME, Win NT with SP 6) supports USB controller. If your OS does not support USB controller, please contact OS vendor for possible patch or driver upgrade. For more information please contact your OS or device(s) vendors.

## Step 3-2 : Connectors Introduction

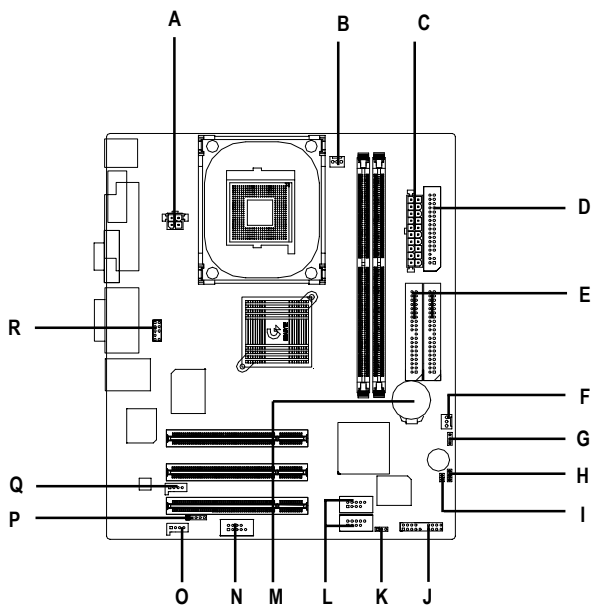

A) ATX_12V	J) F_PANEL
B) CPU_FAN	K) PWR_LED
C) ATX	L) F_USB1/F_USB2
D) FDD	M) BATTERY
E) IDE1/IDE2	N) COMB
F) SYS_FAN	O) CD_IN
G) CLR_CMOS	P) IR
H) BIOS_WP	Q) AUX_IN
I) CI	R) F_AUDIO

**A) ATX\_12V ( +12V Power Connector)**

➤ This connector (ATX +12V) supplies the CPU operation voltage (Vcore). If this " ATX+ 12V connector" is not connected, system cannot boot.

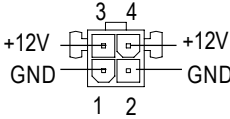

**B) CPU\_FAN (CPU FAN Connector)**

➤ Please note, a proper installation of the CPU cooler is essential to prevent the CPU from running under abnormal condition or damaged by overheating. The CPU fan connector supports Max. current up to 600 mA.



**C) ATX\_POWER (ATX Power)**

➤ AC power cord should only be connected to your power supply unit after ATX power cable and other related devices are firmly connected to the mainboard.

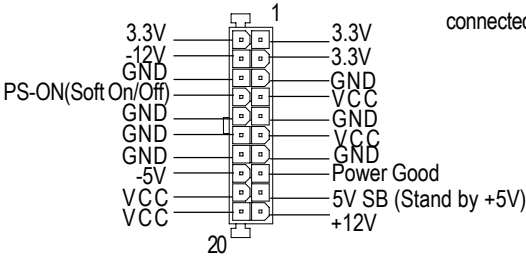

**D) FDD (Floppy Connector)**

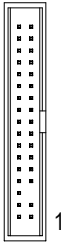

**E) IDE1/ IDE2 (IDE1/IDE2 Connector)**

- Important Notice:  
Please connect first harddisk to IDE1 and connect CDROM to IDE2.

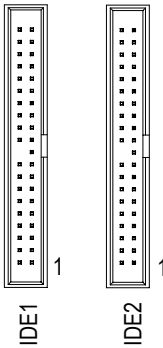

**F) SYS\_FAN (System FAN Connector)**

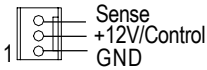

**G) CLR\_CMOS (Clear CMOS)**

- You may clear the CMOS data to its default values by this jumper.

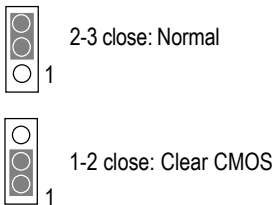

Default doesn't include the "Shunter" to prevent from improper use this jumper. To clear CMOS, temporarily short 1-2 pin.

**H) BIOS\_WP (BIOS Write Protection)**

➤ Please note, To flash/upgrade BIOS on this MB BIOS\_WP must be set to 2-3 close. We recommend BIOS\_WP to be set to "1-2 close", whenever user does not need to flash/upgrade the BIOS.

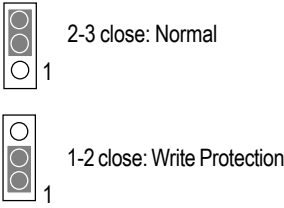

**I) CI (CASE OPEN)**

➤ This 2 pin connector allows your system to enable or disable the system alarm if the system case begin remove.

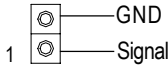

**K) PWR\_LED**

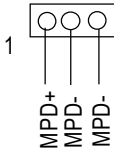

**L) F\_USB1/F\_USB2 (Front USB Connector)**

➤ Be careful with the polarity of the front panel USB connector. Check the pin assignment while you connect the front panel USB cable. Please contact your nearest dealer for optional front panel USB 2.0 cable.

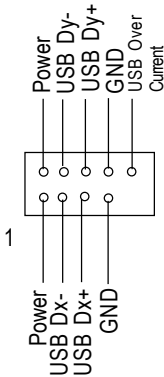

## M) BATTERY (Battery)

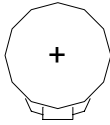

### CAUTION

- ❖ Danger of explosion if battery is incorrectly replaced.
- ❖ Replace only with the same or equivalent type recommended by the manufacturer.
- ❖ Dispose of used batteries according to the manufacturer's instructions.

## N) COM B

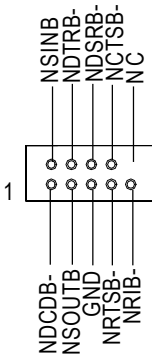

## O) CD\_IN (CD IN)

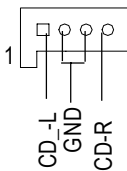

**P)IR**

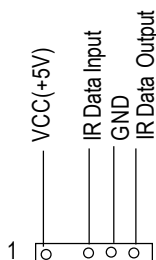

- Be careful with the polarity of the IR connector while you connect the IR. Please contact your nearest dealer for optional IR device.

**Q) AUX\_IN ( AUX In Connector)**

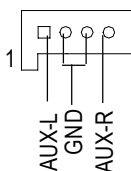

**R)F\_AUDIO (F\_AUDIO Connector)**

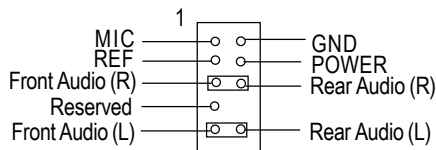

- If you want to use Front Audio connector, you must remove 5-6, 9-10 Jumper. In order to utilize the front audio header, your chassis must have front audio connector. Also please make sure the pin assignment on the cable is the same as the pin assignment on the MB header. To find out if the chassis you are buying support front audio connector, please contact your dealer.

## J) F\_PANEL (2x10 pins connector)

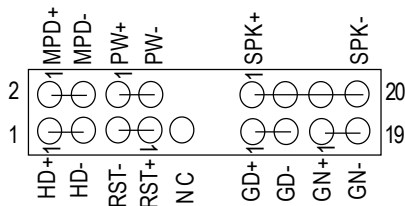

GN (Green Switch)	Open: Normal Operation Close: Entering Green Mode
GD (Green LED)	Pin 1: LED anode(+) Pin 2: LED cathode(-)
HD (IDE Hard Disk Active LED)	Pin 1: LED anode(+) Pin 2: LED cathode(-)
SPK (Speaker Connector)	Pin 1: VCC(+) Pin 2- Pin 3: NC Pin 4: Data(-)
RE (Reset Switch)	Open: Normal Operation Close: Reset Hardware System
PW (Soft Power Connector)	Open: Normal Operation Close: Power On/Off
MPD(Message LED/Power/ Sleep LED)	Pin 1: LED anode(+) Pin 2: LED cathode(-)
NC	NC

- Please connect the power LED, PC speaker, reset switch and power switch etc of your chassis front panel to the F\_PANEL connector according to the pin assignment above.



## Chapter 3 BIOS Setup

BIOS Setup is an overview of the BIOS Setup Program. The program that allows users to modify the basic system configuration. This type of information is stored in battery-backed CMOS RAM so that it retains the Setup information when the power is turned off.

### ENTERING SETUP

Powering ON the computer and pressing <Del> immediately will allow you to enter Setup. If you require more advanced BIOS settings, please go to “Advanced BIOS” setting menu. To enter Advanced BIOS setting menu, press “Ctrl+F1” key on the BIOS screen.

### CONTROL KEYS

<↑>	Move to previous item
<↓>	Move to next item
<←>	Move to the item in the left hand
<→>	Move to the item in the right hand
<Esc>	Main Menu - Quit and not save changes into CMOS Status Page Setup Menu and Option Page Setup Menu - Exit current page and return to Main Menu
<+/PgUp>	Increase the numeric value or make changes
<-/PgDn>	Decrease the numeric value or make changes
<F1>	General help, only for Status Page Setup Menu and Option Page Setup Menu
<F2>	Reserved
<F3>	Reserved
<F4>	Reserved
<F5>	Restore the previous CMOS value from CMOS, only for Option Page Setup Menu
<F6>	Load the file-safe default CMOS value from BIOS default table
<F7>	Load the Optimized Defaults
<F8>	Q-Flash function
<F9>	Reserved
<F10>	Save all the CMOS changes, only for Main Menu

## GETTING HELP

### Main Menu

The on-line description of the highlighted setup function is displayed at the bottom of the screen.

### Status Page Setup Menu / Option Page Setup Menu

Press F1 to pop up a small help window that describes the appropriate keys to use and the possible selections for the highlighted item. To exit the Help Window press <Esc>.

### The Main Menu (For example: BIOS Ver. : F1b)

Once you enter Award BIOS CMOS Setup Utility, the Main Menu (Figure 1) will appear on the screen. The Main Menu allows you to select from eight setup functions and two exit choices. Use arrow keys to select among the items and press <Enter> to accept or enter the sub-menu.

CMOS Setup Utility-Copyright (C) 1984-2002 Award Software

▶Standard CMOS Features	Top Performance
▶Advanced BIOS Features	Load Fail-Safe Defaults
▶Integrated Peripherals	Load Optimized Defaults
▶Power Management Setup	Set Supervisor Password
▶PnP/PCI Configurations	Set User Password
▶PC Health Status	Save & Exit Setup
▶Frequency/Voltage Control	Exit Without Saving
ESC:Quit	↑↓→←:Select Item
F8: Q-Flash	F10:Save & Exit Setup
Time, Date, Hard Disk Type...	

Figure 1: Main Menu

- **Standard CMOS Features**

This setup page includes all the items in standard compatible BIOS.

- **Advanced BIOS Features**

This setup page includes all the items of Award special enhanced features.

- **Integrated Peripherals**  
This setup page includes all onboard peripherals.
- **Power Management Setup**  
This setup page includes all the items of Green function features.
- **PnP/PCI Configurations**  
This setup page includes all the configurations of PCI & PnP ISA resources.
- **PC Health Status**  
This setup page is the System auto detect Temperature, voltage, fan, speed.
- **Frequency/Voltage Control**  
This setup page is control CPU's clock and frequency ratio.
- **Top Performance**  
If you wish to maximize the performance of your system, set "Top Performance" as "Enabled".
- **Load Fail-Safe Defaults**  
Fail-Safe Defaults indicates the value of the system parameters which the system would be in safe configuration.
- **Load Optimized Defaults**  
Optimized Defaults indicates the value of the system parameters which the system would be in best performance configuration.
- **Set Supervisor password**  
Change, set, or disable password. It allows you to limit access to the system and Setup, or just to Setup.
- **Set User password**  
Change, set, or disable password. It allows you to limit access to the system.
- **Save & Exit Setup**  
Save CMOS value settings to CMOS and exit setup.
- **Exit Without Saving**  
Abandon all CMOS value changes and exit setup.

## Standard CMOS Features

CMOS Setup Utility-Copyright (C) 1984-2002 Award Software

### Standard CMOS Features

Date (mm:dd:yy)	Mon, Feb 21 2000	Item Help
Time (hh:mm:ss)	22:31:24	Menu Level ►
►IDE Primary Master	None	Change the day, month, year
►IDE Primary Slave	None	
►IDE Secondary Master	None	<Week>
►IDE Secondary Slave	None	Sun. to Sat.
Drive A	1.44M, 3.5 in.	<Month>
Drive B	None	Jan. to Dec.
Floppy 3 Mode Support	Disabled	
Halt On	All, But Keyboard	<Day>
		1 to 31 (or maximum allowed in the month)
Base Memory	640K	
Extended Memory	130048K	<Year>
Total Memory	131072K	1999 to 2098
↑↓→←: Move    Enter:Select    +/-/PU/PD:Value    F10:Save    ESC:Exit    F1:General Help F5:Previous Values                    F6:Fail-Safe Defaults                    F7:Optimized Defaults		

Figure 2: Standard CMOS Features

### ☞ Date

The date format is <week>, <month>, <day>, <year>.

- Week      The week, from Sun to Sat, determined by the BIOS and is display only
- Month     The month, Jan. Through Dec.
- Day        The day, from 1 to 31 (or the maximum allowed in the month)
- Year        The year, from 1999 through 2098

## ☞ Time

The times format in <hour> <minute> <second>. The time is calculated base on the 24-hour military-time clock. For example, 1 p.m. is 13:00:00.

## ☞ IDE Primary Master, Slave / IDE Secondary Master, Slave

The category identifies the types of hard disk from drive C to F that has been installed in the computer. There are two types: auto type, and manual type. Manual type is user-definable; Auto type which will automatically detect HDD type.

Note that the specifications of your drive must match with the drive table. The hard disk will not work properly if you enter improper information for this category.

If you select User Type, related information will be asked to enter to the following items. Enter the information directly from the keyboard and press <Enter>. Such information should be provided in the documentation form your hard disk vendor or the system manufacturer.

- ▶▶ CYLS.                      Number of cylinders
- ▶▶ HEADS                     Number of heads
- ▶▶ PRECOMP                 Write precomp
- ▶▶ LANDZONE                Landing zone
- ▶▶ SECTORS                  Number of sectors

If a hard disk has not been installed select NONE and press <Enter>.

## ☞ Drive A / Drive B

The category identifies the types of floppy disk drive A or drive B that has been installed in the computer.

- ▶▶ None                      No floppy drive installed
- ▶▶ 360K, 5.25 in.            5.25 inch PC-type standard drive; 360K byte capacity.
- ▶▶ 1.2M, 5.25 in.            5.25 inch AT-type high-density drive; 1.2M byte capacity  
(3.5 inch when 3 Mode is Enabled).
- ▶▶ 720K, 3.5 in.             3.5 inch double-sided drive; 720K byte capacity
- ▶▶ 1.44M, 3.5 in.            3.5 inch double-sided drive; 1.44M byte capacity.
- ▶▶ 2.88M, 3.5 in.            3.5 inch double-sided drive; 2.88M byte capacity.

## ☞ Floppy 3 Mode Support (for Japan Area)

- ▶▶ Disabled Normal Floppy Drive. (Default value)
- ▶▶ Drive A Drive A is 3 mode Floppy Drive.
- ▶▶ Drive B Drive B is 3 mode Floppy Drive.
- ▶▶ Both Drive A & B are 3 mode Floppy Drives.

## ☞ Halt on

The category determines whether the computer will stop if an error is detected during power up.

- ▶▶ NO Errors The system boot will not stop for any error that may be detected and you will be prompted.
- ▶▶ All Errors Whenever the BIOS detects a non-fatal error the system will be stopped.
- ▶▶ All, But Keyboard The system boot will not stop for a keyboard error; it will stop for all other errors. (Default value)
- ▶▶ All, But Diskette The system boot will not stop for a disk error; it will stop for all other errors.
- ▶▶ All, But Disk/Key The system boot will not stop for a keyboard or disk error; it will stop for all other errors.

## ☞ Memory

The category is display-only which is determined by POST (Power On Self Test) of the BIOS.

### Base Memory

The POST of the BIOS will determine the amount of base (or conventional) memory installed in the system.

The value of the base memory is typically 512 K for systems with 512 K memory installed on the motherboard, or 640 K for systems with 640 K or more memory installed on the motherboard.

### Extended Memory

The BIOS determines how much extended memory is present during the POST.

This is the amount of memory located above 1 MB in the CPU's memory address map.

# Advanced BIOS Features

CMOS Setup Utility-Copyright (C) 1984-2002 Award Software

## Advanced BIOS Features

First Boot Device	Floppy	Item Help
Second Boot Device	HDD-0	Menu Level ►
Third Boot Device	CDROM	
Boot Up Floppy Seek	Disabled	
Init Display First	Onboard/AGP	
Graphics Aperture Size	128MB	
Graphics Share Memory	8MB	
↑↓→←: Move    Enter:Select    +/-/PU/PD:Value    F10:Save    ESC:Exit    F1:General Help F5:Previous Values    F6:Fail-Safe Defaults    F7:Optimized Defaults		

Figure 3: Advanced BIOS Features

### ☞ First / Second / Third Boot Device

- ▶▶ Floppy      Select your boot device priority by Floppy.
- ▶▶ LS120      Select your boot device priority by LS120.
- ▶▶ HDD-0~3    Select your boot device priority by HDD-0~3.
- ▶▶ SCSI        Select your boot device priority by SCSI.
- ▶▶ CDROM      Select your boot device priority by CDROM.
- ▶▶ ZIP         Select your boot device priority by ZIP.
- ▶▶ USB-FDD    Select your boot device priority by USB-FDD.
- ▶▶ USB-ZIP    Select your boot device priority by USB-ZIP.
- ▶▶ USB-CDROM Select your boot device priority by USB-CDROM.
- ▶▶ USB-HDD    Select your boot device priority by USB-HDD.
- ▶▶ LAN         Select your boot device priority by LAN.
- ▶▶ Disabled    Select your boot device priority by Disabled.

## ☞ **Boot Up Floppy Seek**

During POST, BIOS will determine the floppy disk drive installed is 40 or 80 tracks. 360 K type is 40 tracks 720 K, 1.2 M and 1.44 M are all 80 tracks.

- ▶▶ Enabled                    BIOS searches for floppy disk drive to determine it is 40 or 80 tracks. Note that BIOS can not tell from 720 K, 1.2 M or 1.44 M drive type as they are all 80tracks.
- ▶▶ Disabled                    BIOS will not search for the type of floppy disk drive by track number. Note that there will not be any warning message if the drive installed is 360 K. (Default value)

## ☞ **Init Display First**

- ▶▶ Onboard/AGP                Set Init Display First to onboard/AGP. (Default value)
- ▶▶ PCI                            Set Init Display First to PCI.

## ☞ **Graphics Aperture Size**

- ▶▶ 128MB                        Set Graphics Aperture Size to 128MB. (Default value)
- ▶▶ Disabled                    Disable this function.

## ☞ **Graphics Share Memory**

- ▶▶ 8MB                            Set Graphics Share Memory to 8MB. (Default value)
- ▶▶ 1MB                            Set Graphics Share Memory to 1MB.



# Integrated Peripherals

CMOS Setup Utility-Copyright (C) 1984-2002 Award Software

## Integrated Peripherals

		Item Help
On-Chip Primary PCI IDE	Enabled	
On-Chip Secondary PCI IDE	Enabled	Menu Level ►
IDE1 Conductor Cable	Auto	If a hard disk
IDE2 Conductor Cable	Auto	controller card is
USB Controller	Enabled	used, set at Disable
USB Keyboard Support	Disabled	
USB Mouse Support	Disabled	[Enabled]
AC97 Audio	Auto	Enable onboard IDE
Onboard LAN	Enabled	PORT
Onboard LAN Boot ROM	Disabled	
Onboard Serial Port 1	3F8/IRQ4	
Onboard Serial Port 2	2F8/IRQ3	
UART Mode Select	Normal	
x UR2 Duplex Mode	Half	[Disabled]
Onboard Parallel Port	378/IRQ7	Disable onboard IDE
Parallel Port Mode	SPP	PORT
Game Port Address	201	
Midi Port Address	330	
Midi Port IRQ	10	
↑↓→←: Move    Enter:Select    +/-/PU/PD:Value    F10:Save    ESC:Exit    F1:General Help F5:Previous Values            F6:Fail-Safe Defaults            F7:Optimized Defaults		

Figure 4: Integrated Peripherals

### ☞ On-Chip Primary PCIIDE

- ▶▶ Enabled      Enable onboard 1st channel IDE port. (Default value)
- ▶▶ Disabled     Disable onboard 1st channel IDE port.

### ☞ On-Chip Secondary PCI IDE

- ▶▶ Enabled      Enable onboard 2nd channel IDE port. (Default value)
- ▶▶ Disabled      Disable onboard 2nd channel IDE port.

### ☞ IDE1 Conductor Cable

- ▶▶ Auto      Will be automatically detected by BIOS. (Default Value)
- ▶▶ ATA66/100      Set IDE1 Conductor Cable to ATA66/100 (Please make sure your IDE device and cable is compatible with ATA66/100).
- ▶▶ ATA33      Set IDE1 Conductor Cable to ATA33 (Please make sure your IDE device and cable is compatible with ATA33).

### ☞ IDE2 Conductor Cable

- ▶▶ Auto      Will be automatically detected by BIOS. (Default Value)
- ▶▶ ATA66/100      Set IDE2 Conductor Cable to ATA66/100 (Please make sure your IDE device and cable is compatible with ATA66/100).
- ▶▶ ATA33      Set IDE2 Conductor Cable to ATA33 (Please make sure your IDE device and cable is compatible with ATA33).

### ☞ USB Controller

- ▶▶ Enabled      Enable USB Controller. (Default value)
- ▶▶ Disabled      Disable USB Controller.

### ☞ USB Keyboard Support

- ▶▶ Enabled      Enable USB Keyboard Support.
- ▶▶ Disabled      Disable USB Keyboard Support. (Default value)

### ☞ USB Mouse Support

- ▶▶ Enabled      Enable USB Mouse Support.
- ▶▶ Disabled      Disable USB Mouse Support. (Default value)

### ☞ AC97 Audio

- ▶▶ Auto Enable onboard AC'97 audio function. (Default Value)
- ▶▶ Disabled Disable this function.

### ☞ OnboardLAN

- ▶▶ Enabled Enabled Onboard LAN function. (Default value)
- ▶▶ Disabled Disabled onboard LAN function.

### ☞ OnboardLAN Boot ROM

- ▶▶ Enabled Enabled Onboard LAN Boot ROM function.
- ▶▶ Disabled Disabled onboard LAN Boot ROM function.(Default value)

### ☞ Onboard Serial Port 1

- ▶▶ Auto BIOS will automatically setup the port 1 address.
- ▶▶ 3F8/IRQ4 Enable onboard Serial port 1 and address is 3F8. (Default value)
- ▶▶ 2F8/IRQ3 Enable onboard Serial port 1 and address is 2F8.
- ▶▶ 3E8/IRQ4 Enable onboard Serial port 1 and address is 3E8.
- ▶▶ 2E8/IRQ3 Enable onboard Serial port 1 and address is 2E8.
- ▶▶ Disabled Disable onboard Serial port 1.

### ☞ Onboard Serial Port 2

- ▶▶ Auto BIOS will automatically setup the port 2 address.
- ▶▶ 3F8/IRQ4 Enable onboard Serial port 2 and address is 3F8.
- ▶▶ 2F8/IRQ3 Enable onboard Serial port 2 and address is 2F8. (Default value)
- ▶▶ 3E8/IRQ4 Enable onboard Serial port 2 and address is 3E8.
- ▶▶ 2E8/IRQ3 Enable onboard Serial port 2 and address is 2E8.
- ▶▶ Disabled Disable onboard Serial port 2.

### ☞ UART Mode Select

(This item allows you to determine which Infra Red(IR) function of Onboard I/O chip)

- ▶▶ ASKIR Set onboard I/O chip UART to ASKIR Mode.
- ▶▶ IrDA Set onboard I/O chip UART to IrDA Mode.
- ▶▶ Normal Set onboard I/O chip UART to Normal Mode. (Default Value)

### ☞ UR2 Duplex Mode

- ▶▶ Half IR Function Duplex Half. (Default Value)
- ▶▶ Full IR Function Duplex Full.

### ☞ Onboard Serial Port 2

- ▶▶ Auto BIOS will automatically setup the port 2 address.
- ▶▶ 3F8/IRQ4 Enable onboard Serial port 2 and address is 3F8.
- ▶▶ 2F8/IRQ3 Enable onboard Serial port 2 and address is 2F8. (Default value)
- ▶▶ 3E8/IRQ4 Enable onboard Serial port 2 and address is 3E8.
- ▶▶ 2E8/IRQ3 Enable onboard Serial port 2 and address is 2E8.
- ▶▶ Disabled Disable onboard Serial port 2.

### ☞ UART Mode Select

(This item allows you to determine which Infra Red(IR) function of Onboard I/O chip)

- ▶▶ ASKIR Set onboard I/O chip UART to ASKIR Mode.
- ▶▶ IrDA Set onboard I/O chip UART to IrDA Mode.
- ▶▶ Normal Set onboard I/O chip UART to Normal Mode. (Default Value)

### ☞ UR2 Duplex Mode

- ▶▶ Half IR Function Duplex Half. (Default Value)
- ▶▶ Full IR Function Duplex Full.

### ☞ Onboard Parallel port

- ▶▶ 378/IRQ7 Enable onboard LPT port and address is 378/IRQ7. (Default Value)
- ▶▶ 278/IRQ5 Enable onboard LPT port and address is 278/IRQ5.
- ▶▶ Disabled Disable onboard LPT port.
- ▶▶ 3BC/IRQ7 Enable onboard LPT port and address is 3BC/IRQ7.

### ☞ Parallel Port Mode

- ▶▶ SPP Using Parallel port as Standard Parallel Port. (Default Value)
- ▶▶ EPP Using Parallel port as Enhanced Parallel Port.
- ▶▶ ECP Using Parallel port as Extended Capabilities Port.
- ▶▶ ECP+EPP Using Parallel port as ECP & EPP mode.

### ☞ ECP Mode Use DMA

- ▶▶ 3 Set ECP Mode Use DMA to 3. (Default Value)
- ▶▶ 1 Set ECP Mode Use DMA to 1.

### ☞ Game Port Address

- ▶▶ 201 Set Game Port Address to 201. (Default Value)
- ▶▶ 209 Set Game Port Address to 209.
- ▶▶ Disabled Disable this function.

### ☞ Midi Port Address

- ▶▶ 300 Set Midi Port Address to 300.
- ▶▶ 330 Set Midi Port Address to 330.(Default Value)
- ▶▶ Disabled Disable this function.

### ☞ Midi Port IRQ

- ▶▶ 5 Set Midi Port IRQ to 5.
- ▶▶ 10 Set Midi Port IRQ to 10. (Default Value)

# Power Management Setup

CMOS Setup Utility-Copyright (C) 1984-2002 Award Software

## Power Management Setup

Item	Value	Item Help
ACPI Suspend Type	S1(POS)	
Power LED in S1 State		
Soft-Off by PWR_BTTN	Instant-Off	Menu Level ►
PME Event Wake Up	Enabled	[S1]
ModemRingOn/WakeOnLan	Enabled	
Resume by Alarm	Disabled	Set suspend type to
x Date (of Month) Alarm	Everyday	Power On Suspend under
x Time (hh:nn:ss) Alarm	0 0 0	ACPI OS
Power On By Mouse	Disabled	
Power On By Keyboard	Disabled	[S3]
x KB Power ON Password	Enter	Set suspend type to
AC Back Function	Soft-Off	Suspend to RAM under
		ACPI OS
↑↓→←: Move    Enter:Select    +/-/PU/PD:Value    F10:Save    ESC:Exit    F1:General Help F5:Previous Values                    F6:Fail-Safe Defaults                    F7:Optimized Defaults		

Figure 5: Power Management Setup

### ☞ ACPI Suspend Type

This option will not be shown or not be available if you are using a CPU with the locked ratio.

- ▶▶ S1(POS)      Set ACPI suspend type to S1. (Default Value)
- ▶▶ S3(STR)      Set ACPI suspend type to S3.

### ☞ Power LED in S1 State

- ▶▶ Blinking      In standby mode(S1), power LED will blink. (Default Value)
- ▶▶ Dual/Off      In standby mode(S1):
  - a. If use single color LED, power LED will turn off.
  - b. If use dual color LED, power LED will turn to another color.

### ☞ **Soft-off by PWR\_BTTN**

- ▶▶ Instant-off      Press power button then Power off instantly. (Default value)
- ▶▶ Delay 4 Sec.    Press power button 4 sec to Power off. Enter suspend if button is pressed less than 4 sec.

### ☞ **PME Event Wake Up**

- ▶▶ Disabled        Disable this function.
- ▶▶ Enabled        Enable PME Event Wake up. (Default Value)

### ☞ **ModemRingOn/WakeOnLAN**

- ▶▶ Disabled        Disable Modem Ring on/wake on Lan function.
- ▶▶ Enabled        Enable Modem Ring on/wake on Lan. (Default Value)

### ☞ **Resume by Alarm**

You can set "Resume by Alarm" item to enabled and key in Data/time to power on system.

- ▶▶ Disabled        Disable this function. (Default Value)
- ▶▶ Enabled        Enable alarm function to POWER ON system.

If RTC Alarm Lead To Power On is Enabled.

Date ( of Month) Alarm :            Everyday, 1~31

Time ( hh: mm: ss) Alarm :        (0~23) : (0~59) : (0~59)

### ☞ **Power On By Mouse**

- ▶▶ Disabled        Disabled this function. (Default value)
- ▶▶ Mouse Click    Double click on PS/2 mouse left button.

### ☞ **Power On By Keyboard**

- ▶▶ Password        Enter from 1 to 5 characters to set the Keyboard Power On Password.
- ▶▶ Disabled        Disabled this function. (Default value)
- ▶▶ Keyboard 98    If your keyboard have "POWER Key" button, you can press the key to power on your system.

## ☞ **KB Power ON Password**

- ▶▶ Enter      Input password (from 1 to 5 characters) and press Enter to set the Key board Power On Password.

## ☞ **AC Back Function**

- ▶▶ Memory      System power on depends on the status before AC lost.
- ▶▶ Soft-Off      Always in Off state when AC back. (Default value)
- ▶▶ Full-On      Always power on the system when AC back.



# PnP/PCI Configurations

CMOS Setup Utility-Copyright (C) 1984-2002 Award Software

## PnP/PCI Configurations

PCI 1 IRQ Assignment	Auto	Item Help
PCI 2 IRQ Assignment	Auto	Menu Level ►
PCI 3 IRQ Assignment	Auto	
↑↓ → ← : Move    Enter:Select    +/-/PU/PD:Value    F10:Save    ESC:Exit    F1:General Help F5:Previous Values    F6:Fail-Safe Defaults    F7:Optimized Defaults		

Figure 6: PnP/PCI Configurations

### ☞ PCI 1 IRQ Assignment

- ▶▶ Auto                      Auto assign IRQ to PCI. (Default value)
- ▶▶ 3,4,5,7,9,10,11,12,14,15    Set IRQ 3,4,5,7,9,10,11,12,14,15 to PCI 1/PCI 5.

### ☞ PCI 2 IRQ Assignment

- ▶▶ Auto                      Auto assign IRQ to PCI 2. (Default value)
- ▶▶ 3,4,5,7,9,10,11,12,14,15    Set IRQ 3,4,5,7,9,10,11,12,14,15 to PCI 2.

### ☞ PCI 3 IRQ Assignment

- ▶▶ Auto                      Auto assign IRQ to PCI 3. (Default value)
- ▶▶ 3,4,5,7,9,10,11,12,14,15    Set IRQ 3,4,5,7,9,10,11,12,14,15 to PCI 3.

## PC Health Status

CMOS Setup Utility-Copyright (C) 1984-2002 Award Software

### PC Health Status

Reset Case Open Status	Disabled	Item Help
Case Opened	No	Menu Level ►
VCORE	1.730V	
+1.5V	1.502V	
+3.3V	3.360V	
+5V	5.053V	
+12V	11.840V	
Current CPU Temperature	35°C/95°F	
Current CPU FAN Speed	6490 RPM	
Current SYSTEM FAN Speed	0 RPM	
CPU Warning Temperature	Disabled	
CPU FAN Fail Warning	Disabled	
SYSTEM FAN Fail Warning	Disabled	
↑↓→←: Move Enter:Select +/-/PU/PD:Value F10:Save ESC:Exit F1:General Help F5:Previous Values F6:Fail-Safe Defaults F7:Optimized Defaults		

Figure 7: PC Health Status

### ☞ Reset Case Open Status

#### ☞ Case Opened

If the case is closed, "Case Opened" will show "No".

If the case have been opened, "Case Opened" will show "Yes".

If you want to reset "Case Opened" value, set "Reset Case Open Status" to "Enabled" and save CMOS, your computer will restart.

Disabled : Don't reset case open status.;Enabled : Clear case open status at next boot.

### ☞ Current Voltage (V) VCORE / 1.5V /+3.3V / +5V / +12V

► Detect system's voltage status automatically.

### ☞ **Current CPU Temperature**

- ▶▶ Detect CPU Temp. automatically.

### ☞ **Current CPU/SYSTEM FAN Speed (RPM)**

- ▶▶ Detect CPU/SYSTEM Fan speed status automatically.

### ☞ **CPU Warning Temperature**

- ▶▶ 60°C / 140°F      Monitor CPU Temp. at 60°C / 140°F.
- ▶▶ 70°C / 158°F      Monitor CPU Temp. at 70°C / 158°F.
- ▶▶ 80°C / 176°F      Monitor CPU Temp. at 80°C / 176°F.
- ▶▶ 90°C / 194°F      Monitor CPU Temp. at 90°C / 194°F.
- ▶▶ Disabled            Disable this function.(Default value)

### ☞ **CPU FAN Fail Warning**

- ▶▶ Disabled            Fan Warning Function Disable. (Default value)
- ▶▶ Enabled             Fan Warning Function Enable.

### ☞ **SYSTEM FAN Fail Warning**

- ▶▶ Disabled            Fan Warning Function Disable. (Default value)
- ▶▶ Enabled             Fan Warning Function Enable.

# Frequency/Voltage Control

CMOS Setup Utility-Copyright (C) 1984-2002 Award Software

## Frequency/Voltage Control

CPU Clock Ratio	15X	Item Help
CPU Host Clock Control	Disabled	Menu Level ►
x CPU Host Frequency (Mhz)	100	
x PCI/AGP Divider	Disabled	
Host/DRAM Clock ratio	Auto	
Memory Frequency (Mhz)	266	
PCI/AGP Frequency (Mhz)	33/66	
↑↓→←: Move    Enter:Select    +/-/PU/PD:Value    F10:Save    ESC:Exit    F1:General Help F5:Previous Values    F6:Fail-Safe Defaults    F7:Optimized Defaults		

Figure 7: Frequency/Voltage Control

### ☞ CPU Clock Ratio

This option will not be shown or not be available if you are using a CPU with the locked ratio.

▶▶ 10X~24X      It's depends on CPU Clock Ratio.

### ☞ CPU Host Clock Control

Note: If system hangs up before enter CMOS setup utility, wait for 20 sec for times out reboot . When time out occur, system will reset and run at CPU default Host clock at next boot.

▶▶ Disable      Disable CPU Host Clock Control.(Default value)

▶▶ Enable      Enable CPU Host Clock Control.

### ☞ CPU Host Frequency

▶▶ 100MHz ~ 355MHz      Set CPU Host Clock from 100MHz to 355MHz.

### ☞ PCI/AGP Divider

▶▶ You can choose Disabled, PLL/40, PLL/32, PLL/24, PLL/20/PLL/16 mode to adjust PCI/AGP frequency.

### ☞ Host/DRAM Clock Ratio

(Warning: wrong frequency may make system can't boot, clear CMOS to overcome wrong frequency issue)

- ▶▶ 2.0            Memory Frequency = Host clock X 2.0.
- ▶▶ 2.66         Memory Frequency = Host clock X 2.66.
- ▶▶ Auto         Set Memory frequency by DRAM SPD data. (Default value)

### ☞ Memory Frequency(Mhz)

▶▶ The values depend on CPU Host Frequency(Mhz) .

### ☞ PCI/AGP Frequency(Mhz)

▶▶ Setup PCI/AGP frequency by adjusting CPU Host Frequency or PCI/AGP Divider item.

## Top Performance

CMOS Setup Utility-Copyright (C) 1984-2002 Award Software

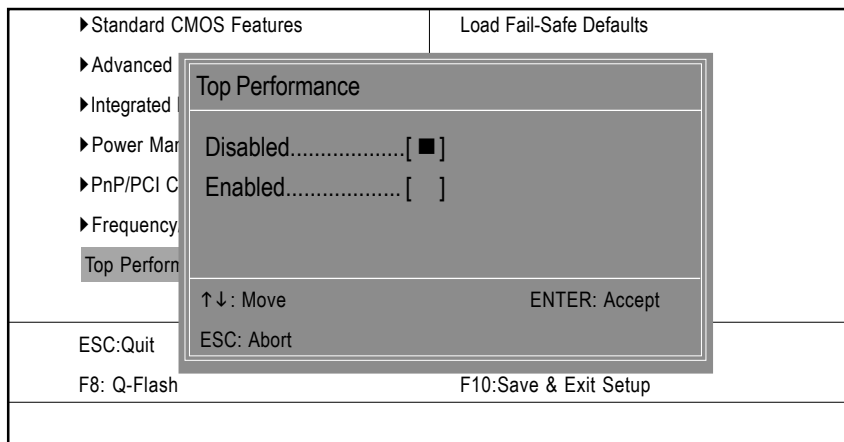

Figure 8: Top Performance

### Top Performance

If you wish to maximize the performance of your system, set "Top Performance" as "Enabled".

- ▶▶ Disabled Disable this function. (Default Value)
- ▶▶ Enabled Enable Top Performance function.

## Load Fail-Safe Defaults

CMOS Setup Utility-Copyright (C) 1984-2002 Award Software

▶Standard CMOS Features	Top Performance
▶Advanced Chipset Features	Load Fail-Safe Defaults
▶Integrated Peripherals	Load Optimized Defaults
▶Power Man	Load Fail-Safe Defaults? (Y/N)?Y
▶PnP/PCI C	
▶PC Health Status	Save & Exit Setup
▶Frequency/Voltage Control	Exit Without Saving
ESC:Quit	↑↓→←:Select Item
F8: Q-Flash	F10:Save & Exit Setup
Load Fail-Safe Defaults	

Figure 10: Load Fail-Safe Defaults

### Load Fail-Safe Defaults

Fail-Safe defaults contain the most appropriate values of the system parameters that allow minimum system performance.

## Load Optimized Defaults

CMOS Setup Utility-Copyright (C) 1984-2002 Award Software

▶Standard CMOS Features	Top Performance
▶Advanced BIOS Features	Load Fail-Safe Defaults
▶Integrated Peripherals	Load Optimized Defaults
▶Power M	
▶PnP/PCI	Load Optimized Defaults? (Y/N)?Y
▶PC Health Status	Save & Exit Setup
▶Frequency/Voltage Control	Exit Without Saving
ESC:Quit	↑↓→←:Select Item
F8: Q-Flash	F10:Save & Exit Setup
Load Optimized Defaults	

Figure 11: Load Optimized Defaults

### Load Optimized Defaults

Selecting this field loads the factory defaults for BIOS and Chipset Features which the system automatically detects.



## Set Supervisor/User Password

CMOS Setup Utility-Copyright (C) 1984-2002 Award Software

▶ Standard CMOS Features	Top Performance
▶ Advanced BIOS Features	Load Fail-Safe Defaults
▶ Integrated Peripherals	Load Optimized Defaults
▶ Power Management Setup	
▶ PnP/PCI Configurations	
▶ PC Health Status	Save & Exit Setup
▶ Frequency/Voltage Control	Exit Without Saving
ESC: Quit	↑ ↓ → ← : Select Item
F8: Q-Flash	F10: Save & Exit Setup
Change/Set/Disable Password	

Figure 12: Password Setting

When you select this function, the following message will appear at the center of the screen to assist you in creating a password.

Type the password, up to eight characters, and press <Enter>. You will be asked to confirm the password. Type the password again and press <Enter>. You may also press <Esc> to abort the selection and not enter a password.

To disable password, just press <Enter> when you are prompted to enter password. A message "PASSWORD DISABLED" will appear to confirm the password being disabled. Once the password is disabled, the system will boot and you can enter Setup freely.

The BIOS Setup program allows you to specify two separate passwords:

SUPERVISOR PASSWORD and a USER PASSWORD. When disabled, anyone may access all BIOS Setup program function. When enabled, the Supervisor password is required for entering the BIOS Setup program and having full configuration fields, the User password is required to access only basic items.

If you select "System" at "Password Check" in Advance BIOS Features Menu, you will be prompted for the password every time the system is rebooted or any time you try to enter Setup Menu.

If you select "Setup" at "Password Check" in Advance BIOS Features Menu, you will be prompted only when you try to enter Setup.

## Save & Exit Setup

CMOS Setup Utility-Copyright (C) 1984-2002 Award Software

▶Standard CMOS Features	Top Performance
▶Advanced BIOS Features	Load Fail-Safe Defaults
▶Integrated Peripherals	Load Optimized Defaults
▶Power Management Setup	Set Supervisor Password
▶PnP/PCI C	
▶PC Health	
▶Frequency/Voltage Control	Exit Without Saving
ESC:Quit	↑↓→←:Select Item
F8: Q-Flash	F10:Save & Exit Setup
Save Data to CMOS	

Figure 13: Save & Exit Setup

Type “Y” will quit the Setup Utility and save the user setup value to RTC CMOS.

Type “N” will return to Setup Utility.

## Exit Without Saving

CMOS Setup Utility-Copyright (C) 1984-2002 Award Software

▶Standard CMOS Features	Top Performance
▶Advanced BIOS Features	Load Fail-Safe Defaults
▶Integrated Peripherals	Load Optimized Defaults
▶Power Management Setup	Set Supervisor Password
▶PnP/PCI Co	
▶PC Health S	
▶Frequency/Voltage Control	Exit Without Saving
ESC:Quit	↑↓→←:Select Item
F8: Q-Flash	F10:Save & Exit Setup
Abandon all Data	

Figure 14: Exit Without Saving

Type "Y" will quit the Setup Utility without saving to RTC CMOS.

Type "N" will return to Setup Utility.

# Chapter 4 Technical Reference

## Block Diagram

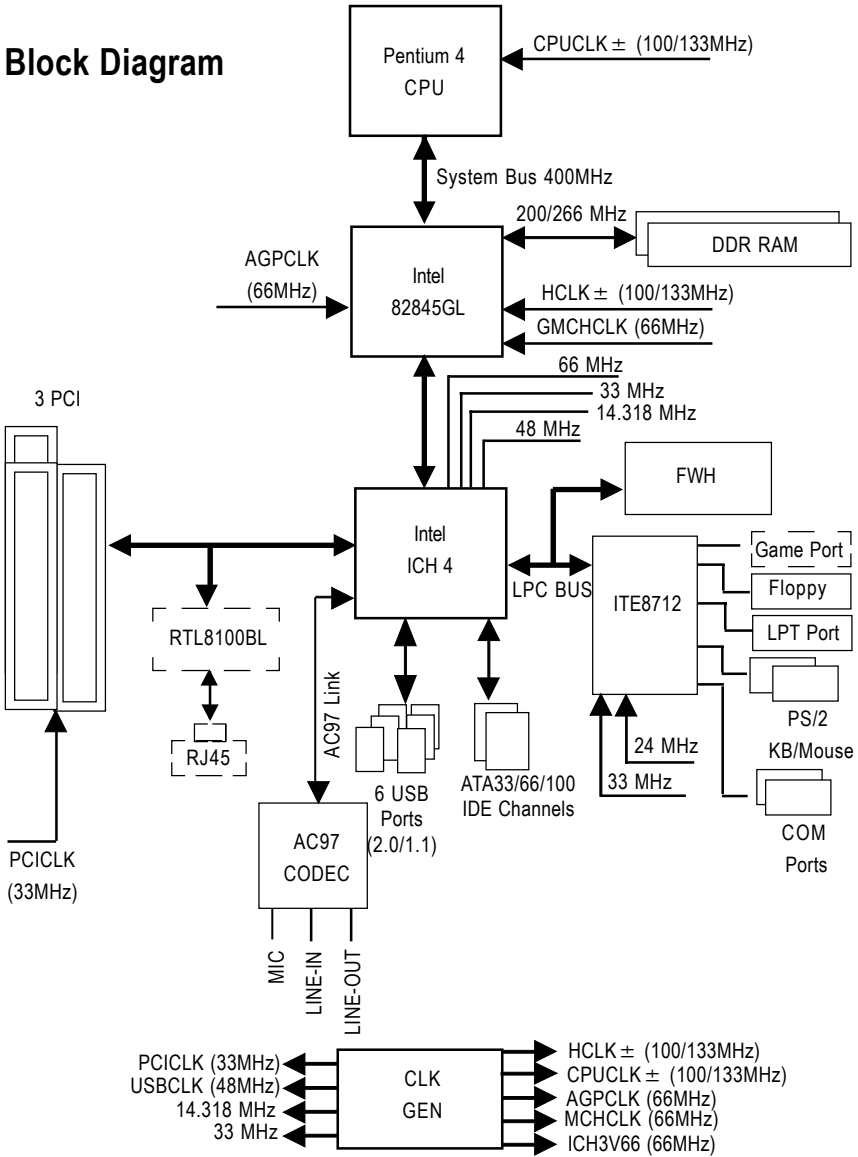

## Q-Flash Introduction

### A. What is Q-Flash Utility?

Q-Flash utility is a pre-O.S. BIOS flash utility enables users to update its BIOS within BIOS mode, no more fooling around any OS.

### B. How to use Q-Flash?

a. After power on the computer, pressing <Del> immediately during POST (Power On Self Test) it will allow you to enter AWARD BIOS CMOS SETUP, then press <F8> to enter Q-Flash utility.

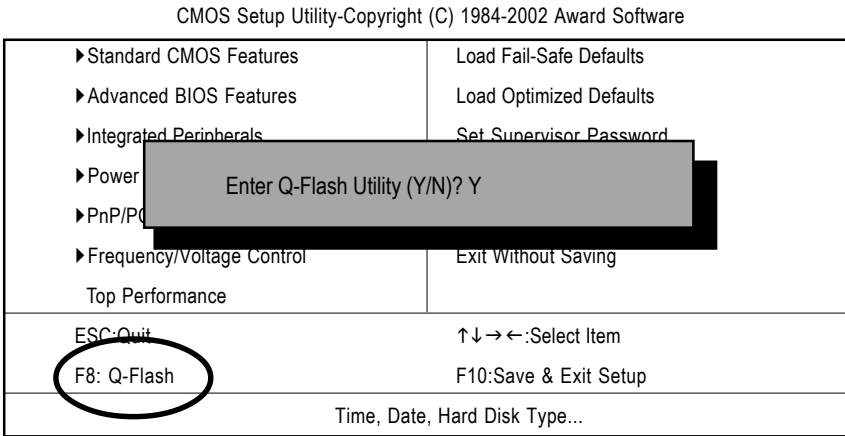

### b. Q-Flash Utility

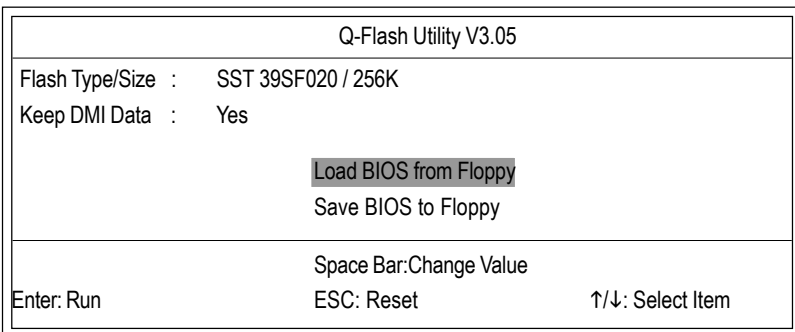

## Load BIOS From Floppy

 In the A:drive, insert the "BIOS" diskette, then Press Enter to Run.

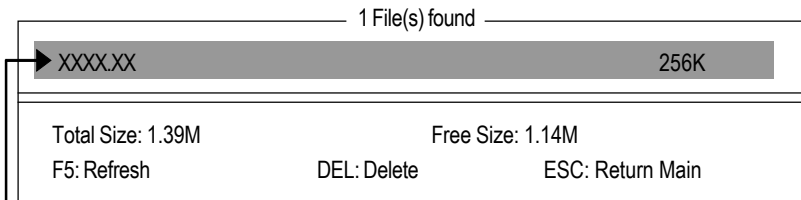

Where XXXX.XX is name of the BIOS file.

 Press Enter to Run.

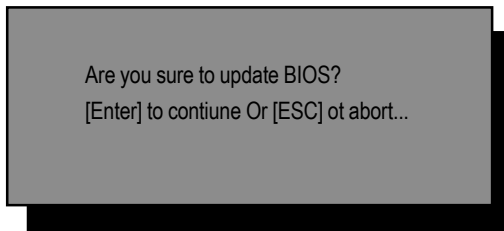

 Press Enter to Run.

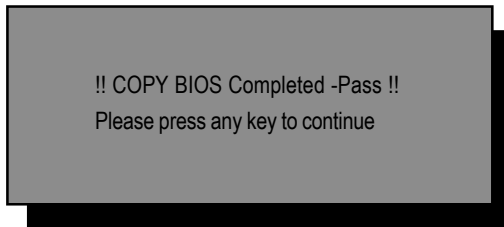

Congratulation! You have completed the flashed and now can restart system.

## @ BIOS Introduction

### Gigabyte announces @ BIOS

### Windows BIOS live update utility



Have you ever updated BIOS by yourself? Or like many other people, you just know what BIOS is, but always hesitate to update it? Because you think updating newest BIOS is unnecessary and actually you don't know how to update it.

Maybe not like others, you are very experienced in BIOS updating and spend quite a lot of time to do it. But of course you don't like to do it too much. First, download different BIOS from website and then switch the operating system to DOS mode. Secondly, use different flash utility to update BIOS. The above process is not a interesting job. Besides, always be carefully to store the BIOS source code correctly in your disks as if you update the wrong BIOS, it will be a nightmare.

Certainly, you wonder why motherboard vendors could not just do something right to save your time and effort and save you from the lousy BIOS updating work? Here it comes! Now Gigabyte announces @BIOS—the first Windows BIOS live update utility. This is a smart BIOS update software. It could help you to download the BIOS from internet and update it. Not like the other BIOS update software, it's a Windows utility. With the help of "@BIOS", BIOS updating is no more than a click.

Besides, no matter which mainboard you are using, if it's a Gigabyte's product\*, @BIOS help you to maintain the BIOS. This utility could detect your correct mainboard model and help you to choose the BIOS accordingly. It then downloads the BIOS from the nearest Gigabyte ftp site automatically. There are several different choices; you could use "Internet Update" to download and update your BIOS directly. Or you may want to keep a backup for your current BIOS, just choose "Save Current BIOS" to save it first. You make a wise choice to use Gigabyte, and @BIOS update your BIOS smartly. You are now worry free from updating wrong BIOS, and capable to maintain and manage your BIOS easily. Again, Gigabyte's innovative product erects a milestone in mainboard industries.

For such a wonderful software, how much it costs? Impossible! It's free! Now, if you buy a Gigabyte's motherboard, you could find this amazing software in the attached driver CD. But please remember, connected to internet at first, then you could have a internet BIOS update from your Gigabyte @BIOS.

## Easy Tune™ 4 Introduction

### Gigabyte announces EasyTune™ 4

#### Windows based Overclocking utility

EasyTune 4 carries on the heritage so as to pave the way for future generations.



"Overclock" might be one of the most common issues in computer field. But have many users ever tried it? The answer is probably "no". Because "Overclock" is thought to be very difficult and includes a lot of technical know-how, sometimes "Overclock" is even considered as special skills found only in some enthusiasts. But as to the experts in "Overclock", what's the truth? They may spend quite a lot of time and money to study, try and use many different hard-

ware or BIOS tools to do "Overclock". And even with these technologies, they still learn that it's quite a risk because the safety and stability of an "Overclock" system is unknown. Now everything is different because of a Windows based overclocking utility "EasyTune 4" --announced by Gigabyte. This windows based utility has totally changed the gaming rule of "Overclock". This is the first windows based overclocking utility is suitable for both normal and power users. Users can choose either "Easy Mode" or "Advanced Mode" for overclocking at their convenience. For users who choose "Easy Mode", they just need to click "Auto Optimize" to have autoed and immediate CPU overclocking. This software will then overdrive CPU speed automatically with the result being shown in the control panel. If users prefer "Overclock" by them, there is also another choice. Click "Advanced Mode" to enjoy "sport drive" class Overclocking user interface. "Advanced Mode", allows users to change the system bus / AGP / Memory working frequency in small increments to get ultimate system performance. It operates in coordination with Gigabyte motherboards. Besides, it is different from other traditional over-clocking methods, EasyTune 4 doesn't require users to change neither BIOS nor hardware switch/ jumper setting; on the other hand, they can do "Overclock" at easy step . Therefore, this is a safer way for "Overclock" as nothing is changed on software or hardware. If user runs EasyTune 4 over system's limitation, the biggest lost is only to restart the computer again and the side effect is then well controlled. Moreover, if one well-performed system speed has been tested in EasyTune 4, user can "Save" this setting and "Load" it in next time. Obviously, Gigabyte EasyTune 4 has already turned the "Overclock" technology toward to a newer generation. This wonderful software is now free bundled in Gigabyte motherboard attached in driver CD. Users may make a test drive of "EasyTune 4" to find out more amazing features by themselves.

\*Some Gigabyte products are not fully supported by EasyTune 4. Please find the products supported list in the web site.

\*Any "Overclocking action" is at user's risk, Gigabyte Technology will not be responsible for any damage or instability to your processor, motherboard, or any other components.



## Chapter 5 Appendix

### Picture below are shown in Windows XP (IUCD driver version 2.0)

Insert the driver CD-title that came with your motherboard into your CD-ROM driver, the driver CD-title will auto start and show the installation guide. If not, please double click the CD-ROM device icon in "My computer", and execute the setup.exe.

#### A. Installing Intel 845GL Chipset Driver

Please install this driver as the first priority. this item installs the chipset driver utility that enables Plug-n-Plug INF support for Intel chipset component.

#### B. Installing Sound Driver

Click this item to install sound driver.

#### C. Installing LAN Driver

Click this item to install LAN driver.



### Appendix A: Intel 845GL Chipset Driver Installation

Follow the setup that showing on the screen to install the Utility.



In order to install the driver successfully, please refer to the following installation procedures.



## A-1. Intel Chipset Software Installation Utility

Insert the driver CD-title that came with your motherboard into your CD-ROM driver, the driver CD-title will auto start and show the installation guide. If not, please double click the CD-ROM device icon in "My computer", and execute the setup.exe.



(1)



(2)

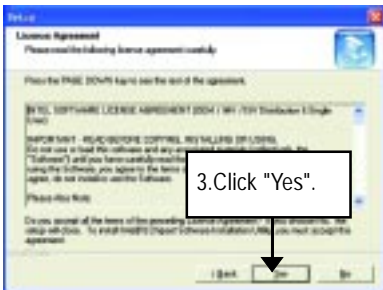

(3)

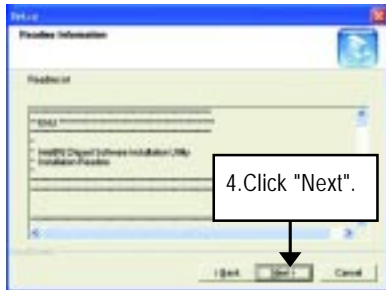

(4)



(5)



(6)

## A-2. Intel Application Accelerator

Insert the driver CD-title that came with your motherboard into your CD-ROM driver, the driver CD-title will auto start and show the installation guide. If not, please double click the CD-ROM device icon in "My computer", and execute the setup.exe.



(1)



(2)



(3)

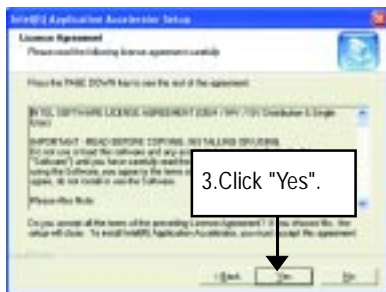

(4)

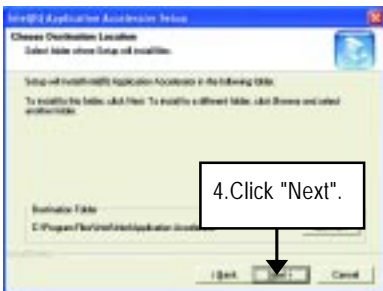

(5)



(6)

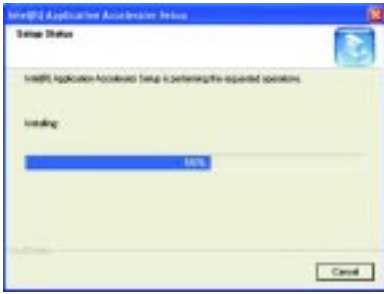

(7)



(8)

### A-3. Intel 845G Chipset VGA Graphics Driver

Insert the driver CD-title that came with your motherboard into your CD-ROM driver, the driver CD-title will auto start and show the installation guide. If not, please double click the CD-ROM device icon in "My computer", and execute the setup.exe.



(1)



(2)

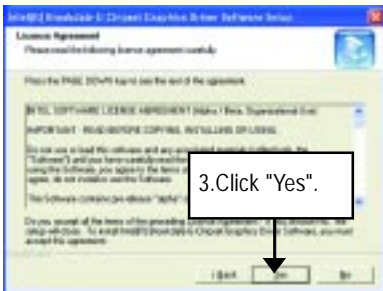

(3)



(4)

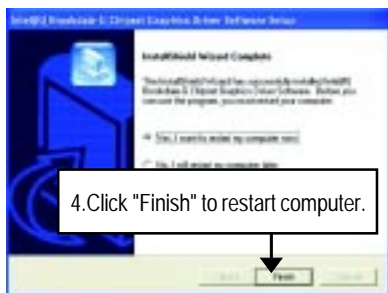

(5)

#### A-4. USB Patch Driver

Insert the driver CD-title that came with your motherboard into your CD-ROM driver, the driver CD-title will auto start and show the installation guide. If not, please double click the CD-ROM device icon in "My computer", and execute the setup.exe.



(1)

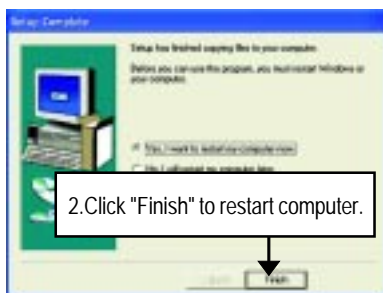
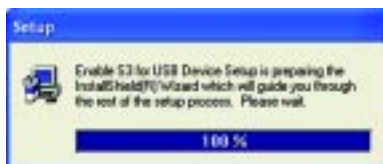

(2)

## Appendix B: Sigmatel AC'97 Audio Driver

Insert the driver CD-title that came with your motherboard into your CD-ROM driver, the driver CD-title will auto start and show the installation guide. If not, please double click the CD-ROM device icon in "My computer", and execute the setup.exe.



(1)



(2)



(3)

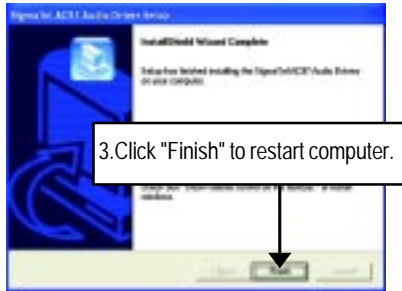

(4)



## Appendix C: RealTek 8139/8130/8100 Network Driver

- For your reference, you can use the following steps to complete the RealTek 8139/8130/8100 Network Driver Installation.



1. Click "RealTek Network Driver" item.

(1)



(2)



(3)

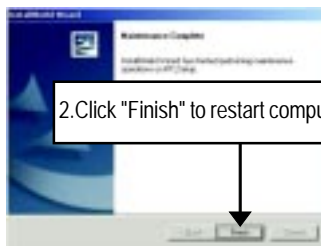

2. Click "Finish" to restart computer.

(4)

## Appendix D: EasyTune 4 Utilities Installation

Insert the driver CD-title that came with your motherboard into your CD-ROM driver, the driver CD-title will auto start and show the installation guide. If not, please double click the CD-ROM device icon in "My computer", and execute the setup.exe.

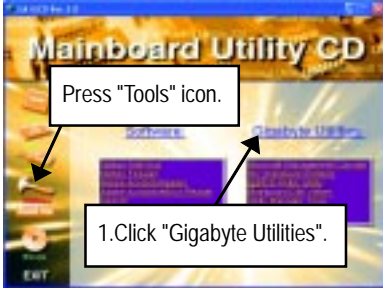

(1)

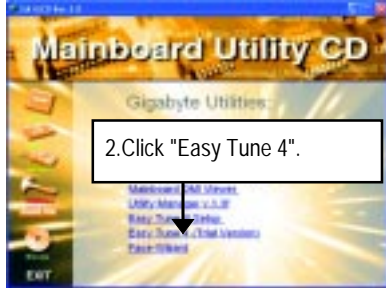

(2)



(3)



(4)



(5)

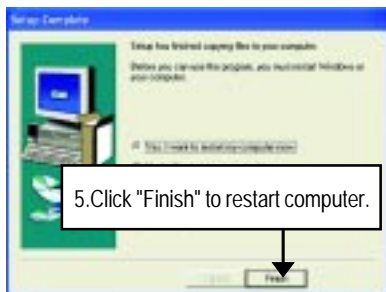

(6)

## Appendix E: BIOS Flash Procedure

BIOS update procedure:

Method 1:

If your OS is Win9X, we recommend that you used Gigabyte @BIOS™ Program to flash BIOS.

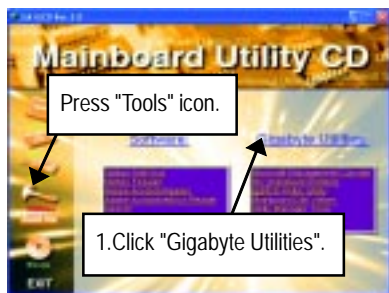

(1)

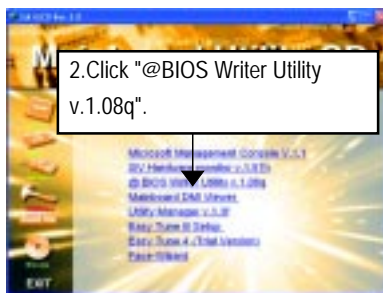

(2)

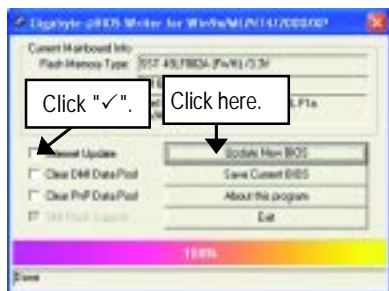

(3)

Methods and steps:

- I. Update BIOS through Internet
  - a. Click "Internet Update" icon
  - b. Click "Update New BIOS" icon
  - c. Select @BIOS™ sever ("Gigabyte @BIOSTM sever 1 in Taiwan" and "Gigabyte @BIOS™ sever 2 in Taiwan" are available for now, the others will be completed soon)
  - d. Select the exact model name on your motherboard
  - e. System will automatically download and update the BIOS.

## II. Update BIOS NOT through Internet:

- a. Do not click "Internet Update" icon
- b. Click "Update New BIOS"
- c. Please select "All Files" in dialog box while opening the old file.
- d. Please search for BIOS unzip file, downloading from internet or any other methods (such as: 8ILMT4.F1).
- e. Complete update process following the instruction.

## III. Save BIOS

In the very beginning, there is "Save Current BIOS" icon shown in dialog box. It means to save the current BIOS version.

## IV. Check out supported motherboard and Flash ROM:

In the very beginning, there is "About this program" icon shown in dialog box. It can help you check out which kind of motherboard and which brand of Flash ROM are supported.

### Note:

- a. In method I, if it shows two or more motherboard's model names to be selected, please make sure your motherboard's model name again. Selecting wrong model name will cause the system unbooted.
- b. In method II, be sure that motherboard's model name in BIOS unzip file are the same as your motherboard's. Otherwise, your system won't boot.
- c. In method I, if the BIOS file you need cannot be found in @BIOS™ server, please go onto Gigabyte's web site for downloading and updating it according to method II.
- d. Please note that any interruption during updating will cause system unbooted

Method 2:

We use GA-7VTX motherboard and Flash841 BIOS flash utility as example.

Please flash the BIOS according to the following procedures if you are now under the DOS mode.

Flash BIOS Procedure:

STEP 1:

- (1) Please make sure your system has installed the extraction utility such as winzip or pkunzip.  
Firstly you have to install the extraction utility such as winzip or pkunzip for the files. Both of these utilities are available on many shareware download pages like <http://www.shareware.cnet.com>

STEP 2: Make a DOS boot diskette. (See example: Windows 98 O.S.)

Beware: Windows ME/2000 are not allowed to make a DOS boot diskette.

- (1) With an available floppy disk in the floppy drive. Please leave the diskette "UN-write protected" type. Double click the "My Computer" icon from Desktop, then click "3.5 diskette (A)" and right click to select "Format (M)"

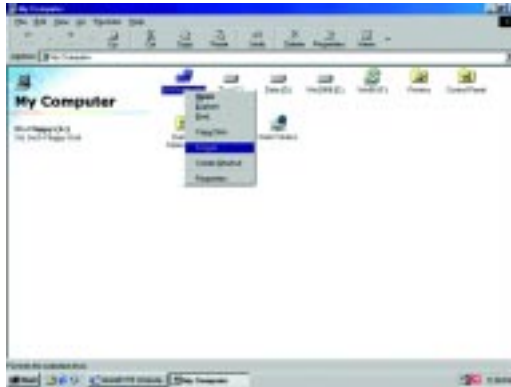

- (2) Select the "Quick (erase)" for Format Type, and pick both "Display summary when finished" and "Copy system files", after that press "Start". That will format the floppy and transfer the needed system files to it.

Beware: This procedure will erase all the prior data on that floppy, so please proceed accordingly.

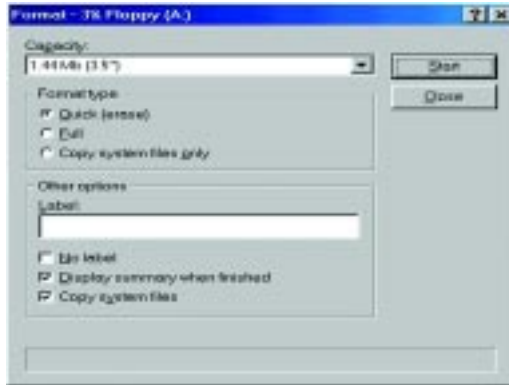

- (3) After the floppy has been formatted completely, please press "Close".



STEP 3: Download BIOS and BIOS utility program.

(1) Please go to Gigabyte website <http://www.gigabyte.com.tw/index.html>, and click "Support".



(2) From Support zone, click the "Motherboards BIOS & Drivers".







- (5) At this time the screen shows the following picture, please click "Extract" button to unzip the files.

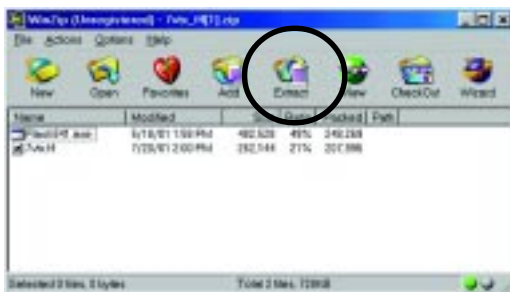

- (6) Please extract the download files into the clean bootable floppy disk A mentioned in STEP 2, and press "Extract".



STEP 4: Make sure the system will boot from the floppy disk.

- (1) Insert the floppy disk (contains bootable program and unzip file) into the floppy drive A. Then, restart the system. The system will boot from the floppy disk. Please press <DEL> key to enter BIOS setup main menu when system is boot up.

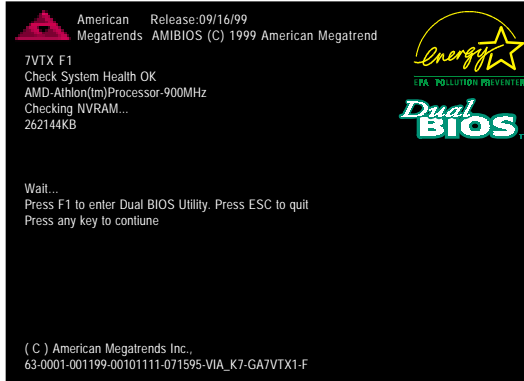

- (2) Once you enter the BIOS setup utility, the main menu will appear on the screen. Use the arrows to highlight the item "BIOS FEATURES SETUP".

AMIBIOS SIMPLE SETUP UTILITY - VERSION 1.24b (C) 1999 American Megatrends, Inc. All Rights Reserved	
STANDARD CMOS SETUP <b>BIOS FEATURES SETUP</b> CHIPSET FEATURES SETUP POWER MANAGEMENT SETUP PNP / PCI CONFIGURATION LOAD BIOS DEFAULTS LOAD SETUP DEFAULTS	INTEGRATED PERIPHERALS HARDWARE MONITOR & MISC SETUP SUPERVISOR PASSWORD USER PASSWORD IDE HDD AUTO DETECTION SAVE & EXIT SETUP EXIT WITHOUT SAVING
ESC: Quit      ↑↓←→ : Select Item      (Shift)F2 : Change Color      F5: Old Values F6: Load BIOS Defaults      F7: Load Setup Defaults      F10: Save & Exit	
Time, Date , Hard Disk Type...	

- (3) Press "Enter" to enter "BIOS FEATURES SETUP" menu. Use the arrows to highlight the item "1st Boot Device", and then use the "Page Up" or "Page Down" keys to select "Floppy".

AMIBIOS SETUP - BIOS FEATURES SETUP	
(C) 2001 American Megatrends, Inc. All Rights Reserved	
1st Boot Device : Floppy	
2nd Boot Device : IDE-0	
3rd Boot Device : CDROM	
S.M.A.R.T. for Hard Disks : Disabled	
BootUp Num-Lock : On	ESC: Quit      ↑↓←→: Select Item
Floppy Drive Seek : Disabled	F1 : Help      PU/PD/+/- : Modify
Password Check : Setup	F5 : Old Values (Shift)F2: Color
	F6 : Load BIOS Defaults
	F7 : Load Setup Defaults

- (4) Press "ESC" to go back to previous screen. Use the arrows to highlight the item "SAVE & EXIT SETUP" then press "Enter". System will ask "SAVE to CMOS and EXIT (Y/N)?" Press "Y" and "Enter" keys to confirm. Now the system will reboot automatically, the new BIOS setting will be taken effect next boot-up.

AMIBIOS SIMPLE SETUP UTILITY - VERSION 1.24b	
(C) 2001 American Megatrends, Inc. All Rights Reserved	
STANDARD CMOS SETUP	INTEGRATED PERIPHERALS
BIOS FEATURES SETUP	HARDWARE MONITOR & MISC SETUP
CHIPSET FEATURES SETUP	SUPERVISOR PASSWORD
POWER MANAGEMENT SETUP	USER PASSWORD
PNP / PCI CONF	SAVE & EXIT SETUP
LOAD BIOS DEFAULTS	EXIT WITHOUT SAVING
LOAD SETUP DEFAULTS	
ESC: Quit      ↑↓←→ : Select Item      (Shift)F2 : Change Color      F5: Old Values	
F6: Load BIOS Defaults      F7: Load Setup Defaults      F10: Save & Exit	
Save Data to CMOS & Exit SETUP	

## STEP 5: BIOS flashing.

- (1) After the system boot from floppy disk, type "A:\> dir/w" and press "Enter" to check the entire files in floppy A. Then type the "BIOS flash utility" and "BIOS file" after A:\>. In this case you have to type "A:\> Flash841 7VTX.F4" and then press "Enter".

```
Starting Windows 98...

Microsoft(R) Windows98
© Copyright Microsoft Corp 1981-1999

A:\> dir/w
Volume in drive A has no label
Volume Serial Number is 16EB-353D
Directory of A:\
COMMAND.COM  7VTX.F4  FLASH841.EXE
              3 file(s)  838,954 bytes
              0 dir(s)  324,608 bytes free

A:\> Flash841 7VTX.F4
```

- (2) Now screen appears the following Flash Utility main menu. Press "Enter", the highlighted item will locate on the model name of the right-upper screen. Right after that, press "Enter" to start BIOS Flash Utility.

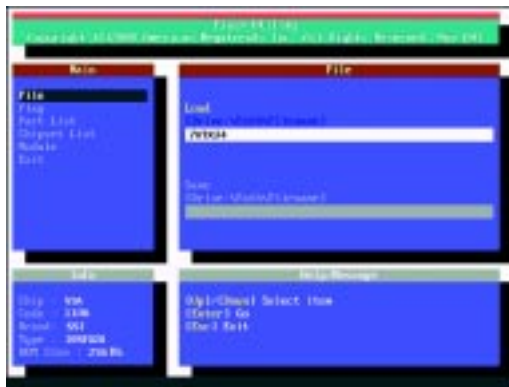

- (3) It will pop up a screen and asks "Are you sure to flash the BIOS?" Press [Enter] to continue the procedure, or press [ESC] to quit.

Beware: Please do not turn off the system while you are upgrading BIOS. It will render your BIOS corrupted and system totally inoperative.

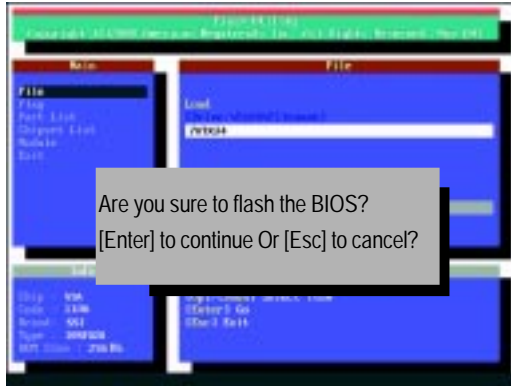

- (4) The BIOS flash completed. Please press [ESC] to exit Flash Utility.

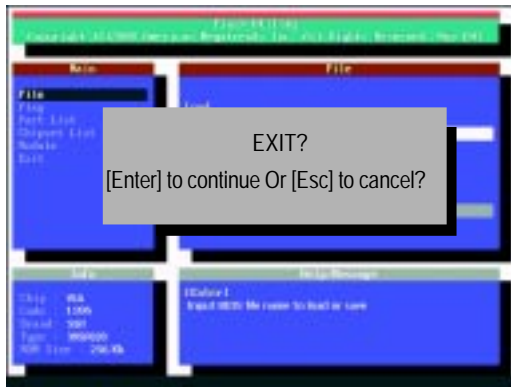

STEP 6: Load BIOS defaults.

Normally the system redetects all devices after BIOS has been upgraded. Therefore, we highly recommend reloading the BIOS defaults after BIOS has been upgraded. This important step resets everything after the flash.

- (1) Take out the floppy diskette from floppy drive, and then restart the system. The boot up screen will indicate your motherboard model and current BIOS version.



- (2) Don't forget to press <DEL> key to enter BIOS setup again when system is boot up. Use the arrows to highlight the item "LOAD SETUP DEFAULTS" then press "Enter". System will ask "Load Setup Defaults (Y/N)?" Press "Y" and "Enter" keys to confirm.

AMIBIOS SIMPLE SETUP UTILITY - VERSION 1.24b (C) 2001 American Megatrends, Inc. All Rights Reserved	
STANDARD CMOS SETUP BIOS FEATURES SETUP CHIPSET FEATURES SETUP POWER MANAGEMENT SETUP PNP / PCI CONFIGURATION	INTEGRATED PERIPHERALS HARDWARE MONITOR & MISC SETUP SUPERVISOR PASSWORD USER PASSWORDS LOAD BIOS DEFAULTS SAVE & EXIT SETUP LOAD SETUP DEFAULTS EXIT WITHOUT SAVING
Load Setup Defaults? (Y/N)?N	
ESC: Quit      ↑↓←→ : Select Item      (Shift)F2 : Change Color      F5: Old Values F6: Load BIOS Defaults      F7: Load Setup Defaults      F10: Save & Exit	
Load Setup Defaults	

- (3) Use the arrows to highlight the item "SAVE & EXIT SETUP" and press "Enter". System will ask "SAVE to CMOS and EXIT (Y/N)?" Press "Y" and "Enter" keys to confirm. Now the system will reboot automatically, the new BIOS setting will be taken effect next boot-up.

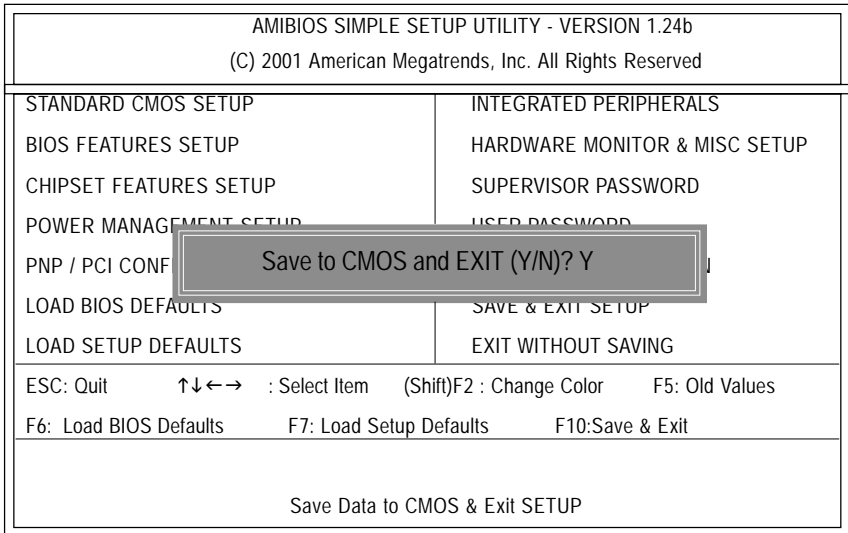

- (4) Congratulate you have accomplished the BIOS flash procedure.

## Appendix E: Acronyms

Acronyms	Meaning
ACPI	Advanced Configuration and Power Interface
APM	Advanced Power Management
AGP	Accelerated Graphics Port
AMR	Audio Modem Riser
ACR	Advanced Communications Riser
BIOS	Basic Input / Output System
CPU	Central Processing Unit
CMOS	Complementary Metal Oxide Semiconductor
CRIMM	Continuity RIMM
CNR	Communication and Networking Riser
DMA	Direct Memory Access
DMI	Desktop Management Interface
DIMM	Dual Inline Memory Module
DRM	Dual Retention Mechanism
DRAM	Dynamic Random Access Memory
DDR	Double Data Rate
ECP	Extended Capabilities Port
ESCD	Extended System Configuration Data
ECC	Error Checking and Correcting
EMC	Electromagnetic Compatibility
EPP	Enhanced Parallel Port
ESD	Electrostatic Discharge
FDD	Floppy Disk Device
FSB	Front Side Bus
HDD	Hard Disk Device
IDE	Integrated Dual Channel Enhanced
IRQ	Interrupt Request
I/O	Input / Output
IOAPIC	Input Output Advanced Programmable Input Controller
ISA	Industry Standard Architecture
LAN	Local Area Network

to be continued.....



Acronyms	Meaning
LBA	Logical Block Addressing
LED	Light Emitting Diode
MHz	Megahertz
MIDI	Musical Interface Digital Interface
MTH	Memory Translator Hub
MPT	Memory Protocol Translator
NIC	Network Interface Card
OS	Operating System
OEM	Original Equipment Manufacturer
PAC	PCI A.G.P. Controller
POST	Power-On Self Test
PCI	Peripheral Component Interconnect
RIMM	Rambus in-line Memory Module
SCI	Special Circumstance Instructions
SECC	Single Edge Contact Cartridge
SRAM	Static Random Access Memory
SMP	Symmetric Multi-Processing
SMI	System Management Interrupt
USB	Universal Serial Bus
VID	Voltage ID

✂ Technical Support/RMA Sheet

Customer/Country:	Company:	Phone No.:
Contact Person:	E-mail Add. :	

Model name/Lot Number:	PCB revision:
BIOS version:	O.S./A.S.:

Hardware Configuration	Mfs.	Model name	Size:	Driver/Utility:
CPU				
Memory Brand				
Video Card				
Audio Card				
HDD				
CD-ROM / DVD-ROM				
Modem				
Network				
AMR / CNR				
Keyboard				
Mouse				
Power supply				
Other Device				

Problem Description:

---



---

