

FCC Compliance Statement:

<p style="text-align: center;">DECLARATION OF CONFORMITY <small>Per FCC Part 2 Section 2.1077(a)</small></p> <p style="text-align: center;">FC</p> <p>Responsible Party Name: G.B.T. INC. Address: 18305 Valley Blvd., Suite 6A LA Puente, CA 91744 Phone/Fax No: (818) 854-9338 / (818) 854-9339</p> <p>hereby declares that the product Product Name: Mother Board Model Number: GA-6VTX</p> <p>Conforms to the following specifications: FCC Part 15, Subpart B, Section 15.107(a) and Section 15.109(a), Class B Digital Device</p> <p>Supplementary Information: This device complies with part 15 of the FCC Rules. Operation is subject to the following two conditions: (1) This device may not cause harmful interference and (2) this device must accept any interference received, including that may cause undesired operation.</p> <p>Representative Person's Name: ERIC LU Signature: EricLu Date: Jul. 23, 2001</p>
--

This equipment has been tested and found to comply with limits for a Class B digital device, pursuant to Part 15 of the FCC rules. These limits are designed to provide reasonable protection against harmful interference in residential installations. This equipment generates, uses, and can radiate radio frequency energy, and if not installed and used in accordance with the instructions, may cause harmful interference to radio communications. However, there is no guarantee that interference will not occur in a particular installation. If this equipment does cause interference to radio or television equipment reception, which can be

determined by turning the equipment off and on, the user is encouraged to try to correct the interference by one or more of the following measures:

- Reorient or relocate the receiving antenna
- Move the equipment away from the receiver
- Plug the equipment into an outlet on a circuit different from that to which the receiver is connected
- Consult the dealer or an experienced radio/television technician for additional suggestions

You are cautioned that any change or modifications to the equipment not expressly approve by the party responsible for compliance could void Your authority to operate such equipment.

This device complies with Part 15 of the FCC Rules. Operation is subjected to the following two conditions 1) this device may not cause harmful interference and 2) this device must accept any interference received, including interference that may cause undesired operation.

Declaration of Conformity

We, Manufacturer/Importer
(full address)

G.B.T. Technology Trading GmbH
Ausschlagler Weg 41, 1F, 20537 Hamburg, Germany

declare that the product
(description of the apparatus, system, installation to which it refers)

Mother Board
GA-6VTX

is in conformity with
(reference to the specification under which conformity is declared)
in accordance with 89/336 EEC-EMC Directive

- | | | | |
|---|--|--|--|
| <input type="checkbox"/> EN 55011 | Limits and methods of measurement of radio disturbance characteristics of industrial, scientific and medical (ISM high frequency equipment | <input type="checkbox"/> EN 61000-3-2*
<input checked="" type="checkbox"/> EN60555-2 | Disturbances in supply systems caused by household appliances and similar electrical equipment "Harmonics" |
| <input type="checkbox"/> EN55013 | Limits and methods of measurement of radio disturbance characteristics of broadcast receivers and associated equipment | <input type="checkbox"/> EN61000-3-3*
<input checked="" type="checkbox"/> EN60555-3 | Disturbances in supply systems caused by household appliances and similar electrical equipment "Voltage fluctuations" |
| <input type="checkbox"/> EN 55014 | Limits and methods of measurement of radio disturbance characteristics of household electrical appliances, portable tools and similar electrical apparatus | <input checked="" type="checkbox"/> EN 50081-1
<input checked="" type="checkbox"/> EN 50082-1 | Generic emission standard Part 1: Residual, commercial and light industry
Generic immunity standard Part 1: Residual, commercial and light industry |
| <input type="checkbox"/> EN 55015 | Limits and methods of measurement of radio disturbance characteristics of fluorescent lamps and luminaries | <input type="checkbox"/> EN 55081-2 | Generic emission standard Part 2: Industrial environment |
| <input type="checkbox"/> EN 55020 | Immunity from radio interference of broadcast receivers and associated equipment | <input type="checkbox"/> EN 55082-2 | Generic immunity standard Part 2: Industrial environment |
| <input checked="" type="checkbox"/> EN 55022 | Limits and methods of measurement of radio disturbance characteristics of information technology equipment | <input type="checkbox"/> ENV 55104 | Immunity requirements for household appliances tools and similar apparatus |
| <input type="checkbox"/> DIN VDE 0855
<input type="checkbox"/> part 10
<input type="checkbox"/> part 12 | Cabled distribution systems; Equipment for receiving and/or distribution from sound and television signals | <input type="checkbox"/> EN 50091- 2 | EMC requirements for uninterruptible power systems (UPS) |
| <input checked="" type="checkbox"/> CE marking | |  | (EC conformity marking) |

The manufacturer also declares the conformity of above mentioned product with the actual required safety standards in accordance with LVD 73/23 EEC

- | | | | |
|-----------------------------------|---|-------------------------------------|---|
| <input type="checkbox"/> EN 60065 | Safety requirements for mains operated electronic and related apparatus for household and similar general use | <input type="checkbox"/> EN 60950 | Safety for information technology equipment including electrical business equipment |
| <input type="checkbox"/> EN 60335 | Safety of household and similar electrical appliances | <input type="checkbox"/> EN 50091-1 | General and Safety requirements for uninterruptible power systems (UPS) |

Manufacturer/Importer

Signature : Rex Lin
Name : Rex Lin

(Stamp)

Date: Jul. 23, 2001

6VTX
Socket 370 Processor Motherboard

USER'S MANUAL

Socket 370 Processor Motherboard
REV. 1.2 Second Edition
12ME-6VTX-1202

How This Manual Is Organized

This manual is divided into the following sections:

1) Revision History	Manual revision information
2) Item Checklist	Product item list
3) Features	Product information & specification
4) Installation Guide	Instructions on CPU & Memory Installation
5) Performance & Block Diagram	Product performance & block diagram
6) Suspend to RAM	Instructions STR installation
7) Four Speaker & SPDIF	Four Speaker & SPDIF introduction
8) Instant BIOS Flash Utility	Instant BIOS Flash utility introduction
9) @BIOS™ & EasyTuneIII™	@BIOS™ & EasyTuneIII™ introduction
10) BIOS Setup	Instructions on setting up the BIOS software
11) Technical Support/RMA Sheet	Document equipment used for after sales service
12) Appendix	General reference

Table Of Content

Revision History	P.1
Item Checklist	P.2
Feature Summary	P.3
6VTX Motherboard Layout	P.5
Installation Guide	P.6
Page Index for Connectors / Panel and Jumper Definition	P.12
Performance List	P.30
Block Diagram	P.32
Suspend to RAM Installation	P.33
Four Speaker & SPDIF Introduction (Optional)	P.38
Instant BIOS Flash Utility Introduction	P.44
@BIOS™ Introduction	P.46
EasyTuneIII™ Introduction	P.47
Page Index for BIOS Setup	P.49
Technical Support / RMA Sheet	P.78
Appendix	P.79

Revision History

Revision	Revision Note	Date
1.1	Initial release of the 6VTX motherboard user's manual.	Jul. 2001
1.2	Initial release of the 6VTX motherboard user's manual.	Jul. 2001
1.2	Second release of the 6VTX motherboard user's manual.	Oct. 2001

The author assumes no responsibility for any errors or omissions that may appear in this document nor does the author make a commitment to update the information contained herein. Third-party brands and names are the property of their respective owners.

Oct. 15, 2001 Taipei, Taiwan, R.O.C

Item Checklist

- The 6VTX motherboard
- Cable for IDE / floppy device
- Diskettes or CD (TUCD) for motherboard driver & utility
- 6VTX user's manual

Features Summary

Form Factor	<ul style="list-style-type: none"> 30.5 cm x20.4 cm ATX SIZE form factor, 4 layers PCB.
CPU	<ul style="list-style-type: none"> Socket 370 processor Supports all new PentiumIII processors (FC-PGA & FC-PGA2 package) Supports Celeron processors in FC-PGA package Supports 66/100/133MHz system bus frequency Can't Support processor with Vcore above 1.8V L2 cache in CPU (Depend on CPU)
Chipset	<ul style="list-style-type: none"> VT82C694T (VIA Apollo Pro 133T) VT82C686B
Clock Generator	<ul style="list-style-type: none"> ICS94241AF 66/100/133 MHz system bus speeds
Memory	<ul style="list-style-type: none"> 3 168-pin DIMM sockets Supports PC-100 / PC-133 SDRAM and VCM SDRAM Supports up to 1.5GB Supports only 3.3V SDRAM DIMM
I/O Control	<ul style="list-style-type: none"> VT82C686B
Slots	<ul style="list-style-type: none"> 1 AGP Slot Supports 4X/2X mode & AGP 2.0 compliant 5 PCI Slots Supports 33MHz & PCI 2.2 compliant 1 ISA slot 1 AMR (Audio Modem Riser) slot (Only Secondary)
On-Board IDE	<ul style="list-style-type: none"> Supports PIO mode 3, 4, DMA33/ATA66/ATA100 IDE & ATAPI CD-ROM 2 IDE bus master (UDMA 33/ATA 66/ATA100) IDE portsfor up to 4 ATAPI devices
On-Board Peripherals	<ul style="list-style-type: none"> 1 floppy port supports 2 FDD with 360K, 720K, 1.2M, 1.44M and 2.88M bytes 1 parallel port supports Normal/EPP/ECP mode 2 serial ports (COM A & COM B) 4 USB ports 1 IrDA connector for IR
Hardware Monitor	<ul style="list-style-type: none"> CPU/System fan revolution detect CPU/System temperature detect System voltage detect CPU overheat shutdown detect

To be continued...

On-Board Sound	<ul style="list-style-type: none">• Creative CT5880 sound (Optional)• AC'97 CODEC• Line In/Line Out/Mic In/AUX In (Optional)/CD In/TEL (Optional)/Game Port/ SPDIF (Optional) /Four Speaker (Optional)
BIOS	<ul style="list-style-type: none">• Licensed AMI BIOS, 2M bit flash ROM
PS/2 Connector	<ul style="list-style-type: none">• PS/2 keyboard interface and PS/2 mouse interface
Additional Features	<ul style="list-style-type: none">• Supports Wake-on-LAN (WOL)• STR (Suspend-To-RAM)• Supports Internal / External modem wake up• Includes 3 fan power connectors (Power Fan is optional)• Poly fuse for keyboard/USB/Mouse over-current protection• Support @BIOS™ and EasyTuneIII™

6VTX Motherboard Layout

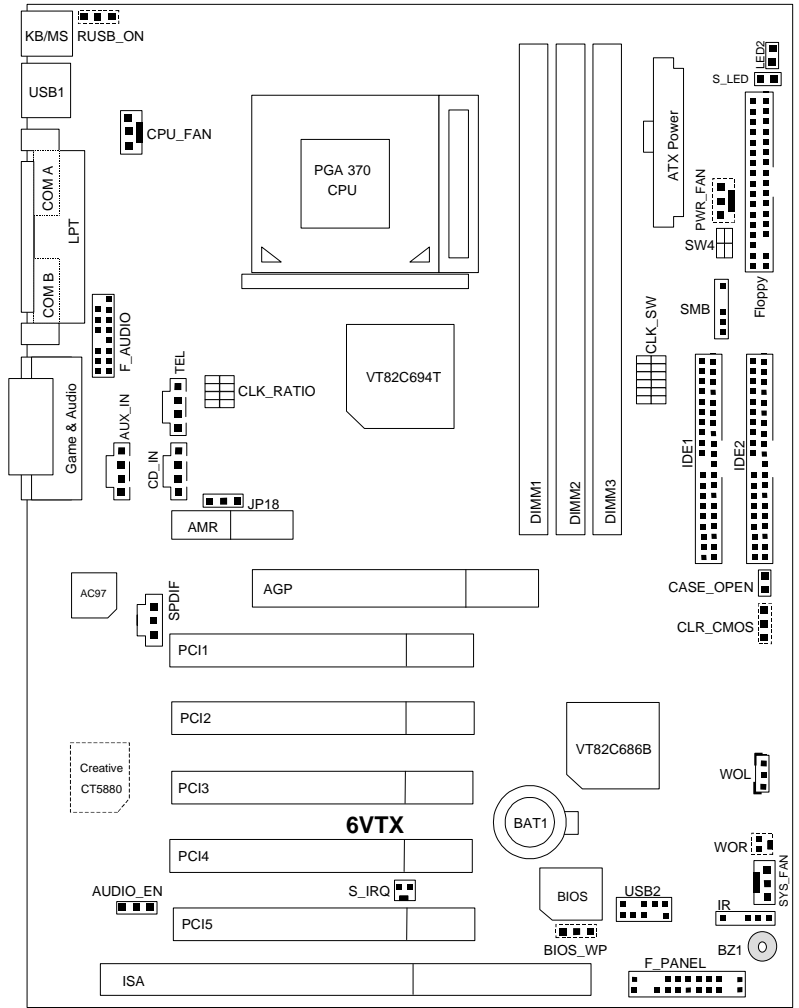

Installation Guide

Getting Started

**WARNING!**

Computer motherboards and expansion cards contain very delicate Integrated Circuit (IC) chips. To protect them against damage from static electricity, you should follow some precautions whenever you work on your computer.

1. Unplug your computer when working on the inside.
2. Use a grounded wrist strap before handling computer components. If you do not have one, touch both of your hands to a safely grounded object or to a metal object, such as the power supply case.
3. Hold components by the edges and try not touch the IC chips, leads or connectors, or other components.
4. Place components on a grounded antistatic pad or on the bag that came with the components whenever the components are separated from the system.
5. Ensure that the ATX power supply is switched off before you plug in or remove the ATX power connector on the motherboard.

Installing the motherboard to the chassis...

If the motherboard has mounting holes, but they don't line up with the holes on the base and there are no slots to attach the spacers, do not become alarmed you can still attach the spacers to the mounting holes. Just cut the bottom portion of the spacers (the spacer may be a little hard to cut off, so be careful of your hands). In this way you can still attach the motherboard to the base without worrying about short circuits. Sometimes you may need to use the plastic springs to isolate the screw from the motherboard PCB surface, because the circuit wire may be near by the hole. Be careful, don't let the screw contact any printed circuit write or parts on the PCB that are near the fixing hole, otherwise it may damage the board or cause board malfunctioning.

6VTX Motherboard

To set up your computer, you must complete the following steps:

- ▶ Step 1 - Set system jumpers
- ▶ Step 2- Install the Central Processing Unit (CPU)
- ▶ Step 3-Install memory modules
- ▶ Step 4-Install expansion cards
- ▶ Step 5-Connect ribbon cables, cabinet wires, and power supply
- ▶ Step 6-Set up BIOS software
- ▶ Step 7-Install supporting software tools

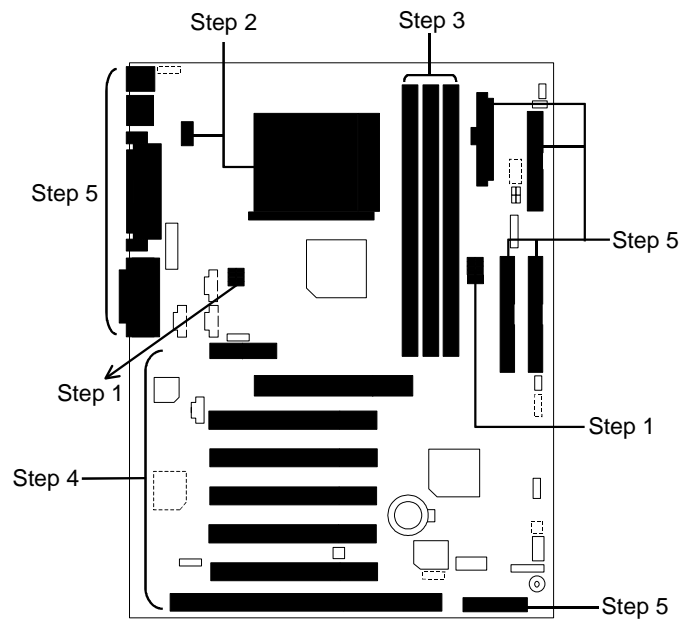

CPU Speed Setup

The system bus speed is selectable at 66,100,133MHz and Auto. The user can select the system bus speed by DIP switch **CLK_SW** & **CLK_RATIO**.

CLK_SW:

O : ON, X : OFF

CPU	1	2	3	4	5	6
AUTO	X	X	O	O	O	O
66	O	O	O	O	X	X
100	O	X	O	O	X	X
133	X	X	O	O	X	X
*137	X	X	X	O	X	X
*142	X	X	X	X	X	X

(* These speed settings are not guaranteed)

CLK_RATIO:

O : ON, X : OFF

FREQ. RATIO	DIP SWITCH			
	1	2	3	4
X3	O	X	O	O
X3.5	X	X	O	O
X4	O	O	X	O
X4.5	X	O	X	O
X5	O	X	X	O
X5.5	X	X	X	O
X6	O	O	O	X
X6.5	X	O	O	X
X7	O	X	O	X
X7.5	X	X	O	X
X8	O	O	X	X
X8.5	O	X	O	O
X9	X	X	O	O
X9.5	X	O	O	O
X10	X	O	X	X
X10.5	O	O	X	O
X11	O	X	X	X

6VTX Motherboard

X11.5	X	O	X	O
X12	O	X	X	O
X13	X	X	X	O
X14	O	O	O	X
X15	X	O	O	X
X16	O	X	O	X

CPU Installation

Please make sure the CPU type and speed is supported by your motherboard.

For example: The newest Pentium III processor (FC-PGA2 package).



CPU Top View

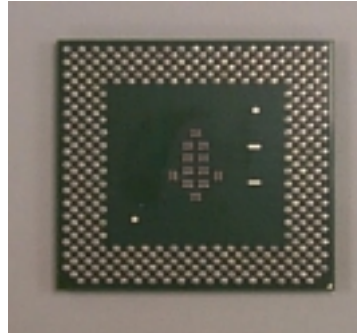

CPU Bottom View

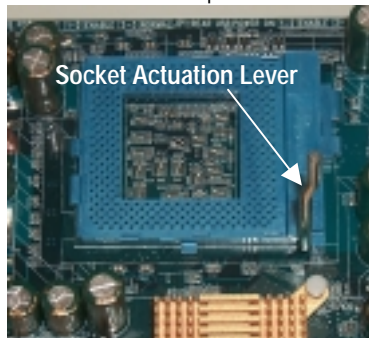

1. Pull the lever out and lift it up.

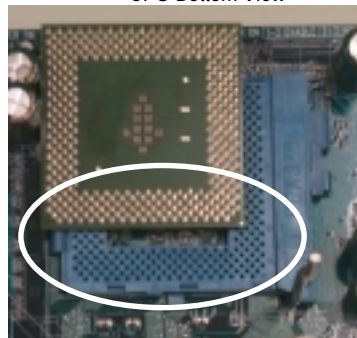

2. The notched corner should point toward the end of the lever. The CPU will only fit in the orientation as shown.

 **CPU Heat Sink Installation:**

Beware: Please check that the heat sink is in good contact with the CPU before you turn on your system. **Poor contact will cause over heat with might cause damage to your processor!**



3. Align CPU and insert it

(Please refer to your heatsink installation manual for application of thermal grease to provide better heat conduction between your CPU and heatsink.)



4. Use compliant fan approved by Intel.



5. Hook one end of the cooler bracket to the CPU socket.

6. Hook the other end of the cooler bracket to the CPU socket.

7. Make sure the CPU fan is plugged to the CPU fan connector, than install complete.

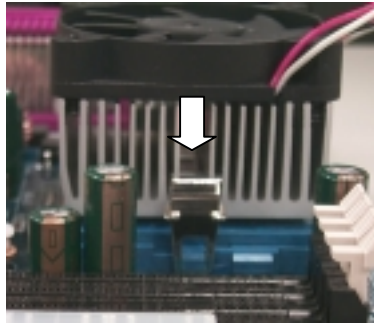

 (Please refer to the cooler's installation manual for detailed installation steps)

Memory Installation

The motherboard has 3 dual inline memory module (DIMM) sockets support 6 banks. The BIOS will automatically detects memory type and size. To install the memory module, just push it vertically into the DIMM Slot .The DIMM module can only fit in one direction due to the two notch. Memory size can vary between sockets.

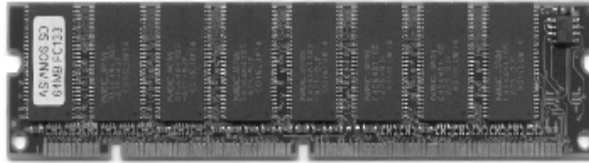

SDRAM

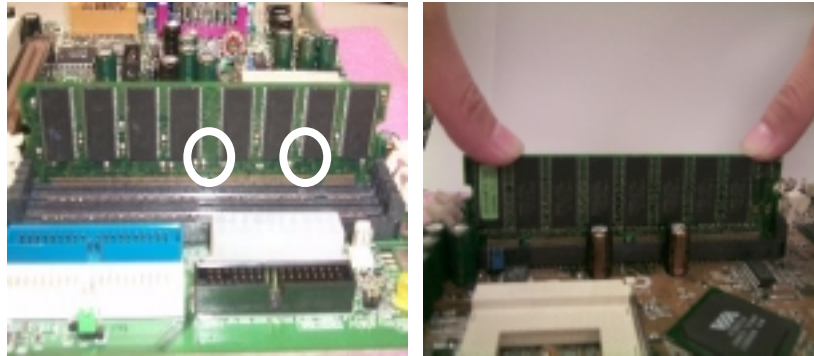

1. The DIMM slot has two notch, so the DIMM memory module can only fit in one direction.
 2. Insert the DIMM memory module vertically into the DIMM slot. Then push it down.
 3. Close the plastic clip at both edges of the DIMM slots to lock the DIMM module.
-  Reverse the installation steps when you wish to remove the DIMM module.

Page Index for Connectors/Panel and Jumper Definition	Page
Connectors	P.13
ATX Power	P.13
AUX_IN (AUX_IN) [Optional]	P.19
CPU_FAN (CPU Fan)	P.17
CD_IN (CD Audio Line In)	P.19
COM A / COM B / LPT Port	P.13
Floppy Port	P.15
F_AUDIO (Front Audio)	P.16
Game & Audio Port	P.17
IDE 1(Primary)/ IDE 2(Secondary) Port	P.16
IR (IR Header)	P.22
KB/MS (PS/2 Keyboard & PS/2 Mouse Connector)	P.14
PWR_FAN (Power Fan) [Optional]	P.18
SMB (External SMBUS Device Connector) [Optional]	P.20
S_LED/LED2 (STR LED Connector & DIMM LED)	P.22
S_IRQ (Serial IRQ) [Optional]	P.23
SPDIF (Optional)	P.24
SW4 (V_DIMM OVER Voltage)	P.23
SYS_FAN (System Fan)	P.18
TEL (Optional)	P.20
USB1 (Rear USB Connector)	P.14
USB2 (Front USB Port)	P.15
WOL (Wake on LAN)	P.21
WOR (Ring Power On) [Optional]	P.21
Panel and Jumper Definition	P.25
AUDIO_EN (Onboard Sound Function Selection) [Optional]	P.28
BAT1 (Battery)	P.29
BIOS_WP (BIOS Write Protection) [Optional]	P.27
CLR_CMOS (Clear CMOS Function) [Optional]	P.26
CASE_OPEN (Case Open) [Optional]	P.27
F_PANEL (2x11 Pins Jumper)	P.25
JP18 (AMR Selection) [Optional]	P.28
RUSB_ON (Front/Rear USB Device Wake up Selection)	P.26

Connectors

ATX Power

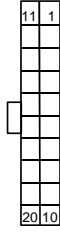
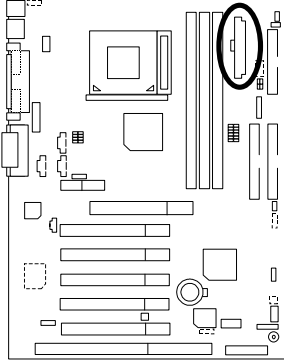

Pin No.	Definition
3,5,7,13,15-17	GND
1,2,11	3.3V
4,6,19,20	VCC
10	+12V
12	-12V
18	-5V
8	Power Good
9	5V SB (stand by+5V)
14	PS-ON(Soft On/Off)



Please note:

AC power cord should only be connected to your power supply unit after ATX power cable and other related devices are firmly connected to the mainboard.

COM A / COM B / LPT Port

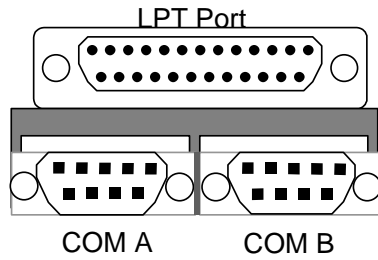
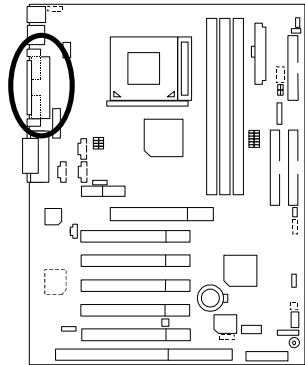

Please note:

This mainboard supports 2 standard COM ports and 1 LPT port. Device like printer can be connected to LPT port, mouse and modem etc can be connected to COM ports.

KB/MS: PS/2 Keyboard & PS/2 Mouse Connector

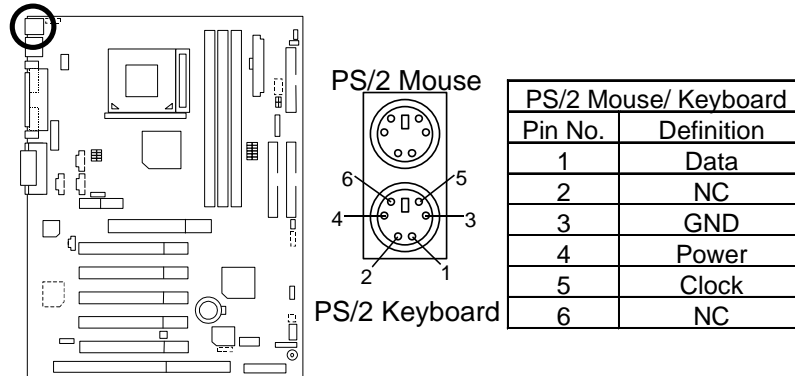
**Please note:**

This mainboard supports standard PS/2 keyboard and PS/2 mouse interface connector.

USB1: Rear USB Connector

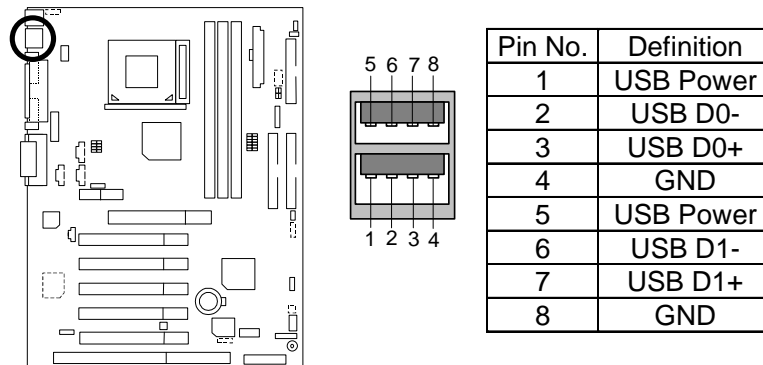
**Please note:**

Before you connect your device(s) into USB connector(s), please make sure your device(s) has a standard USB interface like, USB keyboard, mouse, scanner, zip, buzzer... Also make sure your OS supports USB controller (Win 95 w/ USB supperment, Win98, Windows 2000, Windows ME, Win NT w/ SP 6). If your OS does not support USB controller, please contact OS vendor for passible patch or driver upgrade. For more information please contact your OS or device(s) vendors.

USB2: Front USB Port

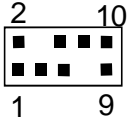
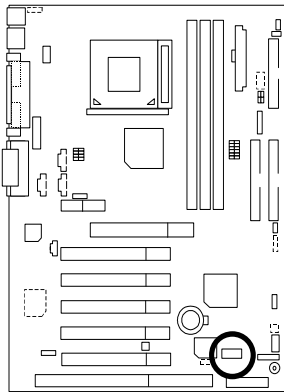

Pin No.	Definition
1	POWER
2	GND
3	USB D2-
4	NC
5	USB D2+
6	USB D3+
7	NC
8	USB D3-
9	GND
10	POWER



Please note:

Be careful with the polarity of the front panel USB connector. Check the pin assignment while you connect the front panel USB cable. Please contact your nearest dealer for optional front panel USB cable.

Floppy Port

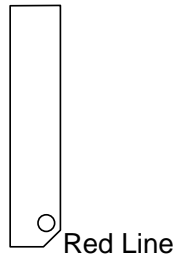
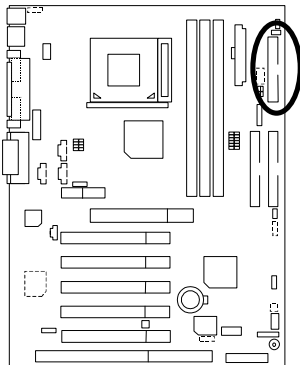

IDE1 (Primary), IDE2 (Secondary) Port

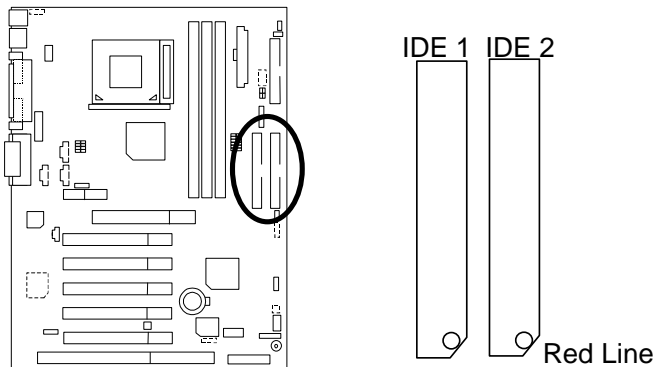

F_AUDIO: Front Audio

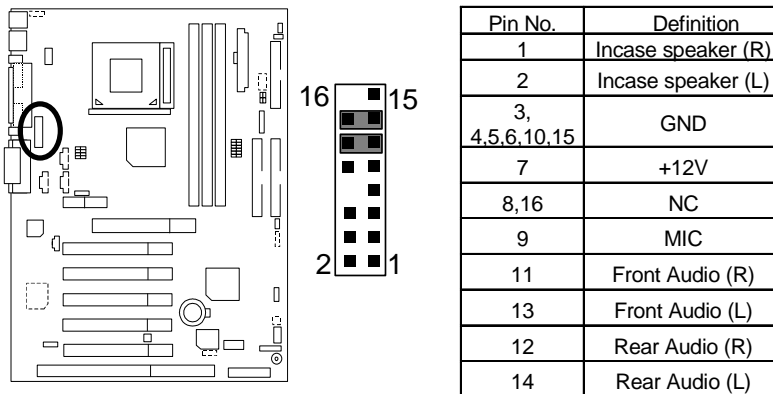

Please note : If you want to use "Front Audio" connector, you must move 11-12,13-14 Jumper.

In order to utilize the front audio header, your chassis must have front audio connector. Also please make sure the pin assignment on the cable is the same as the pin assignment on the MB header. To find out if the chassis you are buying support front audio connector, please contact your dealer.

Game & Audio Port

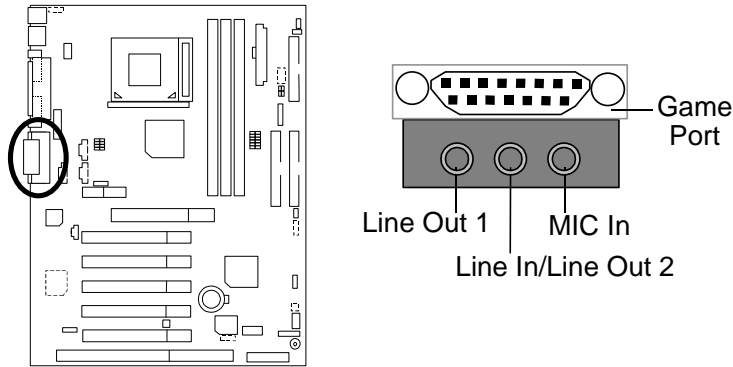

Please note: Line Out 1: Line Out or SPDIF (The SPDIF output is capable of providing digital audio to external speakers or compressed AC3 data to an external Dolby digital decoder). To enable SPDIF, simply insert SPDIF connector into Line Out1. Line Out1 will become SPDIF Out automatically. (see page 41 for more information).
 To enable Four Speaker (for Creative 5880 audio only), simply follow instructions on page 38 and Line In will become Line Out2 to support second pair of stereo speakers.

CPU_FAN: CPU Fan

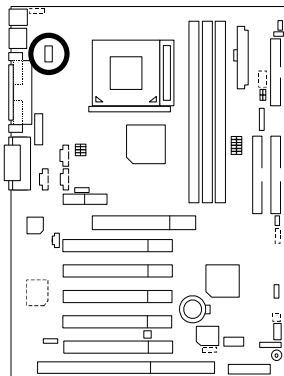

Pin No.	Definition
1	GND
2	+12V
3	SENSE



Please note: A proper installation of the CPU cooler is essential to prevent the CPU from running under abnormal condition or damaged by overheating.

PWR_FAN: Power Fan (Optional)

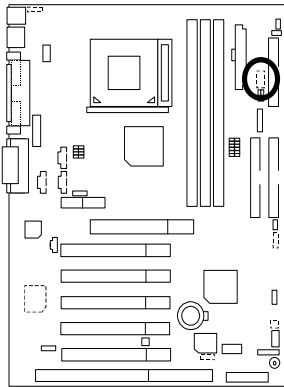

Pin No.	Definition
1	GND
2	+12V
3	SENSE

SYS_FAN: System Fan

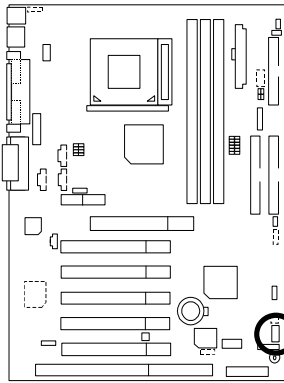

Pin No.	Definition
1	GND
2	+12V
3	SENSE

CD_IN: CD Audio Line In

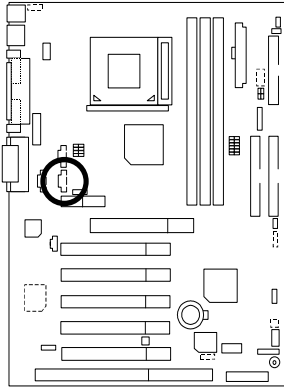

Pin No.	Definition
1	CD-L
2	GND
3	GND
4	CD-R

AUX_IN: AUX_IN (Optional)

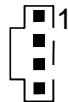
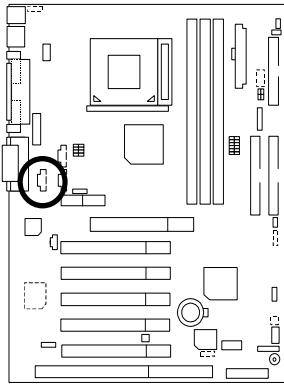

Pin No.	Definition
1	AUX-L
2	GND
3	GND
4	AUX-R

TEL: The connector is for Modem with internal voice connector
(Optional)

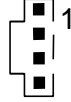
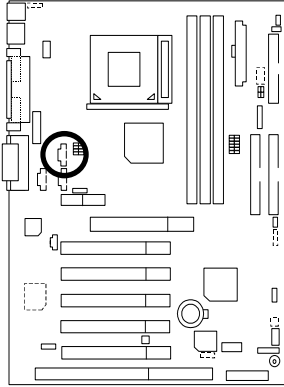

Pin No.	Definition
1	Signal-In
2	GND
3	GND
4	Signal-Out

SMB: External SMBUS Device Connector (Optional)

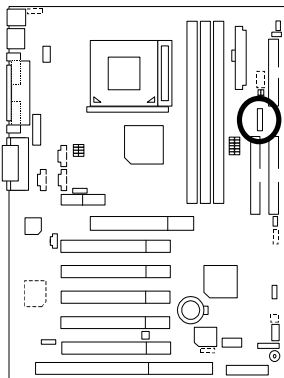

Pin No.	Definition
1	SMB CLK
2	NC
3	GND
4	SMB DATA
5	+5V

WOL: Wake On LAN

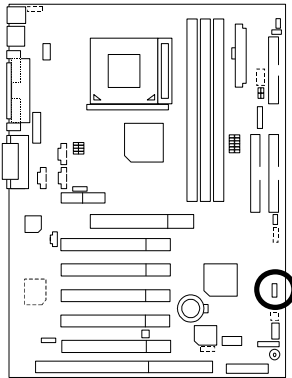

Pin No.	Definition
1	+5V SB
2	GND
3	Signal

WOR: Ring Power On (Internal Modem Card Wake Up) [Optional]

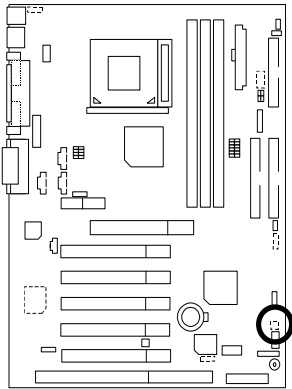

Pin No.	Definition
1	Signal
2	GND

S_LED/LED2: STR LED Connector & DIMM LED

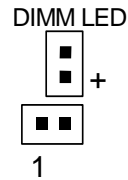
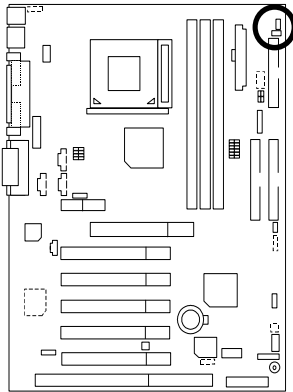

STR LED Connector External

**Please note:**

Do not remove memory modules while DIMM LED is on. It might cause short or other unexpected damages due to the 3.3V stand by voltage. Remove memory modules only when STR function is disabled by jumper and AC Power cord is disconnected.

IR: IR Header

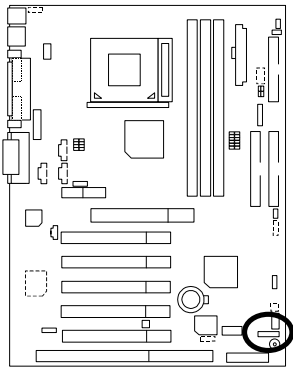

Pin No.	Definition
1	VCC (+5V)
2	NC
3	IR Data Input
4	GND
5	IR Data Output

**Please note:**

Be careful with the polarity of the IR connector while you connect the IR. Please contact you nearest dealer for optional IR device.

S_IRQ: Serial IRQ (Optional)

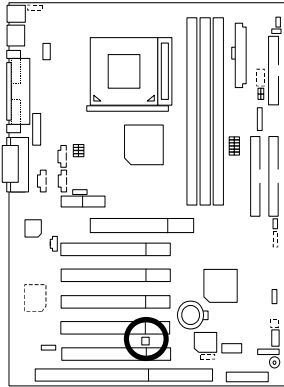

Pin No.	Definition
1	Signal
2	GND

SW4: V_DIMM OVER Voltage

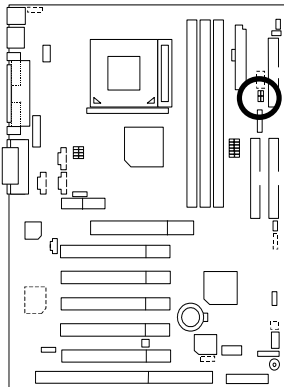

O:ON, X:OFF

	SW1	SW2
3.6V	ON	ON
3.5V	ON	OFF
3.4V	OFF	ON
3.3V (Default)	OFF	OFF



Please note:
Provide SDRAM voltage override function. Incorrect using may cause your SDRAM broken. For power End-User only!

SPDIF: (Optional)

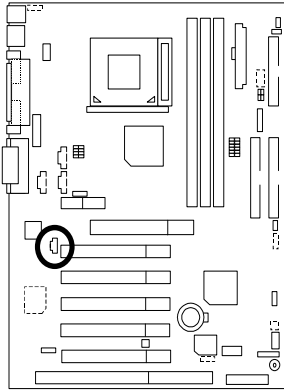

Pin No.	Definition
1	VCC
2	SPDIF OUT
3	GND

**Please note:**

The SPDIF output is capable of providing digital audio to external speakers or compressed AC3 data to an external Dolby Digital Decoder. Use this feature only when your stereo system has digital output function.

Panel And Jumper Definition

F_PANEL: For 2x11 Pins Jumper

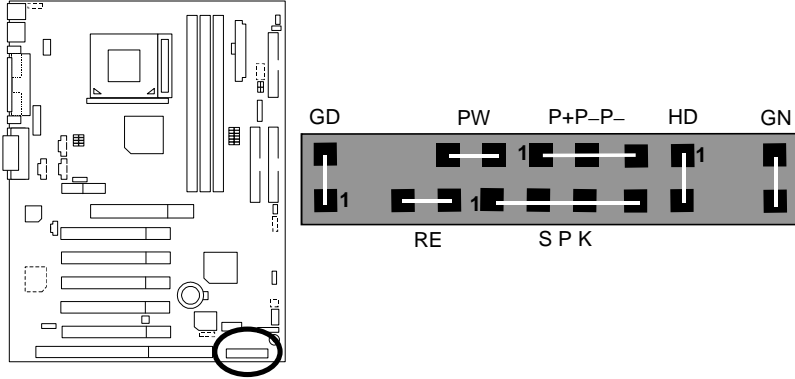

GN (Green Switch)	Open: Normal Operation Close: Entering Green Mode
GD (Green LED)	Pin 1: LED anode(+) Pin 2: LED cathode(-)
HD (IDE Hard Disk Active LED)	Pin 1: LED anode(+) Pin 2: LED cathode(-)
SPK (Speaker Connector)	Pin 1: VCC(+) Pin 2- Pin 3: NC Pin 4: Data(-)
RE (Reset Switch)	Open: Normal Operation Close: Reset Hardware System
P+P-P-(Power LED)	Pin 1: LED anode(+) Pin 2: LED cathode(-) Pin 3: LED cathode(-)
PW (Soft Power Connector)	Open: Normal Operation Close: Power On/Off



Please note: Please connect the power LED, PC speaker, reset switch and power switch etc of your chassis front panel to the front panel jumper according to the pin assignment above.

RUSB_ON: Front/Rear USB Device Wake up Selection

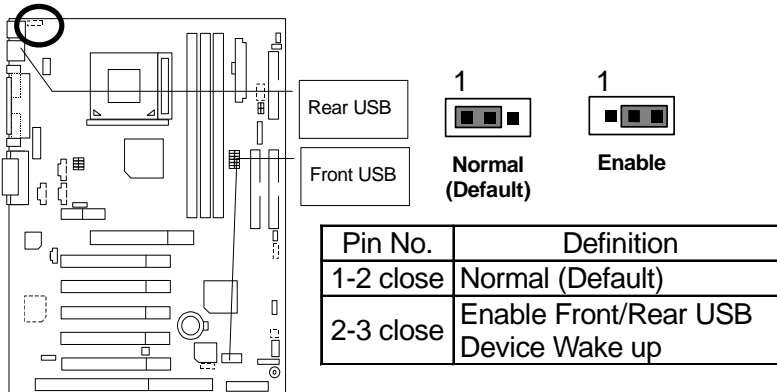

Please note: To use "USB Wakeup from S3-S5" function, set BIOS setting "USB Wakeup from S3-S5" to ENABLED and enable jumpers RUSB_ON & STR_EN.

*(Power on the computer and as soon as memory counting starts, press . You will enter BIOS Setup. Select the item "POWER MANAGEMENT SETUP", then select "USB Wakeup from S3-S5". Remember to save the setting by pressing "ESC" and choose the "SAVE & EXIT SETUP" option.)

CLR_CMOS: Clear CMOS Function (Optional)

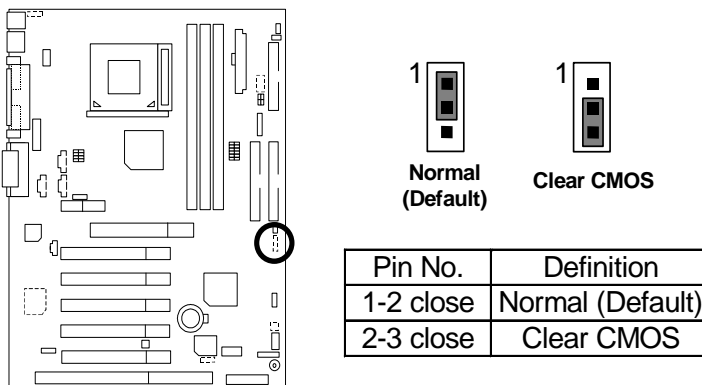

Please note: You may clear the CMOS data to its default values by this jumper.

BIOS_WP: BIOS Write Protection (Optional)

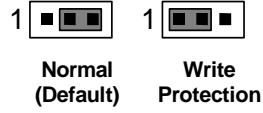
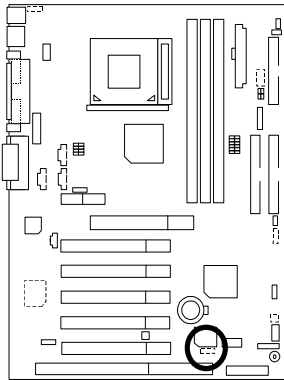

Pin No.	Definition
1-2 close	Write Protection
2-3 close	Normal (Default)



Please note:

To flash/upgrade BIOS on this MB BIOS_WP must be set to 2-3 close. We recommend BIOS_WP to be set to "1-2 close", whenever user does not need to flash/upgrade the BIOS.

CASE_OPEN: Case Open (Optional)

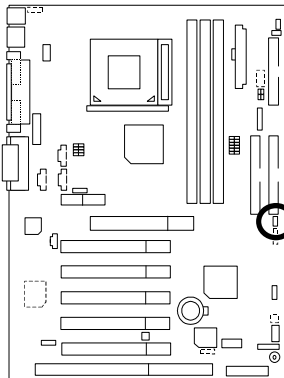

Pin No.	Definition
1	Signal
2	GND

JP18: AMR (Primary or Secondary) Select (Optional)
(AMR → Audio Modem Riser)

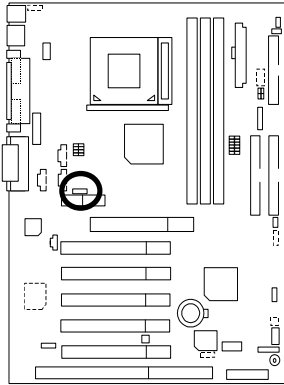

Pin No.	Definition
1-2close	AMR Secondary (Default)
2-3close	AMR Primary AC'97 Disable (Disabled Onboard CODEC)



Please note:

There are two kind of AMR/MR card in the market, Primary and secondary. If your AMR/MR card is primary, JP18 should be set to 2-3, if you have secondary AMR/MR card JP18 should be set to 1-2.
 Warning! If Primary AMR/MR card is used, on-board audio will be disabled.

AUDIO_EN: Onboard Sound Function Selection (Optional)

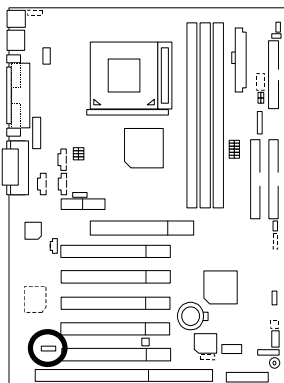

**Enable
(Default)**



Disable

Pin No.	Definition
1-2 close	Enable Onboard Sound (Default)
2-3 close	Disable Onboard Sound

BAT1: Battery

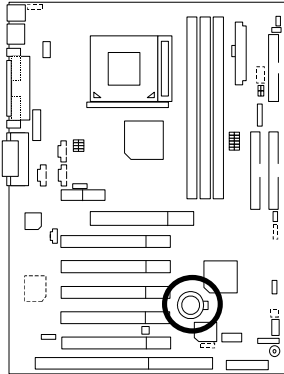

CAUTION

- ▶ Danger of explosion if battery is incorrectly replaced.
- ▶ Replace only with the same or equivalent type recommended by the manufacturer.
- ▶ Dispose of used batteries according to the manufacturer's instructions.

Performance List

The following performance data list is the testing results of some popular benchmark testing programs.

These data are just referred by users, and there is no responsibility for different testing data values gotten by users. (The different Hardware & Software configuration will result in different benchmark testing results.)

- CPU Intel® Socket 370 New Pentium !!! 1.2GHz
Intel® Socket 370 Pentium !!! 1GHz
Intel® Socket370 Celeron 900MHz
- DRAM (128 x 2) MB SDRAM (Kingmax KSV884TA1A-06)
- CACHE SIZE 512 KB included in CPU (Intel® New Pentium !!! 1.2GHz)
256 KB included in CPU (Intel® Pentium !!! 1GHz)
128 KB included in CPU (Intel® Celeron 900MHz)
- DISPLAY GV3000D
- STORAGE Onboard IDE (Quantum AS30000AT 30GB)
- O.S. Windows 2000 + SP2
- DRIVER Display Driver at 1024 x 768 x 64k colors x 75Hz.
VIA 4in1 4.32v(a)

Processor	Intel® New Pentium !!!	Intel® Pentium !!!	Intel® Celeron
	1.2GHz(133x9)	1GHz(133x7.5)	900MHz(100x9)
WCPUID 2.8 Clock Frequency			
Internal MHz	1202.72	1000.03	900.03
External MHz	133.64	133.34	1000.00
SiSoft Sandra 20001			
CPU/FPU Benchmark	3369/1606	2680/1348	2384/1213
CPU Multi-Media Benchmark	6555	5441	4893
Drivers Benchmark	22321	22546	22578
Memory Benchmark	428	370	297

6VTX Motherboard

Processor	Intel® New Pentium !!!	Intel® Pentium !!!	Intel® Celeron
	1.2GHz(133x9)	1GHz(133x7.5)	900MHz(100x9)
SPECviewperf 6.12			
Pro CDRS-03	14.96	14.91	14.88
MedMCAD-01	20.61	19.08	16.22
Light-04	5.120	4.983	4.114
DX-06	14.35	14.35	10.49
DRV-07	13.92	11.56	9.897
Awadvs-04	37.73	41.62	39.32
Winstone 2001			
CC Winstone 2001	63.8	53.2	45.2
Business Winstone 2001	49	41.8	33.7
3D Mark 2001 1.0	5284	4839	4215
Winbench99 (ver1.2g)			
Business Disk	6430	6210	5390
Hi-End Disk	17300	17200	16500
Business Graphics	586	461	323
Hi-End Graphics	1140	929	749

☛ If you wish to maximize the performance of your system, please refer to the detail on P.58

Block Diagram

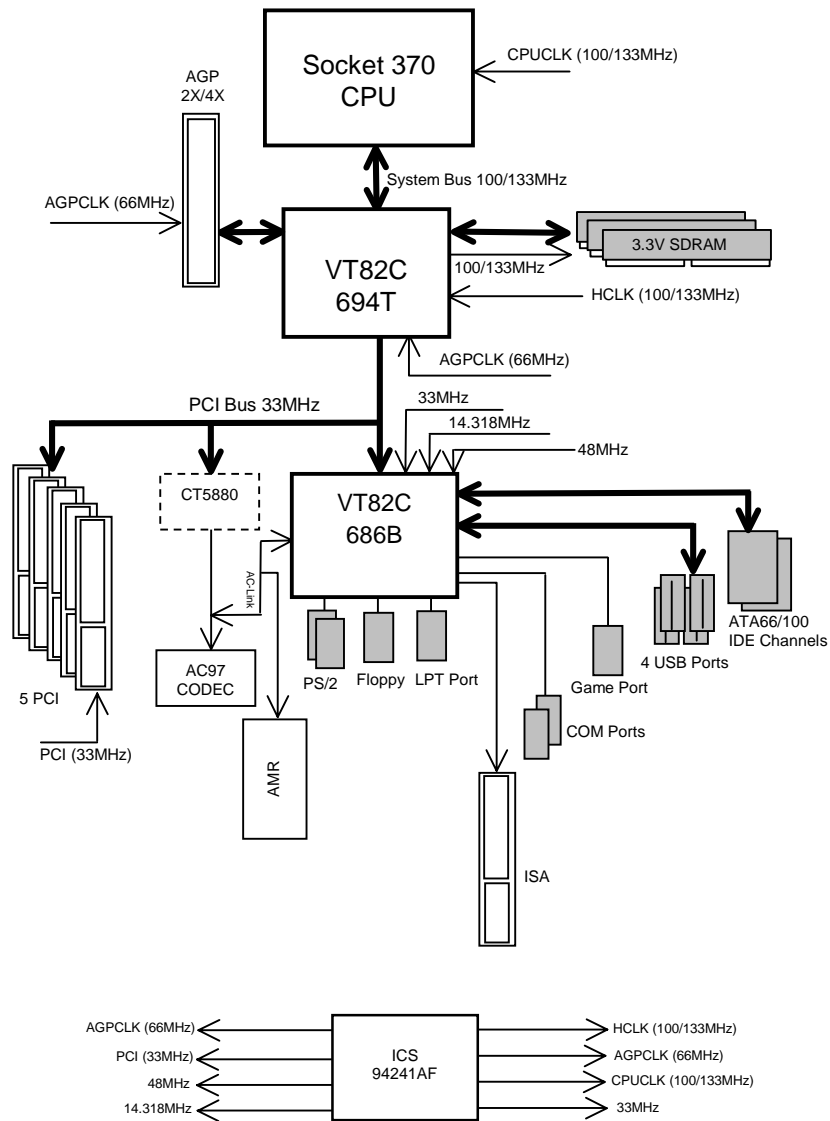

Suspend To RAM Installation

A.1 Introduce STR function:

Suspend-to-RAM (STR) is a Windows 98/ME/2000 ACPI sleep mode function. When recovering from STR (S3) sleep mode, the system is able, in just a few seconds, to retrieve the last "state" of the system before it went to sleep and recover to that state. The "state" is stored in memory (RAM) before the system goes to sleep. During STR sleep mode, your system uses only enough energy to maintain critical information and system functions, primarily the system state and the ability to recognize various "wake up" triggers or signals, respectively.

A.2 STR function Installation

Please use the following steps to complete the STR function installation.

Step-By-Step Setup

Step 1:

To utilize the STR function, the system must be in Windows 98/ME/2000 ACPI mode.

Putting Windows 98/ME/2000 into ACPI mode is fairly easy.

Setup with Windows 98/ME/2000 CD:

- A. Insert the Windows 98/ME/2000 CD into your CD-ROM drive, select Start, and then Run.
- B. Type (without quotes) "**D:\setup** " in the window provided. Hit the enter key or click OK.
- C. After setup completes, remove the CD, and reboot your system
(This manual assumes that your CD-ROM device drive letter is D:).

2. Define the system "power on" button to initiate STR sleep mode:

A. Double click "My Computer" and then "Control Panel"

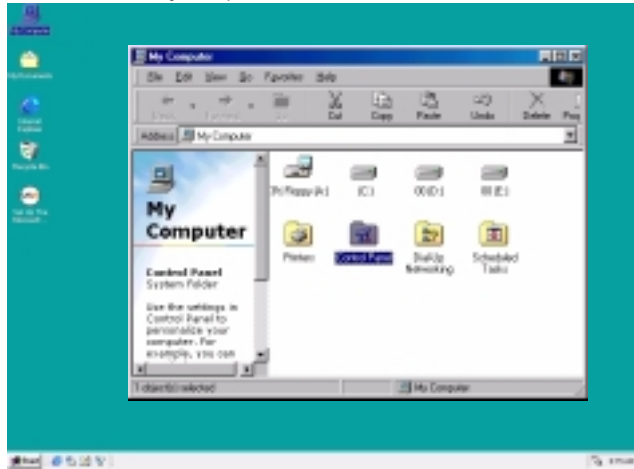

B. Double click the " Power Management" item.

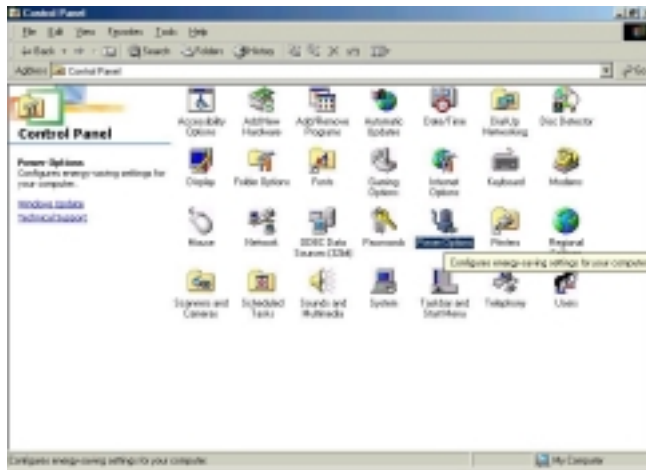

C. Select the "Advanced" tab and "Standby" mode in Power Buttons.

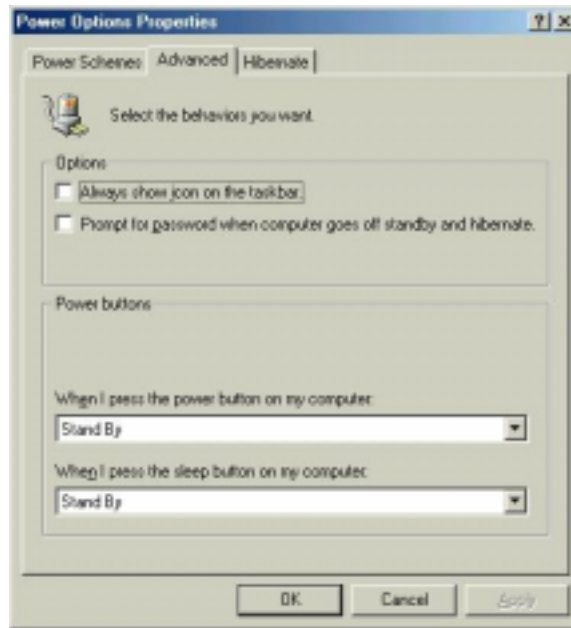

D. Restart your computer to complete setup.

Now when you want to enter STR sleep mode, just momentarily press the "Power on" button.

A.4 How to recover from the STR sleep mode?

There are five ways to "wake up" the system:

1. Press the "Power On" button.
2. Use the "Resume by Alarm" function.
3. Use the "Modem Ring On" function. (Optional)
4. Use the "Wake On LAN" function.
5. Use the "USB Device Wake up" function. (Optional)

A.5 Notices:

1. In order for STR to function properly, several hardware and software requirements must be satisfied:
 - A. Your ATX power supply must comply with the ATX 2.01 specification (provide more than 720 mA 5V Stand-By current).
 - B. Your SDRAM must be PC-100/PC-133 compliant.
2. Jumper S_LED is provided to connect to the STR LED in your system chassis. [Your chassis may not provide this feature.] The STR LED will be illuminated when your system is in STR sleep mode.

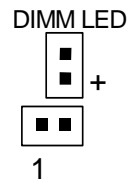
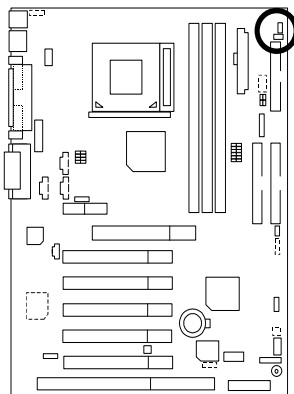

STR LED Connector External

Please note:  Do not remove memory modules while DIMM LED is on. It might cause short or other unexpected damages due to the 3.3V stand by voltage. Remove memory modules only when STR function is disabled by jumper and AC Power cord is disconnected.

Four Speaker & SPDIF Introduction (Optional)

Four Speaker Introduction

A. What is Four Speaker?

The Creative CT5880 audio chip can support up to 4 speaker output. If you select "Four speaker out", Line In will be reconfigured as another line out to support a second pair of speakers.

B. How to use Four Speaker?

Microsoft Windows 98 Second Edition setup procedure:

- a. Click the audio icon along the task bar and select "Configure 3D Audio"

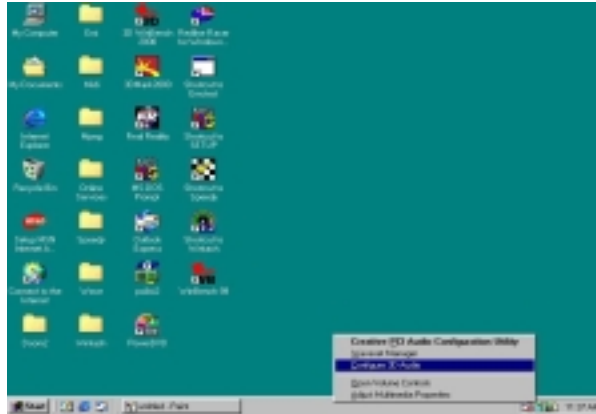

- b. Select two speaker (Default)

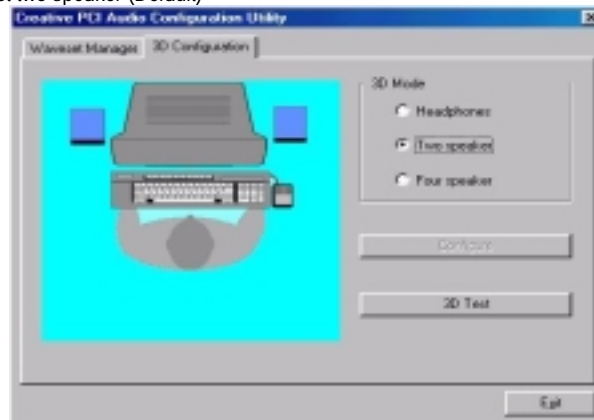

- c. Select "Four speaker" item.

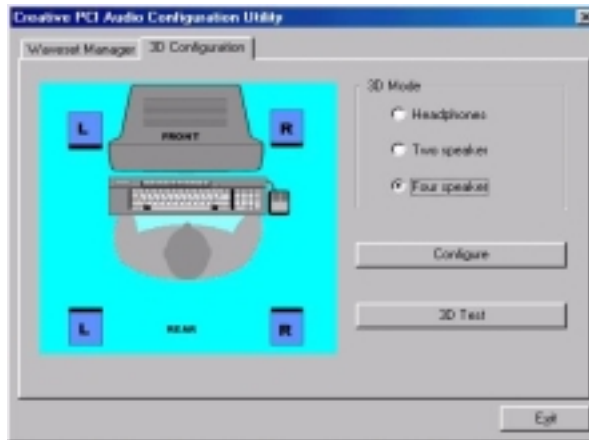

Microsoft Windows Me setup procedure:

- a. Go to "Control Panel"



b. Select "Audio" Page, and click "Advanced" button.

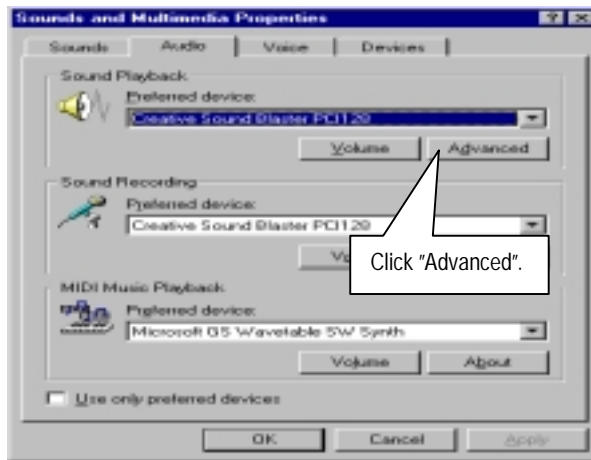

c. Select "Quadraphonic Speakers" and click ok.



C. Four Speaker Application

The four speaker function will only be supported in application softwares that use Microsoft DirectX and Creative EAX, for example, the game titles, software DVD player and MP3 player.

SPDIF Introduction

A. What is SPDIF?

SPDIF output is capable of providing digital signal to AC3 decoder which can support upto 5.1 speakers.

B. How to use SPDIF?

- a. Click your mouse right button in "My Computer" and select the "Properties" item.

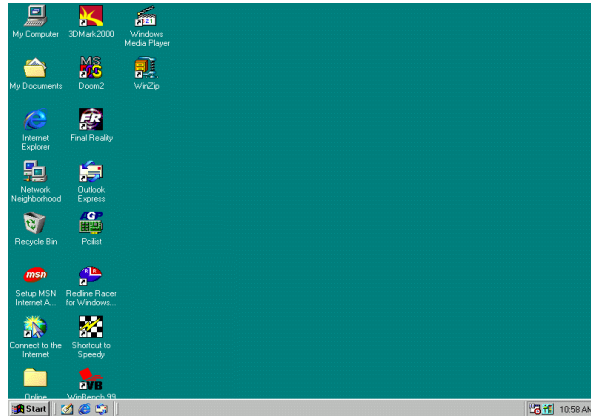

- b. Click "Device Manager" item.

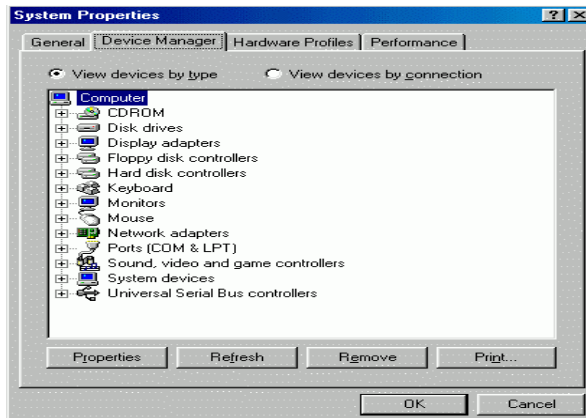

- c. Click "Sound, video and game controllers" item and select the "Creative Sound Blaster PCI128" item.

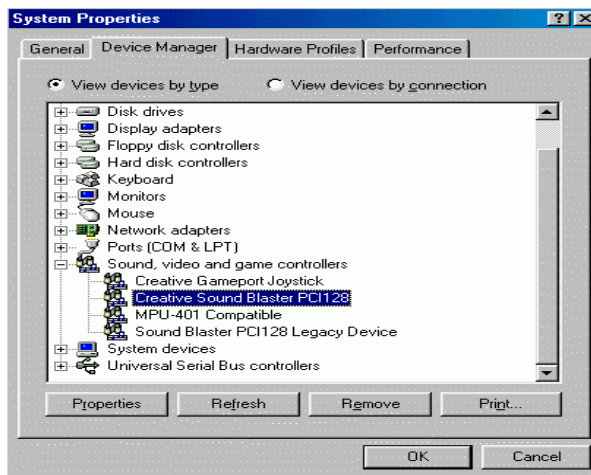

- d. Click "Settings" item and select the "Output Mode" item.

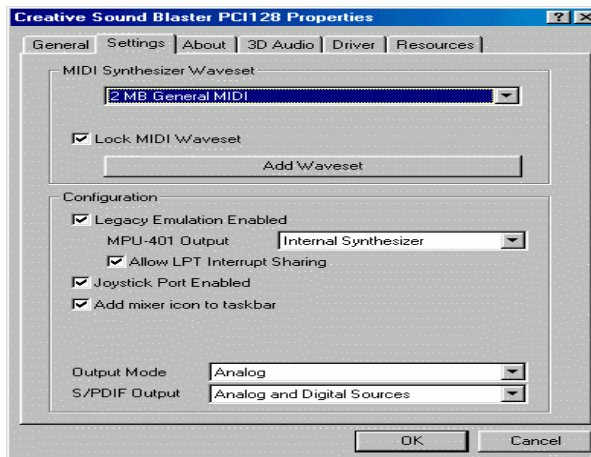

e. Click "Digital" item, Line Out will be reconfigure to SPDIF Out.

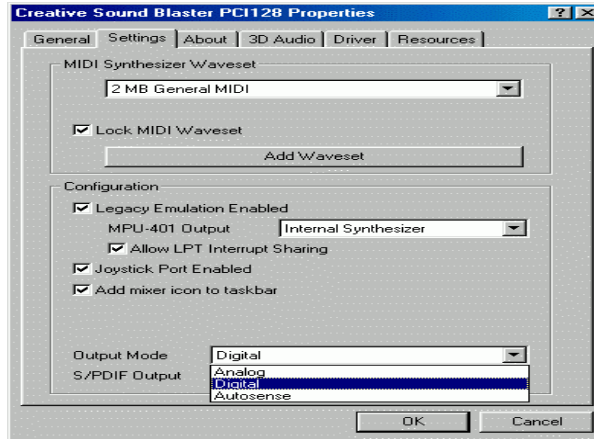

f. Recommend you to select "Autosense", It will automatically detect the type (mono or stereo) of the audio connector that you plug into Line Out audio jack, then configure Line Out to either SPDIF or Speaker accordingly.

Instant BIOS Flash Utility Introduction

A. What's Instant BIOS Flash Utility?

Gigabyte's brings you another BIOS upgrade technology. Today, You don't have to follow the inconvenient traditional way of updating BIOS. With Instant BIOS Flash Utility you don't need to boot into DOS or Windows.

You can now easily update BIOS by just pressing F2 during boot up.

B. How to use Instant BIOS Flash Utility?

a. Boot Screen

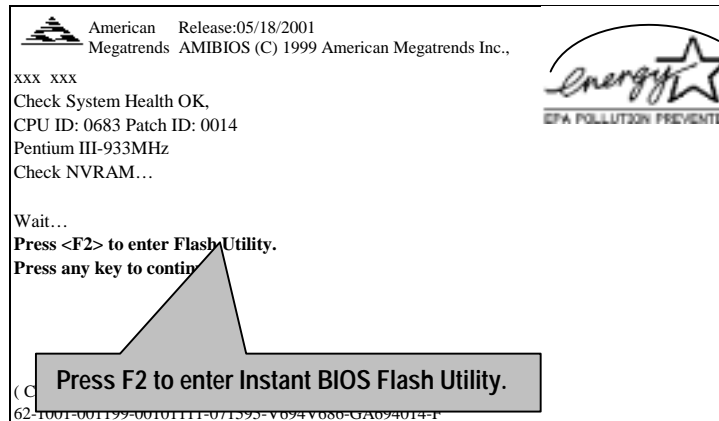

b. AMI Instant BIOS Flash Utility

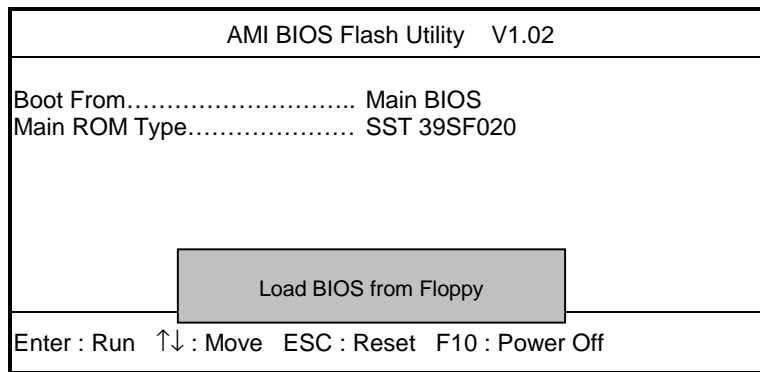

c. In the A: drive, insert the "BIOS" diskette, then Press Enter to Run.

d. Input BIOS file name in the text box. Press "Enter".

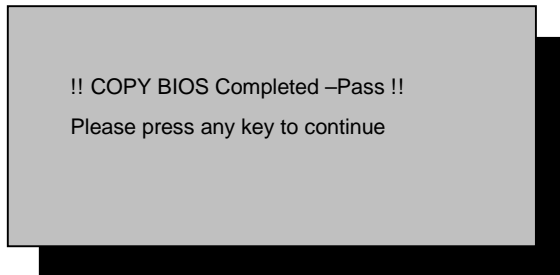
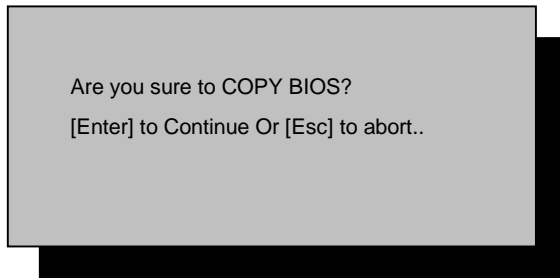

Congratulation! You have completed the flashed and now can restart system.

@BIOS™ Introduction

Gigabyte announces @BIOS™ Windows BIOS live update utility



Have you ever updated BIOS by yourself? Or like many other people, you just know what BIOS is, but always hesitate to update it? Because you think updating newest BIOS is unnecessary and actually you don't know how to update it.

Maybe not like others, you are very experienced in BIOS updating and spend quite a lot of time to do it. But of course you don't like to do it too much. First, download different BIOS from website and then switch the operating system to DOS mode. Secondly, use different flash utility to update BIOS. The above process is not a interesting job. Besides, always be carefully to store the BIOS source code correctly in your disks as if you update the wrong BIOS, it will be a nightmare.

Certainly, you wonder why motherboard vendors could not just do something right to save your time and effort and save you from the lousy BIOS updating work? Here it comes! Now Gigabyte announces @BIOS™--the first Windows BIOS live update utility. This is a smart BIOS update software. It could help you to download the BIOS from internet and update it. Not like the other BIOS update software, it's a Windows utility. With the help of "@BIOS™", BIOS updating is no more than a click.

Besides, no matter which mainboard you are using, if it's a Gigabyte's product*, @BIOS™ help you to maintain the BIOS. This utility could detect your correct mainboard model and help you to choose the BIOS accordingly. It then downloads the BIOS from the nearest Gigabyte ftp site automatically. There are several different choices; you could use "Internet Update" to download and update your BIOS directly. Or you may want to keep a backup for your current BIOS, just choose "Save Current BIOS" to save it first. You make a wise choice to use Gigabyte, and @BIOS™ update your BIOS smartly. You are now worry free from updating wrong BIOS, and capable to maintain and manage your BIOS easily. Again, Gigabyte's innovative product erects a milestone in mainboard industries.

For such a wonderful software, how much it costs? Impossible! It's free! Now, if you buy a Gigabyte's motherboard, you could find this amazing software in the attached driver CD. But please remember, connected to internet at first, then you could have a internet BIOS update from your Gigabyte @BIOS™.

EasyTuneIII™ Introduction

Gigabyte announces EasyTuneIII™ Windows overdrive utility



“Overdrive” might be one of the most common issues in computer field. But have many users ever tried it? The answer is probably “no”. Because “overdrive” is thought to be very difficult and includes a lot of technical know-how, sometimes “overdrive” is even considered as special skills found only in some enthusiasts.

But as to the experts in “overdrive”, what’s the truth? They may spend quite a lot of time and money to study, try and use many different hardware and software tools to do “overdrive”. And even with these technologies, they still learn that it’s quite a risk because the safety and stability of an “overdrive” system is unknown.

Now everything is different because of a Windows overdrive utility EasyTuneIII™ --announced by Gigabyte. This utility has totally changed the gaming rule of “overdrive”. This is the first overdrive utility suitable for both normal and power users. Users can choose either “Easy Mode” or “Advanced Mode” to run “overdrive” at their convenience. For users who choose “Easy Mode”, they just need to click “Auto Optimize” to have auto and immediate CPU overclocking. This software will then overdrive CPU speed automatically with the result being shown in the control panel. If someone prefers to “overdrive” by oneself, there is also another choice. Click “Advanced Mode” to enjoy “sport drive” class overclocking. In “Advanced Mode”, one can change the system bus speed in small increments to get ultimate system performance. And no matter which mainboard is used, if it’s a Gigabyte’s product*, EasyTuneIII™ helps to perform the best of system.

Besides, different from other traditional over-clocking methods, EasyTuneIII™ doesn’t require users to change neither BIOS nor hardware switch/ jumper setting; on the other hand, they can do “overdrive” at only one click. Therefore, this is a safer way for “overdrive” as nothing is changed on software or hardware. If user runs EasyTuneIII™ over system’s limitation, the biggest lost is only to restart the computer again and the side effect is then well controlled. Moreover, if one well-performed system speed been tested in EasyTuneIII™, user can “Save” this bus speed and “Load” it in next time. Obviously, Gigabyte EasyTuneIII™ has already turned the “overdrive” technology toward to a newer generation.

This wonderful software is now free bundled in Gigabyte motherboard attached driver CD. Users may make a test drive of "EasyTuneIII™" to find out more amazing features by themselves.

For further technical information, please link to: <http://www.gigabyte.com.tw>

※ Note: For the latest version of EasyTuneIII™, please visit our website.

6VTX Motherboard

Page Index for BIOS Setup	Page
The Main Menu	P.51
Standard CMOS Setup	P.53
BIOS Features Setup	P.56
Chipset Features Setup	P.58
Power Management Setup	P.61
PNP/ PCI Configuration	P.64
Load Fail-Safe Defaults	P.66
Load Optimized Defaults	P.67
Integrated Peripherals	P.68
Hardware Monitor & MISC Setup	P.72
Supervisor / User Password	P.74
IDE HDD Auto Detection	P.75
Save & Exit Setup	P.76
Exit Without Saving	P.77

BIOS Setup

BIOS Setup is an overview of the BIOS Setup Interface. The interface allows users to modify the basic system configuration, which is stored in battery-backed CMOS RAM so that the Setup information can be retained when the power is turned off.

ENTERING SETUP

Power ON the computer and press immediately will allow you to enter Setup. If unsuccessful, you can restart the system and try again by pressing the "RESET" button on the system case. You may also restart by simultaneously pressing <Ctrl> – <Alt>– keys.

CONTROL KEYS

<↑>	Move to previous item
<↓>	Move to next item
<<→>	Move to the item in the left hand
<←>	Move to the item in the right hand
<Esc>	Main Menu - Quit and not save changes into CMOS Status Page Setup Menu and Option Page Setup Menu - Exit current page and return to Main Menu
<+/ PgUp>	Increase the numeric value or make changes
<-/ PgDn>	Decrease the numeric value or make changes
<F1>	General help, only for Status Page Setup Menu and Option Page Setup Menu
<F2>	Reserved
<F3>	Reserved
<F4>	Reserved
<F5>	Restore the previous CMOS values
<F6>	Load the file-safe default CMOS value from BIOS default table
<F7>	Load the Optimized Defaults
<F8>	Reserved
<F9>	Reserved
<F10>	Save all the CMOS changes, only for Main Menu

GETTING HELP

Main Menu

The on-line description of the highlighted setup function is displayed at the bottom of the screen.

Status Page Setup Menu / Option Page Setup Menu

Press F1 to pop up a small help window that describes the appropriate keys to use and the possible selections for the highlighted item. To exit the Help Window press <Esc>.

The Main Menu (For example: BIOS Ver. : F3)

Once you enter AMI BIOS CMOS Setup Utility, the Main Menu (Figure 1) will appear on the screen. The Main Menu allows you to select from nine setup functions and two exit choices. Use arrow keys to select among the items and press <Enter> to accept or enter the sub-menu.

AMIBIOS SIMPLE SETUP UTILITY – VERSION 1.24e (C) 1999 American Megatrends, Inc. All Rights Reserved	
STANDARD CMOS SETUP	INTEGRATED PERIPHERALS
BIOS FEATURES SETUP	HARDWARE MONITOR & MISC SETUP
CHIPSET FEATURES SETUP	SUPERVISOR PASSWORD
POWER MANAGEMENT SETUP	USER PASSWORD
PNP / PCI CONFIGURATION	IDE HDD AUTO DETECTION
LOAD FAIL-SAFE DEFAULTS	SAVE & EXIT SETUP
LOAD OPTIMIZED DEFAULTS	EXIT WITHOUT SAVING
ESC: Quit ↑↓→←: Select Item (Shift)F2: Change Color F5: Old Values F6: Load Fail-Safe Defaults F7: Load Optimized Defaults F10: Save & Exit	
Time, Date, Hard Disk Type...	

Figure 1: Main Menu

- **Standard CMOS Setup**

This setup page includes all the adjustable items in standard compatible BIOS.

- **BIOS Features Setup**

This setup page includes all the adjustable items of AMI special enhanced features.

- **Chipset Features Setup**

This setup page includes all the adjustable items of chipset special features.

- **Power Management Setup**

This setup page includes all the adjustable items of Green function features.

- **PNP/PCI Configurations**

This setup page includes all the adjustable configurations of PCI & PnP ISA resources.

- **Load Fail-Safe Defaults**

Load Fail-Safe Defaults option loads preset system parameter values to set the system in its most stable configurations.

- **Load Optimized Defaults**

Load Optimized Defaults option loads preset system parameter values to set the system in its highest performance configurations.

- **Integrated Peripherals**

This setup page includes all onboard peripherals.

- **Hardware Monitor & MISC Setup**

Configure hardware monitor features, control frequency/voltage.

- **Set Supervisor Password**

Set Change or disable password. It allows you to limit access to the system and/or BIOS setup.

- **Set User Password**

Set Change or disable password. It allows you to limit access to the system.

- **IDE HDD auto detection**

Automatically configure hard disk parameters.

- **Save & Exit Setup**

Save CMOS value settings to CMOS and exit setup.

- **Exit Without Saving**

Abandon all CMOS value changes and exit setup.

Standard CMOS Setup

The items in Standard CMOS Setup Menu (Figure 2) are divided into 10 categories. Each category includes none, one or more than one setup items. Use the arrows to highlight the item and then use the <PgUp> or <PgDn> keys to select the value in each item.

AMIBIOS SETUP – STANDARD CMOS SETUP																																									
(C) 1999 American Megatrends, Inc. All Rights Reserved																																									
Date (mm/dd/yyyy) : Tue Mar 27, 2001																																									
Time (hh/mm/ss) : 14:44:35																																									
<table border="1"> <thead> <tr> <th>TYPE</th> <th>SIZE</th> <th>CYLS</th> <th>HEAD</th> <th>PRECOMP</th> <th>LANDZ</th> <th>SECTOR</th> <th>MODE</th> </tr> </thead> <tbody> <tr> <td>Pri Master</td> <td>: Auto</td> <td></td> <td></td> <td></td> <td></td> <td></td> <td></td> </tr> <tr> <td>Pri Slave</td> <td>: Auto</td> <td></td> <td></td> <td></td> <td></td> <td></td> <td></td> </tr> <tr> <td>Sec Master</td> <td>: Auto</td> <td></td> <td></td> <td></td> <td></td> <td></td> <td></td> </tr> <tr> <td>Sec Slave</td> <td>: Auto</td> <td></td> <td></td> <td></td> <td></td> <td></td> <td></td> </tr> </tbody> </table>		TYPE	SIZE	CYLS	HEAD	PRECOMP	LANDZ	SECTOR	MODE	Pri Master	: Auto							Pri Slave	: Auto							Sec Master	: Auto							Sec Slave	: Auto						
TYPE	SIZE	CYLS	HEAD	PRECOMP	LANDZ	SECTOR	MODE																																		
Pri Master	: Auto																																								
Pri Slave	: Auto																																								
Sec Master	: Auto																																								
Sec Slave	: Auto																																								
Floppy Drive A : 1.44 MB 3½	Base Memory : 640 Kb																																								
Floppy Drive B : Not Installed	Other Memory : 384 Kb																																								
	Extended Memory : 63 Mb																																								
Boot Sector Virus Protection : Disabled	Total Memory : 64 Mb																																								
Month : Jan – Dec	ESC : Exit																																								
Day : 01– 31	↑↓ : Select Item																																								
Year : 1990 – 2099	PU / PD / + / - : Modify																																								
	(Shift) F2 : Color																																								

Figure 2: Standard CMOS Setup

- **Date**

The date format is <Week> <Month> <Day> <Year>.

Week	The week, from Sun to Sat, determined by the BIOS and is display-only.
Month	The month, Jan. Through Dec.
Day	The day, from 1 to 31 (or the maximum allowed in the month).
Year	The year, from 1990 through 2099.

- **Time**

The times format in <hour> <minute> <second>. The time is calculated base on the 24-hour military-time clock. For example, 1 p.m. is 13:00:00.

● **Primary Master / Slave, Secondary Master / Slave**

The category identifies the type of hard disk from drive C to F that has been installed in the computer. There are two settings: Auto, and Manual. Manual: HDD type is user-definable; Auto will automatically detect HDD type.

Note that the specifications of your drive must match with the drive table. The hard disk will not work properly if you enter improper information for this category.

If you select User Type, related information will be asked to enter to the following items. Enter the information directly from the keyboard and press <Enter>. Such information should be provided in the documentation form your hard disk vendor or the system manufacturer.

CYLS.	Number of cylinders.
HEADS	number of heads.
PRECOMP	write precomp.
LANDZONE	Landing zone.
SECTORS	number of sectors.

If a hard disk has not been installed select NONE and press <Enter>.

● **Floppy Drive A / Floppy Drive B**

The category identifies the type of floppy disk drive A or drive B that has been installed in the computer.

None	No floppy drive installed.
360K, 5.25 in.	5.25 inch PC-type standard drive; 360K byte capacity.
1.2M, 5.25 in.	5.25 inch AT-type high-density drive; 1.2M byte capacity (3.5 inch when 3 Mode is Enabled).
720K, 3.5 in.	3.5 inch double-sided drive; 720K byte capacity.
1.44M, 3.5 in.	3.5 inch double-sided drive; 1.44M byte capacity.
2.88M, 3.5 in.	3.5 inch double-sided drive; 2.88M byte capacity.

- **Boot Sector Virus Protection**

If it is set to enable, the category will flash on the screen when there is any attempt to write to the boot sector or partition table of the hard disk drive. The system will halt and the following error message will appear in the mean time. You can run anti-virus program to locate the problem.

Enabled	Activate automatically when the system boots up causing a warning message to appear when anything attempts to access the boot sector or hard disk partition table.
Disabled	No warning message to appear when anything attempts to access the boot sector or hard disk partition table. (Default Value)

- **Memory**

The category is display-only which is determined by POST (Power On Self Test) of the BIOS.

Base Memory

The POST of the BIOS will determine the amount of base (or conventional) memory installed in the system.

The value of the base memory is typically 512 K for systems with 512 K memory installed on the motherboard, or 640 K for systems with 640 K or more memory installed on the motherboard.

Other Memory

This refers to the memory located in the 640 K to 1024 K address space. This is memory that can be used for different applications.

DOS uses this area to load device drivers to keep as much base memory free for application programs. Most use for this area is Shadow RAM.

Extended Memory

The BIOS determines how much extended memory is present during the POST. This is the amount of memory located above 1 MB in the CPU's memory address map.

BIOS Features Setup

AMIBIOS SETUP – BIOS FEATURES SETUP	
(C) 1999 American Megatrends, Inc. All Rights Reserved	
1st Boot Device	: Floppy
2nd Boot Device	: IDE-0
3rd Boot Device	: CDROM
S.M.A.R.T. for Hard Disks	: Disabled
IDE Boot Delay	: Disabled
BootUp Num-Lock	: On
Floppy Drive Seek	: Disabled
Password Check	: Setup
Processor Serial Number	: Disabled
BIOS Flash Protection	: Disabled
ESC: Quit ↑↓→←: Select Item F1 : Help PU/PD+/-/: Modify F5 :Old Values (Shift)F2:Color F6 : Load Fail-Safe Defaults F7 : Load Optimized Defaults	

Figure 3: BIOS Features Setup

- **1st / 2nd / 3rd Boot Device**

Floppy	Set your boot device priority to Floppy.
LS/ZIP A:	Set your boot device priority to LS/ZIP A:.
ATAPI ZIP C:	Set your boot device priority to ATAPI ZIP C:.
CDROM	Set your boot device priority to CDROM.
SCSI	Set your boot device priority to SCSI.
NETWORK	Set your boot device priority to NETWORK.
IDE-0-IDE-3	Set your boot device priority to IDE-0-IDE-3.
Disabled	Disable this function.

- **S.M.A.R.T. for Hard Disks**

Enabled	Enable S.M.A.R.T. Feature for Hard Disks.
Disabled	Disable S.M.A.R.T. Feature for Hard Disks. (Default Value)

- **IDE Boot Delay**

1 Sec.-10 Sec.	Set IDE Boot Delay to 1 Sec.-10 Sec.
Disabled	Disable this function. (Default Value)

- **Boot Up Num-Lock**

On	Keypad is number keys. (Default Value)
Off	Keypad is arrow keys.

- **Floppy Drive Seek**

During POST, BIOS will determine if the floppy disk drive installed is 40 or 80 tracks. 360 type is 40 tracks while 720, 1.2 and 1.44 are all 80 tracks.

Enabled	BIOS searches for floppy disk drive to determine if it is 40 or 80 tracks. Note that BIOS can't differentiate between from 720, 1.2 or 1.44 drive type as they are all 80 tracks.
Disabled	BIOS will not search for the type of floppy disk drive by track number. Note that there will not be any warning message if the drive installed is 360. (Default Value)

- **Password Check**

 Please refer to the detail on P.74

Setup	The user must enter correct password in order to access BIOS setup utility. (Default Value)
Always	The user must enter correct password in order to access the system and/or BIOS Setup.

- **Processor Serial Number**

This item will show up when you install the Pentium® !!! processor.

Enabled	Pentium® !!! Processor Serial Number Feature.
Disabled	Disable this function. (Default value)

- **BIOS Flash Protection**

Enabled	Enable BIOS Flash Protection. This will prevent BIOS Flash write after POST.
Disabled	To flash/upgrade BIOS on this MB, this item must be disable. We recommend this item to be set to "Disabled". (Default Value)

Chipset Features Setup

 We would not suggest you change the chipset default setting unless you really need it.

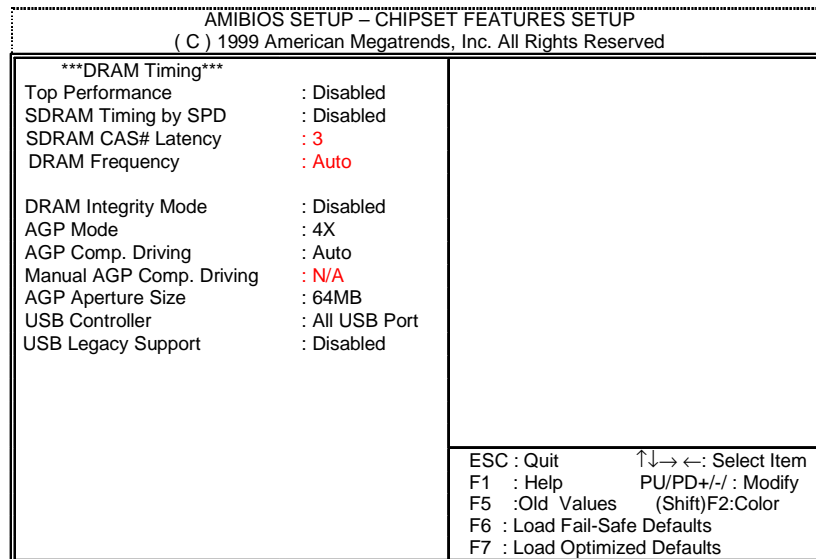

Figure 4: Chipset Features Setup

- **Top Performance**

If you wish to maximize the performance of your system, set "Top Performance" as "Enabled".

Disabled	Disable this function. (Default Value)
Enabled	Top Performance Enable.

- **SDRAM Timing by SPD**

Enabled	Enable SDRAM Timing by SPD. Enable this function, the bios will set SDRAM Frequency/SDRAM CAS#/SDRAM Bank Interleave according to the SPD Data in SDRAM.
Disabled	Disable SDRAM Timing by SPD. (Default Value)

- **SDRAM CAS# Latency**

2	Set SDRAM CAS# Latency to 2.
3	Set SDRAM CAS# Latency to 3.

• DRAM Frequency

Auto	Set DRAM Frequency to Auto.
66Mhz	Set DRAM Frequency to 66Mhz.
100Mhz	Set DRAM Frequency to 100Mhz.
133Mhz	Set DRAM Frequency to 133Mhz.

• DRAM Integrity Mode

Disabled	Disable this function. (Default Value)
ECC	Single-bit error correction and multi-bit error detection.

• AGP Mode

4X	Set AGP Mode to 4X (Only if the AGP Card support 4X Rate). (Default Value)
1X	Set AGP Mode to 1X.
2X	Set AGP Mode to 2X.

• AGP Comp. Driving

Auto	Set AGP Comp. Driving to Auto. (Default Value)
Manual	Set AGP Comp. Driving to Manual.

If AGP Comp. Driving is Manual.

Manual AGP Comp. Driving:	00-FF
---------------------------	-------

• AGP Aperture Size

4 MB	Display AGP Aperture Size is 4MB.
8 MB	Display AGP Aperture Size is 8MB.
16 MB	Display AGP Aperture Size is 16MB.
32 MB	Display AGP Aperture Size is 32MB.
64 MB	Display AGP Aperture Size is 64MB. (Default Value)
128 MB	Display AGP Aperture Size is 128MB.
256 MB	Display AGP Aperture Size is 256MB.

• USB Controller

All USB Port	Enable All USB Ports 0,1,2,3. (Default Value)
Disabled	Disable USB Controller.
USB Port 0&1	Enable USB Ports 0&1.
USB Port 2&3	Enable USB Ports 2&3.

- **USB Legacy Support**

Keyboard	Enable USB Legacy Support for USB Keyboard.
Keyb+Mouse	Enable USB Legacy Support for USB Keyboard/USB Mouse.
Disabled	Disable USB Legacy Support Function. (Default Value)

Power Management Setup

AMIBIOS SETUP – POWER MANAGEMENT SETUP			
(C) 1999 American Megatrends, Inc. All Rights Reserved			
ACPI Sleep Type	: S1/POS	PME Event Wake Up	: Enabled
USB Wakeup from S3-S5	: Disabled	AMR Event Wake Up	: Enabled
Video Power Down Mode	: Stand By	RTC Alarm Power On	: Disabled
Hard Disk Power Down Mode	: Stand By	RTC Alarm Date	: 15
Suspend Time Out (Minute)	: Disabled	RTC Alarm Hour	: 12
Display Activity	: Ignore	RTC Alarm Minute	: 30
IRQ3	: Monitor	RTC Alarm Second	: 30
IRQ4	: Monitor		
IRQ5	: Ignore		
IRQ7	: Monitor		
IRQ9	: Ignore		
IRQ10	: Ignore		
IRQ11	: Ignore		
IRQ13	: Ignore		
IRQ14	: Monitor		
IRQ15	: Ignore		
Soft-Off by Power Button	: Instant Off	ESC : Quit	↑↓→←: Select Item
AC Back Function	: Soft Off	F1 : Help	PU/PD+/-: Modify
Modem Use IRQ	: 4	F5 :Old Values	(Shift)F2:Color
Modem Ring On/Wake On Lan	: Enabled	F6 : Load Fail-Safe Defaults	
		F7 : Load Optimized Defaults	

Figure 5: Power Management Setup

- **ACPI Sleep Type**

S1/POS	Set ACPI sleep type to S1. (Default Value)
S3/STR	Set ACPI sleep type to S3.

- **USB Wakeup From S3-S5**

Enabled	Enable USB Wakeup from S3-S5.
Disabled	Disable USB Wakeup from S3-S5. (Default Value)

- **Video Power Down Mode**

Stand By	Set Video Power Down Mode to Stand By. (Default Value)
Suspend	Set Video Power Down Mode to Suspend.
Disabled	Disable this function.

- **Hard Disk Power Down Mode**

Stand By	Set Hard Disk Power Down Mode to Stand By. (Default Value)
Suspend	Set Hard Disk Power Down Mode to Suspend.
Disabled	Disable this function.

● **Suspend Time Out (Minute.)**

Disabled	Disable Suspend Time Out Function. (Default Value)
1	Enable Suspend Time Out after 1min.
2	Enable Suspend Time Out after 2min.
4	Enable Suspend Time Out after 4min.
8	Enable Suspend Time Out after 8min.
10	Enable Suspend Time Out after 10min.
20	Enable Suspend Time Out after 20min.
30	Enable Suspend Time Out after 30min.
40	Enable Suspend Time Out after 40min.
50	Enable Suspend Time Out after 50min.
60	Enable Suspend Time Out after 60min.

● **Display Activity**

Ignore	Ignore Display Activity. (Default Value)
Monitor	Monitor Display Activity.

● **IRQ 3-IRQ 15**

Ignore	Ignore IRQ3 -IRQ15.
Monitor	IRQ3-IRQ15 event can wake up the system from sleep state (S1).

● **Soft-off by Power Button**

Instant off	The user press the power button once, he can turn off the system. (Default Value)
Delay-4sec	Press power button 4 sec to Power off. Enter suspend if button is pressed less than 4 sec.

● **AC Back Function**

Memory	When AC-power back to the system, the system will return to the Last state before AC-power off.
Soft Off	When AC-power back to the system, the system will be in "Off" state. (Default Value)
Full On	When AC-power back to the system, the system will be in "On" state.

● **Modem USE IRQ**

3, 4, (Default Value) 5, 7, N/A
--

- **Modem Ring On / Wake On Lan**

Disabled	Disable Modem Ring On / Wake On LAN function.
Enabled	The modem ring / LAN wake up will bring the system out of soft-off or suspend state if this option is set "Enabled". (Default Value)

- **PME Event Wake up**

Disabled	Disable PME event wake up function.
Enabled	The PME event wake up will bring the system out of soft-off or suspend state if this option is set "Enabled". (Default Value)

- **AMR Event Wake up**

Disabled	Disable AMR event wake up function.
Enabled	The AMR event wake up will bring the system out of soft-off or suspend state if this option is set "Enabled". (Default Value)

- **RTC Alarm Power On**

You can set "RTC Alarm Power On" item to enabled and key in Data/time to power on system.

Disabled	Disable this function. (Default Value)
Enabled	Enable alarm function to POWER ON system.

If the default value is Enabled.

RTC Alarm Date:	Every Day, 1~31
RTC Alarm Hour:	0~23
RTC Alarm Minute:	0~59
RTC Alarm Second:	0~59

PNP/PCI Configuration

AMIBIOS SETUP – PNP / PCI CONFIGURATION (C) 1999 American Megatrends, Inc. All Rights Reserved	
Plug and Play Aware O/S	: No
Reset Configuration Data	: No
VGA Boot from	: PCI
PCI AGP Palette Snoop	: Disabled
DMA Channel 0	: PnP
DMA Channel 1	: PnP
DMA Channel 3	: PnP
DMA Channel 5	: PnP
DMA Channel 6	: PnP
DMA Channel 7	: PnP
IRQ 3	: PCI/PnP
IRQ 4	: PCI/PnP
IRQ 5	: PCI/PnP
IRQ 7	: PCI/PnP
IRQ 9	: PCI/PnP
IRQ 10	: PCI/PnP
IRQ 11	: PCI/PnP
IRQ 14	: PCI/PnP
IRQ 15	: PCI/PnP
ESC: Quit ↑↓→←: Select Item F1 : Help PU/PD+/-/: Modify F5 :Old Values (Shift)F2:Color F6 : Load Fail-Safe Defaults F7 : Load Optimized Defaults	

Figure 6: PNP/ PCI Configuration

- **Plug and Play Aware O/S**

Yes	Enable Plug and Play Aware O/S function.
No	Disable Plug and Play Aware O/S function. (Default Value)

- **Reset Configuration Data**

Advising BIOS clear PnP configuration data for usable value.

No	Disable this function. (Default Value)
Yes	Reset PnP configuration data in order to re-initialize ESCD for PnP device.

- **VGA Boot from**

AGP	Set VGA Boot from AGP VGA Card.
PCI	Set VGA Boot from PCI VGA Card. (Default Value)

- **PCI/VGA Palette Snoop**

Enabled	For having Video Card on ISA Bus and VGA Card on PCI Bus.
Disabled	For VGA Card only. (Default Value)

- **DMA Channel (0,1,3,5,6,7)**

ISA/EISA	The resource is used by Legacy ISA device.
PnP	The resource is used by PnP device. (Default Value)

- **IRQ (3, 4, 5, 7, 9, 10, 11, 14, 15)**

ISA/EISA	The resource is reserved for Legacy ISA device.
PCI/PnP	The resource is reserved for PCI/ PnP device. (Default Value)

Load Fail-Safe Defaults

AMIBIOS SIMPLE SETUP UTILITY-VERSION 1.24e (C) 1999 American Megatrends, Inc. All Rights Reserved	
STANDARD CMOS SETUP	INTEGRATED PERIPHERALS
BIOS FEATURES SETUP	HARDWARE MONITOR & MISC SETUP
CHIPSET FEATURES SETUP	SUPERVISOR PASSWORD
POWER MANAGEMENT SETUP	USER PASSWORD
PNP/PCI CONFIGURATION	LOAD FAIL-SAFE DEFAULTS (Y/N)?N
LOAD FAIL-SAFE DEFAULTS	SAVE & EXIT SETUP
LOAD OPTIMIZED DEFAULTS	EXIT WITHOUT SAVING
ESC : Quit ↑↓→← : Select Item (Shift) F2 : Change Color F5 : Old Values F6 : Load Fail-Safe Defaults F7: Load Optimized Defaults F10: Save & Exit	
Load Fail-Safe Defaults except Standard CMOS SETUP	

Figure 7: Load Fail-Safe Defaults

- **Load Fail-Safe Defaults**

Fail-Safe defaults contain the most appropriate system parameter values of to configure the system to achieve maximum stability.

Load Optimized Defaults

AMBIOS SIMPLE SETUP UTILITY-VERSION 1.24e (C) 1999 American Megatrends, Inc. All Rights Reserved	
STANDARD CMOS SETUP	INTEGRATED PERIPHERALS
BIOS FEATURES SETUP	HARDWARE MONITOR & MISC SETUP
CHIPSET FEATURES SETUP	SUPERVISOR PASSWORD
POWER MANAGE	
PNP/PCI CONFIG	Load Optimized Defaults (Y/N)?N
LOAD FAIL-SAFE DEFAULTS	SAVE & EXIT SETUP
LOAD OPTIMIZED DEFAULTS	EXIT WITHOUT SAVING
ESC : Quit ↑↓→← : Select Item (Shift) F2 : Change Color F5 : Old Values F6 : Load Fail-Safe Defaults F7: Load Optimized Defaults F10: Save & Exit	
Load Optimized Defaults except Standard CMOS SETUP	

Figure 8: Load Optimized Defaults

- **Load Optimized Defaults**

Optimized defaults contain the most appropriate system parameter values to configure the system to achieve maximum performance.

Integrated Peripherals

AMIBIOS SETUP – INTEGRATED PERIPHERALS (C) 1999 American Megatrends, Inc. All Rights Reserved		
OnBoard IDE	: Both	◆ Game Port (200h-207h) : Enabled
OnBoard FDC	: Auto	
OnBoard Serial Port 1	: Auto	
OnBoard Serial Port 2	: Auto	
Serial Port 2 Mode	: Normal	
*Duplex Mode	: N/A	
OnBoard Parallel Port	: Auto	
Parallel Port Mode	: ECP	
Parallel Port DMA	: Auto	
Parallel Port IRQ	: Auto	
◆ OnBoard AC'97 Audio	: Auto	
OnBoard MC'97 Modem	: Auto	
◆ OnBoard Legacy Audio	: Enabled	
◆ Sound Blaster	: Disabled	
◆ SB I/O Base Address	: 220h-22Fh	
◆ SB IRQ Select	: IRQ 5	
◆ SB DMA Select	: DMA 1	
◆ MPU-401	: Disabled	ESC: Quit ↑↓→←: Select Item
◆ MPU-401 I/O Address	: 330h-333h	F1 : Help PU/PD+/-/: Modify
◆ FM Port (388h-38Bh)	: Disabled	F5 :Old Values (Shift)F2:Color
		F6 : Load Fail-Safe Defaults
		F7 : Load Optimized Defaults

Figure 9: Integrated Peripherals

*This item will be available when "Serial Port 2 Mode" is set to IrDA or ASK IR.

◆ These ten items will not be shown when there is sound chip onboard.

● OnBoard IDE

Disabled	Disable OnBoard IDE.
Both	Both Primary & Secondary IDE channel will be enabled. (Default Value)
Primary	Only Primary IDE channel is enable.
Secondary	Only Secondary IDE channel is enable.

● OnBoard FDC

Disabled	Disable this function.
Enabled	Enable on board floppy disk controller.
Auto	Set the floppy disk controller automatically. (Default Value)

- **OnBoard Serial Port 1**

Auto	BIOS will automatically setup the port 1 address. (Default Value)
3F8/COM1	Enable OnBoard Serial port 1 and address is 3F8.
2F8/COM2	Enable OnBoard Serial port 1 and address is 2F8.
3E8/COM3	Enable OnBoard Serial port 1 and address is 3E8.
2E8/COM4	Enable OnBoard Serial port 1 and address is 2E8.
Disabled	Disable OnBoard Serial port 1.

- **OnBoard Serial Port 2**

Auto	BIOS will automatically setup the port 2 address. (Default Value)
3F8/COM1	Enable OnBoard Serial port 2 and address is 3F8.
2F8/COM2	Enable OnBoard Serial port 2 and address is 2F8.
3E8/COM3	Enable OnBoard Serial port 2 and address is 3E8.
2E8/COM4	Enable OnBoard Serial port 2 and address is 2E8.
Disabled	Disable OnBoard Serial port 2.

- **Serial Port 2 Mode**

(This item allows you to determine which Serial Port 2 Mode of onboard I/O chip)

Normal	Set onboard I/O chip Serial Port 2 to Normal Mode. (Default Value)
IrDA	Set onboard I/O chip Serial Port 2 to IrDA Mode.
ASK IR	Set onboard I/O chip Serial Port 2 to ASK IR Mode.

- **Duplex Mode**

Half Duplex	IR Function Duplex Half.
N/A	Disable this function. (Default Value)
Full Duplex	IR Function Duplex Full.

- **OnBoard Parallel port**

378	Enable OnBoard LPT port and address to 378.
278	Enable OnBoard LPT port and address to 278.
3BC	Enable OnBoard LPT port and address to 3BC.
Auto	Set OnBoard LPT port to Auto. (Default Value)
Disabled	Disable OnBoard LPT port.

- **Parallel Port Mode**

EPP	Using Parallel port as Enhanced Parallel Port.
ECP	Using Parallel port as Extended Capabilities Port. (Default Value)
Normal	Normal Operation.
EPP+ECP	Using Parallel port as Enhanced Parallel Port & Extended Capabilities Port.

- **Parallel Port DMA**

Auto	Set Auto to parallel port mode DMA Channel. (Default Value)
3	Set Parallel Port DMA to 3.
1	Set Parallel Port DMA to 1.
0	Set Parallel Port DMA to 0.

- **Parallel Port IRQ**

7	Set Parallel Port IRQ to 7.
Auto	Set Auto to parallel Port IRQ DMA Channel. (Default Value)
5	Set Parallel Port IRQ to 5.

- **OnBoard AC'97 Audio**

Auto	Enabled onboard AC'97 audio function. (Default Value)
Disabled	Disable this function.

- **OnBoard MC'97 Modem**

Auto	BIOS will search MC97 Codec (AMR Modem Card). If found, MC97 function will be enabled. If no MC97 Codec found, MC97 function will be disabled. (Default Value)
Disabled	Disable this function.

- **OnBoard Legacy Audio**

Enabled	Enable OnBoard Legacy Audio. (Default Value)
Disabled	Disable OnBoard Legacy Audio.

- **Sound Blaster**

Enabled	Enable Sound Blaster.
Disabled	Disable Sound Blaster. (Default Value)

- **SB I/O Base Address**

220h-22Fh	Set SB I/O Base Address to 220h-22Fh. (Default Value)
280h-28Fh	Set SB I/O Base Address to 280h-28Fh.
260h-26Fh	Set SB I/O Base Address to 260h-26Fh.
240h-24Fh	Set SB I/O Base Address to 240h-24Fh.

- **SB IRQ Select**

IRQ 5 / 7 / 9 / 10. (Default Value: 5)

- **SB DMA Select**

DMA 0 / 1 / 2 / 3. (Default Value: 1)
--

- **MPU-401**

Enabled	Enable MPU-401.
Disabled	Disable MPU-401. (Default Value)

Ps. When Force Feedback joystick is used, MPU-401 needs to be Enable.

- **MPU-401 I/O Address**

330h-333h	Set MPU-401 I/O Address to 330h-333h.
300h-303h	Set MPU-401 I/O Address to 300h-303h. (Default Value)
310h-313h	Set MPU-401 I/O Address to 310h-313h.
320h-323h	Set MPU-401 I/O Address to 320h-323h.

- **FM Port (388h-38Bh)**

Disabled	Disable FM Port (388h-38Bh). (Default Value)
Enabled	Enable FM Port (388h-38Bh).

- **Game Port (200h-207h)**

Disabled	Disable Game Port (200h-207h).
Enabled	Enable Game Port (200h-207h). (Default Value)

Hardware Monitor & MISC Setup

AMIBIOS SETUP – HARDWARE MONITOR & MISC SETUP (C) 1999 American Megatrends, Inc. All Rights Reserved	
Front Side Bus Clock	: By Jumper
ClkGen Spread Spectrum	: Enabled
Vcore Voltage	: Original
Current CPU Temp.	: 44°C/ 111°F
Current System Temp.	: 33°C/ 91°F
Current CPU Fan Speed	: 5273 RPM
Current System Fan Speed	: 0 RPM
Vcore	: 1.634V
+3.300V	: 3.321V
+5.000V	: 5.069V
+12.000V	: 12.045V
ESC: Quit ↑↓→←: Select Item F1 : Help PU/PD+/- : Modify F5 :Old Values (Shift)F2:Color F6 : Load Fail-Safe Defaults F7 : Load Optimized Defaults	

Figure 10: Hardware Monitor & MISC Setup

● Front Side Bus Clock

When set to By Jumper, the FSB clock will be set in accordance to DIP switch **CLK_SW** setting. You may also set FSB clock by BOS. **For power End-User use only.**

1. System Bus Speed: 66MHz

67 MHz ~ 99 MHz

2. System Bus Speed: 100MHz

100 MHz ~ 149 MHz

3. System Bus Speed: 133MHz

134 MHz ~ 199 MHz

● ClkGen Spread Spectrum

Enabled	Enable ClkGen Spread Spectrum. (Default Value)
Disabled	Disable ClkGen Spread Spectrum.

● **VCore Voltage**

The function provide CPU over voltage, Incorrect using it may cause your system damage.
For power End-User use only!

Original	Set VCore Voltage to Original. (Default Value)
1.675V	Set VCore Voltage to 1.675V.
1.700V	Set VCore Voltage to 1.700V.
1.725V	Set VCore Voltage to 1.725V.
1.750V	Set VCore Voltage to 1.750V.
1.775V	Set VCore Voltage to 1.775V.
1.800V	Set VCore Voltage to 1.800V.
1.825V	Set VCore Voltage to 1.825V.

● **Current CPU/System Temp.**

Detect CPU/System Temp. automatically.

● **Current CPU Fan / System Fan Speed (RPM)**

Detect Fan speed status automatically.

● **Voltage (V) Vcore / +3.300V / +5.000V / +12.000V**

Detect system's voltage status automatically.

Supervisor / User Password

When you select this function, the following message will appear at the center of the screen to assist you in creating a password.

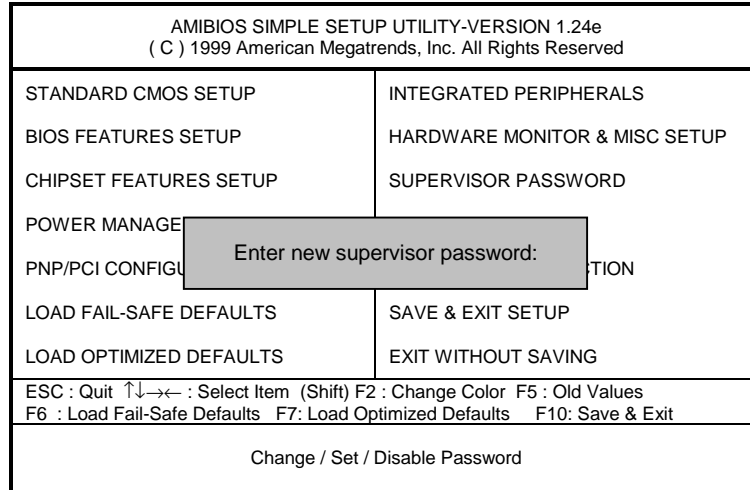

Figure 11: Password Setting

Type the password, up to six characters, and press <Enter>. You will be asked to confirm the password. Type the password again and press <Enter>. You may also press <Esc> to abort the selection and not enter a password.

To disable password, just press <Enter> when you are prompted to enter password. A message **"PASSWORD DISABLED"** will appear to confirm the password being disabled. Once the password is disabled, the system will boot and you can enter Setup freely.

The BIOS Setup program allows you to specify two separate passwords: a **SUPERVISOR PASSWORD** and a **USER PASSWORD**. When disabled, anyone may access all BIOS Setup program function. When enabled, the Supervisor password is required for entering the BIOS Setup program and having full configuration fields, the User password is required to access only basic items.

If you select **"Always"** at **"Password Check"** in BIOS Features Setup Menu, you will be prompted for the password every time the system is rebooted or any time you try to enter Setup Menu.

If you select **"Setup"** at **"Password Check"** in BIOS Features Setup Menu, you will be prompted only when you try to enter Setup.

IDE HDD Auto Detection

AMIBIOS SETUP – STANDARD CMOS SETUP (C) 1999 American Megatrends, Inc. All Rights Reserved							
Date (mm/dd/yyyy) : Tue Mar 27, 2001 Time (hh/mm/ss) : 10:36:24							
TYPE	SIZE	CYLS	HEAD	PRECOMP	LANDZ	SECTOR	MODE
Pri Master : Not Installed Pri Slave : Not Installed Sec Master : Not Installed Sec Slave : Not Installed							
Floppy Drive A: 1.44 MB 3 ½				Base Memory : 640 Kb			
Floppy Drive B: Not Installed				Other Memory: 384 Kb			
Boot Sector Virus Protection : Disabled				Extended Memory: 63Mb			
				Total Memory: 64Mb			
Month: Jan – Dec				ESC : Exit			
Day: 01 – 31				↑↓ : Select Item			
Year: 1990– 2099				PU/PD/+/- : Modify			
				(Shift)F2 : Color			

Figure 12: IDE HDD Auto Detection

Type "Y" will accept the H.D.D. parameter reported by BIOS.

Type "N" will keep the old H.D.D. parameter setup. If the hard disk cylinder number is over 1024, then the user can select LBA mode or LARGER mode for DOS partition larger than 528 MB.

Save & Exit Setup

AMIBIOS SIMPLE SETUP UTILITY-VERSION 1.24e (C) 1999 American Megatrends, Inc. All Rights Reserved	
STANDARD CMOS SETUP	INTEGRATED PERIPHERALS
BIOS FEATURES SETUP	HARDWARE MONITOR & MISC SETUP
CHIPSET FEATURES SETUP	SUPERVISOR PASSWORD
POWER MANAGE	SAVE to CMOS and EXIT(Y/N)? Y
PNP/PCI CONFIG	
LOAD FAIL-SAFE DEFAULTS	SAVE & EXIT SETUP
LOAD OPTIMIZED DEFAULTS	EXIT WITHOUT SAVING
ESC : Quit ↑↓→← : Select Item (Shift) F2 : Change Color F5 : Old Values F6 : Load Fail-Safe Defaults F7: Load Optimized Defaults F10: Save & Exit	
Save Data to CMOS & Exit SETUP	

Figure 13: Save & Exit Setup

Type "Y" will quit the Setup Utility and save the user setup value to RTC CMOS.

Type "N" will return to Setup Utility.

Exit Without Saving

AMBIOS SIMPLE SETUP UTILITY-VERSION 1.24e (C) 1999 American Megatrends, Inc. All Rights Reserved	
STANDARD CMOS SETUP	INTEGRATED PERIPHERALS
BIOS FEATURES SETUP	HARDWARE MONITOR & MISC SETUP
CHIPSET FEATURES SETUP	SUPERVISOR PASSWORD
POWER MANAGEMENT SETUP	USER PASSWORD
PNP/PCI CONFIGURATION	LOAD FAIL-SAFE DEFAULTS
LOAD OPTIMIZED DEFAULTS	SAVE & EXIT SETUP
	EXIT WITHOUT SAVING
ESC : Quit ↑↓→← : Select Item (Shift) F2 : Change Color F5 : Old Values F6 : Load Fail-Safe Defaults F7: Load Optimized Defaults F10: Save & Exit	
Abandon all Datas & Exit SETUP	

Figure 14: Exit Without Saving

Type "Y" will quit the Setup Utility and save the user setup value to RTC CMOS.

Type "N" will return to Setup Utility.

Technical Support/RMA Sheet

Customer/Country:	Company:	Phone No.:
Contact Person:	E-mail Add. :	

Model name/Lot Number:	PCB revision:
BIOS version:	O.S./A.S.:

Hardware Configuration	Mfs.	Model name	Size:	Driver/Utility:
CPU				
Memory Brand				
Video Card				
Audio Card				
HDD				
CD-ROM / DVD-ROM				
Modem				
Network				
AMR / CNR				
Keyboard				
Mouse				
Power supply				
Other Device				

 Problem Description:

Appendix

Picture below are shown in Windows ME (TUCD driver version 1.72)
Appendix A: VIA Chipsets Driver Installation

A. VIA 4 in 1 Service Pack Driver:

Insert the driver CD-title that came with your motherboard into your CD-ROM driver, the driver CD-title will auto start and show the installation guide. If not, please double click the CD-ROM device icon in "My computer", and execute the setup.exe.

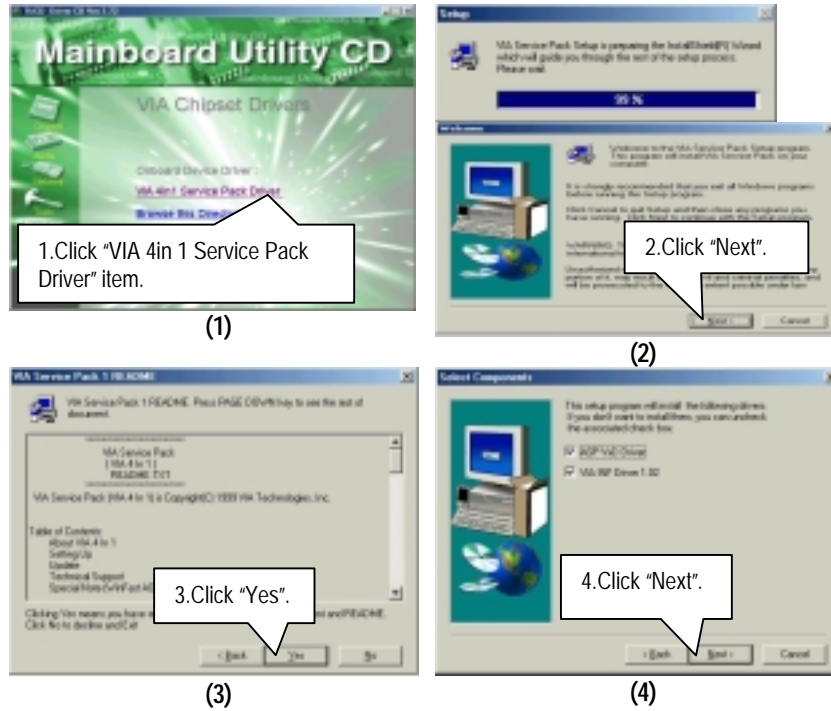

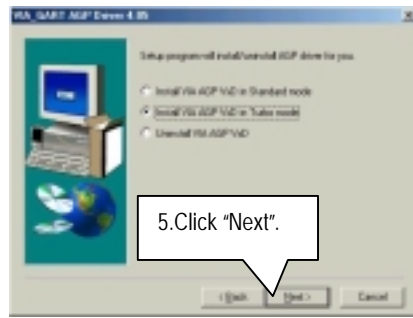

(5)

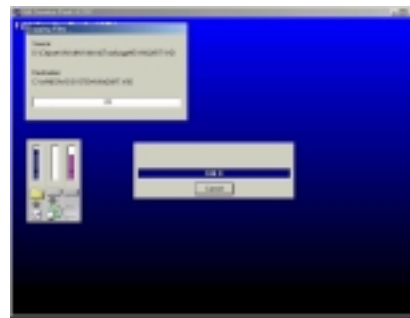

(6)

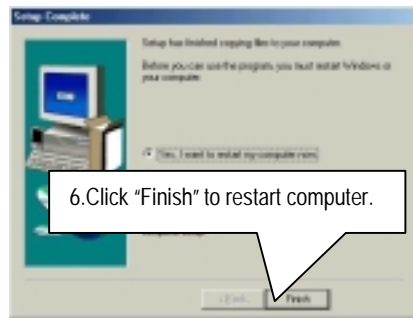

(7)

Appendix B: Creative Sound Driver Installation (Optional)

Insert the driver CD-title that came with your motherboard into your CD-ROM driver, the driver CD-title will auto start and show the installation guide. If not, please double click the CD-ROM device icon in "My computer", and execute the setup.exe.



(1)

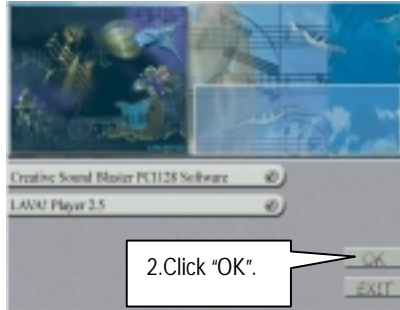

If "LAVA! Player 2.5" item is selected, it will automatically be installed right after "Creative Sound Blaster PCI128 Software" installation.

(2)

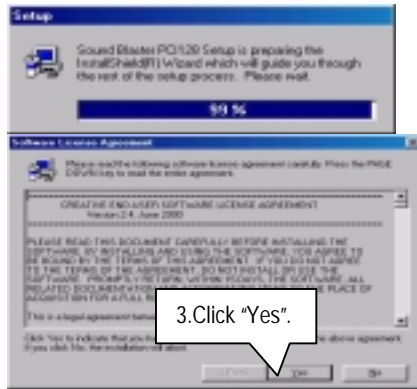

(3)

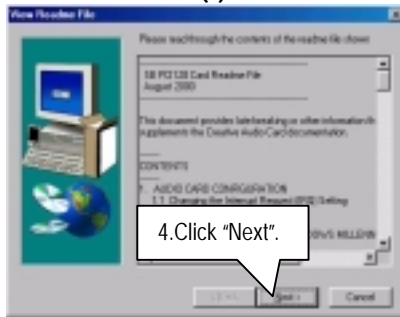

(4)

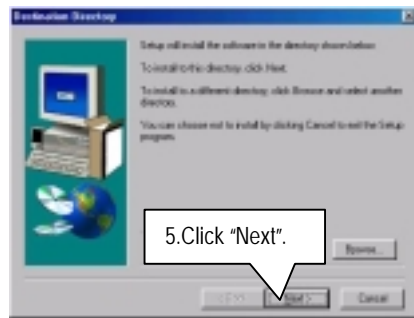

(5)

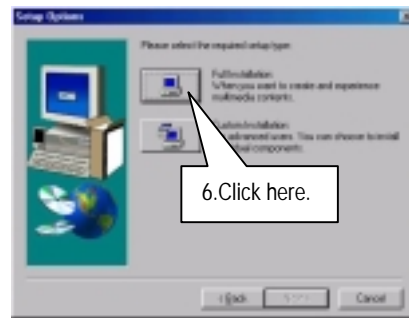

(6)

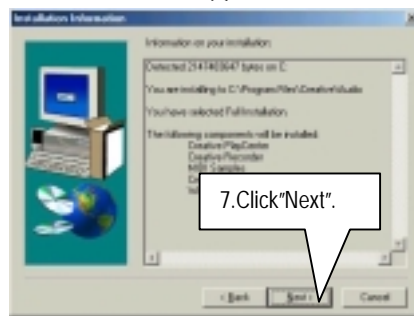

(7)

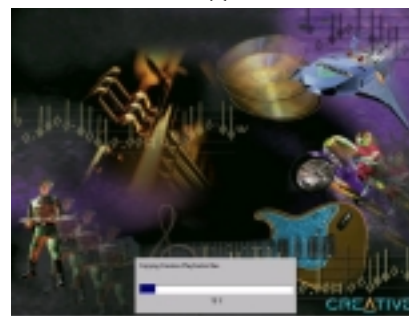

(8)

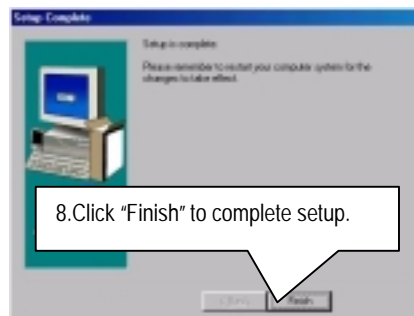

(9)

LAVA! Player Installation:

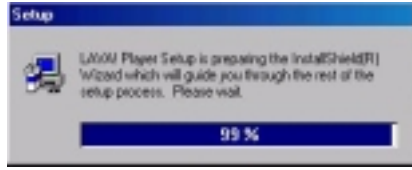

(1)

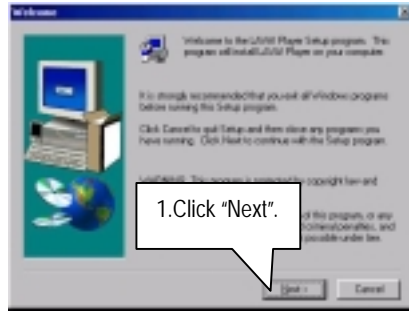

(2)

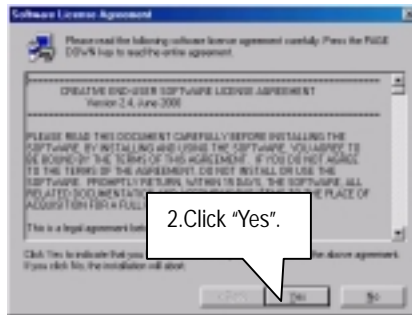

(3)

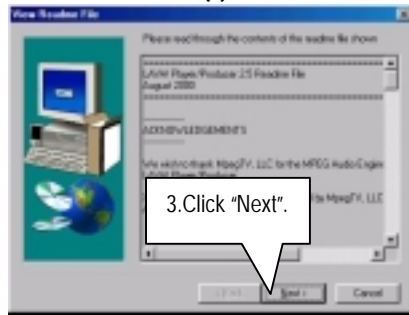

(4)

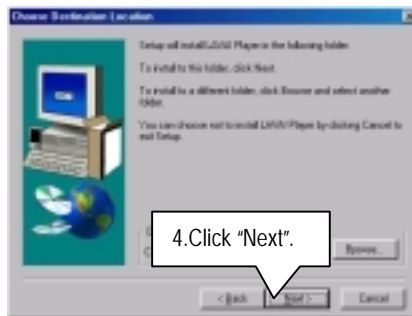

(5)



(6)

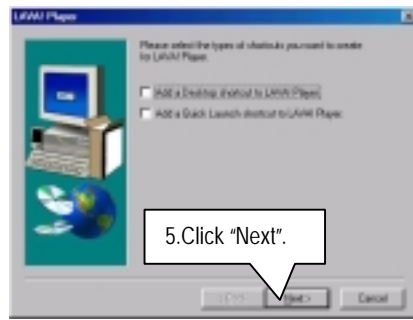

(7)

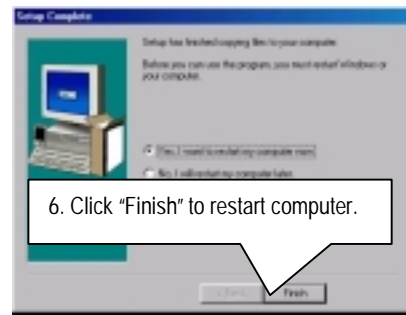

(8)

Appendix C: VIA AC'97 Audio Driver

Insert the driver CD-title that came with your motherboard into your CD-ROM driver, the driver CD-title will auto start and show the installation guide. If not, please double click the CD-ROM device icon in "My computer", and execute the setup.exe.

1. Click "VIA AC'97 Audio Driver".

2. Click "Next".

3. Click "Next".

4. Click "Next".

5. Click "OK".

6. Click "Finish".

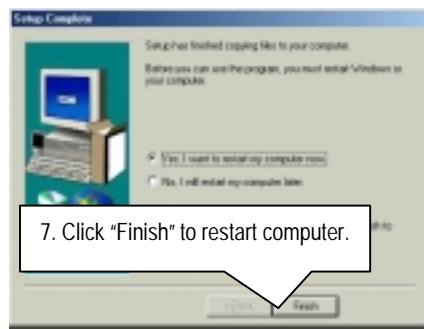

(7)

Appendix D: EasyTuneIII Utilities Installation

Insert the driver CD-title that came with your motherboard into your CD-ROM driver, the driver CD-title will auto start and show the installation guide. If not, please double click the CD-ROM device icon in "My computer", and execute the setup.exe.

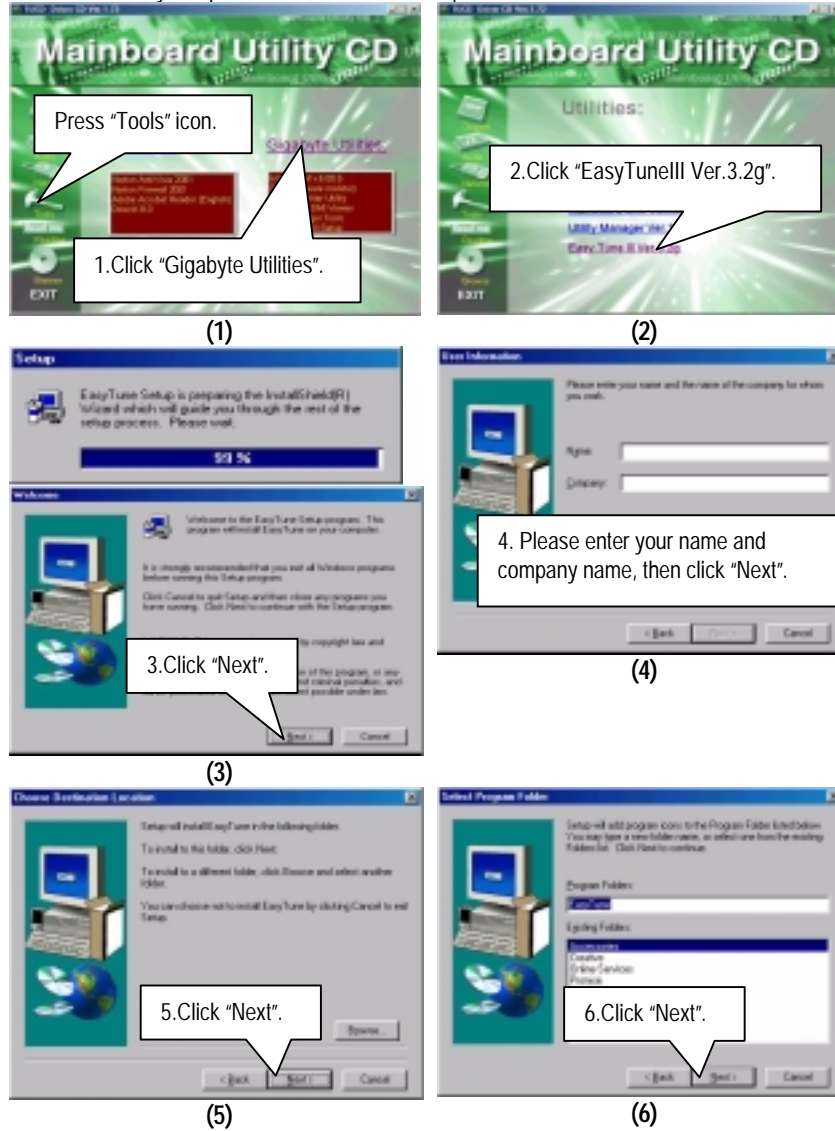

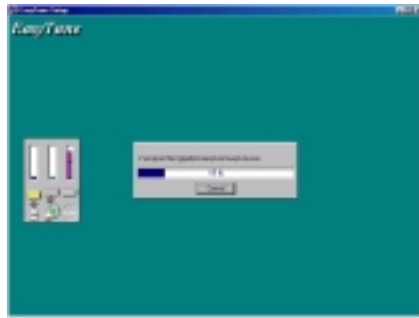

(7)

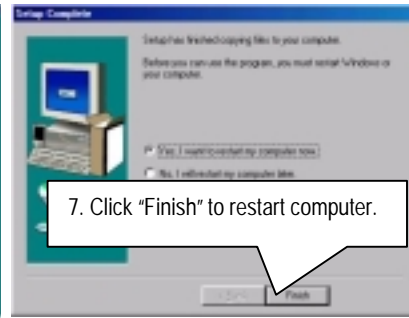

(8)

Appendix E: BIOS Flash Procedure

BIOS update procedure:

If your OS is Win9X, we recommend that you used Gigabyte @BIOS™ Program to flash BIOS.

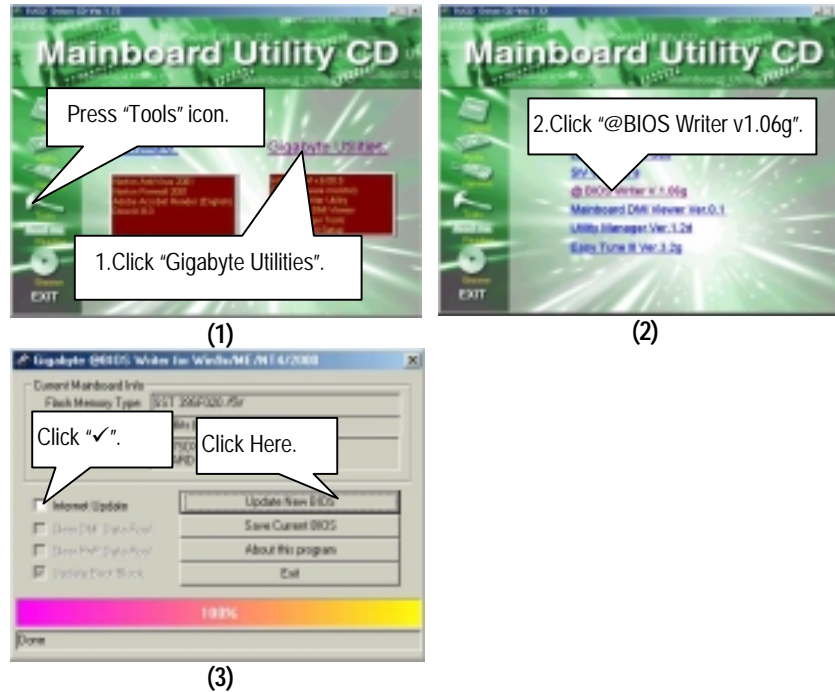

Methods and steps:

- I. Update BIOS through Internet
 - a. Click "Internet Update" icon
 - b. Click "Update New BIOS" icon
 - c. Select @BIOS™ sever ("Gigabyte @BIOS™ sever 1 in Taiwan" and "Gigabyte @BIOS™ sever 2 in Taiwan" are available for now, the others will be completed soon)
 - d. Select the exact model name on your motherboard
 - e. System will automatically download and update the BIOS.

II. Update BIOS **NOT** through Internet:

- a. **Do not** click "Internet Update" icon
- b. Click "Update New BIOS"
- c. Please select "All Files" in dialog box while opening the old file.
- d. Please search for BIOS unzip file, downloading from internet or any other methods (such as: 6VTX.F1).
- e. Complete update process following the instruction.

III. Save BIOS

In the very beginning, there is "Save Current BIOS" icon shown in dialog box. It means to save the current BIOS version.

IV. Check out supported motherboard and Flash ROM:

In the very beginning, there is "About this program" icon shown in dialog box. It can help you check out which kind of motherboard and which brand of Flash ROM are supported.

Note:

- a. In method I, if it shows two or more motherboard's model names to be selected, please make sure your motherboard's model name again. Selecting wrong model name will cause the system unbooted.
- b. In method II, be sure that motherboard's model name in BIOS unzip file are the same as your motherboard's. Otherwise, your system won't boot.
- c. In method I, if the BIOS file you need cannot be found in @BIOS™ server, please go onto Gigabyte's web site for downloading and updating it according to method II.
- d. Please note that any interruption during updating will cause system unbooted

Or else you can select flash BIOS in DOS mode.

☛ Please check your **BIOS vendor (AMI or AWARD)**, your **motherboard name** and **PCB version** on the motherboard.

1. Format a bootable system floppy diskette by the command "**format a:/s**" in command mode.
2. Visit the Gigabyte website at [http:// www.gigabyte.com.tw](http://www.gigabyte.com.tw) , Select the BIOS file you need and download it to your bootable floppy diskette.
3. Insert the bootable diskette containing the BIOS file into the floppy diskette driver.
4. Assuming that the floppy diskette driver is A, reboot the system by using the A: driver. At the A: > prompt, run the BIOS upgraded file by executing the Flash BIOS utility and the BIOS file with its appropriate extension.

Example: (AMI tool) (Where 6vtx.f1 is name of the BIOS file name)

```
A:>flashxxx.exe 6vtx.f1 ↵
```

Example: (Award tool) (Where 6vtx.f1 is name of the BIOS file name)

```
A:>Awdflash.exe 6vtx.f1 ↵
```

5. Upon pressing the <Enter> key, a flash memory writer menu will appear on screen. Enter the new BIOS file name with its extension filename into the text box after file name to program.
6. If you want to save the old BIOS file(perform as soon as system is operational, this is recommended), select Y to **DO YOU WANT TO SAVE BIOS**, then type the old BIOS filename and the extension after filename to save: This option allows you to copy the contents of the flash memory chip onto a diskette, giving you a backup copy of the original motherboard BIOS in case you need to re-install it. Select N to **DO YOU WANT TO SAVE BIOS**, if you don't want to save the old BIOS file.
7. After the decision to save the old BIOS file or not is made, select Y to **ARE YOU SURE TO PROGRAM** when the next menu appear; wait until a message showing Power Off or Reset the system appears. Then turn off your system.
8. Remove the diskette and restart your system.
9. Hold down <Delete> key to enter BIOS setup. You must select "Load Setup BIOS Default" to activate the new BIOS, then you may set other item from the main menu.

Appendix F: Acronyms

Acronyms	Meaning
ACPI	Advanced Configuration and Power Interface
APM	Advanced Power Management
AGP	Accelerated Graphics Port
AMR	Audio Modem Riser
ACR	Advanced Communications Riser
BIOS	Basic Input / Output System
CPU	Central Processing Unit
CMOS	Complementary Metal Oxide Semiconductor
CRIMM	Continuity RIMM
CNR	Communication and Networking Riser
DMA	Direct Memory Access
DMI	Desktop Management Interface
DIMM	Dual Inline Memory Module
DRM	Dual Retention Mechanism
DRAM	Dynamic Random Access Memory
DDR	Double Data Rate
ECP	Extended Capabilities Port
ESCD	Extended System Configuration Data
ECC	Error Checking and Correcting
EMC	Electromagnetic Compatibility
EPP	Enhanced Parallel Port
ESD	Electrostatic Discharge
FDD	Floppy Disk Device
FSB	Front Side Bus
HDD	Hard Disk Device
IDE	Integrated Dual Channel Enhanced
IRQ	Interrupt Request
I/O	Input / Output
IOAPIC	Input Output Advanced Programmable Input Controller
ISA	Industry Standard Architecture
LAN	Local Area Network
LBA	Logical Block Addressing
LED	Light Emitting Diode
MHz	Megahertz
MIDI	Musical Interface Digital Interface
MTH	Memory Translator Hub
MPT	Memory Protocol Translator

To be continued...

Acronyms	Meaning
NIC	Network Interface Card
OS	Operating System
OEM	Original Equipment Manufacturer
PAC	PCI A.G.P. Controller
POST	Power-On Self Test
PCI	Peripheral Component Interconnect
RIMM	Rambus in-line Memory Module
SCI	Special Circumstance Instructions
SECC	Single Edge Contact Cartridge
SRAM	Static Random Access Memory
SMP	Symmetric Multi-Processing
SMI	System Management Interrupt
USB	Universal Serial Bus
VID	Voltage ID