

6SMM7

USER'S MANUAL

- 1. System power on by Keyboard: If your ATX power supply supports larger than 300 mA 5V Stand-By current (dependent on the specification of keyboards), you can power on your system by entering password from the Keyboard after setting the “Keyboard power on” jumper (JP2) and password in CMOS Setup.**
- 2. Support Modem Ring-On. (Include internal Modem and external modem on COM A & COM B)**
- 3. Support Wake-up On LAN. (Your ATX power supply must support larger than 720 mA 5V Stand-By current)**
- 4. ESS SOLO 1 PCI Sound onboard.**
- 5. SIS 620 graphics acceleration onboard**

Celeron™ Socket 370 Processor MAINBOARD
REV. 1.1 First Edition
R-11-01-090519

The author assumes no responsibility for any errors or omissions that may appear in this document nor does it make a commitment to update the information contained herein.

Third-party brands and names are the property of their respective owners.

Sound Blaster is a registered trademark of Creative Technology Ltd in the United States and certain other countries. Sound Blaster-LINK and SB-LINK are trademarks of Creative Technology Ltd.

May. 19, 1999 Taipei, Taiwan

I. Quick Installation Guide :

CPU SPEED SETUP

The system bus frequency can be switched between 66MHz and 133MHz by adjusting DIP SW2. The CPU frequency ratio can be switched from X3 to X8 by adjusting DIP SW1. The user can set up CPU speed for 366~533MHz processors by adjusting SW1 and SW2 properly.

● The CPU speed must match with the frequency RATIO. It will cause system hanging up if the frequency RATIO is higher than that of CPU.

SW1: (O:ON / X:OFF)

CLK RATIO	1	2	3	4
X3	ON	ON	ON	OFF
X3.5	ON	OFF	ON	OFF
X4	ON	ON	OFF	ON
X4.5	ON	OFF	OFF	ON
X5	ON	ON	OFF	OFF
X5.5	ON	OFF	OFF	OFF
X6	OFF	ON	ON	ON
X6.5	OFF	OFF	ON	ON
X7	OFF	ON	ON	OFF
X7.5	OFF	OFF	ON	OFF
X8	OFF	ON	OFF	ON

Set System Bus Speed

SW2: (O:ON / X:OFF)

CPU	1	2	3	4
66	O	O	O	X
75	X	O	O	X
83	O	X	O	X
100	O	O	X	X
112	X	O	X	X
133	X	X	X	X

★ **Note:** Please set the CPU host frequency in accordance with your processor's specifications. We don't recommend you to set the system bus frequency over the CPU's specification because these specific bus frequencies are not the standard specifications for CPU, chipset and most of the peripherals. Whether your system can run under these specific bus frequencies properly will depend on your hardware configurations, including CPU, Chipsets, SDRAM, Cards...etc.

☞ The black part in the picture is the white extruding piece of the DIP switch.

1. Celeron™ 366 MHz / 66MHz FSB

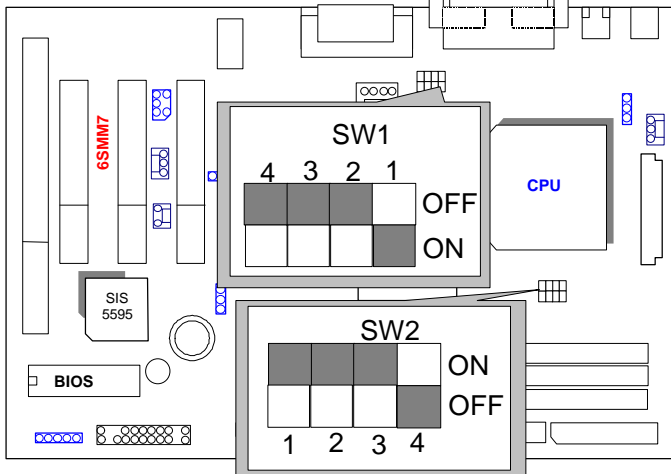

2. Celeron™ 400 MHz / 66MHz FSB

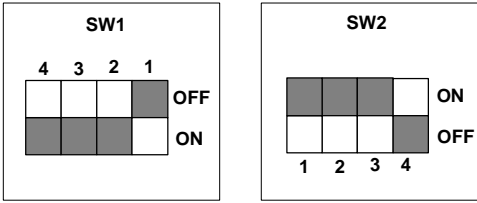

3. Celeron™ 433 MHz / 66MHz FSB

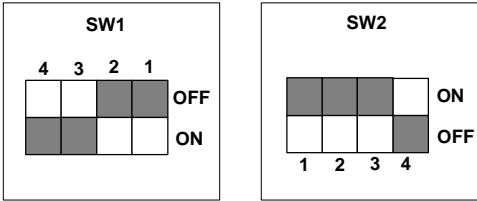

4. Celeron™ 466/ 66 MHz FSB

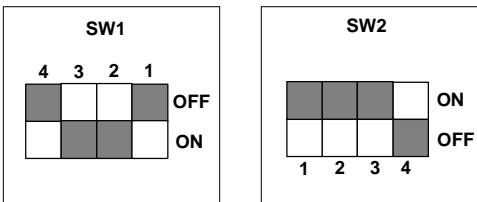

5. Celeron™ 500/ 66 MHz FSB

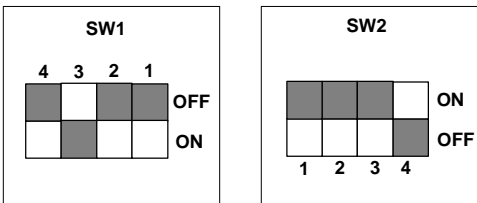

6. Celeron™ 533/ 66 MHz FSB

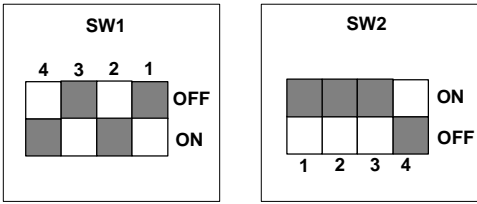

II. Jumper setting :

GN : Green Function Switch

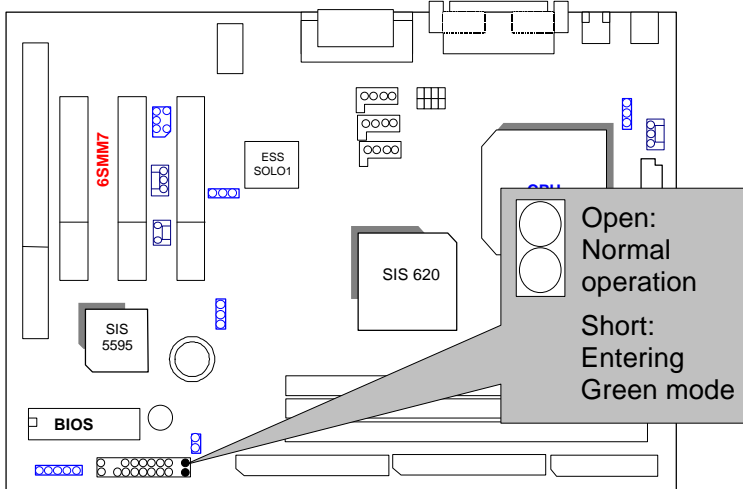

GD : Green Function LED

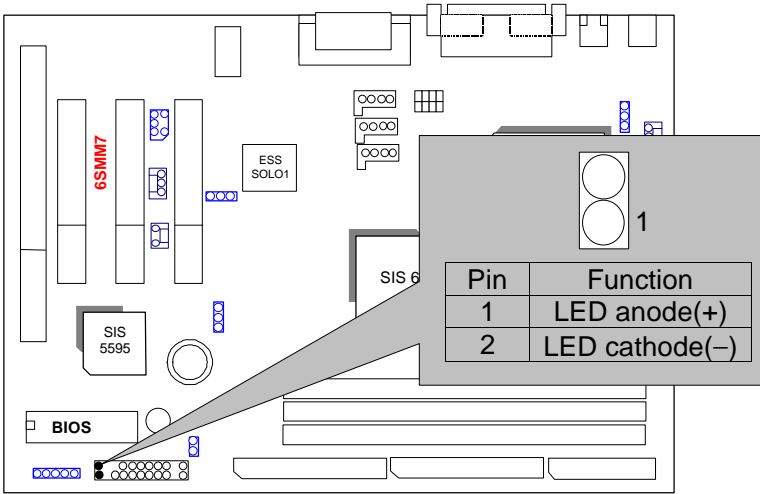

HD : IDE Hard Disk Active LED

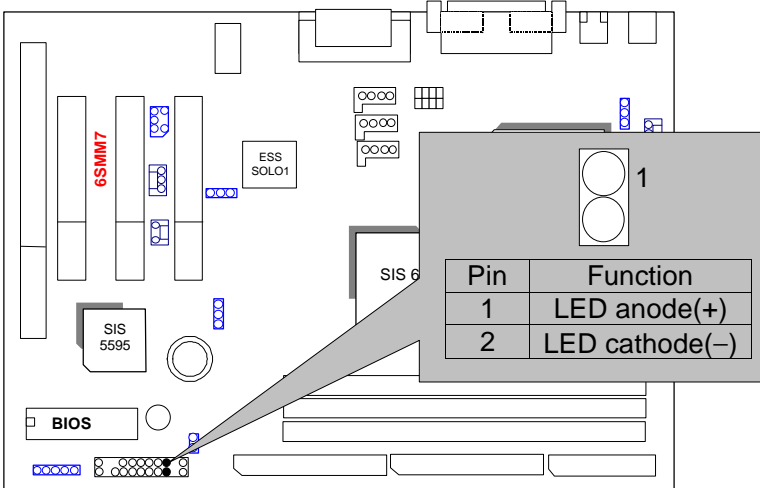

SPK : Speaker Connector

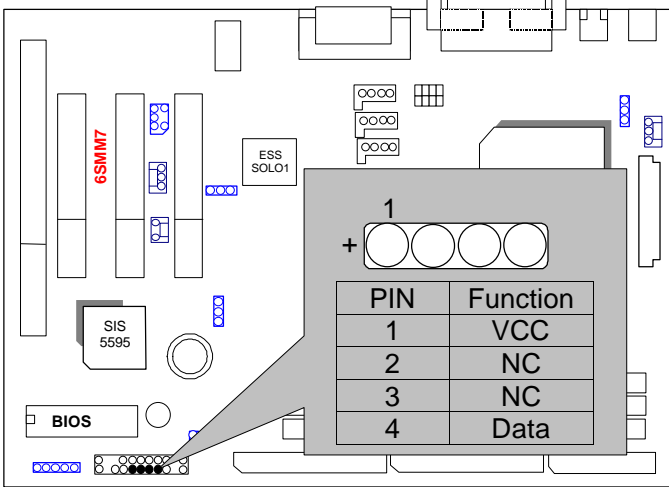

RE : Reset Switch

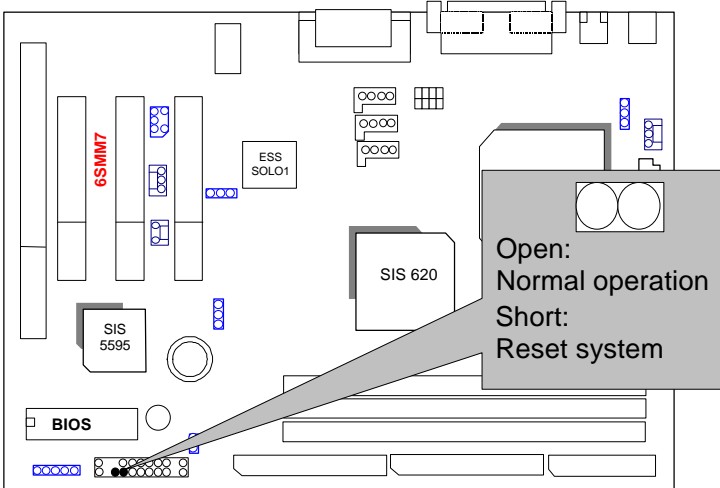

PWR : Power LED Connector (as 3 steps ACPI LED)

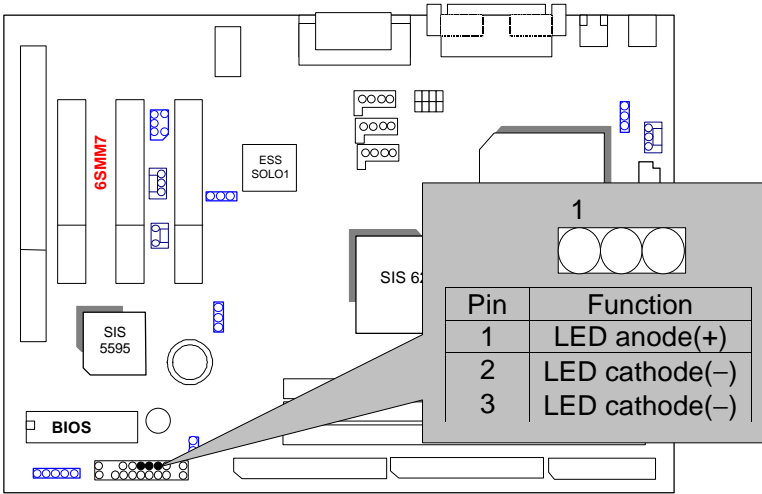

PW: Soft Power Connector

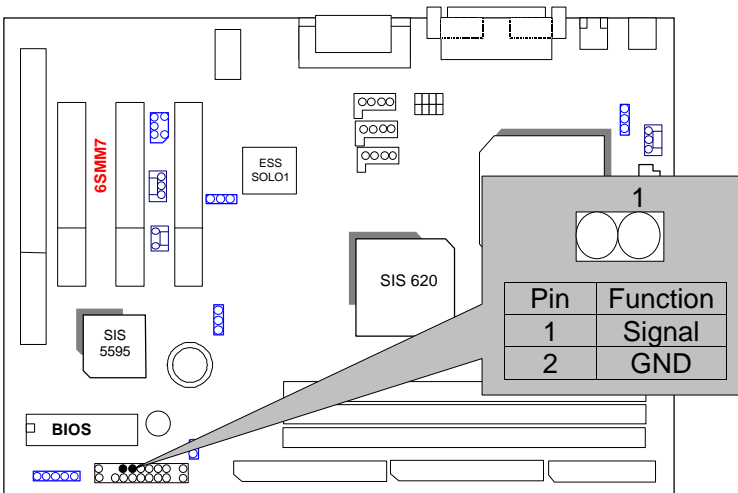

IR: Infrared Connector (Optional)

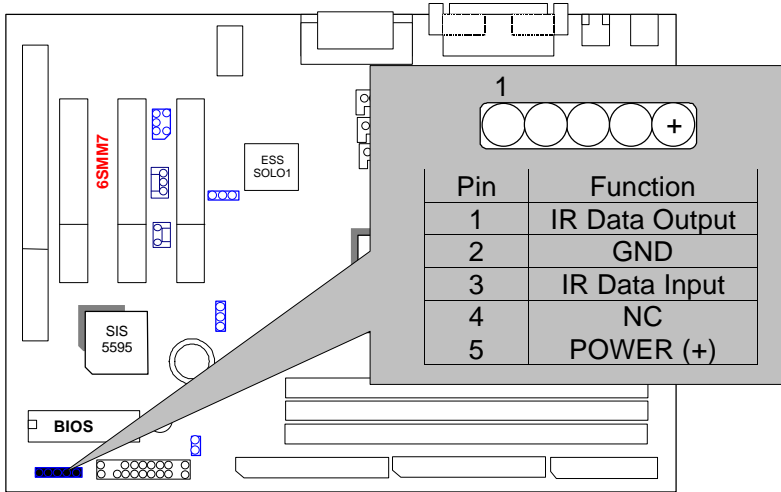

J7 : Internal Buzzer Connector (Optional)

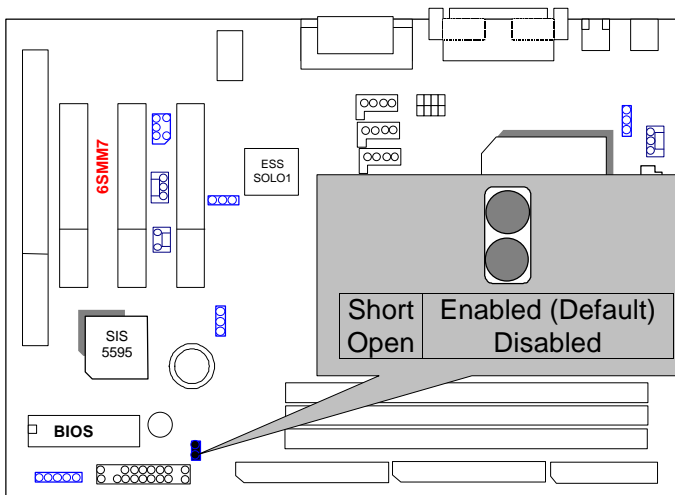

PS/2 Mouse / Keyboard Connector

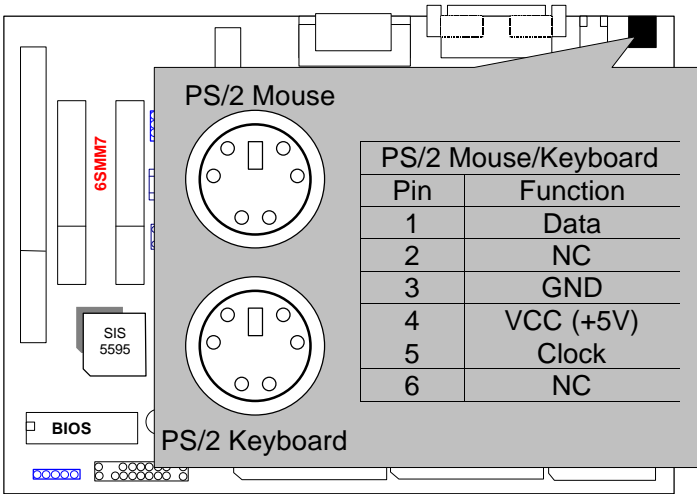

JP1:CPU FAN : CPU Cooling Fan Power Connector

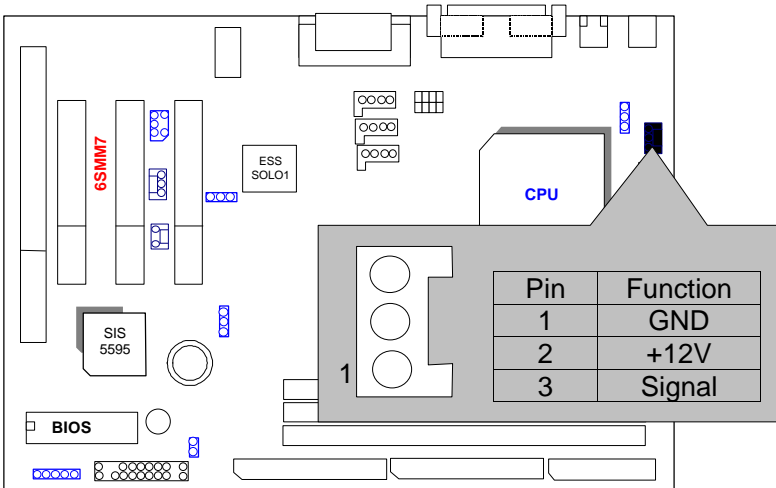

IDE1: For Primary IDE port

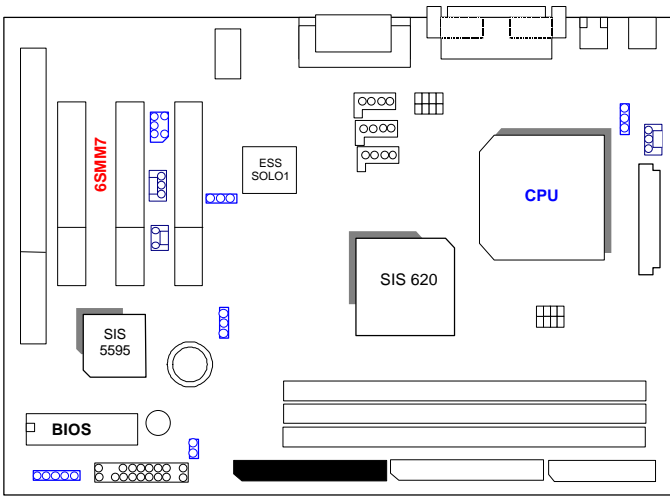

IDE2: For Secondary IDE port

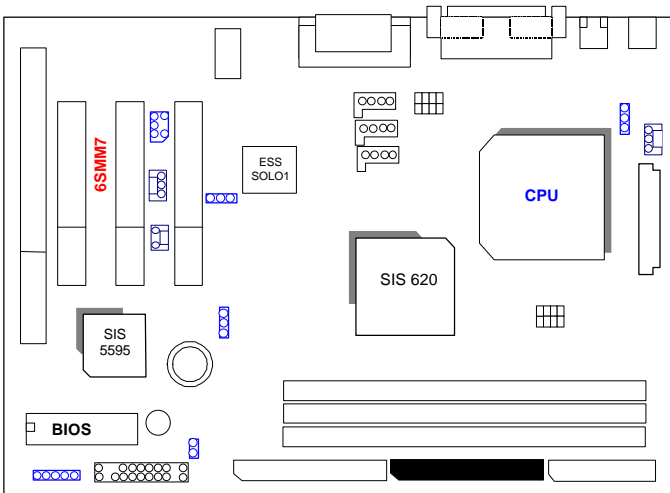

FLOPPY : FLOPPY PORT

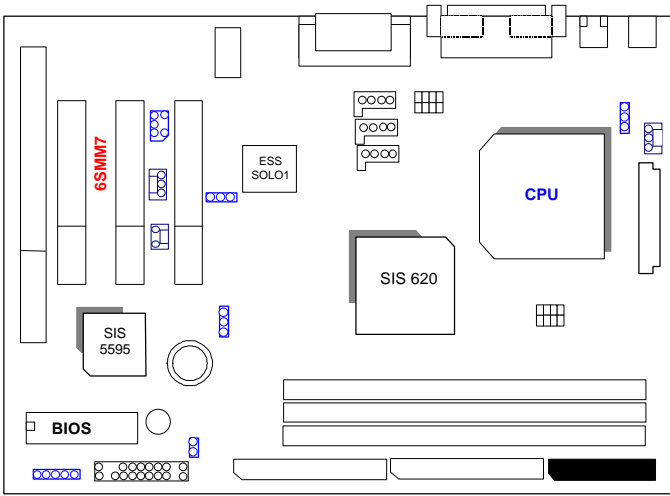

ATX POWER : ATX POWER Connector

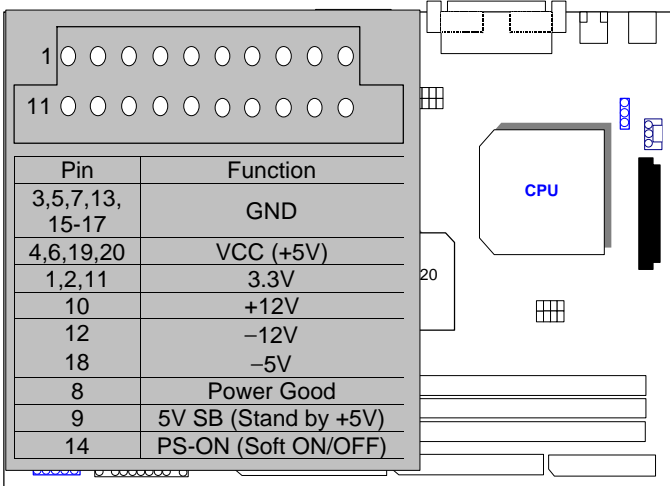

LPT PORT / COM A / COM B / VGA PORT

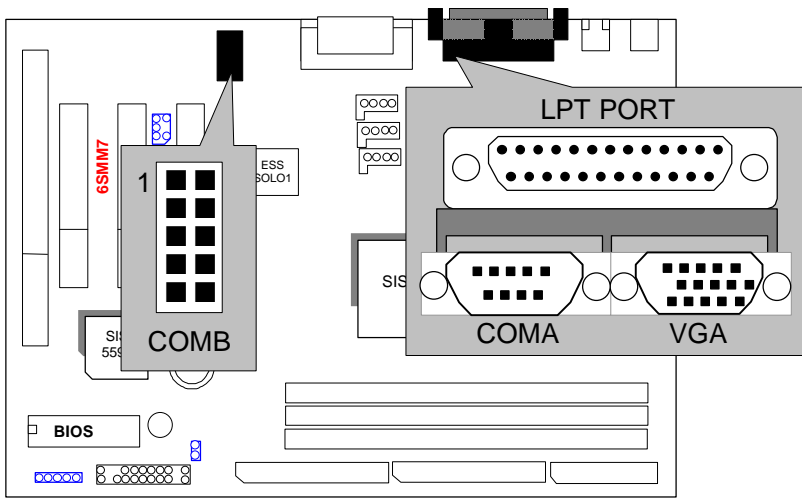

GAME & AUDIO PORT

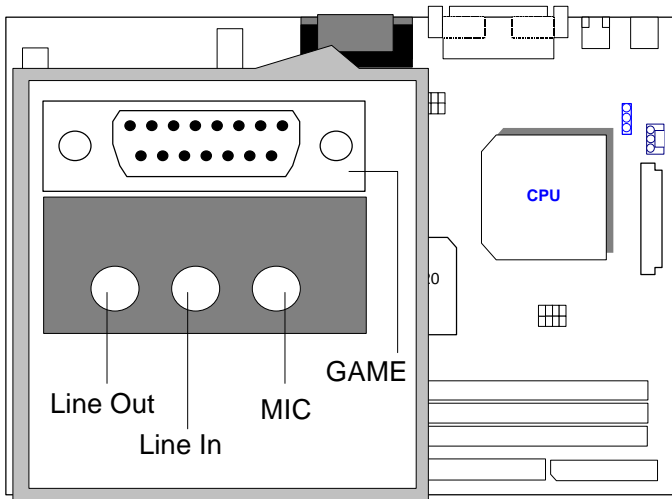

JP2 : Keyboard Power On

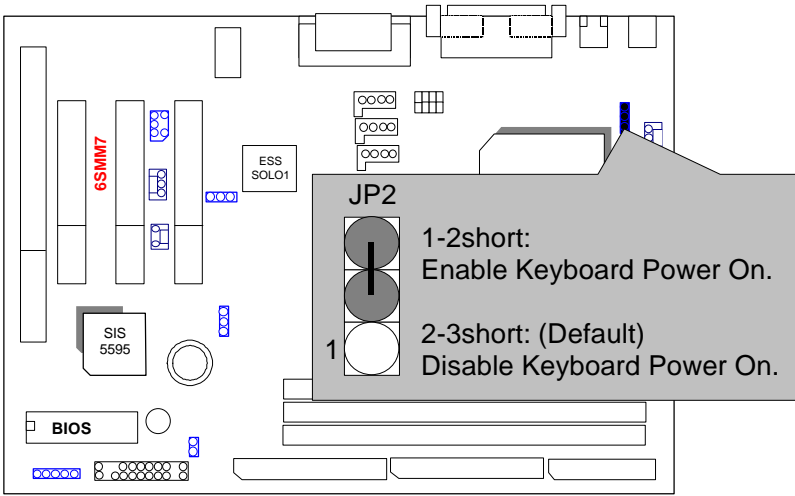

USB: USB Port

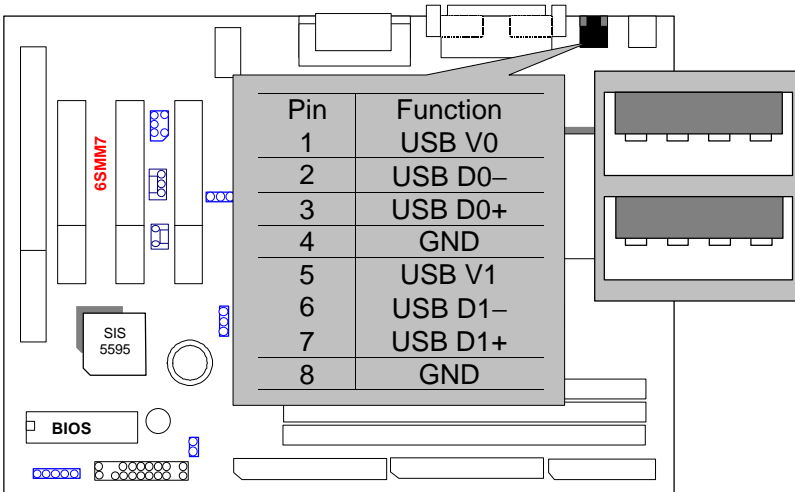

JP9: Wake on LAN

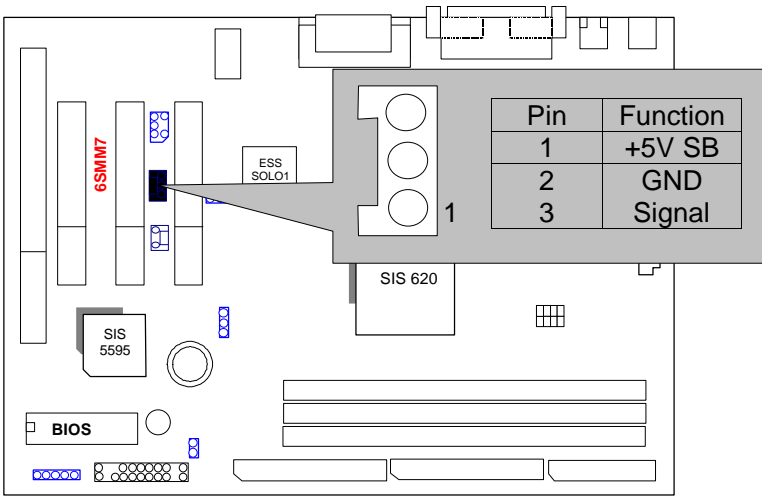

J6 :CD Audio Line In

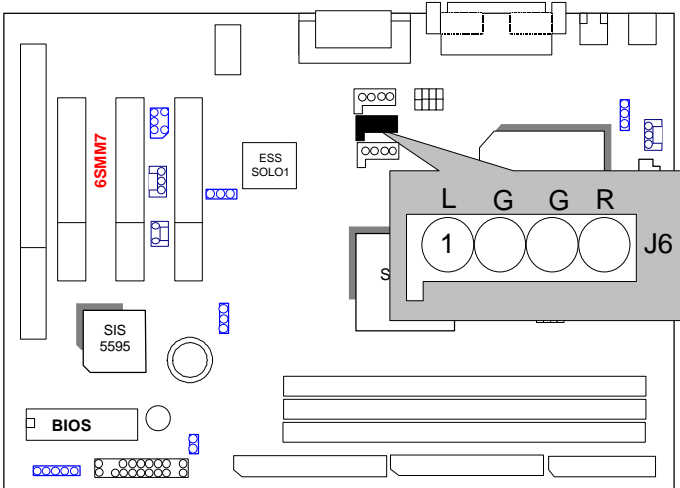

JP5: Onboard Sound Function Selection

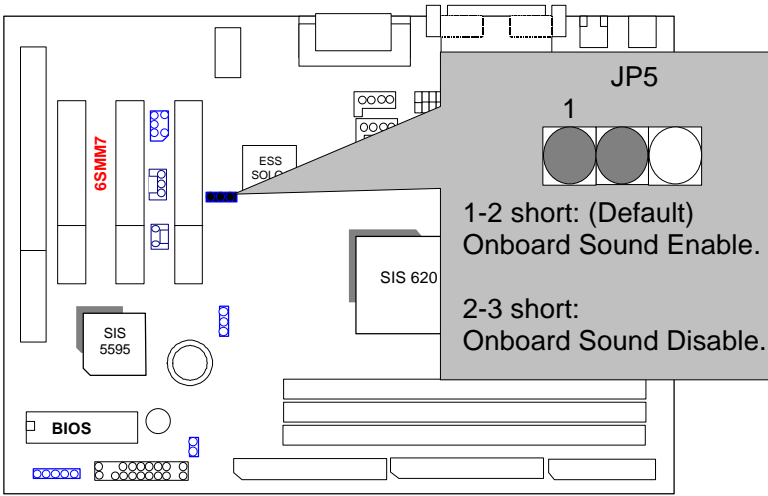

JP10: Internal Modem Card Ring PWR On

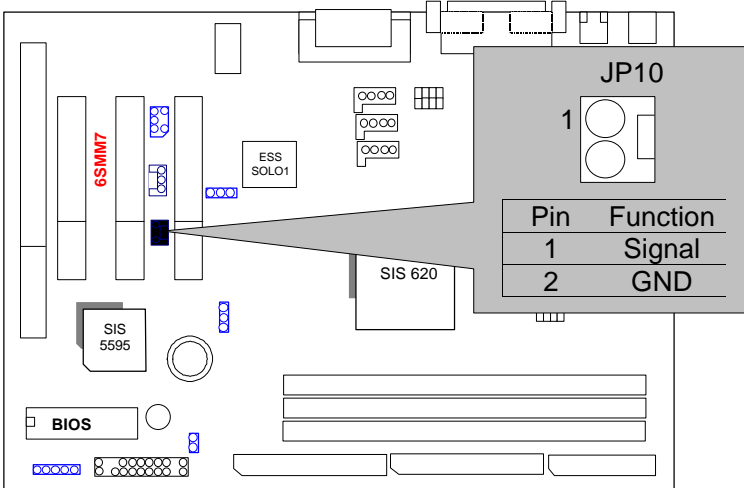

JP8 : SB-LINK (Creative PCI Sound Card Support) (Optional)

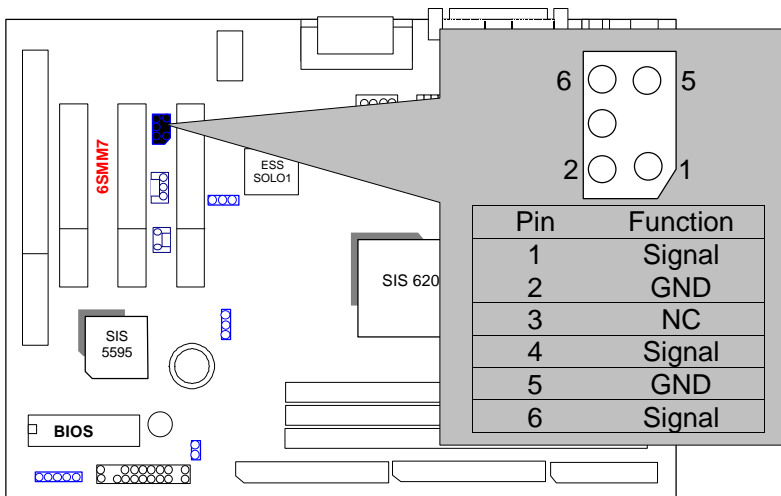

JP6: CLEAR CMOS Function

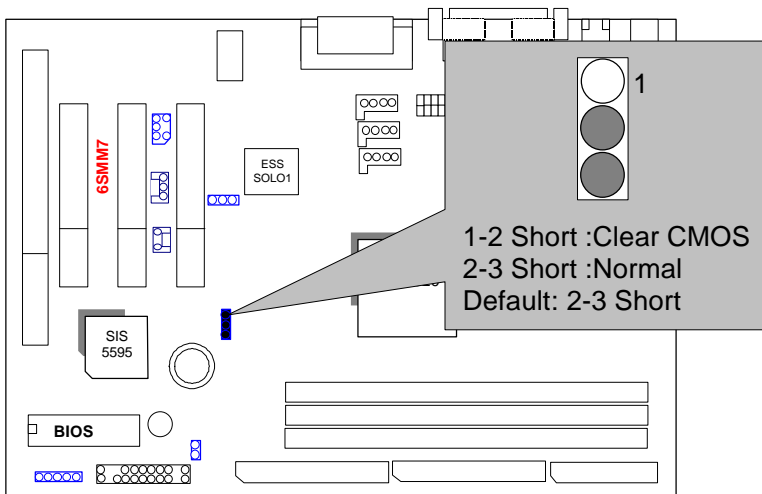

TEL: The connector is for Modem with internal voice connector.

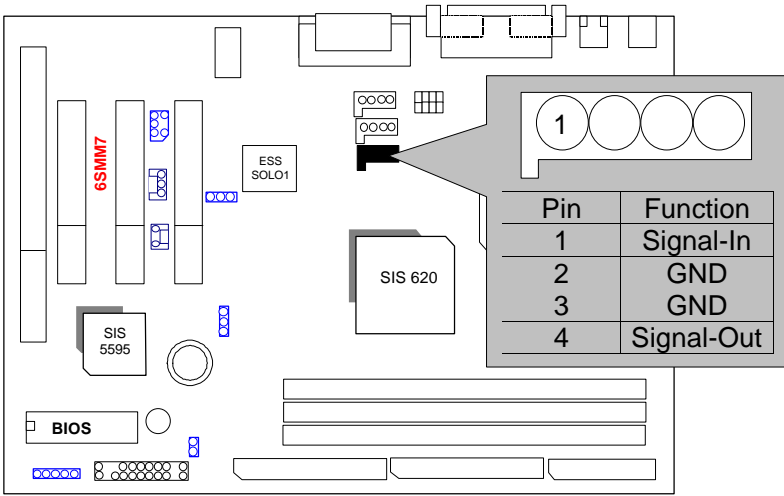

J8 :AUX IN

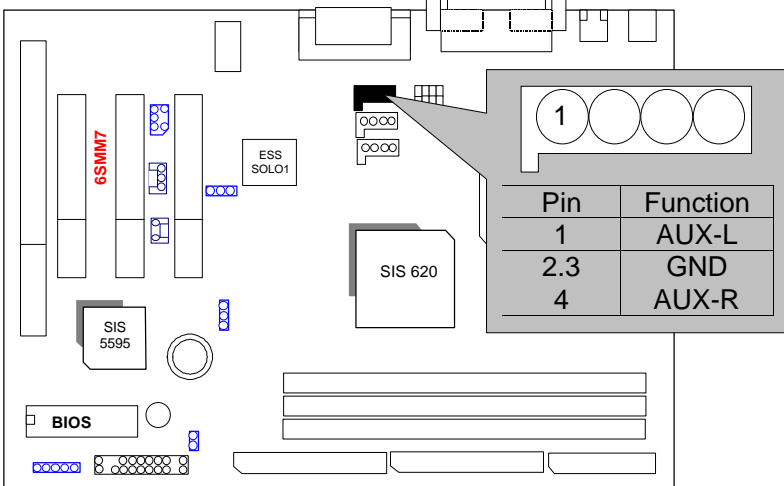

BAT1:For Battery

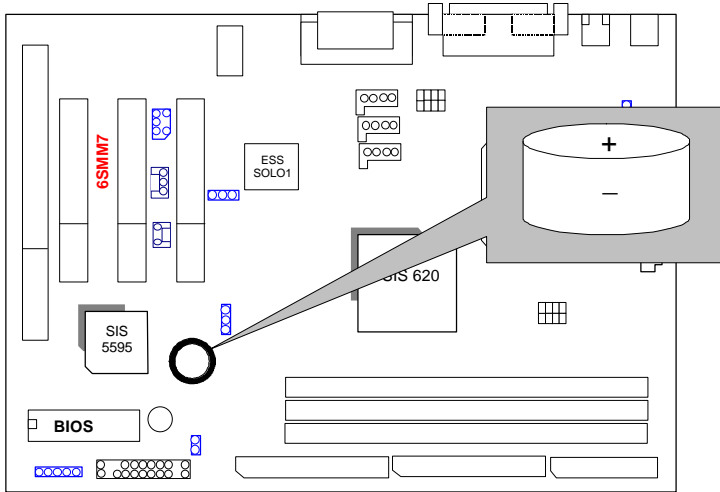

- Danger of explosion if battery is incorrectly replaced.
- Replace only with the same or equivalent type recommended by the manufacturer.
- Dispose of used batteries according to the manufacturer's instructions.

III. Top Performance Test Setting:

The following performance data list is the testing results of some popular benchmark testing programs.

Users have to modify the value for each item in chipset features as follow

```

ROM PCI/ISA BIOS (2A6ILG0C)
CHIPSET FEATURES SETUP
AWARD SOFTWARE, INC.

Auto Configuration      : Enabled
#RAS Pulse Width Refresh : 4T
#RAS Precharge Time    : 2T
#RAS to CAS Delay      : 2T
ISA Bus Clock Frequency : PCICLK/4
Starting Point of Paging : 1T
SDRAM CAS Latency      : 3T
SDRAM WR Retire Rate    : X-1-1-1
CPU to PCI Burst Mem. WR : Enabled
System BIOS Cacheable  : Enabled
Video RAM Cacheable    : Enabled
Memory Hole at 15M-16M : Disabled
AGP Aperture Size      : 64MB
Concurrent function(MEM) : Enabled
Concurrent function(PCI) : Enabled
CPU Pipeline Control   : Enabled
PCI Delay Transaction  : Enabled
SDRAM Synchronous Mode : Enabled
*SDRAM Clock Frequency : 100MHz
*CPU Clk High Than SDRAM : No

Auto Detect DIMM/PCI Clk : Disabled
Spread Spectrum          : Disabled

ESC : Quit          F10 : Select Item
F1  : Help          PU/PD/+/- : Modify
F5  : Old Values   (Shift)F2 : Color
F6  : Load BIOS Defaults
F7  : Load Setup Defaults
    
```

for top performance setting.

**The above settings have to modify according to different kinds of CPU, SDRAM, and peripherals for your system to work properly.

These data are just referred by users, and there is no responsibility for different testing data values gotten by users. (The different Hardware & Software configuration will result in different benchmark testing results.)

- CPU Intel® Celeron™ 366/466MHz Socket 370 processor
- DRAM (128x 1) MB SDRAM (MT 48LC8M8A2-8E B)
- CACHE SIZE 128 KB included in CPU
- DISPLAY Onboard SIS 620 graphics acceleration (8MB SDRAM)

- STORAGE Onboard IDE (Seagate ST34520)
- O.S. Windows NT™4.0 SPK4
- DRIVER Display Driver at 1024 x 768 x 64k colors x 75Hz.
SIS PCI Master IDE Miniport Driver

Processor	366MHz (66x5.5)	466MHz (66x7)
Winbench98		
CPU mark32	643	718
FPU Winmark	1960	2500
Business Disk	4010	4200
Hi-End Disk	9260	9560
Business Graphics	99.8	108
Hi-End Graphics	256	298
Winstone98		
Business	23	25
Hi-End	21.5	24.1

