

FCC Compliance Statement:

<p style="text-align: center;">DECLARATION OF CONFORMITY Per FCC Part 2 Section 2.1077(a)</p> <p style="text-align: center;">FCC</p> <p>Responsible Party Name: G.B.T. INC.</p> <p>Address: 18205 Valley Blvd., Suite#A LA Puente, CA 91744</p> <p>Phone/Fax No: (818) 854-9338/ (818) 854-9339</p> <p>hereby declares that the product</p> <p>Product Name: Mother Board</p> <p>Model Number: GA-6CX7</p> <p>Conforms to the following specifications:</p> <p>FCC Part 15, Subpart B, Section 15.107(a) and Section 15.109(a), Class B Digital Device</p> <p>Supplementary Information:</p> <p>This device complies with part 15 of the FCC Rules. Operation is subject to the following two conditions: (1) This device may not cause harmful and (2) this device must accept any interference received, including that may cause undesired operation.</p> <p>Representative Person's Name: ERIC LU</p> <p>Signature: <u>Eric Lu</u></p> <p>Date: Feb. 29, 2000</p>
--

This equipment has been tested and found to comply with limits for a Class B digital device, pursuant to Part 15 of the FCC rules. These limits are designed to provide reasonable protection against harmful interference in residential installations. This equipment generates, uses, and can radiate radio frequency energy, and if not installed and used in accordance with the instructions, may cause harmful interference to radio communications. However, there is no guarantee that interference will not occur in a particular installation. If this equipment does cause interference to radio or television equipment

reception, which can be determined by turning the equipment off and on, the user is encouraged to try to correct the interference by one or more of the following measures:

- Reorient or relocate the receiving antenna
- Move the equipment away from the receiver
- Plug the equipment into an outlet on a circuit different from that to which the receiver is connected
- Consult the dealer or an experienced radio/television technician for additional suggestions

You are cautioned that any change or modifications to the equipment not expressly approve by the party responsible for compliance could void Your authority to operate such equipment.

This device complies with Part 15 of the FCC Rules. Operation is subjected to the following two conditions 1) this device may not cause harmful interference and 2) this device must accept any interference received, including interference that may cause undesired operation.

Declaration of Conformity

We, Manufacturer/Importer
(full address)

G.B.T. Technology Trädning GmbH
Ausschlagler Weg 41, 1F, 20537 Hamburg, Germany

declare that the product
(description of the apparatus, system, installation to which it refers)

Mother Board
GA-6CX7

is in conformity with
(reference to the specification under which conformity is declared)
in accordance with 89/336 EEC-EMC Directive

- | | | | |
|--|--|--|--|
| <input type="checkbox"/> EN 55011 | Limits and methods of measurement of radio disturbance characteristics of industrial, scientific and medical (ISM) high frequency equipment | <input type="checkbox"/> EN 61000-3-2*
<input checked="" type="checkbox"/> EN60555-2 | Disturbances in supply systems caused by household appliances and similar electrical equipment "Harmonics" |
| <input type="checkbox"/> EN55013 | Limits and methods of measurement of radio disturbance characteristics of broadcast receivers and associated equipment | <input type="checkbox"/> EN61000-3-3*
<input checked="" type="checkbox"/> EN60555-3 | Disturbances in supply systems caused by household appliances and similar electrical equipment "Voltage fluctuations" |
| <input type="checkbox"/> EN 55014 | Limits and methods of measurement of radio disturbance characteristics of household electrical appliances, portable tools and similar electrical apparatus | <input checked="" type="checkbox"/> EN 50081-1
<input checked="" type="checkbox"/> EN 50082-1 | Generic emission standard Part 1: Residual, commercial and light industry
Generic immunity standard Part 1: Residual, commercial and light industry |
| <input type="checkbox"/> EN 55015 | Limits and methods of measurement of radio disturbance characteristics of fluorescent lamps and luminaries | <input type="checkbox"/> EN 55081-2 | Generic emission standard Part 2: Industrial environment |
| <input type="checkbox"/> EN 55020 | Immunity from radio interference of broadcast receivers and associated equipment | <input type="checkbox"/> EN 55082-2 | Generic immunity standard Part 2: Industrial environment |
| <input checked="" type="checkbox"/> EN 55022 | Limits and methods of measurement of radio disturbance characteristics of information technology equipment | <input type="checkbox"/> ENV 55104 | Immunity requirements for household appliances tools and similar apparatus |
| <input type="checkbox"/> DIN VDE 0855
<input type="checkbox"/> part 10
<input type="checkbox"/> part 12 | Cabled distribution systems; Equipment for receiving and/or distribution from sound and television signals | <input type="checkbox"/> EN 50091- 2 | EMC requirements for uninterruptible power systems (UPS) |
| <input checked="" type="checkbox"/> CE marking | |  | (EC conformity marking) |

The manufacturer also declares the conformity of above mentioned product with the actual required safety standards in accordance with LVD 73/23 EEC

- | | | | |
|--|---|--|---|
| <input type="checkbox"/> EN 60065 | Safety requirements for mains operated electronic and related apparatus for household and similar general use | <input type="checkbox"/> EN 60950 | Safety for information technology equipment including electrical business equipment |
| <input type="checkbox"/> EN 60335 | Safety of household and similar electrical appliances | <input type="checkbox"/> EN 50091-1 | General and Safety requirements for uninterruptible power systems (UPS) |

Manufacturer/Importer

Signature : Rex Lin
Name : Rex Lin

(Stamp)

Date: Feb. 29, 2000

6CX7 Series
100/133 MHz Pentium® II/!!!
Socket 370 Processor Motherboard

USER'S MANUAL

Socket 370 Processor Motherboard
REV. 1.1 Third Edition
R-11-03-000712

How This Manual Is Organized

This manual is divided into the following sections:

1) Revision History	Manual revision information
2) Item Checklist	Product item list
3) Features	Product information & specification
4) Hardware Setup	Instructions on setting up the motherboard
5) Performance & Block Diagram	Product performance & block diagram
6) Suspend to RAM & Dual BIOS	Instructions STR installation & Dual BIOS
7) Four Speaker & SPDIF	Four Speaker & SPDIF introduction
8) BIOS Setup	Instructions on setting up the BIOS software
9) Appendix	General reference

Table Of Contents

Revision History	P.1
Item Checklist	P.2
Summary of Features	P.3
6CX7 Series Motherboard Layout	P.5
Page Index for CPU Speed Setup/Connectors/Panel and Jumper Definition	P.6
Performance List	P.30
Block Diagram	P.31
Suspend to RAM Installation	P.32
Dual BIOS Introduction (Optional)	P.38
Four Speaker & SPDIF Introduction (Optional)	P.45
Memory Installation	P.50
Page Index for BIOS Setup	P.52
Appendix	P.82

Revision History

Revision	Revision Note	Date
1.0	Initial release of the 6CX7 Series motherboard user's manual.	Feb.2000
1.1	Initial release of the 6CX7 Series motherboard user's manual.	Mar.2000
1.1	Second release of the 6CX7 Series motherboard user's manual.	Mar.2000
1.1	Third release of the 6CX7 Series motherboard user's manual.	Jul.2000

The author assumes

document nor does the author make a commitment to update the information contained herein.

Third-

Item Checklist

- The 6CX7 Series Motherboard
- Cable for IDE / Floppy device
- CD (IUCD) for motherboard utilities
- Internal COM B Cable (Optional)
- Internal USB Cable (Optional)
- Cable for SCSI device
- 6CX7 Series User's Manual
- CRIMM Module

Summary Of Features

Form factor	<ul style="list-style-type: none"> 30.5 cm x 20 cm ATX Size form factor, 4 layers PCB.
Motherboard	<ul style="list-style-type: none"> 6CX7 series includes 6CX7L, 6CX7, 6CX7-1
CPU	<ul style="list-style-type: none"> Socket 370 Processor 2nd cache in CPU (Depend on CPU)
Chipset	<ul style="list-style-type: none"> 82820 HOST / AGP / RDRAM Controller 82801AA(ICH) I/O Controller Hub
Clock Generator	<ul style="list-style-type: none"> Supports 100 / 133MHz 105/110/117/120/125/127/135/137/140/145/150 MHz clocks (reserved)
Memory	<ul style="list-style-type: none"> 2 184-pin RIMM Sockets
I/O Control	<ul style="list-style-type: none"> Winbond W83627HF
Slots	<ul style="list-style-type: none"> 1 AMR (Audio Modem Riser) slot 1 Universal AGP slot (1X / 2X / 4X 1.5V/3.3V device support) 5 32-bit Master PCI Bus slots (Note: If both of Creative CT5800 and Intel 82559 chipsets are on board, you have only 4 32-bit master PCI slots at PCI1~PCI4, PCI5 will be slave PCI slot)
On-Board IDE	<ul style="list-style-type: none"> An IDE controller on the Intel® 82801AA (ICH) PCI chipset provides IDE HDD/ CD-ROM with PIO, Bus Master (Ultra DMA33/ATA66) operation modes Can connect up to four IDE devices
On-Board Peripherals	<ul style="list-style-type: none"> 1 Floppy port supports 2 FDD with 360K, 720K, 1.2M, 1.44M and 2.88M bytes 1 Parallel ports supports EPP/ECP mode 2 Serial Ports (COM A & COM B) 2 USB ports (Front USB is optional for NEC) 1 IrDA connector for IR/CIR (Optional)
Hardware Monitor	<ul style="list-style-type: none"> CPU/Power Supply/System Fan Revolution detect CPU / Power / System Fan Control System Voltage Detect CPU Overheat Warning Chassis Intrusion Detect Display Actual Current Voltage
PS/2 Connector	<ul style="list-style-type: none"> PS/2® Keyboard interface and PS/2® Mouse interface

To be continued...

BIOS	<ul style="list-style-type: none">• Licensed AMI BIOS, 4M bit FLASH ROM• Support Dual BIOS (Optional)
On-Board LAN	<ul style="list-style-type: none">• Intel® GD 82559(Optional for 6CX7L)• Alert On LAN*2 ASIC (Optional)
On-Board Sound	<ul style="list-style-type: none">• Creative CT5880 sound (Optional for 6CX7)• AC'97 CODEC• Line In/Line Out/Mic In/AUX In/CD In/TEL/Game Port• SPDIF/Four Speaker (Optional for 6CX7)
Additional Features	<ul style="list-style-type: none">• Internal/External Modem Wake up• STR (Suspend-To-RAM)• Wake On LAN• PS/2 Keyboard Password Wake up• System after AC back• Poly fuse for keyboard, USB, Game port over- current protection• PS/2 Mouse Power On• USB KB/MS Wake Up from S3

6CX7 Series Motherboard Layout

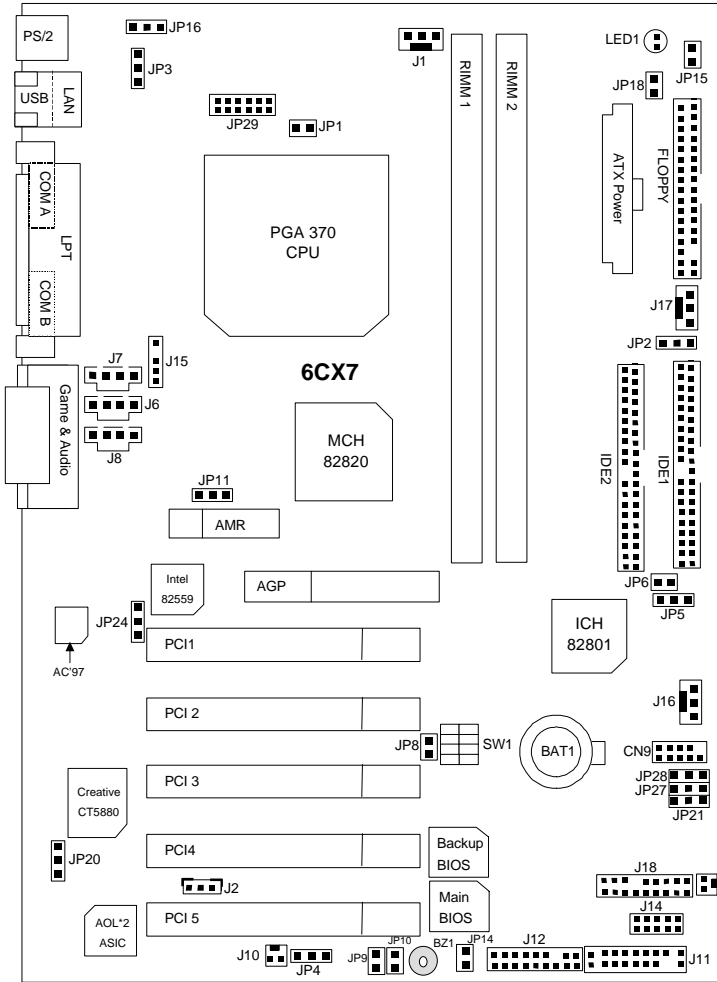

 Page Index for CPU Speed Setup/Connectors/Panel and Jumper Definition	Page
CPU Speed Setup	P.8
Connectors	P.9
Game & Audio Port	P.9
COM A / COM B / LPT Port	P.9
USB & LAN Connector (LAN is optional)	P.10
PS/2 Keyboard & PS/2 Mouse Connector	P.10
J1 (CPU Fan)	P.11
J17 (Power Fan)	P.11
J16 (System Fan)	P.12
ATX Power	P.12
IR/CIR (Optional)	P.13
Floppy Port	P.13
IDE 1(Primary)/ IDE 2(Secondary) Port	P.14
J8 (AUX_IN)	P.14
J6 (CD Audio Line In)	P.15
J7 (TEL)	P.15
J2 (Wake On LAN)	P.16
J10 (Ring Power On)	P.16
J15 (External SMBUS Device Connector)	P.17
JP15 (STR LED Connector) & LED1 (RIMM LED)	P.17
CN9 (FP USB)[For NEC] [Optional]	P.18
J12 (Front Panel Jumper)[For NEC]	P.18
J18 (AOL Connector) [For NEC] [Optional]	P.19
Panel and Jumper Definition	P.20
J11 (2x11 Pins Jumper)	P.20
JP16 (PS/2 Keyboard Power On)	P.21
JP3 (Back USB device Wake Up Selection)[Optional]	P.21
JP4 (Clear CMOS Function) [Optional]	P.22
JP5 (Safe mode / Recovery / Normal)	P.22
JP6 (Timeout Reboot Function) [Optional]	P.23
JP11 (AMR Select)[Optional]	P.23
JP17 (Case Open)	P.24
JP20 (Onboard Sound Function Selection)	P.24
JP21 (Front USB device Wake Up Selection)[Optional]	P.25
JP27/JP28 (USB Port Selection)	P.25

6CX7 Series Motherboard

JP9 (Top Block Lock) [Optional]	P.26
JP10 (FWH Write Protection) [Optional]	P.26
JP14 (Internal Buzzer Connector) [Optional]	P.27
JP18 (STR Enable)	P.27
JP29 (Over Voltage CPU Speed Up)[Optional]	P.28
JP1 (Cyrix CPU Turbo Function) [Optional]	P.28
JP24 (Onboard LAN Function) [Optional]	P.29
BAT1 (Battery)	P.29

CPU Speed Setup

The CPU bus frequency can be switched at 100MHz and 133MHz by adjusting JP8 & SW 1. The CPU ratio selection is control by BIOS.

JP8 / SW1 Select the CPU Speed at 100MHz and 133MHz.

AGPCLK	66.6	73.3	80	66.6	70	75	66.6
CPUCCLK	100	110	120	133	140	150	100/133/Auto
JP8	OFF	OFF	OFF	OFF	OFF	OFF	ON
1	O	O	O	X	X	X	X
2	O	X	X	O	X	X	O
3	X	O	X	X	O	X	X
4	O	O	X	O	X	X	O

(O: ON / X: OFF)

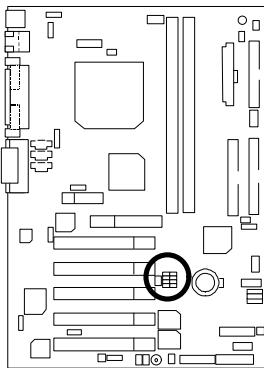

100MHz



SW1

133MHz



SW1

100/133/Auto



SW1

Connectors

Game & Audio Port

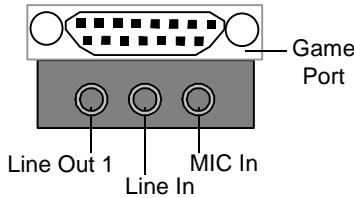
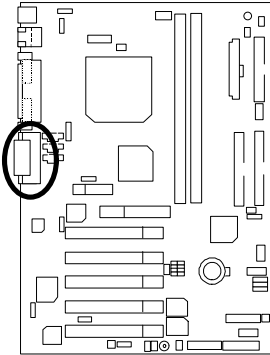

Line Out 1: Line Out or SPDIF (The SPDIF output is capable of providing digital audio to external speakers or compressed AC3 data to an external Dolby digital decoder). In general, Line Out 1 is normally Line Out, when it output digital signal, it will be change to SPDIF Out automatically (see page 47 for more information).
Line In: In general, Line In is normally Line In. When you select "Four Speaker" in Creative application (see page 45 for more information), Line In will be change to Line Out 2, then you can plug 2 pairs stereo speaker into Line Out 1 and Line In simultaneously.

COM A / COM B / LPT Port

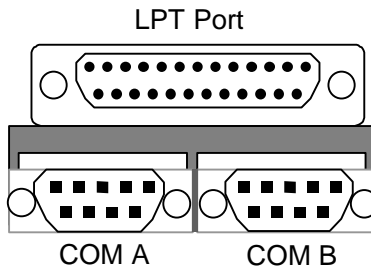
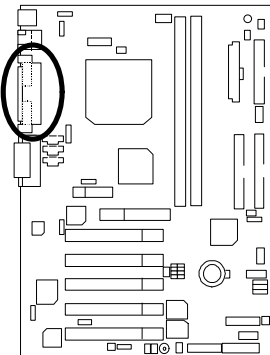

USB & LAN Connector (LAN is optional)

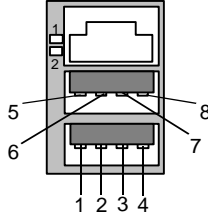
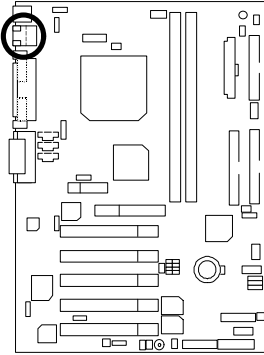

1 – Green LED
(LAN Link LED)

2 – Yellow LED
(LAN Active LED)

Pin No.	Definition
1	USB V0
2	USB D0-
3	USB D0+
4	GND
5	USB V1
6	USB D1-
7	USB D1+
8	GND

PS/2 Keyboard & PS/2 Mouse Connector

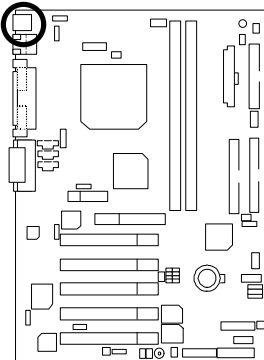

PS/2 Mouse

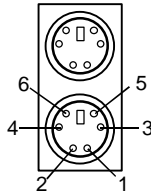

PS/2 Keyboard

PS/2 Mouse/ Keyboard	
Pin No.	Definition
1	Data
2	NC
3	GND
4	VCC(+5V)
5	Clock
6	NC

J1: CPU Fan

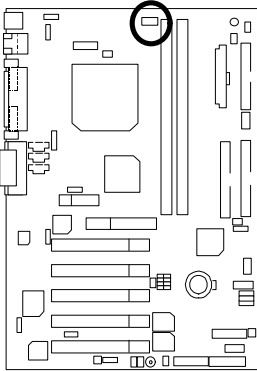

Pin No.	Definition
1	GND
2	+12V
3	SENSE

J17: Power Fan

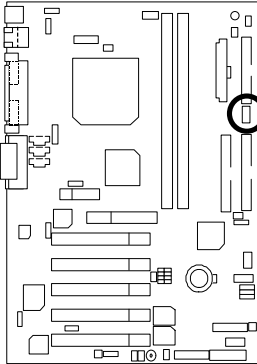

Pin No.	Definition
1	GND
2	+12V
3	SENSE

J16: System Fan

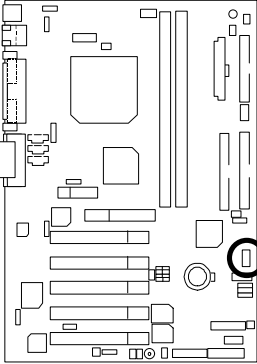

Pin No.	Definition
1	GND
2	+12V
3	SENSE

ATX Power

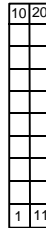
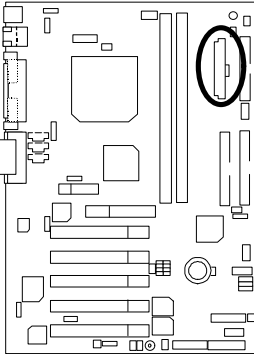

Pin No.	Definition
3,5,7,13, 15-17	GND
1,2,11	3.3V
4,6,19,20	VCC
10	+12V
12	-12V
18	-5V
8	Power Good
9	5V SB stand by+5V
14	PS-ON(Soft On/Off)

IR/CIR (Optional)

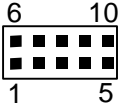
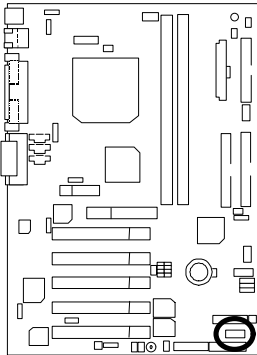

Pin No.	Definition
1	VCC
2	NC
3	IRRX
4	GND
5	IRTX
6	NC
7	CIRRX
8	VCC
9	NC
10	NC

Floppy Port

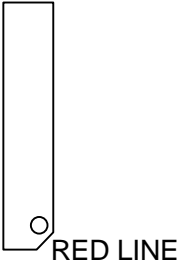
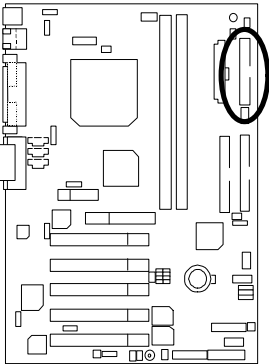

IDE1 (Primary), IDE2 (Secondary) Port

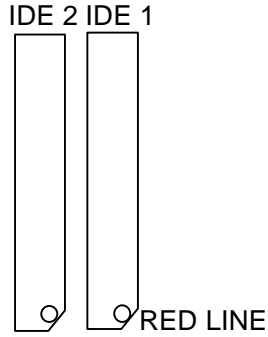
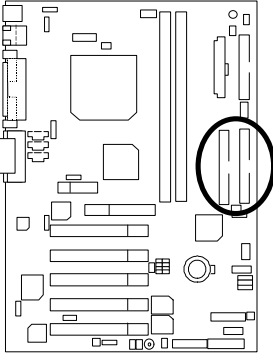

J8: AUX_IN

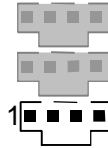
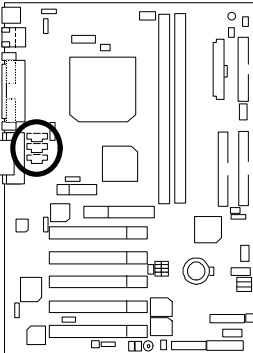

Pin No.	Definition
1	AUX-L
2	GND
3	GND
4	AUX-R

J6: CD Audio Line In

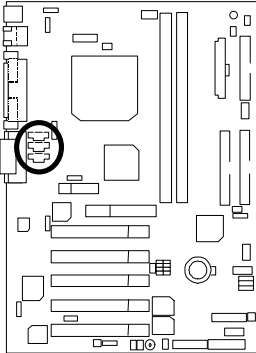

Pin No.	Definition
1	CD-L
2	GND
3	GND
4	CD-R

J7: TEL: The connector is for Modem with internal voice connector

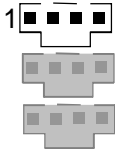
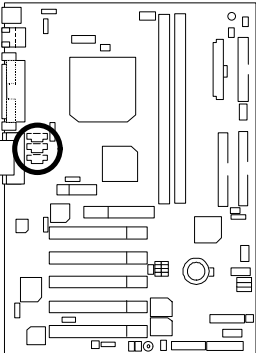

Pin No.	Definition
1	Signal-In
2	GND
3	GND
4	Signal-Out

J2: Wake On LAN

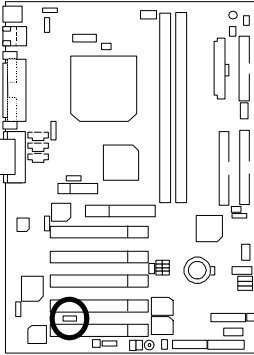

Pin No.	Definition
1	+5V SB
2	GND
3	Signal

J10: Ring Power On

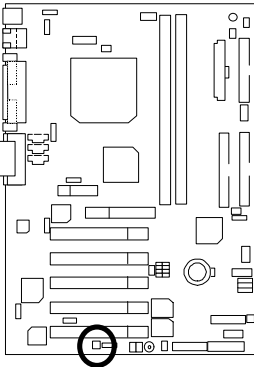

Pin No.	Definition
1	Signal
2	GND

J15: External SMBUS Device Connector

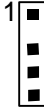
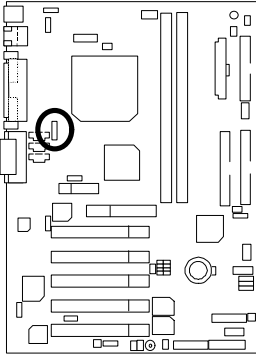

Pin No.	Definition
1	SMB CLK
2	NC
3	GND
4	SMB DATA
5	+5V

JP15: STR LED Connector & LED1: RIMM LED

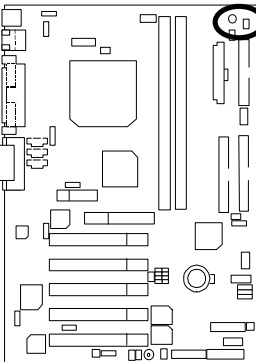

RIMM LED



STR LED Connector External

CN9: FP USB (For NEC)[Optional]

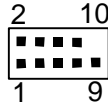
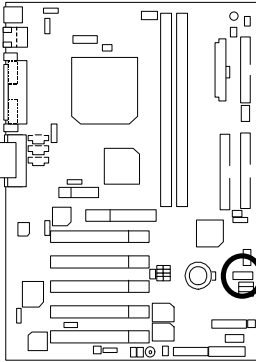

Pin No.	Definition
1, 4,5,10	NC
2	Power
3, 7, 9	GND
6	USB D1+
8	USB D1-

J12: Front Panel Jumper (For NEC)

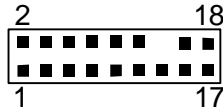
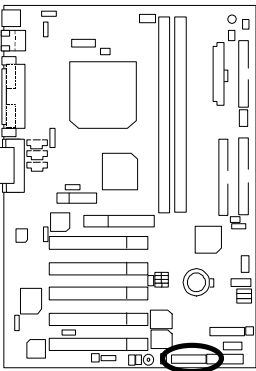

Pin No.	Definition
1	HD LED+
2	PWR LED+
3	HD LED-
4	GN LED+
5,13, 8, 12	GND
6	PW
7	RST
9, 16	VCC
10	GN
11	IRRX
14, 17, 18	NC
15	IRTX

J18: AOL Connector (For NEC)[Optional]

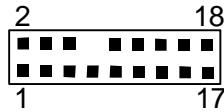
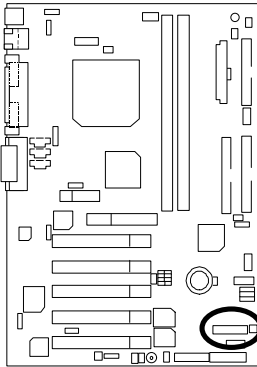

Pin No.	Definition
1	SMB CLK
2	SMB DATA
3,8,13	NC
4	ICH-SCL
5	ICH-SDA
6,15,17	GND
7	PWRSTSW
9	THRMO-
10	GPI10
11	Case open-
12	3VSB
14	RSMRST-
16	RESET
18	PWROK

Panel And Jumper Definition

J11: For 2x11 Pins Jumper

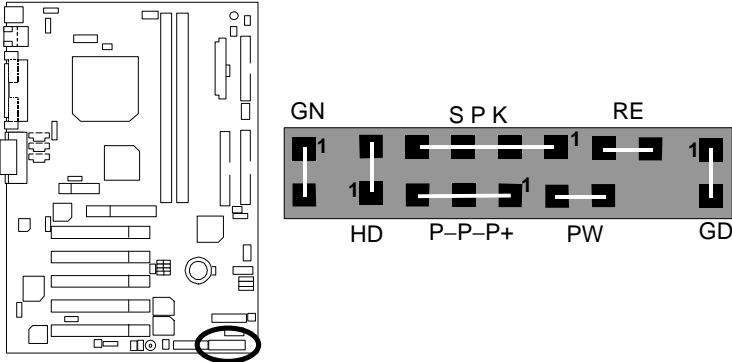

GN (Green Switch)	Open: Normal Operation Close: Entering Green Mode
GD (Green LED)	Pin 1: LED anode(+) Pin 2: LED cathode(-)
HD (IDE Hard Disk Active LED)	Pin 1: LED anode(+) Pin 2: LED cathode(-)
SPK (Speaker Connector)	Pin 1: VCC(+) Pin 2- Pin 3: NC Pin 4: Data(-)
RE (Reset Switch)	Open: Normal Operation Close: Reset Hardware System
P+P-P-(Power LED)	Pin 1: LED anode(+) Pin 2: LED cathode(-) Pin 3: LED cathode(-)
PW (Soft Power Connector)	Open: Normal Operation Close: Power On/Off

JP16: PS/2 Keyboard Power On

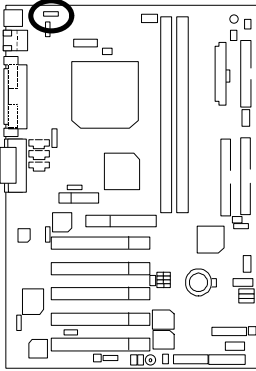

Pin No.	Definition
1-2 close	PS/2 Keyboard Power on Enabled
2-3 close	PS/2 Keyboard Power on Disabled (Default)

JP3: Back USB device Wake up Selection (Optional) (USB Connector → CN1)

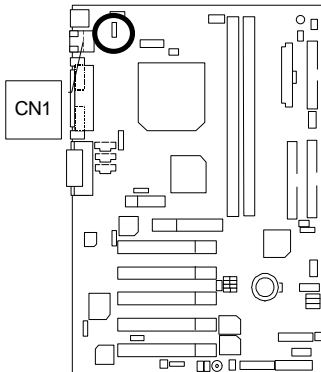

Pin No.	Definition
1-2 close	Enabled Back USB Device Wake up
2-3 close	Disabled Back USB Device Wake up (Default)

(If you want to use “**USB KB/MS Wakeup From S3**” function, you have to set the BIOS setting “**USB KB/MS Wakeup From S3**” enabled, and the jumper “**JP3&JP21**” enabled).
 *(Power on the computer and as soon as memory counting starts, press . You will enter BIOS Setup. Select the item “**POWER MANAGEMENT SETUP**”, then select “**USB KB/MS Wakeup From S3: Enabled**”. Remember to save the setting by pressing “**ESC**” and choose the “**SAVE & EXIT SETUP**” option.)

JP4: Clear CMOS Function (Optional)

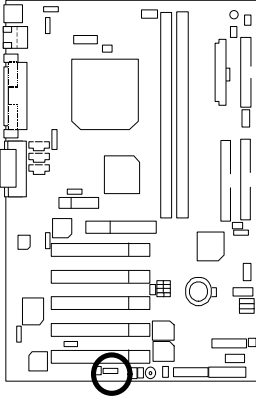

Pin No.	Definition
1-2 close	Clear CMOS
2-3 close	Normal (Default)

JP5: Safe mode / Recovery / Normal

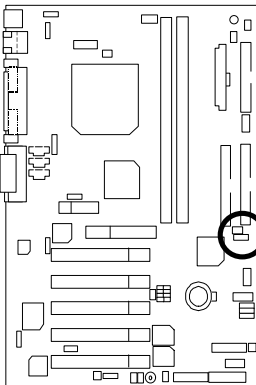

Pin No.	Definition
1-2close	Normal (Default)
2-3close	Safe mode
1-2-3open	Recovery

JP6: Timeout Reboot Function (Optional)

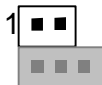
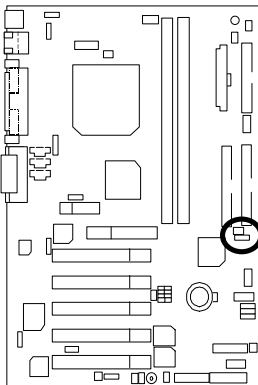

Pin No.	Definition
Open	Timeout Reboot
Close	No Reboot on Timeout

JP11: AMR Select (Optional)

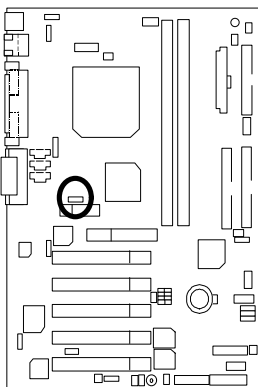

Pin No.	Definition
1-2close	AMR Secondary
2-3close	AMR Primary AC'97 Disabled (Default) (Disabled Onboard CODEC)

JP17: Case Open

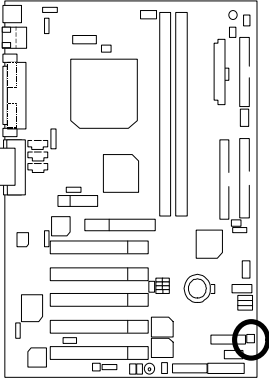

Pin No.	Definition
1	Signal
2	GND

JP20: Onboard Sound Function Selection

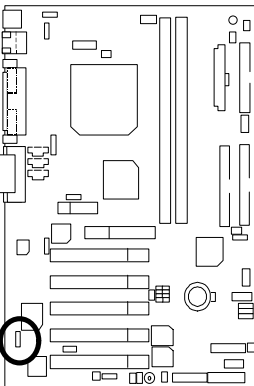

Pin No.	Definition
1-2 close	Enabled Onboard sound (Default)
2-3 close	Disabled Onboard sound

JP21: Front USB device Wake up Selection (Optional)
(USB Connector → CN9)

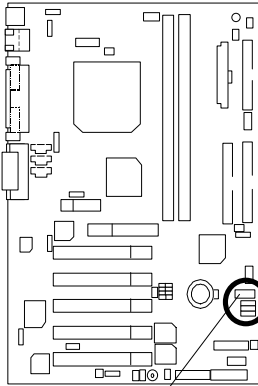

CN9

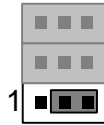

Pin No.	Definition
1-2 close	Enabled Front USB Device Wake up
2-3 close	Disabled Front USB Device Wake up (Default)

(If you want to use "USB KB/MS Wakeup From S3" function, you have to set the BIOS setting "USB KB/MS Wakeup From S3" enabled, and the jumper "JP21&JP3" enabled).
*(Power on the computer and as soon as memory counting starts, press . You will enter BIOS Setup. Select the item "POWER MANAGEMENT SETUP", then select "USB KB/MS Wakeup From S3: Enabled". Remember to save the setting by pressing "ESC" and choose the "SAVE & EXIT SETUP" option.)

JP27/JP28: USB Port Selection

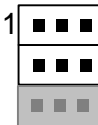
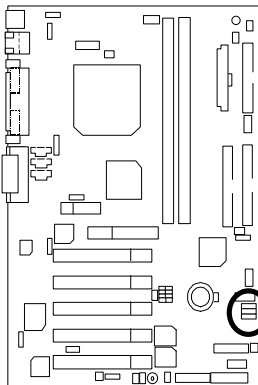

	JP27	JP28
FPUSEB Enabled	1-2 close	1-2 close
FPUSEB Disabled	2-3 close	2-3 close

JP9: Top Block Lock (Optional)

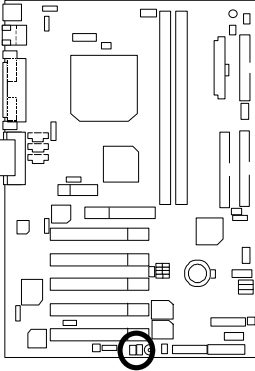

Pin No.	Definition
Open	Top Block Lock
Close	Top Block Unlock (Default)

JP10: FWH Write Protection (Optional)

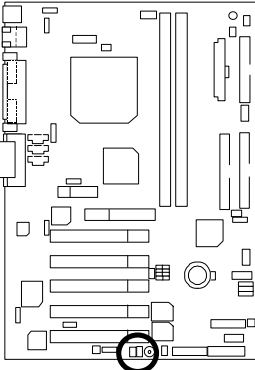

Pin No.	Definition
Open	Normal (Default)
Close	Write Protect

◆ Please set Jumper JP10 to “Open” to enabled BIOS write function when you update new BIOS or new device.

JP14: Internal Buzzer Connector (Optional)

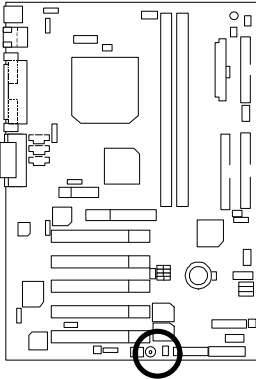

Pin No.	Definition
Open	Internal Buzzer Disabled
Close	Internal Buzzer Enabled (Default)

JP18: STR Enable

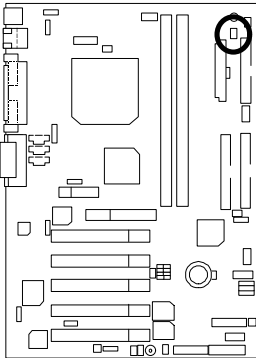

Pin No.	Definition
Open	STR Disabled
Close	STR Enabled

JP29: Over Voltage CPU Speed Up (Optional) (**Magic Booster**)
 (When JP29 set "3-4 close", CPU Voltage is rising 10%)

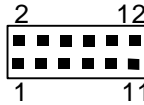
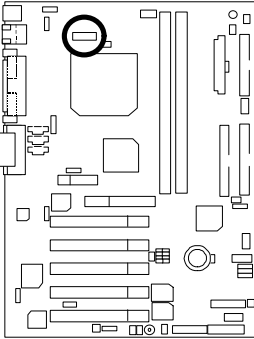

Pin No.	Definition
1-2 close	Normal
3-4 close	10%
5-6 close	20%
7-8 close	30%
9-10 close	40%
11-12 close	50%

JP1: Cyrix CPU Turbo Function (Optional)

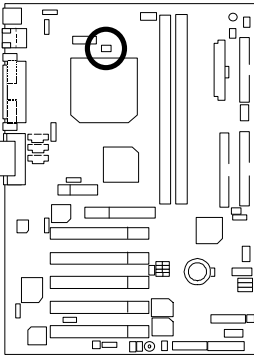

Pin No.	Definition
Open	Normal
Close	For Cyrix 133

JP24: Onboard LAN Function (Optional)

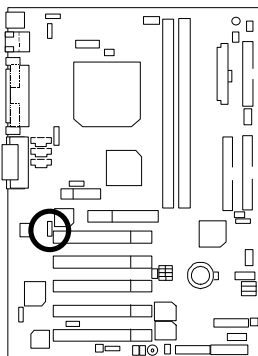

Pin No.	Definition
1-2 close	Onboard LAN Enabled
2-3 close	Onboard LAN Disabled (Default)

BAT1: Battery

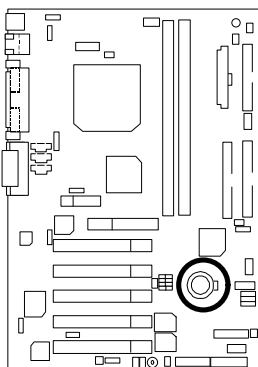

- ⚠ Danger of explosion if battery is incorrectly replaced.
- ⚠ Replace only with the same or equivalent type recommended by the manufacturer.
- ⚠ Dispose of used batteries according to the manufacturer's instructions.

Performance List

The following performance data list is the testing results of some popular benchmark testing programs.

These data are just referred by users, and there is no responsibility for different testing data values gotten by users. (The different Hardware & Software configuration will result in different benchmark testing results.)

- CPU Intel® Pentium® !!! 667MHz processor
- DRAM (128 x 2)MB RIMM (KM-418RD4C-G60)
- CACHE SIZE 256 KB included in CPU
- DISPLAY GA-660+ (32MB)
- STORAGE Onboard IDE (Quantum KA13600AT)
- O.S. Windows NT™ 4.0 SP6
- DRIVER Display Driver at 1024 x 768 x 64K colors x 75Hz.
Intel Ultra ATA storage Driver V5.0.012 (Engineering Sample)

Processor	Intel® Pentium® !!! 667MHz (133X5)
Winbench99	
CPU mark99	62
FPU Winmark 99	3570
Business Disk Winmark 99	5610
Hi-End Disk Winmark 99	13200
Business Graphics Winmark 99	361
Hi-End Graphics Winmark 99	664
Winstone99	
Business Winstone99	41.8
Hi-End Winstone99	40.8

Block Diagram

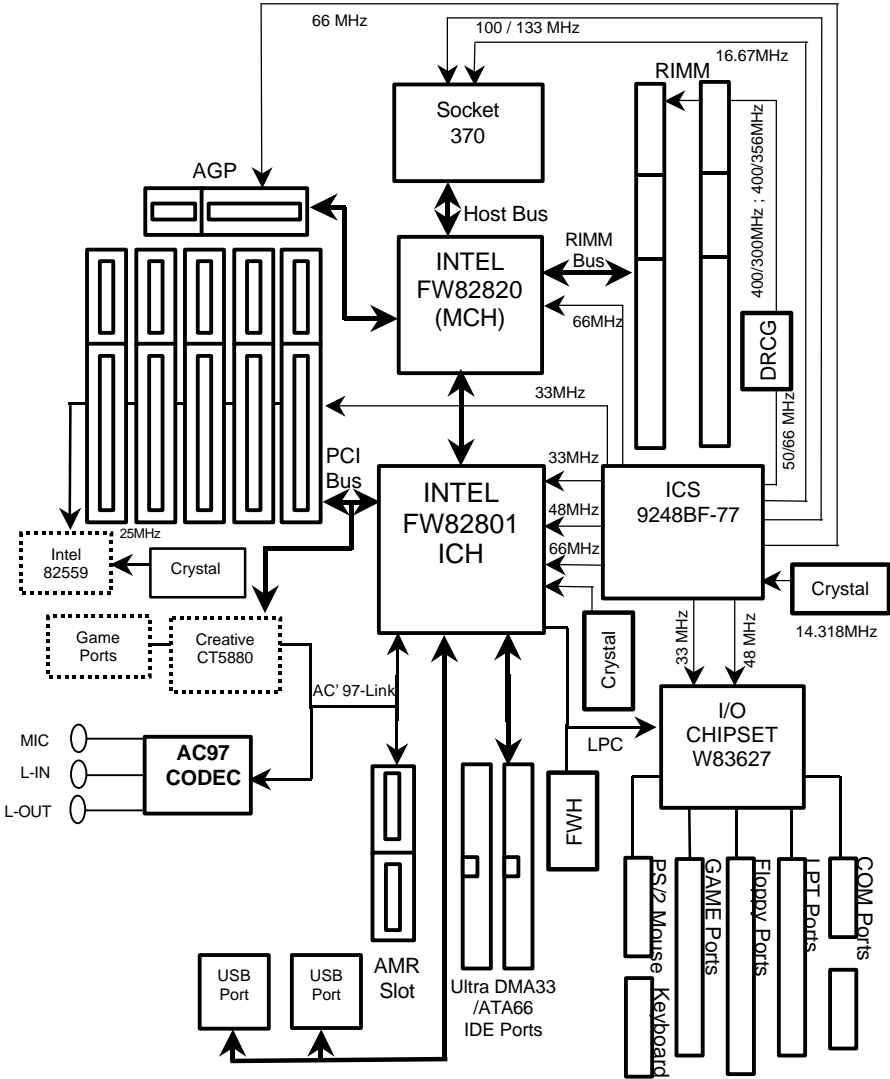

Suspend To RAM Installation

A.1 Introduce STR function:

Suspend-to-RAM (STR) is a Windows 98 ACPI sleep mode function. When recovering from STR (S3) sleep mode, the system is able, in just a few seconds, to retrieve the last "state" of the system before it went to sleep and recover to that state. The "state" is stored in memory (RAM) before the system goes to sleep. During STR sleep mode, your system uses only enough energy to maintain critical information and system functions, primarily the system state and the ability to recognize various "wake up" triggers or signals, respectively.

A.2 STR function Installation

Please use the following steps to complete the STR function installation.

Step-By-Step Setup

Step 1:

To utilize the STR function, the system must be in Windows 98 ACPI mode.

Putting Windows 98 into ACPI mode is fairly easy.

Setup with Windows 98 CD:

- A. Insert the Windows 98 CD into your CD-ROM drive, select Start, and then Run.
- B. Type (without quotes) "**D:\setup /p j**" in the window provided. Hit the enter key or click OK. In Windows 98 second edition version, all the bios version dated 12/01/99 or later are ACPI compatible. Just type "D:\Setup", the operating system will be installed as ACPI mode. z
- C. After setup completes, remove the CD, and reboot your system
(This manual assumes that your CD-ROM device drive letter is D:).

Step 2:

(If you want to use STR Function, please set jumper JP18 Closed.)

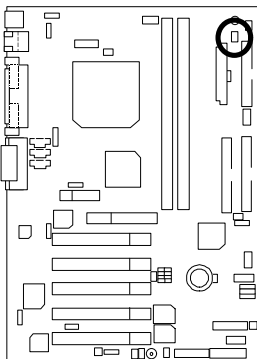

Pin No.	Definition
Open	STR Disabled
Close	STR Enabled

Step 3:

Power on the computer and as soon as memory counting starts, press . You will enter BIOS Setup. Select the item **"POWER MANAGEMENT SETUP"**, then select **"ACPI Sleep Type:S3/STR"**. Remember to save the settings by pressing "ESC" and choose the **"SAVE & EXIT SETUP"** option.

Congratulation! You have completed the installation and now can use the STR function.

A.3 How to put your system into STR mode?

There are two ways to accomplish this:

1. Choose the "Stand by" item in the "Shut Down Windows" area.
 - A. Press the "Start" button and then select "Shut Down"



- B. Choose the "Stand by" item and press "OK"

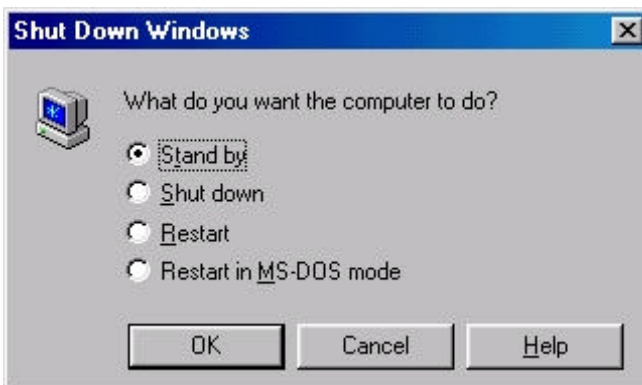

6CX7 Series Motherboard

2. Define the system "power on" button to initiate STR sleep mode:
 - A. Double click "My Computer" and then "Control Panel"

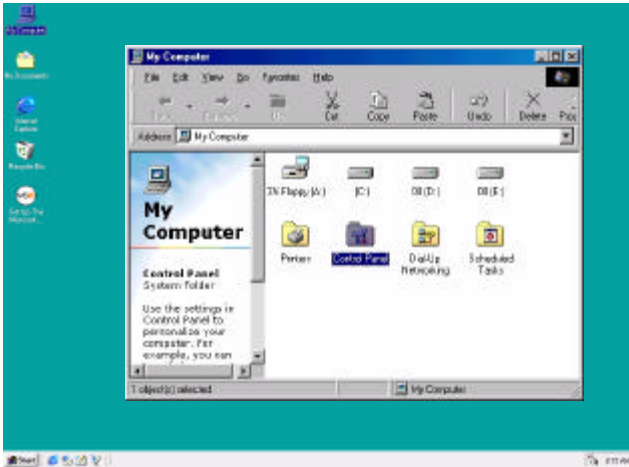

- B. Double click the "Power Management" item.

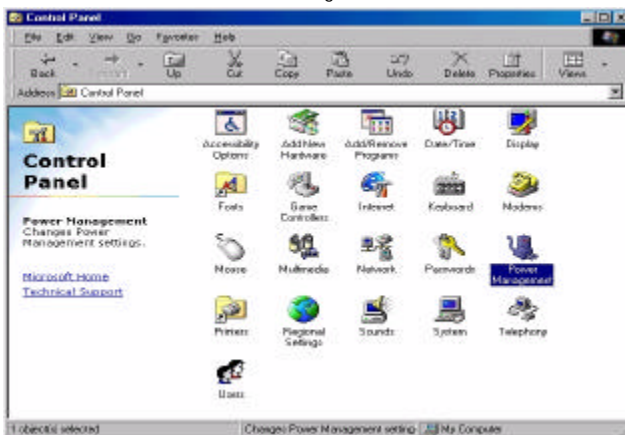

- C. Select the “Advanced” tab and “Standby” mode in Power Buttons.

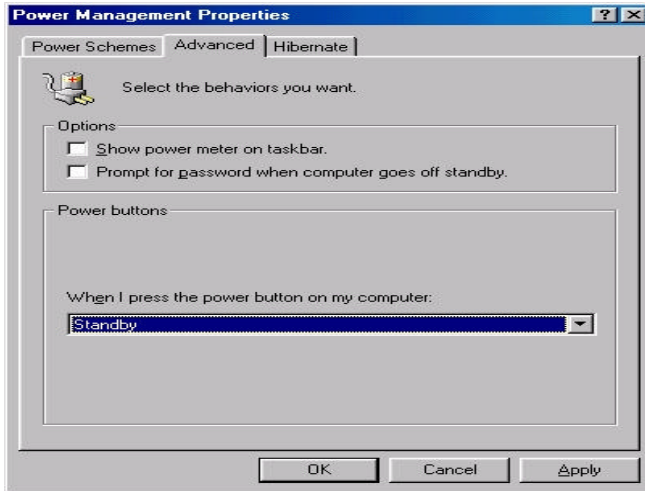

Step 4:

Restart your computer to complete setup.

Now when you want to enter STR sleep mode, just momentarily press the “Power on” button..

A.4 How to recover from the STR sleep mode?

There are seven ways to “wake up” the system:

1. Press the “Power On” button.
2. Use the “PS/2 Keyboard Power On” function.
3. Use the “Mouse Power On” function.
4. Use the “Resume by Alarm” function.
5. Use the “Modem Ring On” function.
6. Use the “Wake On LAN” function.
7. Use the “USB Device Wake up” function.

A.5 Notices:

In order for STR to function properly, several hardware and software requirements must be satisfied:

- A. Your ATX power supply must comply with the ATX 2.01 specification (provide more than 720 mA 5V Stand-By current).
- 2. Jumper JP15 is provided to connect to the STR LED in your system chassis. [Your chassis may not provide this feature.] The STR LED will be illuminated when your system is in STR sleep mode.

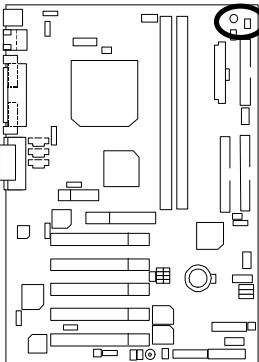

RIMM LED



STR LED Connector External

b. AMI Dual BIOS Flash ROM Programming Utility

AMI Dual BIOS Flash ROM Programming Utility	
Boot From.....	Main BIOS
Main ROM Type.....	Intel N82802AB
Backup ROM Type	Intel N82802AB
<p>Wide Range Protection Disable</p> <p>Boot From Main BIOS</p> <p>Auto Recovery Enable</p> <p>Halt On Error Disable</p> <p>Copy Main ROM Data to Backup</p> <p>Load Default Settings</p> <p>Save Settings to CMOS</p>	
PgDn/PgUp:Modify(Enter:Run) ↑↓:Move ESC:Reset F10:Power Off	

c. Dual BIOS Item explanation:

BIOS will auto detect:

Boot From : Main BIOS

Main ROM Type : Intel N82802AB

Backup ROM Type : Intel N82802AB

Wide Range Protection: Disable(Default), Enable

Status 1:

If any failure (ex. Update ESCD failure, checksum error or reset..) occurs in the Main BIOS , just before the Operating System is loaded and after the power is on, and that the Wide Range Protection is set to “Enable”, the PC will boot from Backup BIOS automatically.

Status 2:

If the ROM BIOS on peripherals cards(ex. SCSI Cards, LAN Cards,..) emits signals to request restart of the system after the user make any alteration on it, the boot up BIOS will not be changed to the Backup BIOS.

Boot From : Main BIOS (Default), Backup BIOS

Status 1:

The user can set to boot from main BIOS or Backup BIOS.

Auto Recovery : Enabled(Default), Disabled

When one of the Main BIOS or Backup BIOS occurs checksum failure, the working BIOS will automatically recover the BIOS of checksum failure.

(In the Power Management Setup of the BIOS Setting, if ACPI Suspend Type is set to Suspend to RAM, the Auto Recovery will be set to Enable automatically.)

(If you want to enter the BIOS setting, please press “**Del**” key when the boot screen appears.)

Halt On Error : Disable(Default), Enable

If the BIOS occurs a checksum error or the Main BIOS occurs a WIDE RANGE PROTECTION error and Halt On BIOS Defects set to Enable, the PC will show messages on the boot screen, and the system will pause and wait for the user’s instruction.

If Auto Recovery: **Disable**, it will show *<or the other key to continue.>*

If Auto Recovery: **Enable**, it will show *<or the other key to Auto Recover.>*

Copy Main ROM Data to Backup

Backup message:

Are you sure to copy BIOS?

[Enter] to continue or [Esc] to abort ...

The means that the Main BIOS works normally and could automatically recover the Backup BIOS. Or the means that the Backup BIOS works normally and could automatically recover the Main BIOS.

(This auto recovery utility is set by system automatically and can’t be changed by user.)



DualBIOS™ Technology FAQ

GIGABYTE Technology is pleased to introduce DualBIOS technology, a hot spare for your system BIOS. This newness "Value-added" feature, in a long series of innovations from GIGABYTE, is available on GA-6CX7 Series motherboard. Future GIGABYTE motherboards will also incorporate this innovation.

What's DualBIOS™?

On GIGABYTE motherboards with DualBIOS there are physically two BIOS chips. For simplicity we'll call one your "Main BIOS" and the other we'll call your "Backup" BIOS (your "hot spare"). If your Main BIOS fails, the Backup BIOS almost automatically takes over on your next system boot. Almost automatically and with virtually zero down time! Whether the problem is a failure in flashing your BIOS or a virus or a catastrophic failure of the Main BIOS chip, the result is the same - the Backup BIOS backs you up, almost automatically.

I. Q: What is DualBIOS™ technology?

Answer:

DualBIOS technology is a patented technology from Giga-Byte Technology. The concept of this technology is based on the redundancy and fault tolerance theory. DualBIOS™ technology simply means there are two system BIOSes (ROM) integrated onto the motherboard. One is a main BIOS, and the other is a backup BIOS. The mainboard will operate normally with the main BIOS, however, if the main BIOS is corrupt or damaged for various reasons, the backup BIOS will be automatically used when the system powered-On. Your PC will operate as before the main BIOS was damaged, and is completely transparent to the user.

II. Q: Why does anyone need a motherboard with DualBIOS™ technology?

Answer:

In today's systems there are more and more BIOS failures. The most common reasons are virus attacks, BIOS upgrade failures, and/or deterioration of the BIOS (ROM) chip itself.

1. New computer viruses are being found that attack and destroy the system BIOS. They may corrupt your BIOS code, causing your PC to be unstable or even not boot normally.
2. BIOS data will be corrupted if a power loss/surge occurs, or if a user resets the system, or if the power button is pressed during the process of performing a system BIOS upgrade.
3. If a user mistakenly updates their mainboard with the incorrect BIOS file, then the system may not be able to boot correctly. This may cause the PC system hang in operation or during boot.
4. A flash ROM's life cycle is limited according to electronic characteristics. The modern PC utilizes the Plug and Play BIOS, and is updated regularly. If a user changes peripherals often, there is a slight chance of damage to the flash ROM.

With Giga-Byte Technology's patented DualBIOS™ technology you can reduce the possibility of hangs during system boot up, and/or loss BIOS data due to above reasons. This new technology will eliminate valuable system down time and costly repair bills cause by BIOS failures.

III. Q: How does DualBIOS™ technology work?

Answer:

1. DualBIOS™ technology provides a wide range of protection during the boot up procedure. It protects your BIOS during system POST, ESCD update, and even all the way to PNP detection/assignment.
2. DualBIOS™ provides automatic recovery for the BIOS. When the first BIOS used during boot up does not complete or if a BIOS checksum error occurs, boot-up is still possible. In the DualBIOS™ utility, the "Auto Recovery" option will guarantee that if either the main BIOS or backup BIOS is corrupted, the DualBIOS™ technology will use the good BIOS and correct the wrong BIOS automatically.
3. DualBIOS™ provides manual recovery for the BIOS. DualBIOS™ technology contains a built-in flash utility, which can flash your system BIOS from backup to main and/or visa versa. There is no need for an OS-dependent flash utility program.
4. DualBIOS™ contains a one-way flash utility. The built-in one-way flash utility will ensure that the corrupt BIOS is not mistaken as the good BIOS during recovery and that the correct BIOS (main vs. backup) will be flashed. This will prevent the good BIOS from being flashed.

IV. Q: Who Needs DualBIOS™ technology?

Answer:

1. Every user should have DualBIOS™ technology due to the advancement of computer viruses.

Everyday, there are new BIOS-type viruses discovered that will destroy your system BIOS. Most commercial products on the market do not have solutions to guard against this type of virus intrusion. The DualBIOS™ technology will provide a state-of-the-art solution to protect your PC:

Case I.) Vicious computer viruses may wipe out your entire system BIOS. With a conventional single system BIOS PC, the PC will not be functional until it is sent for repairs.

Case II.) If the "Auto Recovery" option is enabled in the DualBIOS™ utility, and if a virus corrupts your system BIOS, the backup BIOS will automatically reboot the system and correct the main BIOS.

Case III.) A user may override booting from the main system BIOS. The DualBIOS™ utility may be entered to manually change the boot sequence to boot from the backup BIOS.

2. During or after a BIOS upgrade, if DualBIOS™ detects that the main BIOS is corrupt, the backup BIOS will take over the boot-up process automatically. Moreover, it will verify the main and backup BIOS checksums when booting-up. DualBIOS™ technology examines the checksum of the main and backup BIOS while the system is powered on to guarantee your BIOS operates properly.
3. Power Users will have the advantage of having two BIOS versions on their mainboard. The benefit is being able to select either version BIOS to suit the performance system needs.
4. Flexibility for high-end desktop PCs and workstation/servers. In the DualBIOS™ utility, the option can be set, "Halt On When BIOS Defects," to be enabled to halt your system with a warning message that the main BIOS has been corrupted. Most workstation/servers require constant operation to guarantee services have not been interrupted. In this situation, the "Halt On When BIOS Defects" message may be disabled to avoid system pauses during normal booting. Another advantage you gain from Giga-Byte's DualBIOS™ technology is the ability to upgrade from dual 2 Mbit BIOS to dual 4 Mbit BIOS in the future if extra BIOS storage is need.

Four Speaker & SPDIF Introduction (Optional)

Four Speaker Introduction

A. What is Four Speaker?

The Creative CT5880 audio chip can support 4 speaker output, if you select "Four speaker" out, Line in will be change to another line out.

B. How to use Four Speaker?

- a. Press the "Start" button and then select "Creative" → "Sound Blaster PCI128" → "Creative Configurator".

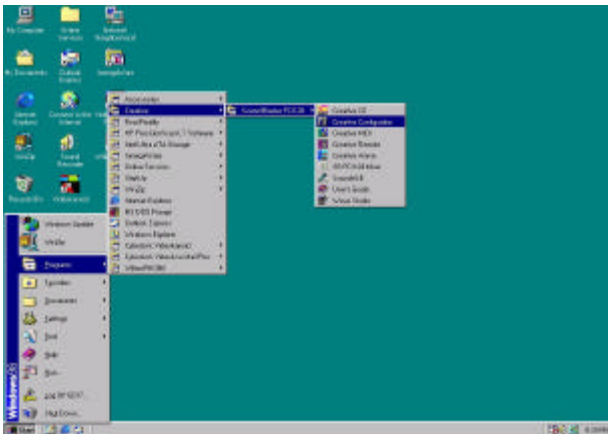

- b. Click "3D Configuration" item.

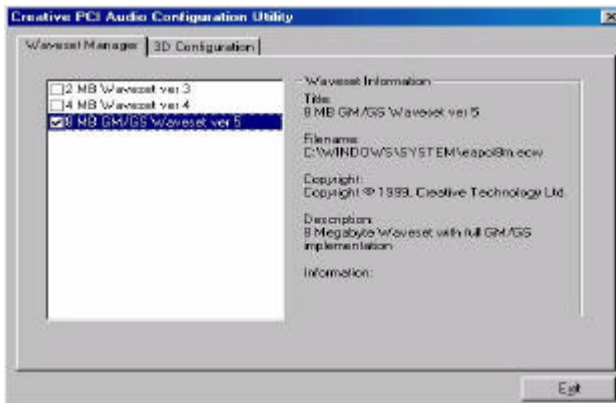

c. Two speaker (Default)

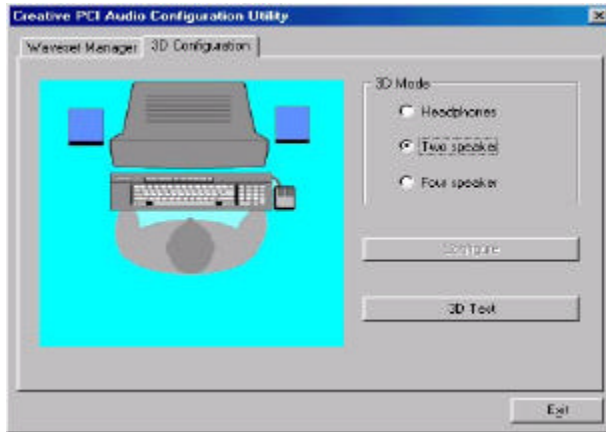

d. Click "Four speaker" item.

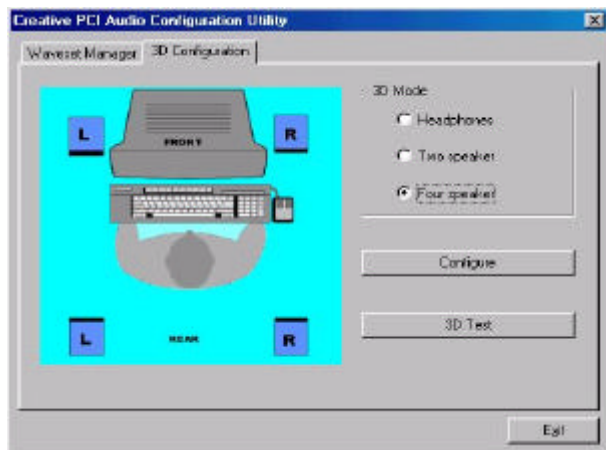

C. Four Speaker Application

The four speaker function will only support in application software that use Microsoft DirectX and Creative EAX. For example, the game titles, software DVD player and MP3 player. Those software support Microsoft DirectX, so they can support four speaker output.

SPDIF Introduction

A. What is SPDIF?

The SPDIF output is capable of providing digital audio to external speakers or compressed AC3 data to an external Dolby digital decoder.

B. How to use SPDIF?

- a. Press your mouse right button in “My Computer” and then select the “Properties” item.

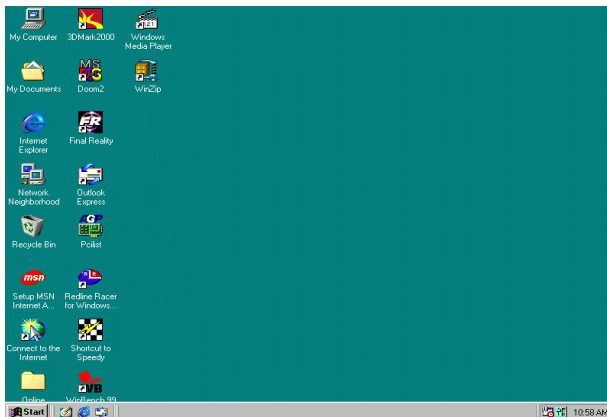

- b. Click “Device Manager” item.

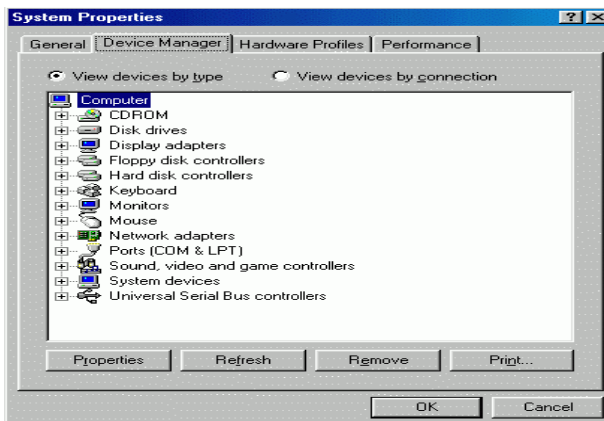

- c. Press "Sound, video and game controllers" item and then select the "Creative Sound Blaster PCI128" item.

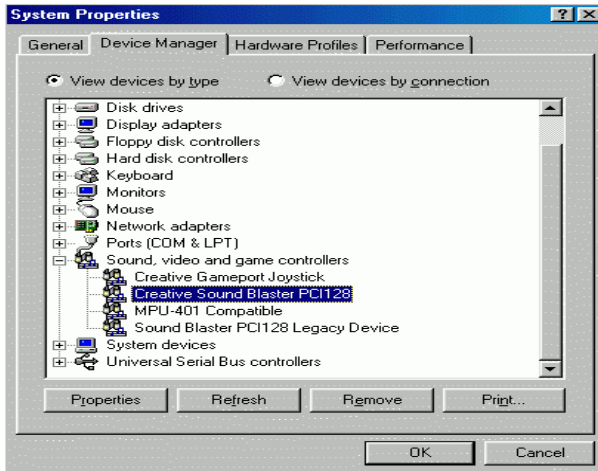

- d. Press "Settings" item and then select the "Output Mode" item.

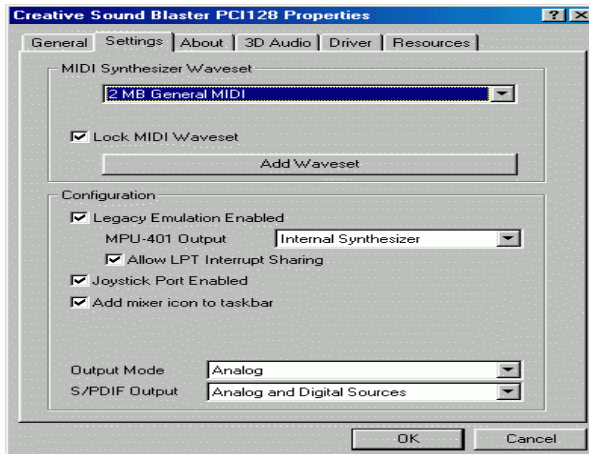

e. Click "Digital" item, Line Out will be change to SPDIF Out.

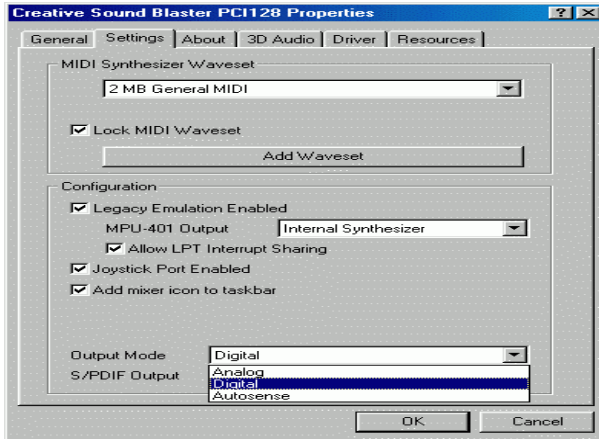

f. Recommend you to select "Autosense", it will auto detect the audio jack you plug in to Line Out is mono or stereo, and then change to SPDIF Out or Speaker out automatically.

Memory Installation

The motherboard has Rambus In-line Memory Module (RIMM) sockets. The BIOS will automatically detect memory type and size. To install the memory module, just push it vertically into the RIMM Slot. The RIMM module can only fit in one direction due to the two notch. Memory size can vary between sockets.

Install memory in any combination table:

RIMM 1	RIMM 2
RIMM	CRIMM
RIMM	RIMM
CRIMM	RIMM

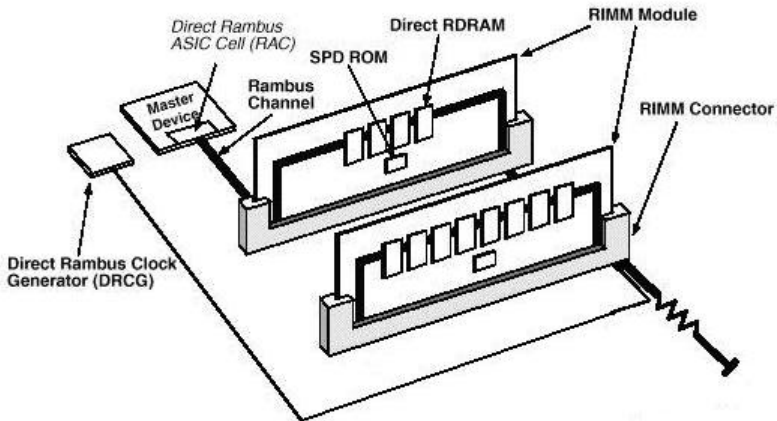

Introduce RIMM (Rambus In-line Memory Module)

Direct Rambus Memory Controller

⇒ Directly support a **single** Direct Rambus * Channel

- Supports 300&400 / 356&400 MHz Direct Rambus * Channel @ 100/133MHz host bus frequency.
- Maximum memory array size up to 256MB using 64Mb/72Mb, 512MB using 128Mb/144Mb, 1GB using 256Mb/288Mb DRAM technology

⇒ Supports up to 32 Direct Rambus devices per channel

⇒ Supports a maximum DRAM address decode space of 4GB

⇒ Configurable optional ECC operation

- ECC with single bit Error Correction and multiple bit Error Detection
- Single bit errors corrected and written back to memory (auto-scrubbing)
- Parity mode not supported

DRAM Interface

The MCH supports a single channel of Direct RDRAM memory using RSL technology. 300 and 400MHz Direct RDRAM devices are supported. 64, 128 and 256Mb technology Direct RDRAM devices are supported. A maximum of 32 Direct RDRAM devices (64Mb technology = 256MB max) are supported for a single channel. The following table shows the maximum DRAM array size and the minimum increment size for the various DRAM densities supported for MCH.

RDRAM Technology	Increments	Maximum
64Mb/72Mb	8MB	256MB
128Mb/144Mb	16MB	512MB
256Mb/288Mb	32MB	1GB

The MCH provides optional ECC error checking for DRAM data integrity. During DRAM writes ECC is generated on a QWORD (64bit) basis. Partial QWORD writes require a read-modify-write cycle when ECC is enabled. During DRAM reads, the MCH supports detection of single-bit and multiple-bit errors, and will correct single bit errors when correction is enabled. The MCH will automatically scrub single bit errors by writing the corrected value back into DRAM when scrubbing is enabled. ECC can only be enabled when the Direct RDRAMs support the extra two data bits used to store the ECC code.

The MCH provides a maximum DRAM address decode space of 4GB. The MCH does not remap APIC memory space in hardware. It is the BIOS or system designers responsibility to limit DRAM population so that adequate PCI, AGP, High BIOS, and APIC memory space can be allocated.

 Page Index for BIOS Setup	Page
The Main Menu	P.54
Standard CMOS Setup	P.57
BIOS Features Setup	P.60
Chipset Features Setup	P.62
Power Management Setup	P.64
PNP/ PCI Configuration	P.68
Load BIOS Defaults	P.70
Load Setup Defaults	P.71
Integrated Peripherals	P.72
Hardware Monitor Setup	P.76
Supervisor / User Password	P.78
IDE HDD Auto Detection	P.79
Save & Exit Setup	P.80
Exit Without Saving	P.81

BIOS Setup

BIOS Setup is an overview of the BIOS Setup Program. The program that allows users to modify the basic system configuration. This type of information is stored in battery-backed CMOS RAM so that it retains the Setup information when the power is turned off.

ENTERING SETUP

Power On the computer and press immediately will allow you to enter Setup. If the message disappears before you respond and you still wish to enter Setup, restart the system to try again by turning it OFF then ON or pressing the "RESET" bottom on the system case. You may also restart by simultaneously press <Ctrl> – <Alt>– keys.

CONTROL KEYS

<↑>	Move to previous item
<↓>	Move to next item
<←>	Move to the item in the left hand
<→>	Move to the item in the right hand
<Esc>	Main Menu - Quit and not save changes into CMOS Status Page Setup Menu and Option Page Setup Menu - Exit current page and return to Main Menu
<+ / PgUp>	Increase the numeric value or make changes
<- / PgDn>	Decrease the numeric value or make changes
<F1>	General help, only for Status Page Setup Menu and Option Page Setup Menu
<F2>	Reserved
<F3>	Reserved
<F4>	Reserved
<F5>	Restore the previous CMOS value from CMOS, only for Option Page Setup Menu
<F6>	Load the default CMOS value from BIOS default table, only for Option Page Setup Menu
<F7>	Load the Setup Defaults
<F8>	Reserved
<F9>	Reserved
<F10>	Save all the CMOS changes, only for Main Menu

GETTING HELP

Main Menu

The on-line description of the highlighted setup function is displayed at the bottom of the screen.

Status Page Setup Menu / Option Page Setup Menu

Press F1 to pop up a small help window that describes the appropriate keys to use and the possible selections for the highlighted item. To exit the Help Window press <Esc>.

The Main Menu

Once you enter AMI BIOS CMOS Setup Utility, the Main Menu (Figure 1) will appear on the screen. The Main Menu allows you to select from nine setup functions and two exit choices. Use arrow keys to select among the items and press <Enter> to accept or enter the sub-menu.

AMIBIOS SIMPLE SETUP UTILITY – VERSION 1.22 (C) 1999 American Megatrends, Inc. All Rights Reserved	
STANDARD CMOS SETUP	INTEGRATED PERIPHERALS
BIOS FEATURES SETUP	HARDWARE MONITOR SETUP
CHIPSET FEATURES SETUP	SUPERVISOR PASSWORD
POWER MANAGEMENT SETUP	USER PASSWORD
PNP / PCI CONFIGURATION	IDE HDD AUTO DETECTION
LOAD BIOS DEFAULTS	SAVE & EXIT SETUP
LOAD SETUP DEFAULTS	EXIT WITHOUT SAVING
ESC: Quit ↑↓→← : Select Item (Shift)F2 : Change Color F5: Old Values F6: Load BIOS Defaults F7: Load Setup Defaults F10: Save & Exit	
Time, Date , Hard Disk Type...	

Figure 1: Main Menu

- **Standard CMOS Setup**

This setup page includes all the items in standard compatible BIOS.
- **BIOS Features Setup**

This setup page includes all the items of AMI special enhanced features.
- **Chipset Features Setup**

This setup page includes all the items of chipset special features.
- **Power Management Setup**

This setup page includes all the items of Green function features.
- **PnP/PCI Configuration**

This setup page includes all the configurations of PCI & PnP ISA resources.
- **Load BIOS Defaults**

BIOS Defaults indicates the value of the system parameters which the system would be in safe configuration.
- **Load Setup Defaults**

Setup Defaults indicates the value of the system parameters which the system would be in best performance configuration.
- **Integrated Peripherals**

This setup page includes all onboard peripherals.
- **Hardware Monitor Setup**

This setup page is the System auto detect Temperature, voltage, fan, speed.
- **Supervisor password**

Change, set, or disable password. It allows you to limit access to the system and Setup, or just to Setup.
- **User password**

Change, set, or disable password. It allows you to limit access to the system.
- **IDE HDD Auto Detection**

Automatically configure hard disk parameters.

- **Save & Exit Setup**

Save CMOS value settings to CMOS and exit setup.

- **Exit Without Saving**

Abandon all CMOS value changes and exit setup.

Standard CMOS Setup

The items in Standard CMOS Setup Menu (Figure 2) are divided into 9 categories. Each category includes no, one or more than one setup items. Use the arrows to highlight the item and then use the <PgUp> or <PgDn> keys to select the value you want in each item.

AMIBIOS SETUP – STANDARD CMOS SETUP	
(C) 1999 American Megatrends, Inc. All Rights Reserved	
Date (mm/dd/yyyy) : Tue Jan 18, 2000	
Time (hh/mm/ss) : 14:44:35	
TYPE SIZE CYLS HEAD PRECOMP LANDZ SECTOR MODE	
Pri Master Auto	
Pri Slave Auto	
Sec Master Auto	
Sec Slave Auto	
Floppy Drive A : 1.44 MB 3½	Base Memory : 640 Kb
Floppy Drive B : Not Installed	Other Memory : 384 Kb
	Extended Memory : 127 Mb
	Total Memory : 128Mb
Boot Sector Virus Protection : Disabled	
Month : Jan – Dec	ESC : Exit
Day : 01– 31	↑↓ : Select Item
Year : 1990 – 2099	PU / PD / + / - :Modify
	(Shift) F2 : Color

Figure 2: Standard CMOS Setup

- **Date**

The date format is <Week> <Month> <Day>, <Year>.

Week	The week, from Sun to Sat, determined by the BIOS and is display-only
Month	The month, Jan. Through Dec.
Day	The day, from 1 to 31 (or the maximum allowed in the month)
Year	The year, from 1990 through 2099

- **Time**

The times format in <hour> <minute> <second>. The time is calculated base on the 24-hour military-time clock. For example, 1 p.m. is 13:00:00.

• **Primary Master, Slave / Secondary Master, Slave**

The category identifies the types of hard disk from drive C to F that has been installed in the computer. There are two types: auto type, and user definable type. User type is user-definable; Auto type which will automatically detect HDD type.

Note that the specifications of your drive must match with the drive table. The hard disk will not work properly if you enter improper information for this category.

If you select User Type, related information will be asked to enter to the following items. Enter the information directly from the keyboard and press <Enter>. Such information should be provided in the documentation form your hard disk vendor or the system manufacturer.

CYLS.	Number of cylinders
HEADS	number of heads
PRECOMP	write precomp
LANDZONE	Landing zone
SECTORS	number of sectors

If a hard disk has not been installed select NONE and press <Enter>.

• **Floppy Drive A type / Drive B**

The category identifies the types of floppy disk drive A or drive B that has been installed in the computer.

None	No floppy drive installed.
360K, 5.25 in.	5.25 inch PC-type standard drive; 360K byte capacity.
1.2M, 5.25 in.	5.25 inch AT-type high-density drive; 1.2M byte capacity (3.5 inch when 3 Mode is Enabled).
720K, 3.5 in.	3.5 inch double-sided drive; 720K byte capacity.
1.44M, 3.5 in.	3.5 inch double-sided drive; 1.44M byte capacity.
2.88M, 3.5 in.	3.5 inch double-sided drive; 2.88M byte capacity.

- **Boot Sector Virus Protection**

If it is set to enable, the category will flash on the screen when there is any attempt to write to the boot sector or partition table of the hard disk drive. The system will halt and the following error message will appear in the mean time. You can run anti-virus program to locate the problem.

Enabled	Activate automatically when the system boots up causing a warning message to appear when anything attempts to access the boot sector or hard disk partition table
Disabled	No warning message to appear when anything attempts to access the boot sector or hard disk partition table (Default Value)

- **Memory**

The category is display-only which is determined by POST (Power On Self Test) of the BIOS.

Base Memory

The POST of the BIOS will determine the amount of base (or conventional) memory installed in the system.

The value of the base memory is typically 512 K for systems with 512 K memory installed on the motherboard, or 640 K for systems with 640 K or more memory installed on the motherboard.

Other Memory

This refers to the memory located in the 640 K to 1024 K address space. This is memory that can be used for different applications.

DOS uses this area to load device drivers to keep as much base memory free for application programs. Most use for this area is Shadow RAM.

Extended Memory

The BIOS determines how much extended memory is present during the POST. This is the amount of memory located above 1 MB in the CPU's memory address map.

BIOS Features Setup

AMIBIOS SETUP – BIOS FEATURES SETUP (C) 1999 American Megatrends, Inc. All Rights Reserved	
1st Boot Device	Floppy
2nd Boot Device	IDE-0
3rd Boot Device	CDROM
S.M.A.R.T. for Hard Disks	Disabled
BootUp Num-Lock	On
Floppy Drive Seek	Disabled
Password Check	Setup
※Processor Serial Number	Enabled
BIOS Write Protect	Disabled
ESC: Quit ↑↓→←: Select Item F1 : Help PU/PD+/-/: Modify F5 :Old Values (Shift)F2:Color F6 : Load BIOS Defaults F7 : Load Setup Defaults	

Figure 3: BIOS Features Setup

※System will detect automatically and show up when you install the Pentium®!!! processor.

- **1st / 2nd / 3rd Boot Device**

Floppy	Boot Device by Floppy.
LS/ZIP A:	Boot Device by LS/ZIP A:.
CDROM	Boot Device by CDROM.
SCSI	Boot Device by SCSI.
NETWORK	Boot Device by NETWORK.
IDE-0-IDE-3	Boot Device by IDE-0-IDE-3.
Disabled	Boot Device by Disabled.
ATAPI ZIP C:	Boot Device by ATAPI ZIP C:.

- **S.M.A.R.T. for Hard Disks**

Enabled	Enabled S.M.A.R.T. Hard for Disks.
Disabled	Disabled S.M.A.R.T. Hard for Disks. (Default Value)

- **Boot Up Num-Lock**

On	Keypad is number keys. (Default Value)
Off	Keypad is arrow keys.

- **Floppy Drive Seek**

During POST, BIOS will determine if the floppy disk drive installed is 40 or 80 tracks. 360 type is 40 tracks while 720, 1.2 and 1.44 are all 80 tracks.

Enabled	BIOS searches for floppy disk drive to determine if it is 40 or 80 tracks. Note that BIOS can not tell from 720, 1.2 or 1.44 drive type as they are all 80 tracks.
Disabled	BIOS will not search for the type of floppy disk drive by track number. Note that there will not be any warning message if the drive installed is 360. (Default Value)

- **Password Check**

Setup	Set Password Check to Setup. (Default Value)
Always	Set Password Check to Always.

- **Processor Serial Number**

This item will show up when you install the Pentium®!!! processor.

Disabled	Disable this function.
Enabled	Pentium® !!! Processor Number Feature. (Default Value)

- **BIOS Write Protect**

Enabled	Enabled BIOS Write Protect.
Disabled	Disabled BIOS Write Protect. (Default Value)

Chipset Features Setup

AMIBIOS SETUP – CHIPSET FEATURES SETUP	
(C) 1999 American Megatrends, Inc. All Rights Reserved	
Direct Rambus Clock	Auto
ICH Delayed Transaction	Enabled
ICH DCB Enable	Disabled
Graphics Aperture Size	64 MB
ClkGen Spread Spectrum	Enabled
CPU Ratio Selection	3.0x
USB Controller	Enabled
USB Legacy Support	Disabled
◆AOL Support	Enabled
ESC: Quit ↑↓→←: Select Item F1 : Help PU/PD+/-/: Modify F5 :Old Values (Shift)F2:Color F6 : Load BIOS Defaults F7 : Load Setup Defaults	

Figure 4: Chipset Features Setup

◆The “AOL Support” option will only be displayed if your hardware supports this function.

• Direct Rambus Clock

300/356Mhz	Set Direct Rambus Clock to 300/356Mhz.(Depend on CPU)
400Mhz	Set Direct Rambus Clock to 400Mhz.
Auto	Set Direct Rambus Clock to Auto. (Default Value)

• ICH Delayed Transaction

Disabled	Disabled ICH Delayed Transaction.
Enabled	Enabled ICH Delayed Transaction. (Default Value)

• ICH DCB Enable

Disabled	Disable ICH DCB. (Default Value)
Enabled	Enable ICH DCB.

• Graphics Aperture Size

4 MB	Display Graphics Aperture Size is 4MB.
8 MB	Display Graphics Aperture Size is 8MB.
16 MB	Display Graphics Aperture Size is 16MB.
32 MB	Display Graphics Aperture Size is 32MB.
64 MB	Display Graphics Aperture Size is 64MB. (Default Value)

128 MB	Display Graphics Aperture Size is 128MB.
256 MB	Display Graphics Aperture Size is 256MB.

- **ClkGen Spread Spectrum**

Disabled	Disabled ClkGen Spread Spectrum function.
Enabled	Enabled ClkGen Spread Spectrum function. (Default Value)

- **CPU Ratio Selection**

3.0x/3.5x/4.0x/4.5x/5.0x/5.5x/6.0x/6.5x/7.0x/7.5x/8.0x/Locked

- **USB Controller**

Disabled	Disabled USB Controller function.
Enabled	Enabled USB Controller function. (Default Value)

- **USB Legacy Support**

USB Legacy Support can be set when USB Function is Enabled.

Disabled	Disabled USB Legacy Support. (Default Value)
Keyb+ Mouse	USB Keyboard and Mouse Support.
Keyboard	USB Keyboard Support.

- **AOL Support**

Disabled	Disabled this function.
Enabled	For Alert On Lan function. (Default value)

Power Management Setup

AMBIOS SETUP – POWER MANAGEMENT SETUP (C) 1999 American Megatrends, Inc. All Rights Reserved			
ACPI Sleep Type	S1/POS	RTC Alarm Date	Every Day
USB KB/MS Wakeup From S3	Disabled	RTC Alarm Hour	00
HDD Power Down	Disabled	RTC Alarm Minute	00
Suspend Mode	Disabled	RTC Alarm Second	00
KB & PS/2 Mouse Access	Monitor		
FDC/LPT/COM Ports Access	Monitor		
Pri. Master IDE Access	Monitor		
Pri. Slave IDE Access	Ignore		
Sec. Master IDE Access	Monitor		
Sec. Slave IDE Access	Ignore		
PIRQ[A] IRQ Active	Ignore		
PIRQ[B] IRQ Active	Ignore		
PIRQ[C] IRQ Active	Ignore		
PIRQ[D] IRQ Active	Ignore		
Soft-Off by Power Button	Instant Off		
System After AC Back	Soft-Off	ESC: Quit	↑↓→←: Select Item
Modem Use IRQ	4	F1 : Help	PU/PD+/-/: Modify
Modem Ring On/Wake On Lan	Enabled	F5 :Old Values (Shift)F2:Color	
PME Event Wake Up	Enabled	F6 : Load BIOS Defaults	
Resume by Alarm	Disabled	F7 : Load Setup Defaults	

Figure 5: Power Management Setup

- ACPI Sleep Type**

S1/POS	Set ACPI Sleep Type is S1/POS. (Default value)
S3/STR	Set ACPI Sleep Type is S3/STR.

- USB KB/MS Wakeup From S3**

USB KB Wakeup From S3 can be set when ACPI Sleep Type set to S3/STR.

Enabled	Enabled USB KB/MS Wakeup From S3.
Disabled	Disabled USB KB/MS Wakeup From S3. (Default value)

- HDD Power Down**

Disabled	Disabled HDD Power Down mode function. (Default value)
Suspend	Set HDD Power Down to Suspend.
Stand By	Set HDD Power Down to Stand By.

- **Suspend Mode (Minute)**

Disabled	Disabled Suspend Mode Function. (Default Value)
1	Enabled Suspend Mode after 1min.
2	Enabled Suspend Mode after 2min.
4	Enabled Suspend Mode after 4min.
8	Enabled Suspend Mode after 8min.
10	Enabled Suspend Mode after 10min.
20	Enabled Suspend Mode after 20min.
30	Enabled Suspend Mode after 30min.
40	Enabled Suspend Mode after 40min.
50	Enabled Suspend Mode after 50min.
60	Enabled Suspend Mode after 60min.

- **KB & PS/2 Mouse Access**

Monitor	Monitor Keyboard & PS/2 Mouse Access. (Default Value)
Ignore	Ignore Keyboard & PS/2 Mouse Access.

- **FDC/LPT/COM Ports Access**

Monitor	Monitor FDC/LPT/COM Ports Access. (Default Value)
Ignore	Ignore FDC/LPT/COM Ports Access.

- **Pri. Master IDE Access**

Monitor	Monitor Primary Master IDE Access. (Default Value)
Ignore	Ignore Primary Master IDE Access.

- **Pri. slave IDE Access**

Monitor	Monitor Primary slave IDE Access.
Ignore	Ignore Primary slave IDE Access. (Default Value)

- **Sec. Master IDE Access**

Monitor	Monitor Secondary Master IDE Access. (Default Value)
Ignore	Ignore Secondary Master IDE Access.

- **Sec. slave IDE Access**

Monitor	Monitor Secondary slave IDE Access.
Ignore	Ignore Secondary slave IDE Access. (Default Value)

- **PIRQ[A] IRQ Active**

Monitor	Monitor PIRQ[A] IRQ Active.
Ignore	Ignore PIRQ[A] IRQ Active. (Default Value)

- **PIRQ[B] IRQ Active**

Monitor	Monitor PIRQ[B] IRQ Active.
Ignore	Ignore PIRQ[B] IRQ Active. (Default Value)

- **PIRQ[C] IRQ Active**

Monitor	Monitor PIRQ[C] IRQ Active.
Ignore	Ignore PIRQ[C] IRQ Active. (Default Value)

- **PIRQ[D] IRQ Active**

Monitor	Monitor PIRQ[D] IRQ Active.
Ignore	Ignore PIRQ[D] IRQ Active. (Default Value)

- **Soft-off by Power Button**

Instant-off	Press power button then Power off instantly. (Default Value)
Delay 4 Sec.	Press power button 4 sec to Power off. Enter suspend if button is pressed less than 4 sec.

- **System After AC Back Function**

Memory	System power on depends on the status before AC lost.
Soft-Off	Always in Off state when AC back. (Default value)
Full-On	Always power on the system when AC back.

- **MODEM Use IRQ**

3, 4 (Default Value) 5, 7, N/A

- **Modem Ring On / Wake On Lan**

Disabled	Disabled Modem Ring On / Wake On Lan.
Enabled	Enabled Modem Ring On / Wake On Lan. (Default Value)

- **PME Event Wake Up**

Disabled	Disabled PME Event Wake Up.
Enabled	Enabled PME Event Wake Up. (Default Value)

- **Resume by Alarm**

You can set "Resume by Alarm" item to Enabled and key in date/time to power on system.

Disabled	Disabled this function. (Default Value)
Enabled	Enabled alarm function to POWER ON system.

If the "Resume by Alarm" is Enabled.

Alarm Date:	Every Day, 1-31
Alarm Hour:	0-23
Alarm Minute:	0-59
Alarm Second:	0-59

PNP/PCI Configuration

AMIBIOS SETUP – PNP / PCI CONFIGURATION	
(C) 1999 American Megatrends, Inc. All Rights Reserved	
PnP OS Installed	No
Reset Configuration Data	Disabled
VGA Boot From	AGP
PCI/VGA Palette Snoop	Disabled
DMA-0	PnP
DMA-1	PnP
DMA-3	PnP
DMA-5	PnP
DMA-6	PnP
DMA-7	PnP
IRQ-3	PCI/PnP
IRQ-4	PCI/PnP
IRQ-5	PCI/PnP
IRQ-7	PCI/PnP
IRQ-9	PCI/PnP
IRQ-10	PCI/PnP
IRQ-11	PCI/PnP
ESC: Quit ↑↓→←: Select Item F1 : Help PU/PD+/-: Modify F5 : Old Values (Shift)F2:Color F6 : Load BIOS Defaults F7 : Load Setup Defaults	

Figure 6: PNP/ PCI Configuration

- **PNP OS Installed**

Yes	Enable PNP OS Installed function.
No	Disable PNP OS Installed function. (Default Value)

- **Reset Configuration Data**

Disabled	Disabled this function. (Default Value)
Enabled	Enabled Reset Configuration Data function.

- **VGA Boot From**

AGP	Set VGA Boot From AGP. (Default Value)
PCI	Set VGA Boot From PCI.

- **PCI/VGA Palette Snoop**

Enabled	For having Video Card on ISA Bus and VGA Card on PCI Bus.
Disabled	For VGA Card only. (Default Value)

- **DMA (0,1,3,5,6,7)**

ISA/ EISA	The resource is used by Legacy ISA device.
PnP	The resource is used by PnP device.

- **IRQ (3,4,5,7,9,10,11)**

ISA/ EISA	The resource is used by Legacy ISA device.
PCI/ PnP	The resource is used by PCI/ PnP device.

Load BIOS Defaults

AMIBIOS SIMPLE SETUP UTILITY-VERSION 1.22 (C) 1999 American Megatrends, Inc. All Rights Reserved	
STANDARD CMOS SETUP	INTEGRATED PERIPHERALS
BIOS FEATURES SETUP	HARDWARE MONITOR SETUP
CHIPSET FEATURES SETUP	SUPERVISOR PASSWORD
POWER MANAGEMENT SETUP	USER PASSWORD
PNP/PCI CONFIGURATION	LOAD BIOS Defaults (Y/N)?
LOAD BIOS DEFAULTS	SAVE & EXIT SETUP
LOAD SETUP DEFAULTS	EXIT WITHOUT SAVING
ESC : Quit ↑↓→← : Select Item (Shift) F2 : Change Color F5 : Old Values F6 : Load BIOS Defaults F7: Load Setup Defaults F10: Save & Exit	
Load BIOS Defaults except Standard CMOS SETUP	

Figure 7: Load BIOS Defaults

- **Load BIOS Defaults**

To load BIOS defaults value to CMOS, enter "Y". If not, enter "N".

Load Setup Defaults

AMIBIOS SIMPLE SETUP UTILITY-VERSION 1.22 (C) 1999 American Megatrends, Inc. All Rights Reserved	
STANDARD CMOS SETUP	INTEGRATED PERIPHERALS
BIOS FEATURES SETUP	HARDWARE MONITOR SETUP
CHIPSET FEATURES SETUP	SUPERVISOR PASSWORD
POWER MANAGE	Load Setup Defaults (Y/N)?
PNP/PCI CONFIG	
LOAD BIOS DEFAULTS	SAVE & EXIT SETUP
LOAD SETUP DEFAULTS	EXIT WITHOUT SAVING
ESC : Quit ↑↓→← : Select Item (Shift) F2 : Change Color F5 : Old Values F6 : Load BIOS Defaults F7: Load Setup Defaults F10: Save & Exit	
Load Setup Defaults except Standard CMOS SETUP	

Figure 8: Load Setup Defaults

- **Load SETUP Defaults**

To load SETUP defaults value to CMOS, enter "Y". If not, enter "N".

Integrated Peripherals

AMIBIOS SETUP – INTEGRATED PERIPHERALS (C) 1999 American Megatrends, Inc. All Rights Reserved			
On-Chip PCI IDE	Both	Mouse PowerOn Function	Disabled
AC97 Audio	Auto		
AC97 Modem	Auto		
OnBoard FDC Controller	Auto		
OnBoard Serial Port A	Auto		
OnBoard Serial Port B	Auto		
Serial Port B Mode	Normal		
*IR Duplex Mode	N/A		
OnBoard CIR Port	Disabled		
CIR IRQ Select	10		
OnBoard Parallel Port	Auto		
Parallel Port Mode	ECP		
Parallel Port IRQ	Auto		
Parallel Port DMA	Auto		
◆OnBoard Midi Port	330		
◆Midi IRQ Select	10	ESC: Quit	↑↓→←: Select Item
◆OnBoard Game Port	201	F1 : Help	PU/PD+/-/: Modify
Keyboard PowerOn Function	Disabled	F5 :Old Values (Shift)F2:Color	
Specific Key for PowerOn	N/A	F6 : Load BIOS Defaults	
		F7 : Load Setup Defaults	

Figure 9: Integrated Peripherals

- *This item will be available when "Serial Port B Mode" is set to IrDA (1.6 μ S), IrDA (3/16) or ASKIR.
- ◆These three items will be shown when there are only AC'97 CODEC sound.

- **On-Chip PCI IDE**

Disabled	Disabled On-Chip PCI IDE.
Both	Set On-Chip PCI IDE is Both. (Default Value)
Primary	Set On-Chip PCI IDE is Primary.
Secondary	Set On-Chip PCI IDE is Secondary.

- **AC'97 Audio**

Auto	Auto Detect AC'97 Audio. (Default Value)
Disabled	Disabled AC'97 Audio.

- **AC'97 Modem**

Auto	Auto Detect AC'97 Modem. (Default Value)
Disabled	Disabled AC'97 Modem.

- **OnBoard FDC Controller**

Auto	Set OnBoard FDC Controller is Auto. (Default Value)
Disabled	Disabled OnBoard FDC Controller.
Enabled	Enabled OnBoard FDC Controller.

- **OnBoard Serial Port A**

Auto	BIOS will automatically setup the port A address. (Default Value)
3F8/COM1	Enable OnBoard Serial port A and address is 3F8.
2F8/COM2	Enable OnBoard Serial port A and address is 2F8.
3E8/COM3	Enable OnBoard Serial port A and address is 3E8.
2E8/COM4	Enable OnBoard Serial port A and address is 2E8.
Disabled	Disable OnBoard Serial port A.

- **OnBoard Serial Port B**

Auto	BIOS will automatically setup the port B address. (Default Value)
3F8/COM1	Enable OnBoard Serial port B and address is 3F8.
2F8/COM2	Enable OnBoard Serial port B and address is 2F8.
3E8/COM3	Enable OnBoard Serial port B and address is 3E8.
2E8/COM4	Enable OnBoard Serial port B and address is 2E8.
Disabled	Disable OnBoard Serial port B.

- **Serial Port B Mode**

(This item allows you to determine which Serial Port B Mode of onboard I/O chip)

Normal	Set onboard I/O chip Serial Port B to Normal Mode. (Default Value)
IrDA (1.6 μ S)	Set onboard I/O chip Serial Port B to IrDA (1.6 μ S Baud Rate)mode.
IrDA (3/16)	Set onboard I/O chip Serial Port B to IrDA (3/16) Mode.
ASKIR	Set onboard I/O chip Serial Port B to ASKIR Mode.

- **IR Duplex Mode**

N/A	Disabled this function. (Default Value)
Half Duplex	IR Function Duplex Half.
Full Duplex	IR Function Duplex Full.

- **OnBoard CIR port**

Disabled	Disabled OnBoard CIR port. (Default Value)
Enabled	Enabled OnBoard CIR port.

- **CIR IRQ Select**

IRQ 3 / 4 / 9 / 10 (Default Value) / 11
--

- **OnBoard Parallel port**

378	Enable OnBoard LPT port and address is 378.
278	Enable OnBoard LPT port and address is 278.
3BC	Enable OnBoard LPT port and address is 3BC.
Auto	Set OnBoard LPT port is Auto. (Default Value)
Disabled	Disable OnBoard LPT port.

- **Parallel Port Mode**

EPP	Using Parallel port as Enhanced Parallel Port.
ECP	Using Parallel port as Extended Capabilities Port. (Default Value)
Normal	Normal Operation.

- **Parallel Port IRQ**

7	Set Parallel Port IRQ is 7.
5	Set Parallel Port IRQ is 5.
Auto	Set Parallel Port IRQ is Auto. (Default Value)

- **Parallel Port DMA**

3	Set Parallel Port DMA is 3.
1	Set Parallel Port DMA is 1.
Auto	Set Parallel Port DMA is Auto. (Default Value)

- **OnBoard Midi Port**

Disabled	Disabled OnBoard Midi Port.
290	Set OnBoard Midi Port is 290.
292	Set OnBoard Midi Port is 292.
300	Set OnBoard Midi Port is 300.
330	Set OnBoard Midi Port is 330. (Default Value)

- **Midi IRQ Select**

IRQ 9 / 5 / 7 / 10 (Default Value)

- **OnBoard Game Port**

Disabled	Disabled OnBoard Game Port.
201	Set OnBoard Game Port is 201. (Default Value)
209	Set OnBoard Game Port is 209.

- **Keyboard Power On Function**

Disabled	Disable this function. (Default Value)
Specific Key	Set specific key to power on by keyboard.
Power Key	Set "Power key" to power on the system.

- **Specific Key for Power On**

N/A	Disable this function. (Default Value)
Password	Enter from 1 to 5 characters to set the Keyboard Power On Password.

- **Mouse Power On Function**

Disabled	Disable this function. (Default Value)
Left-button	Double click on PS/2 left button.
Right-button	Double click on PS/2 right button.

Hardware Monitor Setup

AMIBIOS SETUP – HARDWARE MONITOR SETUP			
(C) 1999 American Megatrends, Inc. All Rights Reserved			
ACPI Shut Down Temp.	Disabled	Battery	3.088V
CPU Temp. Alarm	70°C/158°F	+5V SB	4.896V
CPU Fan Fail Alarm	No		
Power Fan Fail Alarm	No		
System Fan Fail Alarm	No		
Reset Case Open Status	No		
Case Status	Closed		
Current CPU Temp.	35°C/ 95°F		
Current System Temp.	33°C/ 91°F		
Current CPU Fan Speed	5273 RPM		
Current System Fan Speed	0 RPM		
Current Power Fan Speed	0 RPM		
CPU VID	1.65 V		
Vcore	1.648V		
Vtt	1.488V		
Vio	3.298V		
+5.000V	5.168V		
+12.000V	12.106V		
-12.000V	-12.153V		
		ESC: Quit	↑↓→←: Select Item
		F1 : Help	PU/PD+/-/ : Modify
		F5 :Old Values (Shift)	F2:Color
		F6 : Load BIOS Defaults	
		F7 : Load Setup Defaults	

Figure 10: Hardware Monitor Setup

- **ACPI Shutdown Temp.**

(This function will be effective only for the operating systems that support ACPI Function.)

Disabled	Normal Operation. (Default Value)
60°C / 140°F	Monitor CPU Temp. at 60°C / 140°F, if Temp. > 60°C / 140°F system will automatically power off.
65°C / 149°F	Monitor CPU Temp. at 65°C / 149°F, if Temp. > 65°C / 149°F system will automatically power off.
70°C / 158°F	Monitor CPU Temp. at 70°C / 158°F, if Temp. > 70°C / 158°F system will automatically power off.
75°C / 167°F	Monitor CPU Temp. at 75°C / 167°F, if Temp. > 75°C / 167°F system will automatically power off.

- **CPU Temp. Alarm**

60°C / 140°F	Monitor CPU Temp. at 60°C / 140°F.
65°C / 149°F	Monitor CPU Temp. at 65°C / 149°F.
70°C / 158°F	Monitor CPU Temp. at 70°C / 158°F. (Default Value)
75°C / 167°F	Monitor CPU Temp. at 75°C / 167°F.
Disabled	Disabled this function.

- **Fan Fail Alarm**

CPU / Power / System

No	Fan Fail Alarm Function Disabled. (Default Value)
Yes	Fan Fail Alarm Function Enabled.

- **Reset Case Open Status**

- **Case Opened**

If the case is closed, "Case Opened" will show "No".

If the case have been opened, "Case Opened" will show "Yes" .

If you want to reset "Case Opened" value, set "Reset Case Open Status" to "Yes" and save CMOS, your computer will restart.

- **Current CPU Tempe.**

Detect CPU Temp. automatically.

- **Current System Tempe.**

Detect System Temp. automatically.

- **Current CPU Fan / System Fan / Power Fan Speed (RPM)**

Detect Fan speed status automatically.

- **Current CPU VID / Vcore / Vtt / Vio / ±12V / +5V / Battery / +5VSB**

Detect system's voltage status automatically.

Supervisor / User Password

When you select this function, the following message will appear at the center of the screen to assist you in creating a password.

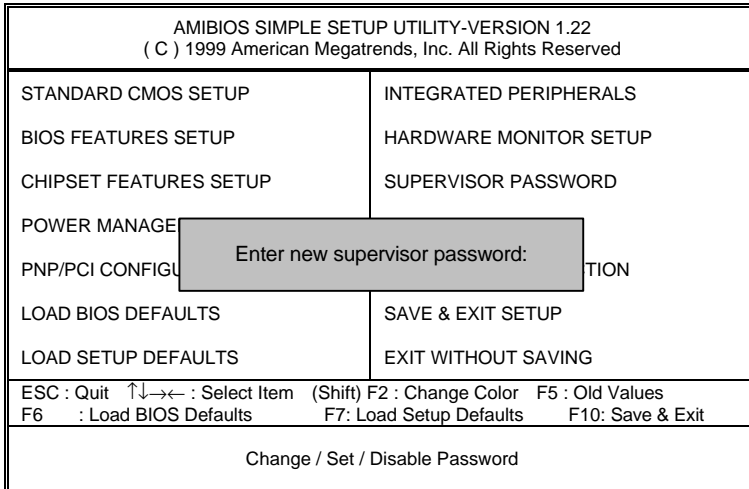

Figure 11: Password Setting

Type the password, up to eight characters, and press <Enter>. The password typed now will clear the previously entered password from CMOS memory. You will be asked to confirm the password. Type the password again and press <Enter>.

To disable password, just press <Enter> when you are prompted to enter password. A message "PASSWORD DISABLED" will appear to confirm the password being disabled. Once the password is disabled, the system will boot and you can enter Setup freely.

If you select Always at Password Check in BIOS Features Setup Menu, you will be prompted for the password every time the system is rebooted or any time you try to enter Setup Menu. If you select Setup at Password Check in BIOS Features Setup Menu, you will be prompted only when you try to enter Setup.

IDE HDD Auto Detection

AMBIOS SETUP – STANDARD CMOS SETUP (C) 1999 American Megatrends, Inc. All Rights Reserved						
Date (mm/dd/yyyy) : Tue Jan 18, 2000						
Time (hh/mm/ss) : 10:36:24						
	TYPE	SIZE	CYLS	HEAD	PRECOMP	LANDZ SECTOR
MODE						
Pri Master : Auto						
Pri Slave : Auto						
Sec Master: Auto						
Sec Slave : Auto						
Floppy Drive A: 1.44 MB 3 ½				Base Memory : 640 Kb		
Floppy Driver B: Not Installed				Other Memory: 384 Kb		
Boot Sector Virus Protection : Disabled				Extended Memory: 63Mb		
				Total Memory: 64Mb		
Month: Jan – Dec				ESC : Exit		
Day: 01 – 31				↑↓ : Select Item		
Year : 1990–2099				PU/PD/+/- : Modify		
				Shift)F2 : Color		

Figure 12: IDE HDD Auto Detection

Type "Y" will accept the H.D.D. parameter reported by BIOS.

Type "N" will keep the old H.D.D. parameter setup. If the hard disk cylinder number is over 1024, then the user can select LBA mode or LARGER mode for DOS partition larger than 528 MB.

Save & Exit Setup

AMIBIOS SIMPLE SETUP UTILITY-VERSION 1.22 (C) 1999 American Megatrends, Inc. All Rights Reserved	
STANDARD CMOS SETUP	INTEGRATED PERIPHERALS
BIOS FEATURES SETUP	HARDWARE MONITOR SETUP
CHIPSET FEATURES SETUP	SUPERVISOR PASSWORD
POWER MANAGE	
PNP/PCI CONFIG	ATION
LOAD BIOS DEFAULTS	SAVE & EXIT SETUP
LOAD SETUP DEFAULTS	EXIT WITHOUT SAVING
ESC : Quit ↑↓→← : Select Item (Shift) F2 : Change Color F5 : Old Values F6 : Load BIOS Defaults F7: Load Setup Defaults F10: Save & Exit	
Save Data to CMOS & Exit SETUP	

Figure 13: Save & Exit Setup

Type "Y" will quit the Setup Utility and save the user setup value to RTC CMOS.

Type "N" will return to Setup Utility.

Exit Without Saving

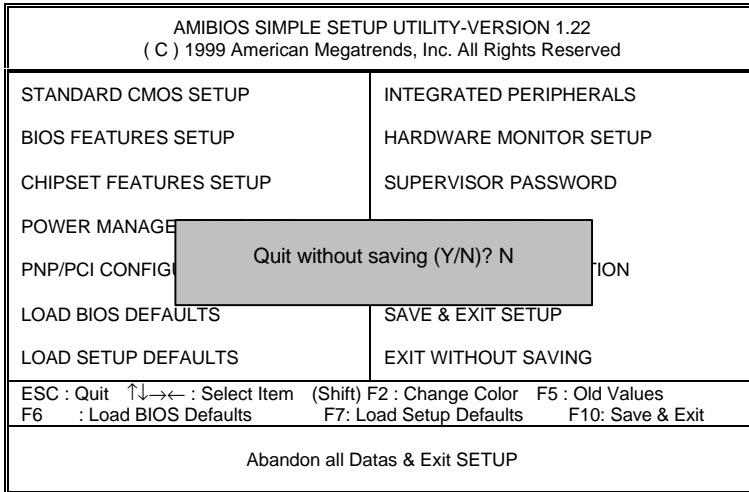

Figure 14: Exit Without Saving

Type "Y" will quit the Setup Utility and save the user setup value to RTC CMOS.

Type "N" will return to Setup Utility.

Appendix

Appendix A: Intel 820 Chipset Driver Installation

A. Windows 9x INF Update Utility

Insert the support CD that came with your motherboard into your CD-ROM drive or double-click the CD drive icon in **My Computer** to bring up the setup screen.



(1)

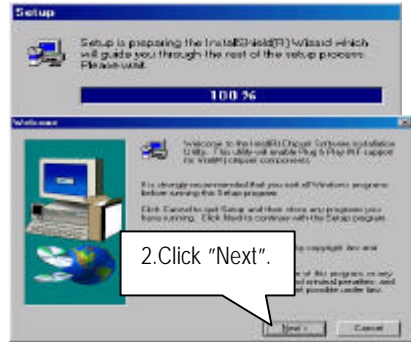

(2)

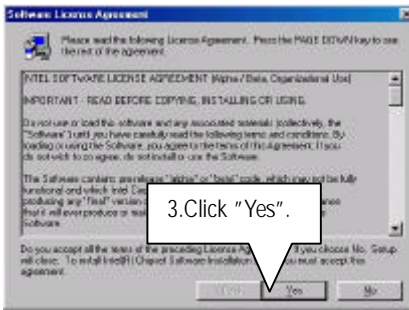

(3)

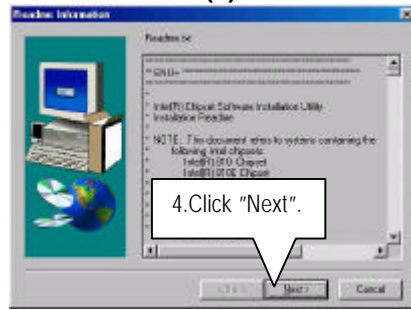

(4)

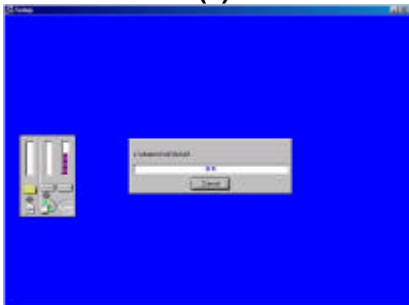

(5)

B. Intel ICH IDE ATA66 Driver Installation

Insert the support CD that came with your motherboard into your CD-ROM drive or double-click the CD drive icon in **My Computer** to bring up the setup screen.

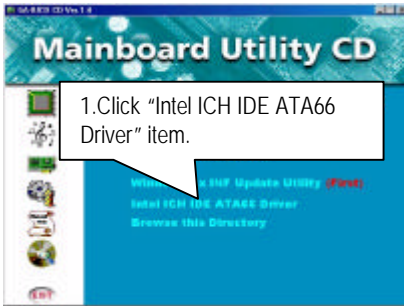

(1)

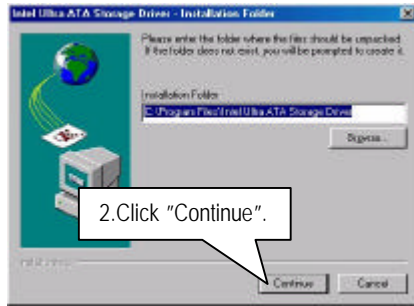

(2)

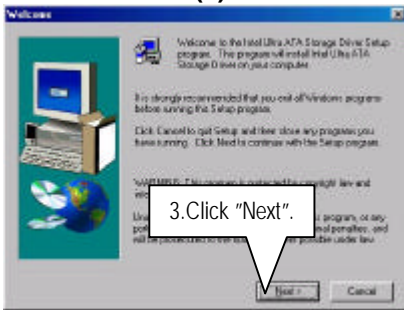

(3)

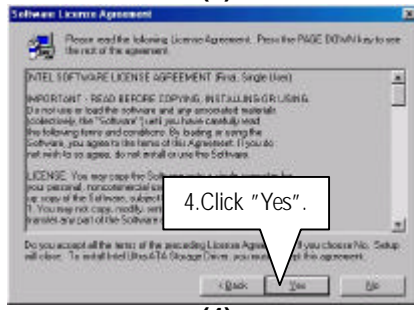

(4)



(5)

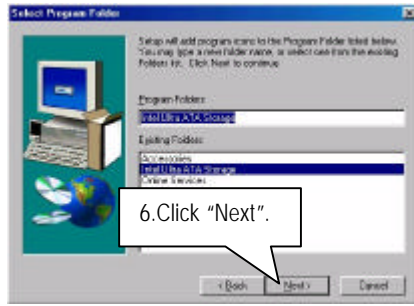

(6)

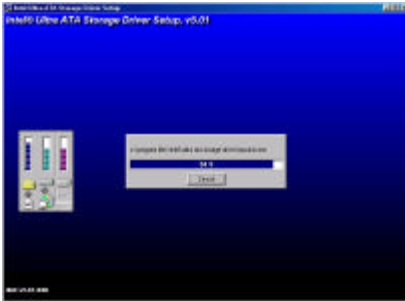

(7)

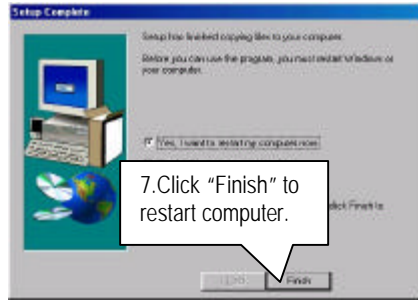

(8)

Appendix B: Intel 8255x Lan Driver Installation

Insert the support CD that came with your motherboard into your CD-ROM drive or double-click the CD drive icon in **My Computer** to bring up the setup screen.

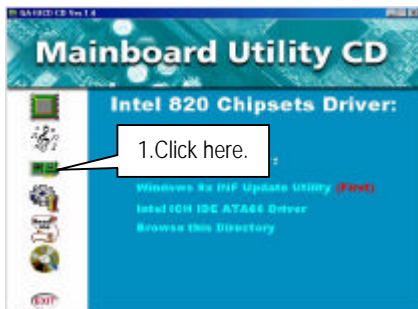

(1)



(2)



(3)

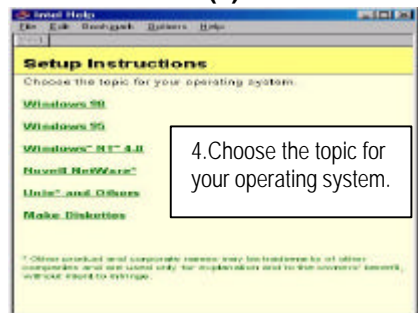

(4)

Appendix C: Creative Sound Driver Installation

Insert the support CD that came with your motherboard into your CD-ROM drive or double-click the CD drive icon in **My Computer** to bring up the setup screen.

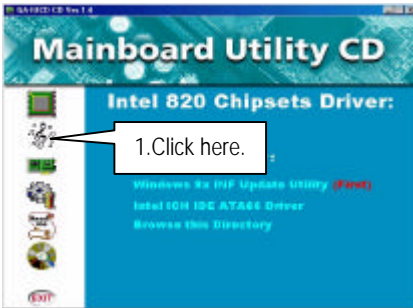

(1)

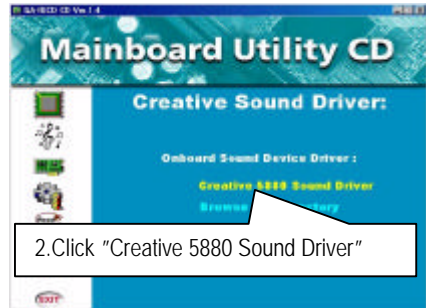

(2)



(3)

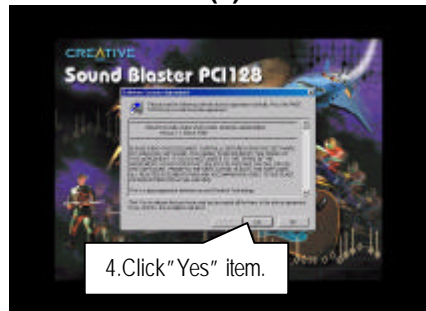

(4)

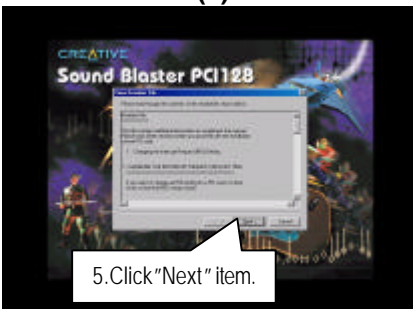

(5)

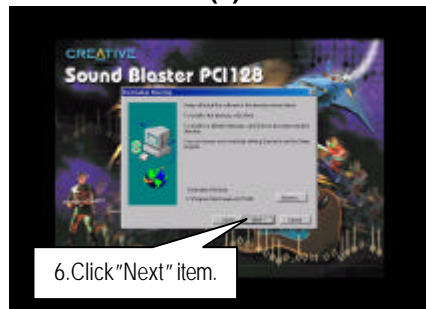

(6)

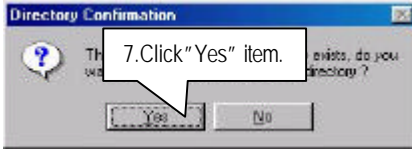

(7)

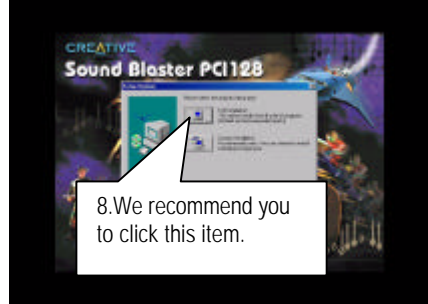

(8)

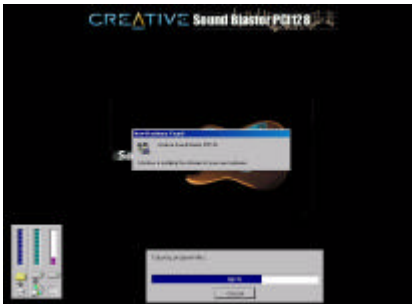

(9)

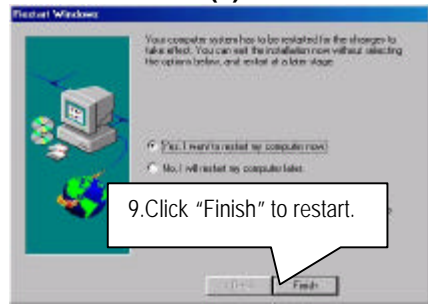

(10)

Appendix D: BIOS Flash Procedure

BIOS update procedure:

- ✓ Please check your BIOS vendor (AMI or AWARD) on the motherboard.
- ✓ It is recommended you copy the AWDFlash.exe or AMIFlash.exe in driver CD (D:\>Utility\BIOSFlash) and the BIOS binary files into the directory you made in your hard disk. **i** i.e:C:\>Utility\ (C:\>Utility : denotes the driver and the directory where you put the flash utilities and BIOS file in.) **j** **j**
- ✓ Restart your computer into MS-DOS mode or command prompt only for Win95/98, go into the directory where the new BIOS file are located use the utility AWDFlash.exe or AMIFlash.exe to update the BIOS.
- ✓ Type the following command once you have enter the directory where all the files are located C:\utility\ AWDFlash or AMIFlash <filename of the BIOS binary file intended for flashing>
- ✓ Once the process is finished, reboot the system
- **Note:** Please download the newest BIOS from our website (www.gigabyte.com.tw) or contact your local dealer for the file.

Appendix E: Introduce The Alert on LAN

The primary functions of the Alert on LAN *2 ASIC are to provide an interface to the 82559 and to the system monitoring critical system parameters and conditions, such as supply voltage detected, cover tamper, over temperature, link loss, and processor missing intrusion. If such a condition is detected, the Alert on LAN ASIC *2 transmits this information to the 82559. In response, the 82559 transmits alert ("SOS") packets to the remote console.

The Alert on LAN *2 ASIC transmits periodic presence packets (heartbeat) to the remote console. It support receiving specially filtered packets, in order to perform various Advanced Power Management modes(such as power-up, power-down and reset), And we very expected these operations to be available when software is unable to perform these functions (such as during a low power state or boot-up or when the operating system becomes inoperable)but are not precluded from running in the working state.

Appendix F: Acronyms

Acor.	Meaning
ACPI	Advanced Configuration and Power Interface
POST	Power-On Self Test
LAN	Local Area Network
ECP	Extended Capabilities Port
APM	Advanced Power Management
DMA	Direct Memory Access
MHz	Megahertz
ESCD	Extended System Configuration Data
CPU	Central Processing Unit
SMP	Symmetric Multi-Processing
USB	Universal Serial Bus
OS	Operating System
ECC	Error Checking and Correcting
IDE	Integrated Dual Channel Enhanced
SCI	Special Circumstance Instructions
LBA	Logical Block Addressing
EMC	Electromagnetic Compatibility
BIOS	Basic Input / Output System
SMI	System Management Interrupt
IRO	Interrupt Request
NIC	Network Interface Card
A.G.P.	Accelerated Graphics Port
S.E.C.C.	Single Edge Contact Cartridge
LED	Light Emitting Diode
EPP	Enhanced Parallel Port
CMOS	Complementary Metal Oxide Semiconductor
I/O	Input / Output
ESD	Electrostatic Discharge
OEM	Original Equipment Manufacturer
SRAM	Static Random Access Memory
VID	Voltage ID
DMI	Desktop Management Interface
MIDI	Musical Interface Digital Interface
IOAPIC	Input Output Advanced Programmable Input Controller
DIMM	Dual Inline Memory Module
DRAM	Dynamic Random Access Memory
PAC	PCI A.G.P. Controller
AMR	Audio Modem Riser

To be continued...

6CX7 Series Motherboard

Acor.	Meaning
PCI	Peripheral Component Interconnect
RIMM	Rambus in-line Memory Module
DRM	Dual Retention Mechanism
ISA	Industry Standard Architecture
MTH	Memory Translator Hub
CRIMM	Continuity RIMM