

FCC Compliance Statement:

<p style="text-align: center;">DECLARATION OF CONFORMITY Per FCC Part 2 Section 2.107(a)</p> <p style="text-align: center;">FC</p> <p>Responsible Party Name: G.B.T. INC.</p> <p style="text-align: center;">Address: 18365 Valley Blvd., Suite#A LA Puente, CA 91744</p> <p style="text-align: center;">Phone/Fax No: (818) 854-9338 / (818) 854-9339</p> <p>hereby declares that the product</p> <p style="text-align: center;">Product Name: Mother Board</p> <p style="text-align: center;">Model Number: GA-60MM7</p> <p>Conforms to the following specifications:</p> <p style="text-align: center;">FCC Part 15, Subpart B, Section 15.107(a) and Section 15.109(a), Class B Digital Device.</p> <p>Supplementary Information:</p> <p style="text-align: center;"><small>This device complies with part 15 of the FCC Rules. Operation is subject to the following two conditions: (1) This device may not cause harmful and (2) this device must accept any interference received, including that may cause undesired operation.</small></p> <p>Representative Person's Name: <u>ERIC LU</u></p> <p>Signature: <u>Eric Lu</u></p> <p>Date: <u>Jun 13, 2000</u></p>

This equipment has been tested and found to comply with limits for a Class B digital device, pursuant to Part 15 of the FCC rules. These limits are designed to provide reasonable protection against harmful interference in residential installations. This equipment generates, uses, and can radiate radio frequency energy, and if not installed and used in accordance with the instructions, may cause harmful interference to radio communications. However, there is no guarantee that interference will not occur in a particular installation. If this equipment does cause interference to radio or television equipment reception, which can be

determined by turning the equipment off and on, the user is encouraged to try to correct the interference by one or more of the following measures:

- Reorient or relocate the receiving antenna
- Move the equipment away from the receiver
- Plug the equipment into an outlet on a circuit different from that to which the receiver is connected
- Consult the dealer or an experienced radio/television technician for additional suggestions

You are cautioned that any change or modifications to the equipment not expressly approve by the party responsible for compliance could void Your authority to operate such equipment.

This device complies with Part 15 of the FCC Rules. Operation is subjected to the following two conditions 1) this device may not cause harmful interference and 2) this device must accept any interference received, including interference that may cause undesired operation.

Declaration of Conformity

We, Manufacturer/Importer
(full address)

G.B.T. Technology Trading GmbH
Ausschlagler Weg 41, 1F, 20537 Hamburg, Germany

declare that the product
(description of the apparatus, system, installation to which it refers)

Mother Board
GA-60MM7

is in conformity with
(reference to the specification under which conformity is declared)
in accordance with 89/336 EEC-EMC Directive

- | | | | |
|---|--|--|--|
| <input type="checkbox"/> EN 55011 | Limits and methods of measurement of radio disturbance characteristics of industrial, scientific and medical (ISM) high frequency equipment | <input checked="" type="checkbox"/> EN 61000-3-2*
<input checked="" type="checkbox"/> EN60555-2 | Disturbances in supply systems caused by household appliances and similar electrical equipment "Harmonics" |
| <input type="checkbox"/> EN55013 | Limits and methods of measurement of radio disturbance characteristics of broadcast receivers and associated equipment | <input type="checkbox"/> EN61000-3-3*
<input checked="" type="checkbox"/> EN60555-3 | Disturbances in supply systems caused by household appliances and similar electrical equipment "Voltage fluctuations" |
| <input type="checkbox"/> EN 55014 | Limits and methods of measurement of radio disturbance characteristics of household electrical appliances, portable tools and similar electrical apparatus | <input checked="" type="checkbox"/> EN 50081-1
<input checked="" type="checkbox"/> EN 50082-1 | Generic emission standard Part 1: Residual, commercial and light industry
Generic immunity standard Part 1: Residual, commercial and light industry |
| <input type="checkbox"/> EN 55015 | Limits and methods of measurement of radio disturbance characteristics of fluorescent lamps and luminaries | <input type="checkbox"/> EN 55081-2 | Generic emission standard Part 2: Industrial environment |
| <input type="checkbox"/> EN 55020 | Immunity from radio interference of broadcast receivers and associated equipment | <input type="checkbox"/> EN 55082-2 | Generic immunity standard Part 2: Industrial environment |
| <input checked="" type="checkbox"/> EN 55022 | Limits and methods of measurement of radio disturbance characteristics of information technology equipment | <input type="checkbox"/> ENV 55104 | Immunity requirements for household appliances tools and similar apparatus |
| <input type="checkbox"/> DIN VDE 0855
<input type="checkbox"/> part 10
<input type="checkbox"/> part 12 | Cabled distribution systems; Equipment for receiving and/or distribution from sound and television signals | <input type="checkbox"/> EN 50091- 2 | EMC requirements for uninterruptible power systems (UPS) |
| <input checked="" type="checkbox"/> CE marking | |  | (EC conformity marking) |

The manufacturer also declares the conformity of above mentioned product with the actual required safety standards in accordance with LVD 73/23 EEC

- | | | | |
|-----------------------------------|---|-------------------------------------|---|
| <input type="checkbox"/> EN 60065 | Safety requirements for mains operated electronic and related apparatus for household and similar general use | <input type="checkbox"/> EN 60950 | Safety for information technology equipment including electrical business equipment |
| <input type="checkbox"/> EN 60335 | Safety of household and similar electrical appliances | <input type="checkbox"/> EN 50091-1 | General and Safety requirements for uninterruptible power systems (UPS) |

Manufacturer/Importer

Signature : Rex Lin
Name : Rex Lin

(Stamp)

Date: Jun. 13, 2000

60MM7
Socket 370 Processor Motherboard

USER'S MANUAL

Socket 370 Processor Motherboard
REV. 3.0 First Edition
R-30-01-001221

How This Manual Is Organized

This manual is divided into the following sections:

1) Revision History	Manual revision information
2) Item Checklist	Product item list
3) Features	Product information & specification
4) Hardware Setup	Instructions on setting up the motherboard
5) Performance & Block Diagram	Product performance & block diagram
6) Suspend to RAM	Instructions STR installation
7) @BIOS™	@BIOS™ introduction
8) BIOS Setup	Instructions on setting up the BIOS software
9) Appendix	General reference

Table Of Content

Revision History	P.1
Item Checklist	P.2
Summary of Features	P.3
6OMM7 Motherboard Layout	P.5
Page Index for CPU Speed Setup/Connectors/Panel and Jumper Definition	P.6
Performance List	P.31
Block Diagram	P.32
Suspend to RAM Installation (Optional)	P.33
@BIOS™ Introduction	P.39
Memory Installation	P.40
Page Index for BIOS Setup	P.41
Appendix	P.79

Revision History

Revision	Revision Note	Date
3.0	Initial release of the 6OMM7 motherboard user's manual.	Dec.2000

The author assumes no responsibility for any errors or omissions that may appear in this document nor does the author make a commitment to update the information contained herein. Third-party brands and names are the property of their respective owners.

Item Checklist

- The 60MM7 motherboard
- Cable for IDE / floppy device
- Diskettes or CD (IUCD) for motherboard driver & utility
- 60MM7 user's manual

Summary Of Features

Form Factor	<ul style="list-style-type: none"> 24.5 cm x 21.2 cm Micro ATX form factor, 4 layers PCB.
CPU	<ul style="list-style-type: none"> Socket 370 processor <ul style="list-style-type: none"> Intel Pentium® III 100/133MHz FSB, FC-PGA Intel Celeron™ 66MHz FSB, FC-PGA 2nd cache in CPU (Depend on CPU)
Chipset	<ul style="list-style-type: none"> Intel 815 HOST / AGP / SDRAM Controller 82801AA I/O Controller Hub (ICH)
Clock Generator	<ul style="list-style-type: none"> ICS 9250AF-25 66/100/133 MHz system bus speeds
Memory	<ul style="list-style-type: none"> 3 168-pin DIMM sockets Supports PC-100 / PC-133 SDRAM Supports up to 512MB(Max) Supports only 3.3V SDRAM DIMM
I/O Control	<ul style="list-style-type: none"> IT8712
Slots	<ul style="list-style-type: none"> 1 AGP Slot Supports 4X mode & AGP 2.0 compliant 1 DFP /TV 3 PCI Slots Supports 33MHz & PCI 2.2 compliant 1 AMR (Audio Modem Riser) Slot
On-Board IDE	<ul style="list-style-type: none"> Supports PIO mode 3, 4, UDMA33/ATA66 IDE & ATAPI CD-ROM 2 IDE bus master (UDMA 33/ ATA 66) IDE ports for up to 4 ATAPI devices
On-Board Peripherals	<ul style="list-style-type: none"> 1 floppy port supports 2 FDD with 360K, 720K, 1.2M, 1.44M and 2.88M bytes 1 parallel port supports SPP/EPP/ECP mode 1 serial port (COM A) 2 USB ports 1 IrDA connector for IR/CIR
Hardware Monitor	<ul style="list-style-type: none"> CPU/Power Supply/System fan revolution detect CPU temperature detect System voltage detect CPU overheat shutdown detect
On-Board Sound	<ul style="list-style-type: none"> AC'97 CODEC Line In / Line Out / Mic In / AUX In / CD In / TEL / Game Port

To be continued...

Summary of Features

PS/2 Connector	<ul style="list-style-type: none">• PS/2 keyboard interface and PS/2 mouse interface
BIOS	<ul style="list-style-type: none">• Licensed AWARD BIOS, 4M bit Flash ROM
Additional Features	<ul style="list-style-type: none">• Supports Wake-on-LAN (WOL)• Supports Internal / External modem wake up• Includes 3 fan power connectors• Poly fuse for keyboard over-current protection• Support @BIOS™

60MM7 Motherboard Layout

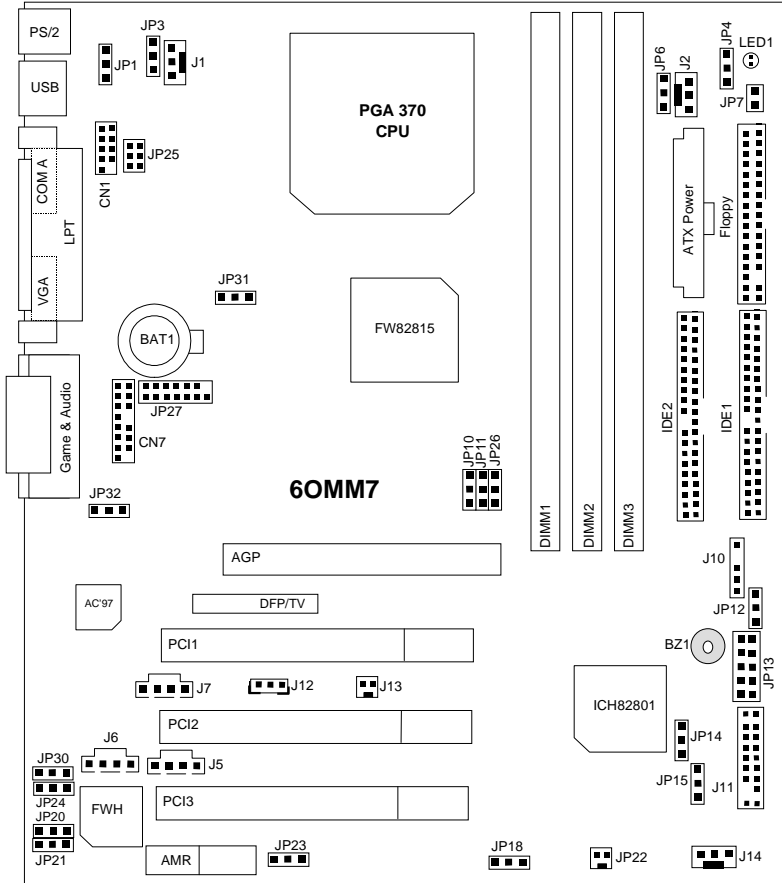

 Page Index for CPU Speed Setup/Connectors/Panel and Jumper Definition	Page
CPU Speed Setup	P.8
Connectors	P.9
Game & Audio Port	P.9
COM A / VGA / LPT Port	P.9
USB Connector	P.10
PS/2 Keyboard & PS/2 Mouse Connector	P.10
J1 (CPU Fan)	P.11
J2 (Power Fan)	P.11
J14 (System Fan)	P.12
ATX Power	P.12
JP13 (IR/CIR)	P.13
Floppy Port	P.13
IDE 1(Primary) / IDE 2(Secondary) Port	P.14
J13 (Ring Power On)	P.14
J12 (Wake on LAN)	P.15
J7 (TEL)	P.15
J6 (AUX_IN)	P.16
J5 (CD Audio Line In)	P.16
JP7 (STR LED Connector) & LED 1 (DIMM LED)[Optional]	P.17
CN11 (Front USB Port) [Optional]	P.17
J10 (Extra SMBUS)	P.18
DFP/TV Out Connector	P.18
JP27 (SCR)	P.19
CN7 (Front Audio) [Optional]	P.20
Panel and Jumper Definition	P.21
J11 (2x11 Pins Jumper)	P.21
JP18 (Clear CMOS Function)	P.22
JP4 (STR Enable) [Optional]	P.22
JP3 (PS/2 Keyboard Power On)	P.23
JP22 (Case Open)	P.23
JP1 (Rear USB Device Wake up Selection)	P.24
JP20 (FWH Flash Write Protect)	P.24
JP21 (Top Block Lock)	P.25
JP6 (DIMM Over Voltage) [Optional]	P.25
JP12 (Internal Buzzer) [Optional]	P.26
JP14 (Timeout Reboot Function)	P.26

6OMM7 Motherboard

JP15 (Safe mode/Recovery/Normal)	P.27
JP23 (PCI/AGP 3VAUX)	P.27
JP24&JP30 (AMR Selection) [Optional]	P.28
JP31 (Over Voltage CPU Speed Up) [Optional]	P.28
JP32 (Front Audio/MIC) [Optional]	P.29
JP25 (USB Port Selection) [Optional]	P.29
BAT1 (Battery)	P.30

CPU Speed Setup

The system bus frequency can be switched at 66MHz, 100MHz, 133MHz and Auto by adjusting JP10/JP11/JP26 (See Figure 1). The CPU Frequency is control by BIOS.

⚠️ **The CPU speed must match with the frequency RATIO. It will cause system hanging up if the frequency RATIO is higher than that of CPU.**

JP10/JP11/JP26: CPU Speed Setup (Optional)

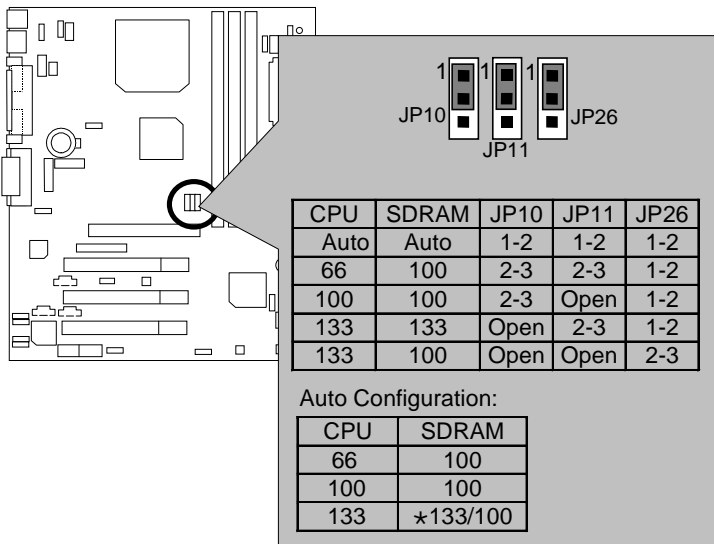
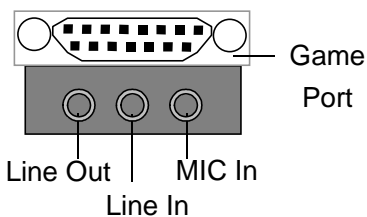
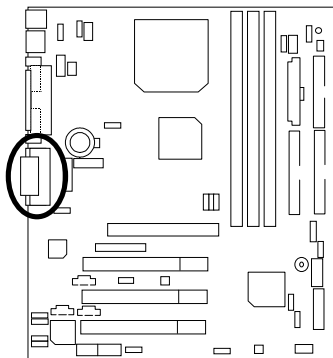

Figure 1

- ★ If the CPU FSB is 133 FSB, the frequency of the SDRAM can be determined by SDRAM's SPD or setting in BIOS.
- ⚠️ If JP10, JP11, JP26 is not present, FSB will be determined automatically. If these 3 jumpers are available, you can choose at 66MHz, 100MHz, 133MHz and Auto.
- ⚠️ **Note:** Please set the CPU host frequency in accordance with your processor's specifications. We don't recommend you to set the system bus frequency over the CPU's specification because these specific bus frequencies are not the standard specifications for CPU, chipset and most of the peripherals. Whether your system can run under these specific bus frequencies properly will depend on your hardware configurations, including CPU, Chipsets, SDRAM, Cards....etc.

Connectors

Game & Audio Port



COM A / VGA / LPT Port

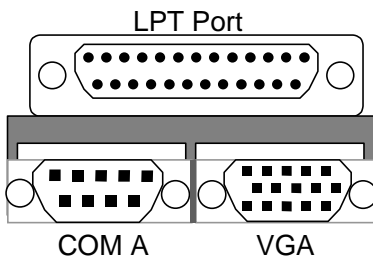
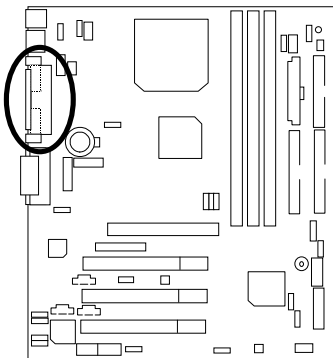

USB Connector

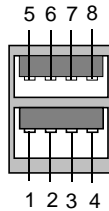
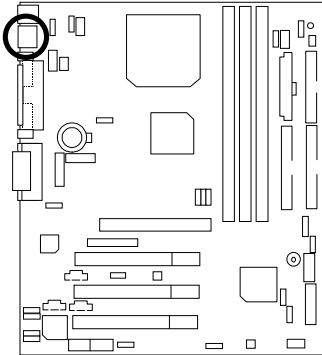

Pin No.	Definition
1	USB V0
2	USB D0-
3	USB D0+
4	GND
5	USB V1
6	USB D1-
7	USB D1+
8	GND

PS/2 Keyboard & PS/2 Mouse Connector

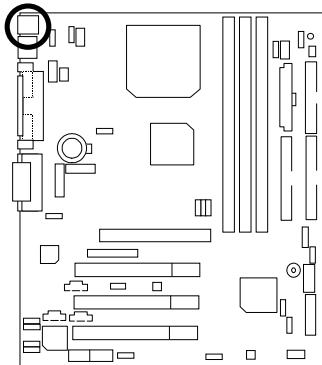

PS/2 Mouse

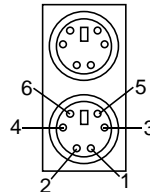

PS/2 Keyboard

PS/2 Mouse/ Keyboard	
Pin No.	Definition
1	Data
2	NC
3	GND
4	VCC(+5V)
5	Clock
6	NC

J1: CPU Fan

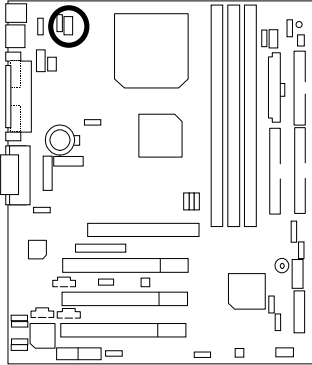

Pin No.	Definition
1	GND
2	+12V
3	SENSE

J2: Power Fan

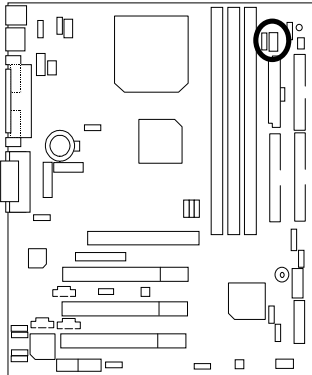

Pin No.	Definition
1	GND
2	+12V
3	SENSE

J14: System Fan

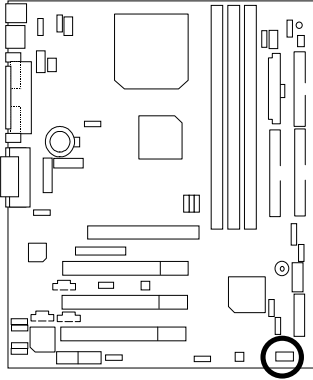

Pin No.	Definition
1	GND
2	+12V
3	SENSE

ATX Power

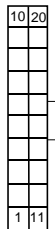
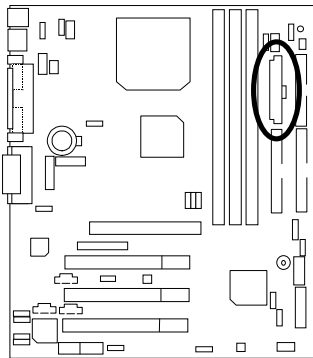

Pin No.	Definition
3,5,7,13,15-17	GND
1,2,11	3.3V
4,6,19,20	VCC
10	+12V
12	-12V
18	-5V
8	Power Good
9	5V SB stand by+5V
14	PS-ON (Soft On/Off)

JP13: IR/CIR

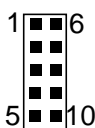
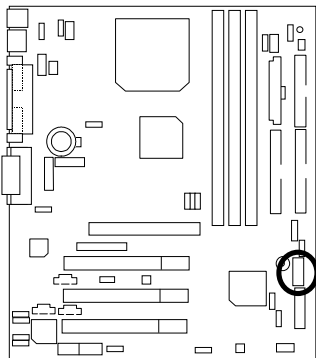

Pin No.	Definition
1	VCC
2	NC
3	IRRX
4	GND
5	IRTX
6	NC
7	CIRRX
8	VCC
9	CIRTX
10	NC

Floppy Port

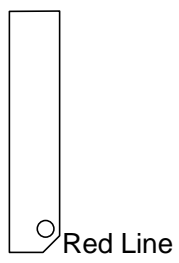
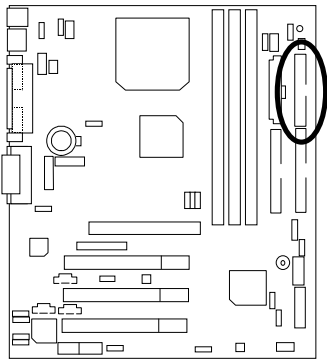

IDE1 (Primary), IDE2 (Secondary) Port

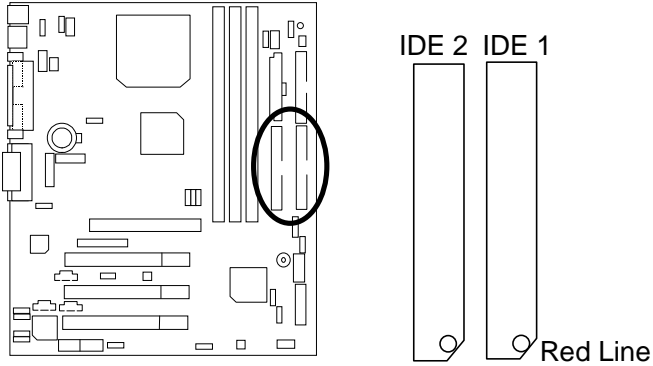

J13: Ring Power On (Internal Modem Card Wake Up)

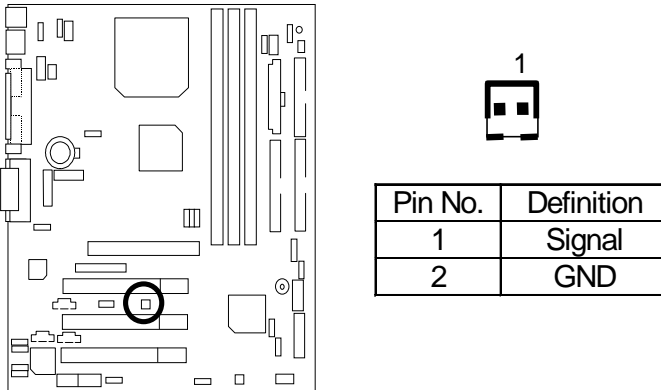

J12: Wake On LAN

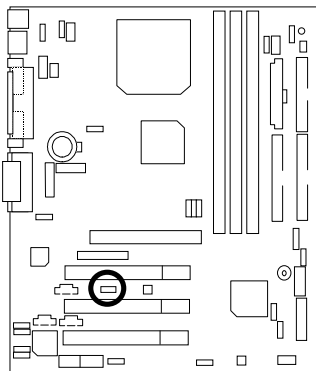

Pin No.	Definition
1	+5V SB
2	GND
3	Signal

J7: TEL: The connector is for Modem with internal voice connector

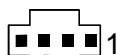
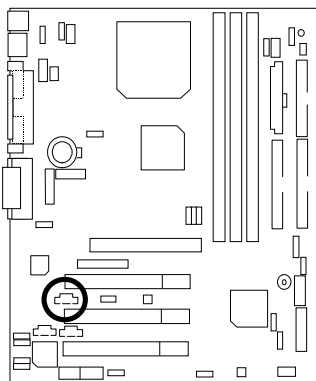

Pin No.	Definition
1	Signal-In
2	GND
3	GND
4	Signal-Out

J6: AUX_IN

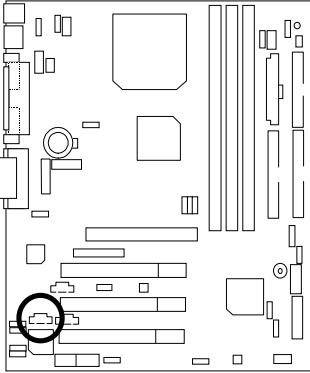

Pin No.	Definition
1	AUX-L
2	GND
3	GND
4	AUX-R

J5: CD Audio Line In

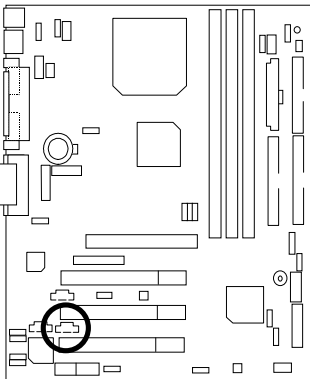

Pin No.	Definition
1	CD-L
2	GND
3	GND
4	CD-R

JP7: STR LED Connector & LED1: DIMM LED (Optional)

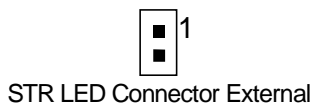
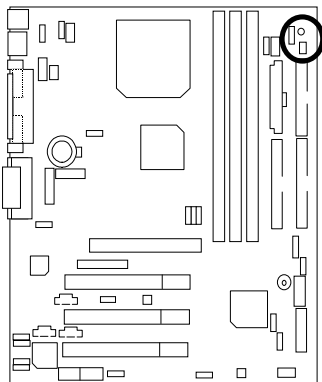

CN11: Front USB Port (Optional)

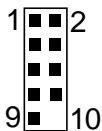
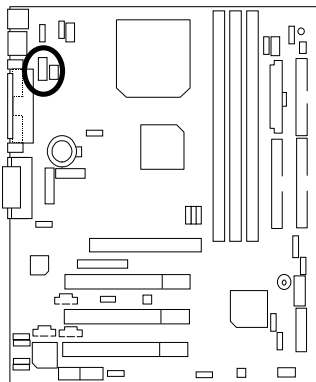

Pin No.	Definition
1,4,5,10	NC
2	+5V
3,7,9	GND
6	USBP0+
8	USBP0-

J10: Extra SMBUS

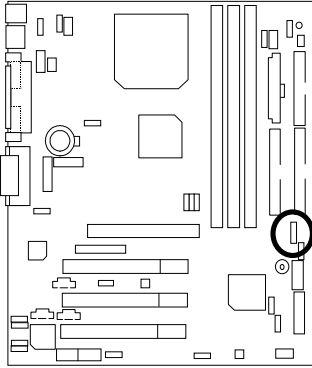

Pin No.	Definition
1	SMB CLK
2	NC
3	GND
4	SMB DATA
5	+5V

DFP/TV Out Connector

* Use only for Gigabyte Digital Flat Panel/TV-Out Daughter card (GA-DFP-x).

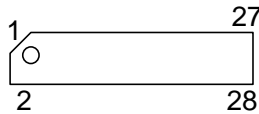
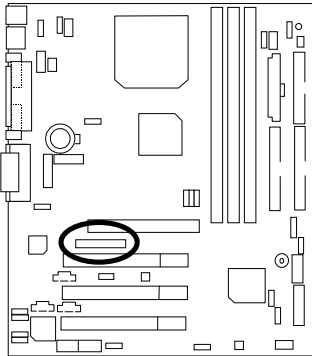

JP27: SCR: Smart Card Reader

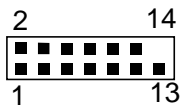
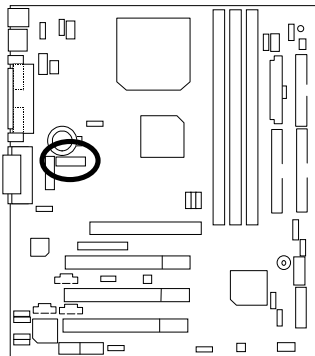

Pin No.	Definition
1	VCC
2	NC
3	NC
4	NC
5	SCRFET
6	SCRRST
7	SCRCLK
8	NC
9	NC
10	SCRIO
11	GND
12	SCRPRES
13	NC
14	NC

CN7: Front Audio (Optional)

- * If the user do not need to use Front Audio connector, please set jumper 11-12 close & 13-14 close.

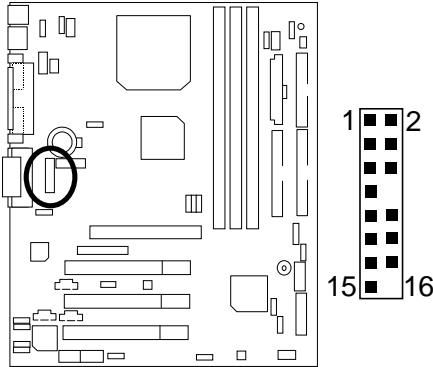

Pin No.	Definition
1	Incase speaker (R)
2	Incase speaker (L)
3,4,5,6, 10,15	GND
7	+12V
8,16	NC
9	MIC
11	Front Audio (R)
13	Front Audio (L)
12	Rear Audio (R)
14	Rear Audio (L)

Panel And Jumper Definition

J11: For 2x11 Pins Jumper

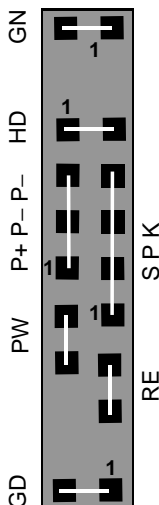
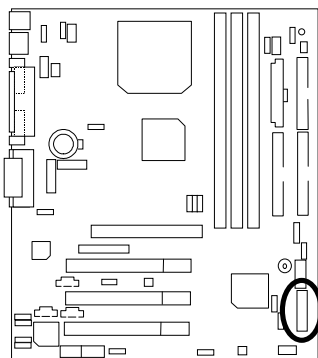

GN (Green Switch)	Open: Normal Operation Close: Entering Green Mode
GD (Green LED)	Pin 1: LED anode(+) Pin 2: LED cathode(-)
HD (IDE Hard Disk Active LED)	Pin 1: LED anode(+) Pin 2: LED cathode(-)
SPK (Speaker Connector)	Pin 1: VCC(+) Pin 2- Pin 3: NC Pin 4: Data(-)
RE (Reset Switch)	Open: Normal Operation Close: Reset Hardware System
P+P-P-(Power LED)	Pin 1: LED anode(+) Pin 2: LED cathode(-) Pin 3: LED cathode(-)
PW (Soft Power Connector)	Open: Normal Operation Close: Power On/Off

JP18: Clear CMOS Function

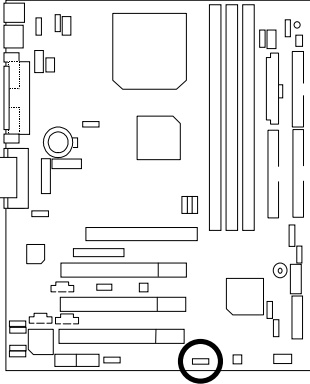

Pin No.	Definition
1-2 close	Clear CMOS
2-3 close	Normal (Default)

JP4: STR Enable (Optional)

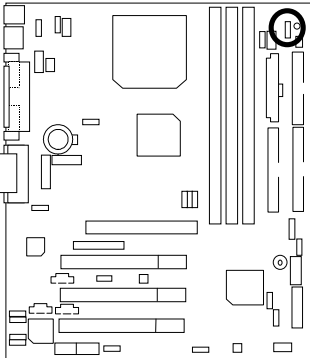

Pin No.	Definition
1-2 close	STR Enable
2-3 close	STR Disable (Default)

JP3: PS/2 Keyboard Power On

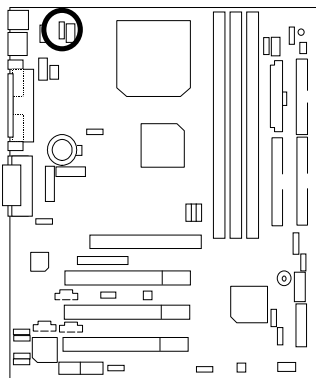

Pin No.	Definition
1-2 close	PS/2 Keyboard Power on Enable
2-3 close	Normal (Default)

JP22: Case Open

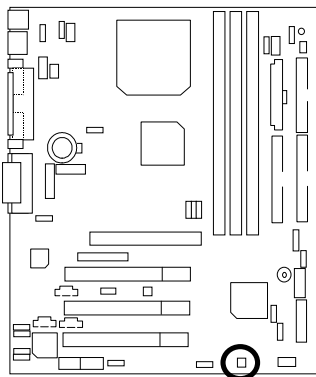

Pin No.	Definition
1	Signal
2	GND

JP1: Rear USB Device Wake up Selection (USB Connector → USB)

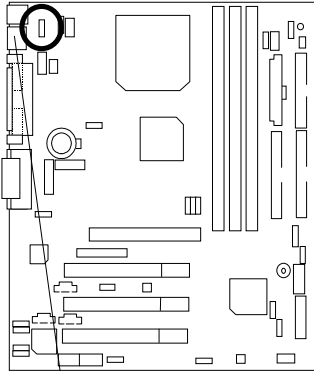

USB



Pin No.	Definition
1-2 close	Enable Rear USB Device Wake up
2-3 close	Normal (Default)

(If you want to use “**USB KB/Mouse Wake from S3**” function, you have to set the BIOS setting “**USB KB/Mouse Wake from S3**” enabled, and the jumper “**JP1&JP4**” enabled).
 *(Power on the computer and as soon as memory counting starts, press . You will enter BIOS Setup. Select the item “**POWER MANAGEMENT SETUP**”, then select “**USB KB/Mouse Wake from S3: Enabled**”. Remember to save the setting by pressing “**ESC**” and choose the “**SAVE & EXIT SETUP**” option.)

JP20: FWH Flash Write Protect

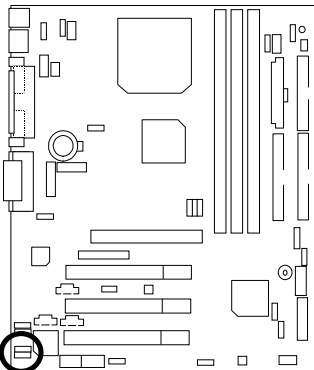

Pin No.	Definition
1-2 close	Write Protection
2-3 close	Normal (Default)

● Please set Jumper JP20 to “2-3 close” to enabled BIOS write function when you update new BIOS or new device.

JP21: Top Block Lock

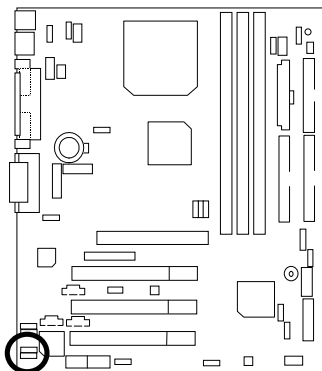

Pin No.	Definition
1-2 close	Top Block Unlock (Default)
2-3 close	Top Block Lock

JP6: DIMM Over Voltage (Optional)

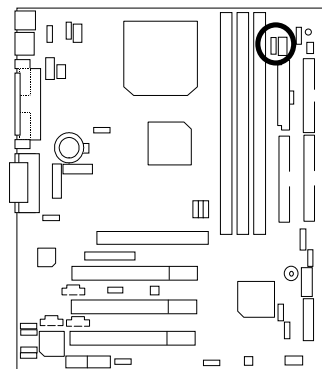

Pin No.	Definition
1-2 close	Enable DIMM Over Voltage
2-3 close	Disable DIMM Over Voltage (Default)

JP12: Internal Buzzer (Optional)

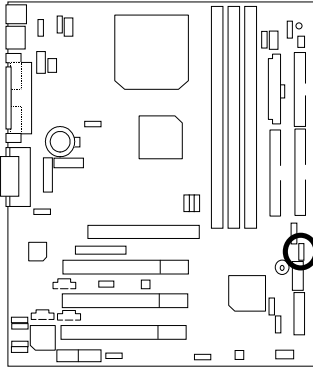

Pin No.	Definition
1-2 close	Internal Buzzer Enable (Default)
2-3 close	Internal Buzzer Disable

JP14: Timeout Reboot Function

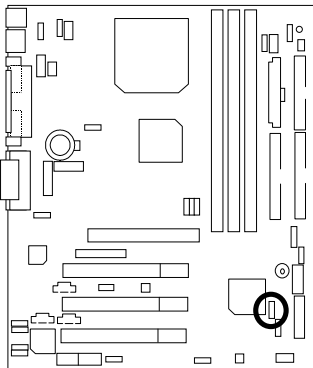

Pin No.	Definition
1-2 close	No Reboot on Timeout (Default)
2-3 close	Timeout Reboot

JP15: Safe mode/Recovery/Normal

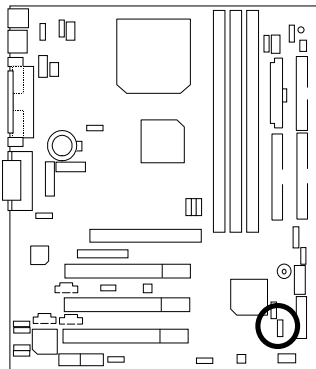

Pin No.	Definition
1-2 close	Normal (Default)
2-3 close	Safe mode
1-2-3 open	Recovery

JP23: PCI/AGP 3VAUX

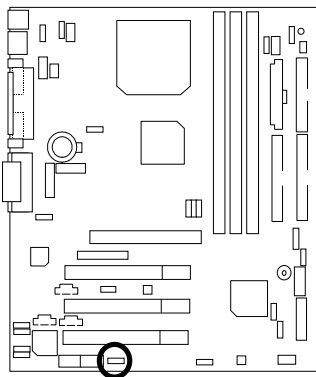

Pin No.	Definition
1-2 close	Enable PCI/AGP 3.3Vsb (Default)
2-3 close	Disable PCI/AGP 3.3Vsb

JP24 & JP30: AMR Selection (Optional)

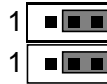
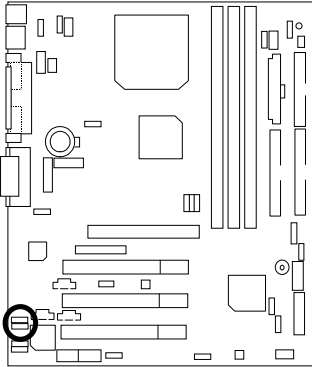

Pin No.	Definition
1-2 close	AMR Secondary
2-3 close	AMR Primary AC'97 Disable (Default) (Disable Onboard CODEC)

JP31: Over Voltage CPU Speed Up (**Magic Booster**)

(When JP31 set "1-2 close", CPU Voltage is rising 10%) (Optional)

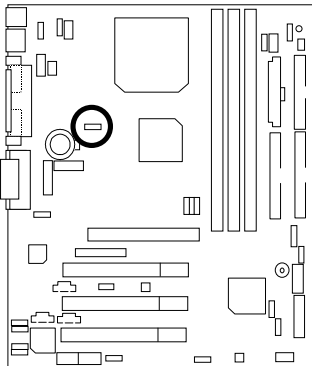

Pin No.	Definition
1-2 close	Turbo [Voltage enhance 10%] for over clock use
2-3 close	Normal (Default)

JP32: Front Audio / MIC (Optional)

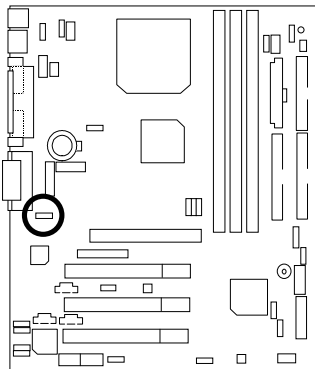

Pin No.	Definition
1-2 close	Disable
2-3 close	Enable (Default)

JP25: USB Port Selection (Optional)

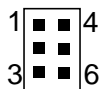
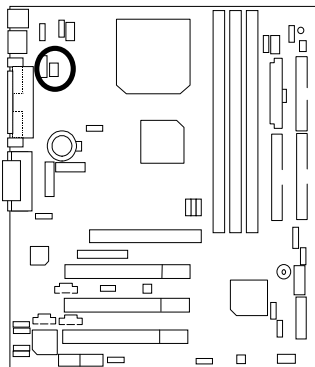

Front Panel USB Enable	Back Panel USB Enable
FPUSB	BPUSB (Default)
1-2 close	2-3 close
4-5 close	5-6 close

BAT1: Battery

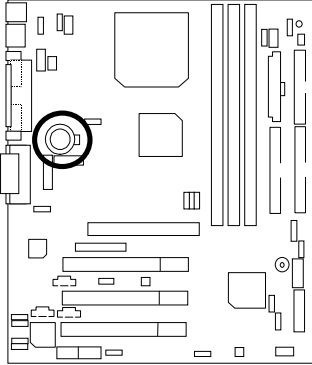

CAUTION

- ☞ Danger of explosion if battery is incorrectly replaced.
- ☞ Replace only with the same or equivalent type recommended by the manufacturer.
- ☞ Dispose of used batteries according to the manufacturer's instructions.

Performance List

The following performance data list is the testing results of some popular benchmark testing programs.

These data are just referred by users, and there is no responsibility for different testing data values gotten by users. (The different Hardware & Software configuration will result in different benchmark testing results.)

- CPU Intel® Pentium® !!! 1 GHz Processor
- DRAM (128 x 2) MB SDRAM (MICRON MT48LC8M8A2-8E B)
- CACHE SIZE 256 KB included in CPU
- DISPLAY Gigabyte GF2000 AGP Card, Onchip display
- STORAGE Onboard IDE (IBM DTLA-307060)
- O.S. Windows NT™ 4.0 SP6
- DRIVER Display Driver at 1024 x 768 x 24bit colors x 75Hz.

Processor	Intel® Pentium® !!! 1 GHz (133X7.5)	
Display	Onchip display	Gigabyte GF2000
Winbench99		
CPU mark99	89.4	91.4
FPU Winmark 99	5350	5350
Business Disk Winmark 99	8650	8510
Hi-End Disk Winmark 99	21700	21600
Business Graphics Winmark 99	169	485
Hi-End Graphics Winmark 99	771	948
Winstone99		
Business Winstone99	43.8	50.7
Hi-End Winstone99	59.3	61.2

☛ If you wish to maximize the performance of your system, please refer to the detail on P.53.

Block Diagram

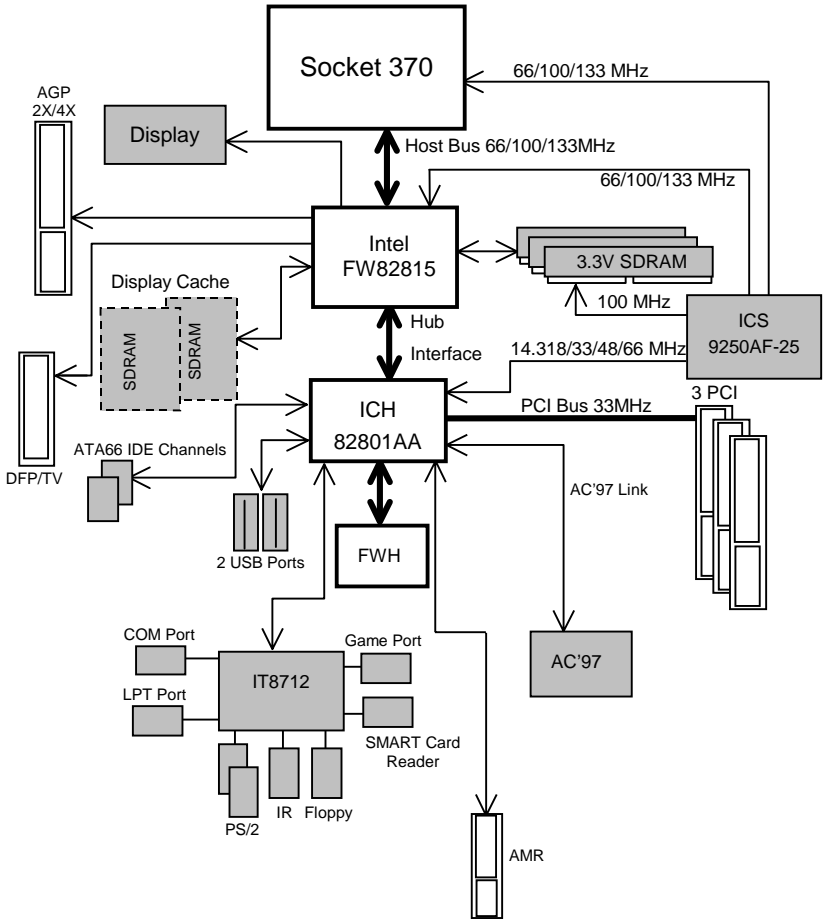

Suspend To RAM Installation (Optional)

A.1 Introduce STR function:

Suspend-to-RAM (STR) is a Windows 98 ACPI sleep mode function. When recovering from STR (S3) sleep mode, the system is able, in just a few seconds, to retrieve the last "state" of the system before it went to sleep and recover to that state. The "state" is stored in memory (RAM) before the system goes to sleep. During STR sleep mode, your system uses only enough energy to maintain critical information and system functions, primarily the system state and the ability to recognize various "wake up" triggers or signals, respectively.

A.2 STR function Installation

Please use the following steps to complete the STR function installation.

Step-By-Step Setup

Step 1:

To utilize the STR function, the system must be in Windows 98 ACPI mode.

Putting Windows 98 into ACPI mode is fairly easy.

Setup with Windows 98 CD:

- A. Insert the Windows 98 CD into your CD-ROM drive, select Start, and then Run.
- B. Type (without quotes) "**D:\setup** " in the window provided. Hit the enter key or click OK.
- C. After setup completes, remove the CD, and reboot your system
(This manual assumes that your CD-ROM device drive letter is D:).

Step 2:

(If you want to use STR Function, please set jumper JP4 Closed.)

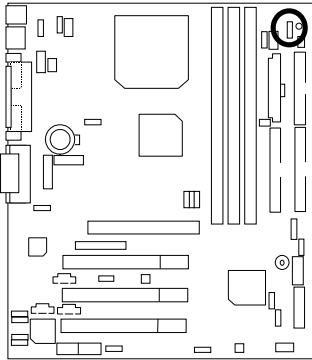

Pin No.	Definition
1-2 close	STR Enable
2-3 close	STR Disable (Default)

Step 3:

Power on the computer and as soon as memory counting starts, press . You will enter BIOS Setup. Select the item **"POWER MANAGEMENT SETUP"**, then select **"ACPI Suspend Type: S3(Suspend to RAM)"**. Remember to save the settings by pressing "ESC" and choose the **"SAVE & EXIT SETUP"** option.

Congratulation! You have completed the installation and now can use the STR function.

A.3 How to put your system into STR mode?

There are two ways to accomplish this:

1. Choose the "Stand by" item in the "Shut Down Windows" area.

- A. Press the "Start" button and then select "Shut Down"



- B. Choose the "Stand by" item and press "OK"

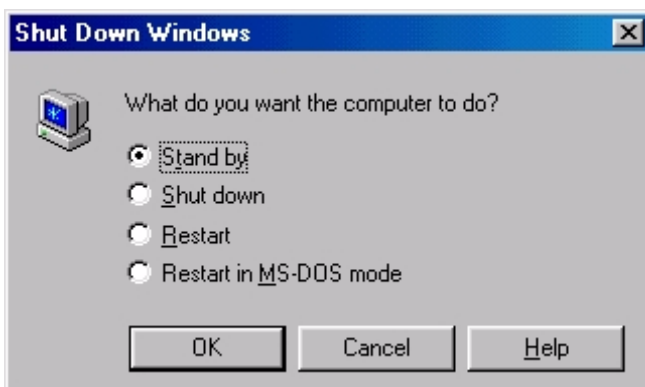

2. Define the system "power on" button to initiate STR sleep mode:

A. Double click "My Computer" and then "Control Panel"

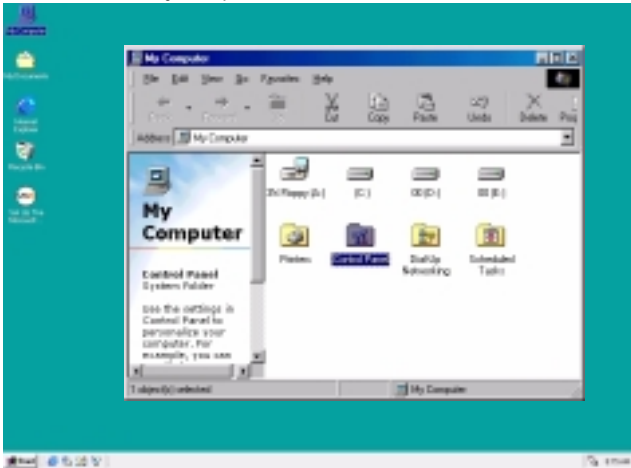

B. Double click the " Power Management" item.

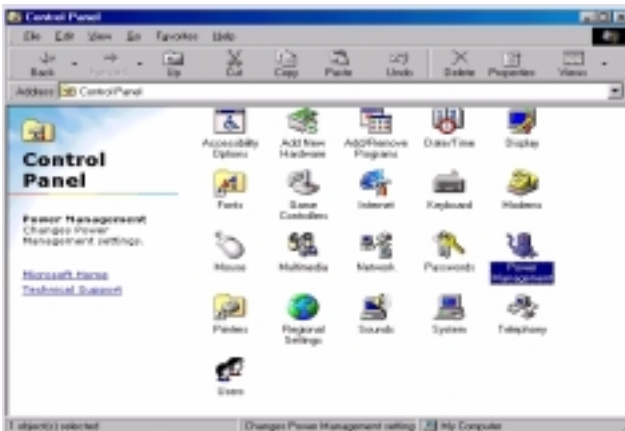

C. Select the "Advanced" tab and "Standby" mode in Power Buttons.



D. Restart your computer to complete setup.

Now when you want to enter STR sleep mode, just momentarily press the "Power on" button.

A.4 How to recover from the STR sleep mode?

There are seven ways to "wake up" the system:

1. Press the "Power On" button.
2. Use the "PS/2 Keyboard Power On" function.
3. Use the "Mouse Power On" function.
4. Use the "Resume by Alarm" function.
5. Use the "Modem Ring On" function.
6. Use the "Wake On LAN" function.
7. Use the "USB Device Wake up" function.

A.5 Notices:

1. In order for STR to function properly, several hardware and software requirements must be satisfied:
 - A. Your ATX power supply must comply with the ATX 2.01 specification (provide more than 720 mA 5V Stand-By current).
 - B. Your SDRAM must be PC-100 compliant.
2. Jumper JP7 is provided to connect to the STR LED in your system chassis. [Your chassis may not provide this feature.] The STR LED will be illuminated when your system is in STR sleep mode.

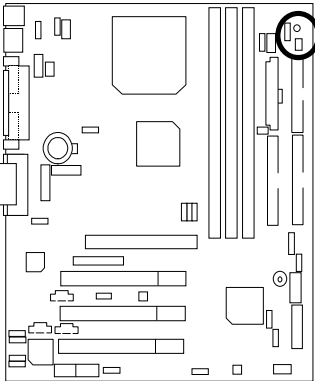

DIMM LED



STR LED Connector External

@BIOS™ Introduction

Gigabyte announces @BIOS™ Windows BIOS live update utility



Have you ever updated BIOS by yourself? Or like many other people, you just know what BIOS is, but always hesitate to update it? Because you think updating newest BIOS is unnecessary and actually you don't know how to update it.

Maybe not like others, you are very experienced in BIOS updating and spend quite a lot of time to do it. But of course you don't like to do it too much. First, download different BIOS from website and then switch the operating system to DOS mode. Secondly, use different flash utility to update BIOS. The above process is not a interesting job. Besides, always be carefully to store the BIOS source code correctly in your disks as if you update the wrong BIOS, it will be a nightmare.

Certainly, you wonder why motherboard vendors could not just do something right to save your time and effort and save you from the lousy BIOS updating work? Here it comes! Now Gigabyte announces @BIOS™ --the first Windows BIOS live update utility. This is a smart BIOS update software. It could help you to download the BIOS from internet and update it. Not like the other BIOS update software, it's a Windows utility. With the help of "@BIOS™", BIOS updating is no more than a click.

Besides, no matter which mainboard you are using, if it's a Gigabyte's product*, @BIOS™ help you to maintain the BIOS. This utility could detect your correct mainboard model and help you to choose the BIOS accordingly. It then downloads the BIOS from the nearest Gigabyte ftp site automatically. There are several different choices; you could use "Internet Update" to download and update your BIOS directly. Or you may want to keep a backup for your current BIOS, just choose "Save Current BIOS" to save it first. You make a wise choice to use Gigabyte, and @BIOS™ update your BIOS smartly. You are now worry free from updating wrong BIOS, and capable to maintain and manage your BIOS easily. Again, Gigabyte's innovative product erects a milestone in mainboard industries.

For such a wonderful software, how much it costs? Impossible! It's free! Now, if you buy a Gigabyte's motherboard, you could find this amazing software in the attached driver CD. But please remember, connected to internet at first, then you could have a internet BIOS update from your Gigabyte @BIOS™.

Memory Installation

The motherboard has 3 dual inline memory module (DIMM) sockets. The BIOS will automatically detects memory type and size. To install the memory module, just push it vertically into the DIMM Slot .The DIMM module can only fit in one direction due to the two notch. Memory size can vary between sockets.

Install memory in any combination table:

DIMM	168-pin SDRAM DIMM Modules	
DIMM1	Supports 16 / 32 / 64 / 128 / 256 / 512MB	X 1 pcs
DIMM2	Supports 16 / 32 / 64 / 128 / 256 / 512MB	X 1 pcs
DIMM3	Supports 16 / 32 / 64 / 128 / 256 / 512MB	X 1 pcs

60MM7 Motherboard

 Page Index for BIOS Setup	Page
Main Menu	P.43
Standard CMOS Features	P.46
Advanced BIOS Features	P.50
Advanced Chipset Features	P.53
Integrated Peripherals	P.59
Power Management Setup	P.65
PnP/ PCI Configurations	P.69
PC Health Status	P.71
Frequency / Voltage Control	P.73
Load Fail-Safe Defaults	P.74
Load Optimized Defaults	P.75
Set Supervisor / User Password	P.76
Save & Exit Setup	P.77
EXIT Without Saving	P.78

BIOS Setup

BIOS Setup is an overview of the BIOS Setup Program. The program that allows users to modify the basic system configuration. This type of information is stored in battery-backed CMOS RAM so that it retains the Setup information when the power is turned off.

ENTERING SETUP

Power ON the computer and press immediately will allow you to enter Setup. If the message disappears before you respond and you still wish to enter Setup, restart the system to try again by turning it OFF then ON or pressing the "RESET" button on the system case. You may also restart by simultaneously press <Ctrl> – <Alt>– keys.

CONTROL KEYS

<↑>	Move to previous item
<↓>	Move to next item
<←>	Move to the item in the left hand
<→>	Move to the item in the right hand
<Esc>	Main Menu - Quit and not save changes into CMOS Status Page Setup Menu and Option Page Setup Menu - Exit current page and return to Main Menu
<+/PgUp>	Increase the numeric value or make changes
<-/PgDn>	Decrease the numeric value or make changes
<F1>	General help, only for Status Page Setup Menu and Option Page Setup Menu
<F2>	Reserved
<F3>	Reserved
<F4>	Reserved
<F5>	Restore the previous CMOS value from CMOS, only for Option Page Setup Menu
<F6>	Load the default CMOS value from BIOS default table, only for Option Page Setup Menu
<F7>	Load the Optimized Defaults
<F8>	Reserved
<F9>	Reserved
<F10>	Save all the CMOS changes, only for Main Menu

GETTING HELP

Main Menu

The on-line description of the highlighted setup function is displayed at the bottom of the screen.

Status Page Setup Menu / Option Page Setup Menu

Press F1 to pop up a small help window that describes the appropriate keys to use and the possible selections for the highlighted item. To exit the Help Window press <Esc>.

The Main Menu

Once you enter Award BIOS CMOS Setup Utility, the Main Menu (Figure 2) will appear on the screen. The Main Menu allows you to select from nine setup functions and two exit choices. Use arrow keys to select among the items and press <Enter> to accept or enter the sub-menu.

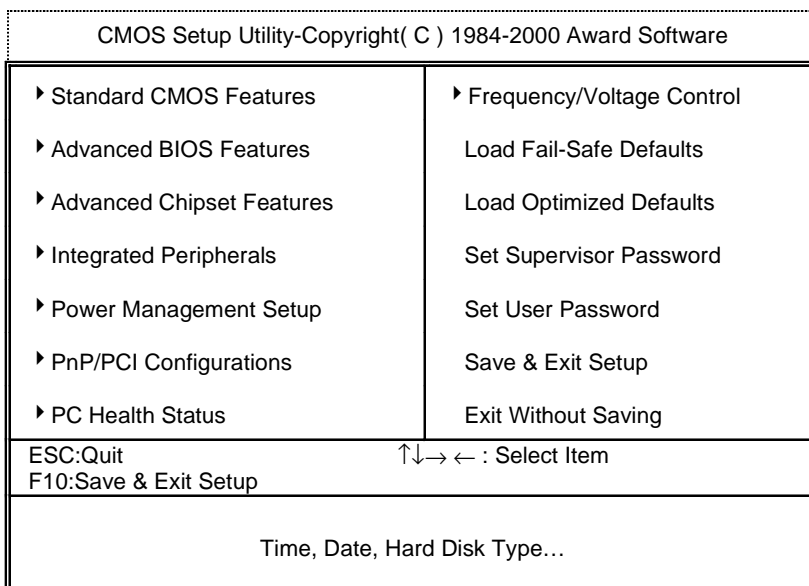

Figure 2: Main Menu

- **Standard CMOS Features**

This setup page includes all the items in standard compatible BIOS.

- **Advanced BIOS Features**

This setup page includes all the items of Award special enhanced features.

- **Advanced Chipset Features**

This setup page includes all the items of chipset special features.

- **Integrated Peripherals**

This setup page includes all onboard peripherals.

- **Power Management Setup**

This setup page includes all the items of Green function features.

- **PnP/PCI Configurations**

This setup page includes all the configurations of PCI & PnP ISA resources.

- **PC Health Status**

This setup page is the System auto detect Temperature, voltage, fan, speed.

- **Frequency/Voltage Control**

This setup page is control CPU's clock and frequency ratio.

- **Load Fail-Safe Defaults**

Fail-Safe Defaults indicates the value of the system parameters which the system would be in safe configuration.

- **Load Optimized Defaults**

Optimized Defaults indicates the value of the system parameters which the system would be in best performance configuration.

- **Set Supervisor password**

Change, set, or disable password. It allows you to limit access to the system and Setup, or just to Setup.

- **Set User password**

Change, set, or disable password. It allows you to limit access to the system.

- **Save & Exit Setup**

Save CMOS value settings to CMOS and exit setup.

- **Exit Without Saving**

Abandon all CMOS value changes and exit setup.

Standard CMOS Features

The items in Standard CMOS Setup Menu (Figure 3) are divided into 9 categories. Each category includes no, one or more than one setup items. Use the arrows to highlight the item and then use the <PgUp> or <PgDn> keys to select the value you want in each item.

CMOS Setup Utility-Copyright(C) 1984-2000 Award Software Standard CMOS Features		
Date (mm:dd:yy)	Mon , Feb 21 2000	Item Help
Time (hh:mm:ss)	2 : 31 : 24	
▶ IDE Primary Master	Press Enter None	Menu Level ▶
▶ IDE Primary Slave	Press Enter None	Change the
▶ IDE Secondary Master	Press Enter None	Day, month,
▶ IDE Secondary Slave	Press Enter None	Year and
		century
Drive A	1.44M, 3.5 in.	
Drive B	None	
Floppy 3 Mode Support	Disabled	
Video	EGA / VGA	
Halt On	All, But Keyboard	
Base Memory	640K	
Extended Memory	63488K	
Total Memory	64512K	

↑↓←→:Move Enter:Select +/-/PU/PD:Value F10:Save ESC:Exit F1:General Help
F5:Previous Values F6:Fail-Safe Defaults F7:Optimized Defaults

Figure 3: Standard CMOS Features

- **Date**

The date format is <week>, <month> <day> <year>.

Week	The week, from Sun to Sat, determined by the BIOS and is display-only
Month	The month, Jan. Through Dec.
Day	The day, from 1 to 31 (or the maximum allowed in the month)
Year	The year, from 1994 through 2079

- **Time**

The times format in <hour> <minute> <second>. The time is calculated base on the 24-hour military-time clock. For example, 1 p.m. is 13:00:00.

- **IDE Primary Master, Slave / Secondary Master, Slave**

The category identifies the types of hard disk from drive C to F that has been installed in the computer. There are two types: auto type, and manual type. Manual type is user-definable; Auto type which will automatically detect HDD type.

Note that the specifications of your drive must match with the drive table. The hard disk will not work properly if you enter improper information for this category.

If you select User Type, related information will be asked to enter to the following items. Enter the information directly from the keyboard and press <Enter>. Such information should be provided in the documentation form your hard disk vendor or the system manufacturer.

CYLS.	Number of cylinders
HEADS	number of heads
PRECOMP	write precomp
LANDZONE	Landing zone
SECTORS	number of sectors

If a hard disk has not been installed select NONE and press <Enter>.

- **Drive A type / Drive B type**

The category identifies the types of floppy disk drive A or drive B that has been installed in the computer.

None	No floppy drive installed
360K, 5.25 in.	5.25 inch PC-type standard drive; 360K byte capacity.
1.2M, 5.25 in.	5.25 inch AT-type high-density drive; 1.2M byte capacity (3.5 inch when 3 Mode is Enabled).
720K, 3.5 in.	3.5 inch double-sided drive; 720K byte capacity
1.44M, 3.5 in.	3.5 inch double-sided drive; 1.44M byte capacity.
2.88M, 3.5 in.	3.5 inch double-sided drive; 2.88M byte capacity.

- **Floppy 3 Mode Support (for Japan Area)**

Disabled	Normal Floppy Drive. (Default value)
Drive A	Drive A is 3 mode Floppy Drive.
Drive B	Drive B is 3 mode Floppy Drive.
Both	Drive A & B are 3 mode Floppy Drives.

- **Video**

The category detects the type of adapter used for the primary system monitor that must match your video display card and monitor. Although secondary monitors are supported, you do not have to select the type in setup.

EGA/VGA	Enhanced Graphics Adapter/Video Graphics Array. For EGA, VGA, SVGA, or VGA monitor adapters
CGA 40	Color Graphics Adapter, power up in 40 column mode
CGA 80	Color Graphics Adapter, power up in 80 column mode
MONO	Monochrome adapter, includes high resolution monochrome adapters

- **Halt on**

The category determines whether the computer will stop if an error is detected during power up.

NO Errors	The system boot will not stop for any error that may be detected and you will be prompted.
All Errors	Whenever the BIOS detects a non-fatal error the system will be stopped.
All, But Keyboard	The system boot will not stop for a keyboard error; it will stop for all other errors. (Default value)
All, But Diskette	The system boot will not stop for a disk error; it will stop for all other errors.
All, But Disk/Key	The system boot will not stop for a keyboard or disk error; it will stop for all other errors.

- **Memory**

The category is display-only which is determined by POST (Power On Self Test) of the BIOS.

Base Memory

The POST of the BIOS will determine the amount of base (or conventional) memory installed in the system.

The value of the base memory is typically 512 K for systems with 512 K memory installed on the motherboard, or 640 K for systems with 640 K or more memory installed on the motherboard.

Extended Memory

The BIOS determines how much extended memory is present during the POST.

This is the amount of memory located above 1 MB in the CPU's memory address map.

Advanced BIOS Features

CMOS Setup Utility-Copyright(C) 1984-2000 Award Software Advanced BIOS Features		
		Item Help
Virus Warning	Disabled	Menu Level ▶ Allows you to choose the VIRUS Warning feature For IDE Hard disk Boot sector Protection. If this Function is enable And someone Attempt to write Data into this area , BIOS will show A warning Message on Screen and alarm beep
BIOS Flash Protection	Disabled	
×Processor Number Feature	Enabled	
First Boot Device	Floppy	
Second Boot Device	HDD-0	
Third Boot Device	LS120	
Boot Up Floppy Seek	Enabled	
Boot Up NumLock Status	On	
Security Option	Setup	
HDD S.M.A.R.T. Capability	Disabled	
Report No FDD For WIN 95	No	

↑↓→←:Move Enter:Select +/-/PU/PD:Value F10:Save ESC:Exit F1:General Help
F5:Previous Values F6:Fail-Safe Defaults F7:Optimized Defaults

Figure 4: Advanced BIOS Features

×System will detect automatically and show up when you install the Pentium® !!! processor.

- **Virus Warning**

If it is set to enable, the category will flash on the screen when there is any attempt to write to the boot sector or partition table of the hard disk drive. The system will halt and the following error message will appear in the mean time. You can run anti-virus program to locate the problem.

Enabled	Activate automatically when the system boots up causing a warning message to appear when anything attempts to access the boot sector or hard disk partition table.
Disabled	No warning message to appear when anything attempts to access the boot sector or hard disk partition table. (Default value)

- **BIOS Flash Protection**

Enabled	Enabled BIOS Flash Protection.
Disabled	Disabled BIOS Flash Protection. (Default Value)

- **Processor Number Feature**

This item will show up when you install the Pentium® !!! processor.

Enabled	Pentium® !!! Processor Number Feature. (Default value)
Disabled	Disable this function.

- **First / Second / Third Boot device**

Floppy	Select your boot device priority by Floppy.
LS120	Select your boot device priority by LS120.
ZIP100	Select your boot device priority by ZIP100.
HDD-0-3	Select your boot device priority by HDD-0-3.
SCSI	Select your boot device priority by SCSI.
CDROM	Select your boot device priority by CDROM.
Disable	Disable this function.
LAN	Select your boot device priority by LAN.

- **Boot Up Floppy Seek**

During POST, BIOS will determine the floppy disk drive installed is 40 or 80 tracks. 360 K type is 40 tracks 720 K, 1.2 M and 1.44 M are all 80 tracks.

Enabled	BIOS searches for floppy disk drive to determine it is 40 or 80 tracks. Note that BIOS can not tell from 720 K, 1.2 M or 1.44 M drive type as they are all 80 tracks. (Default value)
Disabled	BIOS will not search for the type of floppy disk drive by track number. Note that there will not be any warning message if the drive installed is 360 K.

- **Boot Up NumLock Status**

On	Keypad is number keys. (Default value)
Off	Keypad is arrow keys.

- **Security Option**

This category allows you to limit access to the system and Setup, or just to Setup.

System	The system can not boot and can not access to Setup page will be denied if the correct password is not entered at the prompt.
Setup	The system will boot, but access to Setup will be denied if the correct password is not entered at the prompt. (Default value)

- **HDD S.M.A.R.T. Capability**

Enabled	Enabled HDD S.M.A.R.T. Capability.
Disabled	Disabled HDD S.M.A.R.T. Capability. (Default value)

- **Report No FDD For WIN 95**

No	Assign IRQ6 For FDD. (Default value)
Yes	FDD Detect IRQ6 Automatically.

Advanced Chipset Features

CMOS Setup Utility-Copyright(C) 1984-2000 Award Software		
Advanced Chipset Features		
		Item Help
Top Performance	Disabled	
SDRAM Timing Control	Auto	
※ SDRAM CAS Latency Time	3	Menu Level ▶
※ SDRAM Cycle Time Tras/Trc	7/9	
※ SDRAM RAS-to-CAS Delay	3	
※ SDRAM RAS Precharge Time	3	
Delayed Transaction	Enabled	
On-Chip Video Window Size	64MB	
AGP Graphics Aperture Size	64MB	
♣Display Cache Frequency	133MHz	
◆System Memory Frequency	Auto	
Onboard Display Cache Setting		
♣Initial Display Cache	Enabled	
♣Display Cache Timing	Auto	
SDRAM Buffer Strength	Auto	
X SWE#, SCAS#, SRAS, SMAA, SBS	Default	
X SMD[63:0], SDQM[7:0]	Default	
X SMAA#[7:4] (Rows 0/1)	Default	
X SMAB#[7:4] (Rows 2/3)	Default	
X SMAC#[7:4] (Rows 4/5)	Default	
X SCS[0]# (Row 0)	Default	
X SCS[1]# (Row 1)	Default	
X SCS[2]# (Row 2)	Default	
X SCS[3]# (Row 3)	Default	
X SCS[4]# (Row 4)	Default	
X SCS[5]# (Row 5)	Default	
X SCKE[0]# (Row 0)	Default	
X SCKE[1]# (Row 1)	Default	
X SCKE[2]# (Row 2)	Default	
X SCKE[3]# (Row 3)	Default	
X SCKE[4]# (Row 4)	Default	
X SCKE[5]# (Row 5)	Default	
↑↓→←:Move Enter:Select +/-/PU/PD:Value F10:Save ESC:Exit F1:General Help F5:Previous Values F6:Fail-Safe Defaults F7:Optimized Defaults		

Figure 5: Advanced Chipset Features

※ These four items will be available when "SDRAM Timing Control" is set to Manual.

◆ This item will be show when the system bus frequency is 133MHZ.

♣ These three items will only be shown when you install GA-AIMM card.

- **Top Performance**

If you wish to maximize the performance of your system, set "Top Performance" as "Enabled".

Disabled	Disabled this function. (Default Value)
Enabled	Enabled Top Performance function.

- **SDRAM Timing Control**

Auto	Set SDRAM Timing Control to Auto. (Default value)
Manual	Set SDRAM Timing Control to Manual.

- **SDRAM CAS latency Time**

3	For Slower SDRAM DIMM module. (Default Value)
2	For Fastest SDRAM DIMM module.

- **SDRAM Cycle Time Tras/Trc**

7/9	Set SDRAM Tras/Trc Cycle time to 7/9 SCLKs. (Default value)
5/7	Set SDRAM Tras/Trc Cycle time to 5/7 SCLKs.

- **SDRAM RAS-to-CAS delay**

3	Set SDRAM RAS-to-CAS delay 3 SCLKs. (Default value)
2	Set SDRAM RAS-to-CAS delay 2 SCLKs.

- **SDRAM RAS Precharge Time**

3	Set SDRAM RAS Precharge Time to 3. (Default value)
2	Set SDRAM RAS Precharge Time to 2.

- **Delayed Transaction**

Disabled	Normal operation.
Enabled	For slow speed ISA device in system. (Default value)

- **On-Chip Video Window Size**

32MB	Set On-Chip Video Window Size to 32MB.
64MB	Set On-Chip Video Window Size to 64MB. (Default value)

- **AGP Graphics Aperture Size**

32 MB	Set AGP Graphics Aperture Size to 32MB.
64 MB	Set AGP Graphics Aperture Size to 64MB. (Default Value)

- **Display Cache Frequency**

100MHz	Set Display Cache Frequency to 100MHz.
133MHz	Set Display Cache Frequency to 133MHz. (Default value)

- **System Memory Frequency**

Auto	Set System Memory Frequency to Auto. (Default value)
100MHz	Set System Memory Frequency to 100MHz.
133MHz	Set System Memory Frequency to 133MHz.

- **Initial Display Cache**

Disabled	Disabled Initial Display Cache.
Enabled	Enabled Initial Display Cache. (Default value)

- **Display Cache Timing**

Auto	Set Display Cache Timing to Auto. (Default value)
Fast	Set Display Cache Timing to Fast.
Normal	Set Display Cache Timing to Normal.

- **SDRAM Buffer Strength**

Auto	Set SDRAM Buffer Strength to Auto. (Default value)
Manual	Set SDRAM Buffer Strength to Manual.

- **SWE#, SCAS#, SRAS#, SMAA, SBS**

Default	Set SWE#, SCAS#, SRAS#, SMAA, SBS to Default. (Default value)
1.7x	Set SWE#, SCAS#, SRAS#, SMAA, SBS to 1.7x.
0.7x	Set SWE#, SCAS#, SRAS#, SMAA, SBS to 0.7x.
1.0x	Set SWE#, SCAS#, SRAS#, SMAA, SBS to 1.0x.

- **SMD[63:0], SDQM[7:0]**

Default	Set SMD[63:0], SDQM[7:0] to Default. (Default value)
1.7x	Set SMD[63:0], SDQM[7:0] to 1.7x.
0.7x	Set SMD[63:0], SDQM[7:0] to 0.7x.
1.0x	Set SMD[63:0], SDQM[7:0] to 1.0x.

- **SMAA#[7:4] (Rows 0/1)**

Default	Set SMAA#[7:4] (Rows 0/1) to Default. (Default value)
2.7x	Set SMAA#[7:4] (Rows 0/1) to 2.7x.

1.7x	Set SMAA#[7:4] (Rows 0/1) to 1.7x.
1.0x	Set SMAA#[7:4] (Rows 0/1) to 1.0x.

- **SMAB#[7:4] (Rows 2/3)**

Default	Set SMAB#[7:4] (Rows 2/3) to Default. (Default value)
2.7x	Set SMAB#[7:4] (Rows 2/3) to 2.7x.
1.7x	Set SMAB#[7:4] (Rows 2/3) to 1.7x.
1.0x	Set SMAB#[7:4] (Rows 2/3) to 1.0x.

- **SMAC#[7:4] (Rows 4/5)**

Default	Set SMAC#[7:4] (Rows 4/5) to Default. (Default value)
2.7x	Set SMAC#[7:4] (Rows 4/5) to 2.7x.
1.7x	Set SMAC#[7:4] (Rows 4/5) to 1.7x.
1.0x	Set SMAC#[7:4] (Rows 4/5) to 1.0x.

- **SCS[0]# (Row 0)**

Default	Set SCS[0]# (Row 0) to Default. (Default value)
1.7x	Set SCS[0]# (Row 0) to 1.7x.
1.0x	Set SCS[0]# (Row 0) to 1.0x.

- **SCS[1]# (Row 1)**

Default	Set SCS[1]# (Row 1) to Default. (Default value)
1.7x	Set SCS[1]# (Row 1) to 1.7x.
1.0x	Set SCS[1]# (Row 1) to 1.0x.

- **SCS[2]# (Row 2)**

Default	Set SCS[2]# (Row 2) to Default. (Default value)
1.7x	Set SCS[2]# (Row 2) to 1.7x.
1.0x	Set SCS[2]# (Row 2) to 1.0x.

- **SCS[3]# (Row 3)**

Default	Set SCS[3]# (Row 3) to Default. (Default value)
1.7x	Set SCS[3]# (Row 3) to 1.7x.
1.0x	Set SCS[3]# (Row 3) to 1.0x.

- **SCS[4]# (Row 4)**

Default	Set SCS[4]# (Row 4) to Default. (Default value)
1.7x	Set SCS[4]# (Row 4) to 1.7x.
1.0x	Set SCS[4]# (Row 4) to 1.0x.

- **SCS[5]# (Row 5)**

Default	Set SCS[5]# (Row 5) to Default. (Default value)
1.7x	Set SCS[5]# (Row 5) to 1.7x.
1.0x	Set SCS[5]# (Row 5) to 1.0x.

- **SCKE[0]# (Row 0)**

Default	Set SCKE[0]# (Row 0) to Default. (Default value)
2.7x	Set SCKE[0]# (Row 0) to 2.7x.
1.7x	Set SCKE[0]# (Row 0) to 1.7x.

- **SCKE[1]# (Row 1)**

Default	Set SCKE[1]# (Row 1) to Default. (Default value)
2.7x	Set SCKE[1]# (Row 1) to 2.7x.
1.7x	Set SCKE[1]# (Row 1) to 1.7x.

- **SCKE[2]# (Row 2)**

Default	Set SCKE[2]# (Row 2) to Default. (Default value)
2.7x	Set SCKE[2]# (Row 2) to 2.7x.
1.7x	Set SCKE[2]# (Row 2) to 1.7x.

- **SCKE[3]# (Row 3)**

Default	Set SCKE[3]# (Row 3) to Default. (Default value)
2.7x	Set SCKE[3]# (Row 3) to 2.7x.
1.7x	Set SCKE[3]# (Row 3) to 1.7x.

- **SCKE[4]# (Row 4)**

Default	Set SCKE[4]# (Row 4) to Default. (Default value)
2.7x	Set SCKE[4]# (Row 4) to 2.7x.
1.7x	Set SCKE[4]# (Row 4) to 1.7x.

- **SCKE[5]# (Row 5)**

Default	Set SCKE[5]# (Row 5) to Default. (Default value)
2.7x	Set SCKE[5]# (Row 5) to 2.7x.
1.7x	Set SCKE[5]# (Row 5) to 1.7x.

Integrated Peripherals

CMOS Setup Utility-Copyright(C) 1984-2000 Award Software Integrated Peripherals		
On-Chip Primary PCI IDE	Enabled	Item Help
On-Chip Secondary PCI IDE	Enabled	
IDE Primary Master PIO	Auto	Menu Level ▶
IDE Primary Slave PIO	Auto	
IDE Secondary Master PIO	Auto	
IDE Secondary Slave PIO	Auto	
IDE Primary Master UDMA	Auto	
IDE Primary Slave UDMA	Auto	
IDE Secondary Master UDMA	Auto	
IDE Secondary Slave UDMA	Auto	
USB Controller	Enabled	
USB Keyboard Support	Disabled	
USB Mouse Support	Disabled	
Init Display First	PCI Slot	
AC97 Audio	Auto	
AC97 Modem	Auto	
IDE HDD Block Mode	Enabled	
POWER ON by Keyboard	Disabled	
X KB Power ON Password	Enter	
POWER ON by Mouse	Disabled	
Onboard FDC Controller	Enabled	
Onboard Serial Port 1	3F8/IRQ4	
Onboard IR Port	2F8/IRQ3	
UART Mode Select	IrDA	
UR2 Duplex Mode	Half	
Onboard Parallel Port	378/IRQ7	
Parallel Port Mode	SPP	
AC Back Function	Soft-Off	
Game Port Address	201	
Midi Port Address	330	
Midi Port IRQ	10	

↑↓←→:Move Enter:Select +/-/PU/PD:Value F10:Save ESC:Exit F1:General Help
F5:Previous Values F6:Fail-Safe Defaults F7:Optimized Defaults

Figure 6: Integrated Peripherals

- On-Chip Primary PCI IDE

Enabled	Enabled onboard 1st channel IDE port. (Default value)
Disabled	Disabled onboard 1st channel IDE port.

- **On-Chip Secondary PCI IDE**

Enabled	Enabled onboard 2nd channel IDE port. (Default value)
Disabled	Disabled onboard 2nd channel IDE port.

- **IDE Primary Master PIO (for onboard IDE 1st channel)**

Auto	BIOS will automatically detect the IDE HDD Accessing mode. (Default value)
Mode0-4	Manually set the IDE Accessing mode.

- **IDE Primary Slave PIO (for onboard IDE 1st channel)**

Auto	BIOS will automatically detect the IDE HDD Accessing mode. (Default value)
Mode0-4	Manually set the IDE Accessing mode.

- **IDE Secondary Master PIO (for onboard IDE 2nd channel)**

Auto	BIOS will automatically detect the IDE HDD Accessing mode. (Default value)
Mode0-4	Manually set the IDE Accessing mode.

- **IDE Secondary Slave PIO (for onboard IDE 2nd channel)**

Auto	BIOS will automatically detect the IDE HDD Accessing mode. (Default value)
Mode0-4	Manually set the IDE Accessing mode.

- **IDE Primary Master UDMA**

Auto	BIOS will automatically detect the IDE HDD Accessing mode. (Default value)
Disabled	Disable UDMA function.

- **IDE Primary Slave UDMA**

Auto	BIOS will automatically detect the IDE HDD Accessing mode. (Default value)
Disabled	Disable UDMA function.

- **IDE Secondary Master UDMA**

Auto	BIOS will automatically detect the IDE HDD Accessing mode. (Default value)
Disabled	Disable UDMA function.

- **IDE Secondary Slave UDMA**

Auto	BIOS will automatically detect the IDE HDD Accessing mode. (Default value)
Disabled	Disabled UDMA function.

- **USB Controller**

Enabled	Enabled USB Controller. (Default value)
Disabled	Disabled USB Controller.

- **USB Keyboard Support**

Enabled	Enabled USB Keyboard Support.
Disabled	Disabled USB Keyboard Support. (Default value)

- **USB Mouse Support**

Enabled	Enabled USB Mouse Support.
Disabled	Disabled USB Mouse Support. (Default value)

- **Init Display First**

PCI Slot	Set Init Display First to PCI Slot. (Default value)
Onboard/AGP	Set Init Display First to onboard/AGP.

- **AC97 Audio**

Auto	BIOS will automatically detect onboard AC97 Audio. (Default value)
Disabled	Disabled AC97 Audio.

- **AC97 Modem**

Auto	Bios will automatically detect onboard AC97 Modem. (Default value)
Disabled	Disabled AC97 Modem.

- **IDE HDD Block Mode**

Enabled	Enabled IDE HDD Block Mode. (Default value)
Disabled	Disabled IDE HDD Block Mode.

- **POWER ON by Keyboard**

Password	Enter from 1 to 5 characters to set the Keyboard Power On Password.
Disabled	Disabled this function. (Default value)
Keyboard 98	If your keyboard have "POWER Key" button, you can press the key to power on your system.

- **KB Power ON Password**

Enter	Enter from 1 to 5 characters to set the Keyboard Power On Password.
-------	---

- **POWER ON by Mouse**

Mouse Click	Double click on PS/2 mouse left button.
Disabled	Disabled this function. (Default value)

- **Onboard FDC Controller**

Enabled	Enabled onboard FDC port. (Default value)
Disabled	Disabled onboard FDC port.

- **Onboard Serial Port 1**

Auto	BIOS will automatically setup the port 1 address.
3F8/IRQ4	Enabled onboard Serial port 1 and address is 3F8. (Default value)
2F8/IRQ3	Enabled onboard Serial port 1 and address is 2F8.
3E8/IRQ4	Enabled onboard Serial port 1 and address is 3E8.
2E8/IRQ3	Enabled onboard Serial port 1 and address is 2E8.
Disabled	Disabled onboard Serial port 1.

- **Onboard IR Port**

Auto	BIOS will automatically setup the IR Port address.
3F8/IRQ4	Enabled onboard IR Port and address is 3F8.
2F8/IRQ3	Enabled onboard IR Port and address is 2F8. (Default Value)
3E8/IRQ4	Enabled onboard IR Port and address is 3E8.
2E8/IRQ3	Enabled onboard IR Port and address is 2E8.
Disabled	Disabled onboard IR Port.

- **UART Mode Select**

(This item allows you to determine which Infra Red(IR) function of Onboard I/O chip)

ASKIR	Set onboard I/O chip UART to ASKIR Mode.
IrDA	Set onboard I/O chip UART to IrDA Mode. (Default Value)
SCR	Set onboard I/O chip UART to SCR Mode.

- **UR2 Duplex Mode**

Half	IR Function Duplex Half. (Default Value)
Full	IR Function Duplex Full.

- **Onboard Parallel port**

378/IRQ7	Enabled onboard LPT port and address is 378/IRQ7. (Default Value)
278/IRQ5	Enabled onboard LPT port and address is 278/IRQ5.
Disabled	Disabled onboard LPT port.
3BC/IRQ7	Enabled onboard LPT port and address is 3BC/IRQ7.

- **Parallel Port Mode**

SPP	Using Parallel port as Standard Parallel Port. (Default Value)
EPP	Using Parallel port as Enhanced Parallel Port.
ECP	Using Parallel port as Extended Capabilities Port.
ECP+EPP	Using Parallel port as ECP & EPP mode.

- **AC Back Function**

Memory	This function depends on computer status.
Soft-Off	Set System Soft-Off Status. (Default value)
Full-On	Set System Full-On Status.

- **Game Port Address**

Disabled	Disabled this function.
201	Set onboard game port to 201. (Default Value)
209	Set onboard game port to 209.

- **Midi Port Address**

Disabled	Disabled On Board Midi Port.
300	Set On Board Midi Port to 300.
330	Set On Board Midi Port to 330. (Default Value)

- **Midi Port IRQ**

5	Set 5 for Midi Port IRQ.
10	Set 10 for Midi Port IRQ. (Default Value)

Power Management Setup

CMOS Setup Utility-Copyright(C) 1984-2000 Award Software Power Management Setup		
*ACPI Suspend Type	S1(PowerOn suspend)	Item Help
Video Off Method	DPMS	Menu Level ▶
Suspend Type	Stop Grant	
MODEM Use IRQ	4	
Suspend Mode	Disabled	
HDD Power Down	Disabled	
Soft-Off by PWR-BTTN	Instant-off	
Power LED in Suspend	Blinking	
Wake-Up by PCI card	Enabled	
ModemRingOn/WakeOnLan	Enabled	
*USB KB/Mouse Wake From S3	Disabled	
FAN Off In Suspend	Enabled	
CPU Thermal-Throttling	50%	
Resume by Alarm	Disabled	
X Date(of Month) Alarm	Everyday	
X Time(hh:mm:ss) Alarm	0 0 0	
** Reload Global Timer Events **		
Primary IDE 0	Disabled	
Primary IDE 1	Disabled	
Secondary IDE 0	Disabled	
Secondary IDE 1	Disabled	
FDD,COM,LPT Port	Disabled	
PCI PIRQ[A-D]#	Disabled	

↑↓→←:Move Enter:Select +/-/PU/PD:Value F10:Save ESC:Exit F1:General Help
F5:Previous Values F6:Fail-Safe Defaults F7:Optimized Defaults

Figure 7: Power Management Setup

*These two items will be shown when the system support STR function.

- **ACPI Suspend Type**

S1(PowerOn Suspend)	Set ACPI Suspend type to S1. (Default value)
S3(Suspend to RAM)	Set ACPI Suspend type to S3.

- **Video off Method**

V/H SYNC+Blank	BIOS will turn off V/H-SYNC when gets into Green mode for Green monitor power saving.
Blank Screen	BIOS will only black monitor when gets into Green mode.
DPMS	BIOS will use DPMS Standard to control VGA card. (The Green type VGA card will turn off V/H-SYNC automatically.) (Default value)

- **Suspend Type**

Stop Grant	Set Suspend type to stop grant. (Default value)
PwrOn Suspend	Set Suspend type to Power on Suspend.

- **MODEM Use IRQ**

NA	Set MODEM Use IRQ to NA.
3	Set MODEM Use IRQ to 3.
4	Set MODEM Use IRQ to 4. (Default value)
5	Set MODEM Use IRQ to 5.
7	Set MODEM Use IRQ to 7.
9	Set MODEM Use IRQ to 9.
10	Set MODEM Use IRQ to 10.
11	Set MODEM Use IRQ to 11.

- **Suspend Mode**

Disabled	Disabled Suspend Mode. (Default value)
1 min - 1 Hour	Setup the timer to enter Suspend Mode.

- **HDD Power Down**

Disabled	Disabled HDD Power Down mode function. (Default value)
1-15 mins.	Enabled HDD Power Down mode between 1 to 15 mins.

- **Soft-off by PWR-BTTN**

Instant-off	Soft switch ON/OFF for POWER ON/OFF. (Default value)
Delay 4 Sec.	Soft switch ON 4sec. for POWER OFF.

- **Power LED in Suspend**

Blinking	Set Power LED in Suspend at Blinking mode. (Default value)
On	Set Power LED in Suspend at On mode.
Off/Dual	Set Power LED in Suspend at Off/Dual color mode.

- **Wake-Up by PCI card**

Disabled	Disabled this function.
Enabled	Enabled wake-up by PCI card. (Default value)

- **ModemRingOn / WakeOnLan**

Disabled	Disabled these functions.
Enabled	Enabled these functions. (Default value)

- **USB KB/Mouse Wake From S3**

Disabled	Disabled this function. (Default value)
Enabled	Enabled USB KB/Mouse Wake From S3 function.

- **FAN Off In Suspend**

Disabled	Disabled this function.
Enabled	Stop CPU FAN when entering Suspend mode. (Default value)

- **CPU Thermal-Throttling**

87.5%	Monitor CPU Temp. will cause system slow down CPU Duty Cycle to 87.5%.
75.0%	Monitor CPU Temp. will cause system slow down CPU Duty Cycle to 75.0%.
62.5%	Monitor CPU Temp. will cause system slow down CPU Duty Cycle to 62.5%.
50.0%	Monitor CPU Temp. will cause system slow down CPU Duty Cycle to 50.0%. (Default value)
37.5%	Monitor CPU Temp. will cause system slow down CPU Duty Cycle to 37.5%.
25.0%	Monitor CPU Temp. will cause system slow down CPU Duty Cycle to 25.0%.
12.5%	Monitor CPU Temp. will cause system slow down CPU Duty Cycle to 12.5%.

- **Resume by Alarm**

You can set "Resume by Alarm" item to Enabled and key in date/time to power on system.

Disabled	Disable this function. (Default value)
Enabled	Enable alarm function to POWER ON system.

If the default value is Enabled.

Date (of Month) Alarm :	Everyday, 1~31
Time (hh: mm: ss) Alarm :	(0~23) : (0~59) : (0~59)

- **Primary IDE 0/1**

Disabled	Disabled this function. (Default value)
Enabled	Enabled monitor Primary IDE 0/1 for Green event.

- **Secondary IDE 0/1**

Disabled	Disabled this function. (Default value)
Enabled	Enabled monitor Secondary IDE 0/1 for Green event.

- **FDD,COM,LPT Port**

Disabled	Disabled this function. (Default value)
Enabled	Enabled monitor FDD,COM,LPT for Green event.

- **PCI PIRQ[A-D] #**

Enabled	Monitor PCI PIRQ[A-D]# IRQ Active.
Disabled	Ignore PCI PIRQ[A-D]# IRQ Active. (Default value)

PnP/PCI Configurations

CMOS Setup Utility-Copyright(C) 1984-2000 Award Software PnP/PCI Configurations		
Reset Configuration Data	Disabled	Item Help
Resources Controlled By X IRQ Resources	Auto (ESCD) Press Enter	Menu Level ▶
PCI/VGA Palette Snoop	Disabled	When resources are controlled manually, assign each system interrupt a type, depending on the type of device using the interrupt

↑↓→← Move Enter:Select +/-PU/PD:Value F10:Save ESC:Exit F1:General Help
F5:Previous Values F6:Fail-Safe Defaults F7:Optimized Defaults

Figure 8: PnP/PCI Configurations

- **Reset Configuration Data**

Disabled	Disabled this function. (Default value)
ESCD	Clear PnP information in ESCD.
DMI	Update Desktop Management Information data.
Both	Clear PnP information in ESCD & update DMI data.

- **Resources Controlled by**

Manual	User can set the PnP resource (I/O Address, IRQ & DMA channels) used by legacy ISA DEVICE.
Auto (ESCD)	BIOS automatically use these PnP rescuers. (Default value)

- **IRQ (3,4,5,7,9,10,11,12,15)**

PCI Device	The resource is used by PCI device.
Reserved	Set the resource to reserved.

- **PCI/VGA Palette Snoop**

Enabled	For having Video Card on ISA Bus and VGA Card on PCI Bus.
Disabled	For VGA Card only. (Default value)

PC Health Status

CMOS Setup Utility-Copyright(C) 1984-2000 Award Software		
PC Health Status		
		Item Help
Reset Case Open Status	Disabled	
Case Opened	No	
VCORE	1.632 V	Menu Level ▶
VGTL	1.424 V	
VCC3	3.264 V	
+ 5V	5.026 V	
+12V	12.032 V	
- 12V	-12.280 V	
5VSB(V)	4.972 V	
VBAT(V)	3.024 V	
Current CPU Temperature	31°C	
CPU FAN Speed	5443 RPM	
Power FAN Speed	0 RPM	
System FAN speed	0 RPM	
CPU Temperature Select	80°C/176°F	
Shutdown Temperature	Disabled	
CPU FAN Fail Alarm	Disabled	
Power FAN Fail Alarm	Disabled	
System FAN Fail Alarm	Disabled	

↑↓→ ← Move Enter:Select +/-/PU/PD:Value F10:Save ESC:Exit F1:General Help
F5:Previous Values F6:Fail-Safe Defaults F7:Optimized Defaults

Figure 9: PC Health Status

- **Reset Case Open Status**

- **Case Opened**

If the case is closed, "Case Opened" will show "No".

If the case have been opened, "Case Opened" will show "Yes".

If you want to reset "Case Opened" value, set "Reset Case Open Status" to "Enabled" and save CMOS, your computer will restart.

- **Current Voltage (V) VCORE / VGTL/ VCC3 / ±12V / +5V / 5VSB / VBAT**

Detect system's voltage status automatically.

- **Current CPU Temperature**

Detect CPU Temp. automatically.

- **CPU FAN / Power FAN / System FAN Speed (RPM)**

Detect Fan speed status automatically.

- **CPU Temperature Select (°C / °F)**

65°C / 149°F	Monitor CPU Temp. at 65°C / 149°F.
70°C / 158°F	Monitor CPU Temp. at 70°C / 158°F.
75°C / 167°F	Monitor CPU Temp. at 75°C / 167°F.
80°C / 176°F	Monitor CPU Temp. at 80°C / 176°F. (Default value)
85°C / 185°F	Monitor CPU Temp. at 85°C / 185°F.
90°C / 194°F	Monitor CPU Temp. at 90°C / 194°F.
95°C / 203°F	Monitor CPU Temp. at 95°C / 203°F.
Disabled	Disabled this function.

- **Shutdown Temperature (°C / °F)**

(This function will be effective only for the operating systems that support ACPI Function.)

Disabled	Normal Operation. (Default value)
65°C / 149°F	Monitor CPU Temp. at 65°C / 149°F, if Temp. > 65°C / 149°F system will automatically power off.
70°C / 158°F	Monitor CPU Temp. at 70°C / 158°F, if Temp. > 70°C / 158°F system will automatically power off.
75°C / 167°F	Monitor CPU Temp. at 75°C / 167°F, if Temp. > 75°C / 167°F system will automatically power off.
80°C / 176°F	Monitor CPU Temp. at 80°C / 176°F, if Temp. > 80°C / 176°F system will automatically power off.
85°C / 185°F	Monitor CPU Temp. at 85°C / 185°F, if Temp. > 85°C / 185°F system will automatically power off.
90°C / 194°F	Monitor CPU Temp. at 90°C / 194°F, if Temp. > 90°C / 194°F system will automatically power off.
95°C / 203°F	Monitor CPU Temp. at 95°C / 203°F, if Temp. > 95°C / 203°F system will automatically power off.

- **Fan Fail Alarm**

CPU / Power / System

Disabled	Fan Fail Alarm Function Disabled. (Default value)
Enabled	Fan Fail Alarm Function Enabled.

Frequency/Voltage Control

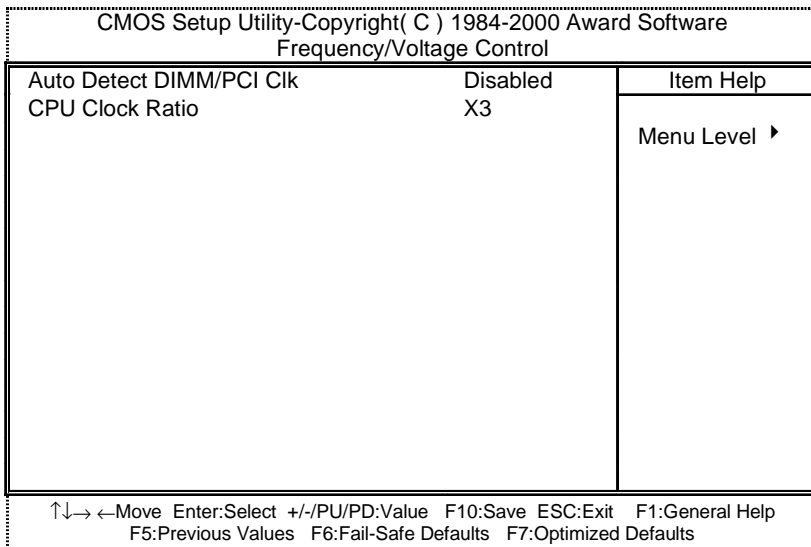

Figure 10: Frequency/Voltage Control

- **Auto Detect DIMM/PCI Clk**

Disabled	Disabled Auto Detect DIMM/PCI Clk. (Default value)
Enabled	Enabled Auto Detect DIMM/PCI Clk.

- **CPU Clock Ratio**

This option will not be shown if you are using a CPU with the locked ratio.

X3/X3.5/X4/X4.5/X5/X5.5/X6/X6.5/X7/X7.5/X8
--

Load Fail-Safe Defaults

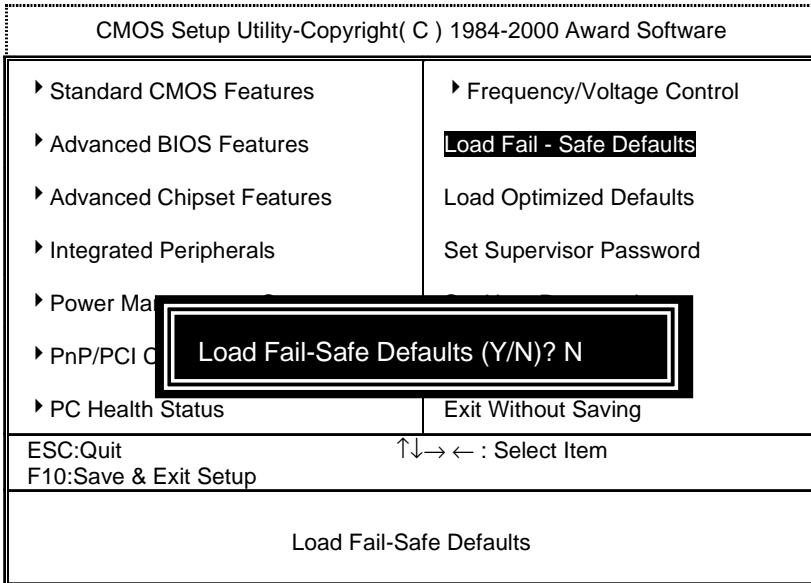

Figure 11: Load Fail-Safe Defaults

- **Load Fail-Safe Defaults**

Fail-Safe defaults contain the most appropriate values of the system parameters that allow minimum system performance.

Load Optimized Defaults

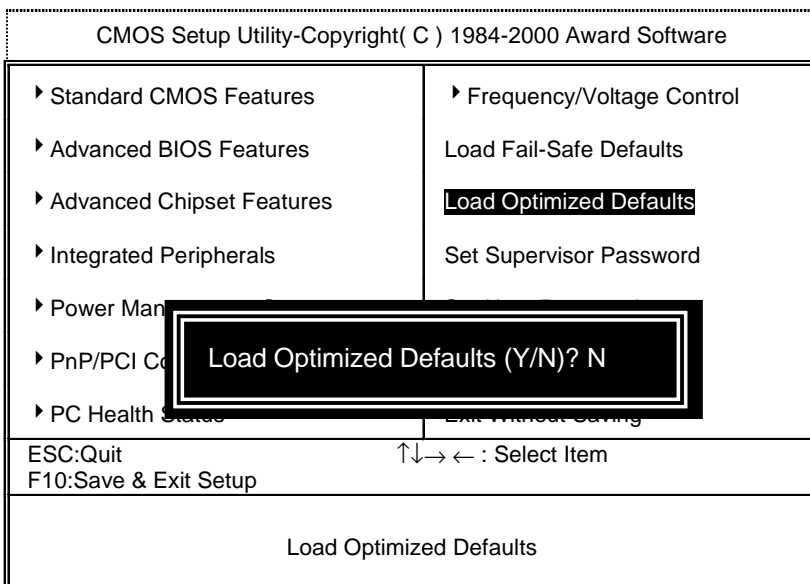

Figure 12: Load Optimized Defaults

- **Load Optimized Defaults**

Selecting this field loads the factory defaults for BIOS and Chipset Features which the system automatically detects.

Set Supervisor / User Password

When you select this function, the following message will appear at the center of the screen to assist you in creating a password.

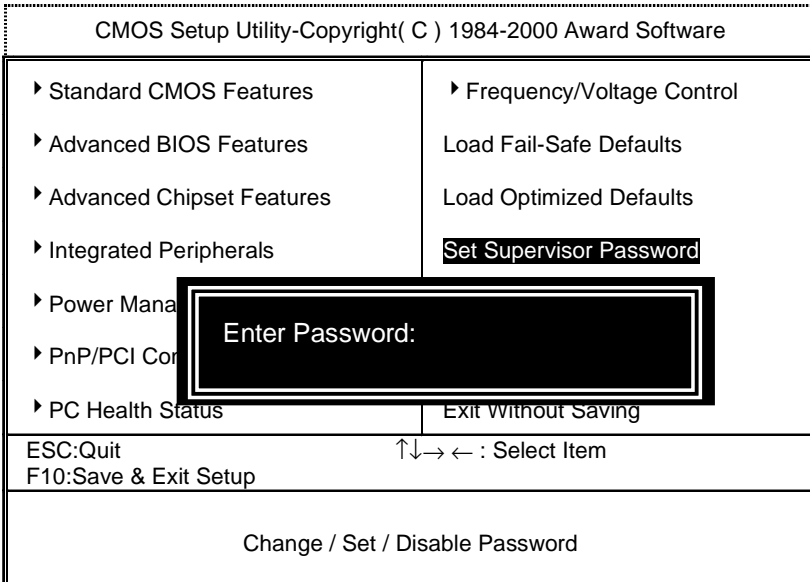

Figure 13: Password Setting

Type the password, up to eight characters, and press <Enter>. You will be asked to confirm the password. Type the password again and press <Enter>. You may also press <Esc> to abort the selection and not enter a password.

To disable password, just press <Enter> when you are prompted to enter password. A message **"PASSWORD DISABLED"** will appear to confirm the password being disabled. Once the password is disabled, the system will boot and you can enter Setup freely.

The BIOS Setup program allows you to specify two separate passwords: a **SUPERVISOR PASSWORD** and a **USER PASSWORD**. When disabled, anyone may access all BIOS Setup program function. When enabled, the Supervisor password is required for entering the BIOS Setup program and having full configuration fields, the User password is required to access only basic items.

If you select **"System"** at **"Security Option"** in Advanced BIOS Feature Menu, you will be prompted for the password every time the system is rebooted or any time you try to enter Setup Menu.

If you select **"Setup"** at **"Security Option"** in Advanced BIOS Feature Menu, you will be prompted only when you try to enter Setup.

Save & Exit Setup

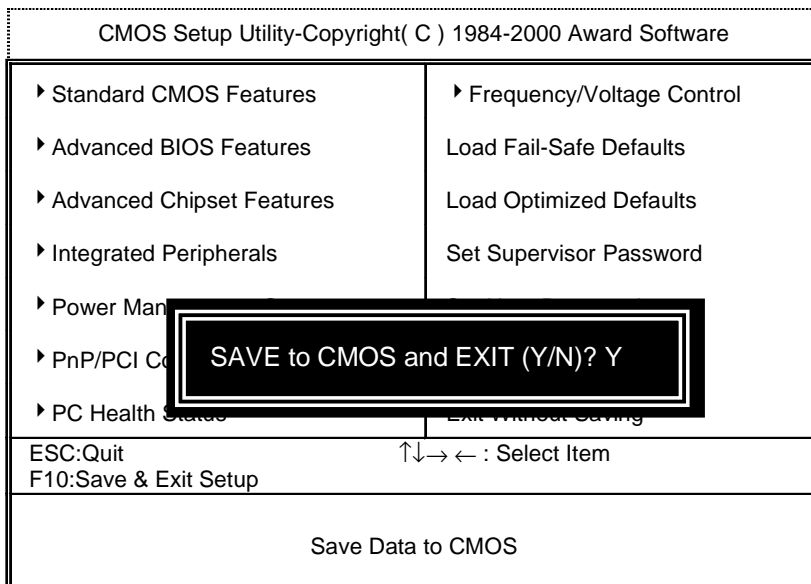

Figure 14: Save & Exit Setup

Type "Y" will quit the Setup Utility and save the user setup value to RTC CMOS.

Type "N" will return to Setup Utility.

Exit Without Saving

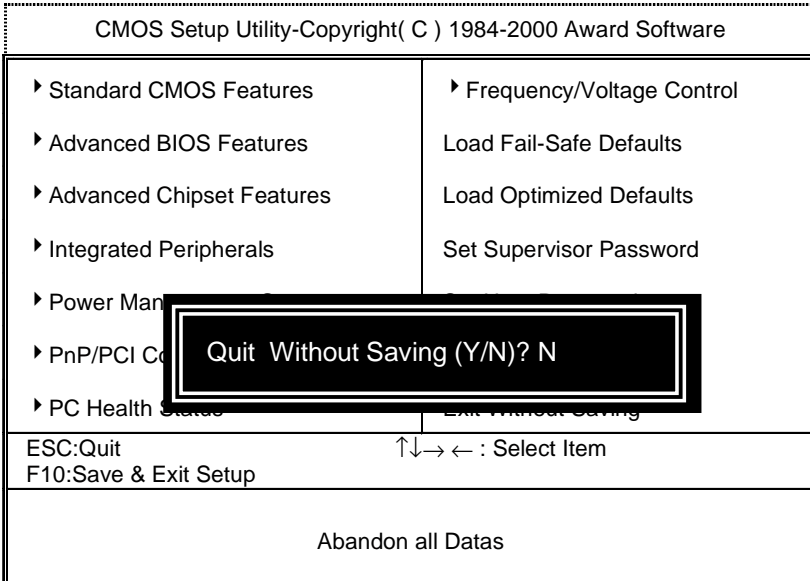

Figure 15: Exit Without Saving

Type "Y" will quit the Setup Utility without saving to RTC CMOS.

Type "N" will return to Setup Utility.

Appendix

Appendix A: Intel 815 Chipsets Driver Installation

A. Windows 9x INF Update Utility

Insert the support CD that came with your motherboard into your CD-ROM drive or double-click the CD drive icon in **My Computer** to bring up the setup screen.

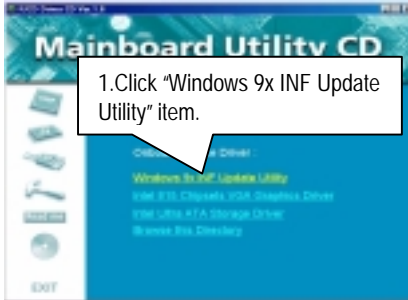

(1)

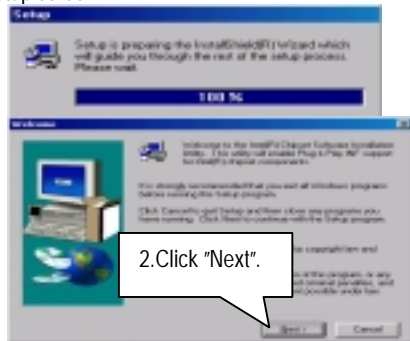

(2)

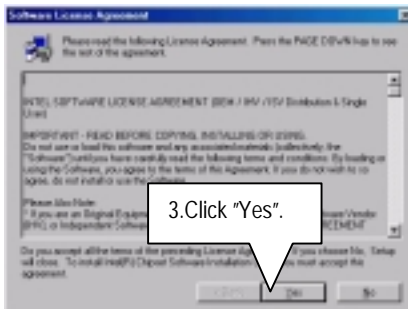

(3)

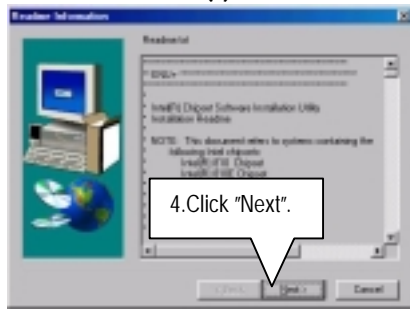

(4)



(5)

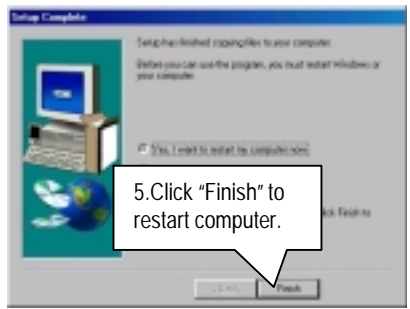

(6)

B: Intel 815 Chipsets VGA Graphics Driver Installation

Insert the support CD that came with your motherboard into your CD-ROM drive or double-click the CD drive icon in **My Computer** to bring up the setup screen.

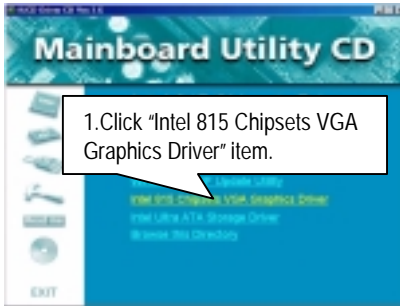

(1)

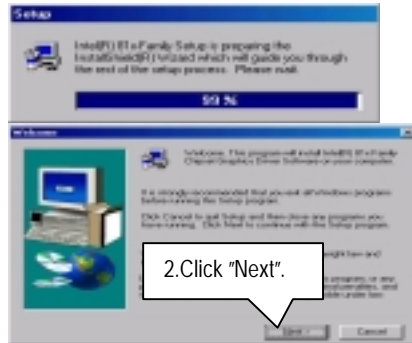

(2)

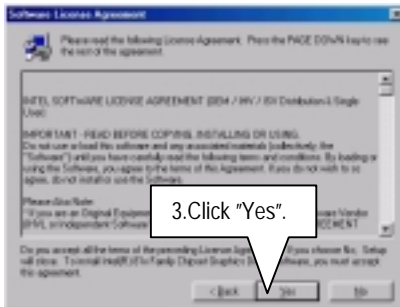

(3)



(4)

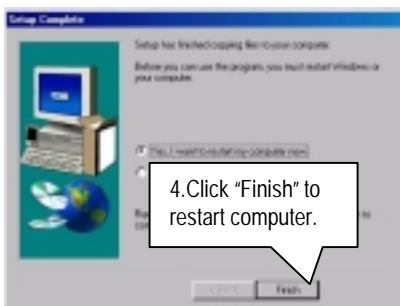

(5)

C. Intel Ultra ATA Storage Driver Installation

Insert the support CD that came with your motherboard into your CD-ROM drive or double-click the CD drive icon in **My Computer** to bring up the setup screen.

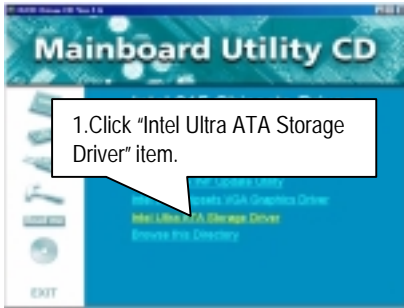

(1)

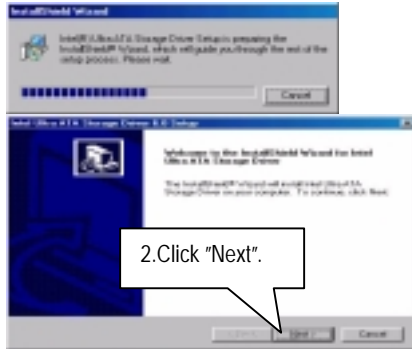

(2)

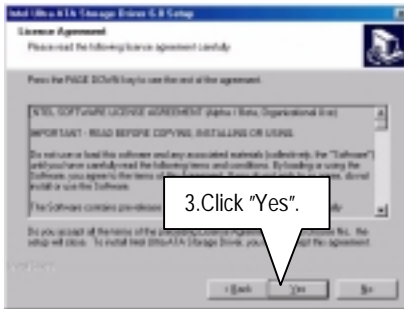

(3)

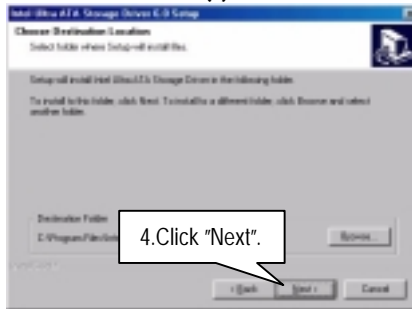

(4)

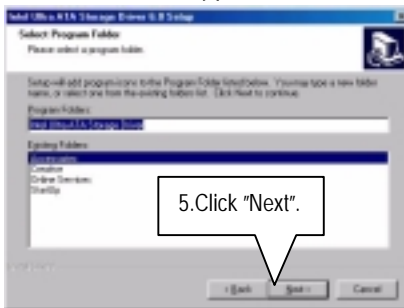

(5)

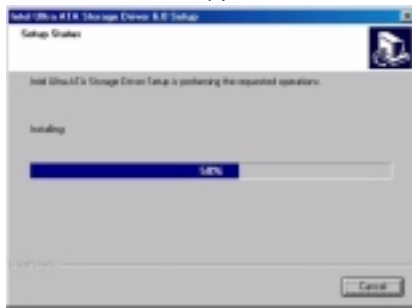

(6)

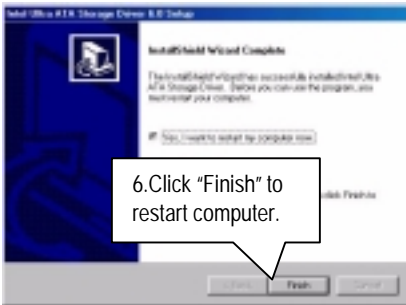

(7)

Appendix B: SigmaTel AC'97 Audio Driver Installation

Insert the support CD that came with your motherboard into your CD-ROM drive or double-click the CD drive icon in **My Computer** to bring up the setup screen.

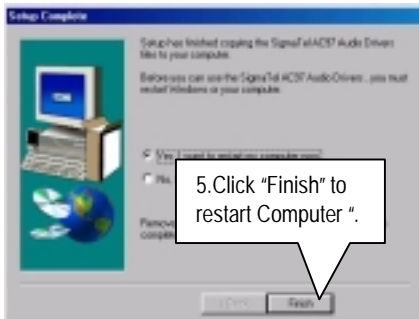
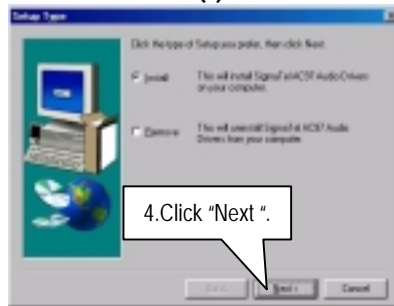
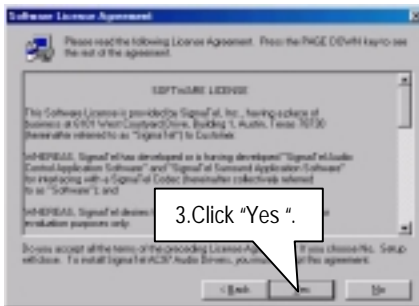
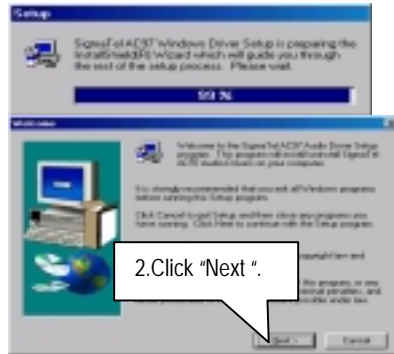
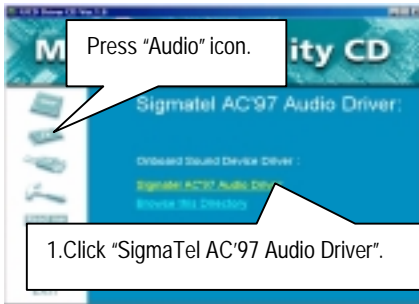

Appendix C: BIOS Flash Procedure

BIOS update procedure:

If your OS is Win9X, we recommend that you used Gigabyte @BIOS™ Program to flash BIOS.

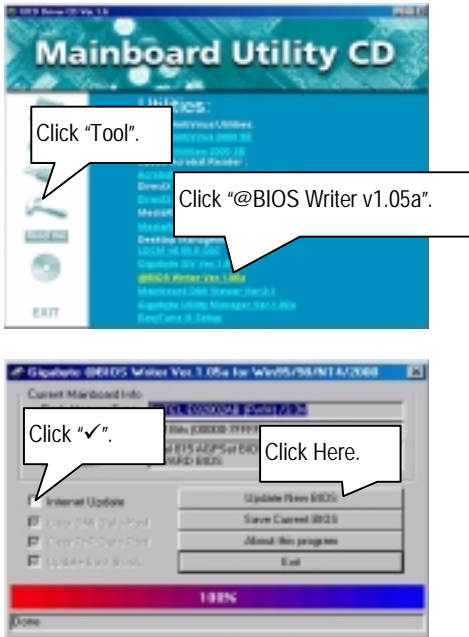

Methods and steps:

- I. Update BIOS through Internet
 - a. Click "Internet Update" icon
 - b. Click "Update New BIOS" icon
 - c. Select @BIOS™ sever ("Gigabyte @BIOS™ sever 1 in Taiwan" and "Gigabyte @BIOS™ sever 2 in Taiwan" are available for now, the others will be completed soon)
 - d. Select the exact model name on your motherboard
 - e. System will automatically download and update the BIOS.

II. Update BIOS **NOT** through Internet:

- a. **Do not** click "Internet Update" icon
- b. Click "Update New BIOS"
- c. Please select "All Files" in dialog box while opening the old file.
- d. Please search for BIOS unzip file, downloading from internet or any other methods (such as: 6OMM7.F1).
- e. Complete update process following the instruction.

III. Save BIOS

In the very beginning, there is "Save Current BIOS" icon shown in dialog box. It means to save the current BIOS version.

IV. Check out supported motherboard and Flash ROM:

In the very beginning, there is "About this program" icon shown in dialog box. It can help you check out which kind of motherboard and which brand of Flash ROM are supported.

Note:

- a. In method I, if it shows two or more motherboard's model names to be selected, please make sure your motherboard's model name again. Selecting name will cause the system unbooted.
- b. In method II, be sure that motherboard's model name in BIOS unzip file are the same as your motherboard's. Otherwise, your system won't boot.
- c. In method I, if the BIOS file you need cannot be found in @BIOS™ server, please go onto Gigabyte's web site for downloading and updating it according to method II.
- d. Please note that any intercorruption during updating will cause system unbooted

Or else you can select flash BIOS in DOS mode.

🔧 Please check your **BIOS vendor (AMI or AWARD)**, your **motherboard name** and **PCB version** on the motherboard.

1. Format a bootable system floppy diskette by the command "**format a:/s**" in command mode.
2. Visit the Gigabyte website at [http:// www.gigabyte.com.tw](http://www.gigabyte.com.tw) ,Select the BIOS file you need and download it to your bootable floppy diskette.
3. Insert the bootable diskette containing the BIOS file into the floppy diskette driver.
4. Assuming that the floppy diskette driver is A, reboot the system by using the A: driver. At the A: > prompt, run the BIOS upgraded file by executing the Flash BIOS utility and the BIOS file with its appropriate extension.

Example: *(AMI tool) (Where 60mm7.f1 is name of the BIOS file name)*

A:>flashxxx.exe 60mm7.f1 ←↵

Example: *(Award tool) (Where 60mm7.f1 is name of the BIOS file name)*

A:>Awdflash.exe 60mm7.f1 ←↵

5. Upon pressing the <Enter> key, a flash memory writer menu will appear on screen. Enter the new BIOS file name with its extension filename into the text box after file name to program.
6. If you want to save the old BIOS file(perform as soon as system is operational, this is recommended), select Y to **DO YOU WANT TO SAVE BIOS**, then type the old BIOS filename and the extension after filename to save: This option allows you to copy the contents of the flash memory chip onto a diskette, giving you a backup copy of the original motherboard BIOS in case you need to re-install it. Select N to **DO YOU WANT TO SAVE BIOS**, if you don't want to save the old BIOS file.
7. After the decision to save the old BIOS file or not is made, select Y to **ARE YOU SURE TO PROGRAM** when the next menu appear; wait until a message showing Power Off or Reset the system appears. Then turn off your system.
8. Remove the diskette and restart your system.
9. Hold down <Delete> key to enter BIOS setup. You must select "Load Setup BIOS Default" to activate the new BIOS, then you may set other item from the main menu.

Appendix D: Issues To Beware Of When Installing AMR

Please use inverse AMR card like the one in order to avoid mechanical problem. (See Figure A)

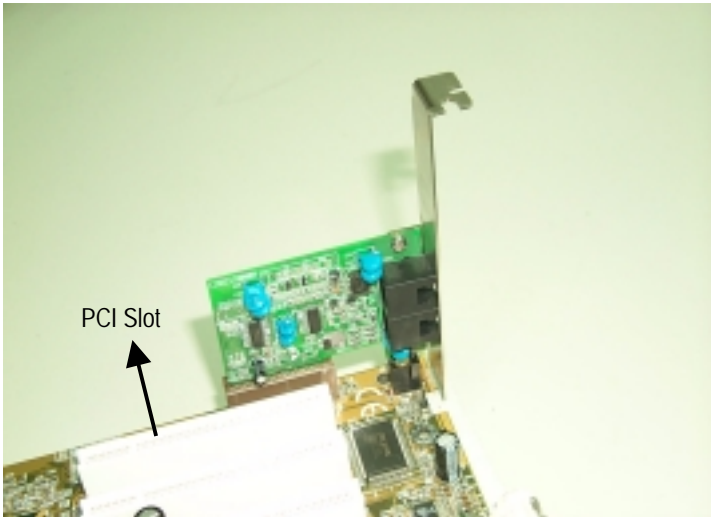

Figure A: Inverse AMR Card (Default)

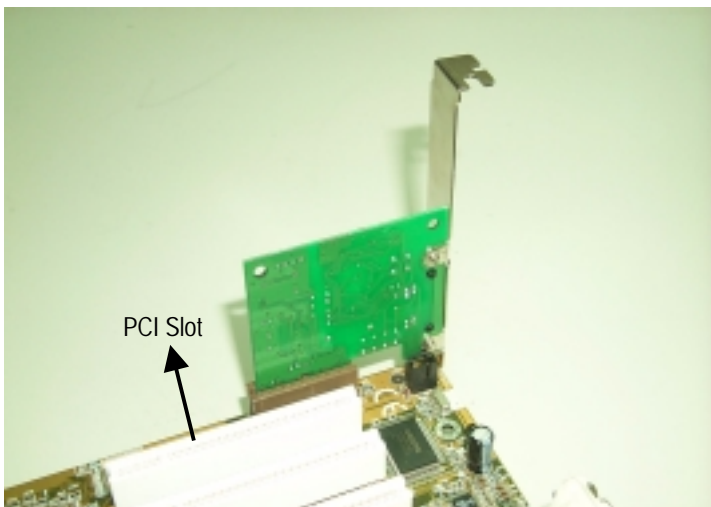
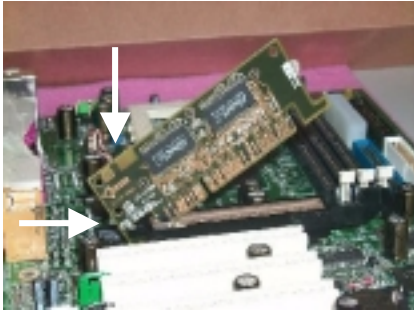

Figure B: Non inverse AMR Card

Appendix E: Issues To Beware Of When Installing GA-AIMM Card (Optional)**Install:**

1. Insert the card at an angle as shown below. Push the card forward a little making sure it's tight.



(1)

2. Push the card down as per picture below.



(2)

Remove:

3. Push the extruding piece of the AGP retention module out. Pull the card from the tip.

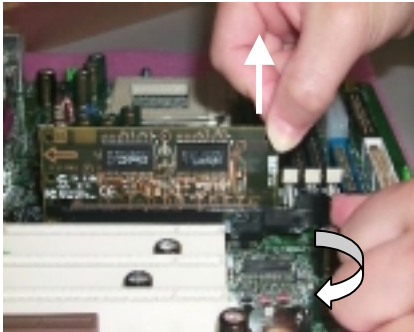

(3)

4. Lift up the card and remove from the slot.

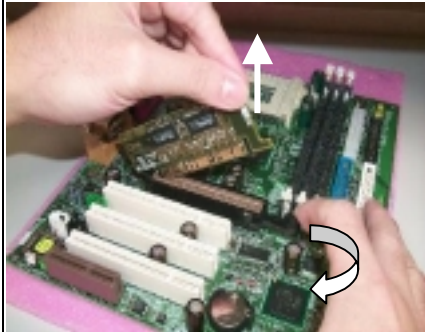

(4)

Appendix F: Acronyms

Acronyms	Meaning
ACPI	Advanced Configuration and Power Interface
POST	Power-On Self Test
LAN	Local Area Network
ECP	Extended Capabilities Port
APM	Advanced Power Management
DMA	Direct Memory Access
MHz	Megahertz
ESCD	Extended System Configuration Data
CPU	Central Processing Unit
SMP	Symmetric Multi-Processing
USB	Universal Serial Bus
OS	Operating System
ECC	Error Checking and Correcting
IDE	Integrated Dual Channel Enhanced
SCI	Special Circumstance Instructions
LBA	Logical Block Addressing
EMC	Electromagnetic Compatibility
BIOS	Basic Input / Output System
SMI	System Management Interrupt
IRO	Interrupt Request
NIC	Network Interface Card
A.G.P.	Accelerated Graphics Port
S.E.C.C.	Single Edge Contact Cartridge
LED	Light Emitting Diode
EPP	Enhanced Parallel Port
CMOS	Complementary Metal Oxide Semiconductor
I/O	Input / Output
ESD	Electrostatic Discharge
OEM	Original Equipment Manufacturer
SRAM	Static Random Access Memory
VID	Voltage ID
DMI	Desktop Management Interface
MIDI	Musical Interface Digital Interface
IOAPIC	Input Output Advanced Programmable Input Controller
DIMM	Dual Inline Memory Module
DRAM	Dynamic Random Access Memory
PAC	PCI A.G.P. Controller
AMR	Audio Modem Riser

To be continued...

Acronyms	Meaning
PCI	Peripheral Component Interconnect
RIMM	Rambus in-line Memory Module
DRM	Dual Retention Mechanism
ISA	Industry Standard Architecture
MTH	Memory Translator Hub
CRIMM	Continuity RIMM