



- ✍ **The author assumes no responsibility for any errors or omissions that may appear in this document nor does the author make a commitment to update the information contained herein.**
- ✍ **Third-party brands and names are the property of their respective owners.**
- ✍ **Please do not remove any labels on motherboard, this may void the warranty of this motherboard.**
- ✍ **Due to rapid change in technology, some of the specifications might be out of date before publication of this booklet.**



WARNING: Never run the processor without the heatsink properly and firmly attached. PERMANENT DAMAGE WILL RESULT!

Mise en garde: Ne faites jamais tourner le processeur sans que le dissipateur de chaleur soit fixé correctement et fermement. UN DOMMAGE PERMANENT EN RÉSULTERA !

Achtung: Der Prozessor darf nur in Betrieb genommen werden, wenn der W ärmehleiter ordnungsgem ä und fest angebracht ist. DIES HAT EINEN PERMANENTEN SCHADEN ZUR FOLGE!

Advertencia: Nunca haga funcionar el procesador sin el dissipador de calor instalado correcta y firmemente. ¡SE PRODUCIRÁ UN DAÑO PERMANENTE!

Aviso: Nunca execute o procesador sem o dissipador de calor estar adequado e firmemente conectado. O RESULTADO SERÁ UM DANO PERMANENTE!

警告: 將散熱板牢固地安裝到處理器上之前，不要運行處理器，這將導致永久性損壞!

警告: 將散熱器牢固地安裝到處理器上之前，不要運行處理器，這將導致永久性損壞!

경고: 히트싱크를 제대로 보 단납혀 부착시키기 않은 채 프로세서들 구동시키지 마십시오. 영구적 손상이 발생할 수 있습니다!

警告: 永久的な損傷を防ぐため、ヒートシンクを正しくしっかりと取り付けるまでは、プロセッサを動作させないようにしてください。

Declaration of Conformity

[Redacted]

[Redacted]

[Redacted]

[Redacted]

[Redacted]

[Redacted]

[Redacted]

[Redacted]

[Redacted]

[Redacted]

[Redacted]

[Redacted]

[Redacted]

[Redacted]

[Redacted]

[Redacted]

[Redacted]

[Redacted]

[Redacted]

[Redacted]



Rex Lin

[Redacted]

[Redacted]

[Redacted]

[Redacted]

[Redacted]

DECLARATION OF CONFORMITY

Per FCC Part 2 Section 2.1077(a)



Responsible Party **G.B.T. INC.**

Name: **Address: 18305 Valley Blvd., Suite#A LA
Puent, CA 91744**

Phone/Fax No:(818) 854-9338/(818) 854-9339

hereby declares that the product

Product Name: Motherboard

Model Number: GA-6IEM /GA-6IEML

Conforms to the following specifications:

FCC Part 15, Subpart B, Section 15.107(a) and Section 15.109
(a), Class B Digital Device

Supplementary Information:

This device complies with part 15 of the FCC Rules . Operation is subject to the following two conditions: (1) This device may not cause harmful and (2) this device must accept any interference received, including that may cause undesired operation.

Representative Person's Name: ERIC LU

Signature: Eric Lu

Date: October 19,2001

USER'S MANUAL

Table of Content

Revision History

Item Checklist

- -
 -
 -
 -
-

WARNING!



Installing the motherboard to the chassis...

Chapter 1 Introduction

Features Summary

④

④

④

④

④

④

④

④

④

④

④

④

④

④

④

④

④

④

④

④

④

④

GA-6IEM Series Motherboard Layout

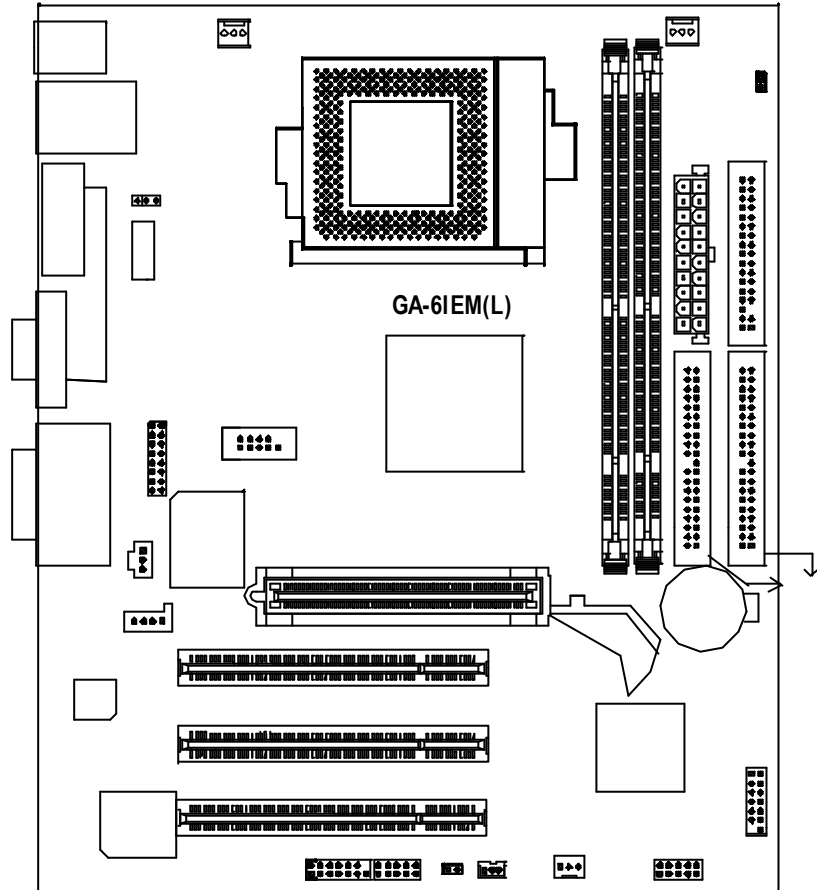

* For GA-6IEM(L) only.

Chapter 2 Hardware Installation Process

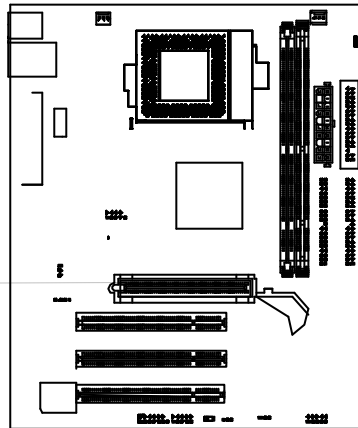

Step1-1: CPU Installation

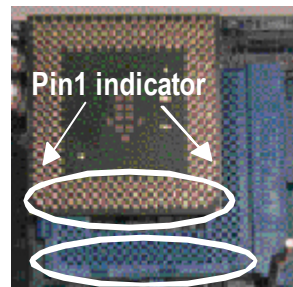
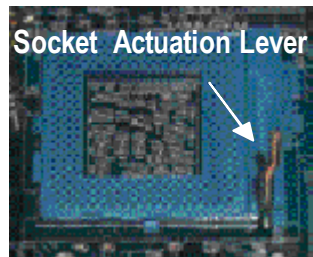
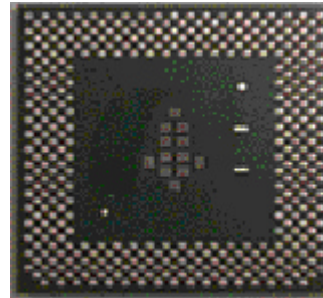
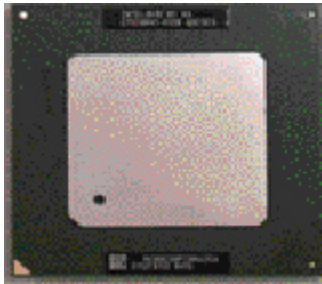

- ✍ Please make sure the CPU type is supported by the motherboard.
 - ✍ If you do not match the CPU socket Pin 1 and CPU cut edge well, it will cause improper installation. Please change the insert orientation.
-

Step1-2:CPU Heat Sink Installation

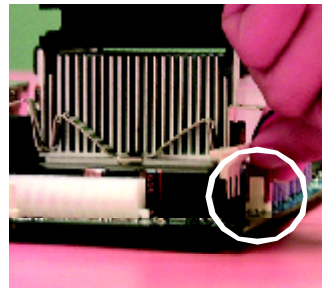
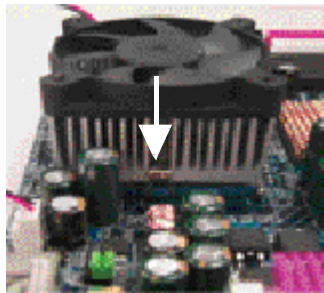
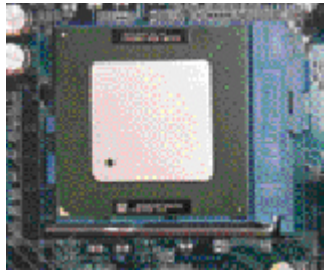

- ⌘ Please use Intel approved cooling fan.
 - ⌘ We recommend you to apply the thermal paste to provide better heat conduction between your CPU and heatsink.
 - ⌘ Make sure the CPU fan power cable is plugged in to the CPU fan connector, this completes the installation.
 - ⌘ Please refer to CPU heat sink user's manual for more detail installation procedure.
-

Step 2: Install memory modules

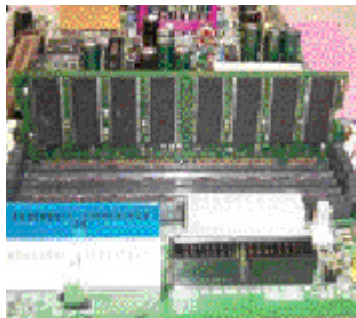

- ✎ When STR/DIMM LED is ON, do not install/remove SDRAM from socket.
 - ✎ Please note that the DIMM module can only fit in one direction due to the two notches. Wrong orientation will cause improper installation. Please change the insert orientation.
-

Step 3: Install expansion cards

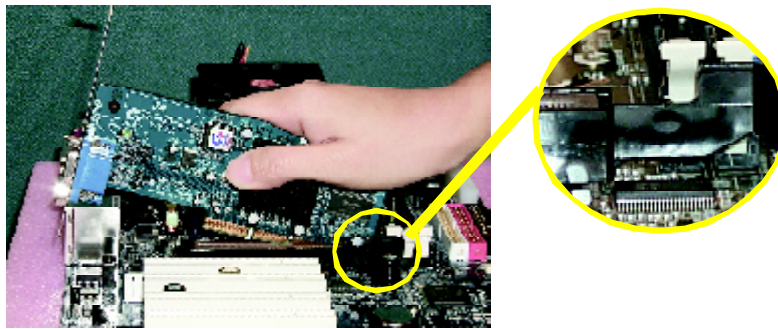

Step 4: Connect ribbon cables, cabinet wires, and power supply

Step4-1:I/O Back Panel Introduction

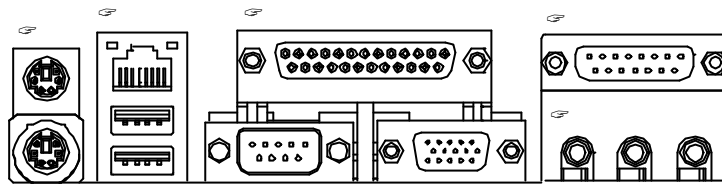

☞ PS/2 Keyboard and PS/2 Mouse Connector



☞ USB & LAN Connector

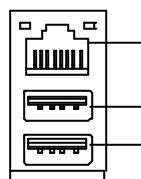

* For GA-6IEML only.

☞ **Parallel Port , Serial Port and VGA Port (LPT/COMA/VGA)**

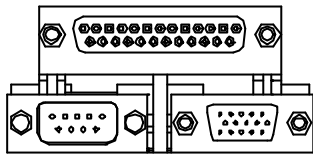

☞ **Game /MIDI Ports**

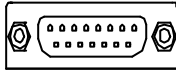

☞ **Audio Connectors**

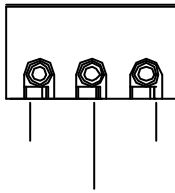

Step4-2: Connectors Introduction

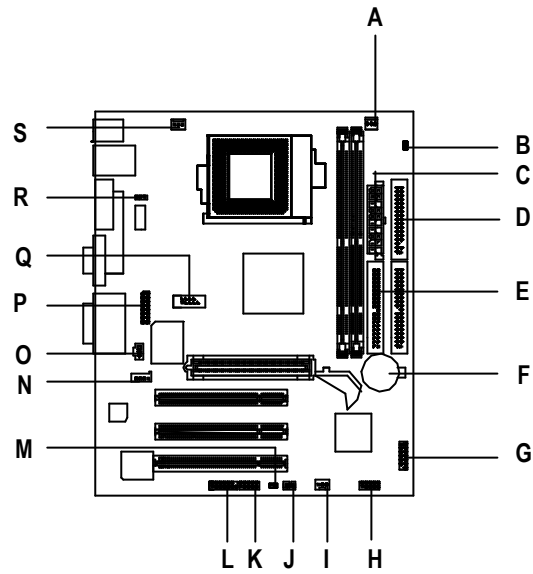

-
- | | |
|-------------|---------|
| A) J2 | K) JP13 |
| B) LED 2 | L) J16 |
| C) ATX PWR | M) JP22 |
| D) Floppy | N) J5 |
| E) IDE/IDE2 | O) JP44 |
| F) BATTERY | P) JP41 |
| G) F_PANEL | Q) CN10 |
| H) JP32 | R) JP34 |
| I) J14 | S) J1 |
| J) J12 | |
-

A) J2 (Power_FAN Connector)

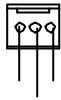

I) J14 (SYS_FAN Connector)

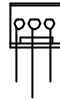

S) J1 (CPU_FAN Connector)

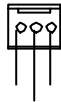

C) ATX PWR (ATX Power)

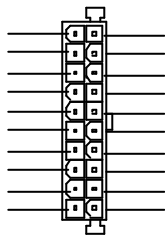

J) J12 (Wake on LAN)

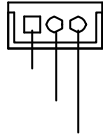

O)JP44 (SPDIF)



P)JP41 (F_AUDIO Connector)

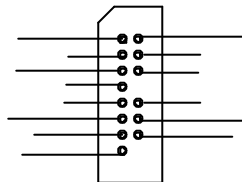

D) Floppy Connector



E) IDE1 / IDE2 Connector

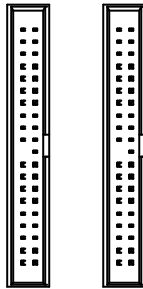

Q) CN10 (COM B)



H) JP32 (Front USB Connector)

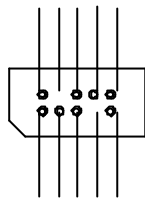

B) LED 2 (STR/DIMM LED)



N) J5 (CD_IN)

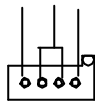

R) JP34 (Onboard LAN Function)*



* For GA-6IEML only.

K) JP13 (IR/CIR)

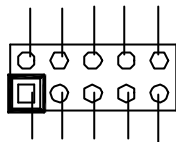

L) J16 (Smart Card Reader Header)

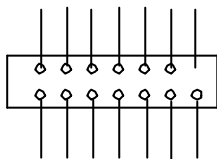

M) JP22 (CASE OPEN)



G) F_PANEL (2x7 pins jumper)

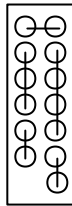

✍

F) Battery

CAUTION

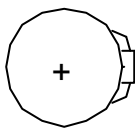

✍

✍

✍

Chapter 3 BIOS Setup

BIOS Setup is an overview of the BIOS Setup Program. The program that allows users to modify the basic system configuration. This type of information is stored in battery-backed CMOS RAM so that it retains the Setup information when the power is turned off.

ENTERING SETUP

Power ON the computer and press immediately will allow you to enter Setup.

CONTROL KEYS

<Left>	Move to previous item
<Right>	Move to next item
<Left>	Move to the item in the left hand
<Right>	Move to the item in the right hand
<Esc>	Main Menu - Quit and not save changes into CMOS Status Page Setup Menu and Option Page Setup Menu - Exit current page and return to Main Menu
<+/PgUp>	Increase the numeric value or make changes
<-/PgDn>	Decrease the numeric value or make changes
<F1>	General help, only for Status Page Setup Menu and Option Page Setup Menu
<F2>	Reserved
<F3>	Reserved
<F4>	Reserved
<F5>	Restore the previous CMOS value from CMOS, only for Option Page Setup Menu
<F6>	Load the default CMOS value from BIOS default table, only for Option Page Setup Menu
<F7>	Load the Setup Defaults
<F8>	Reserved
<F9>	Reserved
<F10>	Save all the CMOS changes, only for Main Menu

GETTING HELP

Main Menu

The on-line description of the highlighted setup function is displayed at the bottom of the screen.

Status Page Setup Menu / Option Page Setup Menu

Press F1 to pop up a small help window that describes the appropriate keys to use and the possible selections for the highlighted item. To exit the Help Window press <Esc>.

Q-Flash Utility

After power on the computer, pressing immediately during POST (Power On Self Test) it will allow you to enter Award BIOS CMOS SETUP, then press <F8> to enter Q-Flash utility.

The Main Menu (For example: BIOS Ver. :F3d)

Once you enter Award BIOS CMOS Setup Utility, the Main Menu (Figure 1) will appear on the screen. The Main Menu allows you to select from eight setup functions and two exit choices. Use arrow keys to select among the items and press <Enter> to accept or enter the sub-menu.

CMOS Setup Utility - Copyright (C) 1984-2001 Award Software

↵Standard CMOS Features ↵Advanced BIOS Features ↵Advanced Chipset Features ↵Integrated Peripherals ↵Power Management Setup ↵PnP/PCI Configurations ↵PC Health Status	↵Frequency/Voltage Control Load Fail-Safe Defaults Load Optimized Defaults Set Supervisor Password Set User Password Save & Exit Setup Exit Without Saving
ESC: Quit	↵↵↵↵: Select Item
F8: Q-Flash	F10: Save & Exit Setup
Time, Date, Hard Disk Type...	

Figure 1: Main Menu

Standard CMOS Features

This setup page includes all the items in standard compatible BIOS.

Advanced BIOS Features

This setup page includes all the items of Award special enhanced features.

- ✎ **Advanced Chipset Features**
This setup page includes all the items of chipset special features.
- ✎ **Integrated Peripherals**
This setup page includes all onboard peripherals.
- ✎ **Power Management Setup**
This setup page includes all the items of Green function features.
- ✎ **PnP/PCI Configurations**
This setup page includes all the configurations of PCI & PnP ISA resources.
- ✎ **PC Health Status**
This setup page is the System auto detect Temperature, voltage, fan, speed.
- ✎ **Frequency/Voltage Control**
This setup page is control CPU's clock and frequency ratio.
- ✎ **Load Fail-Safe Defaults**
Fail-Safe Defaults indicates the value of the system parameters which the system would be in safe configuration.
- ✎ **Load Optimized Defaults**
Optimized Defaults indicates the value of the system parameters which the system would be in best performance configuration.
- ✎ **Set Supervisor password**
Change, set, or disable password. It allows you to limit access to the system and Setup, or just to Setup.
- ✎ **Set User password**
Change, set, or disable password. It allows you to limit access to the system.
- ✎ **Save & Exit Setup**
Save CMOS value settings to CMOS and exit setup.
- ✎ **Exit Without Saving**
Abandon all CMOS value changes and exit setup.

Standard CMOS Features

CMOS Setup Utility - Copyright (C) 1984-2001 Award Software

Standard CMOS Features

Date (mm:dd:yy)	Mon, Feb 21 2000	Item Help
Time (hh:mm:ss)	22:31:24	Menu Level
IDE Primary Master	[Press Enter None]	
IDE Primary Slave	[Press Enter None]	
IDE Secondary Master	[Press Enter None]	
IDE Secondary Slave	[Press Enter None]	
Drive A	[1.44M, 3.5 "]	
Drive B	[None]	
Floppy 3 Mode Support	[Disabled]	
Halt On	[All, But Key board]	
Base Memory	640K	
Extended Memory	130048K	
Total Memory	131072K	
↓ ↓ ↓ ↓ : Move Enter:Select +/-/PU/PD:Value F10:Save ESC:Exit F1:General Help F5:Previous Values F6:Fail-Safe Defaults F7:Optimized Defaults		

Figure 2: Standard CMOS Features

☞ Date

The date format is <week>, <month>, <day>, <year>.

- ☞ Week The week, from Sun to Sat, determined by the BIOS and is display only
- ☞ Month The month, Jan. Through Dec.
- ☞ Day The day, from 1 to 31 (or the maximum allowed in the month)
- ☞ Year The year, from 1994 through 2079

☞ **Time**

The times format in <hour> <minute> <second>. The time is calculated base on the 24-hour military-time clock. For example, 1 p.m. is 13:00:00.

☞ **IDE Primary Master, Slave / Secondary Master, Slave**

The category identifies the types of hard disk from drive C to F that has been installed in the computer. There are two types: auto type, and manual type. Manual type is user-definable; Auto type which will automatically detect HDD type.

Note that the specifications of your drive must match with the drive table. The hard disk will not work properly if you enter improper information for this category.

If you select User Type, related information will be asked to enter to the following items. Enter the information directly from the keyboard and press <Enter>. Such information should be provided in the documentation form your hard disk vendor or the system manufacturer.

☞ CYLS.	Number of cylinders
☞ HEADS	Number of heads
☞ PRECOMP	Write precomp
☞ LANDZONE	Landing zone
☞ SECTORS	Number of sectors

If a hard disk has not been installed select NONE and press <Enter>.

☞ **Drive A / Drive B**

The category identifies the types of floppy disk drive A or drive B that has been installed in the computer.

☞ None	No floppy drive installed
☞ 360K, 5.25 in.	5.25 inch PC-type standard drive; 360K byte capacity.
☞ 1.2M, 5.25 in.	5.25 inch AT-type high-density drive; 1.2M byte capacity (3.5 inch when 3 Mode is Enabled).
☞ 720K, 3.5 in.	3.5 inch double-sided drive; 720K byte capacity
☞ 1.44M, 3.5 in.	3.5 inch double-sided drive; 1.44M byte capacity.
☞ 2.88M, 3.5 in.	3.5 inch double-sided drive; 2.88M byte capacity.

☞ **Floppy 3 Mode Support (for J apan Area)**

- | | |
|------------|---------------------------------------|
| ☞ Disabled | Normal Floppy Drive. (Default value) |
| ☞ Drive A | Drive A is 3 mode Floppy Drive. |
| ☞ Drive B | Drive B is 3 mode Floppy Drive. |
| ☞ Both | Drive A & B are 3 mode Floppy Drives. |

☞ **Halt on**

The category determines whether the computer will stop if an error is detected during power up.

- | | |
|---------------------|--|
| ☞ NO Errors | The system boot will not stop for any error that may be detected and you will be prompted. |
| ☞ All Errors | Whenever the BIOS detects a non-fatal error the system will be stopped. |
| ☞ All, But Keyboar | The system boot will not stop for a keyboard error; it will stop for all other errors. (Default value) |
| ☞ All, But Diskette | The system boot will not stop for a disk error; it will stop for all other errors. |
| ☞ All, But Disk/Key | The system boot will not stop for a keyboard or disk error; it will stop for all other errors. |

☞☞ **Memory**

The category is display-only which is determined by POST (PowerOn Self Test) of the BIOS.

Base Memory

The POST of the BIOS will determine the amount of base (or conventional) memory installed in the system.

The value of the base memory is typically 512 K for systems with 512 K memory installed on the motherboard, or 640 K for systems with 640 K or more memory installed on the motherboard.

Extended Memory

The BIOS determines how much extended memory is present during the POST.

This is the amount of memory located above 1 MB in the CPU's memory address map.

Advanced BIOS Features

CMOS Setup Utility - Copyright (C) 1984-2001 Award Software

Advanced BIOS Features

BIOS Flash Protection	[Auto]	Item Help
Processor Serial Number	[Disabled]	Menu Level
First Boot Device	[Floppy]	
Second Boot Device	[HDD-0]	
Third Boot Device	[CDROM]	
Boot Up Floppy Seek	[Disabled]	
Boot Up Num-Lock	[On]	
Password Check	[Setup]	
Interrupt Mode	[APIC]	
MPS Version Control For OS	[1.4]	
HDD S.M.A.R.T. Capability	[Disabled]	
↑ ↓ ← → : Move Enter: Select +/-/PU/PD: Value F10: Save ESC: Exit F1: General Help F5: Previous Values F6: Fail-Safe Defaults F7: Optimized Defaults		

Figure 3: Advanced BIOS Features

⚠ These two items will be disabled when use VIA Processor(VIA C3, Cyrix® MII, Cyrix® III) / Intel Pentium® III, Celeron™ Processor(for specific lots).

BIOS Flash Protection

This field lets you determine the states that flash BIOS

- 🔒 Auto BIOS enables flash write access automatically when updating BIOS data/DMI/ESCD. (Default Value)
- 🔓 Enabled During POST, DMI/ESCD would not be updated. But flash tools can update BIOS always.

Processor Serial Number

- 🔓 Enabled Pentium III Processor Number Feature.
- 🔒 Disabled Disable this function.(Default Value)

☞ **First / Second / Third Boot Device**

- ☞ Floppy Select your boot device priority by Floppy.
- ☞ LS120 Select your boot device priority by LS120.
- ☞ HDD-0~3 Select your boot device priority by HDD-0~3.
- ☞ SCSI Select your boot device priority by SCSI.
- ☞ CDROM Select your boot device priority by CDROM.
- ☞ ZIP Select your boot device priority by ZIP.
- ☞ USB-FDD Select your boot device priority by USB-FDD.
- ☞ USB-ZIP Select your boot device priority by USB-ZIP.
- ☞ USB-CDROM Select your boot device priority by USB-CDROM.
- ☞ USB-HDD Select your boot device priority by USB-HDD.
- ☞ LAN Select your boot device priority by LAN.
- ☞ Disabled Select your boot device priority by Disabled.

☞ **Boot Up Floppy Seek**

During POST, BIOS will determine the floppy disk drive installed is 40 or 80 tracks. 360 K type is 40 tracks 720 K, 1.2 M and 1.44 M are all 80 tracks.

- ☞ Enabled BIOS searches for floppy disk drive to determine it is 40 or 80 tracks. Note that BIOS can not tell from 720 K, 1.2 M or 1.44 M drive type as they are all 80tracks.
- ☞ Disabled BIOS will not search for the type of floppy disk drive by track number. Note that there will not be any warning message if the drive installed is 360 K.
(Default value)

☞ **Boot Up NumLock**

- ☞ On Keypad is number keys. (Default value)
- ☞ Off Keypad is arrow keys.

☞ Password Check

Please refer to the detail on P.60

- ☞ System The system can not boot and can not access to Setup page will be denied if the correct password is not entered at the prompt.
- ☞ Setup The system will boot, but access to Setup will be denied if the correct password is not entered at the prompt. (Default value)

☞ Interrupt Mode

- ☞ APIC Through IOAPIC generate more IRQ for system use.(Default value)
- ☞ PIC Use AT standard IRQ controller to generate IRQ.

When you already have IOAPIC enable system and want to upgrade the system please note, since running an IOAPIC enabled OS (like Windows NT, Windows 2000, Windows XP...) system with none IOAPIC HW support will cause the system to hang. Following are some situations users might run into:

1. An IOAPIC enabled OS and change the BIOS setting from IOAPIC to PIC, this will cause your system to hang.
2. An IOAPIC enabled OS and change a processor from IOAPIC supported to none IOAPIC support (like VIA C3, Cyrix® MII, Cyrix® III), and some Intel Pentium® III, Celeron™ Processor (certain lot number), this will disable the IOAPIC in the BIOS and cause the system to hang.

When above situation happened you will have to reinstall the OS.

☞ MPS Version Control For OS

(Support Multi Processor Specification revision 1.4)

- ☞ 1.4 Support MPS Version 1.4 . (Default Value)
- ☞ 1.1 Support MPS Version 1.1.

☞ HDD S.M.A.R.T. Capability

- ☞ Enabled Enable HDD S.M.A.R.T. Capability .
- ☞ Disabled Disable HDD S.M.A.R.T. Capability . (Default value)

Advanced Chipset Features

We would not suggest you change the chipset default setting unless you really need it.

CMOS Setup Utility - Copyright (C) 1984-2001 Award Software

Advanced Chipset Features

Top Performance	[Disabled]	Item Help
SDRAM Timing Control	[Auto]	Menu Level
X SDRAM CAS Latency Time	3	
X SDRAM Cycle Time Tras/Trc	7/9	
X SDRAM RAS-to-CAS Delay	3	
X SDRAM RAS Precharge Time	3	
Delayed Transaction	[Enabled]	
AGP Graphics Aperture Size	[64MB]	
AGP Device 4X Support	[Enabled]	
On-Chip Video windows Size	[64MB]	
Buffer Strength Parameter	[Press Enter]	
↓↓↓↓: Move Enter:Select +/-/PU/PD:Value F10:Save ESC:Exit F1:General Help F5:Previous Values F6:Fail-Safe Defaults F7:Optimized Defaults		

Figure 4: Advanced Chipset Features



Advanced Chipset Features

Buffer Strength Control	Auto	Item Help
X SWE#, SCAS#, SRAS, SMAA, SBS	Default	Menu Level
X SMD[63:0], SDQM[7:0]	Default	
X SMAA#[7:4] (Rows 0/1)	Default	
X SMAB#[7:4] (Rows 2/3)	Default	
X SMAC#[7:4] (Rows 4/5)	Default	
X SCS[0]# (Row 0)	Default	
X SCS[1]# (Row 1)	Default	
X SCS[2]# (Row 2)	Default	
X SCS[3]# (Row 3)	Default	
X SCS[4]# (Row 4)	Default	
X SCS[5]# (Row 5)	Default	
X SCKE[0]# (Row 0)	Default	
X SCKE[1]# (Row 1)	Default	
X SCKE[2]# (Row 2)	Default	
X SCKE[3]# (Row 3)	Default	
X SCKE[4]# (Row 4)	Default	
X SCKE[5]# (Row 5)	Default	
↓↓↓↓ : Move Enter:Select +/-/PU/PD:Value F10:Save ESC:Exit F1:General Help F5:Previous Values F6:Fail-Safe Defaults F7:Optimized Defaults		



Figure 4-1: Advanced Chipset Features

 **Top Performance**

If you wish to maximize the performance of your system, set "Top Performance" as "Enabled".

-  Disabled Disable this function. (Default Value)
-  Enabled Enable Top Performance function.

 **SDRAM Timing Control**

-  Auto Set SDRAM Timing Control to Auto. (Default value)
-  Manual Set SDRAM Timing Control to Manual.

SDRAM CAS Latency Time

- 3 Set SDRAM CAS Latency to 3 SCLKS. (Default Value)
- 2 Set SDRAM CAS Latency to 2 SCLKS.

SDRAM Cycle Time Tras/Trc

- 7/9 Set SDRAM Tras/Trc Cycle time to 7/9 SCLKs. (Default value)
- 5/7 Set SDRAM Tras/Trc Cycle time to 5/7 SCLKs.

SDRAM RAS-to-CAS Delay

- 3 Set SDRAM RAS-to-CAS delay 3 SCLKs. (Default value)
- 2 Set SDRAM RAS-to-CAS delay 2 SCLKs.

SDRAM RAS Precharge Time

- 3 Set SDRAM RAS Precharge Time to 3. (Default value)
- 2 Set SDRAM RAS Precharge Time to 2.

Delayed Transaction

- Disabled Normal operation.
- Enabled For slow speed ISA device in system. (Default value)

AGP Graphics Aperture Size

- 32MB AGP Graphics Aperture Size is 32MB.
- 64MB AGP Graphics Aperture Size is 64MB. (Default Value)

AGP Device 4X Support

- Enabled Enable support AGP Device 4X function. (Default Value)
- Disabled Disable this function.

☞ **Onchip Video Windows Size**

- ☞ Disabled Disabled this function.
- ☞ 64MB Set onchip video size is 64MB. (Default Value)

☞ **Buffer Strength Control**

- ☞ Auto Set SDRAM Buffer Strength to Auto. (Default v alue)
- ☞ Manual Set SDRAM Buffer Strength to Manual.

☞ **SWE#, SCAS#, SRAS#, SMAA, SBS**

- ☞ Default Set SWE#, SCAS#, SRAS#, SMAA, SBS to Default. (Default v alue)
- ☞ 1.7x Set SWE#, SCAS#, SRAS#, SMAA, SBS to 1.7x.
- ☞ 0.7x Set SWE#, SCAS#, SRAS#, SMAA, SBS to 0.7x.
- ☞ 1.0x Set SWE#, SCAS#, SRAS#, SMAA, SBS to 1.0x.





☞ **SMD[63:0], SDQM[7:0]**

- ☞ Default Set SMD[63:0], SDQM[7:0] to Default. (Default v alue)
- ☞ 1.7x Set SMD[63:0], SDQM[7:0] to 1.7x.
- ☞ 0.7x Set SMD[63:0], SDQM[7:0] to 0.7x.
- ☞ 1.0x Set SMD[63:0], SDQM[7:0] to 1.0x.





☞ **SMAA#[7:4] (Rows 0/1)**

- ☞ Default Set SMAA#[7:4] (Row s 0/1) to Default. (Default v alue)
- ☞ 2.7x Set SMAA#[7:4] (Row s 0/1) to 2.7x.
- ☞ 1.7x Set SMAA#[7:4] (Row s 0/1) to 1.7x.
- ☞ 1.0x Set SMAA#[7:4] (Row s 0/1) to 1.0x.



SMAB#[7:4] (Rows 2/3)

-  Default Set SMAB#[7:4] (Rows 2/3) to Default. (Default v alue)
-  2.7x Set SMAB#[7:4] (Rows 2/3) to 2.7x .
-  1.7x Set SMAB#[7:4] (Rows 2/3) to 1.7x .
-  1.0x Set SMAB#[7:4] (Rows 2/3) to 1.0x .



SMAC#[7:4] (Rows 4/5)

-  Default Set SMAC#[7:4] (Rows 4/5) to Default. (Default v alue)
-  2.7x Set SMAC#[7:4] (Rows 4/5) to 2.7x .
-  1.7x Set SMAC#[7:4] (Rows 4/5) to 1.7x .
-  1.0x Set SMAC#[7:4] (Rows 4/5) to 1.0x .



SCS[0]# (Row 0)

-  Default Set SCS[0]# (Row 0) to Default. (Default v alue)
-  1.7x Set SCS[0]# (Row 0) to 1.7x .
-  1.0x Set SCS[0]# (Row 0) to 1.0x .

SCS[1]# (Row 1)

-  Default Set SCS[1]# (Row 1) to Default. (Default v alue)
-  1.7x Set SCS[1]# (Row 1) to 1.7x .
-  1.0x Set SCS[1]# (Row 1) to 1.0x .

SCS[2]# (Row 2)

-  Default Set SCS[2]# (Row 2) to Default. (Default v alue)
-  1.7x Set SCS[2]# (Row 2) to 1.7x .
-  1.0x Set SCS[2]# (Row 2) to 1.0x .

☞ **SCS[3]# (Row 3)**

- ☞ Default Set SCS[3]# (Row 3) to Default. (Default v alue)
- ☞ 1.7x Set SCS[3]# (Row 3) to 1.7x .
- ☞ 1.0x Set SCS[3]# (Row 3) to 1.0x .

☞ **SCS[4]# (Row 4)**

- ☞ Default Set SCS[4]# (Row 4) to Default. (Default v alue)
- ☞ 1.7x Set SCS[4]# (Row 4) to 1.7x .
- ☞ 1.0x Set SCS[4]# (Row 4) to 1.0x .

☞ **SCS[5]# (Row 5)**

- ☞ Default Set SCS[5]# (Row 5) to Default. (Default v alue)
- ☞ 1.7x Set SCS[5]# (Row 5) to 1.7x .
- ☞ 1.0x Set SCS[5]# (Row 5) to 1.0x .

☞ **SCKE[0]# (Row 0)**

- ☞ Default Set SCKE[0]# (Row 0) to Default. (Default v alue)
- ☞ 2.7x Set SCKE[0]# (Row 0) to 2.7x .
- ☞ 1.7x Set SCKE[0]# (Row 0) to 1.7x .



☞ **SCKE[1]# (Row 1)**

- ☞ Default Set SCKE[1]# (Row 1) to Default. (Default v alue)
- ☞ 2.7x Set SCKE[1]# (Row 1) to 2.7x .
- ☞ 1.7x Set SCKE[1]# (Row 1) to 1.7x .



☞ **SCKE[2]# (Row 2)**

- ☞ Default Set SCKE[2]# (Row 2) to Default. (Default v alue)
- ☞ 2.7x Set SCKE[2]# (Row 2) to 2.7x .
- ☞ 1.7x Set SCKE[2]# (Row 2) to 1.7x .



SCKE[3]# (Row 3)

-  Default Set SCKE[3]# (Row 3) to Default. (Default v alue)
-  2.7x Set SCKE[3]# (Row 3) to 2.7x .
-  1.7x Set SCKE[3]# (Row 3) to 1.7x .

SCKE[4]# (Row 4)

-  Default Set SCKE[4]# (Row 4) to Default. (Default v alue)
-  2.7x Set SCKE[4]# (Row 4) to 2.7x .
-  1.7x Set SCKE[4]# (Row 4) to 1.7x .

SCKE[5]# (Row 5)

-  Default Set SCKE[5]# (Row 5) to Default. (Default v alue)
-  2.7x Set SCKE[5]# (Row 5) to 2.7x .
-  1.7x Set SCKE[5]# (Row 5) to 1.7x .

Integrated Peripherals

CMOS Setup Utility - Copyright (C) 1984-2001 Award Software

Integrated Peripherals

On-Chip Primary PCI IDE	[Enabled]	Item Help
On-Chip Secondary PCI IDE	[Enabled]	Menu Level
IDE Primary Master PIO	[Auto]	
IDE Primary Slave PIO	[Auto]	
IDE Secondary Master PIO	[Auto]	
IDE Secondary Slave PIO	[Auto]	
IDE Primary Master UDMA	[Auto]	
IDE Primary Slave UDMA	[Auto]	
IDE Secondary Master UDMA	[Auto]	
IDE Secondary Slave UDMA	[Auto]	
IDE1 Conductor Cable	[Auto]	
IDE2 Conductor Cable	[Auto]	
USB Controller	[Enabled]	
USB Keyboard Support	[Disabled]	
USB Mouse Support	[Disabled]	
Init Display First	[PC]	
AC97 Audio	[Auto]	
AC97 Modem	[Auto]	
Power On By Mouse	[Disabled]	
Power On By Keyboard	[Disabled]	
X KB Power ON Password	Enter	
Onboard FDC Controller	[Enabled]	
Onboard Serial Port 1	[3F8/IRQ4]	
Onboard Serial Port 2	[2F8/IRQ3]	
UART Mode Select	[Normal]	
↑ ↓ ← → : Move Enter:Select +/-/PU/PD:Value F10:Save ESC:Exit F1:General Help F5:Previous Values F6:Fail-Safe Defaults F7:Optimized Defaults		

Figure 5: Integrated Peripherals

CMOS Setup Utility - Copyright (C) 1984-2001 Award Software
 Integrated Peripherals

⌘UR2 Duplex Mode	Half	Item Help
Onboard Parallel Port	[378/IRQ7]	Menu Level
Parallel Port Mode	[SPP]	
X ECP Mode Use DMA	3	
AC BACK Function	[Soft-Off]	
Game Port Address	[201]	
Midi Port Address	[330]	
Midi Port IRQ	[10]	
CIR Port Address	[Disabled]	
⌘CIR Port IRQ	11	
↑ ↓ ← → : Move Enter:Select +/-/PU/PD:Value F10:Save ESC:Exit F1:General Help F5:Previous Values F6:Fail-Safe Defaults F7:Optimized Defaults		

Figure 5-1: Integrated Peripherals

⌘ This item will be available when "UART Mode Select" is set to IrDA or ASKIR.

⌘ This item will be available when "CIR Port Address" is set to 310 or 320.

☞ **On-Chip Primary PCI IDE**

- ☞ Enabled Enable onboard 1st channel IDE port. (Default value)
- ☞ Disabled Disable onboard 1st channel IDE port.

☞ **On-Chip Secondary PCI IDE**

- ☞ Enabled Enable onboard 2nd channel IDE port. (Default value)
- ☞ Disabled Disable onboard 2nd channel IDE port.

☞ **IDE Primary Master PIO (for onboard IDE 1st channel)**

- ☞ Auto BIOS will automatically detect the IDE HDD Accessing mode. (Default value)
- ☞ Mode0~4 Manually set the IDE Accessing mode.

☞ **IDE Primary Slave PIO (for onboard IDE 1st channel)**

- ☞ Auto BIOS will automatically detect the IDE HDD Accessing mode.(Default v alue)
- ☞ Mode0~4 Manually set the IDE Accessing mode.

☞ **IDE Secondary Master PIO (for onboard IDE 2nd channel)**

- ☞ Auto BIOS will automatically detect the IDE HDD Accessing mode.(Default v alue)
- ☞ Mode0~4 Manually set the IDE Accessing mode.

☞ **IDE Secondary Slave PIO (for onboard IDE 2nd channel)**

- ☞ Auto BIOS will automatically detect the IDE HDD Accessing mode.(Default v alue)
- ☞ Mode0~4 Manually set the IDE Accessing mode.

☞ **IDE Primary Master UDMA**

- ☞ Auto BIOS will automatically detect the IDE HDD Accessing mode.(Default v alue)
- ☞ Disabled Disable UDMA function.

☞ **IDE Primary Slave UDMA**

- ☞ Auto BIOS will automatically detect the IDE HDD Accessing mode.(Default v alue)
- ☞ Disabled Disable UDMA function.

☞ **IDE Secondary Master UDMA**

- ☞ Auto BIOS will automatically detect the IDE HDD Accessing mode.(Default v alue)
- ☞ Disabled Disable UDMA function.

☞ **IDE Secondary Slave UDMA**

- ☞ Auto BIOS will automatically detect the IDE HDD Accessing mode.(Default v alue)
- ☞ Disabled Disable UDMA function.

IDE1 Conductor Cable

- Auto Will be automatically detected by BIOS. (Default Value)
- ATA66/100 Set IDE1 Conductor Cable to ATA66/100 (Please make sure your IDE device and cable is compatible with ATA66/100).
- ATA33 Set IDE1 Conductor Cable to ATA33 (Please make sure your IDE device and cable is compatible with ATA33).

IDE2 Conductor Cable

- Auto Will be automatically detected by BIOS. (Default Value)
- ATA66/100 Set IDE2 Conductor Cable to ATA66/100 (Please make sure your IDE device and cable is compatible with ATA66/100).
- ATA33 Set IDE2 Conductor Cable to ATA33 (Please make sure your IDE device and cable is compatible with ATA33).

USB Controller

- Enabled Enable USB Controller. (Default value)
- Disabled Disable USB Controller.

USB Keyboard Support

- Enabled Enable USB Key board Support.
- Disabled Disable USB Key board Support. (Default value)

USB Mouse Support

- Enabled Enable USB Mouse Support.
- Disabled Disable USB Mouse Support. (Default value)

Init Display First

- PCI Set Init Display First to PCI. (Default value)
- Onboard/AGP Set Init Display First to Onboard / AGP.

☞ **AC97 Audio**

- ☞ Auto Enable onboard AC'97 audio function. (Default Value)
- ☞ Disabled Disable this function.

☞ **AC97 Modem**

- ☞ Auto BIOS will search MC97 Codec (AMR Modem Card). If found, MC97 function will be enabled. If no MC97 Codec found, MC97 function will be disabled. (Default Value)
- ☞ Disabled Disable this function.

☞ **Power On By Mouse**

- ☞ Mouse Click Double click on PS/2 mouse left button.
- ☞ Disabled Disable this function. (Default value)

☞ **Power On By Keyboard**

- ☞ Password Enter from 1 to 5 characters to set the Key board Power On Password.
- ☞ Disabled Disable this function. (Default value)
- ☞ Key board 98 If your key board have "POWER Key" button, you can press the key to power on your system.

☞ **KB Power ON Password**

- ☞ Enter Input password (from 1 to 5 characters) and press Enter to set the Key board Power On Password.

☞ **Onboard FDC Controller**

- ☞ Enabled Enable onboard FDC port. (Default value)
- ☞ Disabled Disable onboard FDC port.

☞ Onboard Serial Port 1

- ☞ Auto BIOS will automatically setup the port 1 address.
- ☞ 3F8/IRQ4 Enable onboard Serial port 1 and address is 3F8. (Default value)
- ☞ 2F8/IRQ3 Enable onboard Serial port 1 and address is 2F8.
- ☞ 3E8/IRQ4 Enable onboard Serial port 1 and address is 3E8.
- ☞ 2E8/IRQ3 Enable onboard Serial port 1 and address is 2E8.
- ☞ Disabled Disable onboard Serial port 1.

☞ Onboard Serial Port 2

- ☞ Auto BIOS will automatically setup the port 2 address.
- ☞ 3F8/IRQ4 Enable onboard Serial port 2 and address is 3F8. (Default value)
- ☞ 2F8/IRQ3 Enable onboard Serial port 2 and address is 2F8.
- ☞ 3E8/IRQ4 Enable onboard Serial port 2 and address is 3E8.
- ☞ 2E8/IRQ3 Enable onboard Serial port 2 and address is 2E8.
- ☞ Disabled Disable onboard Serial port 2.

☞ UART Mode Select

(This item allows you to determine which Infra Red(IR) function of Onboard I/O chip)

- ☞ ASKIR Set onboard I/O chip UART to ASKIR Mode.
- ☞ IrDA Set onboard I/O chip UART to IrDA Mode.
- ☞ SCR Set onboard I/O chip UART to SCR Mode.
- ☞ Normal Set onboard I/O chip UART to Normal Mode. (Default Value)

☞ UR2 Duplex Mode

- ☞ Half IR Function Duplex Half. (Default Value)
- ☞ Full IR Function Duplex Full.

☞ **Onboard Parallel port**

- ☞ 378/IRQ7 Enable onboard LPT port and address is 378/IRQ7. (Default Value)
- ☞ 278/IRQ5 Enable onboard LPT port and address is 278/IRQ5.
- ☞ Disabled Disable onboard LPT port.
- ☞ 3BC/IRQ7 Enable onboard LPT port and address is 3BC/IRQ7.

☞ **Parallel Port Mode**

- ☞ SPP Using Parallel port as Standard Parallel Port. (Default Value)
- ☞ EPP Using Parallel port as Enhanced Parallel Port.
- ☞ ECP Using Parallel port as Extended Capabilities Port.
- ☞ ECP+EPP Using Parallel port as ECP & EPP mode.

☞ **ECP Mode Use DMA**

- ☞ 3 Set ECP Mode Use DMA to 3. (Default Value)
- ☞ 1 Set ECP Mode Use DMA to 1.

☞ **AC Back Function**

- ☞ Memory System power on depends on the status before AC lost.
- ☞ Soft-Off Always in Off state when AC back. (Default value)
- ☞ Full-On Always power on the system when AC back.

☞ **Game Port Address**

- ☞ Disabled Disabled this function.
- ☞ 201 Set Game Port Address to 201. (Default Value)
- ☞ 209 Set Game Port Address to 209.

☞ **Midi Port Address**

- ☞ Disabled Disabled this function.
- ☞ 290 Set Midi Port Address to 290.
- ☞ 300 Set Midi Port Address to 300.
- ☞ 330 Set Midi Port Address to 300.(Default Value)

☞ **Midi Port IRQ**

- ☞ 5 Set 5 for Midi Port IRQ.
- ☞ 10 Set 11 for Midi Port IRQ. (Default Value)

☞ **CIR Port Address**

- ☞ Disabled Disable this function. (Default Value)
- ☞ 310 Set CIR Port Address to 310.
- ☞ 320 Set CIR Port Address to 320.

☞ **CIR Port IRQ**

- ☞ 5 Set 5 for CIR Port IRQ.
- ☞ 11 Set 11 for CIR Port IRQ. (Default Value)

Power Management Setup

CMOS Setup Utility - Copyright (C) 1984-2001 Award Software

Power Management Setup

ACPI Suspend Type	[S1(POS)]	
USB Device Wake-Up From S3	[Disabled]	
X Power Management	[User Define]	Menu Level
Video Off Method	[DPMS]	
Video Off In Suspend	[Yes]	
Suspend Type	[Stop Grant]	
MODEM Use IRQ	[NA]	
Suspend Mode	[Disabled]	
HDD Power Down	[Disabled]	
Soft-Off by PWR-BTTN	[Instant-off]	
PME Event Wake Up	[Enabled]	
ModemRingOn/WakeOnLan	[Enabled]	
Resume by Alarm	[Disabled]	
X Date(of Month) Alarm	Every day	
X Time(hh:mm:ss) Alarm	0 0 0	
** Reload Global Timer Events **		
Primary IDE 0	[Disabled]	
Primary IDE 1	[Disabled]	
Secondary IDE 0	[Disabled]	
Secondary IDE 1	[Disabled]	
FDD,COM,LPT Port	[Disabled]	
PCI PIRQ[A-D]#	[Disabled]	
↑ ↓ ← → : Move Enter:Select +/-/PU/PD:Value F10:Save ESC:Exit F1:General Help F5:Previous Values F6:Fail-Safe Defaults F7:Optimized Defaults		

Figure 6: Power Management Setup

ACPI Suspend Type

- S1(POS) Set ACPI Suspend Type to S1/POS (Power On Suspend). (Default value)
- S3(STR) Set ACPI Suspend Type to S3/STR (Suspend To RAM).

USB Device Wake-Up From S3

- Enabled Enable USB Device Wakeup From S3.
- Disabled Disable USB Device Wakeup From S3. (Default value)

Power Management

- User Define For configuring our own power management features (Default Value)
- Min Saving Disable Green & software APM function.
- Max Saving Enable Green & software APM function.

Video off Method

- V/H SYNC+Blank BIOS will turn off V/H-SYNC when gets into Green mode for Green monitor power saving.
- Blank Screen BIOS will only black monitor when gets into Green mode.
- DPMS BIOS will use DPMS Standard to control VGA card. (The Green type VGA card will turn off V/H-SYNC automatically.)(Default value)

Video Off In Suspend

- Yes Enable Video Off In Suspend function. (Default value)
- No Disable this function.

Suspend Type

- Stop Grant Set Suspend Type to stop grant. (Default value)
- PwrOn Suspend Set Suspend Type to Power on Suspend.

☞ **MODEM Use IRQ**

- ☞ N/A Set MODEM Use IRQ to NA. (Default value)
- ☞ 3 Set MODEM Use IRQ to 3.
- ☞ 4 Set MODEM Use IRQ to 4.
- ☞ 5 Set MODEM Use IRQ to 5.
- ☞ 7 Set MODEM Use IRQ to 7.
- ☞ 9 Set MODEM Use IRQ to 9.
- ☞ 10 Set MODEM Use IRQ to 10.
- ☞ 11 Set MODEM Use IRQ to 11.

☞ **Suspend Mode**

- ☞ Disabled Disable Suspend Mode. (Default value)
- ☞ 1 min - 1 Hour Setup the timer to enter Suspend Mode.

☞ **HDD Power Down**

- ☞ Disabled Disable HDD Power Down mode function. (Default value)
- ☞ 1-15 mins. Enable HDD Power Down mode between 1 to 15 mins.

☞ **Soft-off by PWR-BTTN**

- ☞ Instant-off Press power button then Power off instantly. (Default value)
- ☞ Delay 4 Sec. Press power button 4 sec to Power off. Enter suspend if button is pressed less than 4 sec.

☞ **PME Event Wake UP**

- ☞ Disabled Disable this function.
- ☞ Enabled Enable PME Event Wake up. (Default Value)

☞ **Modem Ring On/Wake On LAN**

- ☞ Disabled Disable Modem Ring on/wake on Lan function.
- ☞ Enabled Enable Modem Ring on/wake on Lan. (Default Value)

☞ **Resume by Alarm**

You can set "Resume by Alarm" item to enabled and key in Date/time to power on system.

- ☞ Disabled Disable this function. (Default Value)
- ☞ Enabled Enable alarm function to POWER ON system.

If RTC Alarm Lead To Power On is Enabled.

Date (of Month) Alarm : Ev ery day , 1~31
Time (hh: mm: ss) Alarm : (0~23) : (0~59) : (0~59)

☞ **Primary IDE 0/1**

- ☞ Disabled Disable this function. (Default value)
- ☞ Enabled Enable monitor Primary IDE 0/1 for Green event.

☞ **Secondary IDE 0/1**

- ☞ Disabled Disable this function. (Default value)
- ☞ Enabled Enable monitor Secondary IDE 0/1 for Green event.

☞ **FDD,COM,LPT Port**

- ☞ Disabled Disable this function. (Default value)
- ☞ Enabled Enable monitor FDC,COM,LPT for Green event.

☞ **PCI PIRQ[A-D] #**

- ☞ Enabled Monitor PCI PIRQ[A-D]# IRQ Active.
- ☞ Disabled Ignore PCI PIRQ[A-D]# IRQ Active. (Default value)

PnP/PCI Configurations

CMOS Setup Utility - Copyright (C) 1984-2001 Award Software

PnP/PCI Configurations

Resources Controlled By	[Auto]	Item Help
X=> IRQ Resources	Press Enter	Menu Level
PCI1 IRQ Assignment	[Auto]	
PCI2 IRQ Assignment	[Auto]	
PCI3 IRQ Assignment	[Auto]	
↓↓↓↓ : Move Enter:Select +/-/PU/PD:Value F10:Save ESC:Exit F1:General Help F5:Previous Values F6:Fail-Safe Defaults F7:Optimized Defaults		

Figure 7: PnP/PCI Configurations

☞ Resources Controlled by

- ☞ Manual User can set the PnP resource (I/O Address, IRQ & DMA channels) used by legacy ISA DEVICE.
- ☞ Auto BIOS automatically use these PnP resources. (Default value)

☞ IRQ Resources (3,4,5,7,9,10,11,12,14,15)

- ☞ PCI Device The resource is used by PCI device.
- ☞ Reserved Set the resource to reserved.

PCI1 IRQ Assignment

- Auto Auto assign IRQ to PCI1. (Default value)
- 3,4,5,7,9.,10,11,12,14,15 Set IRQ 3,4,5,7,9,10,11,12,14,15 to PCI1.

PCI2 IRQ Assignment

- Auto Auto assign IRQ to PCI2. (Default value)
- 3,4,5,7,9.,10,11,12,14,15 Set IRQ 3,4,5,7,9,10,11,12,14,15 to PCI2.

PCI3 IRQ Assignment

- Auto Auto assign IRQ to PCI3. (Default value)
- 3,4,5,7,9.,10,11,12,14,15 Set IRQ 3,4,5,7,9,10,11,12,14,15 to PCI3.

PC Health Status

CMOS Setup Utility - Copyright (C) 1984-2001 Award Software

PC Health Status		
Reset Case Open Status	[Disabled]	
Case Opened	No	
VCORE	1.712V	Item Help
VTT	1.552V	Menu Level
+3.3V	3.344V	
+5V	5.053V	
+12V	12.03V	
Current CPU Temperature	36°C	
Current CPU FAN Speed	6490 RPM	
Current POWER FAN Speed	0RPM	
Current SYSTEM FAN speed	0 RPM	
CPU Warning Temperature	[Disabled]	
CPU FAN Fail Warning	[Disabled]	
POWER FAN Fail Warning	[Disabled]	
SYSTEM FAN Fail Warning	[Disabled]	
↑ ↓ ← → : Move Enter:Select +/-/PU/PD:Value F10:Save ESC:Exit F1:General Help F5:Previous Values F6:Fail-Safe Defaults F7:Optimized Defaults		

Figure8: PC Health Status

☞ Reset Case Open Status

☞ Case Opened

If the case is closed, "Case Opened" will show "No".

If the case have been opened, "Case Opened" will show "Yes".

If you want to reset "Case Opened" value, set "Reset Case Open Status" to "Enabled" and save CMOS, your computer will restart.

☞ Current Voltage (V) VCORE / VTT / +3.3V / +5V / +12V

☛ Detect system's voltage status automatically.

☞ Current CPU Temperature

 Detect CPU Temp. automatically.

☞ Current CPU / POWER / SYSTEM FAN Speed (RPM)

 Detect Fan speed status automatically.

☞ CPU Warning Temperature

 60°C / 140°F Monitor CPU Temp. at 60°C / 140°F.

 70°C / 158°F Monitor CPU Temp. at 70°C / 158°F.

 80°C / 176°F Monitor CPU Temp. at 80°C / 176°F.

 90°C / 194°F Monitor CPU Temp. at 90°C / 194°F.

 Disabled Disable this function. (Default value)

☞ Fan Fail Warning (CPU / POWER / SYSTEM)

 Disabled Fan Warning Function Disable. (Default value)

 Enabled Fan Warning Function Enable.

Frequency/Voltage Control

CMOS Setup Utility - Copyright (C) 1984-2001 Award Software
 Frequency/Voltage Control

CPU Host Clock Control	[Disabled]	Item Help
X CPU Host Frequency (Mhz)	133	Menu Level
PCI/AGP Frequency (Mhz)	[33/66]	
Host DRAM Colck Ratio	[Auto]	
Memory Frequency (Mhz)	133	
↑↓↑↓: Move Enter:Select +/-/PU/PD:Value F10:Save ESC:Exit F1:General Help F5:Previous Values F6:Fail-Safe Defaults F7:Optimized Defaults		

Figure 9: Frequency/Voltage Control

☞ CPU Host Clock Control

Note: If system hangs up before enter CMOS setup utility, wait for 10 sec for times out reboot. When time out occur, system will reset and run at CPU default Host clock at next boot.

- ☛ Disabled Disable this function. (Default value)
- ☛ Enabled Enable this function.

☞ CPU Host Frequency (Mhz)

- ☛ 66~200 Select CPU Host Frequency (Mhz) to 66Mhz~200Mhz.

☞ PCI/AGP Frequency (Mhz)

- ☛ The values depend on CPU Host Frequency (Mhz).

☞ **Host/DRAM Clock Ratio**

- ☛ 1.0 Memory Frequency = Host clock X 1.0.
- ☛ 0.75 Memory Frequency = Host clock X 0.75.
- ☛ Auto Depend's On SPD Data. (Default value)

☞ **Memory Frequency(Mhz)**

- ☛ The values depend on CPU Host Frequency (Mhz) .

Load Fail-Safe Defaults

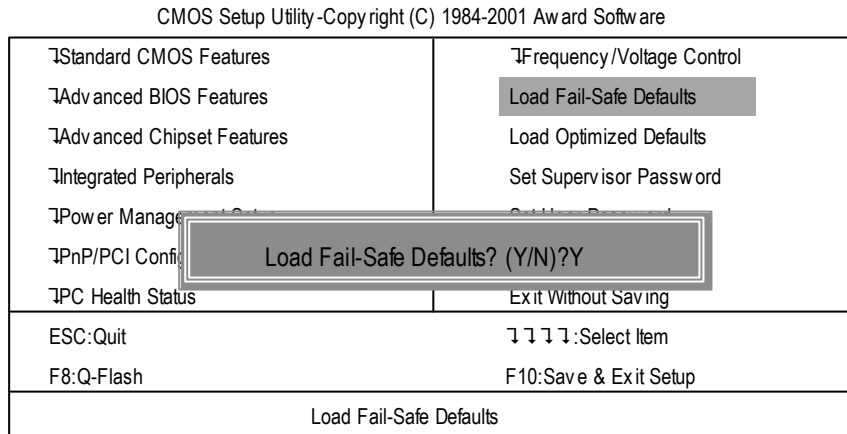

Figure 10: Load Fail-Safe Defaults

Load Fail-Safe Defaults

Fail-Safe defaults contain the most appropriate values of the system parameters that allow minimum system performance.

Load Optimized Defaults

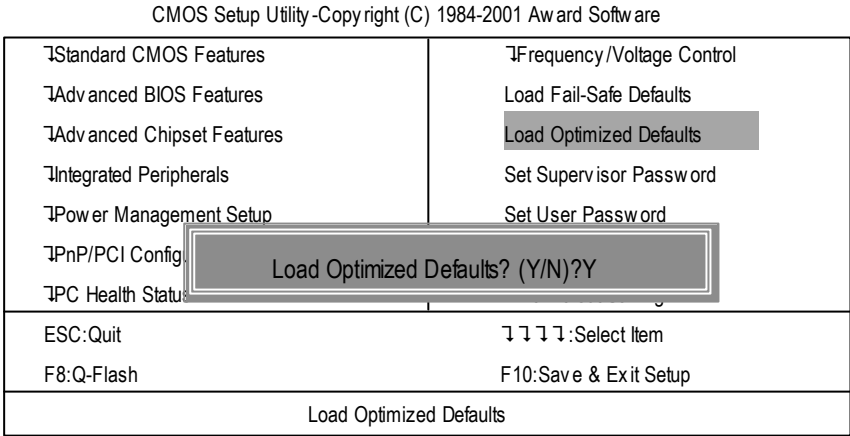

Figure 11: Load Optimized Defaults

Load Optimized Defaults

Selecting this field loads the factory defaults for BIOS and Chipset Features which the system automatically detects.

Set Supervisor/User Password

CMOS Setup Utility-Copyright (C) 1984-2001 Award Software

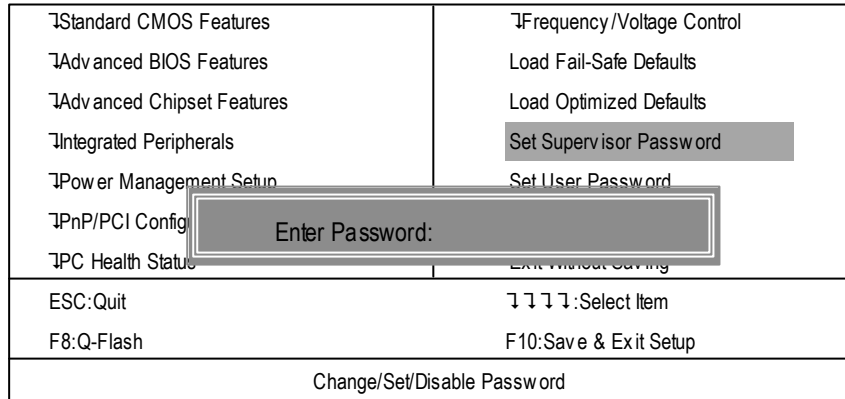

Figure 12: Password Setting

When you select this function, the following message will appear at the center of the screen to assist you in creating a password.

Type the password, up to eight characters, and press <Enter>. You will be asked to confirm the password. Type the password again and press <Enter>. You may also press <Esc> to abort the selection and not enter a password.

To disable password, just press <Enter> when you are prompted to enter password. A message "PASSWORD DISABLED" will appear to confirm the password being disabled. Once the password is disabled, the system will boot and you can enter Setup freely.

The BIOS Setup program allows you to specify two separate passwords:

SUPERVISOR PASSWORD and a USER PASSWORD. When disabled, anyone may access all BIOS Setup program function. When enabled, the Supervisor password is required for entering the BIOS Setup program and having full configuration fields, the User password is required to access only basic items.

If you select "System" at "Password Check" in Advance BIOS Features Menu, you will be prompted for the password every time the system is rebooted or any time you try to enter Setup Menu.

If you select "Setup" at "Password Check" in Advance BIOS Features Menu, you will be prompted only when you try to enter Setup.

Save & Exit Setup

CMOS Setup Utility-Copyright (C) 1984-2001 Award Software

Standard CMOS Features	Frequency/Voltage Control
Advanced BIOS Features	Load Fail-Safe Defaults
Advanced Chipset Features	Load Optimized Defaults
Integrated Peripherals	Set Supervisor Password
Power Management Setup	Set User Password
PnP/PCI Configurations	Save to CMOS and EXIT (Y/N)? Y
PC Health Status	Exit without Saving
ESC:Quit	↑↓←→:Select Item
F8:Q-Flash	F10:Save & Exit Setup
Save Data to CMOS	

Figure 13: Save & Exit Setup

Type "Y" will quit the Setup Utility and save the user setup value to RTC CMOS.
Type "N" will return to Setup Utility.

Exit Without Saving

CMOS Setup Utility-Copyright (C) 1984-2001 Award Software

Standard CMOS Features	Frequency/Voltage Control
Advanced BIOS Features	Load Fail-Safe Defaults
Advanced Chipset Features	Load Optimized Defaults
Integrated Peripherals	Set Supervisor Password
Power Management Setup	Set User Password
PnP/PCI Configurations	Quit Without Saving (Y/N)? N
PC Health Status	Exit Without Saving
ESC:Quit	↑↓←→:Select Item
F8:Q-Flash	F10:Save & Exit Setup
Abandon all Data	

Figure 14: Exit Without Saving

Type "Y" will quit the Setup Utility without saving to RTC CMOS.

Type "N" will return to Setup Utility.

Chapter 4 Technical Reference

Performance List

The following performance data list is the testing results of some popular benchmark testing programs. These data are just referred by users, and there is no responsibility for different testing data values gotten by users. (The different Hardware & Software configuration will result in different benchmark testing results.)

CPU	Intel Socket370 Pentium® III 1.13G / Intel Socket370 Celeron 1.1G processor
DRAM	(128x2)MB RAM (PQI PC-166 MP6828UMR-T6863)
CACHE SIZE	256 KB included in CPU(Intel Pentium® III) 128 KB included in CPU(Intel Celeron)
DISPLAY	GF3000D/Onboard i815
STORAGE	Onboard IDE (Quantum AS30000AT 30GB)
O.S	Window s 2000+ SP2+DirectX 8.0a
DRIVER	Display Driver at 1024 x 768 x 64K colors x 75Hz. IUCD ver. 1.81 For Intel chipset M.B.

Processor	Intel Pentium® III Socket 370 1.13GHz (133x8.5)	Intel Celeron Socket 370 1.1GHz (100x11)		
WCPUID 3.0C Clock Frequency	AGP	Onboard AGP		
	Internal MHz	1137.89	1137.93	1104.38
	External MHz	133.87	133.87	100.40
SiSoft Sandra 2001	CPU/FPU Benchmark	3053/1537	3088/1538	2930/1485
	CPU Multi-Media Benchmark	6200/7594	6205/7599	6012/7363
	Drives Benchmark	22906	22931	20748
	Memory Benchmark	337/375	285/304	212/223

GA-6IEM Series Motherboard

Processor	Intel Pentium® III Socket 370 1.13GHz (133x8.5)		Intel Celeron Socket 370 1.1GHz (100x 11)
SPECviewperf 6.12			
Pro CDRS-03	14.75	-	4.363
MedMCAD-01	19.15	-	5.338
Light-04	4.909	-	2.077
DX-06	13.67	-	4.025
DRV-07	12.00	-	3.149
Awadv s-04	47.47	-	5.78
Winstone 2001			
CC Winstone 2001	56.7	54.2	43.6
Business Winstone 2001	41.8	40.1	32
3D Mark 20001 1.0D			
Memory Benchmark	5008	579	457

If you wish to maximize the performance of your system, please refer to the detail on P.33

Block Diagram

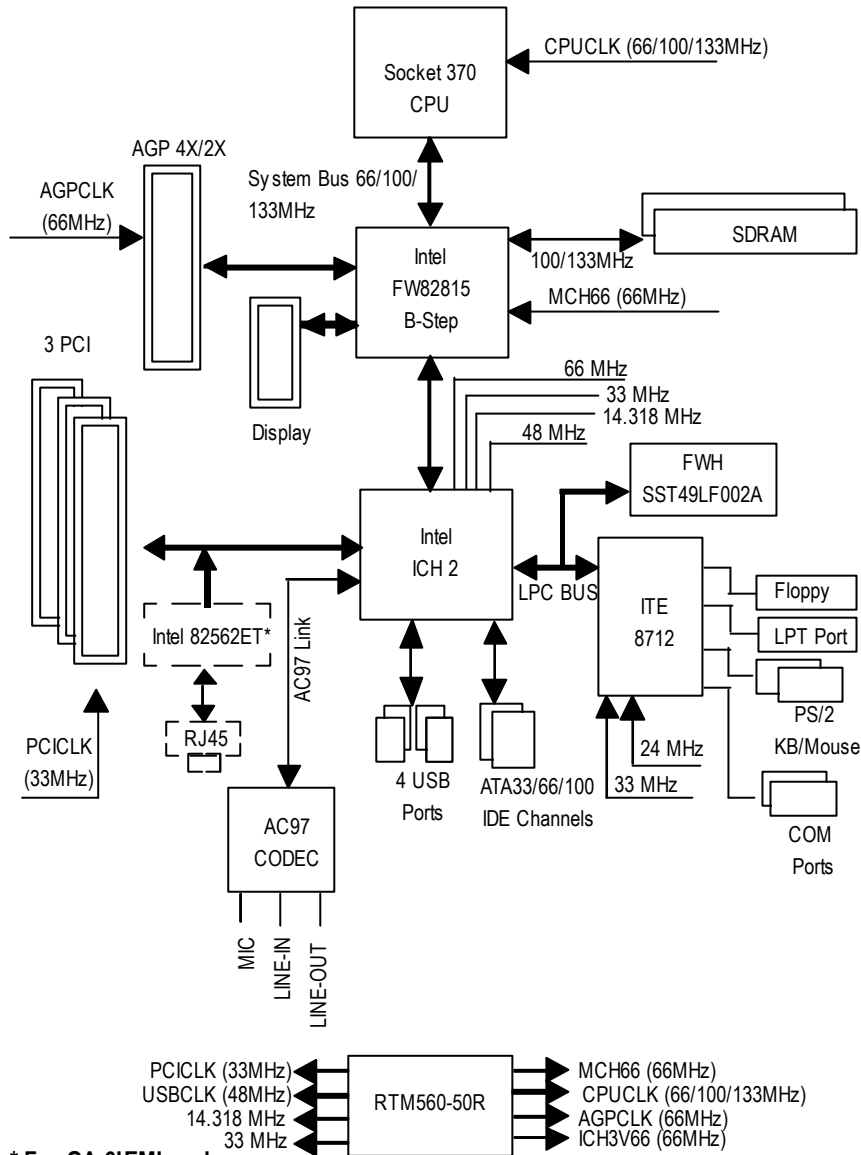

@ BIOS Introduction

Gigabyte announces @ BIOS Windows BIOS live update utility



Have you ever updated BIOS by yourself? Or like many other people, you just know what BIOS is, but always hesitate to update it? Because you think updating newest BIOS is unnecessary and actually you don't know how to update it.

Maybe not like others, you are very experienced in BIOS updating and spend quite a lot of time to do it. But of course you don't like to do it too much. First, download different BIOS from website and then switch the operating system to DOS mode. Secondly, use different flash utility to update BIOS. The above process is not a interesting job. Besides, always be carefully to store the BIOS source code correctly in your disks as if you update the wrong BIOS, it will be a nightmare.

Certainly, you wonder why motherboard vendors could not just do something right to save your time and effort and save you from the lousy BIOS updating work? Here it comes! Now Gigabyte announces @BIOS—the first Windows BIOS live update utility. This is a smart BIOS update software. It could help you to download the BIOS from internet and update it. Not like the other BIOS update software, it's a Windows utility. With the help of "@BIOS", BIOS updating is no more than a click.

Besides, no matter which mainboard you are using, if it's a Gigabyte's product*, @BIOS help you to maintain the BIOS. This utility could detect your correct mainboard model and help you to choose the BIOS accordingly. It then downloads the BIOS from the nearest Gigabyte ftp site automatically. There are several different choices; you could use "Internet Update" to download and update your BIOS directly. Or you may want to keep a backup for your current BIOS, just choose "Save Current BIOS" to save it first. You make a wise choice to use Gigabyte, and @BIOS update your BIOS smartly. You are now worry free from updating wrong BIOS, and capable to maintain and manage your BIOS easily. Again, Gigabyte's innovative product erects a milestone in mainboard industries.

For such a wonderful software, how much it costs? Impossible! It's free! Now, if you buy a Gigabyte's motherboard, you could find this amazing software in the attached driver CD. But please remember, connected to internet at first, then you could have a internet BIOS update from your Gigabyte @BIOS.

Easy TuneIII™ Introduction

Gigabyte announces *EasyTuneIII* Windows overdrive utility



“Overdrive” might be one of the most common issues in computer field. But have many users ever tried it? The answer is probably “no”. Because “overdrive” is thought to be very difficult and includes a lot of technical know-how, sometimes “overdrive” is even considered as special skills found only in some enthusiasts.

But as to the experts in “overdrive”, what’s the truth? They may spend quite a lot of time and money to study, try and use many different hardware and software tools to do “overdrive”. And even with these technologies, they still learn that it’s quite a risk because the safety and stability of an “overdrive” system is unknown.

Now everything is different because of a Windows overdrive utility Easy TuneIII—announced by Gigabyte. This utility has totally changed the gaming rule of “overdrive”. This is the first overdrive utility suitable for both normal and power users. Users can choose either “Easy Mode” or “Advanced Mode” to run “overdrive” at their convenience. For users who choose “Easy Mode”, they just need to click “Auto Optimize” to have auto and immediate CPU overclocking. This software will then overdrive CPU speed automatically with the result being shown in the control panel. If someone prefers to “overdrive” by oneself, there is also another choice. Click “Advanced Mode” to enjoy “sport drive” class overclocking. In “Advanced Mode”, one can change the system bus speed in small increments to get ultimate system performance. And no matter which motherboard is used, if it’s a Gigabyte’s product, Easy TuneIII helps to perform the best of system.

Besides, different from other traditional over-clocking methods, Easy TuneIII doesn’t require users to change neither BIOS nor hardware switch/ jumper setting; on the other hand, they can do “overdrive” at only one click. Therefore, this is a safer way for “overdrive” as nothing is changed on software or hardware. If user runs Easy TuneIII over system’s limitation, the biggest lost is only to restart the computer again and the side effect is then well controlled. Moreover, if one well-performed system speed been tested in Easy TuneIII, user can “Save” this bus speed and “Load” it in next time. Obviously, Gigabyte Easy TuneIII has already turned the “overdrive” technology toward to a newer generation.

This wonderful software is now free bundled in Gigabyte motherboard attached driver CD. Users may make a test drive of “Easy TuneIII” to find out more amazing features by themselves.

Chapter 5 Appendix

Picture below are shown in Windows ME (IUCD driver version 1.9)

Appendix A: Intel 815EP/820 Chipsets Driver Installation

A.Intel Ultra ATA Storage Driver (WHQL):

Insert the driver CD-title that came with your motherboard into your CD-ROM driver, the driver CD-title will auto start and show the installation guide. If not, please double click the CD-ROM device icon in "My computer", and execute the setup.exe.



(1)

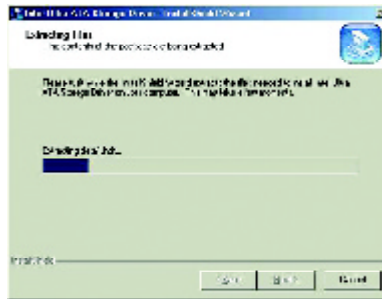

(2)

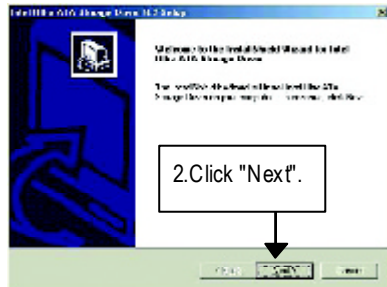

(3)



(4)

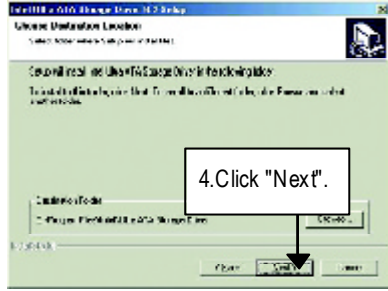

(5)

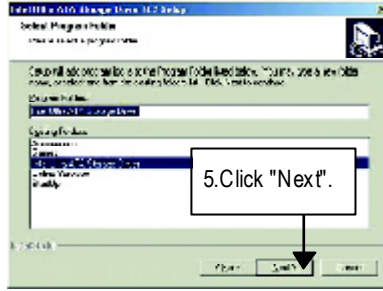

(6)

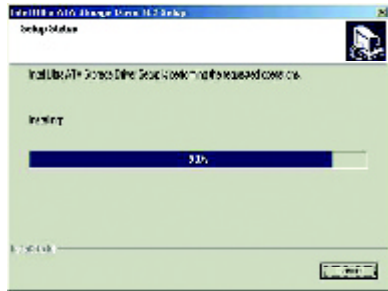

(7)



(8)

B.Intel Ultra ATA Storage Driver (WHQL):



(1)

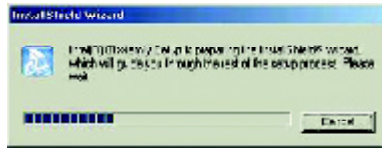

(2)



(3)

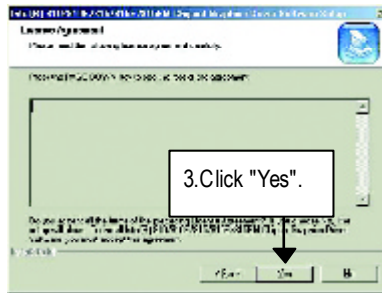

(4)

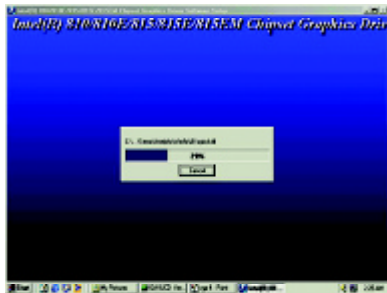

(5)



(6)

Appendix B: RealTek AC'97 Audio Driver

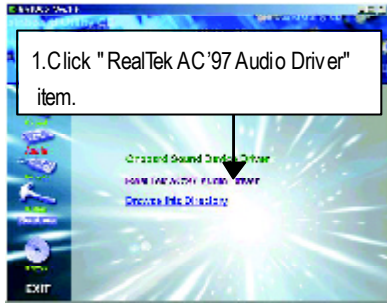

(1)

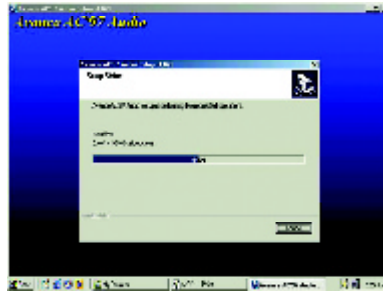

(2)

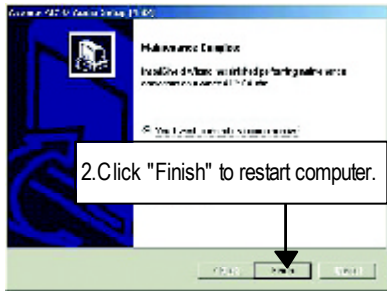

(3)

Appendix C: Intel 82562 Network Driver* (6IEM skip the step)

"Intel 82562 Network Driver" under Windows ME will auto install. If you would like to install LAN driver, please refer to attached README.txt file for detail instruction. Please install the driver through CD-ROM by the path D:\Network\RTI (This manual assumes that your CD-ROM device drive letter is D:).

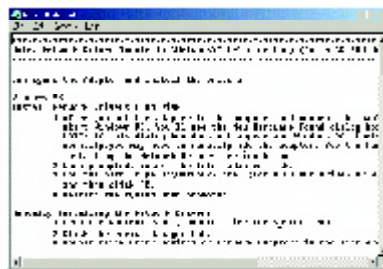

Appendix D: EasyTuneIII Utilities Installation

Insert the driver CD-title that came with your motherboard into your CD-ROM driver, the driver CD-title will auto start and show the installation guide. If not, please double click the CD-ROM device icon in "My computer", and execute the setup.exe.

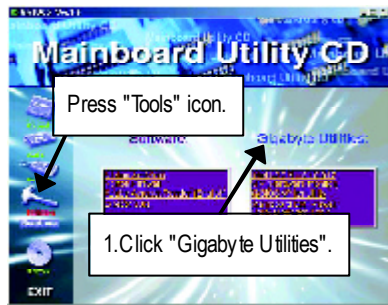

(1)



(2)



(3)

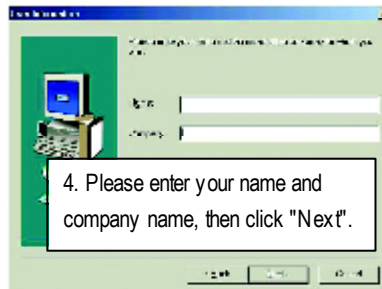

(4)

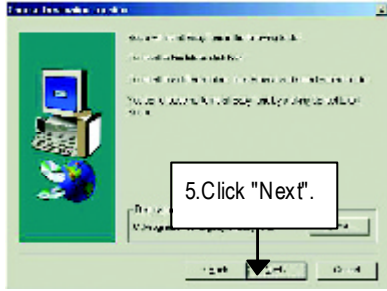

(5)

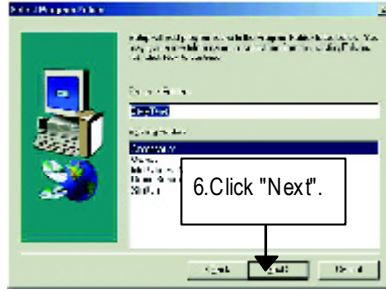

(6)

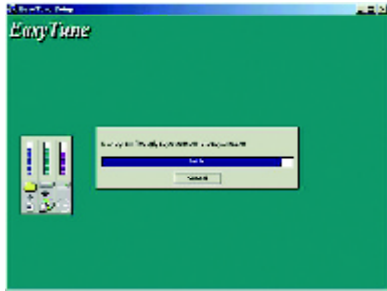

(7)



(8)

Appendix E: BIOS Flash Procedure

BIOS update procedure:

If your OS is Win9X, we recommend that you used Gigabyte @BIOS™ Program to flash BIOS.

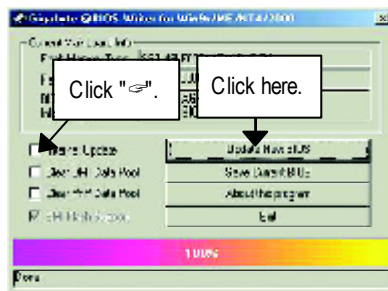

Methods and steps:

- I. Update BIOS through Internet
 - a. Click "Internet Update" icon
 - b. Click "Update New BIOS" icon
 - c. Select @BIOS™ sever ("Gigabyte @BIOS™ sever 1 in Taiwan" and "Gigabyte @BIOS™ sever 2 in Taiwan" are available for now, the others will be completed soon)
 - d. Select the exact model name on your motherboard
 - e. System will automatically download and update the BIOS.

II. Update BIOS NOT through Internet:

- a. Do not click "Internet Update" icon
- b. Click "Update New BIOS"
- c. Please select "All Files" in dialog box while opening the old file.
- d. Please search for BIOS unzip file, downloading from internet or any other methods (such as: 6IEM.F1).
- e. Complete update process following the instruction.

III. Save BIOS

In the very beginning, there is "Save Current BIOS" icon shown in dialog box. It means to save the current BIOS version.

IV. Check out supported motherboard and Flash ROM:

In the very beginning, there is "About this program" icon shown in dialog box. It can help you check out which kind of motherboard and which brand of Flash ROM are supported.

Note:

- a. In method I, if it shows two or more motherboard's model names to be selected, please make sure your motherboard's model name again. Selecting wrong model name will cause the system unbooted.
- b. In method II, be sure that motherboard's model name in BIOS unzip file are the same as your motherboard's. Otherwise, your system won't boot.
- c. In method I, if the BIOS file you need cannot be found in @BIOS™ server, please go onto Gigabyte's web site for downloading and updating it according to method II.
- d. Please note that any interruption during updating will cause system unbooted

We use GA-7V/TX motherboard and Flash841 BIOS flash utility as example.

Please flash the BIOS according to the following procedures if you are now under the DOS mode.

Flash BIOS Procedure:

STEP 1:

- (1) Please make sure you have set "Auto" for BIOS Feature Setup (BIOS Flash Protection). For more detail please refer to page 28.
- (2) Please make sure your system has installed the extraction utility such as winzip or pkunzip.
Firstly you have to install the extraction utility such as winzip or pkunzip for unzip the files. Both of these utilities are available on many shareware download pages like <http://www.shareware.cnet.com>

STEP 2: Make a DOS boot diskette. (See example: Windows 98 O.S.)

Beware: Windows ME/2000 are not allowed to make a DOS boot diskette.

- (1) With an available floppy disk in the floppy drive. Please leave the diskette "UN-write protected" type. Double click the "My Computer" icon from Desktop, then click "3.5 diskette (A)" and right click to select "Format (M)"

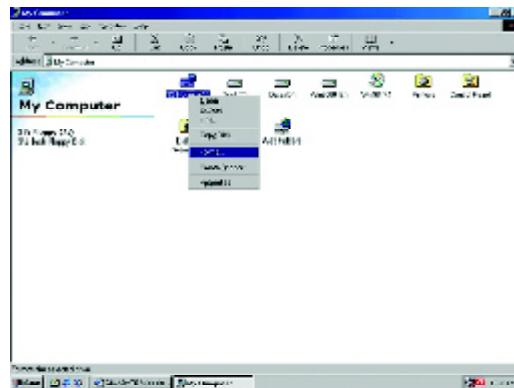

- (2) Select the "Quick (erase)" for Format Type, and pick both "Display summary when finished" and "Copy system files", after that press "Start". That will format the floppy and transfer the needed system files to it.

Beware: This procedure will erase all the prior data on that floppy, so please proceed accordingly.

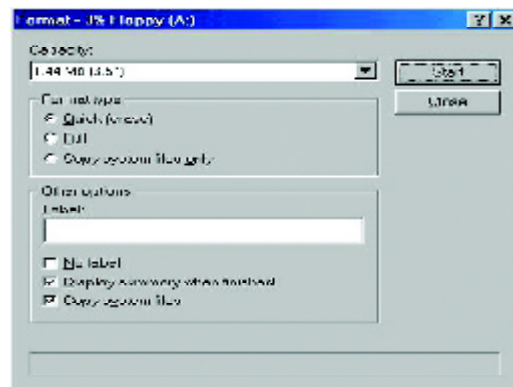

- (3) After the floppy has been formatted completely, please press "Close".

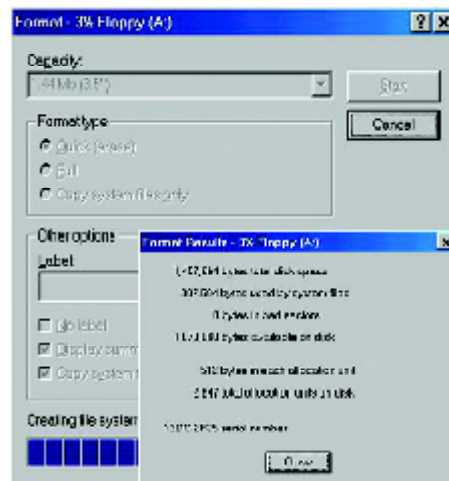

STEP 3: Download BIOS and BIOS utility program.

(1) Please go to Gigabyte website <http://www.gigabyte.com.tw/index.html>, and click "Support".



(2) From Support zone, click the "Motherboards BIOS & Drivers".

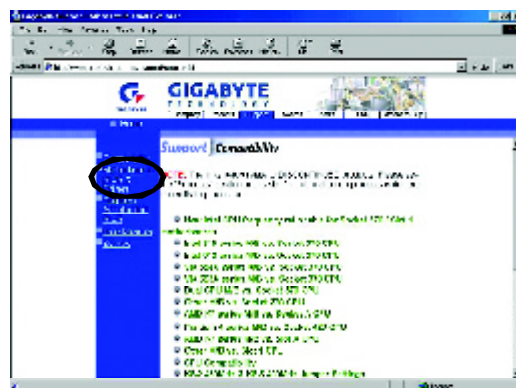

- (3) We use GA-7VTX motherboard as example. Please select GA-7VTX by Model or Chipset optional menu to obtain BIOS flash files.

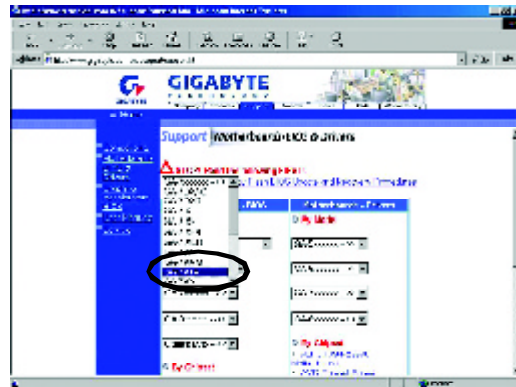

- (4) Select an appropriate BIOS version (For example: F4), and click to download the file. It will pop up a file download screen, then select the "Open this file from its current location" and press "OK".

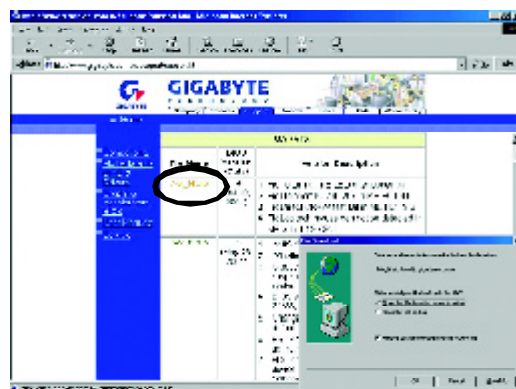

(5) At this time the screen shows the following picture, please click "Extract" button to unzip the files.



(6) Please extract the download files into the clean bootable floppy disk A mentioned in STEP 2, and press "Extract".

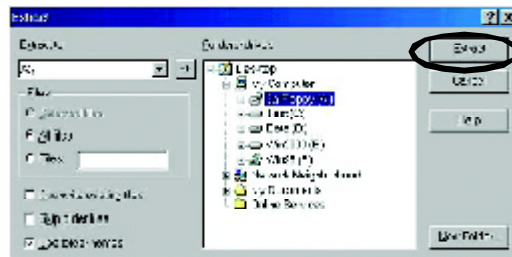

STEP 4: Make sure the system will boot from the floppy disk.

- (1) Insert the floppy disk (contains bootable program and unzip file) into the floppy drive A. Then, restart the system. The system will boot from the floppy disk. Please press key to enter BIOS setup main menu when system is boot up.

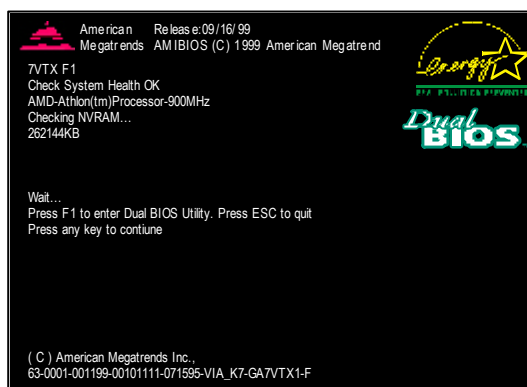

- (2) Once you enter the BIOS setup utility, the main menu will appear on the screen. Use the arrows to highlight the item "BIOS FEATURES SETUP".

AMIBIOS SIMPLE SETUP UTILITY - VERSION 1.24b (C) 1999 American Megatrends, Inc. All Rights Reserved	
STANDARD CMOS SETUP BIOS FEATURES SETUP CHIPSET FEATURES SETUP POWER MANAGEMENT SETUP PNP / PCI CONFIGURATION LOAD BIOS DEFAULTS LOAD SETUP DEFAULTS	INTEGRATED PERIPHERALS HARDWARE MONITOR & MISC SETUP SUPERVISOR PASSWORD USER PASSWORD IDE HDD AUTO DETECTION SAVE & EXIT SETUP EXIT WITHOUT SAVING
ESC: Quit ↓ ↓ ↓ ↓ ↓ : Select Item (Shift)F2 : Change Color F5: Old Values F6: Load BIOS Defaults F7: Load Setup Defaults F10: Save & Exit	
Time, Date , Hard Disk Type...	

- (3) Press "Enter" to enter "BIOS FEATURES SETUP" menu. Use the arrows to highlight the item "1st Boot Device", and then use the "Page Up" or "Page Down" keys to select "Floppy".

AMIBIOS SETUP - BIOS FEATURES SETUP	
(C) 2001 American Megatrends, Inc. All Rights Reserved	
1st Boot Device : Floppy	
2nd Boot Device : IDE-0	
3rd Boot Device : CDROM	
S.M.A.R.T. for Hard Disks : Disabled	
BootUp Num-Lock : On	ESC: Quit ↓↓↓↓: Select Item
Floppy Drive Seek : Disabled	F1 : Help PU/PD/+/- : Modify
Password Check : Setup	F5 : Old Values (Shift)F2: Color
	F6 : Load BIOS Defaults
	F7 : Load Setup Defaults

- (4) Press "ESC" to go back to previous screen. Use the arrows to highlight the item "SAVE & EXIT SETUP" then press "Enter". System will ask "SAVE to CMOS and EXIT (Y/N)?" Press "Y" and "Enter" keys to confirm. Now the system will reboot automatically, the new BIOS setting will be taken effect next boot-up.

AMIBIOS SIMPLE SETUP UTILITY - VERSION 1.24b	
(C) 2001 American Megatrends, Inc. All Rights Reserved	
STANDARD CMOS SETUP	INTEGRATED PERIPHERALS
BIOS FEATURES SETUP	HARDWARE MONITOR & MISC SETUP
CHIPSET FEATURES SETUP	SUPERVISOR PASSWORD
POWER MANAGEMENT SETUP	USER PASSWORD
PNP / PCI CONF	
LOAD BIOS DEFAULTS	SAVE & EXIT SETUP
LOAD SETUP DEFAULTS	EXIT WITHOUT SAVING
ESC: Quit ↓↓↓↓: Select Item (Shift)F2: Change Color F5: Old Values	
F6: Load BIOS Defaults F7: Load Setup Defaults F10: Save & Exit	
Save Data to CMOS & Exit SETUP	

STEP 5: BIOS flashing.

- (1) After the system boot from floppy disk, type "A:\> dir/w" and press "Enter" to check the entire files in floppy A. Then type the "BIOS flash utility" and "BIOS file" after A:\>. In this case you have to type "A:\> Flash841 7VTX.F4" and then press "Enter".

```
Starting Windows 98...

Microsoft(R) Windows98
  © Copyright Microsoft Corp 1981-1999

A:\> dir/w
  Volume in drive A has no label
  Volume Serial Number is 16EB-353D
  Directory of A:\
COMMAND.COM    7VTX.F4  FLASH841.EXE
               3 file(s)  838,954 bytes
               0 dir(s)  324,608 bytes free

A:\> Flash841 7VTX.F4
```

- (2) Now screen appears the following Flash Utility main menu. Press "Enter", the highlighted item will locate on the model name of the right-upper screen. Right after that, press "Enter" to start BIOS Flash Utility.

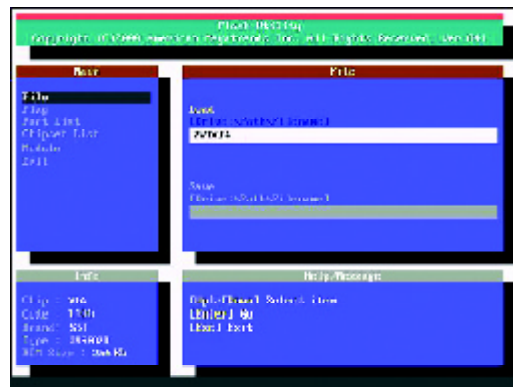

- (3) It will pop up a screen and asks "Are you sure to flash the BIOS?" Press [Enter] to continue the procedure, or press [ESC] to quit.

Beware: Please do not turn off the system while you are upgrading BIOS. It will render your BIOS corrupted and system totally inoperative.

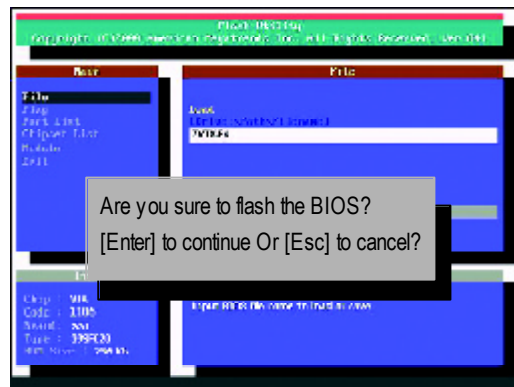

- (4) The BIOS flash completed. Please press [ESC] to exit Flash Utility.

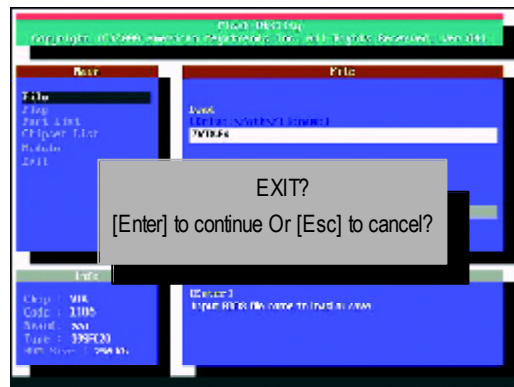

STEP 6: Load BIOS defaults.

Normally the system redetects all devices after BIOS has been upgraded. Therefore, we highly recommend reloading the BIOS defaults after BIOS has been upgraded. This important step resets everything after the flash.

- (1) Take out the floppy diskette from floppy drive, and then restart the system. The boot up screen will indicate your motherboard model and current BIOS version.



- (2) Don't forget to press key to enter BIOS setup again when system is boot up. Use the arrows to highlight the item "LOAD SETUP DEFAULTS" then press "Enter". System will ask "Load Setup Defaults (Y/N)?" Press "Y" and "Enter" keys to confirm.

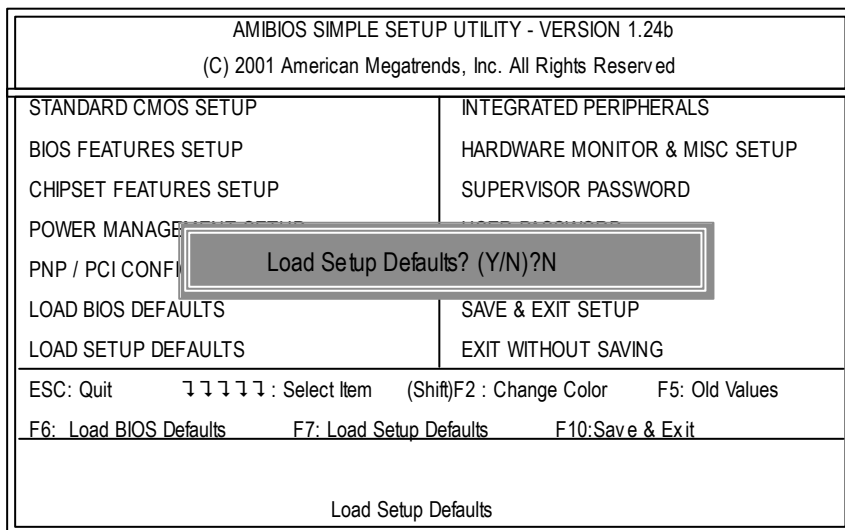

- (3) Use the arrows to highlight the item "SAVE & EXIT SETUP" and press "Enter". System will ask "SAVE to CMOS and EXIT (Y/N)?" Press "Y" and "Enter" keys to confirm. Now the system will reboot automatically, the new BIOS setting will be taken effect next boot-up.

AMBIOS SIMPLE SETUP UTILITY - VERSION 1.24b (C) 2001 American Megatrends, Inc. All Rights Reserved	
STANDARD CMOS SETUP	INTEGRATED PERIPHERALS
BIOS FEATURES SETUP	HARDWARE MONITOR & MISC SETUP
CHIPSET FEATURES SETUP	SUPERVISOR PASSWORD
POWER MANAGEMENT SETUP	USER PASSWORD
PNP / PCI CONF	SAVE & EXIT SETUP
LOAD BIOS DEFAULTS	EXIT WITHOUT SAVING
LOAD SETUP DEFAULTS	
ESC: Quit ↑ ↓ ← → : Select Item (Shift)F2 : Change Color F5: Old Values	
F6: Load BIOS Defaults F7: Load Setup Defaults F10: Save & Exit	
Save Data to CMOS & Exit SETUP	

- (4) Congratulate you have accomplished the BIOS flash procedure.

Appendix E: Acronyms

Acronyms	Meaning
ACPI	Advanced Configuration and Power Interface
APM	Advanced Power Management
AGP	Accelerated Graphics Port
AMR	Audio Modem Riser
ACR	Advanced Communications Riser
BBS	BIOS Boot Specification
BIOS	Basic Input / Output System
CPU	Central Processing Unit
CMOS	Complementary Metal Oxide Semiconductor
CRIMM	Continuity RIMM
CNR	Communication and Networking Riser
DMA	Direct Memory Access
DMI	Desktop Management Interface
DIMM	Dual Inline Memory Module
DRM	Dual Retention Mechanism
DRAM	Dynamic Random Access Memory
DDR	Double Data Rate
ECP	Extended Capabilities Port
ESCD	Extended System Configuration Data
ECC	Error Checking and Correcting
EMC	Electromagnetic Compatibility
EPP	Enhanced Parallel Port
ESD	Electrostatic Discharge
FDD	Floppy Disk Device
FSB	Front Side Bus
HDD	Hard Disk Device
IDE	Integrated Dual Channel Enhanced
IRQ	Interrupt Request
I/O	Input / Output
IOAPIC	Input Output Advanced Programmable Input Controller
ISA	Industry Standard Architecture

to be continued.....

GA-6IEM Series Motherboard

Acronyms	Meaning
LAN	Local Area Network
LBA	Logical Block Addressing
LED	Light Emitting Diode
MHz	Megahertz
MIDI	Musical Interface Digital Interface
MTH	Memory Translator Hub
MPT	Memory Protocol Translator
NIC	Network Interface Card
OS	Operating System
OEM	Original Equipment Manufacturer
PAC	PCI A.G.P. Controller
POST	Power-On Self Test
PCI	Peripheral Component Interconnect
RIMM	Rambus in-line Memory Module
SCI	Special Circumstance Instructions
SECC	Single Edge Contact Cartridge
SRAM	Static Random Access Memory
SMP	Symmetric Multi-Processing
SMI	System Management Interrupt
USB	Universal Serial Bus
VID	Voltage ID

Technical Support/RMA Sheet

Customer/Country :	Company :	Phone No.:
Contact Person:	E-mail Add. :	

Model name/Lot Number:	PCB revision:
BIOS version:	O.S./A.S.:

Hardware Configuration	Mfs.	Model name	Size:	Driver/Utility:
CPU				
Memory				
Brand				
Video Card				
Audio Card				
HDD				
CD-ROM / DVD-ROM				
Modem				
Network				
AMR / CNR				
Keyboard				
Mouse				
Power supply				
Other Device				

Problem Description:
