

# *Advanced Pentium Motherboard*

## VP1543

### **User's Manual**



# *Declaration*

## **Declaration**

### **Rights:**

No part of this manual, including but not limited to the products and software described in it, may be reproduced, transmitted, transcribed, stored in a retrieval system, or translated in any form or by any means without the expressed written permission of the manufacturer.

Products and corporate names appearing in this manual may or may not be registered trademarks or copyrights of their respective companies and are used only for identification or explanation purposes without intent to infringe.

- Intel, MMX and Pentium are registered trademarks of Intel Corporation.
- IBM and OS/2 are registered trademarks of International Business Machines.
- AWARD is a registered trademark of American Megatrends Inc.
- Winbond is a registered trademark of Winbond Electronics Inc.

### **Responsibility:**

This manual is provided “As is” with no warranties of any kind, either expressed or implied, including, but not limited to the implied warranties or conditions of this product’s fitness for any particular purpose. In no event shall we be liable for any loss of profits, loss of business, loss of data, interruption of business, or indirect, special, incidental, or consequential damages of any kind, even the possibility of such damages arising from any defect or error in this manual or product. We reserve the right to modify and update the user manual without prior notice.

1999/07

# *Compliance & Certificate*

## **Compliance & Certificate**

### **ISO 9001 Certificate:**

This device was produced in our plant with advanced quality system certified by DNV QA Ltd. in according to ISO 9001. This Certificate is valid for:

DESIGN & MANUFACTURE OF MOTHER BOARDS AND PERSONAL COMPUTERS.

### **CE Declaration:**

CE marking is a visible declaration by the manufacturer or his authorized representatives that the electrical equipment to which it relates satisfies all the provisions of the 1994 Regulations.

FCC Compliance:

### **FCC stands for Federal Communications Commission.**

This product complies with FCC Rules Part 15 and has been tested, and complied with the EMI rules by a certified body. In normal operation, there shall be no harmful interference caused by this device nor shall this device accept any interference received, including interference that may cause undesired operation of this product.

### **Year 2000 Compliance:**

This product is tested to be qualified to bear the NSTL Year 2000 Compliant logo. Year2000 problem is mainly a problem of computer software (OS), and the hardware issue. With the support of BIOS on motherboard, the Y2K problem can be thoroughly conquered.

### **Microsoft Windows Compliance:**

Microsoft, Windows NT, Windows, and the Windows Logo are registered trademarks of Microsoft Corporation.

# Easy Installation

## Easy Installation

### Easy Installation Steps

The following “Easy Installation” steps are for users accustomed to the assembly of a computer system. For those individuals requiring more specific information, please refer to the more detailed descriptions located within the latter chapters of this manual. Note: You must keep your power cable unplugged until the following installation steps are completed.

#### Getting Start:

Touch a grounded metal surface to release static electricity stored in your body before unpacking your motherboard. For details please refer to Precaution section in Chapter 3.

Install the CPU by correctly aligning the CPU with the Slot as noted in the motherboard diagram. Once aligned, press down on the CPU gently but firmly and lock it. Next, install the 3.3 volt unbuffered SDRAM into the 168 pin DIMMs. See Sec. 3.2 & 3.3.

Set CPU speed in according to Sec.3.2.

After completing the above steps, install any expansion Cards( PCI, ISA) into riser card and have the riser card installed firmly into the slot for riser card on board. See Sec. 3.4.

Plug in all cables included in the package except for the power cord. Please see Sec. 3.5.

Please recheck all steps to ensure no mistakes have been made and then plug in the power cord and turn on the power to enter the BIOS setup, Chapter 4.

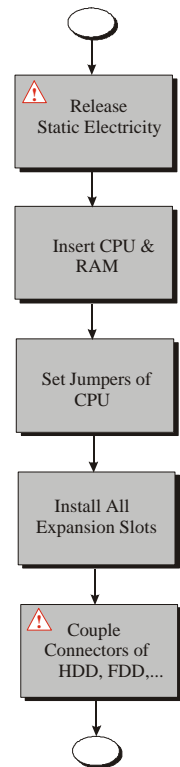

# Contents

<b>Declaration .....</b>	<b>2</b>
<b>Compliance &amp; Certificate .....</b>	<b>3</b>
<b>Easy Installation.....</b>	<b>4</b>
<b>1. Introduction.....</b>	<b>9</b>
1.1 How To Use This Manual .....	9
1.2 Check Your Device Items.....	9
<b>2. Features.....</b>	<b>11</b>
2.1 Features Of The Motherboard .....	11
<b>3. INSTALLATION.....</b>	<b>13</b>
3.1 Motherboard Layout & Main Parts .....	13
<i>Static Electricity Damage:</i> .....	15
<i>Misplaced Jumper Damage:</i> .....	15
3.2 Slots And Connectors.....	16
3.3 CPU (Central Processing Unit) .....	17
3.3.1 <i>Install CPU</i> .....	17
3.3.2 <i>Arrange Jumper Setting</i> .....	18
3.3.3 <i>Other Jumper Settings</i> .....	22
3.4 System Memory (DRAM) .....	22
3.4.1 <i>DIMM (Dual Inline Memory Module)</i> .....	22
3.4.2 <i>Installation Procedure</i> .....	22
3.4.3 <i>DIMM Module Combinations</i> .....	23
3.5 Expansion Slots .....	24
3.6 Connectors.....	25
3.6.1 <i>Primary IDE Connector (J10, 39-pin block, Black)</i> .....	25
3.6.2 <i>Secondary IDE Connector (J9, 39-pin block, White)</i> .....	25
3.6.3 <i>Floppy Drive Connector (J6, 33-pin block)</i> .....	26
3.6.4 <i>Power Input Connector (J5, 20-pin block)</i> .....	26
3.6.5 <i>Front Panel connectors (J20, 15-pin)</i> .....	27
3.6.6 <i>Speaker Connector (4-pin)</i> .....	27
3.6.7 <i>Power LED (3-pin)</i> .....	27
3.6.8 <i>Keyboard Lock (2-pin)</i> .....	27
3.6.9 <i>Reset Switch Connector (2-pin)</i> .....	27
3.6.10 <i>HDD (IDE) LED Connector (2-pin)</i> .....	27
3.6.11 <i>Sleep Switch (2-pin)</i> .....	27
3.6.12 <i>Power Switch (2-pin)</i> .....	28
3.6.13 <i>Back Panel Connectors</i> .....	28
3.6.14 <i>PS/2 Keyboard and Mouse Ports</i> .....	29
3.6.15 <i>Universal Serial Bus (USB) Ports</i> .....	29

# Contents

3.6.16 Parallel Port (Printer).....	29
3.6.17 Serial Port (COM1/COM2).....	30
3.6.18 Additional Connectors.....	30
3.6.19 WOL (Wake On LAN).....	30
3.6.20 Chassis Fan.....	30
3.6.21 Infrared (IrDA) connector (6-pin).....	31
3.6.22 CPU Fan.....	31
<b>4. BIOS Setup .....</b>	<b>33</b>
4.1 BIOS Setup.....	33
4.1.1 Setup Keys.....	34
4.1.2 Getting Help.....	34
4.1.3 In Case of Problems.....	34
4.2 Main Setup Menu.....	34
4.3 Standard CMOS Setup Menu.....	36
4.3.1 Date.....	36
4.3.2 Time.....	36
4.3.3 Hard Disks.....	36
4.3.4 Drive A/B type.....	38
4.3.5 Video.....	38
4.3.6 Halt on.....	38
4.3.7 Memory.....	39
4.4 BIOS Features Setup Menu.....	40
4.4.1 Virus Warning.....	40
4.4.2 CPU Internal Cache.....	40
4.4.3 External Cache.....	41
4.4.4 Quick Power On Self Test.....	41
4.4.5 Boot Sequence.....	41
4.4.6 Swap Floppy Drive.....	41
4.4.7 Boot Up Floppy Seek.....	41
4.4.8 Boot Up NumLock Status.....	41
4.4.9 Boot Up System Speed.....	41
4.4.10 Typematic Rate Setting.....	41
4.4.11 Typematic Rate (Chars/Sec).....	42
4.4.12 Typematic Delay (Msec).....	42
4.4.13 Security Option.....	42
4.4.14 PCI/VGA Palette Snoop.....	42
4.4.15 Assign IRQ For VGA.....	42
4.4.16 OS select for DRAM > 64MB.....	42
4.5 Chipset Features Setup Menu.....	43
4.5.1 Auto Configuration.....	43
4.5.2 L2 TAG RAM Size.....	43

# Contents

4.5.3 AT Bus Clock .....	43
4.5.4 DRAM Timing.....	43
4.5.5 SDRAM CAS Latency .....	44
4.5.6 Pipelined Function.....	44
4.5.7 Graphics Aperture Size.....	44
4.5.8 DRAM Data Integrity Mode.....	44
4.5.9 Memory Hole At 15M-16M.....	44
4.5.10 Host Read DRAM Command Mode .....	44
4.5.11 ISA Line Buffer .....	44
4.5.12 Passive Release.....	44
4.5.13 Delay Transaction .....	45
4.5.14 Primary Frame Buffer .....	45
4.5.15 VGA Frame Buffer.....	45
4.5.16 Data Merge .....	45
4.5.17 Shutdown Temperature .....	45
4.5.18 CPU Warning Temperature .....	45
4.6 Power Management Setup Menu.....	46
4.6.1 ACPI function .....	46
4.6.2 Power Management .....	46
4.6.3 PM Control by APM.....	47
4.6.4 Modem Use IRQ .....	47
4.6.5 Video Off Option.....	47
4.6.6 Video Off Method .....	47
4.6.7 HDD Power Down .....	47
4.6.8 Doze Mode.....	47
4.6.8 Standby Mode .....	48
4.6.9 Suspend Mode .....	48
4.6.10 Primary HDD / Floppy / COM Ports / Keyboard / LPT Ports.....	48
4.6.11 Power Button .....	48
4.6.12 Thermal SMI.....	48
4.7 PCI Configuration Setup Menu .....	49
4.7.1 PNP OS Installed .....	49
4.7.2 Resources Controlled By.....	49
4.7.3 Reset Configuration Data .....	49
4.7.4 PCI IDE 2 <sup>nd</sup> Channel.....	49
4.7.5 PCI IRQ Activated By .....	50
4.7.6 PCI IDE IRQ Map To.....	50
4.7.7 Primary/Secondary IDE INT#.....	50
4.8 Integrated peripherals Menu.....	51
4.8.1 On-chip Primary IDE .....	51
4.8.2 On-Chip Secondary IDE.....	51

# Contents

4.8.3 On-Chip Primary/Secondary Master/Slave PIO.....	51
4.8.4 On-Chip Primary/Secondary Master/Save UDMA.....	51
4.8.5 IDE HDD Block.....	52
4.8.6 On-Chip USB Controller.....	52
4.8.7 Ring / Wake On LAN Control.....	52
4.8.8 Onboard FDC Controller.....	52
4.8.9 Onboard UART Port1 / Port 2.....	52
4.8.10 Onboard Parallel Port.....	52
4.8.11 Parallel Port Mode.....	52
4.8.12 ECP Mode Use DMA.....	52
4.8.13 Onboard IrDA Port.....	52
4.9 Load Setup Defaults.....	53
4.10 User Password.....	53
4.11 IDE HDD Auto Detection.....	53
4.12 Save & Exit Setup.....	53
4.13 Exit Without Saving.....	53



# 1. Introduction

## 1. Introduction

### 1.1 How To Use This Manual

This manual provides information necessary for Original Equipment Manufactures (OEMs) and home users to build a PC-AT compatible system using the Pentium PCI/ISA motherboard. Follow the installation procedure presented on the **Easy Installation Page** and refer to the section number following each step if you require more detailed instructions.

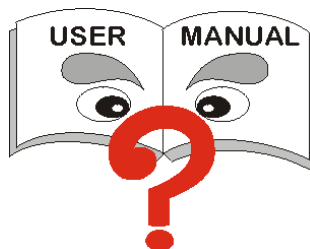

### 1.2 Check Your Device Items

The standard package should contain the following items. If you find any of these items be missing or damaged, please contact your retailer.

- The VP1543 motherboard
- 1 IDE ribbon cable
- 1 floppy ribbon cable
- 1 CD Diskette with IDE&AGP drivers for Aladdin 5 chipset.
- 1 User's Manual
- ✗ Infrared (IrDA) module with ribbon cable (optional)

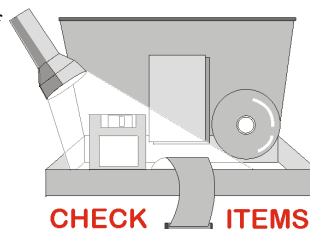

# *1. Introduction*

## 2. Features

## 2. Features

### 2.1 Features Of The Motherboard

The VP1543 motherboard integrates the Pentium® microprocessor, memory, I/O and is designed to fit into a standard ATX form factor chassis. This motherboard support Pentium processors, Pentium processors with MMX , Cyrix 6X86/6x86L/MX/MII processors, IDT-C6, WinChip2/WinChip3 processors and AMD K5/K6/K6-2/K6III processors. Page 13 illustrates the Layout for the VP1543 motherboard. Below lists the key features provided by this motherboard:

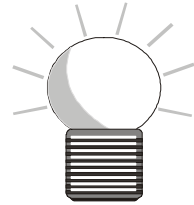

#### Processor (+Cache)

- ZIF socket 7
- Intel Pentium Family 90~233 MHz CPU with MMX™ technology or Cyrix 6X86/6X86L/MX/MII and AMD-K5/ K6/K6-2/K6-III or IDT-C6 / IDT WinChip2/WinChip3.

#### Chipset

- ALI M1541/M1543C AGP/PCI/ISA (AladdinV) with I/O subsystem chipset.

#### System Memory

- Three 168-pin DIMM sockets
- Minimum 8MB up to maximum 768MB Memory Capacity
- Support 66MHz /100MHz SDRAM DIMM module.

#### Graphics Support

- Supports AGP (Accelerated Graphics Port) for increased performance of Graphic Displays, special 3D operations in multimedia, and higher speed to satisfy the users optical vision.
- AGP Interface supports data transfers at 1x or 2X with full side-band signals.

#### PCI Bus Master IDE Controller

- Integrated PCI Bus Master IDE Controller Chip with Ultra-DMA66 capabilities. Up to four IDE devices can be supported using the two onboard IDE connectors. Also supported is PIO Modes 3&4, Bus Master IDE DMA Mode 2 and Enhanced IDE

## 2. Features

devices such as Tape Backup machines and CD-ROMs. Either the 5.25-inch or 3.5 inch (1.44MB or 2.88MB) floppy drives can be used without requiring an external card. Additionally, Floppy 3 mode (Japanese standard 3.5 inch disk drive, 1.2MB) and LS-120 floppy disk drives (3.5 inch disk drive: 120MB, 1.44MB, 720K) are also supported.

### Hardware Monitoring (Optional)

- Onboard Winbond W83781D chip to monitor variable voltages used in system CPU fan speed, and temperature.

### External Communication Ports

- Universal Serial Bus (USB) integrated with Core Logic.

### System BIOS

- AWARD BIOS based on 1MB Flash ROM. Enable IDE Auto-configuring, support ISA Plug & play, PC-98, Multi-Boot and PCI Add-In card auto-configuring.
- Also it supports DMI, which allows hardware to communicate within a standard protocol creating a higher level of compatibility. (Requires DMI-enabled component.)

### Green Features

- Power Management: APM 2.1, Meets EPA Mode 2.0.
- Additionally, with support for ACPI (Advanced Configuration and Power Interface) feature, your system will become more wise in management of power.

### Additional features

- Wake-On-LAN header
- Smart soft power control

### Expansion Slots

- Four PCI, Three ISA bus slots and One AGP slot for your variable usage

### Mechanical

- This motherboard complies with the ATX Form Factor specifications and is a four layers with dimensions of 7.5" x 12.0"

# 3. Installation

## 3. Installation

### 3.1 Motherboard Layout & Main Parts

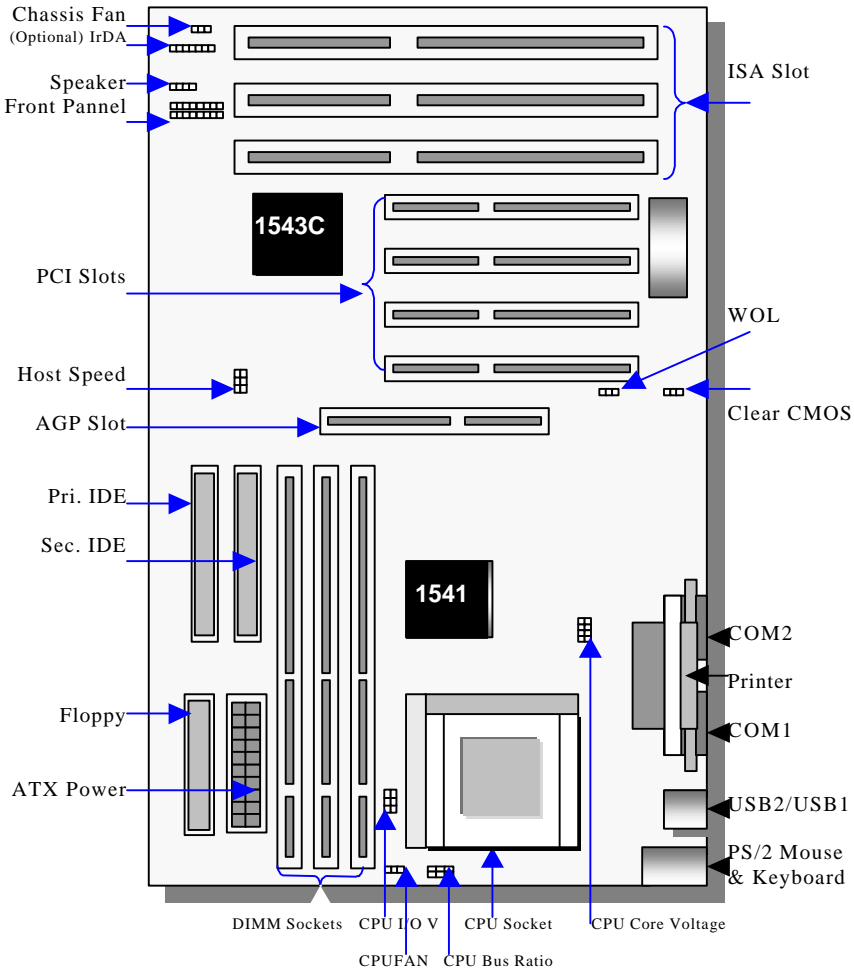

## 3. Installation

### Significant Parts List

#### Front Panel Connectors

Speaker	Refer to Sec. 3.5.5
Reset	Refer to Sec. 3.5.5
Key Lock/ Power LED	Refer to Sec. 3.5.5
Power Switch (Optional)	Refer to Sec. 3.5.5
Sleep	Refer to Sec. 3.5.5
IDE LED	Refer to Sec. 3.5.5

#### Back Panel Connectors

PS/2-style keyboard and mouse connectors	Refer to Sec. 3.5.6
USB connectors	Refer to Sec. 3.5.6
Two serials ports	Refer to Sec. 3.5.6
One parallel port	Refer to Sec. 3.5.6

#### Expansion Slots/Sockets

Socket7 CPU Slot	Refer to Sec. 3.2
SIMM/DIMM Sockets	Refer to Sec. 3.3
ISA/PCI/AGP Slots	Refer to Sec. 3.4

#### Power/IDE/FDD Connectors

IDE connectors	Refer to Sec. 3.5.1
Power connector	Refer to Sec. 3.5.4
FDD connector	Refer to Sec. 3.5.3

#### Additional Connectors

Clear CMOS	Refer to Sec. 3.2.3
CPU Fan	Refer to Sec. 3.5.7
Chassis Fan	Refer to Sec. 3.5.7
IrDA	Refer to Sec. 3.5.7
WOL Connector	Refer to Sec. 3.5.7

## 3. Installation

### Precaution Before Start

#### Static Electricity Damage:

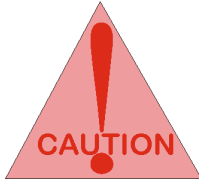

Static electricity can easily damage your motherboard. Observing a few basic precautions can help safeguard against damage that could result in expensive repairs. Follow the simple measures below to protect your equipment from static electricity damage.

1. Keep the motherboard and other system components in their anti-static packaging until you are ready to install them.
2. Touch a grounded surface before you remove any system component from its protective anti-static packaging. Unpacking and installation should be done on a grounded, anti-static mat. The operator should be wearing an anti-static wristband, grounded at the same points as the anti-static mat.
3. After removing the motherboard from its original packaging, only place it on a grounded, anti-static surface component side up. Immediately inspect the board for damage. Due to shifting during shipping, it is suggested that the installer press down on the entire socket ICs to ensure they are properly seated. Do this only with the board placed on a firm flat surface.
4. During configuration and installation touch a grounded surface frequently to discharge any static electrical charge that may have built up in your body. The best precaution is to wear a grounded wrist strap. Avoid touching the components. When handling the motherboard or an adapter card. Handle the motherboard and adapter cards either by the edges or by the adapter card case-mounting bracket.

#### Misplaced Jumper Damage:



There are critical headers used for connectors or power sources. These are clearly marked separately from the jumpers listed in Motherboard Layout. Incorrect setting jumpers and connectors may lead to damage to your motherboard. Please pay special attention not to connect these headers in wrong directions

# 3. Installation

## 3.2 Slots And Connectors

This motherboard requires jumper setting for making some change.

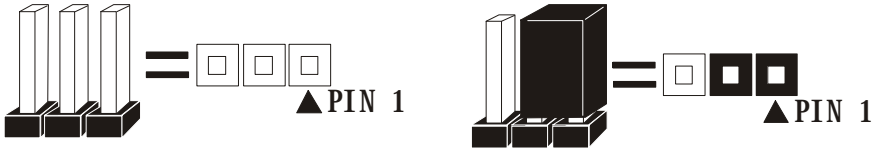

Note: In the following pages, the triangle ▲ mark stands for pin 1 of connectors.

### Slots/Connectors List

J1: CPU FAN	J14: PCI3
J2: Upside (Mouse), Bottom(Keyboard)	J16: PCI 4
J3: Upside (USB2), Bottom (USB1)	J17: ISA1
J4: Serial Port (COM1)	J18: ISA2
J5: ATX Power connector	J19: Keyboard Lock & Power/Green LED
J6: Floppy Connector	J20: HDD LED
J7: Parallel Port (LPT1)	J21: Sleep
J8: Serial Port (COM2)	J22: Reset
J9: Secondary IDE	J23: Power switch
J10: Primary IDE	J24: Speaker
J11: WOL (Wake On LAN) connector	J25: ISA3
J12: PCI 1	J26: IrDA (Infrared DATA Association)
J13: PCI2	J27: Chassis FAN



# 3. Installation

## 3.3 CPU (Central Processing Unit)

The Pentium P54C/P55C, Cyrix 6X86L/6X86MX/MII, IDT-C6, AMD-K5/K6 /K6-2 processors have various voltage choices depending on the CPU suppliers. Also this motherboard can be upgraded with Pentium processors that run at higher speeds. When upgrading the processor, use the BIOS configuration mode to change the processor speed. To complete CPU installation, please install CPU to socket firmly and arrange jumper settings carefully, presented in sec. 3.3.1 and 3.3.2.

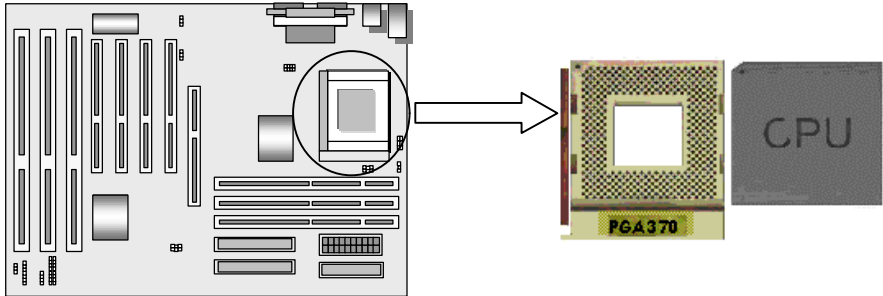

### 3.3.1 Install CPU

Please follow the steps below to install your CPU, and configure the types, voltage and speed in according to Processor Jumper Setting List.

- Step 1: Pull the handling bar of the socket upward to the other end to loosen the socket's openings.
- Step 2: Place the CPU on the middle of the socket, orienting its beveled corner to line up with the socket's beveled corner. Make sure the pins of the CPU fit evenly to the socket openings.

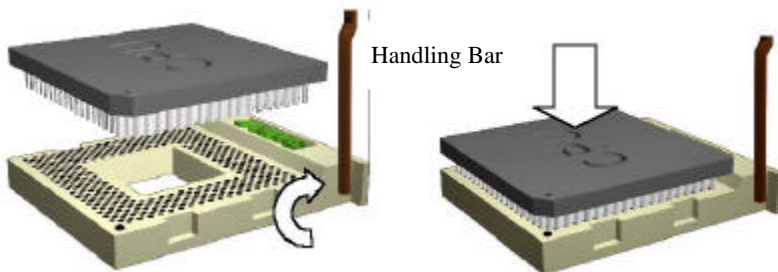

# 3. Installation

Step 3: Press the handling bar downward to fasten the CPU to the socket.

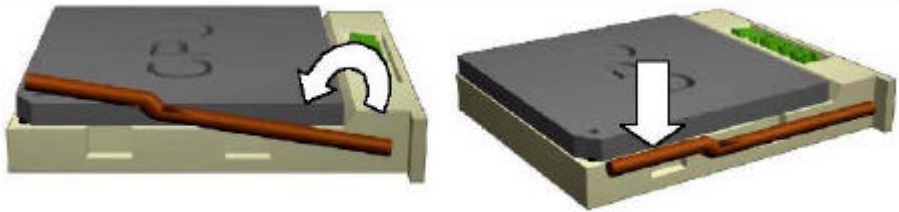

**Warning :** It is strongly recommended that a heatsink and CPU cooling fan be used to prevent the CPU from overheating. Applying a thermal of jelly between the CPU and the heatsink/fan will further cool the CPU.

## 3.3.2 Arrange Jumper Setting

Due to different CPU require a varied configuration of Clock, CPU/BUS speed, I/O voltage and Core voltage. Please refer to the following Jumper setting list exactly to setup your jumper.

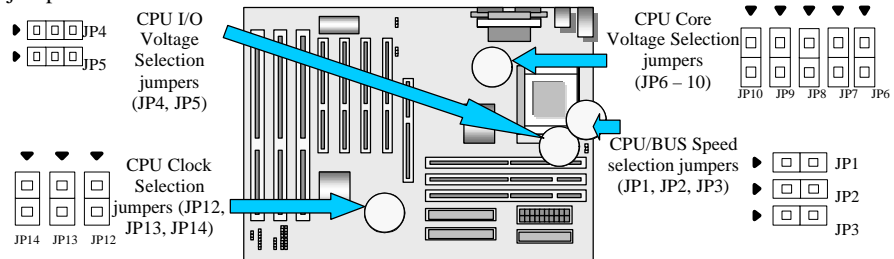

Now follow the below steps to configure your CPU settings.

# 3. Installation

Step1: Setting CPU I/O Voltage

Step2 :Setting CPU Clock





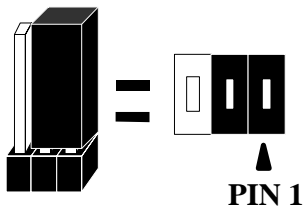



















CPU TYPE (I/O Voltage)	JP4	JP5
P54C, K5, 6X86		
P55C, K6, K6-2, K6III, 6X86L, M2, MII		

CPU Clock (MHz)	JP12	JP13	JP14
60			
66			
75			
83			
95			
100			









### 3. Installation

#### Step3: Setting CPU/BUS Speed

Intel CPU/BUS	JP1 (BF2)	JP2(BF1)	JP3(BF0)
X1.5 / X3.5			
X2.0			
X2.5			
X3.0			
X4.0			
X4.5			
X5.0			
X5.5			

#### Step 4: Setting CUP/BUS Speed for IDT WinChip2/WinChip3 CPU

IDT CPU/BUS	JP1 (BF2)	JP2(BF1)	JP3(BF0)
X2.33			
X2.66			

### 3. Installation

#### Step 5: Setting CPU Core Voltage

Vcore	JP10	JP9	JP8	JP7	JP6
2.0V					
2.1V					
2.2V					
2.3V					
2.4V					
2.5V					
2.6V					
2.7V					
2.8V					
2.9V					
3.0V					
3.1V					
3.2V					
3.3V					
3.4V					
3.5V					

# 3. Installation

## 3.3.3 Other Jumper Settings

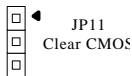
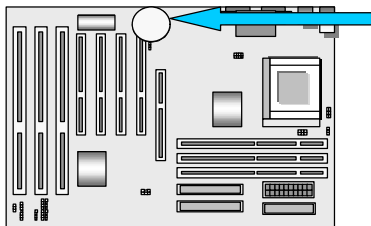

### Clear CMOS (JP11)

If an unknown password is set in the BIOS, it can be cleared by inserting a cap over JP11.

Description	JP11
Default	
Clear CMOS	

## 3.4 System Memory (DRAM)

### 3.4.1 DIMM (Dual Inline Memory Module)

The VP1543 features three 168-pin DIMM sockets. You can configure the system memory size from 8MB to 768MB in a variety of ways by using different combinations of the three 168-pin DIMM.

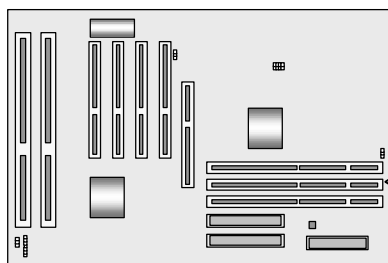

### 3.4.2 Installation Procedure

- Step1:** Make sure Pin 1 of the DIMM match with pin 1 of the DIMM socket.
- Step2:** Insert the DIMM module into the DIMM socket vertically. After inserting the DIMM module completely into the socket, push up on the socket latches securing the DIMM into place.

### 3. Installation

If the pin 1 of the DIMM module does not line up with pin 1 of the socket, the DIMM module will not be inserted correctly into the socket.

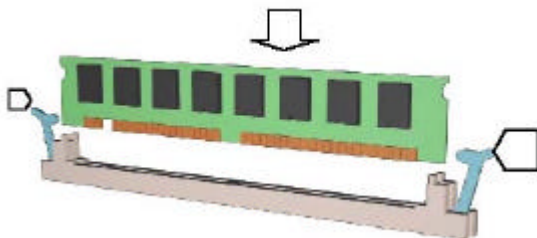

Be careful not to misfit the DIMM Module into DIMM sockets in wrong direction. This module can be inserted into the socket only one way. To release the memory module, push both latches down and carefully rock the module forward and backward while slowly lifting it upward.

#### 3.4.3 DIMM Module Combinations

Each DIMM socket can be inserted with 8MB, 16MB, 32MB, 64MB, 128MB, 256MB DIMM or empty. The total combinations are,  $7*7*7$ , 343 selections. You can refer to following figure to select one way to insert your DIMM, for example:.

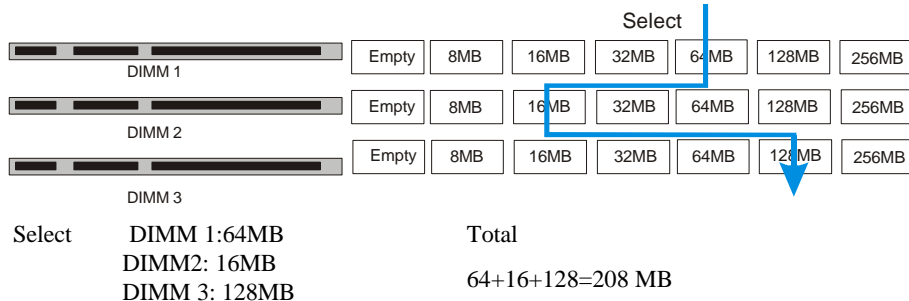

To select 1 out of 7 items (empty, 8MB, 16MB, 32MB, 64MB, 128MB, 256MB) in DIMM3.

Then, repeat again in DIMM2, DIMM1 to go through your own path.

A total of 343 combinations ensure you can insert your DIMM modules any way you prefer.

## 3. Installation

### 3.5 Expansion Slots

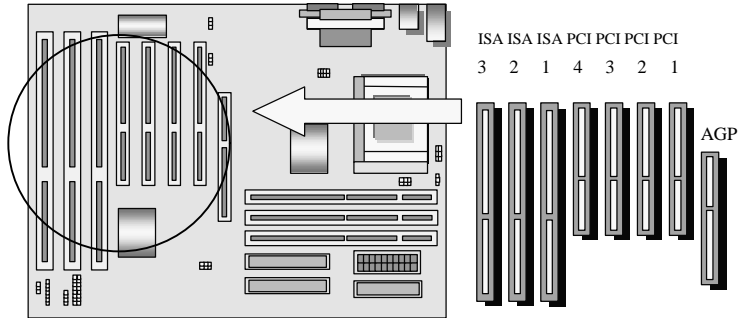

This motherboard contains 8 expansion slots onboard. Three 16-bit ISA Bus, four 32-bit PCI expansion slots and one 32-bit AGP slot as shown above.

All four PCI expansion slots accept PCI bus master cards and are fully supported by the PCI 2.1 specification.

The Accelerated Graphics Port (AGP or A.G.P.) is a high performance interconnect targeted at 3D graphical display applications and is based on a set of performance extensions or enhancements to the PCI bus. (AGP interface specification Rev. 1.0 compliant)

To install expansion cards, please read the expansion card's documentation for instructions and cautions.



# 3. Installation

## 3.6 Connectors

This motherboard contains IDE, floppy, power input, front panel, back panel and additional connectors.

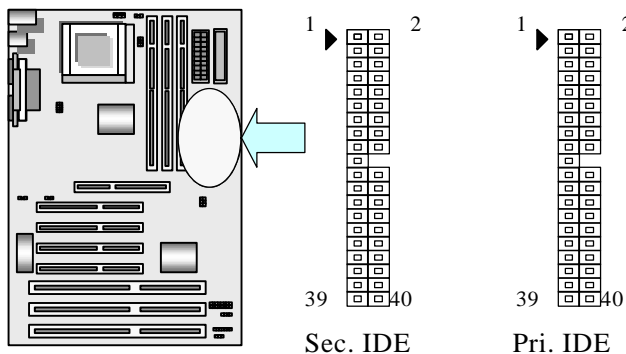

### 3.6.1 Primary IDE Connector (J10, 39-pin block, Black)

This connector supports two primary channel IDE devices via a ribbon cable. When two IDE devices are installed using the primary IDE connector, make sure that the second IDE device is set to slave mode as indicated in the device's manual.

### 3.6.2 Secondary IDE Connector (J9, 39-pin block, White)

This connector supports two secondary channel IDE devices as well as the 120MB Floppy drives via a ribbon cable. When two IDE devices are installed using the secondary IDE connector, make sure that the second IDE device is adjusted to slave mode as indicated in the device's manual.

**Warning:** When you connect a ribbon cable to these ports, you must orient the cable connector so that the PIN 1 edge of the cable is at the PIN 1 edge of the onboard connector.

## 3. Installation

### 3.6.3 Floppy Drive Connector (J6, 33-pin block)

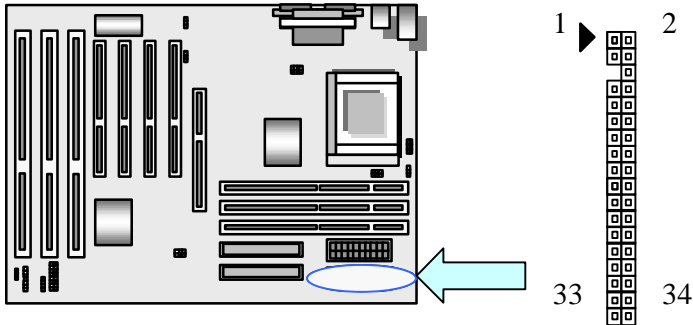

The FDC sub-system can control three types of floppy drives (1.2, 1.44 and 2.88MB) or compatible tape drives. The connection to the floppy drive is via a header. The floppy disk interface includes 48mA drivers and inputs on the drive interface.

### 3.6.4 Power Input Connector (J5, 20-pin block)

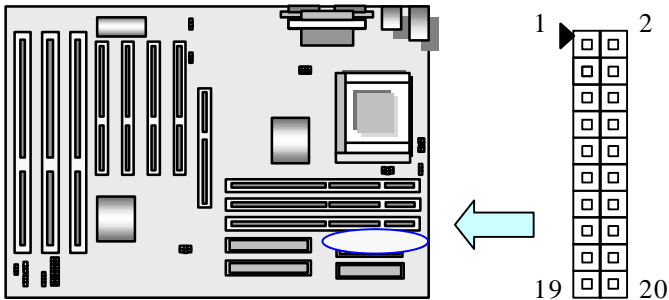

This connector supports a standard ATX power supply. When connecting, make sure the lock key matches the hook attached on a power supply cable. The power cord should be unplugged when you connect it.

# 3. Installation

## 3.6.5 Front Panel connectors (J20, 15-pin)

Front Panel includes headers for the following eight I/O connectors:

Power LED, Keyboard Lock, Speaker, Power Switch (optional), Reset, Sleep, HDD LED and 4sec Power switch(Optional). Descriptions are as follows.

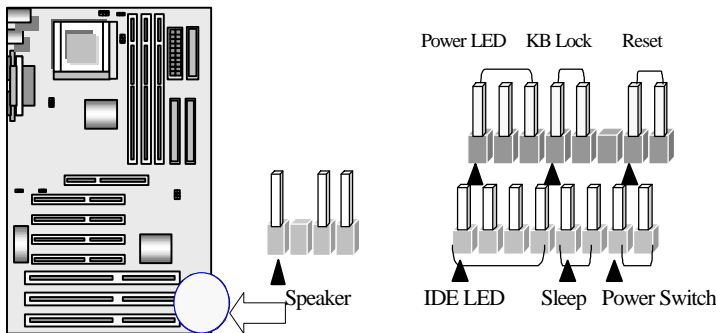

## 3.6.6 Speaker Connector (4-pin)

It is used to drive a chassis-mounted speaker if desired.

## 3.6.7 Power LED (3-pin)

This header can be connected to a LED that will light when the computer is powered on.

## 3.6.8 Keyboard Lock (2-pin)

This header allows you to lock your keyboard with a button or a key manually.

## 3.6.9 Reset Switch Connector (2-pin)

This connector supports the front panel case-mounted reset button. It is advised that the reset switch be used for rebooting the system in order to extend the life of the system's power supply.

## 3.6.10 HDD (IDE) LED Connector (2-pin)

The mainboard supports one straight 4-pin header for connecting to front Panel Hard Disk activity LED indicator.

## 3.6.11 Sleep Switch (2-pin)

When the APM (Advanced Power Management) feature is enabled in the system BIOS and

## 3. Installation

the operating system's APM driver is loaded, the system can enter the sleep (standby) mode in one of the following ways:

- Optional front panel sleep/resume button
- Prolonged system inactivity using the BIOS inactivity timer feature.

The 2-pin header supports a front panel sleep/resume switch, which must be a momentary SPST type that is normally open.

### 3.6.12 Power Switch (2-pin)

This connector supports the ATX case-mounted Power Switch, which in turn supports System Suspend function. When the BIOS sets the Power Button function to "Delay 4 sec.", the system can be set to the suspended mode once you push the power switch for no longer than 4 seconds. If the power switch is pushed down for over 4 seconds the system will be totally Power Off. When the BIOS setting sets the Delay 4 second to "Instant-off", then Power Switch function work as regular power switch.

### 3.6.13 Back Panel Connectors

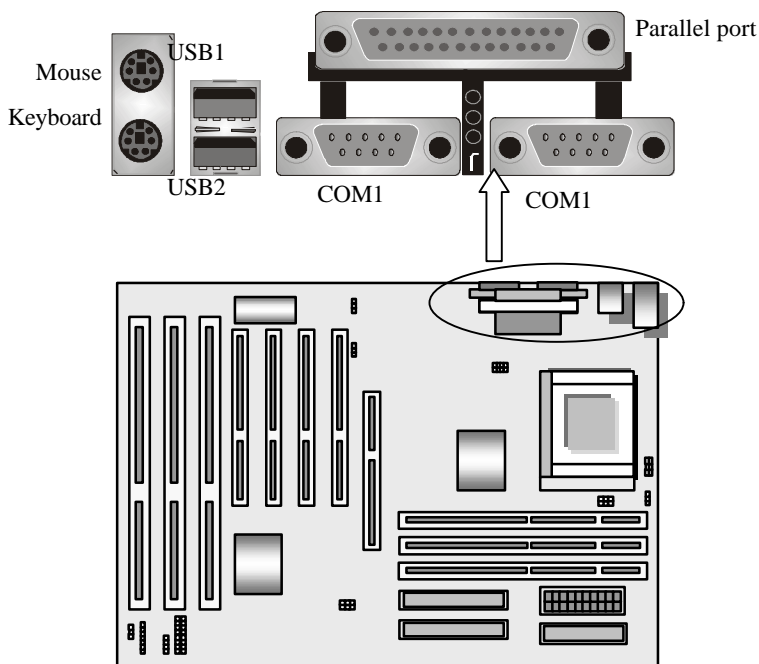

# 3. Installation

## 3.6.14 PS/2 Keyboard and Mouse Ports

The motherboard offers 1 PS/2 Keyboard and 1 PS/2 Mouse port.

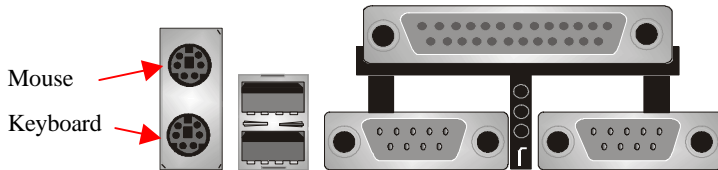

## 3.6.15 Universal Serial Bus (USB) Ports

The motherboard has two USB connectors. USB devices provide a more convenient operating environment and improve data transferring capacity. True Plug & Play. This new bus technology will support over 127 different peripherals through a Hub.

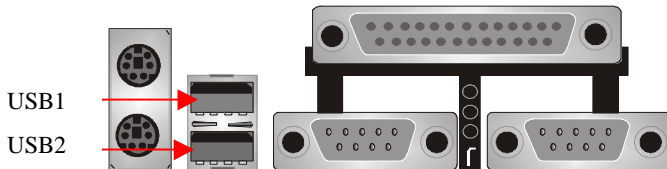

## 3.6.16 Parallel Port (Printer)

The motherboard includes a parallel port (EPP/ECP compatible). The parallel port is capable of being disabled or remapped to either the secondary LPT address or the primary LPT address through BIOS if another parallel port is installed.

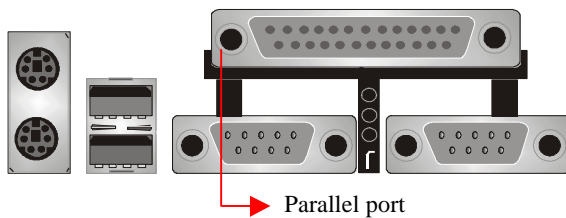

## 3. Installation

### 3.6.17 Serial Port (COM1/COM2)

The motherboard has two serial ports (one on rear panel, one on board). The electrical characteristics are compliant with the EIA-232-D Serial Communications Specifications. The serial ports may be remapped over other installable serial ports or disabled through the BIOS.

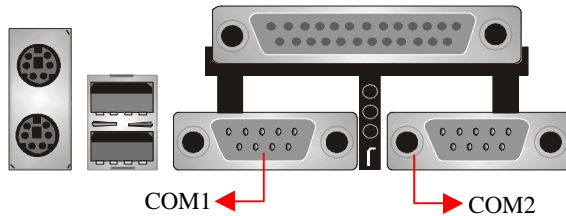

### 3.6.18 Additional Connectors

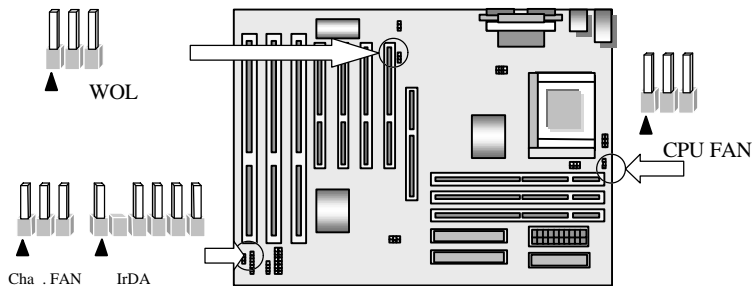

### 3.6.19 WOL (Wake On LAN)

This header is used for remote wakeup of the computer through a network. WOL requires a PCI add-in network interface card (NIC) with remote wakeup capabilities. The remote wakeup header on the NIC must be connected to the onboard Wake on LAN header. For Wake on LAN, the 5-V standby line for the power supply must be capable of delivering  $5V \pm 5\%$  at 720mA.

### 3.6.20 Chassis Fan

This header can supply power for Chassis Fan which may be mounted inside your case to cool down your system components. If your chassis have a Chassis Fan, this header will support it.

## 3. Installation

### 3.6.21 Infrared (IrDA) connector (6-pin)

The VP1543 offers an IrDA infrared header that supports third party infrared modules. The case must reserve space for the IR module if you want to use the IrDA function. This option supports wireless transmission and reception of infrared data. The module mounts in a small opening on the system case that supports this feature. The efficient distance is 100cm and the transfer rate is 115,200 bits/sec.

### 3.6.22 CPU Fan

Your Pentium Cartridge may have an attached heatsink and Fan; this connector is for the CPU Fan.

## Ready To Turn On Power

### Check Again

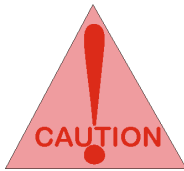

1. Is the CPU installed exactly and firmly into the socket (Sec. 3.3)?
2. Are all the DRAM modules installed properly (Sec. 3.4)?
3. Did you insert the expansion card (VGA, Sound..etc.) already (Sec. 3.5)?

Are you sure that all the connectors (described in Sec 3.6) have been connected to their variable devices (Sec. 3.6)?

### Yes, I have checked and assured the above steps!



Now get ready to turn on your device by following the steps below.

1. Mount your motherboard to the chassis frame and close the case cover.
2. Switch off all power.
3. Connect the power supply cord into inlet of the system case.
4. Connect the power supply cord into an outlet of power supply.
5. Connect Monitor signal cable to the system VGA port and the monitor power cord to power outlet.
6. Now turn on the monitor and system power.

**After Power on**, The power LED on the front panel of the system case will light. For ATX power supplies, the system LED will light when the ATX power switch is pressed.

The system will then do a power-on tests item by item, and additional messages will appear on screen. If the screen blinks or the tests stops more than 30 seconds, the system may have failed the power-on test. If so, please recheck the above steps or call your retailer for assistance.

## 3. *Installation*

If the power-on test goes well, hold down <F2> button on the keyboard to enter BIOS Setup. Next, follow the instructions in the next chapter, **BIOS SETUP**.

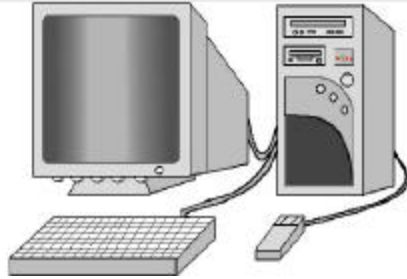



## 4. BIOS Setup

### 4. BIOS Setup



The IN620 motherboard uses AWARD BIOS, which is stored in a Flash EEPROM and can be upgraded by a floppy disk-based program. The BIOS has a built-in Setup Program that allows users to modify the basic system configuration settings. The settings are then stored in a dedicated battery-backed memory, called CMMOS RAM that retains the information when the power is turned off.

The BIOS provides critical low-level support for the system's central processing, memory and I/O subsystems. The AWARD BIOS has been customized by adding important, nonstandard, features such as virus and password protection, power management, and detailed fine-tuning of the chipset which controls the system. The remainder of this manual is intended to guide you through the process of configuring your system using the BIOS Setup.

#### 4.1 BIOS Setup

The AWARD BIOS is immediately activated when you first turn on the computer. The BIOS reads system configuration information in CMOS RAM and begins the process of checking the system and configuring it through the power-on self test (POST). When these preliminaries are finished, the BIOS seek an operation system on the data storage devices (hard drive, floppy drive, etc.). The BIOS launches the operating system and hands over control of system operation to it.

To start Setup, press the <Del> key during boot-up before or while a message similar to this appears briefly at the bottom of the screen during POST (Power On Self Test):

**Press DEL if you want to enter SETUP**

If the above message disappears before you have responded and you still wish to enter Setup, reboot the system to try again by pressing the "RESET" button on the system case. You may also restart by simultaneously pressing the <Ctrl>, <Alt> and <Delete> keys.

Press **F1** to continue, **DEL** to enter SETUP.

# 4. BIOS Setup

## 4.1.1 Setup Keys

The keys below help you navigate in Setup.

<↑> , <↓>	Move to previous or next item
<←> , <→>	Move to the item in the left or right hand
<Esc>	Main Menu – Quit and not save changes into CMOS Other Pages -- Exit current page and return to Main Menu
<PgUp> / <+>	Increase the numeric value or make changes
<PgDn> / <->	Decrease the numeric value or make changes
<F1>	General help, only for Status Page Setup Menu and Option Page Setup Menu
<F2>	Change color from total 16 colors. F2 to select Shift-F2 color forward, Shift-F2 to select color backward
<F3>	Calendar, only for Status Page Setup Menu
<F5>	Restore the previous CMOS value from CMOS, only for Option Page Setup Menu
<F7>	Load the Setup default
<F10>	Save all the CMOS changes, only for Main Menu

## 4.1.2 Getting Help

Press F1 to pop up a small help window that describes the appropriate keys to use and the possible selections for the highlighted item. To exit the Help Window press Esc or the F1 key again.

## 4.1.3 In Case of Problems

If after making and saving system changes with Setup, you discover that your computer no longer is able to boot, the Award BIOS supports an override to the CMOS settings that resets your system to its default configuration.

The best advice is to alter only settings that you thoroughly understand. In particular, do not change settings in the Chipset screen without a good reason. BCM Advanced Research Inc. or your system manufacturer for the best performance and reliability has carefully chosen the Chipset defaults. Even a seemingly small change to the Chipset setup may cause the system to become unstable.

## 4.2 Main Setup Menu

When you enter the Award BIOS CMOS Setup Utility, a Main Menu (Figure 1) appears on the screen. The Main Menu allows you to select from several Setup functions and two exit

## 4. BIOS Setup

choices. Use the arrow keys to select among the items and press Enter to accept and enter the sub-menu.

A brief description of each highlighted selection appears at the bottom of the screen.

ROM PCI/ISA BIOS (2A5KKG5C) CMOS SETUP UTILITY AWARD SOFTWARE, INC.	
<b>STAND CMOS SETUP</b> BIOS FEATURES SETUP CHIPSET FEATURES SETUP POWER MANAGEMENT SETUP PNP/PCI CONFIGURATION LOAD SETUPDEFAULTS	INTEGRATED PERIPHERALS USER PASSWORD IDE HDD AUTO DETECTION SAVE & EXIT SETUP EXIT WITHOUT SAVING
ESC: QUIT <span style="float: right;">i Ⓟ Ⓡ Ⓢ Select Item</span>	
F10: Save & Exit Setup <span style="float: right;">(Shift) F2: Change Color</span>	
Time, Date, Hard Disk Type	

Figure 1: Main Menu

Following is a brief summary of each Setup category.

Standard CMOS	Options in the original PC AT-compatible BIOS.
BIOS Features	Award enhanced BIOS options.
Chipset Features	Options specific to your system chipset.
Power Management	Advanced Power Management (APM) options.
PnP/PCI Configuration	Plug and Play standard and PCI Local Bus configuration options.
Integrated Peripherals	I/O subsystems that depend on the integrated peripherals controller in your system.
Supervisor/User Password Setting	Change, set, or disable a password. In BIOS versions that allow separate user and supervisor passwords, only the supervisor password permits access to Setup. The user password generally allows only power-on access.
IDE HDD Auto Detection	Automatically detect and configure IDE hard disk parameters.
Load Setup Defaults	Setup defaults are factory settings for optimal-performance system operations.
Save & Exit Setup	Save settings in nonvolatile CMOS RAM and exit Setup.
Exit Without Save	Abandon all changes and exit Setup.

# 4. BIOS Setup

## 4.3 Standard CMOS Setup Menu

In the Standard CMOS Menu (Figure 2) you can set the system clock and calendar, record disk drive parameters and the video subsystem type, and select the type of errors that stop the BIOS POST.

The screenshot shows the 'Standard CMOS Setup Utility' menu. At the top, it reads 'ROM PCI/ISA BIOS (2A5KKG5C) CMOS SETUP UTILITY AWARD SOFTWARE, INC.'. Below this, the date is 'Wed, Jun 4, 1997' and the time is '8:53:11'. A table lists 'HARD DISKS' with columns for TYPE, SIZE, CYLS, HEAD, PRECOMP, LANDZ, SECOTR, and MODE. The table shows settings for Primary Master, Primary Slave, Secondary Master, and Secondary Slave, all set to 'Auto'. Below the table, drive information is shown: 'Drive A: 1.44M, 3.5in.', 'Drive B: None', 'Video: EGA/VGA', and 'Halt on: All, But'. A memory summary box shows 'Base Memory: OK', 'Extended Memory: OK', 'Other Memory: 512K', and 'Total Memory: 512K'. At the bottom, navigation instructions are provided: 'Esc: Quit', 'F10: Save & Exit Setup', 'i, j, k, l: Select Item', and 'PU/PD/+/-: Modify (Shift) F2: Change Color'. Navigation icons are shown around the screen: 'Move to items' (arrow keys), 'Modify values' (Page Up/Down), 'Enter Sub-Menu' (Enter), and 'Exit to Main Menu' (Esc).

HARD DISKS	TYPE	SIZE	CYLS	HEAD	PRECOMP	LANDZ	SECOTR	MODE
Primary Master:	Auto	0	0	0	0	0	0	Auto
Primary Slave:	Auto	0	0	0	0	0	0	Auto
Secondary Master:	Auto	0	0	0	0	0	0	Auto
Secondary Slave:	Auto	0	0	0	0	0	0	Auto

Drive A:	1.44M, 3.5in.
Drive B:	None
Video:	EGA/VGA
Halt on:	All, But
Base Memory:	OK
Extended Memory:	OK
Other Memory:	512K
Total Memory:	512K

Esc: Quit  
F10: Save & Exit Setup  
i j k l Select Item  
(Shift) F2: Change Color  
PU/PD/+/-: Modify

Figure 2: Standard CMOS Setup

### 4.3.1 Date

The BIOS determines the day of the week from the other date information. This field is for information only. Press the left or right arrow key to move to the desired field (date, month, year). Press the PgUp or PgDn key to increment the setting, or type the desired value into the field.

### 4.3.2 Time

The time format is based on the 24-hour military-time clock. For example, 1 p.m. is 13:00:00. Press the left or right arrow key to move to the desired field. Press the PgUp or PgDn key to increment the setting, or type the desired value into the field.

### 4.3.3 Hard Disks

The BIOS supports up to four IDE drives. This section does not show information about other IDE devices, such as a CD-ROM drive, or about other hard drive types, such as SCSI drives.

## 4. BIOS Setup

**NOTE:** We recommend that you select type AUTO for all drives.

The BIOS can automatically detect the specifications and optimal operating mode of almost all IDE hard drives. When you select type AUTO for a hard drive, the BIOS detects its specifications during POST, every time the system boots.

If you do not want to select drive type AUTO, other methods of selecting the drive type are available:

1. Match the specifications of your installed IDE hard drive(s) with the preprogrammed values for drive types 1 through 45.
2. Select USER and enter values into each drive parameter field.
3. Use the IDE HDD AUTO DETECTION function in Setup.

Here is a brief explanation of drive specifications:

- **Type:** The BIOS contains a table of pre-defined drive types. Each defined drive type has a specified number of cylinders, number of heads, write precompensation factor, landing zone, and number of sectors. Drives whose specifications do not accommodate any pre-defined type are classified as type USER.
- **Size:** Disk drive capacity (approximate). Note that this size is usually slightly greater than the size of a formatted disk given by a disk-checking program.
- **Cyls:** Number of cylinders
- **Head:** Number of heads
- **Precomp:** Write precompensation cylinder
- **Landz:** Landing zone
- **Sector:** Number of sectors
- **Mode:** Auto, Normal, large, or LBA
- **Auto:** The BIOS automatically determines the optimal mode.
- **Normal:** Maximum number of cylinders, heads, and sectors supported are 1024, 16 and 63.
- **Large:** For drives that do not support LBA and have more than 1024 cylinders.
- **LBA (Logical Block Addressing):** During drive accesses, the IDE controller
- **Transforms the data address described by sector, head, and cylinder number**
- **into a physical block address, significantly improving data transfer rates. For drives with greater than 1024 cylinders.**

## 4. BIOS Setup

### 4.3.4 Drive A/B type

Select the correct specifications for the diskette drive(s) installed in the computer.

None	No diskette drive installed
360K, 5.25 in	5-1/4 inch PC-type standard drive; 360 kilobyte capacity
1.2M, 5.25 in	5-1/4 inch AT-type high-density drive; 1.2 megabyte capacity
720K, 3.5 in	3-1/2 inch double-sided drive; 720 kilobyte capacity
1.44M, 3.5 in	3-1/2 inch double-sided drive; 1.44 megabyte capacity
2.88M, 3.5 in	3-1/2 inch double-sided drive; 2.88 megabyte capacity

### 4.3.5 Video

Select the type of primary video subsystem in your computer. The BIOS usually detects the correct video type automatically. The BIOS supports a secondary video subsystem, but you do not select it in Setup.

EGA/VGA	Enhanced Graphics Adapter/Video Graphics Array. For EGA, VGA, SEGA, SVGA or PGA monitor adapters.
CGA 40	Color Graphics Adapter, power up in 40 column mode.
CGA 80	Color Graphics Adapter, power up in 80 column mode.
MONO	Monochrome adapter, includes high resolution monochrome adapters.

### 4.3.6 Halt on

During the power-on self-test (POST), the computer stops if the BIOS detect a hardware error. You can tell the BIOS to ignore certain errors during POST and continue the boot-up process. Below are the selections:

No errors	POST does not stop for any errors.
All errors	If the BIOS detect any non-fatal error, POST stops and prompts you to take corrective action.
All, But Keyboard	POST does not stop for a keyboard error, but stops for all other errors.
All, But Diskette	POST does not stop for diskette drive errors, but stops for all other

## 4. BIOS Setup

	errors.
All, But Disk/Key	POST does not stop for a keyboard or disk error, but stops for all other errors.

### 4.3.7 Memory

You cannot change any values in the Memory fields; they are only for your information. The fields show the total installed random access memory (RAM) and amounts allocated to base memory, extended memory, and other (high) memory. RAM is counted in kilobytes (KB: approximately one thousand bytes) and megabytes (MB: approximately one million bytes).

RAM is the computer's working memory, where the computer stores programs and data currently being used, so they are accessible to the CPU. Modern personal computers may contain up to 64 MB, 128 MB, or more.

#### **Base Memory**

Typically 640 KB. Also called conventional memory. The DOS operating system and conventional applications use this area.

#### **Extended Memory**

Above the 1-MB boundary. Early IBM personal computers could not use memory above 1 MB, but current PCs and their software can use extended memory.

#### **Other Memory**

Between 640 KB and 1 MB; often called High memory. DOS may load terminate-and-stay-resident (TSR) programs, such as device drivers, in this area, to free as much conventional memory as possible for applications. Lines in your CONFIG.SYS file that start with LOADHIGH load programs into high memory.

#### **Total Memory**

System total memory is the sum of base memory, extended memory, and other memory.

# 4. BIOS Setup

## 4.4 BIOS Features Setup Menu

This screen (Figure 3) contains industry-standard options additional to the core PC AT BIOS. This section describes all fields offered by Award Software in this screen. Some fields may vary from those in your Setup program. Your system board designer may omit or modify some fields.

ROM PCI/ISA BIOS (2A5KKG5C)  
CMOS SETUP UTILITY  
AWARD SOFTWARE, INC.

Virus Warning	: Disabled	Video BIOS Shadow	: Enabled
CPU Internal Cache	: Enabled	C8000-CBFFF Shadow	: Disabled
External Cache	: Enabled	CC000-CFFF Shadow	: Disabled
Quick Power On Self Test	: Enabled	D0000-D3FFF Shadow	: Disabled
Boot Sequence	: A, C, SCSI	D4000-D7FFF Shadow	: Disabled
Swap Floppy Drive	: Disabled	D8000-DBFFF Shadow	: Disabled
Boot Up NumLock Status	: On	DC000-DFFFF Shadow	: Disabled
Boot Up System Speed	: High		
Gate A20 Option	: Fast		
Typematic Rate Settings	: Disabled		
Typematic Rate(Chars/Sec.)	: 6		
Typematic Delay (Msec)	: 250		
Security Option	: System		
PCI/VGA Palette Snoop	: Disabled		
Assign IRQ for VGA	: Enabled		
OS Select For DRAM>64MB	: Non-OS2		
Report No FDD For WIN95	: No		

ESC: Quit      i     $\phi$      $\mp$      $\circ$   
F1: Help      j     $\square$ Select Item  
F5: Old value    PU/PD +/-: Modify  
F7: Load Setup Defaults    (Shift)F2: Color

Figure 3: BIOS Features Setup Menu

### 4.4.1 Virus Warning

When enabled, you receive a warning message if a program (specifically, a virus) attempts to write to the boot sector or the partition table of the hard disk drive. You should then run an anti-virus program. Keep in mind that this feature protects only the boot sector, not the entire hard drive.

**NOTE:** Many disk diagnostic programs that access the boot sector table can trigger the virus warning message. If you plan to run such a program, we recommend that you first disable the virus warning.

### 4.4.2 CPU Internal Cache

Cache memory is additional memory that is much faster than conventional DRAM (system memory). Some CPU integrate a build-in Cache memory to speed up the data transfer. This item allows you to enable or disable the inter Cache.



## 4. BIOS Setup

### 4.4.3 External Cache

Cache memory is additional memory that is much faster than conventional DRAM (system memory). When the CPU requests data, the system transfers the requested data from the main DRAM into cache memory, for even faster access by the CPU. The External Cache field may not appear if your system does not have external cache memory.

### 4.4.4 Quick Power On Self Test

This allows you to enable or disable system self test when power on.

### 4.4.5 Boot Sequence

The original IBM PCs loaded the DOS operating system from drive A (floppy disk), so IBM PC-compatible systems are designed to search for an operating system first on drive A, and then on drive C (hard disk). However, the BIOS now offers 10 different boot sequence options of three drives each. In addition to the traditional drives A and C, options include IDE hard drives D, E, and F; plus a SCSI hard drive and a CD-ROM drive.

### 4.4.6 Swap Floppy Drive

This field is effective only in systems with two floppy drives. Selecting Enabled assigns physical drive B to logical drive A, and physical drive A to logical drive B.

### 4.4.7 Boot Up Floppy Seek

When *Enabled*, the BIOS tests (seeks) floppy drives to determine whether they have 40 or 80 tracks. Only 360-KB floppy drives have 40 tracks; drives with 720 KB, 1.2 MB, and 1.44 MB capacity all have 80 tracks. Because very few modern PCs have 40-track floppy drives, we recommend that you set this field to *Disabled* to save time.

### 4.4.8 Boot Up NumLock Status

Toggle between *On* or *Off* to control the state of the NumLock key when the system boots. When toggled *On*, the numeric keypad generates numbers instead of controlling cursor operations.

### 4.4.9 Boot Up System Speed

This item allows you to set the boot speed of your system.

### 4.4.10 Typematic Rate Setting

When *Disabled*, the following two items (Typematic Rate and Typematic Delay) are irrelevant. Keystrokes repeat at a rate determined by the keyboard controller in your system. When *Enabled*, you can select a typematic rate and typematic delay.

## 4. BIOS Setup

### 4.4.11 Typematic Rate (Chars/Sec)

When the typematic rate setting is enabled, you can select a typematic rate (the rate at which character repeats when you hold down a key) of 6, 8, 10,12, 15, 20, 24 or 30 characters per second.

### 4.4.12 Typematic Delay (Msec)

When the typematic rate setting is enabled, you can select a typematic delay (the delay before key strokes begin to repeat) of 250, 500, 750 or 1000 milliseconds.

### 4.4.13 Security Option

If you have set a password, select whether the password is required every time the System boots, or only when you enter Setup.

### 4.4.14 PCI/VGA Palette Snoop

Some display cards that are not standard VGA such as graphics accelerators or MPEG cards may not show the correct colors, the setting can correct this problem once you set it to Enabled, to default setting leave at Disabled.

### 4.4.15 Assign IRQ For VGA

Set this option to Yes to allocate an IRQ to VGA device on the PCI Bus. The setting are Enabled or Disabled.

### 4.4.16 OS select for DRAM > 64MB

Select *OS2* only if you are running OS/2 operating system with greater than 64 MB of RAM on your system.

# 4. BIOS Setup

## 4.5 Chipset Features Setup Menu

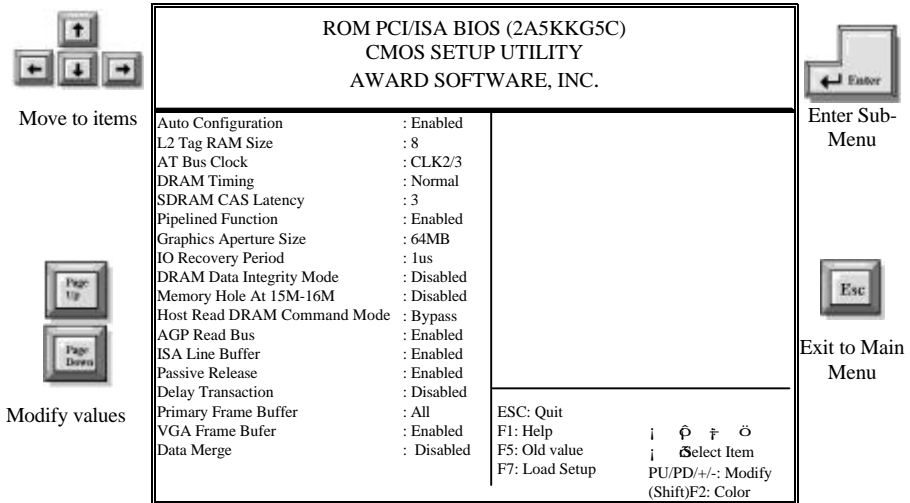

Figure 4: Chipset Features Setup Menu

### 4.5.1 Auto Configuration

This item allows you to select pre-determined optimal values for DRAM, cache and timing according to CPU type & system clock. The choice: Enabled, Disabled.

**Note:** When this item is enabled, the pre-defined items will become SHOW-ONLY

### 4.5.2 L2 TAG RAM Size

The system uses tag bits to determine the status of data in the L2 cache. Set this field to match the specifications (8 or 10 bits) of the installed tag RAM chip. The Choice: 8,10.

### 4.5.3 AT Bus Clock

You can set the speed of the AT bus in terms of a fraction of the CPU clock speed (PCLK2), or at the fixed speed of 7.16 MHz.

The Choice: 7.16 MHz, CLK2/2, CLK2/3, CLK2/4, CLK2/5, and CLK2/6

### 4.5.4 DRAM Timing

The value in this field depends on performance parameters of the installed memory chips (DRAM). Do not change the value from the factory setting unless you install new memory that has a different performance rating than the original DRAMs. The Choice: Normal, Fast,

## 4. BIOS Setup

Slow.

### 4.5.5 SDRAM CAS Latency

When synchronous DRAM is installed, the number of clock cycles of CAS latency depends on the DRAM timing. Do not reset this field from the default value specified by the system designer. The Choice: 2, 3.

### 4.5.6 Pipelined Function

When *Enabled*, the controller signals the CPU for a new memory address before all data transfers for the current cycles are complete, resulting in faster performance. The Choice: Enabled, Disabled.

### 4.5.7 Graphics Aperture Size

Select the size of the Accelerated Graphics Port (AGP aperture). The aperture is a portion of the PCI memory address range dedicated for graphics memory address space. Host cycles that hit the aperture range are forwarded to the AGP without any translation.

### 4.5.8 DRAM Data Integrity Mode

Select *Parity* or *ECC* (error-correcting code), according to the type of installed DRAM. The Choice: Disabled, ECC, Parity.

### 4.5.9 Memory Hole At 15M-16M

You can reserve this area of system memory for ISA adapter ROM. When this area is reserved, it cannot be cached. The user information of peripherals that need to use this area of system memory usually discusses their memory requirements.

### 4.5.10 Host Read DRAM Command Mode

This item allows you to select the type of Host Read DRAM Command Mode. The choices are: Syn., Bypass.

### 4.5.11 ISA Line Buffer

The PCI to ISA Bridge has an 8-byte bi-directional line buffer for ISA or DMA bus master memory reads from or writes to the PCI bus. When *Enabled*, an ISA or DMA bus master can prefetch two doublewords to the line buffer for a read cycle.

The choices are: Enabled, Disabled

### 4.5.12 Passive Release

When *Enabled*, CPU to PCI bus accesses is allowed during passive release. Otherwise, the arbiter only accepts another PCI master access to local DRAM.

The choice : Enabled , Disabled.

## 4. BIOS Setup

### 4.5.13 Delay Transaction

The chipset has an embedded 32-bit posted write buffer to support delay transactions cycles. Select *Enabled* to support compliance with PCI specification version 2.1.

The choices are: Enabled, Disabled

### 4.5.14 Primary Frame Buffer

Select a size for the PCI frame buffer. The size of the buffer should not impinge on local memory.

The choices are: Disabled, 2MB 4MB, 8MB, 16MB.

### 4.5.15 VGA Frame Buffer

When *Enabled*, a fixed VGA frame buffer from A000h to BFFFh and a CPU-to-PCI write buffer are implemented.

The choices are: Enabled , Disabled.

### 4.5.16 Data Merge

This field controls the word-merge feature for frame buffer cycles. When Enabled, this controller checks the eight CPU Byte Enable signals to determine if data words read from the PCI bus by the CPU can be merged. The choice: Enabled , Disabled.

### 4.5.17 Shutdown Temperature

When the temperature of CPU is over specified value. The system will send a signal to O/S to shut down the system.

### 4.5.18 CPU Warning Temperature

This item presents the current hardware situation for the hardware monitoring feature of this motherboard. Here you can Enable or Disabled the function.

# 4. BIOS Setup

## 4.6 Power Management Setup Menu

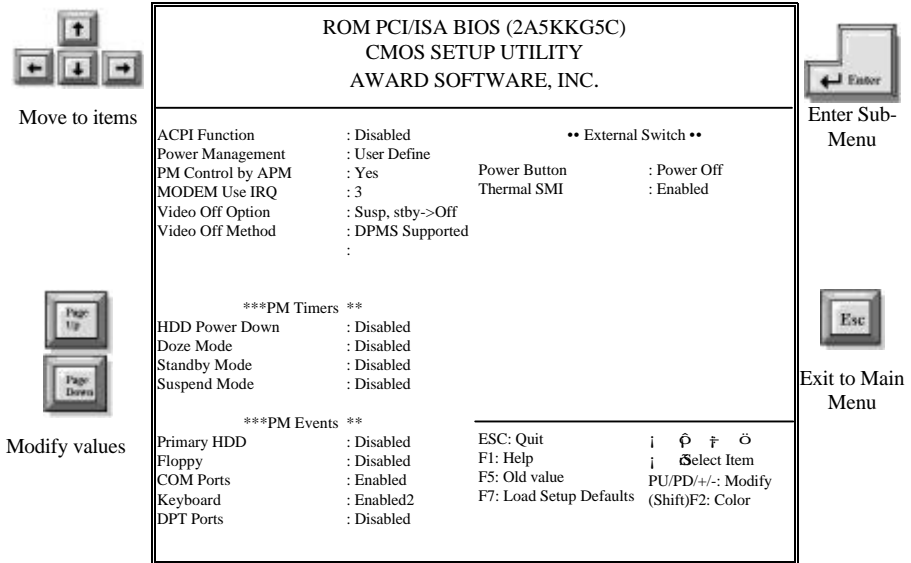

Figure 5: Power Management Setup Menu

### 4.6.1 ACPI function

ACPI (Advanced Configuration and Power Interface) evolves the existing motherboard configuration interfaces to support these advanced architectures in a more robust, and potentially more efficient manner.

### 4.6.2 Power Management

This option allows you to select the type (or degree) of power saving for Doze, Standby, and Suspend modes. See the section *PM Timers* for a brief description of each mode. This table describes each power management mode:

Disable	Global Power Management will be disabled
Max Saving	Maximum power savings. <b>Only Available for SL CPUs.</b> Inactivity period is 1 minute in each mode.
User Define	Set each mode individually. Select time-out periods in the <i>PM Timers</i> section, following.
Min Saving	Minimum power savings. Inactivity period is 1 hour in each mode (except the hard drive).

# 4. BIOS Setup

## 4.6.3 PM Control by APM

When enabled, an Advanced Power Management device will be activated to enhance the Max. Power Saving mode and stop the CPU internal clock. If Advance Power Management (APM) is installed on your system, selecting Yes gives better power savings.

If the Max. Power Saving is not enabled, this will be preset to *No*.

## 4.6.4 Modem Use IRQ

This determines the IRQ in which the MODEM can use. The choices are: 3, 4, 5, 7, 9, 10, 11, NA.

## 4.6.5 Video Off Option

When enabled, this feature allows the VGA adapter to operate in a power saving mode.

Always On	Monitor will remain on during power saving modes.
Suspend --> Off	Monitor blanked when the systems enters the Suspend mode.
Susp,Stby --> Off	Monitor blanked when the system enters either Suspend or Standby modes.
All Modes --> Off	Monitor blanked when the system enters any power saving mode.

## 4.6.6 Video Off Method

Determines the manner in which the monitor is blanked.

V/H SYNC+Blank	System turns off vertical and horizontal synchronization ports and writes blanks to the video buffer.
DPMS Support	Select this option if your monitor supports the Display Power Management Signaling (DPMS) standard of the Video Electronics Standards Association (VESA). Use the software supplied for your video subsystem to select video power management values.
Blank Screen	System only writes blanks to the video buffer.

## 4.6.7 HDD Power Down

When enabled and after the set time of system inactivity, the hard disk drive will be powered down while all other devices remain active.

## 4.6.8 Doze Mode

When enabled and after the set time of system inactivity, the CPU clock will run at slower speed while all other devices still operate at full speed.

## 4. BIOS Setup

### 4.6.8 Standby Mode

When enabled and after the set time of system inactivity, the fixed disk drive and the video would be shut off while all other devices still operate at full speed.

### 4.6.9 Suspend Mode

When enabled and after the set time of system inactivity, all devices except the CPU will be shut off.

### 4.6.10 Primary HDD / Floppy / COM Ports / Keyboard / LPT Ports

When Enabled, an event occurring on each device listed above restarts the global time for Standby mode.

### 4.6.11 Power Button

This item allows you to select the function of power button. The choices are: Disabled, Green Mode, Power Off.

### 4.6.12 Thermal SMI

This item allows you to enable or disable the function of Sleep. The choices are: Enabled, Disabled.



# 4. BIOS Setup

## 4.7 PCI Configuration Setup Menu

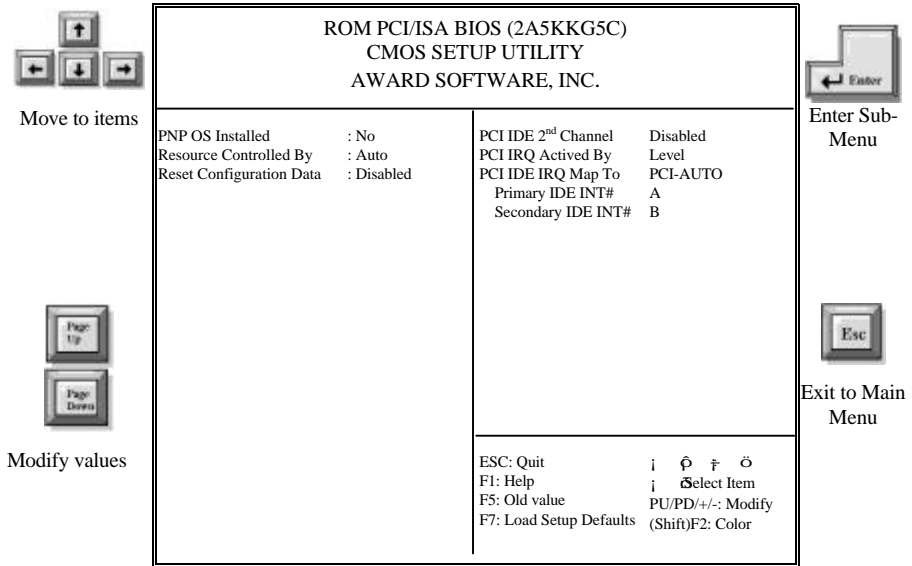

Figure 6: PNP/PCI Configuration Setup Menu

### 4.7.1 PNP OS Installed

This item allows you to determine install PnP OS or not. The choices are: Yes and No

### 4.7.2 Resources Controlled By

The Award Plug and Play BIOS can automatically configure all the boot and Plug and Play-compatible devices. If you select Auto, all the interrupt request (IRQ) and DMA assignment fields disappear, as the BIOS automatically assign them.

### 4.7.3 Reset Configuration Data

Normally, you leave this field Disabled. Select Enabled to reset Extended System Configuration Date (ESCD) when you exit Setup if you have installed a new add-on and the system reconfiguration has caused such a serious conflict that the operating system cannot boot.

### 4.7.4 PCI IDE 2<sup>nd</sup> Channel

The IDE standard supports two channels (interfaces) with two devices on each channel.

## 4. BIOS Setup

Enabled the second channel if your system has two PCI IDE connectors in use, either on the system board or on expansion boards. Disable the second channel if a second IDE connector is not present or not in use.

### 4.7.5 PCI IRQ Activated By

Leave the IRQ trigger set at Level unless the PCI device assigned to the interrupt specifies Edge-triggered interrupts.

### 4.7.6 PCI IDE IRQ Map To

This field lets you select PCI IDE IRQ mapping or PC AT (ISA) interrupts. If your system does not have one or two PCI IDE connectors on the system board, select values according to the type of IDE interface(s) installed in your system (PCI or ISA). Standard ISA interrupts for IDE channels are IRQ14 for primary and IRQ15 for secondary.

### 4.7.7 Primary/Secondary IDE INT#

Each PCI peripheral connection is capable of activating up to four interrupts: INT# A, INT# B, INT# C and INT# D. By default, a PCI connection is assigned INT# A. Assigning INT# B has no meaning unless the peripheral device requires two interrupt services rather than just one. Because the PCI IDE interface in the chipset has two channels, it requires two interrupt services. The primary and secondary IDE INT# fields default to values appropriate for two PCI IDE channels, with the primary PCI IDE channel having a lower interrupt than the secondary.

# 4. BIOS Setup

## 4.8 Integrated peripherals Menu

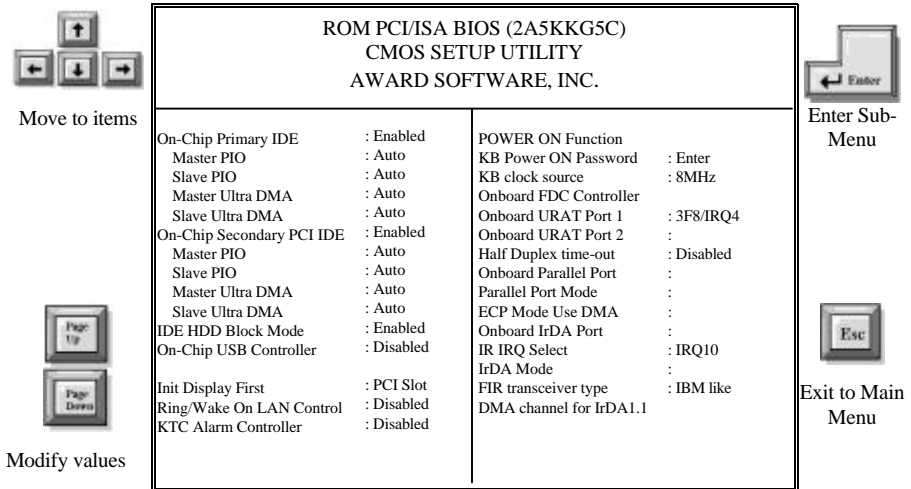

Figure 7: Integrated Peripherals Setup Menu

### 4.8.1 On-chip Primary IDE

The chipset contains a PCI IDE interface with support for two IDE channels. Select Enabled to activate the primary IDE interface. Select Disabled to deactivate this interface. The choices are: Enabled, Disabled.

### 4.8.2 On-Chip Secondary IDE

The chipset contains a PCI IDE interface with support for two IDE channels. Select Enabled to activate the secondary IDE interface. Select Disabled to deactivate this interface. The choices are: Enabled, Disabled.

### 4.8.3 On-Chip Primary/Secondary Master/Slave PIO

The four IDE PIO (Programmed Input/Output) fields let you set a PIO mode (0-4) for each of the four IDE devices that the onboard IDE interface supports. Modes 0 through 4 provide successively increased performance. In Auto mode, the system automatically determines the best mode for each device. The choices are: Auto, Mode 0, Mode 1, Mode 2, Mode 3, Mode 4.

### 4.8.4 On-Chip Primary/Secondary Master/Save UDMA

Ultra DMA/33 implementation is possible only if your IDE hard drive supports it and the operating environment includes a DMA driver (Windows 95 OSR2 or a third-party IDE bus

## 4. BIOS Setup

master driver). If your hard drive and your system software both support Ultra DMA/33, select Auto to enable BIOS support. The choices are: Auto, Mode 0, Mode 1, Mode 2.

### 4.8.5 IDE HDD Block

Block mode is also called block transfer, multiple commands, or multiple sector read/write. If your IDE hard drive supports block mode (most new drives do), select Enabled for automatic detection of the optimal number of block read/writes per sector the drive can support. The choices are: Enabled, Disabled.

### 4.8.6 On-Chip USB Controller

Select Enabled if your system contains a Universal Serial Bus (USB) controller. The choices are: Enabled, Disabled.

### 4.8.7 Ring / Wake On LAN Control

An input signal on the serial ring Indicator (RI) line (in other words, an incoming call on the modem) awakens the system from a soft off state. This option specifies whether the computer responds to an incoming call or not. Wake-On-LAN requires a PCI add-in network interface card with remote wakeup capabilities.

### 4.8.8 Onboard FDC Controller

Select Enabled if your system has a floppy disk controller (FDC) installed on the system board and you wish to use it. If you install and-in FDC or the system has no floppy drive, select Disabled in this field. The choices are: Enabled, Disabled.

### 4.8.9 Onboard UART Port1 / Port 2

This item allows you to determine access onboard serial port 1/port 2 controller with which I/O address. The choices are: 3F8/IRQ4, 2E8/IRQ3, 3E8/IRQ4, 2F8/IRQ3, Disabled, Auto.

### 4.8.10 Onboard Parallel Port

This item allows you to determine access onboard parallel port controller with which I/O address. The choices are: 378H/IRQ7, 278H/IRQ5, 3BC/IRQ7, Disabled.

### 4.8.11 Parallel Port Mode

Select an operating mode for the onboard parallel (printer) port. Select Normal unless your hardware and software require one of the other modes offered in this field. The choice: PS/2, EPP1.9, ECP, ECPEPP1.9, SPP, EPP1.7.

### 4.8.12 ECP Mode Use DMA

Select a DMA channel for the parallel port for use during ECP mode. The choices are: 3, 1.

### 4.8.13 Onboard IrDA Port

IR IRQ Select/ IrDA Mode/ FIR transceiver type/ DMA channel for IrDA1.1 This item

## 4. BIOS Setup

allows you to determine which Infra Red (IR) function of onboard I/O chip.

The choices are: Normal, AS KIR, IrDA and FIR.

### 4.9 Load Setup Defaults

The chipset defaults are settings which provide for maximum system performance. While Award has designed the custom BIOS to maximize performance, the manufacturer has the right to change these defaults to meet their needs.

### 4.10 User Password

When you select this function, a message appears at the center of the screen:

**ENTER PASSWORD:**

Type the password, up to eight characters, and press Enter. Typing a password clears any previously entered password from CMOS memory. Now the message changes:

**CONFIRM PASSWORD:**

Again, type the password and press Enter. To abort the process at any time, press Esc.

In the *Security Option* item in the **BIOS Features Setup** screen select *System or Setup*:

- System: Enter a password each time the system boots and whenever you enter Setup.
- Setup: Enter a password whenever you enter Setup.

**NOTE:** To clear the password, simply press Enter when asked to enter a password. Then the password function is disabled.

### 4.11 IDE HDD Auto Detection

BIOS setup will display all possible modes that supported by the HDD including NORMAL, LBA & LARGE. If HDD does not support LBA modes, no 'LBA' option will be shown. If no of cylinders is less than or equal to 1024, no 'LARGE' option will be show. Users can select a mode which is appropriate for them.

### 4.12 Save & Exit Setup

This feature allows the changes to be made to the CMOS setup to be saved. The system will resume booting after a successful save.

### 4.13 Exit Without Saving

Abandon all CMOS value change without saving.