

Read me first

1. The "**LOAD SETUP DEFAULTS**" function loads the system default data directly from

ROM and initializes the associated hardware properly. This function is necessary

| ROM PCI/ISA BIOS CMOS SETUP UTILITY AWARD SOFTWARE, INC. | |
|--|-----------------------------|
| STANDARD CMOS SETUP | SUPERVISOR PASSWORD |
| BIOS FEATURES SETUP | USER PASSWORD |
| CHIPSET FEATURES SETUP | IDE HDD AUTO DETECTION |
| POWER MANAGEMENT SETUP | HDD LOW LEVEL FORMAT |
| PNP/PCI CONFIGURATION SETUP | LOAD SETUP Default (Y/N)? Y |
| INTEGRATED PERIPHERALS SETUP | SAVING |
| LOAD SETUP DEFAULTS | |
| ESC: QUIT | ↑↓→← :SELECT ITEM |
| F10:Save & Exit Setup | (Shift)F2 :Change Color |
| Load Setup Defaults Except Standard COMS SETUP | |

LOAD SETUP DEFAULT

2. **KBPO(KeyBoard Power On)** Function : There is a basic requirement that the "+5V SB" power of the ATX power supply must be $\geq 0.1A$ (100mA). Please refer to chapter 2-5 for detail.

Apollo MVP3 AGPset

EP-MVP3G-M

ISA/PCI/AGP MainBoard

with Onboard PCI IDE and Super Multi-I/O.

TRADEMARK

All products and company names are trademarks or registered trademarks of their respective holders.

The specification is subject to change without notice.

V040

Components Checklist

Please check your package which should include all items listed below. If you find any item damaged or missed, please contact your supplier.

- ✓ A. (1) One mainboard
- ✓ B. (1) One user's manual
- ✓ C. (1) Floppy ribbon cable
- ✓ D. (1) IDE ribbon cables
- E. (2) PS/2 to AT keyboard connector adapter (optional)
- ✓ F. (1) Ultra_DMA IDE driver diskette
(1) AGP Drivers

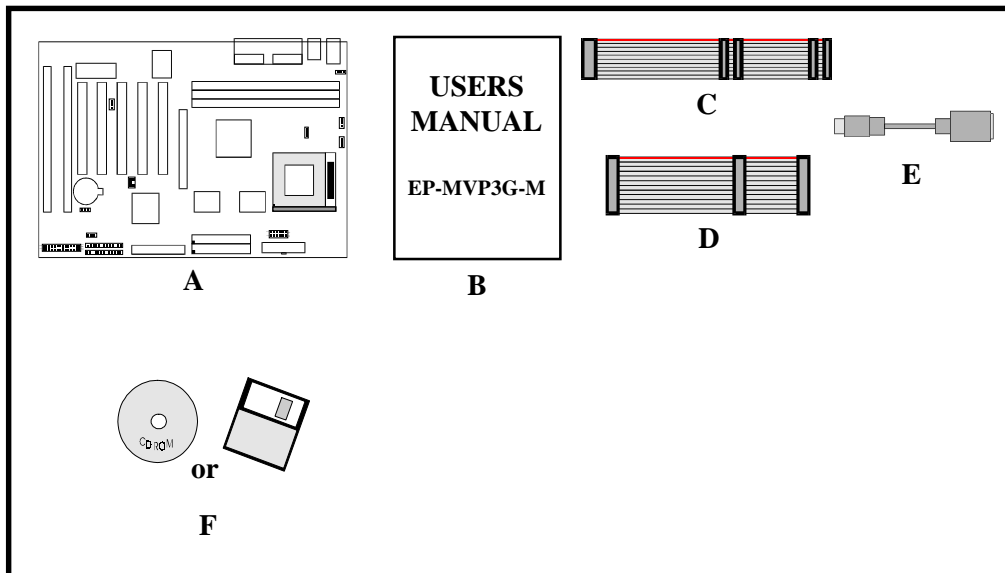

Contents

| | page |
|--|-------------|
| Chapter 1 - Introduction | 1-1 |
| Chapter 2 - Hardware Design | 2-1 |
| 2-1 Mainboard Layout | 2-1 |
| 2-2 Connectors and Jumpers | 2-3 |
| 2-3 System Memory Configuration | 2-5 |
| 2-4 ATX Power ON/OFF Control | 2-6 |
| 2-5 External Modem Ring-in Power ON and Keyboard Power ON Functions | 2-7 |
| 2-6 Integrated PCI Bridge | 2-8 |
| Chapter 3 - Award BIOS Setup | 3-1 |
| 3-1 Standard CMOS Setup | 3-2 |
| 3-3 BIOS Features Setup | 3-2 |
| 3-3 Chipset Features Setup | 3-6 |
| 3-4 Power Management Setup | 3-8 |
| 3-5 PNP/PCI Configuration | 3-10 |
| 3-6 Integrated Peripherals | 3-12 |
| 3-7 Load Setup Defaults | 3-14 |
| 3-8 Change Supervisor or User Password | 3-15 |
| 3-9 IDE HDD Auto Detection | 3-16 |
| 3-10 HDD Low Level Format | 3-18 |
| 3-11 Save & Exit Setup | 3-18 |
| 3-11 Exit Without Saving | 3-18 |
| Chapter 4 - Onboard Technical Information | 4-1 |
| 4-1 I/O & Memory Map | 4-1 |
| 4-2 Time & DMA Channels Map | 4-2 |
| 4-3 Interrupt Map | 4-2 |
| 4-4 RTC & CMOS RAM Map | 4-3 |
| Appendix A: Post Codes | 4-4 |
| Appendix B: Connectors | 4-8 |
| Appendix C: AGP Driver for Win95 Installation Guide | 4-11 |

Chapter 1

Introduction

This mainboard is a high performance system hardware based on Intel Pentium processor and is equipped with an AGP slot, four PCI slots, three standard ISA slots, Super Multi-I/O controller and dual port PCI-IDE connectors for the future expansion. The hardware dimension is 305mm x 200mm with a four-layer-design technology.

Specification

- VIA Apollo MVP3 AGP/PCiset chipset.
- Intel **Pentium**[®] Processor, Pentium Processor with MMX technology, AMD K5/K6, Cyrix 6x86L/6x86MX & *idt* C6 operating at **133 ~ 500 MHz** with **321 ZIF socket 7** provides scalability to accept faster Processors in the future.
- Supports up to 384 MegaBytes of memory (168-Pin DIMM SOCKET x 3)
- Supports 1024KB (Optional) L2 **Cache**.
- Supports two 16 bit ISA slots ,five 32 bit PCI slots and an AGP slot and provides two independent high performance PCI IDE interfaces capable of supporting **PIO Mode 3/4 and Ultra-DMA33** devices.
- Supports **ATAPI** (e.g. **CD-ROM**) devices on both IDE interfaces.
- Supports a floppy port, a parallel port (EPP,ECP port), two serial ports (16550 Fast UART compatible), 2 USB Ports, a PS/2 style mouse connector and a PS/2 style keyboard connector.
- Supports Award Plug & Play BIOS.
- Supports CPU Hardware sleep, APM (Advanced Power Management) and *ACPI (Advanced Configuration Power Interface)*.
- Supports an *ATX power supply connector* for a *Remote On/Off*, a *Phone-Ring Power On* and a *Keyboard Power On* Function.
- Supports *Switching Regulator* for CPU power supply. and *single jumper for CPU working voltage selection*.
- *Supports ESDJ (Easy Setting Dual Jumper) function for CPU selection.*
- *Support hardware monitor function.*

Chapter 2

Hardware design

2-1 Mainboard Layout

This mainboard is designed with VIA Apollo MVP3 AGP/PCIset chipset which is developed by VIA Corporation to fully support Pentium Processor PCI/ISA system. By providing a massive increase in the bandwidth available between the video card and the processor (66MHz), the unique feature of AGP supported by VIA Apollo MVP3 chipset improves the speed of rendering and texturing for 3D graphics. The chipset also provides an integrated IDE controller with two high performance IDE interfaces for up to four IDE devices (hard devices, CD-ROM device, etc). The Winbond W83877TF Super I/O controller provides the standard PC I/O function: one floppy interface, two 16 Byte FIFO serial ports and one EPP/ECP capable parallel port. This mainboard layout is shown in the next page for user's reference. **Care must be taken** when inserting memory modules, CPUs or even plugging PCI card into associated slots to avoid damaging any circuits or sockets on board. A cooling fan is strongly recommended when installing Pentium/Pentium MMX/K5/K6/6x86/6x86L/6x86MX/C6 processor due to possible overheat.

This mainboard supports a minimum of 8MB and a maximum of 384MB of System Memory while Onboard 1024KB cache to increase system performance.

This mainboard supports standard Fast Page, EDO (Extended Data Out or Hyper Page Mode) or synchronous DRAM. **This mainboard** provides two 168-pin DIMM sites for memory expansion. The sockets support 1M x 64(8MB), 2M x 64(16MB), 4M x 64(32MB), and 8M x 64(64MB) single-sided or double-sided memory modules. The memory timing requires 70 ns Fast page devices or 60 ns EDO DRAM. (DRAM Modules may be parity [x 36] or non-parity [x 32]).

This mainboard supports **two Onboard PCI IDE** connectors, and automatically detects IDE harddisk type by BIOS utility automatic.

This mainboard supports Award Plug & Play BIOS for the ISA and PCI cards. The BIOS can be located in Flash EPROM which can replace BIOS code easily if necessary.

EP-MVP3G-M Layout

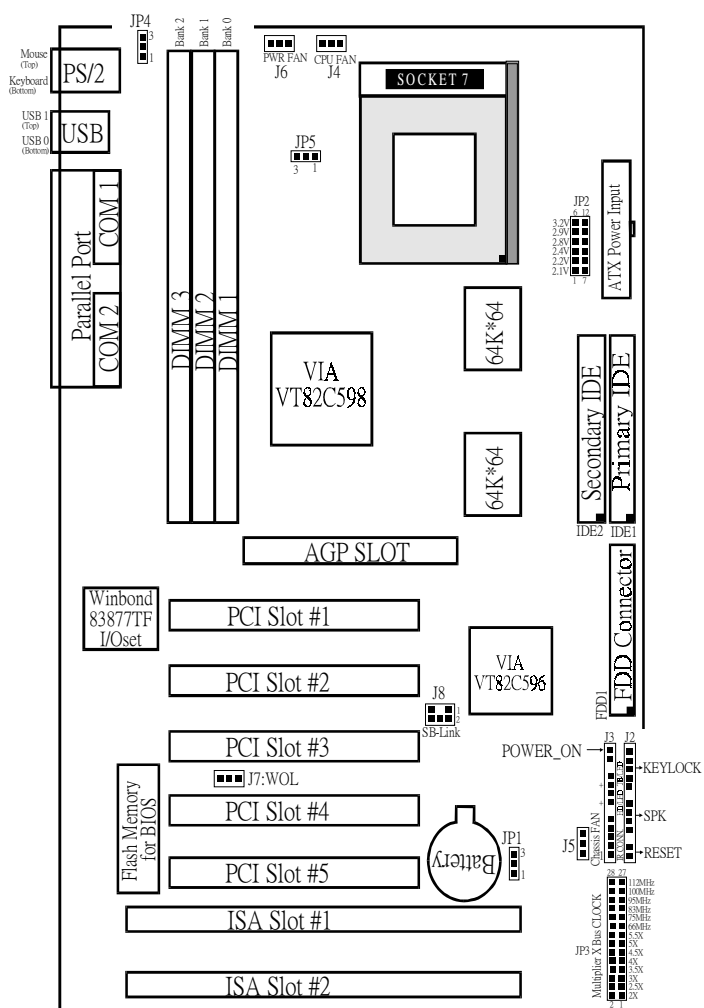

Figure 2-1

2-2 Connectors and Jumpers

This section describes the connectors and jumpers equipped in the mainboard. Please refer to **Figure 2-1** for the location of each connector and jumper.

| JP3 Pentium/MMX AMD K5/K6 idt-C6 | JP3 | | Cyrix / IBM 6x86L/MMX II |
|---|------------|-----------|-----------------------------|
| | Multiplier | Bus CLOCK | |
| 166MHz | 2.5X | 66MHz | MX-PR200 |
| | | 75MHz | MII/MX-PR233 |
| | | 83MHz | MII/MX-PR266 |
| 250MHz | 3X | 100MHz | MII/MX-PR333 |
| 200MHz | | 66MHz | MII/MX-PR233 |
| | | 75MHz | MII/MX-PR266 |
| 250MHz | 3.5X | 83MHz | MII/MX-PR333 |
| 300MHz | | 100MHz | MII/MX-PR350 |
| 200MHz | | 66MHz | MII/MX-PR300 |
| 333MHz | 4X | 75MHz | MII/MX-PR333 |
| 350MHz | | 83MHz | MII/MX-PR350 |
| 266MHz | | 95MHz | |
| | 4.5X | 100MHz | |
| 333MHz | | 66MHz | MII/MX-PR333 |
| 400MHz | | 75MHz | MII/MX-PR350 |
| 300MHz | 5X | 83MHz | |
| 450MHz | | 100MHz | |
| 333MHz | 5.5X | 66MHz | |
| 500MHz | | 100MHz | |
| 366MHz | | 66MHz | |

JP2:

**CPU Vcore voltage selection : For Pentium Processor with MMX technology,
AMD K6 and Cyrix 6x86L/6x86MX/M II**

| 1 7 | |
|-------------|---|
| ■ | 1-7 : 2.1V Reserved |
| ■ ■ | 2-8 : 2.2V for AMD K6-2 (3D) CPUs |
| ■ ■ ■ | 3-9 : 2.4V Reserved |
| ■ ■ ■ ■ | 4-10 : 2.8V for Pentium MMX and Cyrix 6x86L |
| ■ ■ ■ ■ ■ | 5-11 : 2.9V for AMD K6-PR2-166/200MHz and Cyrix 6x86MX/M II |
| ■ ■ ■ ■ ■ ■ | 6-12 : 3.2V for AMD K6-PR2-233MHz |

6 12

Note: 1-7, 2-8 ; 2.3V for AMD K6-2/450MHz

2-4 EP-MVP3G-M

Please install the motherboard into the chassis.

Now that your motherboard is installed you are ready to connect all your connections (figure 2-2).

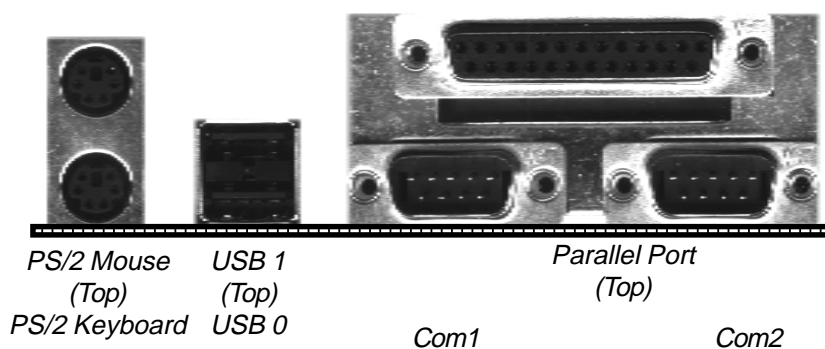
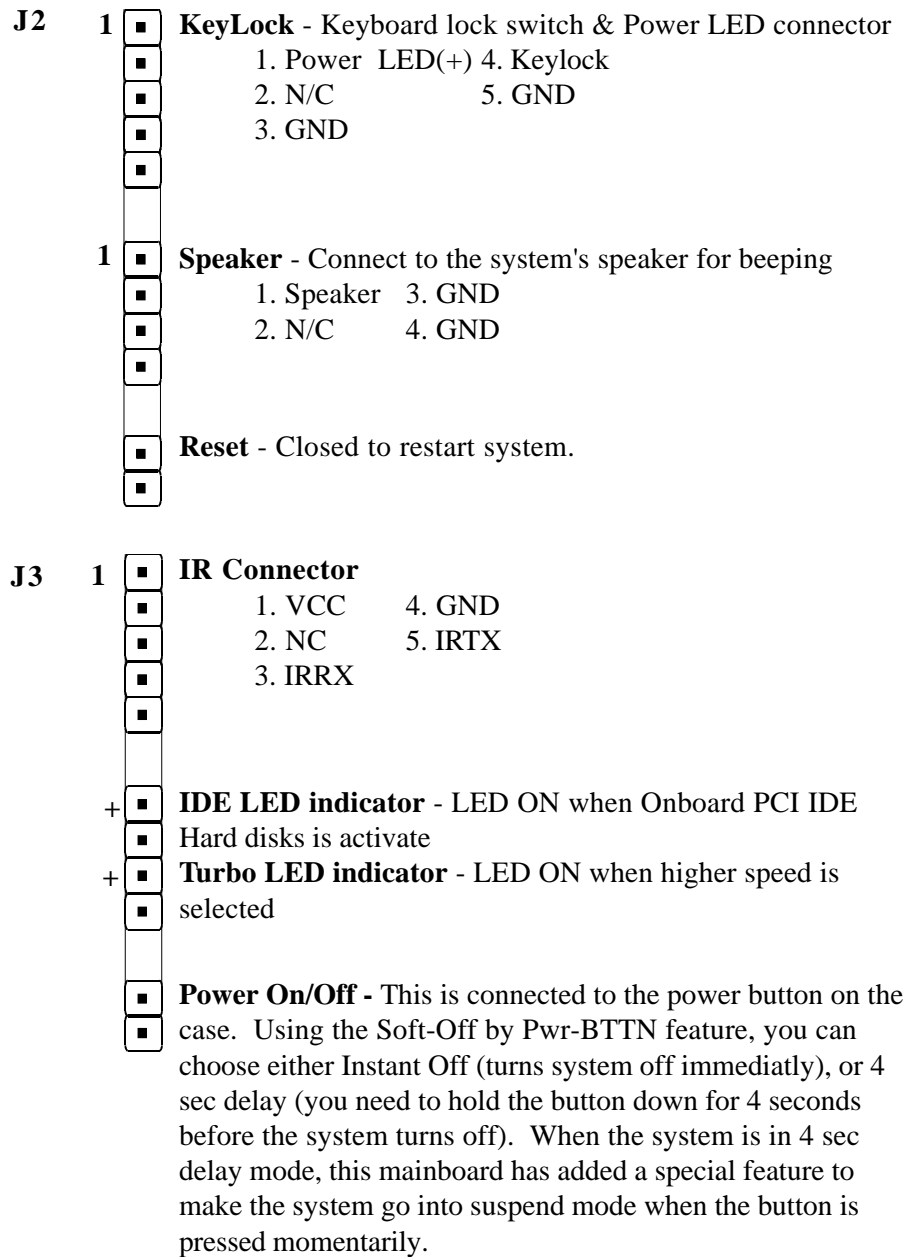

Figure 2-2

- J2:** Keylock, Speaker, Reset
- J3:** IR Conn. TB-LED, HDD-LED, POWER_ON
- J4:** CPU Fan Power
 - A plug-in for the CPU Fan Power
- J5:** POWER Supply FAN POWER
 - A plug-in for Power Supply Fan
- J6:** Chassis Fan Power
 - A Plug-in for the chassis Fan Power
- J7:** WOL (Wake on Lan) Connector
- J8:** SB_Link Header



2-6 EP-MVP3G-M

2-3 System Memory Configuration

This mainboard supports different type of settings for the system memory. The following figures and table provides all possible memory combinations.

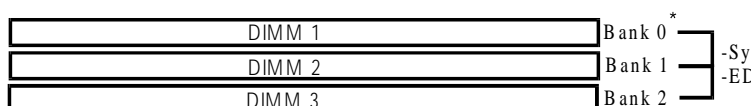

| Total Memory | DIMM 1 (Bank 0) | DIMM 2 (Bank 1) | DIMM 3 (Bank 2) |
|--------------------|---|---|---|
| = 128MB Maximum | EDO/SDRAM* 8MB, 16MB, 32MB, 64MB, 128MB X 1 | None | None |
| = 256MB Maximum | EDO/SDRAM* 8MB, 16MB, 32MB, 64MB, 128MB X 1 | EDO/SDRAM* 8MB, 16MB, 32MB, 64MB, 128MB X 1 | None |
| = 384MB Maximum | EDO/SDRAM* 8MB, 16MB, 32MB, 64MB, 128MB X 1 | EDO/SDRAM* 8MB, 16MB, 32MB, 64MB, 128MB X 1 | EDO/SDRAM* 8MB, 16MB, 32MB, 64MB, 128MB X 1 |

* SDRAM only supports 8, 16, 32, 64, 128MB DIMM modules.

Table 1

This mainboard supports 2 kinds of powerful and flexible SDRAM frequency selections. These can be synchronous with CPU bus clock or fixed as 66MHz. By implementing the VCS (Virtual Clock Synchronization) technology, this mainboard refers to the use of delay-lock-loop (DLL) to enable synchronous and pseudo-synchronous operation of the processor and DRAM, AGP and PCI buses. The JP5 allows user to set the SDRAM Frequency between 66/100MHz.

JP5  1 SDRAM CLOCK Selection
 1-2 : SDRAM = CPU (Default)
 2-3 : SDRAM = AGP (2/3 CPU CLOCK)

Jumper's position:

1-2 : Pseudo-synchronous Status(Fixed as 66MHz)

A more stable and compatible operation condition for non-100MHz based SDRAM when you are using 100MHz based CPU. This setting is suitable for those users who are like to remain the usage of current SDRAM module.

2-3 : Synchronous Status(SDRAM Clock= CPU Bus Clock)

Increasing the bus speeds from the traditional 66MHz to 100MHz greatly improves system performance because the speed at which data traveling between the CPU and memory is increased by 50%. However, there is one thing you should bear in mind.

Please make sure you are using 125MHz(-8) based or above SDRAM module.

2-4 ATX Power ON/OFF Control

This mainboard equips an ATX power connector which is a single 20-PIN input device for an ATX power supply (see Figure 2-2). An ATX power supply provides a build-in Remote Power ON/OFF function. To implement the function, a momentary switch which is normally open should be connected to the position J3(PIN 12, 13) as the system's power ON/OFF button. Note that an AT power supply does not offer this function.

Based on the ATX power connector, this mainboard has been designed to support both *ACPI* and *Soft-OFF* functions. According to the definition of *ACPI*, a *Suspend mode* will be enabled while you push the J3(system power ON/OFF) button less than 4 seconds. Nevertheless, the system will be turned off by pressing for more than 4 seconds. Regarding the *Soft-OFF*(coming from this mainboard onboard circuit controller), it is another way to turn off your system. Your system can be shut down automatically by an operation system such as Windows 95.

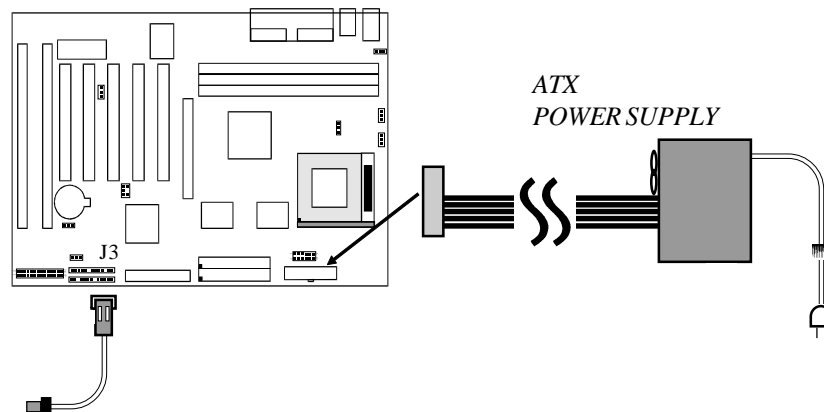

EP-MVP3G-M Board

Case (chassis) Power
ON/OFF momentary button (J3)

Figure 2-2: Simple ATX Power ON/OFF Controller

2-5 External Modem Ring-in Power ON Functions

On the basis of bounded functions in I/O chipset, the two serial ports are able to support the External Modem Ring-in Power ON function. Once users connect the external modem to COM1 or COM2, this mainboard mainboard allows users to turn on their system through the remote and host's dial-up control.

2-5 External Modem Ring-in Power ON and Keyboard Power ON Functions

On the basis of bounded functions in I/O chipset, the two serial ports are able to support the External Modem Ring-in Power ON function. Once users connect the external modem to COM1 or COM2, this mainboard mainboard allows users to turn on their system through the remote and host's dial-up control.

Exclusive Keyboard Power ON Function

To innovate a unique feature to benefit users, we devoted ourselves to create the easiest and most convenient way to turn on your system based on the the ATX power supply. This function is available only under system being connected to ATX power supply.

How to work with it

Step 1: Please place JP4 at the position 2-3 after you finished the system installation.

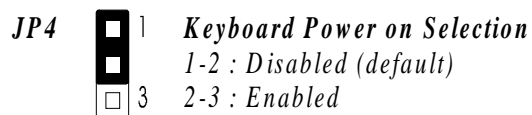

Step 2: You can enjoy the Keyboard Power ON function by *pressing any 1 or 2 keys on you keyboard at the same time* for 1-2 seconds. Your system will be turned on automatically, after releasing the keys. To power off you system, you can use the Soft-OFF function under Windows 95.

Notes:

1. The number of keys needed to turn on a system depends on the model of keyboard you are applying due to different loadings on different keyboards. Here, we would like to suggest you push 2 keys at the same time..
2. Intel ATX version 2.0 specification has recommended you use the power supply with 0.72A(720mA). With our EP-MVP3G-M mainboard, *the 5.0VSB standby power only has to be $\geq 0.1A$ (100mA)* then you can enjoy this unique benefit. However, the ATX power supply which is < 0.1 (100mA) is still applicable to your system by placed JP4 at the position 1-2 to disable this feature.

2-6 Integrated PCI Bridge

This **mainboard** utilizes **VIA Apollo MVP3 AGP/PCIsset** chipset to support Intel Pentium Processor PCI/ISA system. The VIA Apollo MVP3 PCIsset chipset consists of the 82C598AT system controller (TSC), and one 82C596B PCI ISA/IDE Accelerator bridge chip. It provides an interface which translates CPU cycle into PCI bus cycle, and PCI burst read/write capability. In addition, it provides high performance PCI arbitor to support four PCI Masters, Rotating Priority Mechanism, and Hidden Arbitration Scheme Minimizes Arbitration Overhead.

There are four interrupts in each PCI slot : INTA#, INTB#, INTC#, and INTD#. Since this mainboard adapts the PCI auto-configuration with the system BIOS Setup utility. When the system is turned on after adding a PCI add-in card, the BIOS automatically configure interrupts, DMA channels, I/O space, and other paramaters. You do not have to configure jumpers or worry about potential resource conflicts. Because PCI cards use the same interrupt resource as ISA cards, you must specify the interrupt used by ISA add-in cards in the BIOS Setup utility.

However, if a "Legacy card" (such as plugging a paddle card and cable into an ISA slot) is plugged in the system, modification in the **ROM SETUP UTILITY** becomes necessary. First of all, you must enter **PCI CONFIGURATION SETUP** utility from the **ROM SETUP UTILITY** main menu to set "ISA" for the "**PCI IDE IRQ MAP TO**

Secondly, you must enter the **CHIPSET FEATURES SETUP UTILITY** from the **ROM SETUP UTILITY** main menu and set "Disabled" for the "**Onboard Primary PCI IDE**" and the **Onboard Secondary PCI IDE**. When you plug PCI/ISA IDE cards into the system, You should select "Disabled" for the **Onboard Primary and Secondary PCI IDE** from the **CHIPSET FEATURES SETUP UTILITY** too.

You can set the system interrupt request (IRQ) on some "Legacy cards" which have on paddle card and cable. (refer to user's manual of the card) to a proper system IRQ level (In general, card's Primary is assigned to INTA and Secondary is assigned to INTB). If the card is plugged into slot 1 (marked PCI#1), you cannot use second slot (marked PCI#2) because the Secondary INT signal takes INTB from the slot (refer to Page 3-12 for circuit diagram). The user then enters the **PCI CONFIGURATION SETUP** utility from the **ROM SETUP UTILITY** main menu and set "PCI-Slot 1" for the "**PCI IDE IRQ MAP TO**" (This depends on the slot # where the Legacy card is plugged).

CHAPTER 3

AWARD BIOS SETUP

Award's ROM BIOS provides a built-in setup program which allows user to modify the basic system configurations and hardware parameters. The modified data will be stored in a battery-backed CMOS RAM so that data will be retained even when the power is turned off. In general, the information saved in the CMOS RAM stays unchanged unless there is a configuration change in the system, such as a hard drive replacement or a new device installation.

If this does happen, you will need to reconfigure your configuration parameter.

To Enter Setup Program

Power on the computer and press key immediately. This will bring you into BIOS CMOSSETUPUTILITY.

| ROMPCI/ISA BIOS(2A5LEPAD) CMOSSETUPUTILITY AWARDSOFTWARE, INC. | |
|--|--------------------------|
| STANDARD CMOS SETUP | SUPERVISOR PASSWORD |
| BIOS FEATURES SETUP | USER PASSWORD |
| CHIPSET FEATURES SETUP | IDE HDD AUTO DETECTION |
| POWER MANAGEMENT SETUP | HDD LOW LEVEL FORMAT |
| PNP/PCI CONFIGURATION | SAVE & EXIT SETUP |
| INTEGRATED PERIPHERALS | EXIT WITHOUT SAVING |
| LOAD SETUP DEFAULTS | |
| ESC : QUIT | ↑ ↓ → ← : SELECT ITEM |
| F10 : Save & Exit Setup | (Shift)F2 : Change Color |
| Time, Date, Hard Disk Type... | |

Figure 3-1 CMOSSETUPUTILITY

The menu displays all major selection items. Select the item you need to reconfigure. The selection is made by moving cursor (press any direction key) to the item and press the 'Enter' key. An on-line help message is displayed at the bottom of the screen as the cursor is moving to various items which provides a better understanding of each function. When a selection is made, the menu of selected item will appear so the user can modify the associated configuration parameters.

3-1 STANDARD CMOS SETUP

Choose "STANDARD CMOS SETUP" in the CMOS SETUP UTILITY Menu (Fig.3-1). The STANDARD CMOS SETUP allows user to configure system setting such as the current date and time, type of hard disk installed, floppy type, and display type. Memory size is auto-detected by the BIOS and displayed for your reference. When a field is highlighted (use direction keys to move cursor and <Enter> key to select), the entries in the field will be changed by pressing <PgDn> or <PgUp> keys or user can enter new data directly from the keyboard.

| ROM PCI/ISA BIOS(2A5LEPAD) | | | | | | | | | | | | | | | | | |
|------------------------------------|----------|---------------------------|------|--|--------------------|----------|---------|------|--|-------------|--------|-----------------|----------|--------------|--------|-----------------------|--|
| STANDARD CMOS SETUP | | | | | | | | | | | | | | | | | |
| AWARD SOFTWARE, INC. | | | | | | | | | | | | | | | | | |
| Date (mm:dd:yy) : Wed, Jan 15 1998 | | | | | | | | | | | | | | | | | |
| Time (hh:mm:ss) : 14 : 30 : 50 | | | | | | | | | | | | | | | | | |
| HARD DISKS | TYPE | SIZE | CYLS | HEAD | PRECOMP | LANDZONE | SECTORS | MODE | | | | | | | | | |
| Primary Master | :Auto | 0 | 0 | 0 | 0 | 0 | 0 | Auto | | | | | | | | | |
| Primary Slave | :Auto | 0 | 0 | 0 | 0 | 0 | 0 | Auto | | | | | | | | | |
| Secondary Master | :Auto | 0 | 0 | 0 | 0 | 0 | 0 | Auto | | | | | | | | | |
| Secondary Slave | :Auto | 0 | 0 | 0 | 0 | 0 | 0 | Auto | | | | | | | | | |
| Drive A : 1.44M,3.5 in. | | | | <table border="1"> <tr> <td>Base Memory</td> <td>: 640K</td> </tr> <tr> <td>Extended Memory</td> <td>: 31744K</td> </tr> <tr> <td>Other Memory</td> <td>: 384K</td> </tr> <tr> <td colspan="2">Total Memory : 32768K</td> </tr> </table> | | | | | | Base Memory | : 640K | Extended Memory | : 31744K | Other Memory | : 384K | Total Memory : 32768K | |
| Base Memory | : 640K | | | | | | | | | | | | | | | | |
| Extended Memory | : 31744K | | | | | | | | | | | | | | | | |
| Other Memory | : 384K | | | | | | | | | | | | | | | | |
| Total Memory : 32768K | | | | | | | | | | | | | | | | | |
| Drive B : None | | | | | | | | | | | | | | | | | |
| Floppy 3 mode Support : Disable | | | | | | | | | | | | | | | | | |
| Video : EGA/VGA | | | | | | | | | | | | | | | | | |
| Halt On : All, But keyboard | | | | | | | | | | | | | | | | | |
| ESC : Quit | | ↑ ↓ → ← : Select Item | | | PU/PD/+/- : Modify | | | | | | | | | | | | |
| F1 : Help | | (Shift) F2 : Change Color | | | | | | | | | | | | | | | |

Figure 3-2 STANDARD CMOS SETUP

NOTE: If the Primary Master/Slave and the Secondary Master/Slave are set as "Auto", the hard disk size and model will be auto-detected.

NOTE: The "Halt On :" field is to determine when to halt the system by the BIOS if an error occurs.

3-2 BIOS FEATURES SETUP

By selecting the "BIOS FEATURES SETUP" option in the CMOS SETUP UTILITY menu, user can change system related parameters in the displayed menu. This menu shows all of the manufacturer's default values of this mainboard. Again, user can move the cursor by pressing direction keys and <PgDn> or <PgUp> keys to modify the parameters. Pressing [F1] key to display help message of the selected item.

| ROM PCI/ISA BIOS(2A5LEPAD) | | | | |
|----------------------------|--------------|--------------------------|-----------------------|------------|
| BIOS FEATURES SETUP | | | | |
| AWARD SOFTWARE, INC. | | | | |
| Virus Warning | : Disabled | Video BIOS | Shadow | : Enabled |
| CPU Internal Cache | : Enabled | C8000-CBFFF | Shadow | : Disabled |
| External Cache | : Enabled | CC000-CFFFF | Shadow | : Disabled |
| Quick Power On Self Test | : Enabled | D0000-D3FFF | Shadow | : Disabled |
| Boot Sequence | : A, C, SCSI | D4000-D7FFF | Shadow | : Disabled |
| Swap Floppy Drive | : Disabled | D8000-DBFFF | Shadow | : Disabled |
| Boot Up Floppy Seek | : Enabled | DC000-DFFFF | Shadow | : Disabled |
| Boot Up NumLock Status | : On | Diskette Access For | | : All |
| Gate A20 Option | : Fast | | | |
| Memory Parity/ECC Check | : Disabled | | | |
| Typematic Rate Setting | : Disabled | | | |
| Typematic Rate (Chars/Sec) | : 6 | | | |
| Type matic Delay (Msec) | : 250 | | | |
| Security Option | : Setup | | | |
| PCI/VGA Palette Snoop | : Disabled | | | |
| OS Select For DRAM > 64MB | : Non-OS2 | | | |
| | | Esc : Quit | ↑ ↓ → ← : Select Item | |
| | | F1 : Help | PU/PD/+/- : Modify | |
| | | F5 : Old Values | (Shift)F2 : Color | |
| | | F7 : Load Setup Defaults | | |

Figure 3-3 BIOS FEATURES SETUP

Note: The **Security Option** contains "setup" and "system". The "setup" indicates that the password setting is for CMOS only while the "system" indicates the password setting is for both CMOS and system boot up.

- **Virus Warning:** This category flashes on the screen. During and after the system boots up, any attempt to write to the boot sector or partition table of the hard disk drive will halt the system and an error message will appear. You should then run an anti-virus program to locate the virus. Keep in mind that this feature protects only the boot sector, not the entire hard drive. Default value is Disabled.

Enabled : Activates automatically when the system boots up causing a warning message to appear when any attempt to access the boot sector or hard disk partition table.

Disabled : No warning message to appear when any attempt to access the boot sector or hard disk partition table.
- **CPU Internal Cache / External Cache:** These two categories speed up memory access. However, it depends on CPU/chipset design. The default value is Enabled. If your CPU is without Internal Cache then this item "CPU Internal Cache" will not be shown.

Enabled : Enable cache.

Disabled : Disable cache.

- **Quick Power On Self Test:** This category speeds up Power On Self Test (POST) after you power on the computer. If it is set to Enable, BIOS will shorten or skip some checking items during POST.
Enabled : Enable quick POST.
Disabled: Normal POST.
- **Boot Sequence:** This category determines which drive is searched first for the O/S (Operating System). The default value is A,C.
A,C : The system will search for floppy disk drive first then hard disk drive.
C,A : The system will search for hard disk drive first then floppy disk drive.
- **Swap Floppy Drive:** This will swap your physical drive letters A&B if you are using two floppy disks. The default value is Disabled.
Enabled : Floppy A & B will be swapped under the O/S.
Disabled : Floppy A & B will be not swapped.
- **Boot Up Floppy Seek:** During Power-On-Self-Test (POST), BIOS will determine if the installed floppy drive is 40 or 80 tracks. Only 360K type is 40 tracks while 760K, 1.2M and 1.44M are all 80 tracks. The default value is Enabled.
Enabled : BIOS searches for floppy disk drive to determine if it is 40 or 80 tracks.
Note that BIOS cannot tell from 720K, 1.2M or 1.44M drive type as they are all 80 tracks.
Disabled: BIOS will not search for the type of floppy disk drive by track number.
Note that there will not be any warning message if the drive installed is 360K.
- **Boot Up NumLock Status:** The default value is On.
On : Keypad is number keys.
Off : Keypad is arrow keys.
- **Boot UP System Speed:** Select default system speed. The system will run at the selected speed after the system boots.
High: Set the speed to high.
Low : Set the speed to low.
- **Gate A20 Option:** This refers to the way the system addresses memory above 1MB (extended memory). The default value is Fast.
Normal: The A20 signal is controlled by keyboard controller or chipset hardware.
Fast : The A20 signal is controlled by Port 92 or chipset specific method.

- **Typematic Rate Setting:** This determines the typematic rate.
Enabled : Enable typematic rate and typematic delay programming.
Disabled: Disable typematic rate and typematic delay programming. The system BIOS will use default value of 2 items and the default is controlled by the keyboard.

- **TypematicRate(Chars/Sec):**

| | |
|-------------------------------|-------------------------------|
| 6 : 6 characters per second. | 8 : 8 characters per second. |
| 10: 10 characters per second. | 12: 12 characters per second. |
| 15: 15 characters per second. | 20: 20 characters per second. |
| 24: 24 characters per second. | 30: 30 characters per second. |

- **Typematic Delay(Msec):** This determines the time between the first and second character displayed, when holding a key.
250 : 250msec.
500 : 500 msec.
750 : 750 msec.
1000: 1000msec.

- **Security Option:** This category allows you to limit access to the system and Setup, or just to Setup. The default value is Setup.
System: The system will not boot and the access to Setup will be denied if the correct password is not entered at the prompt.
Setup : The system will boot, but the access to Setup will be denied if the correct password is not entered at the prompt.

- **PCI/VGA Palette Snoop:** This filed controls the ability of a primary PCI VGA controller to share a common palette (when a snoop write cycles) with an ISA video card. The default value is Disabled.
Enabled:If an ISA card connects to a PCI VGA card via the VESA connector and the ISA card connects to VGA monitor and uses the RAMDAC of PCI card, the PCI/VGA Palette Snoop is enabled.
Disabled:Disable the VGA card Palette snoop function.

- **Video BIOS Shadow:** It determines whether video BIOS will be copied to RAM. However, it is optional from chipset design. Video Shadow will increase the video speed.
Enabled : Video shadow is enabled.
Disabled: Video shadow is disabled.

- **C8000 - CBFFF Shadow :**
- CC000 - CFFFF Shadow:**
- D0000 - D3FFF Shadow:**
- D4000 - D7FFF Shadow:**
- D8000 - DBFFF Shadow:**
- DC000 - DFFFF Shadow:**

These categories determine whether optional ROM will be copied to RAM by 16K byte or 32K byte per unit and the size depends on the chipset.

Enabled : Optional shadow is enabled.

Disabled: Optional shadow is disabled.

3-3 CHIPSET FEATURES SETUP

Choose the "CHIPSET FEATURES SETUP" in the CMOS SETUP UTILITY menu to display the following menu.

| ROM PCI/ISA BIOS(2A5LEPAD) CHIPSET FEATURES SETUP AWARD SOFTWARE, INC. | | | |
|--|---------------|-----------------------------------|-----------------|
| Bank 0/1 DRAM Timing | : SDRAM Fast | Auto Detect DIMM/PCI Clk | : Enabled |
| Bank 2/3 DRAM Timing | : FP/EDO Fast | Spread Spectrum | : Disabled |
| Bank 4/5 DRAM Timing | : FP/EDO Fast | CPU Host Clock (CPU/PCI) | : Default |
| SDRAM Cycle Length | : 3 | CPU Warning Temperature | : Disabled |
| SDRAM Bank Interleave | : Disabled | Current CPU Temperature | : 37.1°C/98.8°F |
| DRAM Page-Mode | : Enabled | Current System Temp. | : 25.1°C/77.1°F |
| DRAM Read Pipeline | : Enabled | Current CPU Fan Speed | : 0 RPM |
| DRAM Fast Decoding | : Enabled | Current Chassis Fan Speed | : 0 RPM |
| Cache Rd+CPU Wt Pipeline | : Disabled | Current POWER FAN Speed | : 0 RPM |
| Cache Timing | : Fastest | CPUcore: 2.20V | CPU1/O : 3.52V |
| Video BIOS Cacheable | : Enabled | +5V : 4.99V | +12V : 12.09V |
| System BIOS Cacheabled | : Enabled | -12V : -12.04V | -5V : -5.12V |
| Memory Hole AT 15Mb Addr. | : Disabled | Esc : Quit | |
| AGP Aperture Size | : 64M | ↑ ↓ → ← : Select Item | |
| | | F1 : Help PU/PD/+/- : Modify | |
| | | F5 : Old Values (Shift)F2 : Color | |
| | | F7 : Load Setup Defaults | |

Figure3-4 CHIPSETFEATURESETUP

Note: When you insert slower memory modules in the system and set a faster timing, maybe the system will hang up.

- **SDRAM Bank Interleave:** The default value is Disabled.
Disabled : Normal Setting.
2 Bank/4 Bank: SDRAM 2 or 4 Bank Interleave.
- **Memory Hole at 15M-16M:** The default value is Disabled.
Disabled: Normal Setting.
Enabled : This field enables the main memory (15~16MB) remap to ISA BUS.
- **Read Around Write:** The default value is Disabled.
Disabled : Normal Setting.
Enabled: This field enables the memory read around write cycle.
- **Video RAM Cacheable:** This option allows the CPU to cache read/writes of the video RAM. The default is Disabled.
Disabled: *Reduced video performance.*
Enabled: *This option allows for faster video access.*
- **AGP Aperture Size:** The amount of the system memory that the AGP card is allowed to share. The options available are 4M, 8M, 16M, 32M, 64M, 128M, 256M. The default value is 64M.
- **System/CPU Warning Temp:** The default value is Disabled
Disabled : Normal Setting.
Enabled: The options available is 50C/122F~70C/158F.
- **Current System Temp:** This is the current temperature of the system.
- **Current CPU Temp:** This is the current temperature of the CPU.
- **Current CPU Fan Speed:** The current CPU fan speed in RPMs.
- **Current ChassisFan Speed:** The current chassis fan speed in RPMs .
- **CPU(V) :** The voltage level of the CPU(Vio/Vcore).
- **+3.3V, ±5V, ±12V:** The voltage level of the power supply.

3-4 POWER MANAGEMENT SETUP

Choose the "POWERMANAGEMENTSETUP" in the CMOSSETUPUTILITY to display the following screen. This menu allows the user to modify the power management parameters and IRQ signals. In general, these parameters should not be changed unless it is absolutely necessary.

| ROM PCI/ISA BIOS(2A5LEPAD) | | | |
|----------------------------|------------------|--------------------------|-----------------------|
| POWER MANAGEMENT SETUP | | | |
| AWARD SOFTWARE, INC. | | | |
| Power Management | : User Define | Primary INTR | : ON |
| PM Control by APM | : Yes | IRQ3 (COM 2) | : Primary |
| Video off Option | : Suspend -> Off | IRQ4 (COM 1) | : Primary |
| Video off Method | : V/H SYNC+Blank | IRQ5 (LPT 2) | : Primary |
| MODEM Use IRQ | : 3 | IRQ6 (Floppy Disk) | : Disabled |
| Soft-off by PWRBTN | : Delay 4 Sec | IRQ7 (LPT 1) | : Primary |
| ** RM Timers ** | | IRQ8 (RTC Alarm) | : Disabled |
| HDD Power Down | : Disable | IRQ9 (IRQ2 Redir) | : Primary |
| Doze Mode | : Disable | IRQ10(Reserved) | : Primary |
| Suspend Mode | : Disable | IRQ11(Reserved) | : Primary |
| ** RM Events ** | | IRQ12(PS/2 Mouse) | : Primary |
| VGA | : OFF | IRQ13(Coprocessor) | : Primary |
| LPT & COM | : LPT /COM | IRQ14(Hard Disk) | : Primary |
| HDD & FDD | : ON | IRQ15(Reserved) | : Disabled |
| DMA /master | : OFF | | |
| Modem Ring Resume | : Disabled | Esc : Quit | ↑ ↓ → ← : Select Item |
| RTC Alarm Resume | : Disabled | F1 : Help | PU/PD/+/- : Modify |
| | | F5 : Old Values | (Shift)F2 : Color |
| | | F7 : Load Setup Defaults | |

Figure3-5 POWERMANAGEMENTSETUP

You can only change the content of **Doze Mode**, **Standby Mode**, and **Suspend Mode** when the **Power Management** is set to 'User Define'.

Power Management: Use this to select your Power Management selection. The default is User define.

Disabled: The system operates in NORMAL conditions (Non-GREEN), and the Power Management function is disabled.

Max. saving: Maximum power savings. Inactivity period is 1 minute in each mode.

Min. saving: Minimum power savings. Inactivity period is 1 hour in each mode.

User define: Allows user to define PM Timers parameters to control power saving mode.

PM controlled APM: This option shows whether or not you want the Power Management to be controlled the Advanced Power Management (APM). The default is Yes.

Yes: APM controls your PM

No: APM does not control your PM

- **Video Off Method:** This option allows you to select how the video will be disabled by the power management.

The default is V/H Sync + Blank

V/H Sync + Blank: System turns off vertical and horizontal synchronization ports and writes blanks to the video buffer.

DPMS: Select this option if your monitor supports the Display Power Management Signaling (DPMS) standard of the Video Electronics Standards Association (VESA). Use the software supplied for your video subsystem to select video power management values.

Blank Screen: System only writes blanks to the video buffer.

- **Video Off option:** Tells you what time frame that the video will be disabled under current power management settings.

The default is Standby.

Standby: Video powers off after time shown in standby mode setting.

Doze: Video powers off after time shown in doze mode setting.

Suspend: Video powers off after time shown in suspend mode setting.

N/A: Video power off not controlled by power management.

- **MODEM Use IRQ:** Name the interrupt request (IRQ) line assigned to the modem (if any) on your system. Activity of the selected IRQ always awakens the system.

Default is IRQ 3.

N/A: No IRQ is used. **3:** IRQ 3

4: IRQ 4 **5:** IRQ 5

7: IRQ 7 **9:** IRQ 9

10: IRQ 10 **11:** IRQ 11

The EP-MVP3G-M supports HDD Power Down, Doze and Standby power saving functions when using the Intel Pentium II Processor.

The default is Disabled

- **Doze Mode:** The “Doze” mode timer starts to count when no “PM events” have occurred.
- **Suspend Mode:** This function works only when the Pentium II Processor is installed. The timer starts to count when “System Standby” mode timer is timed out and no “PM Events” are occurring. Valid range is from 1 minute up to 1 hour.
- **HDD Power Down:** HDD Standby timer can be set from 1 to 15 minute(s).

VGA Active Monitor: Use this option if your monitor has advanced power saving features.

The default is Enabled

Enabled: Your monitor’s power features will be included in power management.

Disabled: Your monitor’s power features will not be included in power management.

- **Soft-Off by PWR-BTTN:** Use this to select your soft-off function.
 The default is Delay 4 sec.
Instant Off: Turns off instantly.
Delay 4 Second : Turns off after a 4 second delay. If momentary press of button, the system will go into Suspend Mode. Press again to take system out of Suspend Mode.
- **Resume by Alarm:** This option allows you to have the system turn on at a preset time each day or on a certain day. This option is only available when Power Loss Recovery is Enabled.
 The default is Enabled.
Enabled: The system will turn on at the preset time.
Disabled: The system will not turn on until you turn it on.
- Date (of month) Alarm:** This is how you set the date that the system will turn on.
 The default is 0.
0: Setting this to 0 will turn the system on everyday at the preset time.
1-31: Represents the day of the month that you need the system to turn on.
- Time (hh:mm:ss) Alarm:** This sets the time that you need the system to turn on.
 The default is 08:00:00.

3-5 PNP/PCI CONFIGURATION

The PNP/PCI configuration program is for the user to modify the PCI/ISA IRQ signals when various PCI/ISA cards are inserted in the PCI or ISA slots.

WARNING : Any misplacing IRQ could cause system can't pick out the resources.

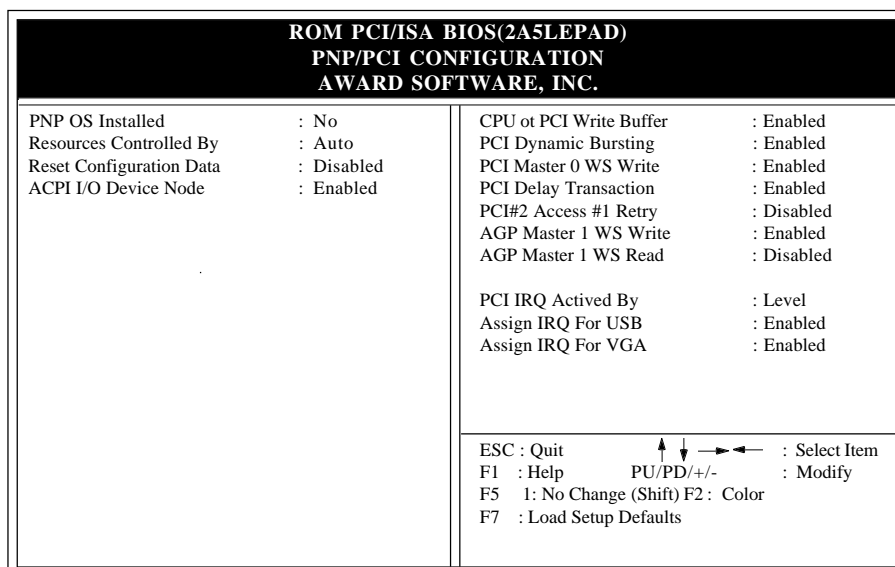

Figure3-6PCICONFIGURATIONSETUP

- PNP OS Installed:** Do you have a PNP OS installed on your system.
 The default is No.
Yes: Select if you are using a PNP OS
No: Select if your OS does not support PNP.
- Resource Controlled By:** The default value is Manual.
Manual: The field defines that the PNP Card's resource is controlled by manual. You can setup whether IRQ-X or DMA-X is assigned to PCI/ISA PNP or Legacy ISA Cards.
Auto: If your ISA card and PCI card are all PNP cards. Set this field to "Auto". The BIOS will assign the interrupt resource automatically.
- Reset Configuration Data:** The default value is Disabled.
Disabled: Normal Setting
Enabled: If you plug some Legacy cards in the system and record into ESCD (Extended System Configuration Data). You can set this field to be Enabled and to clear ESCD at one time, when some Legacy cards are removed.
- PCIIDE IRQ Map To:** The default value is PCI-AUTO.
 When you have true PCI card(s) plugged into the system, you will not need to change any thing here in the **SETUP** program. However, if you do not know whether you are using a true PCI card, please refer to your PCI card user's manual for the details.

When you have a Legacy card (described in section 2-5) to plug into the system, a proper setting is extremely important or it may cause the system hung up. The diagram shown below tells you how the Rotating Priority Mechanism is designed.

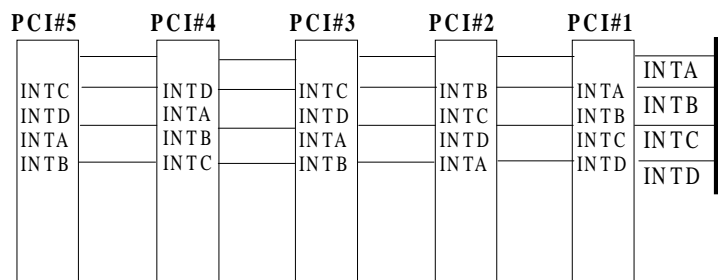

Figure 3-7: The Combination of PCI INT#lines

3-6 INTEGRATED PERIPHERALS

| ROM PCI/ISA BIOS(2A5LEPAD) INTEGRATED PERIPHERALS WARD SOFTWARE, INC. | | | |
|---|------------|--------------------------|-----------------------|
| OnChip IDE Channel1 | : Enabled | Onboard Parallel Port | : 378/IRQ7 |
| OnChip IDE Second Channel1 | : Enabled | Onboard Parallel Mode | : ECP / EPP |
| IDE Prefetch Mode | : Enabled | ECP Mode Use DMA | : 3 |
| IDE HDD Block Mode | : Enabled | Parallel Port EPP Type | : EPP1.9 |
| IDE primary Master PIO | : Auto | OnChip USB | : Enabled |
| IDE Primary Slave PIO | : Auto | USB Keyboard Support | : Disabled |
| IDE Secondary Master PIO | : Auto | | |
| IDE Secondary Slave PIO | : Auto | | |
| IDE Primary Master UDMA | : Auto | | |
| IDE Primary Slave UDMA | : Auto | | |
| IDE Secondary Master UDMA | : Auto | | |
| IDE Secondary Slave UDMA | : Auto | | |
| IDEInit Display First | : PCI Slot | | |
| Onboard FDD Controller | : Enabled | ESC : Quit | ↑ ↓ → ← : Select Item |
| Onboard Serial Port 1 | : 3F8/IRQ4 | F1 : Help | PU/PD/+/- : Modify |
| Onboard Serial Port 2 | : 2F8/IRQ3 | F5 : No Change | (Shift) F2 : Color |
| UART 2 Mode | : Standard | F7 : Load Setup Defaults | |

Note: If you don't use the Onboard IDE connector, but use On-card (PCI or ISA card) IDE connector. You have to set Onboard Primary PCIIDE: Disabled and Onboard Secondary PCIIDE: Disabled from CHIPSETFEATURESETUPUTILITY. The Onboard PCIIDE cable should be equal to or less than 18 inches (45 cm.).

- IDE HDD Block Mode:** The default value is Enabled.
Enabled : Enabled IDE HDD Block Mode. The HDD transfer rate is better than Disable.
Disabled: Disable IDE HDD Block Mode.
- PCI Slot IDE 2nd Channel:** The default value is Enabled.
Enabled : Enable secondary IDE port and BIOS will assign IRQ15 for this port.
Disabled : Disable secondary IDE port and IRQ15 is available for other device.
- Onboard Primary PCI IDE:** The default value is Enabled.
Enabled : Enable Onboard 1st channel IDE port.
Disabled : Disable Onboard 1st channel IDE port. When use On-card (PCI or ISA card) IDE connector.
- Onboard Secondary PCI IDE:** The default value is Enabled.
Enabled : Enable Onboard 2nd channel IDE port.
Disabled : Disable Onboard 2nd channel IDE port When use On-card (PCI or ISA card) IDE connector.

- **IDE Primary Master PIO:** The default value is Auto.
 - Auto* : BIOS will automatically detect the Onboard Primary Master PCI IDE HDD Accessing mode.
 - Mode0~4* : Manually set the IDE Accessing mode.

- **IDE Primary Slave PIO:** The default value is Auto.
 - Auto* : BIOS will automatically detect the Onboard Primary Slave PCI IDE HDD Accessing mode.
 - Mode0~4* : Manually set the IDE Accessing mode.

- **IDE Secondary Master PIO:** The default value is Auto.
 - Auto* : BIOS will automatically detect the Onboard Secondary Master PCI IDE HDD Accessing mode.
 - Mode0~4* : Manually set the IDE Accessing mode.

- **IDE Secondary Slave PIO:** The default value is Auto.
 - Auto* : BIOS will automatically detect the Onboard Secondary Slave PCI IDE HDD Accessing mode.
 - Mode0~4* : Manually set the IDE Accessing mode.

- **Onboard FDC Controller:** The default value is Enabled.
 - Enabled* : Enable the Onboard floppy drive interface controller.
 - Disabled* : Disable the Onboard floppy drive interface controller, When using On-card ISA FDC's controller.

- **Onboard UART 1:** This field allows the user to select the serial port. The default value is 3F8H/IRQ4.
 - COM1:* Enable Onboard Serial port 1 and address is 3F8H/IRQ4.
 - COM2:* Enable Onboard Serial port 1 and address is 2F8H/IRQ3.
 - COM3:* Enable Onboard Serial port 1 and address is 3E8H/IRQ4.
 - COM4:* Enable Onboard Serial port 1 and address is 2E8H/IRQ3.
 - Disabled:* Disable Onboard Serial port 1.

- **Onboard UART 2:** This field allows the user to select the serial port. The default value is 2F8H/IRQ3.
 - COM1:* Enable Onboard Serial port 2 and address is 3F8H/IRQ4.
 - COM2:* Enable Onboard Serial port 2 and address is 2F8H/IRQ3.
 - COM3:* Enable Onboard Serial port 2 and address is 3E8H/IRQ4.
 - COM4:* Enable Onboard Serial port 2 and address is 2E8H/IRQ3.
 - Disabled:* Disable Onboard Serial port 2.

- **Onboard UART 2 Mode:** The default value is standard. This field allows the User to select the COM2 port that can support a serial Infrared Interface.
Standard: Support a Serial Infrared Interface IrDA.
HPSIR: Support a HP Serial Infrared Interface format.
ASKIR: Support a Sharp Serial Infrared Interface format.
- **Onboard Parallel port:** This field allows the user to select the LPT port. The default value is 378H/IRQ7.
378H : Enable Onboard LPT port and address is 378H and IRQ7
278H : Enable Onboard LPT port and address is 278H and IRQ5.
3BCH : Enable Onboard LPT port and address is 3BCH and IRQ7.
Disabled : Disable Onboard LPT port.

NOTE: Parallel Port address is 378H/3BCH that selects the routing of IRQ7 for LPT1.
Parallel Port address is 278H that selects the routing of IRQ5 for LPT1.

- **Parallel port Mode:** This field allows the user to select the parallel port mode. The default value is ECP+EPP.
Normal : Standard mode. IBM PC/AT Compatible bidirectional parallel port.
EPP : Enhanced Parallel Port mode.
ECP : Extended Capability Port mode.
EPP+ECP : ECP Mode & EPP Mode.

ECP Mode USE DMA: This field allows the user to select DMA1 or DMA3 for the ECP mode. The default value is DMA3.

- DMA1** : The field selects the routing of DMA1 for the ECP mode.
- DMA3** : The field selects the routing of DMA3 for the ECP mode.

3-7 LOAD SETUP DEFAULTS

The "LOAD SETUP DEFAULTS" function loads the system default data directly from ROM and initializes the associated hardware properly. This function will be necessary only when the system CMOS data is corrupted.

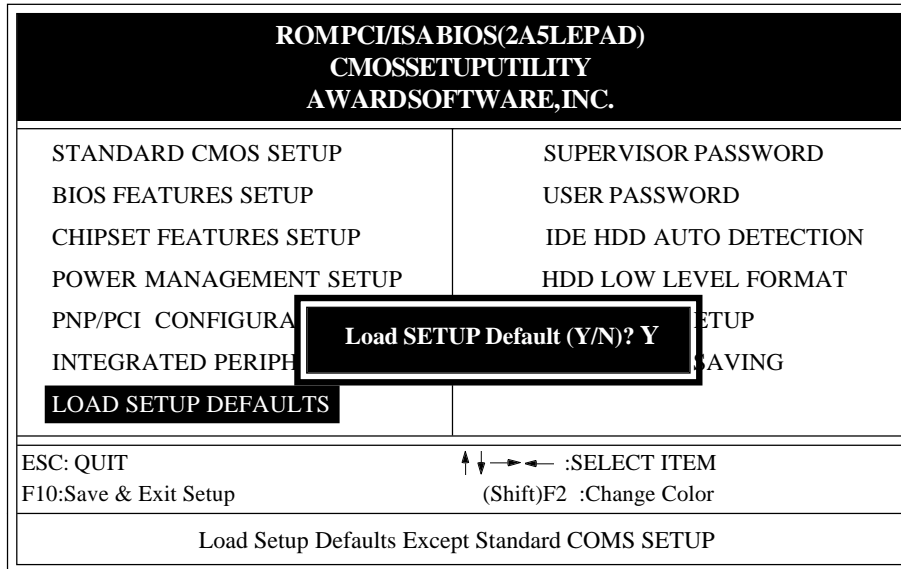

Figure 3-8 LOAD SETUP DEFAULT

3-8 CHANGE SUPERVISOR or USER PASSWORD

To change the password, choose the "SUPERVISOR PASSWORD or USER PASSWORD" option from the CMOS SETUP UTILITY menu and press [Enter].

NOTE : Either "Setup" or "System" must be selected in the "Security Option" of the BIOS FEATURES SETUP menu (Refer to Figure 3-3 for the details).

1. If CMOS is corrupted or the option is not used, a default password stored in the ROM will be used. The screen will display the following message:

Enter Password:

Press the [Enter] key to continue after proper password is given.

2. If CMOS is corrupted or the option was used earlier and the user wish to change default password, the SETUP UTILITY will display a message and ask for a confirmation.

Confirm Password:

3. After pressing the [Enter] key (ROM password if the option was not used) or current password (user-defined password), the user can change the password and store new one in CMOS RAM. A maximum of 8 characters can be entered.

3-9 IDE HDD AUTO DETECTION

The "IDE HDD AUTO DETECTION" utility is a very useful tool especially when you do not know which kind of hard disk type you are using. You can use this utility to detect the correct disk type installed in the system automatically. **But now** you can set **HARD DISK TYPE** to **Auto** in the **STANDARD CMOS SETUP**. You do not need the "IDE HDD AUTO DETECTION" utility. The BIOS will Auto-detect the hard disk size and model on display during POST.

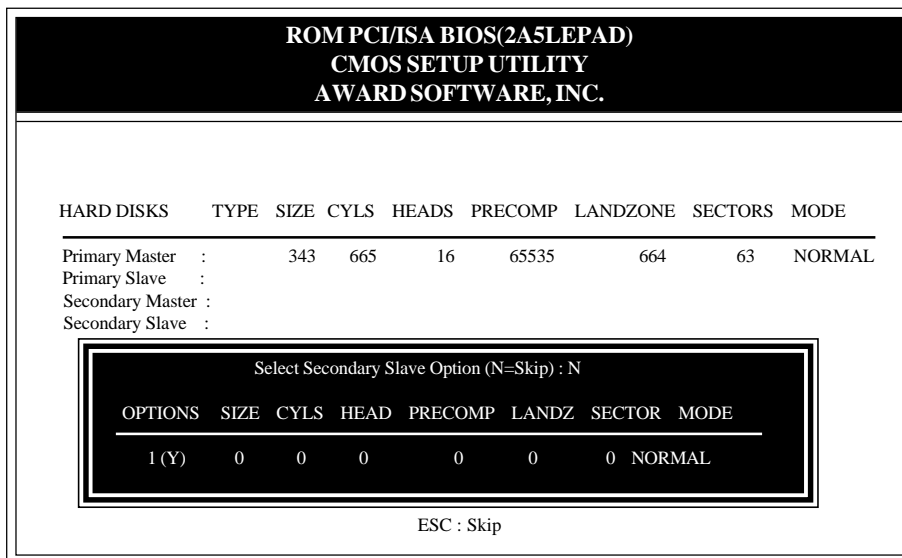

Figure 3-9 IDE HDD AUTO DETECTION

NOTE: HDD Modes

The Award BIOS supports 3 HDD modes : NORMAL, LBA and LARGE NORMAL mode.

Generic access mode that is neither the BIOS nor the IDE controller will make transformations during accessing.

The maximum numbers of cylinders, head & sectors for NORMAL mode are 1024, 16 and 63.

$$\begin{array}{r}
 \text{no. Cylinder} \quad (1024) \\
 \times \text{ no. Head} \quad (16) \\
 \times \text{ no. Sector} \quad (63) \\
 \hline
 \times \text{ no. per sector} \quad (512) \\
 \hline
 528 \text{ Megabytes}
 \end{array}$$

If an user sets the HDD to NORMAL mode, the maximum accessible HDD size will be 528 Megabytes even though its physical size may be greater than that!

LBA (Logical Block Addressing) mode: This is a new HDD accessing method to overcome the 528 Megabyte bottleneck.

The number of cylinders, heads and sectors shown in the setup may not be the number physically contained in the HDD.

During the HDD accessing, the IDE controller will transform the logical address described by sector, head and cylinder into its own physical address inside the HDD.

The maximum HDD size supported by LBA mode is 8.4 Gigabytes which is obtained by the following formula:

$$\begin{array}{r}
 \text{no. Cylinder} \quad (1024) \\
 \times \text{ no. Head} \quad (255) \\
 \times \text{ no. Sector} \quad (63) \\
 \hline
 \times \text{ bytes per sector} \quad (512) \\
 \hline
 8.4 \text{ Gigabytes}
 \end{array}$$

LARGE mode: This is an extended HDD access mode supported by Award Software.

Some IDE HDDs contain more than 1024 cylinders without LBA support (in some cases, user does not want LBA). The Award BIOS provides another alternative to support these kinds of LARGE mode:

| <u>CYLS.</u> | <u>HEADS</u> | <u>SECTOR</u> | <u>MODE</u> |
|--------------|--------------|---------------|-------------|
| 1120 | 16 | 59 | NORMAL |
| 560 | 32 | 59 | LARGE |

BIOS tricks DOS (or other OS) that the number of cylinders is less than 1024 by dividing it by 2. At the same time, the number of heads is multiplied by 2. A reverse transformation process will be made inside INT 12h in order to access the right HDD address

Maximum HDD size:

$$\begin{array}{r}
 \text{no. Cylinder} \quad (1024) \\
 \times \text{ no. Head} \quad (32) \\
 \times \text{ no. Sector} \quad (63) \\
 \hline
 \times \text{ bytes per sector} \quad (512) \\
 \hline
 1 \text{ Gigabytes}
 \end{array}$$

Note:

To support LBA or LARGE mode of HDDs, there must be some softwares involved. All softwares are located in the Award HDD Service Routine (1NT 13h). It may fail to access a HDD with LBA (LARGE) mode selected if you are running under on Operating System which replaces the whole 1NT 13h. UNIX operating systems do not support either LBA or LARGE and must utilize the Standard mode. UNIX can support drives larger than 528MB.

3-10 HDD LOW LEVEL FORMAT

Interleave

Select the interleave number of the hard disk drive that you wish to perform a low level format on. You may select from 1 to 8. Check the documentation that came with the drive for the correct interleave number, or select 0 for automatic detection.

Auto scan bad track

This allows the utility to scan first then format by each track.

Start

Press<Y>to start low level format.

3-11 SAVE & EXIT SETUP

The "SAVE & EXIT SETUP" option will bring you back to boot up procedure with all the changes you just recorded in the CMOS RAM.

3-12 EXIT WITHOUT SAVING

The "EXIT WITHOUT SAVING" option will bring you back to normal boot up procedure without saving any data into CMOS RAM. All old data in the CMOS will not be destroyed.

Chapter 4

Technical Information

4-1 I/O & MEMORY MAP

MEMORYMAP

| Address Range | Size | Description |
|---------------|------|--|
| [0000-7FFFF] | 512K | Conventional memory |
| [8000-9FBFF] | 127K | Extended Conventional memory |
| [9FC00-9FFFF] | 1K | Extended BIOS data area if PS/2 mouse is installed |
| [A0000-C7FFF] | 160K | Available for Hi DOS memory |
| [C8000-DFFFF] | 96K | Available for Hi DOS memory and adapter ROMs |
| [E0000-EEFFF] | 60K | Available for UMB |
| [EF000-EFFFF] | 4K | Video service routine for Monochrome & CGA adaptor |
| [F0000-F7FFF] | 32K | BIOS CMOS setup utility |
| [F8000-FCFFF] | 20K | BIOS runtime service routine (2) |
| [FD000-FDFFF] | 4K | Plug and Play ESCD data area |
| [FE000-FFFFF] | 8K | BIOS runtime service routine (1) |

I/OMAP

| | |
|-----------|---------------------------------------|
| [000-01F] | DMA controller.(Master) |
| [020-021] | INTERRUPT CONTROLLER.(Master) |
| [022-023] | CHIPSET control registers. I/O ports. |
| [040-05F] | TIMER control registers. |
| [060-06F] | KEYBOARD interface controller.(8042) |
| [070-07F] | RTC ports & CMOS I/O ports. |
| [080-09F] | DMA register. |
| [0A0-0BF] | INTERRUPT controller.(Slave) |
| [0C0-0DF] | DMA controller.(Slave) |
| [0F0-0FF] | MATH COPROCESSOR. |
| [1F0-1F8] | HARD DISK controller. |
| [278-27F] | PARALLEL port 2. |
| [2B0-2DF] | GRAPHICS adapter controller. |
| [2F8-2FF] | SERIAL port 2. |
| [360-36F] | NETWORK ports. |
| [378-37F] | PARALLEL port 1. |
| [3B0-3BF] | MONOCHROME & PARALLEL port adapter. |
| [3C0-3CF] | EGA adapter. |
| [3D0-3DF] | CGA adapter. |
| [3F0-3F7] | FLOPPY DISK controller. |
| [3F8-3FF] | SERIAL port 1. |

4-2 TIME & DMA CHANNELS MAP

| | | |
|----------------------|-----------------|-------------------------------|
| TIMEMAP: | TIMER Channel 0 | System timer interrupt. |
| | TIMER Channel 1 | DRAM REFRESH request. |
| | TIMER Channel 2 | SPEAKER tone generator. |
| DMA CHANNELS: | DMA Channel 0 | Available. |
| | DMA Channel 1 | Onboard ECP (Option). |
| | DMA Channel 2 | FLOPPY DISK (SMC CHIP). |
| | DMA Channel 3 | Onboard ECP (default). |
| | DMA Channel 4 | Cascade for DMA controller 1. |
| | DMA Channel 5 | Available. |
| | DMA Channel 6 | Available. |
| | DMA Channel 7 | Available. |

4-3 INTERRUPT MAP

| | |
|-------------------|--|
| NMI: | Parity check error. |
| IRQ (H/W): | 0 System TIMER interrupt from TIMER 0. |
| | 1 KEYBOARD output buffer full. |
| | 2 Cascade for IRQ 8-15. |
| | 3 SERIAL port 2. |
| | 4 SERIAL port 1. |
| | 5 PARALLEL port 2. |
| | 6 FLOPPY DISK (SMC CHIP). |
| | 7 PARALLEL port 1. |
| | 8 RTC clock. |
| | 9 Available. |
| | 10 Available. |
| | 11 Available. |
| | 12 PS/2 Mouse. |
| | 13 MATH coprocessor. |
| | 14 Onboard HARD DISK (IDE1) channel. |
| | 15 Onboard HARD DISK (IDE2) channel. |

4-4 RTC & CMOS RAM MAP

| | | |
|-------------------------|-------|--|
| RTC & CMOS : | 00 | Seconds. |
| | 01 | Second alarm. |
| | 02 | Minutes. |
| | 03 | Minutes alarm. |
| | 04 | Hours. |
| | 05 | Hours alarm. |
| | 06 | Day of week. |
| | 07 | Day of month. |
| | 08 | Month. |
| | 09 | Year. |
| | 0A | Status register A. |
| | 0B | Status register B. |
| | 0C | Status register C. |
| | 0D | Status register D. |
| | 0E | Diagnostic status byte. |
| | 0F | Shutdown byte. |
| | 10 | FLOPPY DISK drive type byte. |
| | 11 | Reserve. |
| | 12 | HARD DISK type byte. |
| | 13 | Reserve. |
| | 14 | Equipment type. |
| | 15 | Base memory low byte. |
| | 16 | Base memory high byte. |
| | 17 | Extension memory low byte. |
| | 18 | Extension memory high byte. |
| | 19-2d | |
| | 2E-2F | |
| | 30 | Reserved for extension memory low bytw. |
| | 31 | Reserved for extension memory high byte. |
| | 32 | DATE CENTURY byte. |
| | 33 | INFORMATIONFLAG. |
| | 34-3F | Reserve. |
| | 40-7F | Reserved for CHIPSET SETTING DATA. |

APPENDIX A: POST CODES

ISA POST codes are typically output to port address 80h.

POST(hex) DESCRIPTION

| | |
|--------------|---|
| 01-02 | Reserved. |
| C0 | Turn off OEM specific cache, shadow. |
| 03 | <ol style="list-style-type: none"> 1.Initialize EISA registers (EISA BIOS only). 2.Initialize all the standard devices with default values Standard devices includes. <ul style="list-style-type: none"> -DMA controller (8237). -Programmable Interrupt Controller (8259). -Programmable Interval Timer (8254). -RTC chip. |
| 04 | Reserved |
| 05 | <ol style="list-style-type: none"> 1.Keyboard Controller Self-Test. 2.Enable Keyboard Interface. |
| 06 | Reserved. |
| 07 | Verifies CMOS's basic R/W functionality. |
| C1 | Auto-detection of onboard DRAM & Cache. |
| C5 | Copy the BIOS from ROM into E0000-FFFFF shadow RAM so that POST will go faster. |
| 08 | Test the first 256K DRAM. |
| 09 | OEM specific cache initialization. (if needed) |
| 0A | <ol style="list-style-type: none"> 1.Initialize the first 32 interrupt vectors with corresponding Interrupt handlers Initialize INT no from 33-120 with Dummy (Suprious) Interrupt Handler. 2.Issue CPUID instruction to identify CPU type. 3.Early Power Management initialization. (OEM specific) |
| 0B | <ol style="list-style-type: none"> 1.Verify the RTC time is valid or not. 2.Detect bad battery. 3.Read CMOS data into BIOS stack area. 4.PnP initializations including. (PnP BIOS only) <ul style="list-style-type: none"> -Assign CSN to PnP ISA card. -Create resource map from ESCD. 5.Assign IO & Memory for PCI devices. (PCI BIOS only) |

POST(hex) DESCRIPTION

| | |
|--------------|---|
| 0C | Initialization of the BIOS Data Area. (40:00 - 40:FF) |
| 0D | <ol style="list-style-type: none"> 1.Program some of the Chipset's value according to Setup. (Early Setup Value Program) 2.Measure CPU speed for display & decide the system clock speed. 3.Video initialization including Monochromc, CGA, EGA/VGA. If no display device found, the speaker will beep. |
| 0E | <ol style="list-style-type: none"> 1.Test video RAM. (If Monochromc display device found) 2.Show messages including. <ul style="list-style-type: none"> -Award Logo, Copyright string, BIOS Data code & Part No. -OEM specific sign on messages. -Energy Star Logo. (Green BIOS ONLY) -CPU brand, type & speed. -Test system BIOS checksum. (Non-Compress Version only) |
| 0F | DMA channel 0 test. |
| 10 | DMA channel 1 test. |
| 11 | DMA page registers test. |
| 12-13 | Reserved. |
| 14 | Test 8254 Timer 0 Counter 2. |
| 15 | Test 8259 interrupt mask bits for channel 1. |
| 16 | Test 8259 interrupt mask bits for channel 2. |
| 17 | Reserved. |
| 19 | Test 8259 functionality. |
| 1A-1D | Reserved. |
| 1E | If EISA NVM checksum is good, exccute EISA initialization. (EISA BIOS only) |
| 1F-29 | Reserved. |
| 30 | Detect Base Memory & Extended Memory Size. |
| 31 | <ol style="list-style-type: none"> 1.Test Base Memory from 256K to 640K. 2.Test Extended Memory from 1M to the top of memory. |

POST(hex) DESCRIPTION

| | |
|--------------|--|
| 32 | 1.Display the Award Plug & Play BIOS Extension message. (PnP BIOS only) 2.Program all onboard super I/O chips (if any) including COM ports, LPT ports, FDD port ... according to setup value. |
| 33-3B | Reserved. |
| 3C | Set flag to allow users to enter CMOS Setup Utility. |
| 3D | 1.Initialize Keyboard. 2.Install PS2 mouse. |
| 3E | Try to turn on Level 2 cache. Note : Some chipset may need to turn on the L2 cache in this stage. But usually, the cache is turn on later in POST 61h. |
| 3F-40 | Reserved. |
| BF | 1.Program the rest of the Chipset's value according to Setup. (Later Setup Value Program) 2.If auto-configuration is enabled, programmed the chipset with pre-defined Values. |
| 41 | Initialize floppy disk drive controller. |
| 42 | Initialize Hard drive controller. |
| 43 | If it is a PnP BIOS, initialize serial & parallel ports. |
| 44 | Reserved. |
| 45 | Initialize math coprocessor. |
| 46-4D | Reserved. |
| 4E | If there is any error detected (such as video, kb...), show all the error messages on the screen & wait for user to press <F1> key. |
| 4F | 1.If password is needed, ask for password. 2.Clear the Energy Star Logo. (Green BIOS only) |
| 50 | Write all CMOS values currently in the BIOS stack area back into the CMOS. |
| 51 | Reserved. |

POST(hex) DESCRIPTION

- 52** 1.Initialize all ISA ROMs.
 2.Later PCI initializations. (PCI BIOS only)
 -assign IRQ to PCI devices.
 -initialize all PCI ROMs.
 3.PnP Initializations. (PnP BIOS only)
 -assign IO, Memory, IRQ & DMA to PnP ISA devices.
 -initialize all PnP ISA ROMs.
 4.Program shadows RAM according to Setup settings.
 5.Program parity according to Setup setting.
 6.Power Management Initialization.
 -Enable/Disable global PM.
 -APM interface initialization.
- 53** 1.If it is NOT a PnP BIOS, initialize serial & parallel ports.
 2.Initialize time value in BIOS data area by translate the RTC time value into a timer tick value.
- 60** Setup Virus Protection. (Boot Sector Protection) functionality according to Setup setting.
- 61** 1.Try to turn on Level 2 cache.
 Note : if L2 cache is already turned on in POST 3D, this part will be skipped.
 2.Set the boot up speed according to Setup setting.
 3.Last chance for Chipset initialization.
 4.Last chance for Power Management initialization. (Green BIOS only)
 5.Show the system configuration table.
- 62** 1.Setup daylight saving according to Setup value.
 2.Program the NUM Lock, typematic rate & typematic speed according to Setup setting.
- 63** 1.If there is any changes in the hardware configuration, update the ESCD information. (PnP BIOS only)
 2.Clear memory that have been used.
 3.Boot system via INT 19H.
- FF** System Booting. This means that the BIOS already pass the control right to the operating system.

Unexpected Errors:

POST(hex) DESCRIPTION

- B0** If interrupt occurs in protected mode.
- B1** Unclaimed NMI occurs.

APPENDIX B: CONNECTORS

ATX Power Supply Connector:

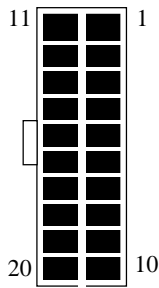

| Signal Name | Pin | Pin | Signal Name |
|-------------|-----|-----|-------------|
| 3.3V | 11 | 1 | 3.3V |
| -12.0V | 12 | 2 | 3.3V |
| GND | 13 | 3 | GND |
| PS-ON | 14 | 4 | 5.0V |
| GND | 15 | 5 | GND |
| GND | 16 | 6 | 5.0V |
| GND | 17 | 7 | GND |
| -5.0V | 18 | 8 | PW-OK |
| 5.0V | 19 | 9 | 5VSB |
| 5.0V | 20 | 10 | 12.0V |

I/O back panel connector:

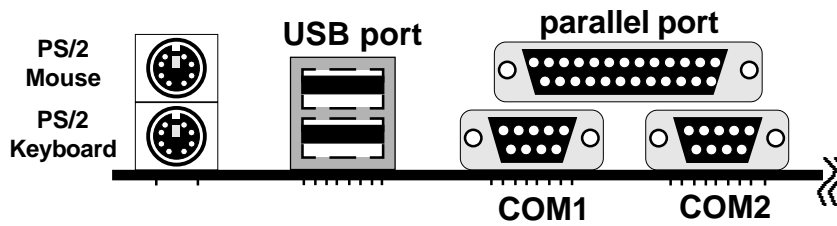

PS/2 KEYBOARD & MOUSE CONNECTOR:

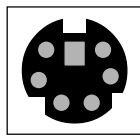

| Pin | Signal Name |
|-----|-------------|
| 1 | Data |
| 2 | Clock |
| 3 | GND |
| 4 | NC |
| 5 | VCC |

COM1,COM2 : Serial Ports Connector

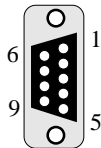

| Signal Name | Pin | Pin | Signal Name |
|-------------|-----|-----|-------------|
| DCD | 1 | 6 | DSR |
| SIN | 2 | 7 | RTS |
| SOUT | 3 | 8 | CTS |
| DTR | 4 | 9 | RI |
| GND | 5 | | |

LPT1 : Parallel Port Connector

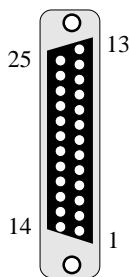

| Signal Name | Pin | Pin | Signal Name |
|-------------|-----|-----|-------------|
| STROBE- | 1 | 14 | AUTO FEED- |
| Data Bit 0 | 2 | 15 | ERROR- |
| Data Bit 1 | 3 | 16 | INIT- |
| Data Bit 2 | 4 | 17 | SLCT IN- |
| Data Bit 3 | 5 | 18 | Ground |
| Data Bit 4 | 6 | 19 | Ground |
| Data Bit 5 | 7 | 20 | Ground |
| Data Bit 6 | 8 | 21 | Ground |
| Data Bit 7 | 9 | 22 | Ground |
| ACJ- | 10 | 23 | Ground |
| BUSY | 11 | 24 | Ground |
| PE | 12 | 25 | Ground |
| SLCT | 13 | | |

FDD1 : Floppy Disk Connector

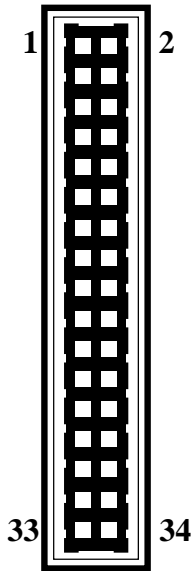

| Signal Name | Pin | Pin | Signal Name |
|-------------|-----|-----|-----------------|
| Ground | 1 | 2 | FDHDIN |
| Ground | 3 | 4 | Reserved |
| Ground | 5 | 6 | FDEDIN |
| Ground | 7 | 8 | Index- |
| Ground | 9 | 10 | Motor Enable |
| Ground | 11 | 12 | Drive Select B- |
| Ground | 13 | 14 | Drive Select A- |
| Ground | 15 | 16 | Motor Enable |
| Ground | 17 | 18 | DIR- |
| Ground | 19 | 20 | STEP- |
| Ground | 21 | 22 | Write Data |
| Ground | 23 | 24 | Write Gate |
| Ground | 25 | 26 | Track 00- |
| Ground | 27 | 28 | Write Protect- |
| Ground | 29 | 30 | Read Data- |
| Ground | 31 | 32 | SIDE 1 SELECT- |
| Ground | 33 | 34 | Diskette |

IDE1,IDE2 : Primary,Secondary IDE Connector

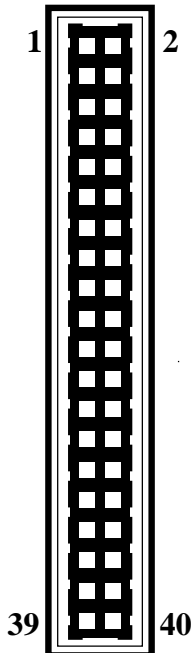

| Signal Name | Pin | Pin | Signal Name |
|----------------|-----|-----|----------------|
| Reset IDE | 1 | 2 | Ground |
| Host Data 7 | 3 | 4 | Host Data 8 |
| Host Data 6 | 5 | 6 | Host Data 9 |
| Host Data 5 | 7 | 8 | Host Data 10 |
| Host Data 4 | 9 | 10 | Host Data 11 |
| Host Data 3 | 11 | 12 | Host Data 12 |
| Host Data 2 | 13 | 14 | Host Data 13 |
| Host Data 1 | 15 | 16 | Host Data 14 |
| Host Data 0 | 17 | 18 | Host Data 15 |
| Ground | 19 | 20 | Key |
| DRQ3 | 21 | 22 | Ground |
| I/O Write- | 23 | 24 | Ground |
| I/O Read- | 25 | 26 | Ground |
| IOCHRDY | 27 | 28 | BALE |
| DACK3- | 29 | 30 | Ground |
| IRQ14 | 31 | 32 | IOCS16- |
| Addr 1 | 33 | 34 | Ground |
| Addr 0 | 35 | 36 | Addr 2 |
| Chip Select 0- | 37 | 38 | Chip Select 1- |
| Activity | 39 | 40 | Ground |

Appendix C : AGP Driver for Windows 95 Installation Guide

This section provides the information for installation of Apollo VP3 VxD Driver which supports Accelerated Graphics Port (AGP) functionalities.

SYSTEM REQUIREMENTS

1. Microsoft Windows 95 OSR2.1 (OSR2.0 with USB upgrade)
2. VIA Apollo VP3 AGP Driver (Vgart.VXD)
3. AGP VGA Card with Driver
4. Direct X5 DDK or SDK

INSTALLATION PROCEDURE

- Step 1. Install Windows 95 4.00.950 B or later version
- Step 2. Install USBSUPP (USB upgrade)
- Step 3. Install Apollo VP3 AGP Driver
 - run the program "SETUP.EXE" which can be found in the VIA VxD driver disk and this process will then automatically install the VIA VxD driver onto your windows 95 system.
- Step 4. Install VGA driver for Windows 95
- Step 5. Install Microsoft Direct X5 DDK or SDK

NOTES

1. This driver should be installed on a system with the VIA Apollo VP3 AGP chipset while other chipsets is not be supported. The VIA VxD Driver is only supported by Windows 95 OSR 2.0 (4.00.950 B) or later versions.
2. For Win95 users, you will need to
 - a. Get "USBSUPP.EXE" from Microsoft (www.microsoft.com), which includes the USB supplement and a new memory manager (VMM32.VxD) needed for the AGP DIME (Direct Memory Execute) feature.
 - b. Get DirectX 5.0 from Microsoft (www.microsoft.com). DirectX 5.0 is the first DirectX version that supports AGP's DIME.
 - c. Get "VIAGART.VXD", a virtual device manager which is usually installed during the installation procedure of the Windows 95 card driver.
3. To make sure if the Apollo VP3 AGP driver is properly installed, one must boot the Windows 95 system up and run "Regedit" and check whether the file VIAGART exists in the following path
"HKEY_LOCAL_MACHINE\System\CurrentControlSet\Services\VxD"
4. To check whether the AGP driver is able to activate, one must do the following:
 - a. Activate the "Control Panel"

- b. Click on "Direct X" then
- c. Click on "Direct Draw" and
- d. Check if there are some values existing in the "Bit" and "overlays."
if there is, that means the AGP can be activated properly.

REPLACING AN EXISTING VGA CARD WITH THE AGP VGA CARD

1. Shut down the computer and then turn off the power
2. Replace the VGA card boot up the system once again
3. Now, Update Device Driver Wizard Window will appear. This wizard will complete the installation of the Standard PCI Graphics Adapter (VGA).
Click Next > to let Windows search for an updated driver.

WARNING ! Only click Next >. The system will hang if you click Cancel!

4. Click Finish to install the VGA driver. You will then be asked for your Windows 95 CD in order to complete the VGA driver installation. If you do not have your CD handy, direct the installation path to your \windows\system directory.
Windows will prompt you to restart your windows. Chose "NO" and install the appropriate AGP VGA Driver