



# EP-8KTA

An AMD Socket A Processor based  
mainboard (100MHz)  
Supports PC133/VC133 Memory Modules

## **TRADEMARK**

All products and company names are trademarks or registered trademarks of their respective holders.

*These specifications are subject to change without notice.*

*Manual Revision 1.3  
December 19, 2000*

## **User Notice**

No part of this product, including the product and software may be reproduced, transmitted, transcribed, stored in a retrieval system, or translated into any language in any form without the express written permission of EPoX Computer Company (hereinafter referred to as EPoX) except for documentation kept by the purchaser for backup purposes.

We provide this manual “as is” without warranty of any kind, either expressed or implied, including but not limited to the implied warranties or conditions of merchantability or fitness for a particular purpose. In no event shall EPoX be liable for any loss of profits, loss of business, loss of use or data, interruption of business or for indirect, special incidental, or consequential damages of any kind, even if EPoX has been advised of the possibility of such damages arising from any defect or error in the manual or product. EPoX may revise this manual from time to time without notice. For updated BIOS, drivers, or product release information you may visit our websites at <http://www.epox.com> or <http://www.epox.com.tw>.

Products mentioned in this manual are mentioned for identification purposes only. Product names appearing in this manual may or may not be registered trademarks or copyrights of their respective companies. **The product name and revision number are both printed on the mainboard itself.**

## **Handling Procedures**

Static electricity can severely damage your equipment. Handle the EP-8KTA and any other device in your system with extreme care and avoid unnecessary contact with system components on the mainboard. Always work on an antistatic surface to avoid possible damage to the mainboard from static discharge. Always have the power supply unplugged and powered off when inserting and removing devices within the computer chassis. EPoX assumes no responsibility for any damage to the EP-8KTA mainboard that results from failure to follow instruction or failure to observe safety precautions.



### **CAUTION**



**The EP-8KTA mainboard is subject to damage by static electricity. Always observe the handling procedures.**

---

## **EP-8KTA**

---

### **Technical Support Services**

If you need additional information, help during installation or normal use of this product, please contact your retailer. Your retailer will have the most current information about your configuration. If your retailer cannot help, you may visit our online technical support website and/or contact our support technicians at the locations listed below.

Record your serial number before installing your EP-8KTA mainboard. (The serial number is located near the ISA slots at the edge of the board.)

**EP-8KTA serial number:** \_\_\_\_\_

### **Contacting Technical Support**

EPoX technical support is working hard to answer all of your questions online. From our website you can find answers to many common questions, drivers, BIOS updates, tech notes, and important technical bulletins. If you are still unable to locate the solution you are seeking, you always have the option to contact our support technicians directly.

#### **North American website (English language)**

<http://www.epox.com>

[sales@epox.com](mailto:sales@epox.com)

[support@epox.com](mailto:support@epox.com)

#### **European website (Multi-language)**

<http://www.epox.nl>

[sales@epox.nl](mailto:sales@epox.nl)

[support@epox.nl](mailto:support@epox.nl)

[info @elito-epox.com](mailto:info@elito-epox.com)

#### **Taiwan website (Chinese language)**

<http://www.epox.com.tw>

[sales@epox.com.tw](mailto:sales@epox.com.tw)

[support@epox.com.tw](mailto:support@epox.com.tw)

*Thank you for using EPoX mainboards!*

*Copyright 2000 EPoX Computer Company. All rights reserved.*

---

---

# Table of Contents

---

	<i>Page</i>
<b>Section 1</b>	<b>Introduction</b>
	Components Checklist ..... 1-1
	<b>Overview</b>
	AMD Duron™ & Athlon™ Processors ..... 1-2
	Accelerated Graphics Port ..... 1-3
	Hardware Monitoring ..... 1-3
	EP-8KTA Form-Factor ..... 1-4
	I/O Shield Connector ..... 1-5
	Power-On/Off (Remote) ..... 1-5
	System Block Diagram ..... 1-6
<b>Section 2</b>	<b>Features</b>
	EP-8KTA Features ..... 2-1
<b>Section 3</b>	<b>Installation</b>
	EP-8KTA Detailed Layout ..... 3-2
	<b>Easy Installation Procedure</b>
	CPU Insertion ..... 3-3
	Jumper Settings ..... 3-5
	System Memory Configuration ..... 3-7
	Device Connectors ..... 3-9
	External Modem Ring-in Power ON and Keyboard Power ON Function (KBPO) ..... 3-12
	STR (Suspend To RAM) Function ..... 3-13
<b>Section 4</b>	<b>Award BIOS Setup</b>
	Main Menu ..... 4-1
	Standard CMOS Setup ..... 4-2
	Advanced BIOS Features ..... 4-3
	Advanced Chipset Features ..... 4-8
	Integrated Peripherals ..... 4-11
	Power Management Setup ..... 4-15
	PNP/PCI Configuration ..... 4-18
	PC Health Status ..... 4-20
	Frequency/Voltage Control ..... 4-21

---

Defaults Menu ..... 4-22  
Supervisor/User Password Setting ..... 4-23  
Exit Selecting ..... 4-24

***Appendix***

***Appendix A***

Memory Map ..... A-1  
I/O Map ..... A-1  
Timer & DMA Channels Map ..... A-2  
Interrupt Map ..... A-2  
RTC & CMOS RAM Map ..... A-3

***Appendix B***

POST Codes ..... B-1

***Appendix C***

Load Setup Defaults ..... C-1

***Appendix D***

GHOST 5.1 Quick User's Guide ..... D-1

---



**Section 1  
INTRODUCTION**

**Components Checklist**

- ✓ A. (1) EP-8KTA mainboard
- ✓ B. (1) EP-8KTA user's manual
- ✓ C. (1) Floppy ribbon cable
- ✓ D. (1) ATA-66 Hard drive ribbon cable
- E. (1) USB Cable (Optional)
- ✓ F. (1) Driver and utility

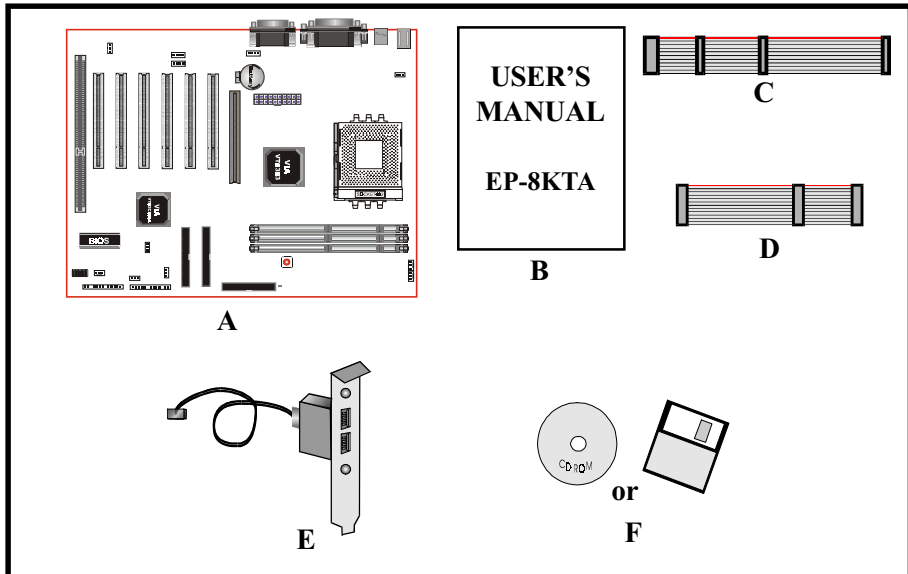

## AMD Duron™ & Athlon™ Processors

The AMD Athlon™ is a seventh-generation micro architecture with an integrated L2 cache, which is powerful enough to support the bandwidth requirements of a large range of applications, hardware, graphics, and memory technologies. These processors implement advanced design techniques such as:

- ◆ Socket A (PGA 462)
- ◆ 200MHz system interface based on the Alpha™ EV6 bus protocol.
- ◆ Three out-of-order, superscalar, pipelined Multimedia Units.
- ◆ Three out-of-order, superscalar, pipelined Integer Units.
- ◆ Fixed-sized internal instruction formats (MacroOPs).
- ◆ 72-entry Instruction Control Units.
- ◆ AMD enhanced 3DNow!™ technology
- ◆ L1 and L2 caches.
- ◆ Dynamic branch prediction.

Socket A is the name for AMD's new socketed interface designed to support both AMD Duron™ and AMD Athlon™ processors. This innovation is made possible by integrating the L2 cache memory on chip with the processor. Socket A will help enable smaller enclosures, and ultimately result in a wider variety of solutions in the market.

The AMD Duron™ & Athlon™ processors in the Socket A format continue to deliver the ultimate performance for cutting-edge applications. Both bring to desktop systems running industry-standard x86 software superscalar RISC performance. Being provided in the Socket A format they are the world's most powerful x86 processors. They easily deliver the highest integer, floating-point, and 3D multimedia performance for applications running on x86 platforms around.



The AMD Duron™ processor is derived from the AMD Athlon™ processor core. It features full-speed, on-chip cache memory, a 200MHz front side system bus, and enhanced 3DNow!™ technology. Although both processors are related, there are key differences. The AMD Athlon™ processor is targeted at the performance segment, and as such will have more cache memory and higher clock speeds.

## Accelerated Graphics Port (AGP or A.G.P.)

Typically, 3D graphics rendering requires a tremendous amount of memory, and demands ever increasing throughput speed as well. As 3D products for the personal computer become more and more popular, these demands will only increase. This will cause a rise in costs for both end users and manufacturers. Lowering these costs as well as improving performance is the primary motivation behind AGP. By providing a massive increase in the bandwidth available between the video card and the processor, it will assist in relieving some of these pressures for quite sometime.

## Hardware Monitoring

Hardware monitoring allows you to monitor various aspects of your systems operations and status. The features include CPU temperature, voltage and RPM of fan.

## EP-8KTA Form-Factor

The EP-8KTA is designed with ATX form factor - the new industry standard of chassis. ATX form factor is essentially a Baby-AT baseboard rotated 90 degrees within the chassis enclosure and a new mounting configuration for the power supply. With these changes the processor is relocated away from the expansion slots, allowing them all to hold full length add-in cards. ATX defines a double height aperture to the rear of the chassis which can be used to host a wide range of onboard I/O. Only the size and position of this aperture is defined, allowing PC manufacturers to add new I/O features (e.g.; TV input, TV output, joystick, modem, LAN, etc.) to systems. This will help systems integrators differentiate their products in the marketplace, and better meet your needs.

- Smaller size promotes a smaller system size.
- I/O shield does not need to be retooled in an ATX 2.01 or later. The mainboard should be used in an ATX 2.01 (or later) compliant case.
- A smaller power supply can be used. High integration on mainboard reduces the system costs.

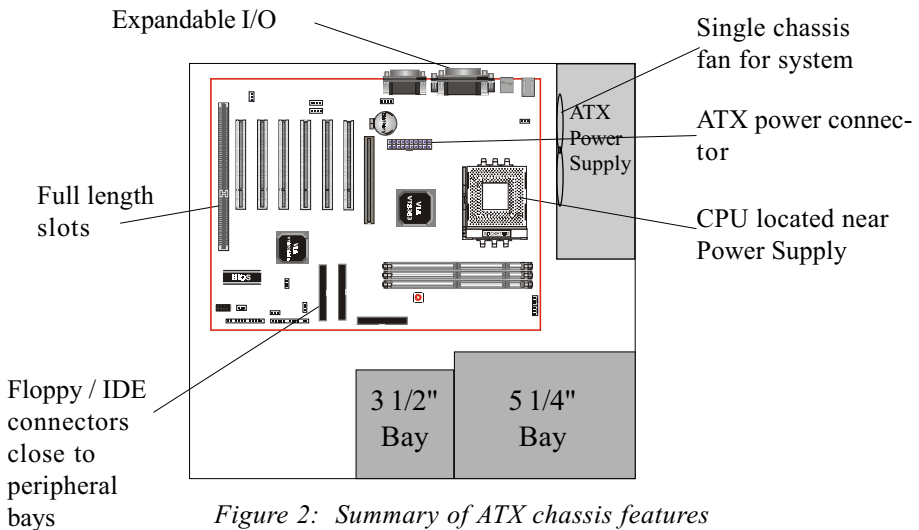

Figure 2: Summary of ATX chassis features

### I/O Shield Connector

The EP-8KTA is equipped with an I/O back panel. Please use the appropriate I/O shield (figure 3).

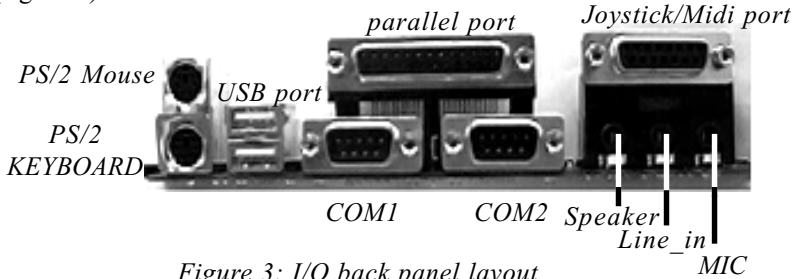

Figure 3: I/O back panel layout

### Power-On/Off (Remote)

The EP-8KTA has a single 20-pin connector for ATX power supplies. For ATX power supplies that support the **Remote On/Off** feature, this should be connected to the systems front panel for system Power On/Off button. The systems power On/Off button should be a momentary button that is normally open.

The EP-8KTA has been designed with "Soft Off" functions. You can turn Off the system from one of two sources: The first is the front panel Power On/Off button, and the other is the "Soft Off" function (coming from the EP-8KTA's onboard circuit controller) that can be controlled by the operating system such as Windows® 95/98 or Windows®2000.

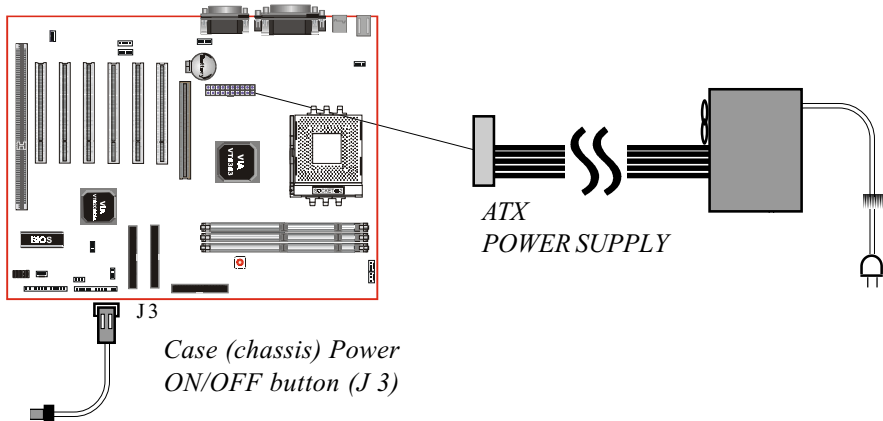

Figure 4: Simple ATX Power ON/OFF Controller

System Block Diagram

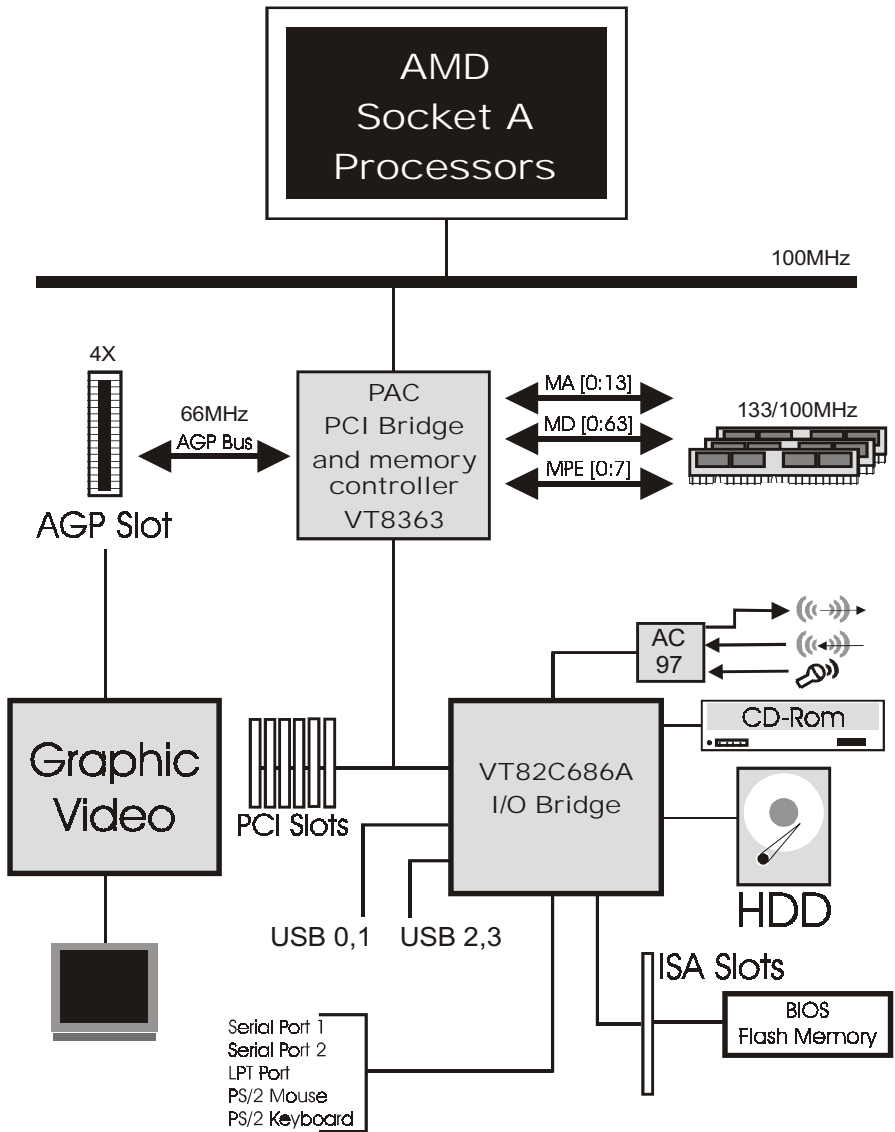

Figure 5: System Block Diagram

---

**Section 2  
FEATURES**

---

**EP-8KTA Features:**

---

- EP-8KTA is based on the AMD Socket A Processors operating at 600 ~ 1GHz.
- Designed with VIA KT133 AGPset.
- Supports up to 1.5GB of PC133/VC133 memory (minimum of 32 MB) on board (please see Section 3-3).
- Supports (1) 16 bit ISA slots, (6) 32 bit PCI slots, (1) 4X AGP slot and provides (2) independent high performance PCI IDE interfaces capable of supporting PIO Mode 3/4 and Ultra DMA 33/66 devices.  
The EP-8KTA supports (6) PCI Bus Master slots and a jumperless PCI INT# control scheme which reduces configuration confusion when plugging in PCI card(s).
- Supports ATAPI (e.g. CD-ROM) devices on both Primary and Secondary IDE interfaces.
- Designed with on chip Multi I/O: (1) floppy port, (1) parallel port (EPP, ECP), and (2) serial ports (16550 Fast UART).  
Note: Japanese “Floppy 3 mode” is also supported
- Features Award Plug & Play BIOS. With Flash Memory you can always upgrade to the current BIOS as they are released.
- EP-8KTA utilizes a Lithium battery which provides environmental protection and longer battery life.
- 4 USB ports provided, 2 ports are onboard and another 2 USB ports as optional.
- Built-in ATX 20-pin power supply connector.
- Software power-down when using Windows® 95/98 or Windows® 2000.

- Supports ring-in feature (remote power-on through external modem, allows system to be turned on remotely).
- Resume by Alarm - Allows your system to turn on at a preselected time.
- Power Loss Recovery - In the event of a power outage your system will automatically turn itself back on without user intervention.
- Supports CPU Hardware sleep and SMM (System Management Mode).
- Supports Keyboard power ON function (KBPO).
- Built-in WOL (Wake-up On Lan) Connector.
- Built-in AC97 PCI Audio.
- Supports STR (Suspend to RAM) function.
- Supports CPU Front Side Bus setting via BIOS.
- Supports CPU Vcore setting via DIP Switch.

Section 3  
INSTALLATION

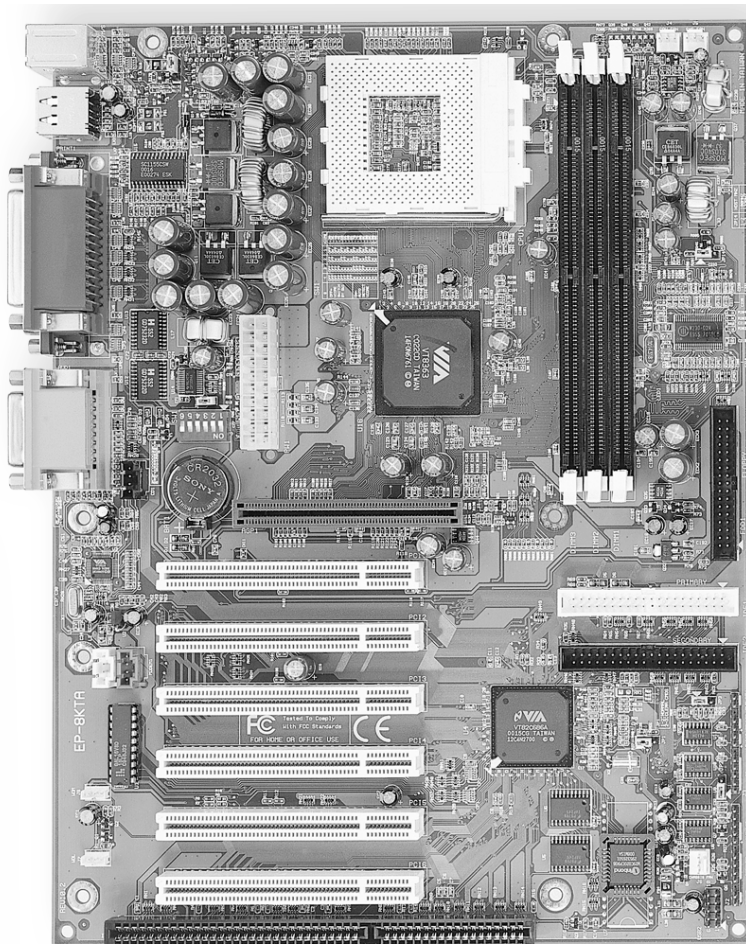

### EP-8KTA Detailed Layout

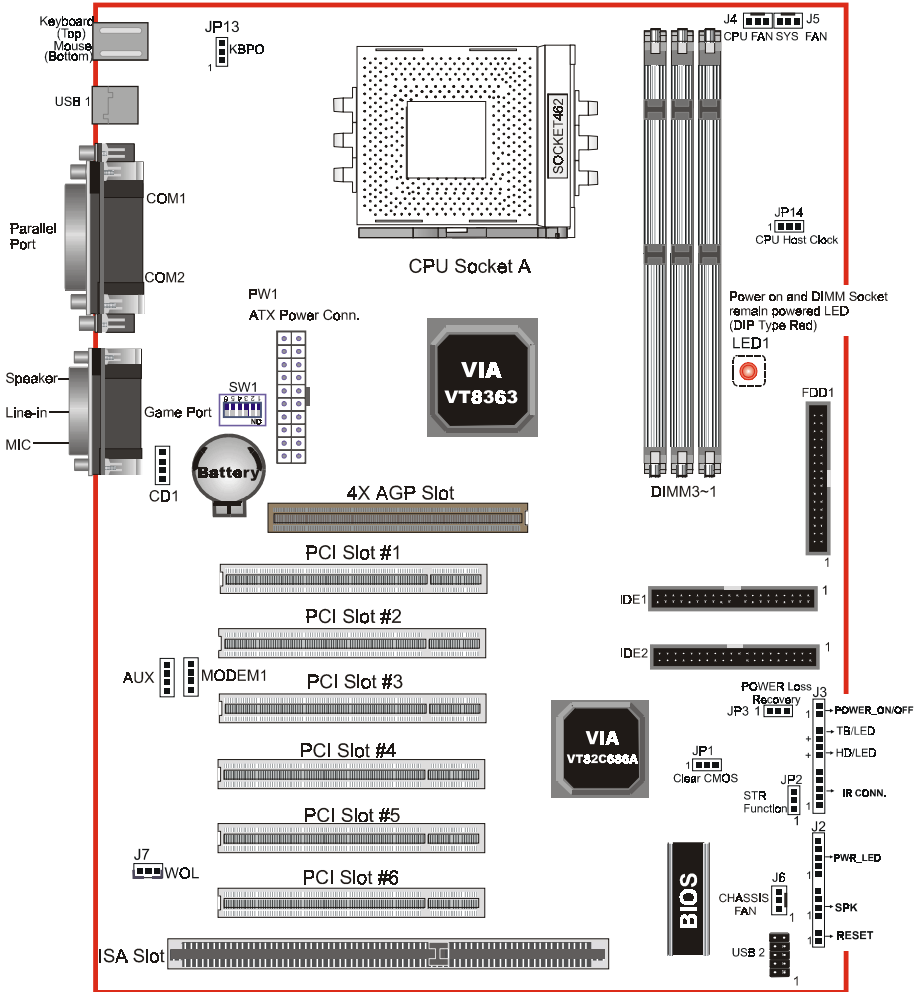

Figure 1



## Easy Installation Procedure

The following must be completed before powering on your new system:

- 3-1. CPU Insertion**
- 3-2. Jumper Settings**
- 3-3. System memory Configuration**
- 3-4. Device Connectors**
- 3-5. External Modem Ring-in Power ON and Keyboard Power ON Functions (KBPO)**
- 3-6. STR Function**

### Section 3-1 CPU Insertion

CPU Insertion: (use AMD Athlon™ as reference)

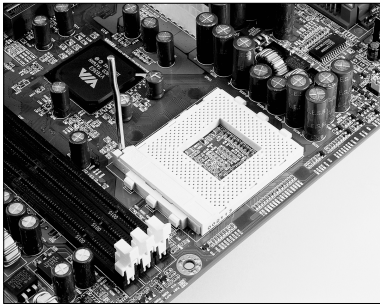

*Figure 2*

#### **Step 1**

Open the socket by raising the actuation lever.

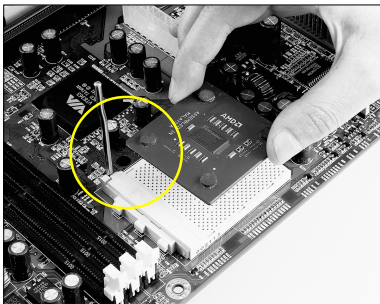

*Figure 3*

#### **Step 2**

Insert the processor.

Ensure proper pin 1 orientation by aligning the FC-PGA corner marking with the socket corner closest to the actuation arm tip. The pin field is keyed to prevent mis-oriented insertion.

Don't force processor into socket. If it does not go in easily, check for mis-orientation and debris.

Make sure the processor is fully inserted into the socket on all sides.

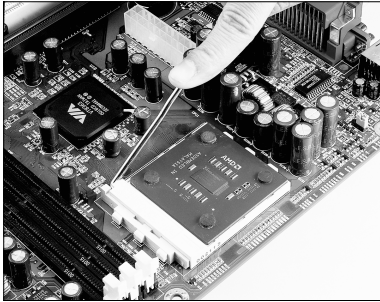

Figure 4

**Step 3**

Close the socket by lowering and locking the actuation lever.

**Step 4**

Thermal conductive and qualified heatsink recommended by AMD are a must to avoid CPU overheat and burned.

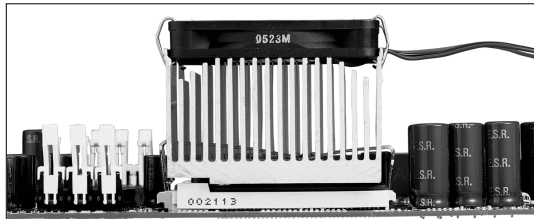
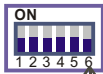

Figure 5

Section 3-2  
 Jumper Settings

The EP-8KTA motherboard was designed with very few jumpers to make your installation faster and easier.

SW1: CPU Vcore Voltage Selection



SW1 Pin6  
 OFF = Vcore adjustable by switch  
 ON = Vcore auto detected

SW1					CPU Vcore (V)
1	2	3	4	5	
OFF	OFF	OFF	OFF	ON	1.475
ON	OFF	OFF	OFF	ON	1.500
OFF	ON	OFF	OFF	ON	1.525
ON	ON	OFF	OFF	ON	1.550
OFF	OFF	ON	OFF	ON	1.575
ON	OFF	ON	OFF	ON	1.600
OFF	ON	ON	OFF	ON	1.625
ON	ON	ON	OFF	ON	1.650
OFF	OFF	OFF	ON	ON	1.675
ON	OFF	OFF	ON	ON	1.700
OFF	ON	OFF	ON	ON	1.725
ON	ON	OFF	ON	ON	1.750
OFF	OFF	ON	ON	ON	1.775
ON	OFF	ON	ON	ON	1.800
OFF	ON	ON	ON	ON	1.825
ON	ON	ON	ON	ON	1.850

\*Note: any Vcore setting over CPU specification may cause CPU to be burned.

JP1



CMOS Clear

JP1 = 1-2 Normal (Default)  
 = 2-3 Clear CMOS

JP2



STR Function

JP2 = 1-2 Disabled  
 = 2-3 Enabled

JP3



Power Loss Recovery

JP3 = 1-2 Disabled

= 2-3 Enabled

JP13



Keyboard Power-ON Function

JP13= 1-2 Disabled (Default)

= 2-3 Enabled

JP14



CPU Host Clock Select

JP14= 1-2 100MHz

= 2-3 133MHz

**Section 3-3**  
**System Memory Configuration**

**Memory Layout**

The EP-8KTA supports (3) PC133/VC133 168-pin DIMMs (Dual In-line Memory Module). The DIMMs is for SDRAM (Synchronous DRAM) only.

- DIMM SDRAM may be 83MHz (12ns), 100MHz (10ns) or 125MHz (8ns) bus speed.
- If you use both 50ns and 60ns memory you must configure your BIOS to read 60ns.
- When using Synchronous DRAM we recommend using the 4 clock variety over the 2 clock.

Figure 2 and Table 1 show several possible configurations for memory modules available in the market.

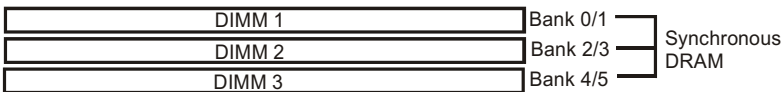

*Figure 2*

Total Memory	DIMM 1 (Bank 0/1)	DIMM 2 (Bank 2/3)	DIMM 3 (Bank 4/5)
= 256MB Maximum	SDRAM* 32MB, 64MB, 128MB, 256MB X 1	None	None
= 512MB Maximum	SDRAM* 32MB, 64MB, 128MB, 256MB X 1	SDRAM* 32MB, 64MB, 128MB, 256MB X 1	None
= 768MB Maximum	SDRAM* 32MB, 64MB, 128MB, 256MB X 1	SDRAM* 32MB, 64MB, 128MB, 256MB X 1	SDRAM* 32MB, 64MB, 128MB, 256MB X 1

*Table 1*

- \* SDRAM supports 32, 64, 128, 256MB or higher DIMM modules.
- \* We recommend to use PC100 Memory Module for bus speed 100MHz and PC133 Memory for bus speed over 100MHz.
- \* Using non-compliant memory with higher bus speed (over clocking) may severely compromise the integrity of the system.

### DIMM Module Installation

Figure 3 displays the notch marks and what they should look like on your DIMM memory module.

DIMMs have 168-pins and two notches that will match with the onboard DIMM socket. DIMM modules are installed by placing the chip firmly into the socket at a 90 degree angle and pressing straight down (figure 4) until it fits tightly into the DIMM socket (figure 5).

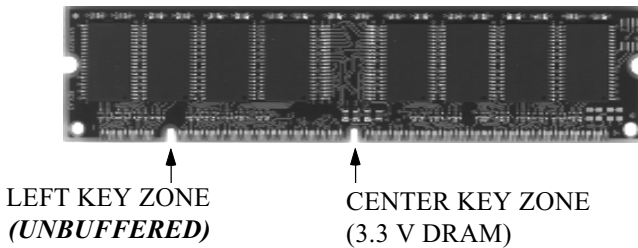

Figure 3

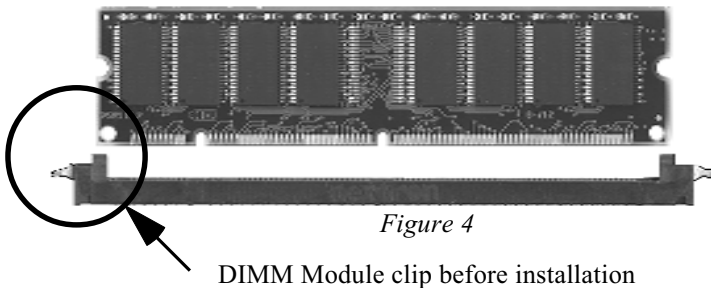

Figure 4

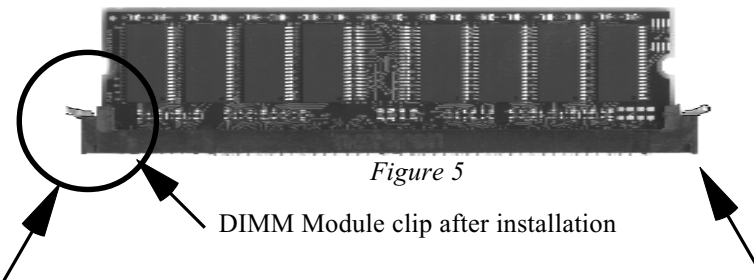

Figure 5

To remove the DIMM module simply press down both of the white clips on either side and the module will be released from the socket.

## Section 3-4

### Device Connectors

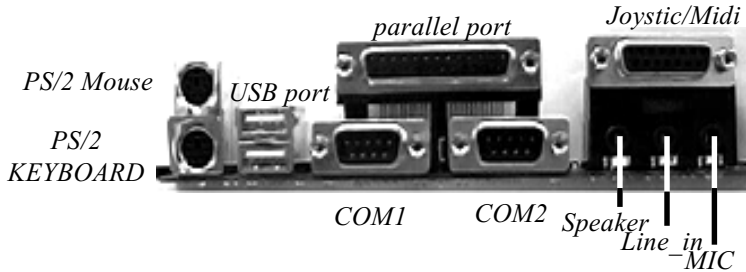

Figure 7

- J2,J3:** Chassis Panel Connector
- Power\_LED, Speaker, Reset, Sleep, Turbo LED and HDD LED
- J4:** CPU Fan Power
- A plug-in for the CPU Fan Power
- J5:** SYS Fan Power
- A plug-in for the Power Supply Fan Power
- J6:** Chassis Fan Power
- A plug-in for the chassis Fan Power
- J7:** WOL (Wake On Lan) Connector
- IDE1:** Primary IDE Connector (White Color)
- IDE2:** Secondary IDE Connector (Black Color)
- FDD1:** Floppy Controller Connector (Black Color)
- PW1:** ATX Power Connector
- 20-pin power connector
- CD1:** CD Audio\_IN Connector
- Pin1(CD\_IN\_Left), Pin2/Pin3(CD\_Reference), Pin4(CD\_IN\_Right)

**AUX1:** Auxiliary Line\_IN Connector

- Pin1(Left Line\_IN), Pin2/Pin3(GND), Pin4(Right Line-IN)

**MODEM1:** Telephony Connector

- Pin1(Audio\_in), Pin2/Pin3(GND), Pin4(Mic-out to Modem)

**USB2:** USB port header pins for adding two additional USB ports.

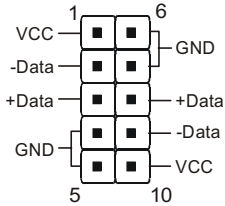

USB port header pin descriptions.

PIN#	Wire color	Signal Name	Comment
1	Red	Vcc	Cable Power
2	White	-Data	Data
3	Green	+Data	Data
4	Black	Ground	Cable Ground
5	Black	Ground	Case Ground
6	Black	Ground	Case Ground
7	Black	Ground	Cable Ground
8	Green	+Data	Data
9	White	-Data	Data
10	Red	Vcc	Cable Power



Device Connectors (continued)

(This is connected to the power button on the case. Using the Soft-Off by Pwr-BTTN feature, you can choose either Instant Off (turns system off immediatly), or 4 sec delay (you need to hold the button down for 4 seconds before the system turns off). When the system is in 4 sec delay mode, there is a special feature to make the system to go into suspend mode when the button is pressed momentarily).

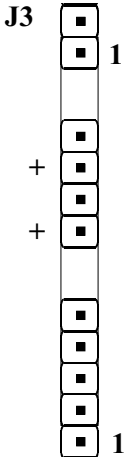

**Power On/Off**

**Turbo LED indicator** - LED ON when higher speed is selected

**IDE LED indicator** - LED ON when Onboard PCI IDE Hard disks is activate

**IR Connector**

- 1. VCC
- 2. NC
- 3. IRRX
- 4. GND
- 5. IRTX

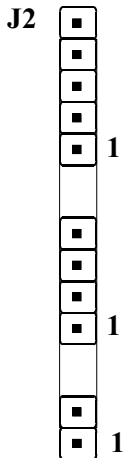

**Power LED** - Power LED connector

- 1. Power LED(+)
- 2. N/C
- 3. GND
- 4. NC
- 5. GND

**Speaker** - Connect to the system's speaker for beeping

- 1. Speaker
- 2. N/C
- 3. GND
- 4. GND

**Reset** - Closed to restart system.

## Section 3-5

### External Modem Ring-in Power ON and Keyboard Power ON Functions (KBPO)

---

On the basis of bounded functions in I/O chipset, the two serial ports are able to support the External Modem Ring-in Power ON function. Once users connect the external modem to COM1 or COM2, the EP-8KTA mainboard allows users to turn on their system through the remote and host's dial-up control.

#### **Exclusive Keyboard Power ON Function**

To innovate a unique feature to benefit users, we devoted the easiest and most convenient way to turn on your system based on the the ATX power supply.

How to work with it

**Step 1:** Please check JP13 at the position 2-3 after you finished the system installation.

JP13



Keyboard Power-ON Function  
JP13 = 1-2 Disabled (Default)  
      = 2-3 Enabled

**Step 2:** You can enjoy the Keyboard Power ON function (KBPO) by *pressing any key and BUTTON only to turn on your system*. Your system will be turned on automatically, after releasing the keys. To power off you system, you can use the Soft-OFF function under Windows® 95/98 or Windows®2000.

**Notes:** ATX version 2.0 specification has recommended you use the power supply with 0.72A(720mA) in 5.0VSB. With our EP-8KTA mainboard, *the 5.0VSB standby power only has to be > = 0.72A (720mA)* then you can enjoy this unique benefit. However, the ATX power supply which is < 0.72A (720mA) is still applicable to your system by placed JP13 at the position 1-2 to disable this feature.

## 3-6 STR (Suspend To RAM) Function

The EP-8KTA supports the STR power management state by maintaining the appropriate states on the SDRAM interface signals. The power source must be kept alive to the SDRAM during STR (ACPI S3). Advanced Configuration Power Interface (ACPI) provides more Energy Saving Features for operating systems that supporting Instant ON and QuickStart™ function.

1. To enable the ACPI function and use the STR functionally to save your system energy, you are recommended to confirm the following requirements:
  - a. Please do install all ACPI qualified add-on cards such as AGP, LAN, Modem cards.
  - b. In BIOS, please select “ACPI function: Enable” and “ACPI Suspend Type: S3(STR)” in the Power Management Setup menu.
  - c. Then, please install the Windows® 98SE or Windows® 2000.
  - d. Restart your system.
  - e. Getting in to the “Advanced” of the Power Management icon of Control Panel, and selecting the “Stand By” in the Power Buttons.
2. Getting start with STR function, please click the START button and choose Shut Down. Then, select the Stand By option in the Shut Down Windows box to get into STR mode.

Here are the differences between STR power saving mode and Green (or Suspend) mode:

- a. It is the most advanced Power Management mode
- b. It cuts all the power supplied to peripherals except to Memory - max. power saving
- c. It saves and keeps all on-screen data including any executed applications to SDRAM.

- d. You must push the Power button connected with onboard J3 pin to wake up you system (not to click to mouse or press keyboard to wake up the system).

Just pushing Power button, your system will quickly back to the last screen for you.

The “LED Indicator for ACPI Status” table shown below will guide you and give you a reference for ACPI status on this mainboard.

<b>ACPI Onboard's LED Status Indicator Table</b>					
Onboard's LED Location	Status				
	Plug in the ATX Power Core	Power ON J3(PW-ON)	Green Mode (S1)	STR (S3)	Shutdown (Soft-OFF) (S5)
LED1 (Red LED)	OFF	ON	ON	ON	OFF
J2 PW_LED	OFF	ON	Blinking	Blinking	OFF

---

## Section 4

# AWARD BIOS SETUP

---

### Main Menu

---

Award's ROM BIOS provides a built-in Setup program which allows user to modify the basic system configuration and hardware parameters. The modified data will be stored in a battery-backed CMOS, so that data will be retained even when the power is turned off. In general, the information saved in the CMOS RAM will stay unchanged unless there is a configuration change in the system, such as hard drive replacement or a device is added.

It is possible for the CMOS battery to fail, this will cause data loss in the CMOS only. If this does happen you will need to reconfigure your BIOS settings.

#### To enter the Setup Program :

Power on the computer and press the <Del> key immediately, this will bring you into the BIOS CMOS SETUP UTILITY.

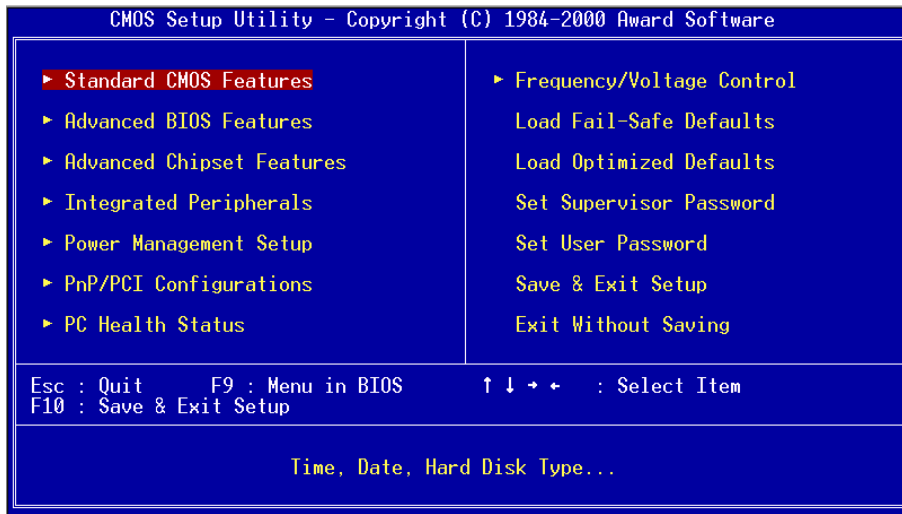

Figure 1: CMOS Setup Utility

The menu displays all the major selection items. Select the item you need to reconfigure. The selection is made by moving the cursor (press any direction key ) to the item and pressing the ‘Enter’ key. An on-line help message is displayed at the bottom of the screen as the cursor is moved to various items which provides a better understanding of each function. When a selection is made, the menu of the selected item will appear so that the user can modify associated configuration parameters.

## 4-1 Standard CMOS Setup

Choose “Standard CMOS Setup” in the CMOS SETUP UTILITY Menu (Figure 2). The Standard CMOS Setup allows the user to configure system settings such as the current date and time, type of hard disk drive installed, floppy drive type, and display type. Memory size is auto-detected by the BIOS and displayed for your reference. When a field is highlighted (use direction keys to move the cursor and the <Enter> key to select), the entries in the field can be changed by pressing the <PgDn> or the <PgUp> key.

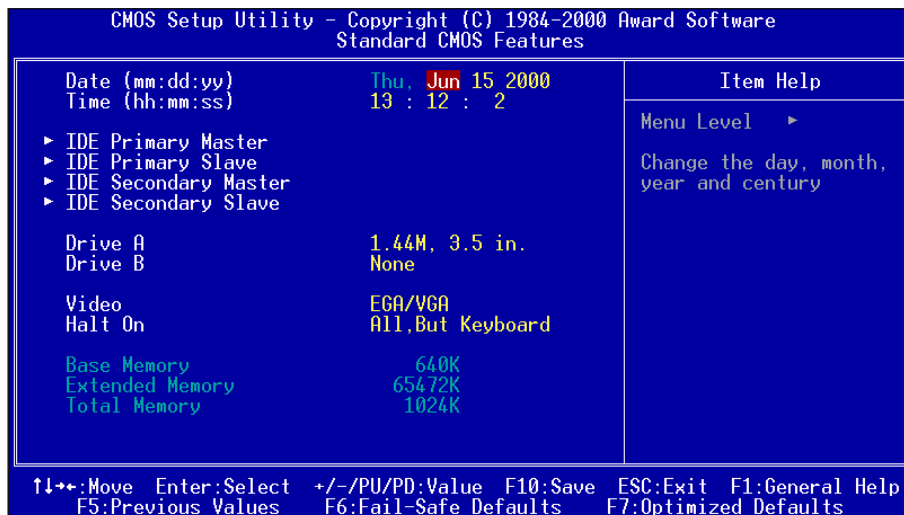

Figure 2: Standard CMOS Setup

**NOTE:** If the hard disk Primary Master/Slave and Secondary Master/Slave are set to Auto, then the hard disk size and model will be auto-detected.

**NOTE:** The “Halt On:” field is used to determine when to halt the system by the BIOS if an error occurs.

**NOTE:** Floppy 3 Mode support is a mode used to support a special 3.5” drive used in Japan. This is a 3.5” disk that stores only 1.2 MB, the default setting for this is disabled.

## 4-2 Advanced BIOS Features

Selecting the “BIOS FEATURES SETUP” option in the CMOS SETUP UTILITY menu allows users to change system related parameters in the displayed menu. This menu shows all of the manufacturer’s default values for the EP-8KTA.

Pressing the [F1] key will display a help message for the selected item.

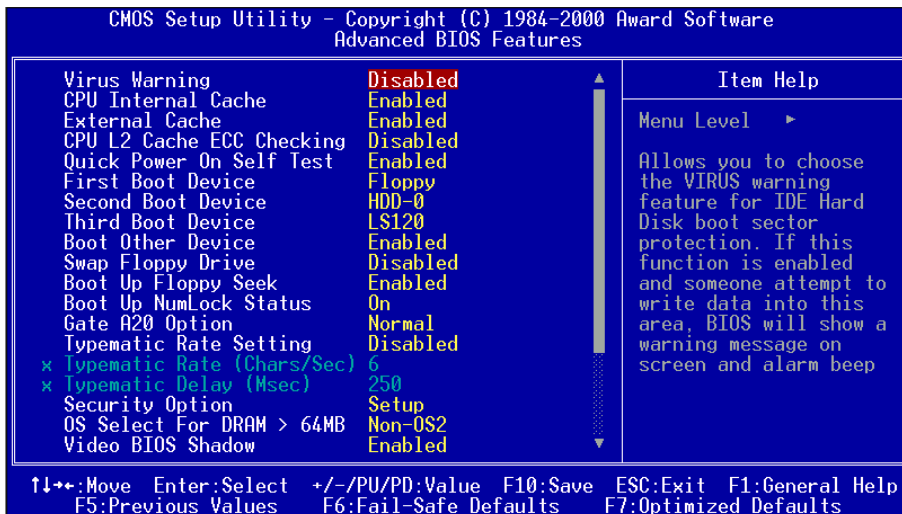

Figure 3: BIOS Features Setup

**Virus Warning:** During and after the system boots up, any attempt to write to the boot sector or partition table of the hard disk drive will halt the system and an error message will appear.

You should then run an anti-virus program to locate the virus. Keep in mind that this feature protects only the boot sector, not the entire hard drive.

The default value is Disabled.

**Enabled:** Activates automatically when the system boots up causing a warning message to appear when anything attempts to access the boot sector.

**Disabled:** No warning message will appear when anything attempts to access the boot sector.

*Note: Many disk diagnostic programs that access the boot sector table can trigger the virus warning message. If you plan to run such a program, we recommend that you first disable the virus warning.*

**CPU Internal Cache:** This controls the status of the processor's internal cache area. The default is Enabled.

**Enabled:** This activates the processor's internal cache thereby increasing performance.

**Disabled:** This deactivates the processor's internal cache thereby lowering performance.

**External (L2) Cache:** This controls the status of the external (L2) cache area. The default is Enabled.

**Enabled:** This activates the CPU's L2 cache thereby increasing performance.

**Disabled:** This deactivates the CPU's L2 cache thereby lowering performance.

**CPU L2 Cache ECC Checking:** This control if the CPU's L2 Cache will support Error Checking and Correcting (ECC). The default is Disabled.

**Enabled:** Enables ECC support for the CPU's L2 cache. Performance will decrease 2% ~ 4%.

**Disabled:** Disables ECC support for the CPU's L2 cache.

**Quick Power On Self Test:** This category speeds up the Power On Self Test (POST). The default is Enabled.

**Enabled:** This setting will shorten or skip of the items checked during POST.

**Disabled:** Normal POST.

---



**First /Second/Third/Other Boot Device:** The BIOS attempts to load the operating system from the devices in the sequence selected in these items.

The choice: Floppy, LS120, HDD, SCSI, CDROM, Disabled.

**Swap Floppy Drive:** This will swap your physical drive letters A & B if you are using two floppy disks. The default is Disabled.

**Enabled:** Floppy A & B will be swapped under the O/S.

**Disabled:** Floppy A & B will be not swapped.

**Boot Up Floppy Seek:** During Power-On-Self-Test (POST), BIOS will determine if the floppy disk drive installed is 40 or 80 tracks. Only 360K type is 40 tracks while 760K, 1.2MB and 1.44MB are all 80 tracks. The default is Enabled.

**Enabled:** The BIOS will search the floppy disk drive to determine if it is 40 or 80 tracks.

**Disabled:** The BIOS will not search for the type of floppy disk drive by track number.

*Note: BIOS can not tell the difference between 720K, 1.2MB and 1.44MB drive types as they are all 80 tracks.*

**Boot Up NumLock Status:** This controls the state of the NumLock key when the system boots. The default is On.

**On:** The keypad acts as a 10-key pad.

**Off:** The keypad acts like the cursor keys.

**Gate A20 Option:** This refers to the way the system addresses memory above 1MB (extended memory). The default is Normal.

**Normal:** The A20 signal is controlled by the keyboard controller or chipset hardware.

**Fast:** The A20 signal is controlled by Port 92 or chipset specific method.

**Typematic Rate Setting:** This determines the keystrokes repeat rate. The default is Disabled.

**Enabled:** Allows typematic rate and typematic delay programming.

**Disabled:** The typematic rate and typematic delay will be controlled by the keyboard controller in your system.

**Typematic Rate (Chars/Sec):** This is the number of characters that will be repeated by a keyboard press. The default is 6.

**6:** 6 characters per second.

**8:** 8 characters per second.

**10:** 10 characters per second.

**12:** 12 characters per second.

**15:** 15 characters per second.

**20:** 20 characters per second.

**24:** 24 characters per second.

**30:** 30 characters per second.

**Typematic Delay (msec):** This setting controls the time between the first and the second character displayed by typematic auto-repeat. The default is 250.

**250:** 250 msec.

**500:** 500 msec.

**750:** 750 msec.

**1000:** 1000 msec.

**Security Option:** This category allows you to limit access to the System and Setup, or just to Setup. The default is Setup.

**System:** The system will not boot and the access to Setup will be denied if the correct password is not entered at the prompt.

**Setup:** The system will boot; but the access to Setup will be denied if the incorrect password is not entered at the prompt.

**OS Select For DRAM > 64MB:** Some operating systems require special handling. Use this option only if your system has greater than 64MB of memory. The default is Non-OS2.

**OS2:** Select this if you are running the OS/2 operating system with greater than 64MB of RAM.

**Non-OS2:** Select this for all other operating systems and configurations.

**Video BIOS Shadow:** This option allows video BIOS to be copied into RAM. Video Shadowing will increase the video performance of your system. The default is Enabled.

**Enabled:** Video shadow is enabled.

**Disabled:** Video shadow is disabled.

**C8000 - CBFFF Shadow:**

**CC000 - CFFFF Shadow:**

**D0000 - D3FFF Shadow:**

**D4000 - D7FFF Shadow:**

**D8000 - DBFFF Shadow:****DC000 - DFFFF Shadow:**

These categories determine whether ROMs from option cards will be copied into RAM. This will be in 16K byte or 32K byte units, and the size will depend on chipset of the option card.

**Enabled:** Optional shadow is enabled.

**Disabled:** Optional shadow is disabled.

## 4-3 Advanced Chipset Features

Choose the “CHIPSET FEATURES SETUP” in the CMOS SETUP UTILITY menu to display following menu.

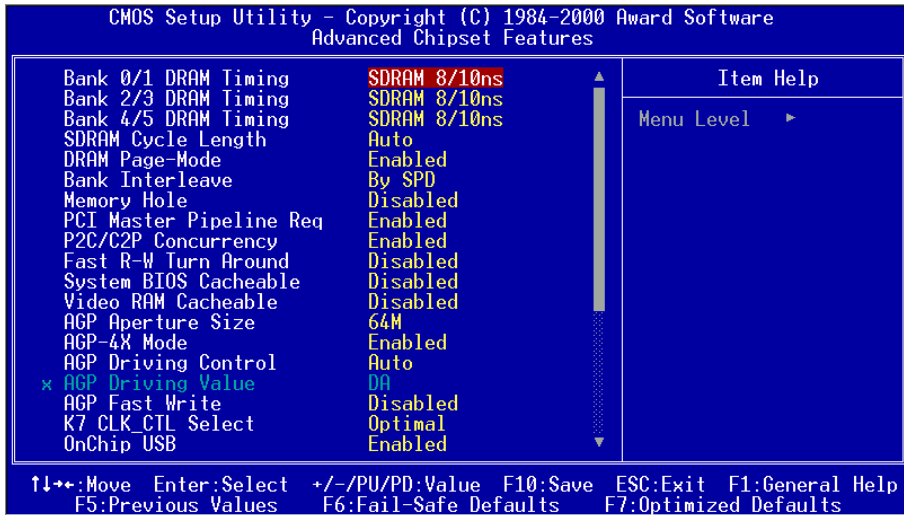

Figure 4: Chipset Features Setup

**Bank 0/1, 2/3, 4/5 DRAM Timing:** This value in this field is set by the system board manufacturer, depending on whether the board has paged DRAMs or EDO (extended data output) DRAMs.

The Choice: Bank 0/1, 2/3, 4/5.

**SDRAM Cycle length:** This setting defines the CAS timing parameter of the SDRAM in terms of clocks. The default is 3.

2: Provides faster memory performance.

3: Provides better memory compatibility.

**Auto:** Determined by BIOS.

**Bank Interleave:** The item allows you to set how many banks of SDRAM support in your mainboard.

The Choice: 2 Bank, 4 Bank, Disabled.

**DRAM Page-Mode:** The item will active or inactive chipset page registers.

**Enabled:** Page-Mode Enabled.

**Disabled:** No page registers update and non Page-Mode operation.

**Memory Hole :** You can reserve this memory area for the use of ISA adaptor ROMs. The default is Disabled.

*Enabled:* This field enables the main memory (15~16MB) to remap to ISA BUS.

*Disabled:* Normal Setting.

*Note: If this feature is enabled you will not be able to cache this memory segment.*

**System BIOS Cacheable:** This allows you to copy your BIOS code from slow ROM to fast RAM. The default is Disabled.

**Enabled:** The option will improve system performance. However, if any program writes to this memory area, a system error may result.

**Disabled:** System BIOS non-cacheable.

**Video BIOS Cacheable:** This option copies the video ROM BIOS to fast RAM (C0000h to C7FFFh). The default is Enabled.

**Enabled:** Enables the Video BIOS Cacheable to speed up the VGA Performance.

**Disabled:** Will not use the Video BIOS Cacheable function.

**Video RAM Cacheable:** This option allows the CPU to cache read/writes of the video RAM. The default is Enabled.

**Enabled:** This option allows for faster video access.

**Disabled:** Reduced video performance.

**AGP Aperture Size:** The amount of system memory that the AGP card is allowed to share. The default is 64.

- 4:** 4MB of systems memory accessible by the AGP card.
- 8:** 8MB of systems memory accessible by the AGP card.
- 16:** 16MB of systems memory accessible by the AGP card.
- 32:** 32MB of systems memory accessible by the AGP card.
- 64:** 64MB of systems memory accessible by the AGP card.
- 128:** 128MB of systems memory accessible by the AGP card.
- 256:** 256MB of systems memory accessible by the AGP card.

**AGP-4X Mode:** Chipset AGP Mode support.

Options: x1 , x2 and x4.

**AGP Driving Control:** This item allows you to adjust the AGP driving force. Choose Manual to key in a AGP Driving Value in the next selection. This field is recommended to set in Auto for avoiding any error in your system.

**K7 CLK\_CTL Select:** Use this item to specify the clock control for ramp rate. Select default for a defaulted time value, and optimal for optimum time value which depends on different CPU ratio.

The choice: Default, Optimal

**OnChip USB/USB2:** USB Connector (Port 0-1)/(Port 2-3).

The choice: Enabled, Disabled.

**USB Keyboard Support:** This controls the activation status of an optional USB keyboard that may be attached. The default is disabled.

*Enabled:* Enable USB keyboard support.

*Disabled:* Disable USB keyboard support.

**OnChip Sound:** Turn on/off onchip sound device.

**CPU to PCI Write Buffer:** When enabled, up to four D words of data can be written to the PCI bus without interrupting the CPU. When disabled, a write buffer is not used and the CPU read cycle will not be completed until the PCI bus signals that it is ready to receive the data.

The Choice: Enabled, Disabled.

**PCI Dynamic Bursting:** When Enabled, data transfers on the PCI bus, where possible, make use of the high-performance PCI bust protocol, in which graeater amounts of data are transferred at a single command.

The Choice: Enabled, Disabled.

**PCI Master 0 WS Write:** When Enabled, writes to the PCI bus are command with zero wait states.

The Choice: Enabled, Disabled.

**PCI Delay Transaction:** The chipset has an embedded 32-bit posted write buffer to support delay transactions cycles. Select Enabled to support compliance with PCI specification version 2.1.

The Choice: Enabled, Disabled.

**PCI #2 Access #1 Retry:** This item allows you enabled/disable the PCI #2 Access #1 Retry.

The Choice: Enabled, Disabled.

## 4-4 Integrated Peripherals

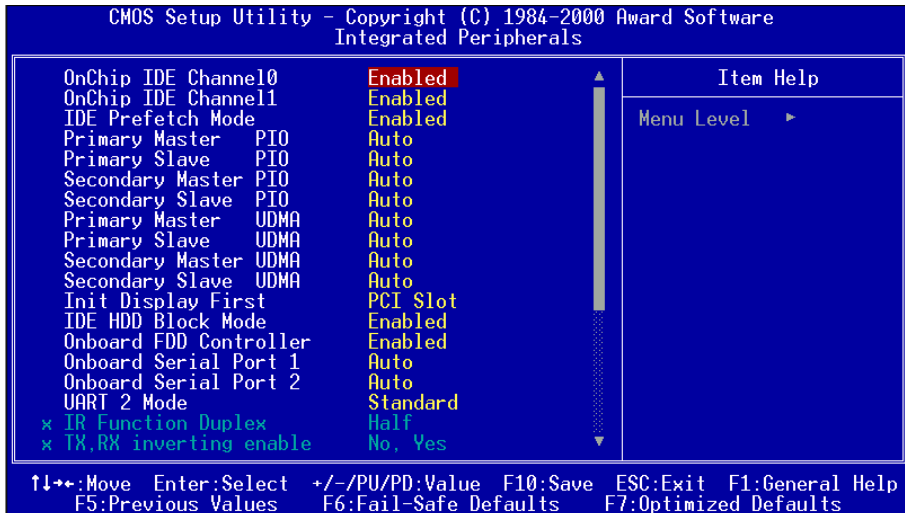

Figure 5: Integrated Peripherals

**Note:** If you do not use the Onboard IDE connector, then you will need to set Onboard Primary PCI IDE: Disabled and Onboard Secondary PCI IDE: Disabled

**Note:** The Onboard PCI IDE cable should be equal to or less than 18 inches (45 cm.).

**OnChip IDE Channel0:** The default value is Enabled.

**Enabled:** Enables Onboard IDE primary port.

**Disabled:** Disables Onboard IDE primary port.

**OnChip IDE Channel1:** The default is Enabled.

**Enabled:** Enables Onboard IDE secondary port.

**Disabled:** Disables Onboard IDE secondary port.

**IDE Prefetch Mode:** Enable prefetching for IDE drive interfaces that support its faster drive accesses. If you are getting disk drive errors, change the setting to omit the drive interface where the errors occur. Depending on the configuration of your IDE subsystem, this field may not appear, and it does not appear when the Internal PCI/IDE field, above, is Disabled.

The Choice: Enabled, Disabled.

**Primary Master PIO:** The default is Auto.

**Auto:** BIOS will automatically detect the Onboard Primary Master PCI IDE HDD Accessing mode.

**Mode 0~4:** Manually set the IDE Programmed interrupt mode.

**Primary Slave PIO:** The default is Auto.

**Auto:** BIOS will automatically detect the Onboard Primary Slave PCI IDE HDD Accessing mode.

**Mode 0~4:** Manually set the IDE Programmed interrupt mode.

**Secondary Master PIO:** The default is Auto.

**Auto:** BIOS will automatically detect the Onboard Secondary Master PCI IDE HDD Accessing mode.

**Mode 0~4:** Manually set the IDE Programmed interrupt mode.

**Secondary Slave PIO:** The default is Auto.

**Auto:** BIOS will automatically detect the Onboard Secondary Slave PCI IDE HDD Accessing mode.

**Mode 0~4:** Manually set the IDE Programmed interrupt mode.

**Primary Master UDMA:** This allows you to select the mode of operation for the hard drive. The default is Auto.

**Auto:** The computer will select the optimal setting.

**Disabled:** The hard drive will run in normal mode.

**Primary Slave UDMA:** This allows you to select the mode of operation for the hard drive. The default is Auto.

**Auto:** The computer will select the optimal setting.

**Disabled:** The hard drive will run in normal mode.

**Secondary Master UDMA:** This allows you to select the mode of operation for the hard drive. The default is Auto.

**Auto:** The computer will select the optimal setting.

**Disabled:** The hard drive will run in normal mode.

**Secondary Slave UDMA:** This allows you to select the mode of operation for the hard drive. The default is Auto.

**Auto:** The computer will select the optimal setting.

**Disabled:** The hard drive will run in normal mode.



**Init Display First:** If two video cards are used (1 AGP and 1 PCI) this specifies which one will be the primary display adapter. The default is PCI Slot.

**PCI Slots:** PCI video card will be primary adapter.

**AGP:** AGP video card will be primary adapter.

**IDE HDD Block Mode:** IDE Block Mode allows the controller to access blocks of sectors rather than a single sector at a time. The default is Enabled.

**Enabled:** Enabled IDE HDD Block Mode. Provides higher HDD transfer rates.

**Disabled:** Disable IDE HDD Block Mode.

**Onboard FDD Controller:** This controls the state of the onboard floppy controller. The default value is Enabled.

**Enabled:** Enable the Onboard VIA686A Chips's floppy drive interface controller.

**Disabled:** Disable the Onboard VIA686A Chip's floppy drive interface controller.

**Onboard Serial Port 1:** This field allows the user to configure the 1st serial port. The default is Auto.

**AUTO:** Enable Onboard Serial port 1 and address is Auto adjusted.

**COM1:** Enable Onboard Serial port 1 and address is 3F8H/IRQ4.

**COM2:** Enable Onboard Serial port 1 and address is 2F8H/IRQ3.

**COM3:** Enable Onboard Serial port 1 and address is 3E8H/IRQ4.

**COM4:** Enable Onboard Serial port 1 and address is 2E8H/IRQ3.

**Disabled:** Disable Onboard SMC CHIP's Serial port 1.

**Onboard Serial Port 2:** This field allows the user to configure the 2nd serial port. The default is Auto.

**AUTO:** Enable Onboard Serial port 2 and address is Auto adjusted.

**COM1:** Enable Onboard Serial port 2 and address is 3F8H/IRQ4.

**COM2:** Enable Onboard Serial port 2 and address is 2F8H/IRQ3.

**COM3:** Enable Onboard Serial port 2 and address is 3E8H/IRQ4.

**COM4:** Enable Onboard Serial port 2 and address is 2E8H/IRQ3.

**Disabled:** Disable Onboard SMC CHIP's Serial port 2.

**UART 2 Mode:** This item allows you to determine which Infra Red (IR) function of onboard I/O chip.

The Choice: Standard, ASKIR, HPSIR.

**Onboard Parallel port:** This field allows the user to configure the LPT port. The default is 378H / IRQ7.

**378H:** Enable Onboard LPT port and address is 378H and IRQ7.

**278H:** Enable Onboard LPT port and address is 278H and IRQ5.

**3BCH:** Enable Onboard LPT port and address is 3BCH and IRQ7.

**Disabled:** Disable Onboard Winbond Chip's LPT port.

**Onboard Parallel Port Mode:** This field allows the user to select the parallel port mode.

The default is Normal.

**Normal:** Standard mode. IBM PC/AT Compatible bidirectional parallel port.

**EPP:** Enhanced Parallel Port mode.

**ECP:** Extended Capabilities Port mode.

**EPP+ECP:** ECP Mode & EPP Mode.

**ECP Mode USE DMA:** This field allows the user to select DMA1 or DMA3 for the ECP mode. The default is DMA3.

**DMA1:** This field selects the routing of DMA1 for the ECP mode.

**DMA3:** This field selects the routing of DMA3 for the ECP mode.

**Parallel Port EPP Type:** This item allows you to determine the IR transfer mode of onboard I/O chip.

The Choice: EPP1.9, EPP1.7.

**Onboard Legacy Audio:** Legacy Audio enabled/disabled.

**Sound Blaster:** Sound Blaster compatible device enabled/disabled.

**SB I/O Base Address:** Sound Blaster I/O resource selection.

**SB IRQ Select:** Legacy audio device IRQ selection.

**SB DMA Select:** Sound Blaster DMA channel selection.

**MPU-401:** MPU-401 function enabled/disabled.

**MPU-401 I/O Address:** Built-in MPU-401 compatible MIDI I/O port selection:

*300-303H*

*310-313H*

*320-323H*

*330-333H (default)*

**Game Port (200-207H):** Built-in joystick port support disabled/enabled(default).

## 4-5 Power Management Setup

Choose the “POWER MANAGEMENT SETUP” in the CMOS SETUP UTILITY to display the following screen. This menu allows the user to modify the power management parameters and IRQ signals. In general, these parameters should not be changed unless it’s absolutely necessary.

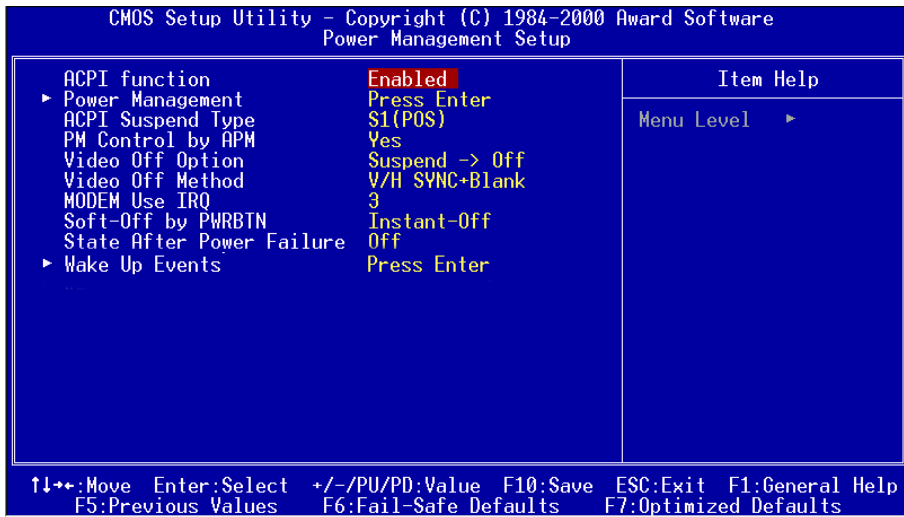

Figure 6: Power Management Setup

**ACPI Function:** This option allows you to select ACPI Function. The default is Enabled.

**Enabled:** Support ACPI function for new O.S

**Disabled:** No Support ACPI function.

You can only change the content of Doze Mode, Standby Mode, and Suspend Mode when the Power Management is set to ‘User Define’.

**Power Management:** Use this to select your Power Management selection. The default is User define.

**Disabled:** The system operates in NORMAL conditions (Non-GREEN), and the Power Management function is disabled.

**Max. saving:** Maximum power savings. Inactivity period is 1 minute in each mode.

**Min. saving:** Minimum power savings. Inactivity period is 1 hour in each mode.

**User define:** Allows user to define PM Timers parameters to control power saving mode.

**ACPI Suspend Type:** This item allows you to select S1(POS) or S3(STR) function. The choice: S1(POS), S3(STR).

**PM controlled by APM:** This option shows weather or not you want the Power Management to be controlled the Advanced Power Management (APM). The default is Yes.

**Yes:** APM controls your PM

**No:** APM does not control your PM

**Video Off Option:** Tells you what time frame that the video will be disabled under current power management settings. The default is Standby.

**Standby:** Video powers off after time shown in standby mode setting.

**Doze:** Video powers off after time shown in doze mode setting.

**Suspend:** Video powers off after time shown in suspend mode setting.

**N/A:** Video power off not controlled by power management.

**Video Off Method:** This option allows you to select how the video will be disabled by the power management. The default is V/H Sync + Blank

**V/H Sync + Blank:** System turns off vertical and horizontal synchronization ports and writes blanks to the video buffer.

**DPMS:** Select this option if your monitor supports the Display Power Management Signaling (DPMS) standard of the Video Electronics Standards Association (VESA). Use the software supplied for your video subsystem to select video power management values.

**Blank Screen:** System only writes blanks to the video buffer.

**MODEM Use IRQ:** Name the interrupt request (IRQ) line assigned to the modem (if any) on your system. Activity of the selected IRQ always awakens the system. Default is IRQ 3.

**N/A:** No IRQ is used.                   **3:** IRQ 3

**4:** IRQ 4                                   **5:** IRQ 5

**7:** IRQ 7                                   **9:** IRQ 9

**10:** IRQ 10                               **11:** IRQ 11

**Soft-Off by PWRBTN:** Use this to select your soft-off function.

The default is Delay 4 sec.

**Instant Off:** Turns off the system instantly.

**Delay 4 Second :** Turns off the system after a 4 second delay. If momentary press of button, the system will go into Suspend Mode. Press the power button again to take system out of Suspend Mode.

**State After Power Failure:** This field lets you determine the state that your PC returns to after a power failure. If set to Off, the PC will not boot after a power failure, if set to On, the PC will restart after a power failure.

**VGA:** When set to On (default), any event occurring at a VGA port will awaken a system which has been powered down.

**LPT & COM:** When set to *On* (default), any event occurring at a COM(serial)/LPT (printer) port will awaken a system which has been powered down.

**HDD & FDD:** When set to *On* (default), any event occurring at a hard or floppy drive port will awaken a system which has been powered down.

**PCI Card:** When set to *On* (default), any event occurring to the DMA controller will awaken a system which has been powered down.

**Modem Ring Resume:** When set to *Enabled*, any event occurring to the Modem Ring will awaken a system which has been powered down.

**RTC Alarm Resume:** When set to *Enable rtc alarm resume*, you could set the date (of month) and timer (hh:mm:ss), any event occurring at will awaken a system which has been powered down.

**Primary INTR:** When set to *On* (default), any event occurring at will awaken a system which has been powered down.

## 4-6 PNP/PCI Configuration

The PNP/PCI configuration program is for the user to modify the PCI/ISA IRQ signals when various PCI/ISA cards are inserted in the PCI or ISA slots.

**WARNING:** *Conflicting IRQ's may cause the system to not find certain devices.*

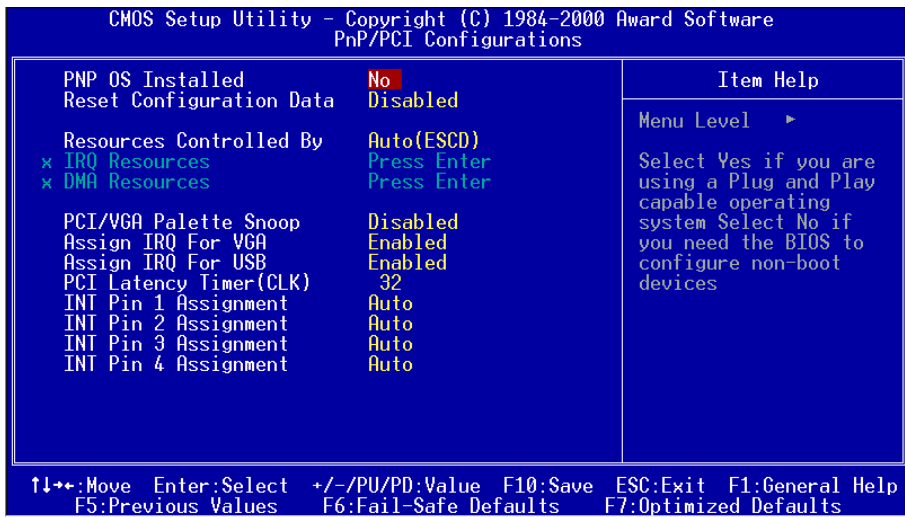

Figure 7: PCI Configuration Setup

**PNP OS Installed:** Do you have a PNP OS installed on your system. The default is No.

**Yes:** Select if you are using a PNP OS.

**No:** Select if your OS does not support PNP.

**Resources Controlled By:** Who controlled the system PNP/PCI resources. The default is Auto.

**Manual:** PNP Card's resources will be controlled manually. You can set which IRQ-X and DMA-X are assigned to PCI/ISA PNP or Legacy ISA Cards.

**Auto:** If your ISA card and PCI card are all PNP cards, BIOS will assign the interrupt resource automatically.

**Reset Configuration Data:** This setting allows you to clear ESCD data.

The default is Disabled

**Disabled:** Normal Setting.

**Enabled:** If you have plugged in some Legacy cards to the system and they were recorded into ESCD (Extended System Configuration Data), you can set this field to Enabled in order to clear ESCD.

**PCI/VGA Palette Snoop:** Leave this field at Disabled.

The choice: Enabled, Disabled.

**Assign IRQ For USB:** This item allows BIOS to assign whether IRQ is with USB or not. If you have not connect the USB device. Can release the IRQ for other device. The default is Enabled.

**Enabled:** Provides IRQ for USB device.

**Disabled:** Release IRQ for other device.

**Slot 1 to Slot 5 Use IRQ No:** These settings allow the user to specify what IRQ will be assigned to PCI devices in the chosen slot. Options available: Auto,3,4,5, 7,9,10,11,12,14 & 15. The defaults are Auto.

## 4-7 PC Health Status

CMOS Setup Utility - Copyright (C) 1984-2000 Award Software		PC Health Status	
Current CPU Temp.	31°C/87°F	Item	Help
Current System Temp.	0°C/32°F	Menu	Level ▶
Current CPU Fan Speed	6135 RPM		
Current Chassis Fan Speed	0 RPM		
Vcore	1.62V		
3.3V	3.22V		
5V	5.01V		
12V	12.12V		

↑↓←→: Move    Enter: Select    +/-/PU/PD: Value    F10: Save    ESC: Exit    F1: General Help  
 F5: Previous Values    F6: Fail-Safe Defaults    F7: Optimized Defaults

**Current CPU Temperature:** This is the current temperature of the CPU.

**Current System Temperature:** This is the Current temperature of the system.

**Current CPU FAN Speed:** The current CPU fan speed in RPMs.

**Current Chassis FAN Speed:** The current chassis fan speed in RPMs.

**CPU(V):** The voltage level of the CPU(Vcore).

**3.3V, 5V, 12V:** The voltage level of the switch power supply.



## 4-8 Frequency/Voltage Control

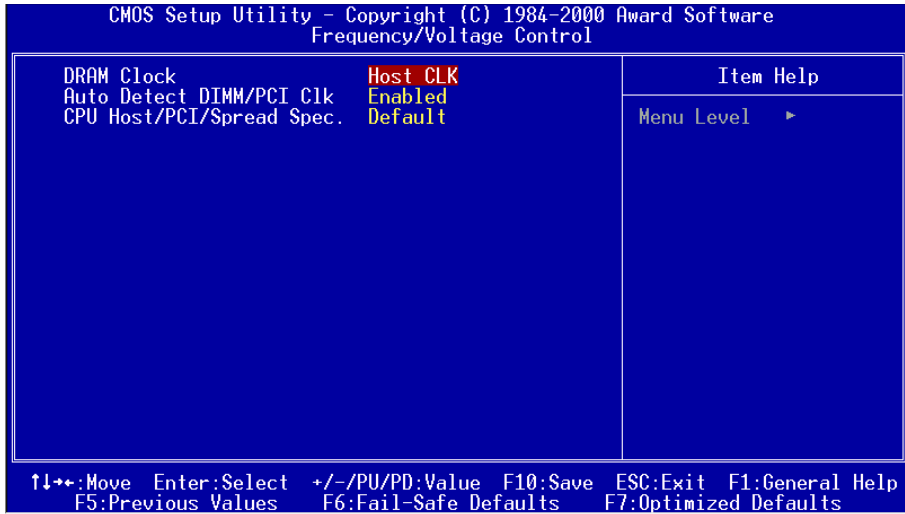

**DRAM Clock :** The item will synchronize/asynchronize DRAM operation clock.

**Host Clock:** DRAM has same working clock with CPU host bus.

**2/3 Host:** DRAM running with lower operation clock.

**Auto Detect DIMM/PCI Clk:** When enabled the motherboard will automatically disable the clock source for a DIMM socket which does not have a module in it. Same applies for PCI slots. The default is Enabled.

**Enabled:** Enables this option.

**Disabled:** Disables this option.

**CPU Host/PCI/Spread Spec. :** Allows the external clock to be modified depending upon what FSB has been selected. Should not be used to clock processor faster than it was designed for. The default is Default.

## 4-9 Defaults Menu

---

Selecting “Defaults” from the main menu shows you two options which are described below

### **Load Fail-Safe Defaults**

When you press <Enter> on this item you get a confirmation dialog box with a message similar to:

Load Fail-Safe Defaults (Y/N) ? N

Pressing ‘Y’ loads the BIOS default values for the most stable, minimal-performance system operations.

### **Load Optimized Defaults**

When you press <Enter> on this item you get a confirmation dialog box with a message similar to:

Load Optimized Defaults (Y/N) ? N

Pressing ‘Y’ loads the default values that are factory settings for optimal performance system operations.

---

## 4-10 Supervisor/User Password Setting

---

You can set either supervisor or user password, or both of them. The differences between are:

**supervisor password** : can enter and change the options of the setup menus.

**user password** : just can only enter but do not have the right to change the options of the setup menus. When you select this function, the following message will appear at the center of the screen to assist you in creating a password.

### ENTER PASSWORD:

Type the password, up to eight characters in length, and press <Enter>. The password typed now will clear any previously entered password from CMOS memory. You will be asked to confirm the password. Type the password again and press <Enter>. You may also press <Esc> to abort the selection and not enter a password. To disable a password, just press <Enter> when you are prompted to enter the password. A message will confirm the password will be disabled. Once the password is disabled, the system will boot and you can enter Setup freely.

### PASSWORD DISABLED.

When a password has been enabled, you will be prompted to enter it every time you try to enter Setup. This prevents an unauthorized person from changing any part of your system configuration.

Additionally, when a password is enabled, you can also require the BIOS to request a password every time your system is rebooted. This would prevent unauthorized use of your computer.

You determine when the password is required within the BIOS Features Setup Menu and its Security option (see Section 3). If the Security option is set to "System", the password will be required both at boot and at entry to Setup. If set to "Setup", prompting only occurs when trying to enter Setup.

## 4-11 Exit Selecting

---

### **Save & Exit Setup**

Pressing <Enter> on this item asks for confirmation:

**Save to CMOS and EXIT (Y/N)? Y**

Pressing “Y” stores the selections made in the menus in CMOS – a special section of memory that stays on after you turn your system off. The next time you boot your computer, the BIOS configures your system according to the Setup selections stored in CMOS. After saving the values the system is restarted again.

### **Exit Without Saving**

Pressing <Enter> on this item asks for confirmation:

**Quit without saving (Y/N)? Y**

This allows you to exit Setup without storing in CMOS any change. The previous selections remain in effect. This exits the Setup utility and restarts your computer.

---

## Appendix A

---

### A-1 MEMORY MAP

---

Address Range	Size	Description
[00000-7FFFF]	512K	Conventional memory
[80000-9FBFF]	127K	Extended Conventional memory
[9FC00-9FFFF]	1K	Extended BIOS data area if PS/2 mouse is installed
[A0000-C7FFF]	160K	Available for Hi DOS memory
[C8000-DFFFF]	96K	Available for Hi DOS memory and adapter ROMs
[E0000-EEFFF]	60K	Available for UMB
[EF000-EFFFF]	4K	Video service routine for Monochrome & CGA adaptor
[F0000-F7FFF]	32K	BIOS CMOS setup utility
[F8000-FCFFF]	20K	BIOS runtime service routine (2)
[FD000-FDFFF]	4K	Plug and Play ESCD data area
[FE000-FFFFF]	8K	BIOS runtime service routine (1)

### A-2 I/O MAP

---

[000-01F]	DMA controller.(Master)
[020-021]	INTERRUPT CONTROLLER.(Master)
[022-023]	CHIPSET control registers. I/O ports.
[040-05F]	TIMER control registers.
[060-06F]	KEYBOARD interface controller.(8042)
[070-07F]	RTC ports & CMOS I/O ports.
[080-09F]	DMA register.
[0A0-0BF]	INTERRUPT controller.(Slave)
[0C0-0DF]	DMA controller.(Slave)
[0F0-0FF]	MATH COPROCESSOR.
[1F0-1F8 ]	HARD DISK controller.
[278-27F]	PARALLEL port 2.
[2B0-2DF]	GRAPHICS adapter controller.

[2F8-2FF]	SERIAL port 2.
[360-36F]	NETWORK ports.
[378-37F]	PARALLEL port 1.
[3B0-3BF]	MONOCHROME & PARALLEL port adapter.
[3C0-3CF]	EGA adapter.
[3D0-3DF]	CGA adapter.
[3F0-3F7]	FLOPPY DISK controller.
[3F8-3FF]	SERIAL port 1.

### A-3 TIMER & DMA CHANNELS MAP

#### TIMER MAP:

TIMER Channel 0	System timer interrupt.
TIMER Channel 1	DRAM REFRESH request.
TIMER Channel 2	SPEAKER tone generator.

#### DMA CHANNELS:

DMA Channel 0	Available.
DMA Channel 1	Onboard ECP (Option).
DMA Channel 2	FLOPPY DISK (SMC CHIP).
DMA Channel 3	Onboard ECP (default).
DMA Channel 4	Cascade for DMA controller 1.
DMA Channel 5	Available.
DMA Channel 6	Available.
DMA Channel 7	Available

### A-4 INTERRUPT MAP

#### NMI :

Parity check error.

#### IRQ (H/W):

0	System TIMER interrupt from TIMER 0.
1	KEYBOARD output buffer full.
2	Cascade for IRQ 8-15.
3	SERIAL port 2.
4	SERIAL port 1.
5	PARALLEL port 2.

6	FLOPPY DISK (SMC CHIP).
7	PARALLEL port 1.
8	RTC clock.
9	Available.
10	Available.
11	Available.
12	PS/2 Mouse.
13	MATH coprocessor.
14	Onboard HARD DISK (IDE1) channel.
15	Onboard HARD DISK (IDE1) channel.

### A-5 RTC & CMOS RAM MAP

RTC & CMOS:

00	Seconds.
01	Second alarm.
02	Minutes.
03	Minutes alarm.
04	Hours.
05	Hours alarm.
06	Day of week.
07	Day of month.
08	Month.
09	Year.
0A	Status register A.
0B	Status register B.
0C	Status register C.
0D	Status register D.
0E	Diagnostic status byte.
0F	Shutdown byte.
10	FLOPPY DISK drive type byte.
11	Reserve.
12	HARD DISK type byte.
13	Reserve.
14	Equipment type.
15	Base memory low byte.

- 16 Base memory high byte.
- 17 Extension memory low byte.
- 18 Extension memory high byte.
- 19-2d
- 2E-2F
- 30 Reserved for extension memory low byte.
- 31 Reserved for extension memory high byte.
- 32 DATE CENTURY byte.
- 33 INFORMATION FLAG.
- 34-3F Reserve.
- 40-7F Reserved for CHIPSET SETTING DATA.



---

 Appendix B
 

---

 B-1 POST CODES
 

---

**For BIOS 6.0 Code**

<b>POST (hex)</b>	<b>DESCRIPTION</b>
CFh	Test CMOS R/W functionality.
C0h	Early chipset initialization: <ul style="list-style-type: none"> <li>- Disable shadow RAM</li> <li>- Disable L2 cache (socket 7 or below)</li> <li>- Program basic chipset registers</li> </ul>
C1h	Detect memory <ul style="list-style-type: none"> <li>- Auto-detection of DRAM size, type and ECC.</li> <li>- Auto-detection of L2 cache (socket 7 or below)</li> </ul>
C3h	Expand compressed BIOS code to DRAM
C5h	Call chipset hook to copy BIOS back to E000 & F000 shadow RAM.
0h1	Expand the Xgroup codes locating in physical address 1000:0
02h	Reserved
03h	Initial Superio_Early_Init switch.
04h	Reserved
05h	<ol style="list-style-type: none"> <li>1. Blank out screen</li> <li>2. Clear CMOS error flag</li> </ol>
06h	Reserved
07h	<ol style="list-style-type: none"> <li>1. Clear 8042 interface</li> <li>2. Initialize 8042 self-test</li> </ol>
08h	<ol style="list-style-type: none"> <li>1. Test special keyboard controller for Winbond 977 series Super I/O chips.</li> <li>2. Enable keyboard interface.</li> </ol>
09h	Reserved
0Ah	<ol style="list-style-type: none"> <li>1. Disable PS/2 mouse interface (optional).</li> <li>2. Auto detect ports for keyboard &amp; mouse followed by a port &amp; interface swap (optional).</li> </ol>

	3. Reset keyboard for Winbond 977 series Super I/O chips.
0Ch	Reserved
0Dh	Reserved
0Eh	Test F000h segment shadow to see whether it is R/W-able or not. If test fails, keep beeping the speaker.
0Fh	Reserved
10h	Auto detect flash type to load appropriate flash R/W codes into the run time area in F000 for ESCD & DMI support.
11h	Reserved
12h	Use walking 1's algorithm to check out interface in CMOS circuitry. Also set real-time clock power status, and then check for override.
13h	Reserved
14h	Program chipset default values into chipset. Chipset default values are MODBINable by OEM customers.
15h	Reserved
16h	Initial Early_Init_Onboard_Generator switch.
17h	Reserved
18h	Detect CPU information including brand, SMI type (Cyrix or Intel) and CPU level (586 or 686).
19h	Reserved
1Ah	Reserved
1Bh	Initial interrupts vector table. If no special specified, all H/W interrupts are directed to PURIOUS_INT_HDLR & S/W interrupts to SPURIOUS_soft_HDLR.
1Ch	Reserved
1Dh	Initial EARLY_PM_INIT switch.
1Eh	Reserved
1Fh	Load keyboard matrix (notebook platform)
20h	Reserved
21h	HPM initialization (notebook platform)
22h	Reserved
23h	<ol style="list-style-type: none"><li>1. Check validity of RTC value: e.g. a value of 5Ah is an invalid value for RTC minute.</li><li>2. Load CMOS settings into BIOS stack. If CMOS</li></ol>

- checksum fails, use default value instead.
  - 3. Prepare BIOS resource map for PCI & PnP use. If ESCD is valid, take into consideration of the ESCD's legacy information.
  - 4. Onboard clock generator initialization. Disable respective clock resource to empty PCI & DIMM slots.
  - 5. Early PCI initialization:
    - Enumerate PCI bus number
    - Assign memory & I/O resource
    - Search for a valid VGA device & VGA BIOS, and put it into C000:0.
- |     |   |
|-----|---|
| 24h | Reserved  |
| 25h | Reserved  |
| 26h | Reserved  |
| 27h | Initialize INT 09 buffer  |
| 28h | Reserved  |
| 29h | <ol style="list-style-type: none"> <li>1. Program CPU internal MTRR (P6 &amp; PII) for 0-640K memory address.</li> <li>2. Initialize the APIC for Pentium class CPU.</li> <li>3. Program early chipset according to CMOS setup.<br/>Example: onboard IDE controller.</li> <li>4. Measure CPU speed.</li> <li>5. Invoke video BIOS.</li> </ol> |
| 2Ah | Reserved  |
| 2Bh | Reserved  |
| 2Ch | Reserved  |
| 2Dh | <ol style="list-style-type: none"> <li>1. Initialize multi-language</li> <li>2. Put information on screen display, including Award title, CPU type, CPU speed ....</li> </ol>   |
| 2Eh | Reserved  |
| 2Fh | Reserved  |
| 30h | Reserved  |
| 31h | Reserved  |
| 32h | Reserved  |
| 33h | Reset keyboard except Winbond 977 series Super I/O chips.   |

---

34h	Reserved
35h	Reserved
36h	Reserved
37h	Reserved
38h	Reserved
39h	Reserved
3Ah	Reserved
3Bh	Reserved
3Ch	Test 8254
3Dh	Reserved
3Eh	Test 8259 interrupt mask bits for channel 1.
3Fh	Reserved
40h	Test 8259 interrupt mask bits for channel 2.
41h	Reserved
42h	Reserved
43h	Test 8259 functionality.
44h	Reserved
45h	Reserved
46h	Reserved
47h	Initialize EISA slot
48h	Reserved
49h	<ol style="list-style-type: none"><li>1. Calculate total memory by testing the last double word of each 64K page.</li><li>2. Program write allocation for AMD K5 CPU.</li></ol>
4Ah	Reserved
4Bh	Reserved
4Ch	Reserved
4Dh	Reserved
4Eh	<ol style="list-style-type: none"><li>1. Program MTRR of M1 CPU</li><li>2. Initialize L2 cache for P6 class CPU &amp; program CPU with proper cacheable range.</li><li>3. Initialize the APIC for P6 class CPU.</li><li>4. On MP platform, adjust the cacheable range to smaller one in case the cacheable ranges between each CPU are not identical.</li></ol>
4Fh	Reserved
50h	Initialize USB

---

---

51h	Reserved
52h	Test all memory (clear all extended memory to 0)
53h	Reserved
54h	Reserved
55h	Display number of processors (multi-processor platform)
56h	Reserved
57h	1. Display PnP logo 2. Early ISA PnP initialization - Assign CSN to every ISA PnP device.
58h	Reserved
59h	Initialize the combined Trend Anti-Virus code.
5Ah	Reserved
5Bh	(Optional Feature) Show message for entering AWDFLASH.EXE from FDD (optional)
5Ch	Reserved
5Dh	1. Initialize Init_Onboard_Super_IO switch. 2. Initialize Init_Onboard_AUDIO switch.
5Eh	Reserved
5Fh	Reserved
60h	Okay to enter Setup utility; i.e. not until this POST stage can users enter the CMOS setup utility.
61h	Reserved
62h	Reserved
63h	Reserved
64h	Reserved
65h	Initialize PS/2 Mouse
66h	Reserved
67h	Prepare memory size information for function call: INT 15h ax=E820h
68h	Reserved
69h	Turn on L2 cache
6Ah	Reserved
6Bh	Program chipset registers according to items described in Setup & Auto-configuration table.
6Ch	Reserved

---

---

6Dh	<ol style="list-style-type: none"><li>1. Assign resources to all ISA PnP devices.</li><li>2. Auto assign ports to onboard COM ports if the corresponding item in Setup is set to "AUTO".</li></ol>
6Eh	Reserved
6Fh	<ol style="list-style-type: none"><li>1. Initialize floppy controller</li><li>2. Set up floppy related fields in 40:hardware.</li></ol>
70h	Reserved
71h	Reserved
72h	Reserved
73h	(Optional Feature) Enter AWDFLASH.EXE if : - AWDFLASH is found in floppy drive. - ALT+F2 is pressed
74h	Reserved
75h	Detect & install all IDE devices: HDD, LS120, ZIP, CDROM.....
76h	Reserved
77h	Detect serial ports & parallel ports.
78h	Reserved
79h	Reserved
7Ah	Detect & install co-processor
7Bh	Reserved
7Ch	Reserved
7Dh	Reserved
7Eh	Reserved
7Fh	<ol style="list-style-type: none"><li>1. Switch back to text mode if full screen logo is supported. - If errors occur, report errors &amp; wait for keys - If no errors occur or F1 key is pressed to continue:     ◆Clear EPA or customization logo.</li></ol>
80h	Reserved
81h	Reserved
82h	<ol style="list-style-type: none"><li>1. Call chipset power management hook.</li><li>2. Recover the text fond used by EPA logo (not for full screen logo)</li><li>3. If password is set, ask for password.</li></ol>
83h	Save all data in stack back to CMOS

---

---

84h	Initialize ISA PnP boot devices
85h	<ol style="list-style-type: none"><li>1. USB final Initialization</li><li>2. NET PC: Build SYSID structure</li><li>3. Switch screen back to text mode</li><li>4. Set up ACPI table at top of memory.</li><li>5. Invoke ISA adapter ROMs</li><li>6. Assign IRQs to PCI devices</li><li>7. Initialize APM</li><li>8. Clear noise of IRQs.</li></ol>
86h	Reserved
87h	Reserved
88h	Reserved
89h	Reserved
90h	Reserved
91h	Reserved
92h	Reserved
93h	Read HDD boot sector information for Trend Anti-Virus code
94h	<ol style="list-style-type: none"><li>1. Enable L2 cache</li><li>2. Program boot up speed</li><li>3. Chipset final initialization.</li><li>4. Power management final initialization</li><li>5. Clear screen &amp; display summary table</li><li>6. Program K6 write allocation</li><li>7. Program P6 class write combining</li></ol>
95h	<ol style="list-style-type: none"><li>1. Program daylight saving</li><li>2. Update keyboard LED &amp; typematic rate</li></ol>
96h	<ol style="list-style-type: none"><li>1. Build MP table</li><li>2. Build &amp; update ESCD</li><li>3. Set CMOS century to 20h or 19h</li><li>4. Load CMOS time into DOS timer tick</li><li>5. Build MSIRQ routing table.</li></ol>
FFh	Boot attempt (INT 19h)

---

Page Left Blank

---



Appendix C

**NOTE:**

The "**LOAD Optimized DEFAULTS**" function loads the system default data directly from ROM and initializes the associated hardware properly. This function will be necessary when you accept this mainboard, or the system CMOS data is corrupted.

CMOS Setup Utility - Copyright ( C ) 1984-1998

Standard CMOS Feature	Frequency/Voltage Control
Advanced BIOS Feature	Load Fail-Safe Defaults
Advanced Chipset Feature	Load Optimized Defaults
Integrated Peripherals	Set Supervisor Password
Power Management Settings	<input type="text" value="Load Optimized Defaults (Y/N)? Y"/>
PnP/PCI Configurations	Exit Without Saving
PC Health Status	

Esc : Quit	↑ ↓ ← → : Select Item
F10 : Save & Exit Setup	

Time, Date, Hard Disk Type....

**LOAD Optimized DEFAULTS**

Page Left Blank

---

Appendix D

D-1 GHOST 5.1 Quick User's Guide

Installation is very easy. You only need to copy the **Ghost5** folder or **Ghost.exe** to your hard disk.

The current market version is for single **Client**, so the LPT and NetBios portions will not be explained further.

**Description of Menus**

**Ghost** clones and backs up **Disk** and **Partition**.

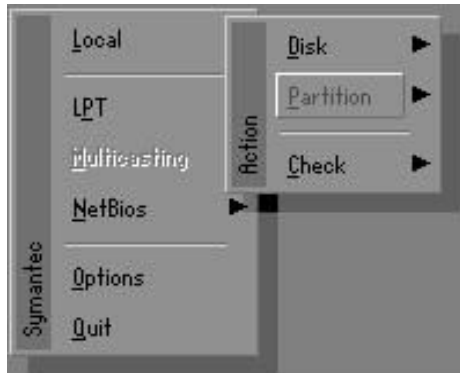

In which **Disk** indicates hard disk options  
**Partition** indicates partition options  
**Check** indicates check options

**Disk**

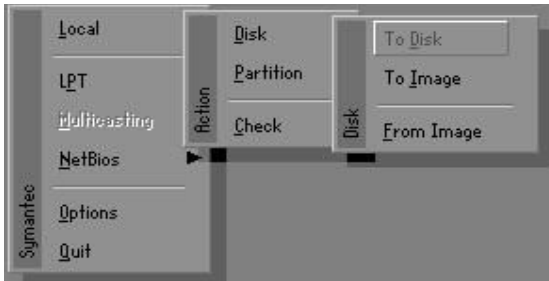

**There are 3 hard disk functions:**

- 1. Disk To Disk (disk cloning)
- 2. Disk To Image (disk backup)
- 3. Disk From Image (restore backup)

**Important!**

- 1. To use this function, the system must have at least 2 disks. Press the **Tab** key to move the cursor.
- 2. When restoring to a destination disk, all data in that disk will be completely destroyed.

**Disk To Disk (Disk Cloning)**

- 1. Select the location of the **Source** drive.
- 2. Select the location of the **Destination** drive.

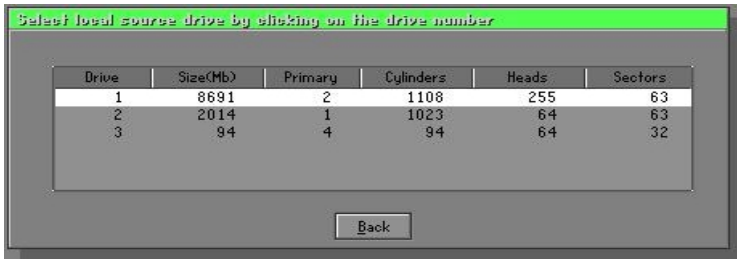

- 3. When cloning a disk or restoring the backup, set the required partition size as shown in the following figure.

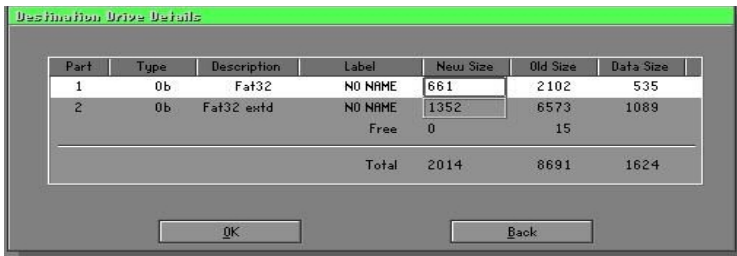

- Click OK to display the following confirmation screen. Select **Yes** to start.

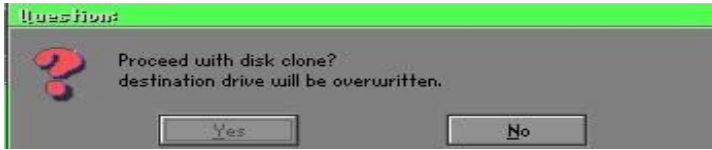

### Disk To Image (Disk Backup)

- Select the location of the Source drive.

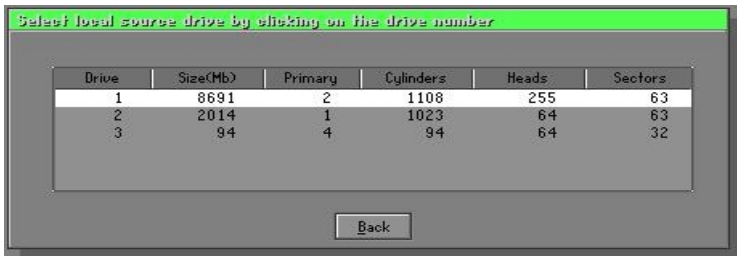

- Select the location for storing the backup file.

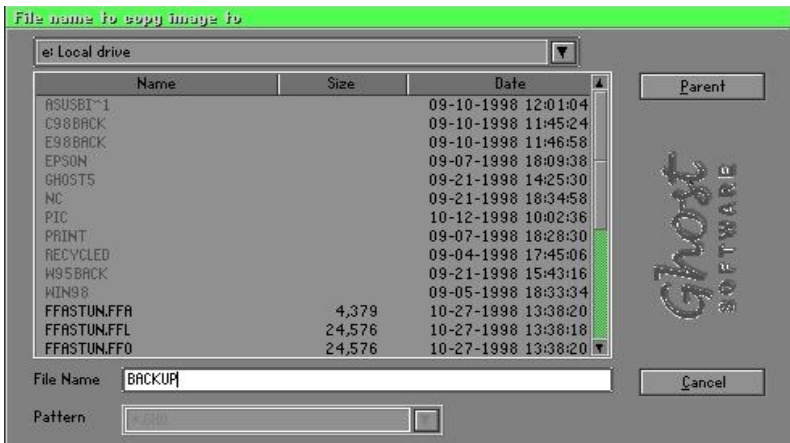

3. Click **OK** to display the following confirmation screen. Select **Yes** to start.



### Disk From Image (Restore Backup)

1. Select the Restore file.

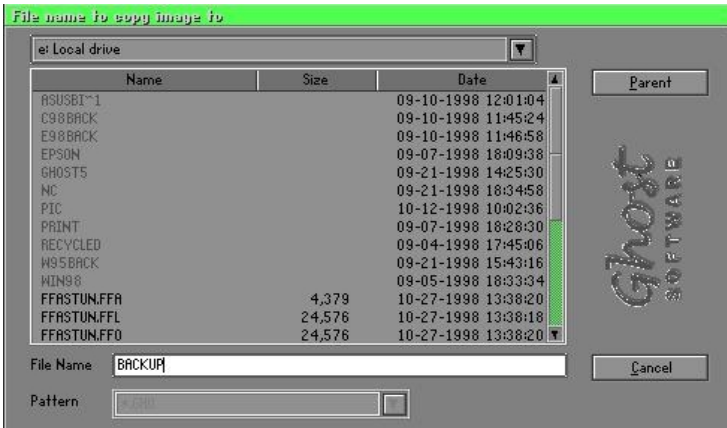

2. Select the **Destination** drive of the disk to be restored.

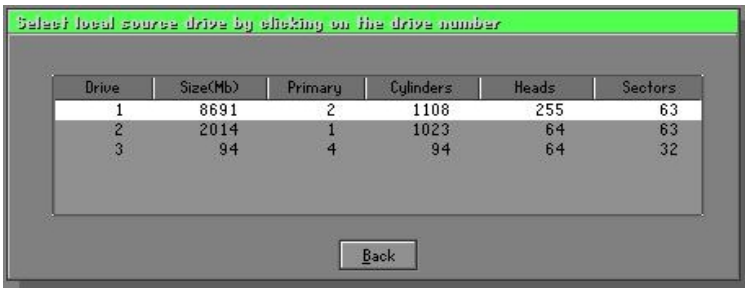

- 3. When restoring disk backup, set the required partition size as shown in the following figure.

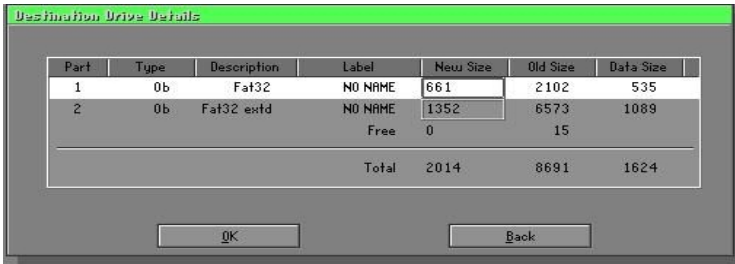

- 4. Click **OK** to display the following confirmation screen. Select **Yes** to start.

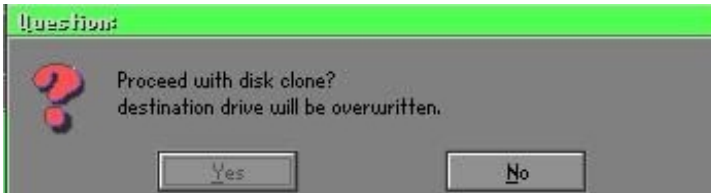

**Partition**

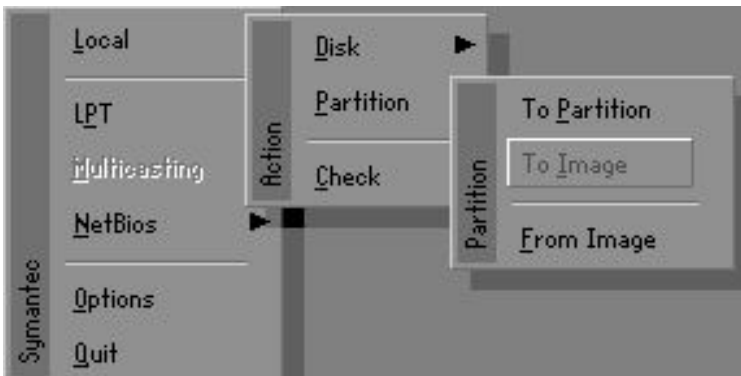

There are 3 partition functions:

- 1. **Partition To Partition** (partition cloning)
- 2. **Partition To Image** (partition backup)
- 3. **Partition From Image** (restore partition)

**Partition To Partition (Partition Cloning)**

The basic unit for partition cloning is a partition. Refer to disk cloning for the operation method.

**Partition To Image (Partition Backup)**

- 1. Select the disk to be backed up.

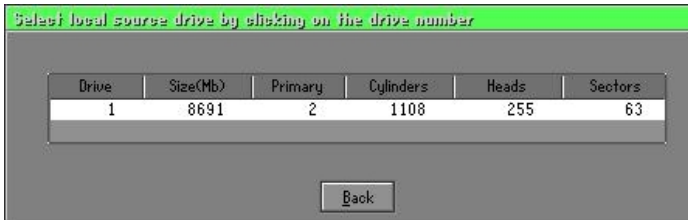

- 2. Select the first partition to be backed up. This is usually where the operating system and programs are stored.

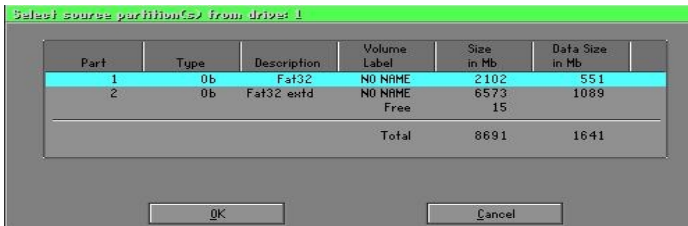



3. Select the path and file name for storing the backup file.

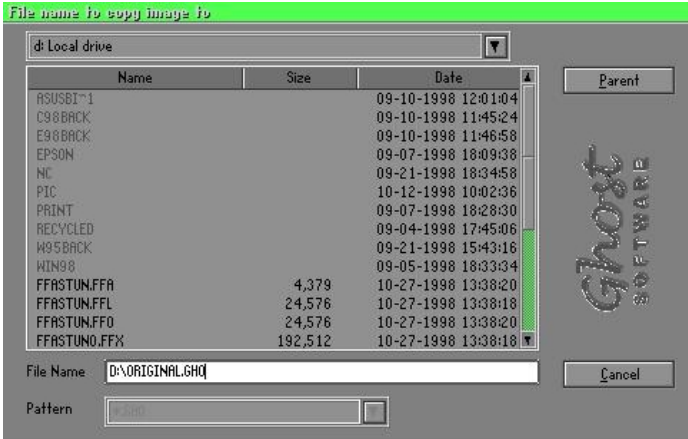

4. Is the file compressed? There are 3 options:

- (1) No: do not compress data during backup
- (2) Fast: Small volume compression
- (3) High: high ratio compression. File can be compressed to its minimum, but this requires longer execution time.

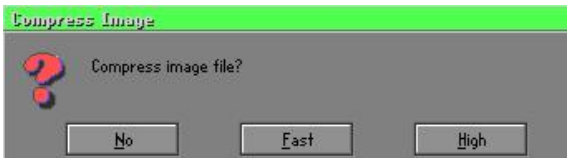

5. During confirmation, select Yes to start performing backup.



### Partition From Image (Restore Partition)

1. Select the backup file to be restored.

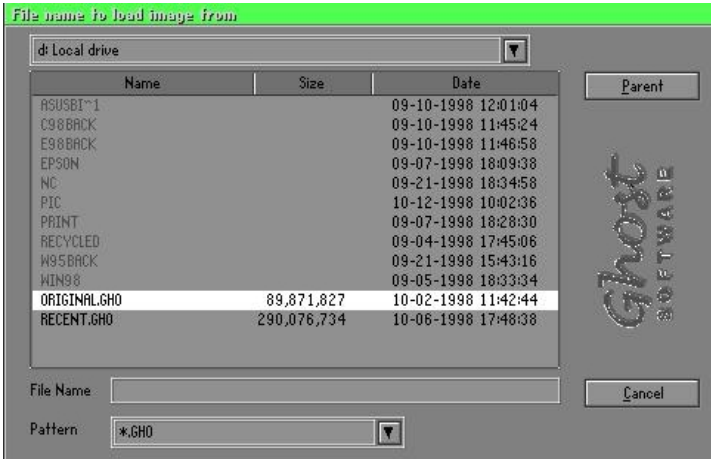

2. Select the source partition.



3. Select the disk to be restored.



4. Select the partition to be restored.



5. Select Yes to start restoring.

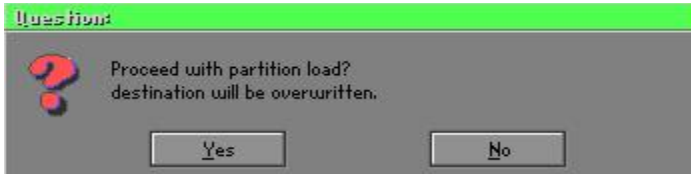

**Check**

This function checks the hard disk or backup file for backup or restoration error due to FAT or track error.