



User's Manual

**A Pentium 4 Processor based AGP
(4X) mainboard (100MHz)**

TRADEMARK

All products and company names are trademarks or registered trademarks of their respective holders.

These specifications are subject to change without notice.

*Manual Revision 1.0
June 08, 2001*

Table of Contents

	<i>Page</i>
Section 1	<i>Introduction</i>
	Components Checklist 1-1
	<i>Overview</i>
	Terminology 1-2
	System Overview 1-4
	Chipset Components 1-5
	Intel Pentium 4 Processors 1-6
	Direct Rambus 1-7
	Bandwidth Overview 1-8
	Accelerated Graphics Port 1-9
	Ultra ATA66/100 1-9
	Hardware Monitoring 1-8
	Mainboard Form-Factor 1-10
	I/O Shield Connector 1-11
	Power-On/Off (Remote) 1-11
	System Block Diagram 1-12
Section 2	<i>Features</i>
	Mainboard Features 2-1
Section 3	<i>Installation</i>
	Mainboard Detailed Layout 3-2
	<i>Easy Installation Procedure</i>
	CPU Installation 3-3
	Jumper Settings 3-7
	System Memory Configuration 3-9
	Device Connectors 3-16
	External Modem Ring-in Power ON and Keyboard Power ON Function (KBPO) 3-20
	STR Function 3-22

Section 4***Award BIOS Setup***

Main Menu	4-1
Standard CMOS Setup	4-3
Advanced BIOS Features	4-7
Advanced Chipset Features	4-10
Integrated Peripherals	4-12
Power Management Setup	4-17
PNP/PCI Configuration Setup	4-20
PC Health Status	4-22
Frequency/Voltage Control	4-24
Defaults Menu	4-25
Supervisor/User Password Setting	4-26
Exit Selecting	4-27

Section 5***Driver Installation***

850 and Sound Driver Installation	5-1
-----------------------------------------	-----

Section 6***PCI Audio Sound***

CMI8738 Features	6-1
------------------------	-----

Section 7***Appendix******Appendix A***

Update Your System BIOS	A-1
-------------------------------	-----

Appendix B

GHOST 5.1/6.03 Quick User's Guide	B-1
-----------------------------------------	-----

Appendix C

EEPROM BOIS Remover	C-1
---------------------------	-----

Section 1
INTRODUCTION

Components Checklist

Package Contents

- A. (1) Mainboard
- B. (1) User's manual
- C. (1) Floppy ribbon cable
- D. (1) ATA-66/100 Hard drive ribbon cable
- E. (2) Continuity Module
- F. (1) Driver and utility

Optional Item

- G. (1) USB Cable

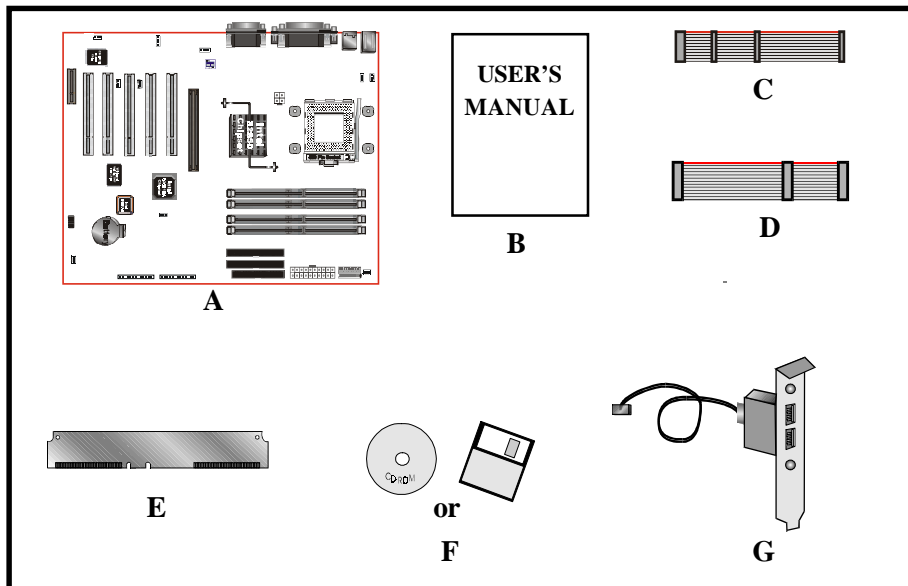

Terminology

◆ **Accelerated Graphics Port (AGP)**

The AGP interface that is in the MCH, it supports a subset of 3.3V, 66MHz components, 3.3V 66/133 MHz AGP 2.0 compliant components, and the new 1.5V 66/266 MHz components.

◆ **CMD, SCK, SIO**

CMOS side-band signals that make up the side-band bus used to communicate with the RDRAM devices without using the normal channel interface. CMD is the signal used for framing operations on SIO. SCK is the clock of the side-band bus, and SIO is the bidirectional data signal of the side-band bus.

◆ **Continuity Module/C-RIMM**

A RIMM module that does not have any memory devices on the module. This module serves as a pass through to propagate the Rambus channel to the next RIMM 184-pin socket.

◆ **Core**

The internal base logic in the MCH.

◆ **Device**

A single Direct RDRAM Device.

◆ **DRCG**

Direct Rambus Clock Generator. The DRCG provides the 400MHz channel clock for the mainboard Rambus Channel.

◆ **LPC I/O**

The Low Pin Count interface super I/O component.

◆ **Host Bus**

This term bus is used synonymously with CPU.

- ◆ **Rambus channel**

Common name referring to the high speed interface between the system memory controller MCH(850) and RDRAM devices.

- ◆ **RDRAM**

Rambus Dynamic Random - Access Memory.

- ◆ **RIMM**

Rambus Interface Memory Module.

- ◆ **RSL**

Rambus Signal Level is the name of the signaling technology used by Rambus.

- ◆ **STR (Suspend-To-RAM)**

A lower power state than active. In the STR state, the system state is stored in main memory and all unnecessary system logic is turned off. Only main memory and logic required to wake the system remain powered.

Introduction

System Overview

This board is designed with Intel® 850 chipset. The Intel® 850 chipset includes MCH(FW82850), ICH2(FW82801BA) and FWH (N82802AB) three chips. The Intel® 850 chipset is the third generation desktop chipset designed for Intel's FC-PGA socket 423 package architecture and support the 4X capability of the AGP 2.0 Interface Specification and 400MHz Direct RDRAM. The 400MHz, 16bit, double clocked Direct RDRAM interface provides 1.6GB/s access to main memory. A new chipset component interconnect, the hub interface, is designed into the Intel® 850 chipset to provide more efficient communication between chipset components.

Support of AGP 4X, 400MHz Direct RDRAM and the hub interface provides a balanced system architecture for the Pentium® 4 or later Socket 423 architecture processor minimizing bottlenecks and increasing system performance. By increasing memory bandwidth to 1.6GB/s through the use of AGP 4X, the Intel® 850 chipset will deliver the data throughput necessary to take advantage of the high performance provided by the powerful Pentium® 4 or later Socket 423 architecture processor.

The Intel® 850 chipset architecture removes the requirement for the ISA expansion bus that was traditionally integrated into the I/O subsystem of Intel chipsets. This removes many of the conflicts experienced when installing hardware and drivers into legacy ISA systems. The elimination of ISA will provide true plug-and-play for the Intel® 850 platform.

Intel® 850 chipset contains three core components: the Memory Controller Hub (MCH), the I/O Controller Hub (ICH) and the Firmware Hub (FWH). The MCH integrates the 400MHz, Pentium® 4 processor bus controller, AGP 2.0 controller, 400MHz direct RDRAM controller and a high-speed hub interface for communication with the ICH2. The ICH2 integrates an UltraATA/66/100 controller, USB host controller, LPC interface controller, FWH interface controller, PCI interface controller, and a hub interface for communication with the MCH. The Intel® 850 chipset will provide the data buffering and interface arbitration required to ensure that system interfaces operate efficiently and provide the system bandwidth necessary to obtain peak performance the Pentium® 4 or later Socket 423 architecture.

Chipset Components

The Intel® 850 chipset consists of the Memory Controller Hub (MCH), the I/O Controller Hub (ICH2) and the Firmware Hub (FWH).

◆ **Memory Controller Hub (MCH)**

The MCH provides the interconnect between the Direct RDRAM and the system logic. It integrates:

- Support for single processor with a data transfer rate of 400MHz.
- 400MHz Direct RDRAM interface supporting 2GB of Direct RDRAM.
- 1X, 2X, 4X, 1.5V AGP interface (Only support 1.5V on AGP interface).
- Downstream hub link for access to the ICH2.

◆ **I/O Controller Hub (ICH2)**

The I/O controller Hub provides the I/O subsystem with access to the rest of the system. Additionally, it integrates many I/O functions. The ICH integrates:

- Upstream hub link for access to the MCH
- 2 Channel Ultra ATA/33/66/100 Bus Master IDE controller
- USB controller
- SMBus controller
- FWH interface
- LPC interface
- PCI 2.2 interface
- Integrated System Management Controller
- Integrated LAN Controller

◆ **Firmware Hub (FWH)**

The FWH component is a key element to enabling a new security and manageability infrastructure for the PC platform. The device operates under the FWH interface and protocol. The hardware features of this device include a unique Random Number Generator (RNG), register-based locking, and hardware-based locking.

Introduction

Intel Pentium 4 processors

Formally known as the Willamette, the Pentium™ 4 is the next generation IA-32 processor from Intel. This next generation design is based upon a new micro-architecture that brings higher clock speeds and performance than previous processors could deliver. Among other advanced features the Pentium 4 offers Streaming SIMD extensions 2, Advanced Dynamic Execution, Hyper Pipelined Technology, and a 400MHz system bus.

Streaming SIMD Extensions 2

Building upon the foundations of core features of their previous line of processors the Pentium III, this new version introduces Streaming SIMD Extensions 2 technology commonly referred to as SSE2. But what does this mean? SIMD stands for Single Instruction Multiple Data. Usually, processors process one data element in one instruction, called Single Instruction Single Data, or SISD. In contrast, with Single Instruction Single Data (SISD), SIMD has the ability to process more than one piece of data element during one instruction.

This technology is useful for 3D graphics applications that handle considerable amounts of floating-point numbers. With SIMD applications such as 3D graphics will be able to processor more data per instruction when equates to better performance. This technology adds 144 new instructions to the CPU core that can be used in a wide variety of applications. Software programmers can for example, take advantage of these new instructions and write more optimized code that take advantage of newer SIMD double-precision floating-point, integer, and cache ability instructions. In theory this will enable better next generation services such as Interactive Digital TV to be produced.

Advanced Dynamic Execution

Advanced Dynamic Execution describes the improved implementation and abilities over the older P6 processor line's out-of-order decoupled super scalar execution. Dynamic execution allows instructions to the processor to be executed without the need to do so in order. The ability to do this can add a significant performance increase versus ordered execution.

Hyper Pipelined Technology & 400MHz System Bus

Hyper Pipelined Technology doubles the pipeline depth the Pentium 4 delivers to 20 stages. This significantly increases the performance and frequency capabilities. Pentium 4 also introduces a 400MHz system bus as opposed to the 100 and

133MHz bus seen in previous Pentium III processors. This allows 3.2Gbytes per second of throughput while the Pentium III had a limited 1.06Gbyte/s throughput. Willamette will reportedly be introduced in the 0.18-micron using aluminum.

For more information about all the cool new features the Pentium 4 delivers check out the Intel website at <http://www.intel.com>

Direct Rambus

The Direct Rambus (RDRAM) initiative will provide the memory bandwidth necessary to obtain optional performance from the Pentium 4 or later 423-pin socket processor as well as a high-performance AGP graphics controller. The MCH RDRAM interface supports 400MHz operation; the latter delivers 1.6GB/s of theoretical memory bandwidth; twice the memory bandwidth of 100MHz SDRAM system. Coupled with the greater bandwidth, the RDRAM protocol, which is heavily pipelined, provides substantially more efficient data transfer. The RDRAM memory interface can achieve greater than 95% utilization of the 1.6GB/s theoretical maximum bandwidth. The Figure 1 is the example picture for RIMM Module to plug in the RIMM socket.

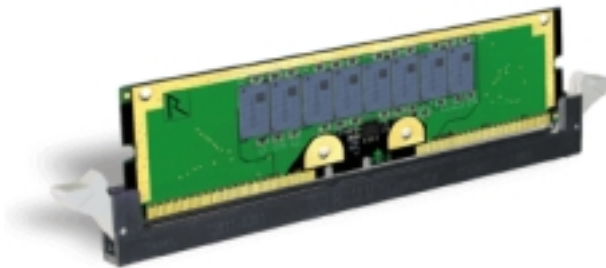

Figure 1: RIMM Module

Introduction

Bandwidth Overview

Table 1 provides a summary of the bandwidth requirements for the Intel® 850 chipset.

Interface	Clock Speed (MHz)	Samples Per Clock	Data Rate (Mega-samples/s)	Data Width (Bytes)	Bandwidth (MB/s)
CPU Bus	100	4	400	8	3200
RDRAM	400	2	800	4	3200
AGP 2.0	66.6	4	266	4	1066
Hub Link	66.6	4	266	1	266
PCI 2.2	33.3	1	33.3	4	133

Table 1: Intel® 850 platform Bandwidth Summary

Accelerated Graphics Port (AGP or A.G.P.)

Typically, 3D graphics rendering requires a tremendous amount of memory, and demands ever increasing throughput speed as well. As 3D products for the personal computer become more and more popular, these demands will only increase. This will cause a rise in costs for both end users and manufacturers. Lowering these costs as well as improving performance is the primary motivation behind AGP. By providing a massive increase in the bandwidth available between the video card and the processor, it will assist in relieving some of these pressures for quite sometime.

The board provides the AGP 2.0 interface. The AGP Interface Specification revision 2.0 enhances the functionality of the original AGP Interface Specification (revision 1.0) by allowing 4X data transfers (4 data samples per clock) and 1.5 volt (power supply) operation. The AGP 2.0 interface, along with Direct Rambus memory technology, allows graphics controllers to access main memory at over 1GB/s. In order to match the 1X, 2X and 4X AGP Card. The board used the Universal AGP connector. (1.5 volt AGP Card supports only).

Ultra ATA/66/100

The ICH2 provides two channel Ultra ATA/66/100 Bus Master IDE controllers, that support Ultra ATA/66/100 protocols, perfect for such demanding applications as real-time video, multimedia, and high performance operating system. A new IDE cable is required for Ultra ATA/66/100. This cable is an 80 conductor cable; however the connectors are, of course, backwards compatible with ATA/33.

Hardware Monitoring

Hardware monitoring allows you to monitor various aspects of your systems operations and status. The features include CPU temperature, voltage and RPM of fan.

Introduction

Mainboard Form-Factor

The board is designed with ATX form factor - the latest industry standard of chassis. The ATX form factor is essentially a Baby-AT baseboard rotated 90 degrees within the chassis enclosure and a new mounting configuration for the power supply. With these changes the processor is relocated away from the expansion slots, allowing them all to hold full length add-in cards. ATX defines a double height aperture to the rear of the chassis which can be used to host a wide range of onboard I/O. Only the size and position of this aperture is defined, allowing PC manufacturers to add new I/O features (e.g.; TV input, TV output, joystick, modem, LAN, audio, etc.) to systems. This will help systems integrators differentiate their products in the marketplace, and better meet your needs.

- By integrating more I/O down onto the board and better positioning the hard drive and floppy connectors material cost of cables and add-in cards is reduced.
- By reducing the number of cables and components in the system, manufacturing time and inventory holding costs are reduced and reliability will increase.
- By using an optimized power supply, it's possible to reduce cooling costs and lower acoustical noise. An ATX12V power supply, which has a side-mounted fan, allows direct cooling of the processor and add-in cards making a secondary fan or active heatsink unnecessary in most system applications.

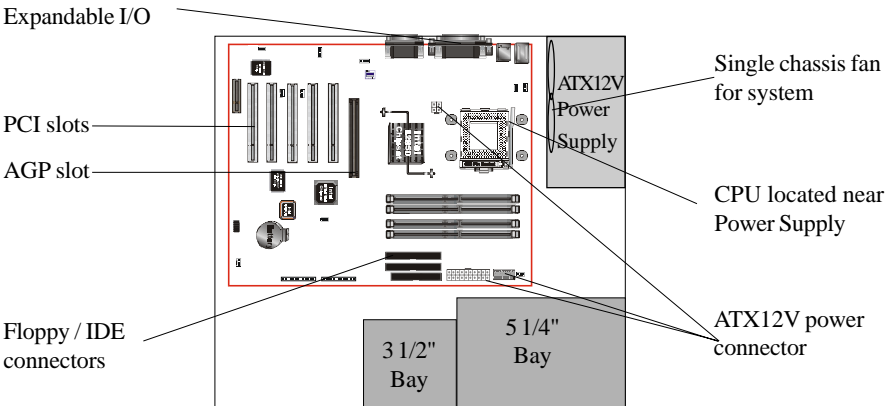

Figure 2: Summary of ATX12V chassis features

I/O Shield Connector

The board is equipped with an I/O back panel. Please use the appropriate I/O shield (figure 3).

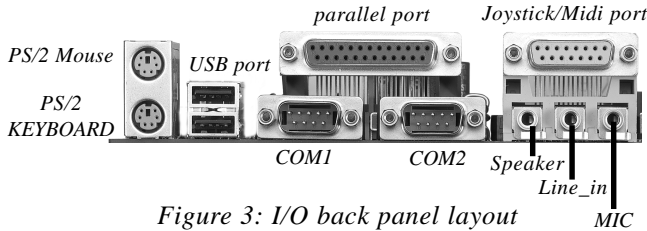

Figure 3: I/O back panel layout

Power-On/Off (Remote)

The board has a single 20-pin, 6-pin and 4-pin connector for ATX12V power supplies. For ATX12V power supplies that support the **Remote On/Off** feature, this should be connected to the systems front panel for system Power On/Off button. The systems power On/Off button should be a momentary button that is normally open.

The board has been designed with “Soft Off” functions. You can turn Off the system from one of two sources: The first is the front panel Power On/Off button, and the other is the “Soft Off” function (coming from the BOARD’s onboard circuit controller) that can be controlled by the operating system such as Windows® 95/98 and Windows® 2000 to Shutdown the system.

Note: For maintaining the RDRAM power during STR (ACPI S3) function, it is strongly recommend to use ATX12V power supplies that have a +5VSB current of (\geq) 1A (1000mA). Please check the 5VSB’s specification that has been printed on the ATX12V power supply’s outer case.

Note: The board requires a minimum of 250 Watt ATX 12V power supply to operate. Your system configuration (amount of memory, add-in cards, peripherals, etc.) may exceed the minimum power requirement but to ensure that adequate power is provided, use a 300 Watt (or greater) ATX 12V power supply.

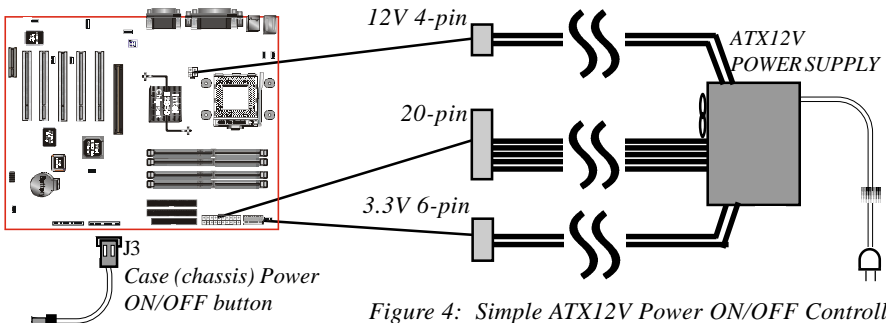

Figure 4: Simple ATX12V Power ON/OFF Controller

Introduction

System Block Diagram

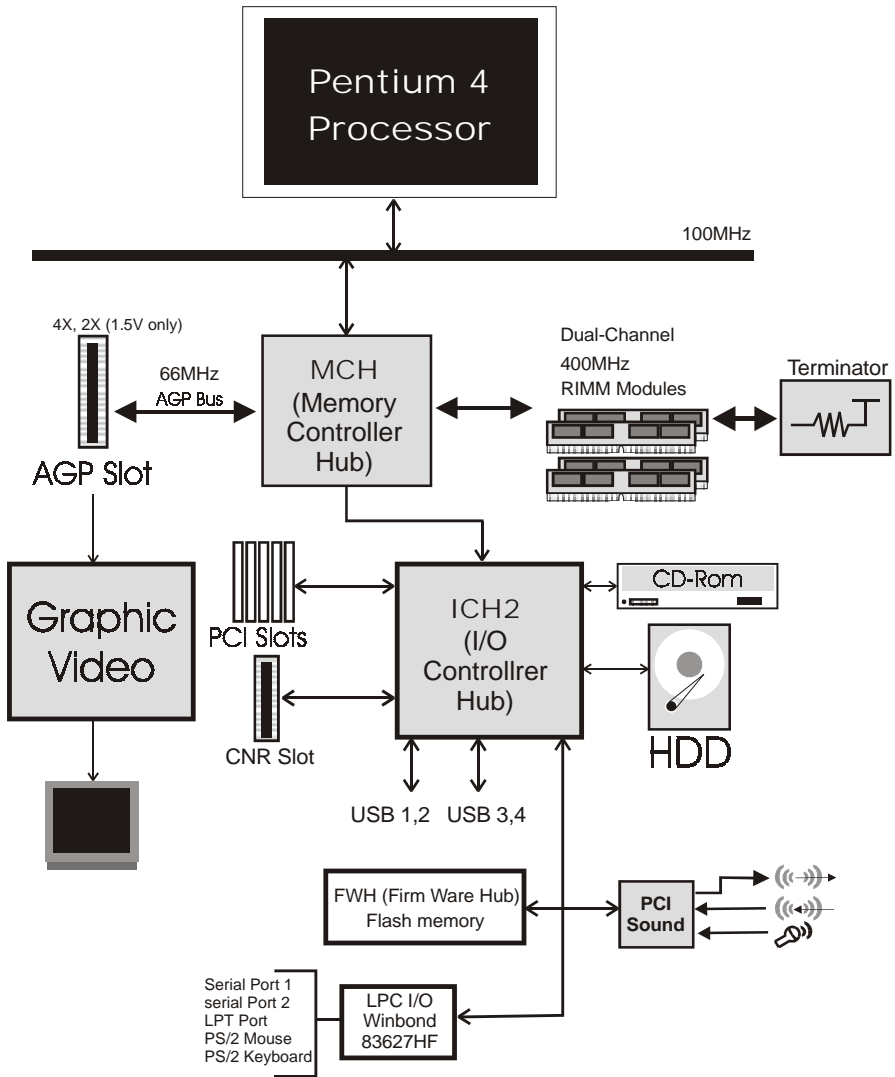

Figure 5: System Block Diagram

Mainboard Features:

◆ **PROCESSOR**

- Intel[®] Pentium 4 Processor with FC-PGA socket 423 package: Operating at 1.3~1.5 GHz

◆ **CHIPSET**

- Intel 82850 AGPset

◆ **DRAM MODULE**

- 184pin RIMM x 4 for PC800 Memory
- DRAM Size: 64MB to 2GB (max. 32 Devices)

◆ **EXPANSION SLOT**

- PCI x 5, 4X AGP x 1 (1.5V only)
- CNR slot x 1 (Shared) for communication and network riser card

◆ **ONBOARD I/O**

- Winbond 83627HF-AW LPC I/O integrated with K/B , Mouse, FDD, Parallel and Serial, Fast IR and Power-ON controllers

◆ **ONBOARD PCI / IDE**

Intel 82801BA/ICH2 Controller

- PCI Rev. 2.2 Compliant
- ACPI Compliant Power Management
- AC97 2.1/2.0 Compliant Link for Audio CODEC
- PCI Bus IDE Port with PIO /Ultra DMA-33/66/100 x 2 (Up to 4 Devices)

Features

- CNR supports multi-channel audio, V.90 analog modem, Home PNA, 10/100 LAN

◆ I/O CONNECTOR

- PS/2 Mouse and PS/2 style Keyboard

◆ USB

- USB connector x 4 (2 for Opt.)

◆ C-Media CMI8737/PCI-SX PCI sound chip

◆ BIOS

- Intel 82802AB/FWH (4MB)

◆ EXTENDED FUNCTION

- Supports exclusive USDM(Unified System Diagnostic Manager) and Hardware Monitoring Function by W83627HF-AW
- Supports exclusive KBPO (Keyboard Power ON)
- Supports STR (Suspend To RAM) power saving Function
- Supports CPU Clock Settings via DIP Switch
- Supports CPU Vcore, AGP and RDRAM Voltage Settings via BIOS
- Supports Wake-On-LAN Function

◆ FORM FACTOR

- 305mm x 245mm ATX Size

Section 3 INSTALLATION

Mainboard Detailed Layout

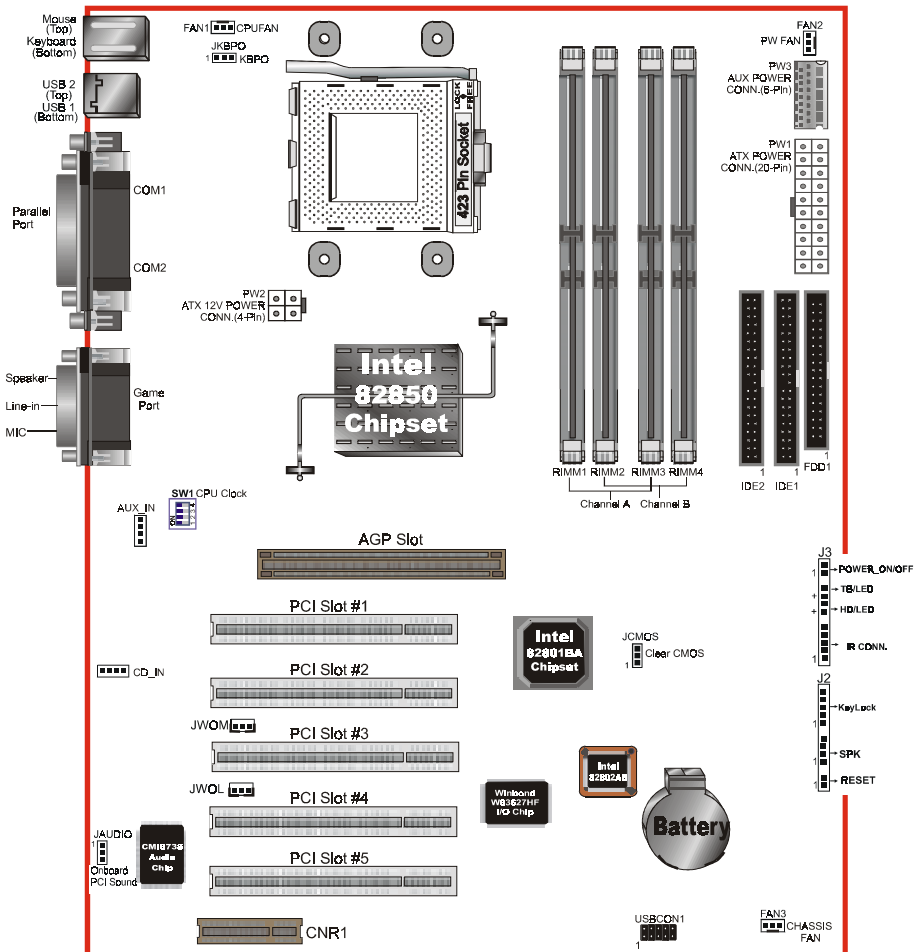

Figure 1

Installation

Easy Installation Procedure

The following must be completed before powering on your new system:

- 3-1. CPU Installation**
- 3-2. Jumper Settings**
- 3-3. System memory Configuration**
- 3-4. Device Connectors**
- 3-5. External Modem Ring-in Power ON and Keyboard Power ON Functions (KBPO)**
- 3-6. STR Function**

Section 3-1 CPU Installation

Install the mainboard to the chassis:

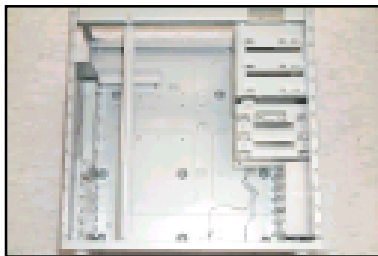

Figure 2

Step 1

The 4 new mounting holes on the chassis are for additional support for P4 CPU heat-sink on the mainboard.

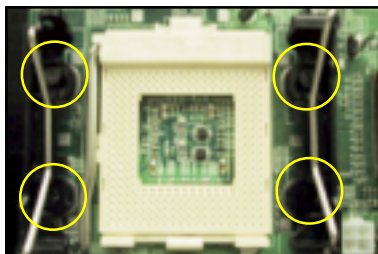

Figure 3

Step 2

Please remove 4 sets of plastic push-pins as indicated. Remove the white pins first, then black pins as indicated.

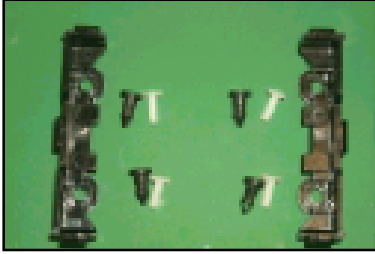

Figure 4

Step 3

There are 4 screws and 2 CPU retention modules.

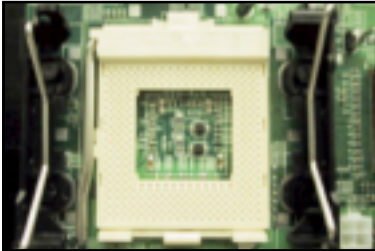

Figure 5

Step 4

Fit the screws with 2 CPU retention modules on the chassis.

CPU Insertion:

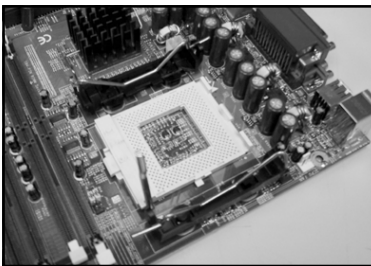

Figure 6

Step 1

Open the socket by raising the actuation lever.

Installation

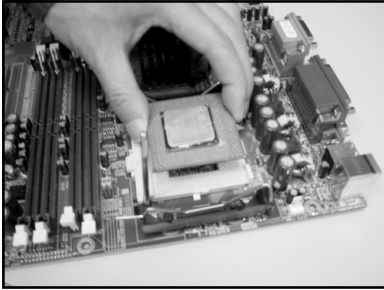

Figure 7

Step 2

Insert the processor.

Ensure proper pin 1 orientation by aligning the FC-PGA corner marking with the socket corner closest to the actuation arm tip. The pin field is keyed to prevent mis-oriented insertion.

Don't force processor into socket. If it does not go in easily, check for mis-orientation and debris. Make sure the processor is fully inserted into the socket on all sides.

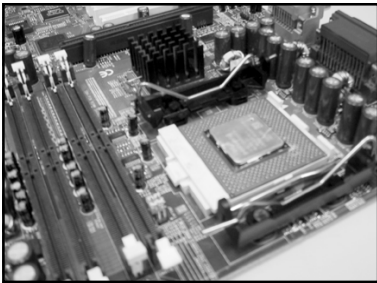

Figure 8

Step 3

Close the socket by lowering and locking the actuation lever.

Note: Intel's reference design thermal solution is an active heatsink; an extruded aluminum heatsink based and a fan attached to the top on the fin array. (See Figure 9)

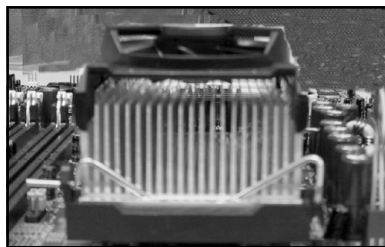
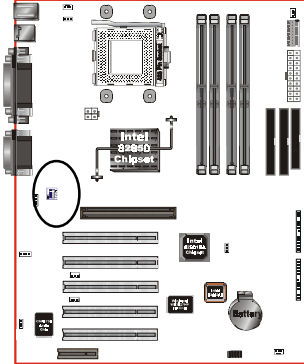

Figure 9

Section 3-2 Jumper Settings



SW1



CPU Clock Selection

SW1				CPU (MHz)
1	2	3	4	
ON	ON	ON	ON	100MHz (Default)
OFF	ON	ON	ON	103MHz *
ON	OFF	OFF	ON	105MHz *
OFF	OFF	OFF	ON	108MHz *
ON	ON	OFF	ON	110MHz *
ON	OFF	ON	OFF	115MHz *
OFF	OFF	ON	OFF	118MHz *
ON	ON	ON	OFF	120MHz *
OFF	ON	ON	OFF	122MHz *
OFF	OFF	OFF	OFF	125MHz *
OFF	ON	OFF	OFF	133MHz *

*reserved

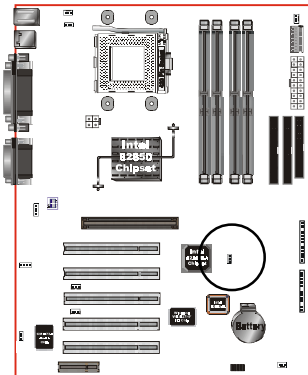

JCMOS



CMOS Clear

1-2 Normal (Default)

2-3 Clear CMOS

Installation

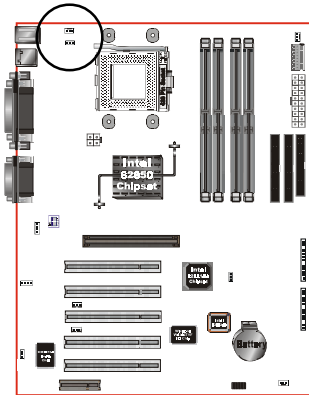

JKBPO

- 1
- 1-2 Enabled
 - 2-3 Disabled (Default)

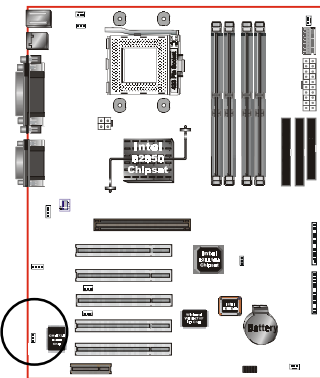

JAUDIO

- 1
- 1-2 Enabled (Default)
 - 2-3 Disabled

Section 3-3 System RIMM Memory Module Configuration

Memory Layout

The board supports two channels (4) 184-pin RIMMs (Rambus Interface Memory Module) as shown in Figure 10. The RIMMs can be RIMM and C-RIMM (Continuity RIMM) only. RIMM modules have Rambus channel signals as their memory interface. A RIMM module may contain up to a maximum of 16 RDRAM devices. All RDRAM devices on a RIMM must have the same timing characteristics. Empty RIMM sockets must be populated with continuity modules (C-RIMM). These modules have no memory on them and are used to propagate the channel to the next RIMM socket. Figure 12, 13, 14 & 15 provide a general diagram of a RIMM module and installations of RIMM/C-RIMM modules. **The board must be populated 4 RIMM modules at the same time, that will boot-up the system.**

- The board supports a maximum of 32 devices on a RDRAM channel. A Channel is defined as the two RIMM Slots on the motherboard added together. Thus the motherboard has two channel. See Figure 11 for two channel RDRAM interconnections.
- No support for EDO/SDRAM DIMM Modules.
- The board supports 16/18 (ECC) - bit RDRAM configurations.
- The RIMM modules and continuity RIMM (C-RIMM) spec. should be Revision Number 1.0. For more detailed “RIMM Modules spec.” information you may visit the following Web Site: <http://www.rimm.com>.
- 64MB, 128MB or 256MB DRAM technology that supports 256MB, 512MB, 1GB (in the feature devices) max. memory size module produced. The Max. memory information show in Table 2.
- Direct Rambus Channel operating at a clock rate of 400MHz which enables a data rate of 800MHz (data is clocked on both clock edges).

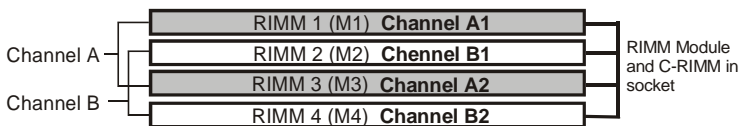

Figure 10

Installation

RDRAM technology	Max Memory on Channel
64 Mbit	256 MB
128 Mbit	512 MB
256 Mbit	1 GB

Table 2: Maximum memory support on this board with RDRAM populated on a channel.

The figure 11 below shows the RSL interconnections between 850 (MCH) and two RDRAM channel. This figure describes the logical interconnections, and is not a physical representation of RDARM devices on a motherboard.

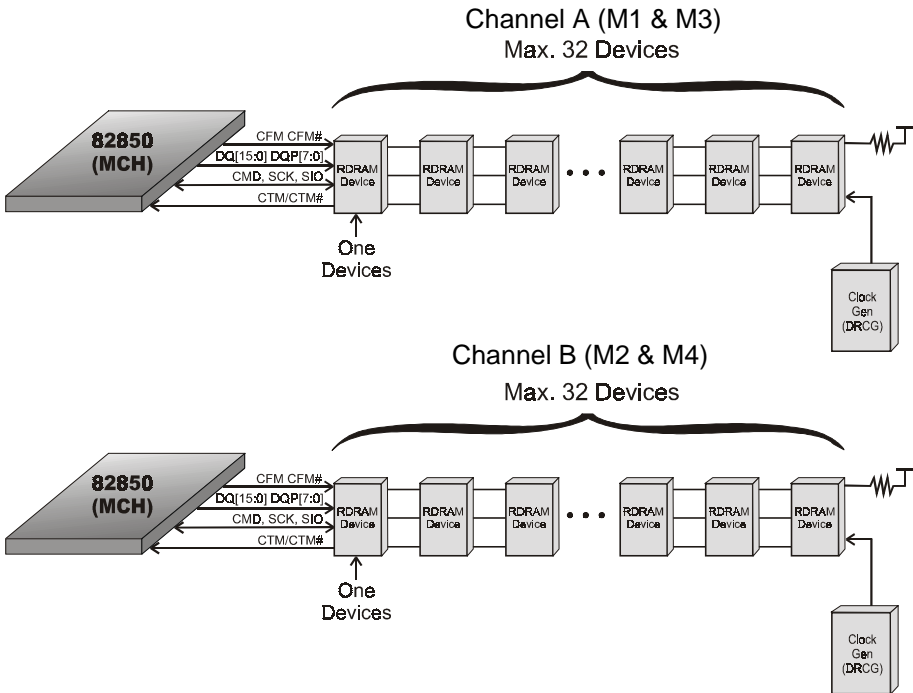

Figure 11: MCH/RDRAM Interconnections

The table 3 below shows the onboard RIMM memory socket population.

RIMM Socket# of Onboard				System Accept	Max. of RDRAM devices on a Channel	Total Memory
RIMM1	RIMM2	RIMM3	RIMM4	Status	Device	Size
RIMM#	RIMM#	C-RIMM%	C-RIMM%	OK	32	2048MB (2GB) *
C-RIMM%	C-RIMM%	RIMM#	RIMM#	OK	32	2048MB (2GB) *
RIMM#	RIMM#	RIMM#	RIMM#	OK	32	2048MB (2GB) *
Any RIMM socket# is empty or the RIMM Module is not properly inserted.				Failure, System can't boot and no display.		

Table 3: Onboard RIMM memory socket population.

RIMM# : RIMM in Socket

C-RIMM% : Continuity Module in Socket

* : in the feature devices

Note : Two Channel must be populated the same size of RIMM memory modules.

Important Notice

For the safe of reducing the high heat of RDRAM, it is strongly recommended that user must install the Chassis cooling fan in the system.

Installation

RIMM/C-RIMM Module Installation

This section describes some basic RIMM/C-RIMM installations as described in table 3. Note that continuity Modules are required in empty sockets. Figure 14-1, 14-2 and 15 display common installations including examples of incorrect (see figure 12, 13-1, 13-2). RIMM or RDRAM signals are daisy-chained through each device on RIMM and memory module.

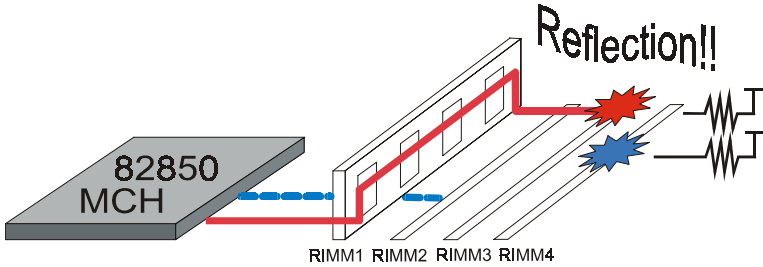

Figure 12: Wrong Configuration

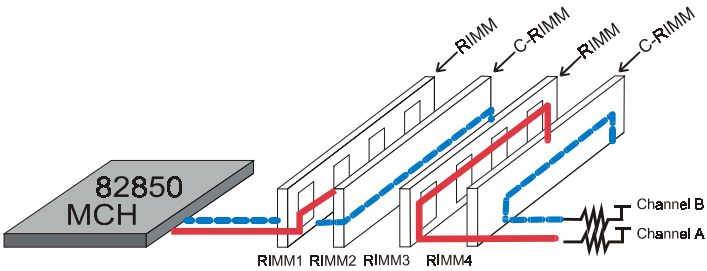

Figure 13-1: Wrong Configuration

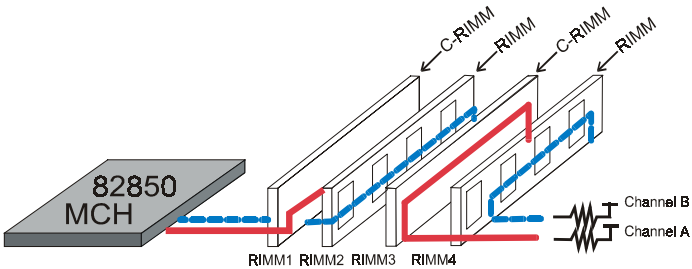

Figure 13-2: Wrong Configuration

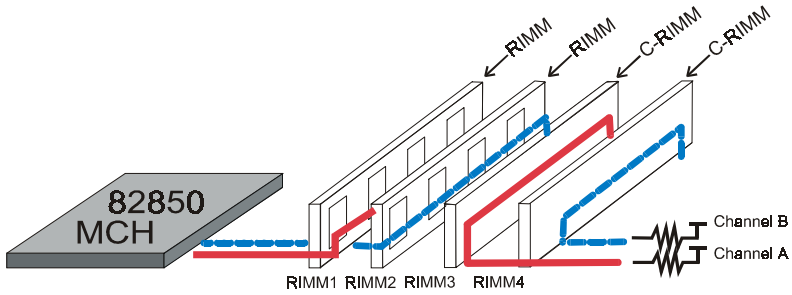

Figure 14-1: Right Base Configuration

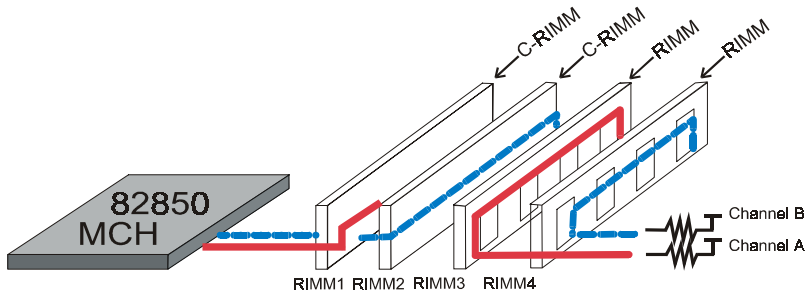

Figure 14-2: Right Base Configuration

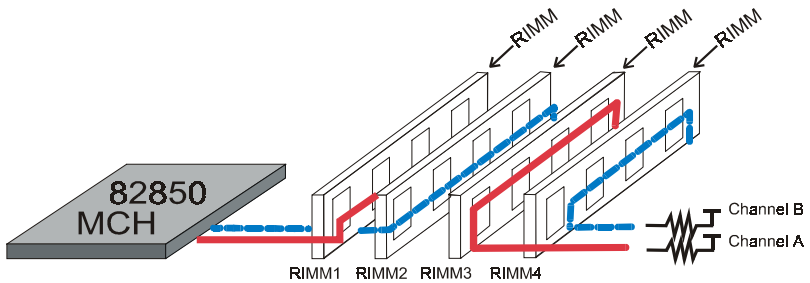

Figure 15: Right Base Configuration

Installation

Figure 16 displays the notch marks and what they should look like on your RIMM memory module.

RIMMs have 184-pins and two notches that will match with the onboard RIMM socket. RIMM modules are installed by placing the chip firmly into the socket at a 90 degree angle and pressing straight down (figure 17) until it fits tightly into the RIMM socket (figure 18).



Figure 16



Figure 17

RIMM Module clip before installation

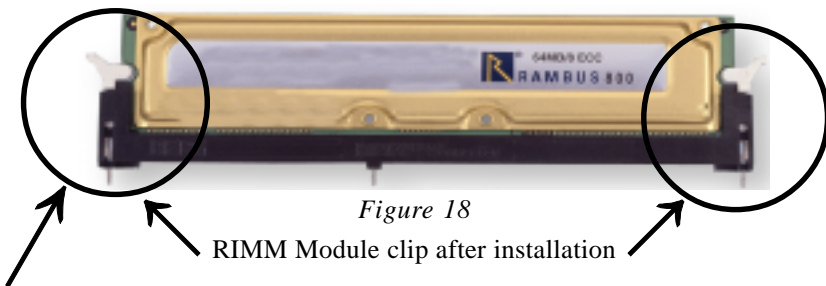

Figure 18

RIMM Module clip after installation

To remove the RIMM module simply press down both of the white clips on either side and the module will be released from the socket.

Figure 16a displays the notch marks and what they should look like on your C-RIMM memory module.

C-RIMMs have 184-pins and two notches that will match with the onboard C-RIMM socket. C-RIMM modules are installed by placing the chip firmly into the socket at a 90 degree angle and pressing straight down (figure 17a) until it fits tightly into the RIMM socket (figure 18a).



Figure 16a

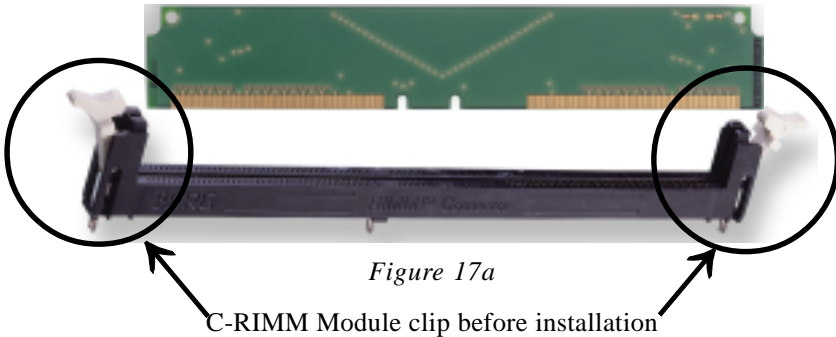

Figure 17a

C-RIMM Module clip before installation

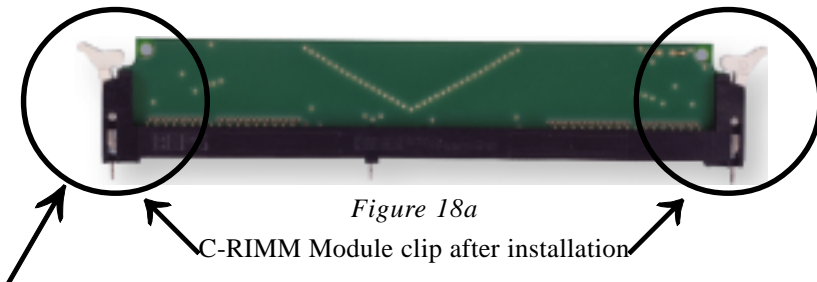

Figure 18a

C-RIMM Module clip after installation

To remove the C-RIMM module simply press down both of the white clips on either side and the module will be released from the socket.

Installation

Section 3-4 Device Connectors

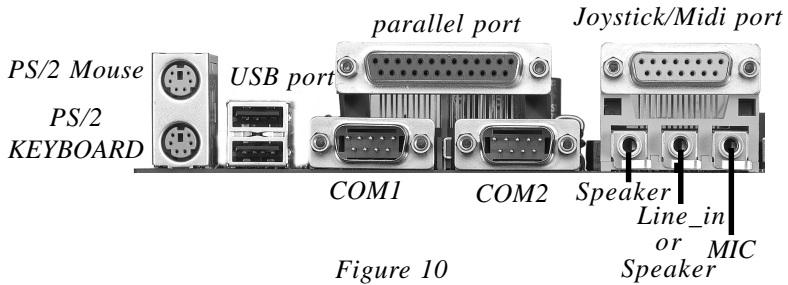
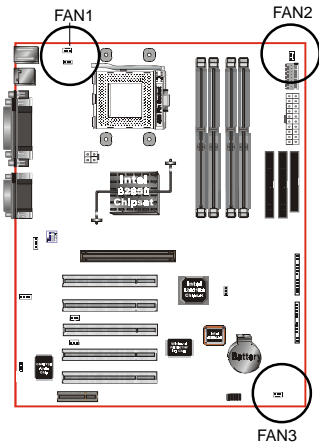

Figure 10



FAN1 / FAN2 / FAN3:

- A plug-in for the CPU/Power/Cassis Fan power

FAN1: CPU Fan FAN2: PW Fan FAN3: Chasis Fan

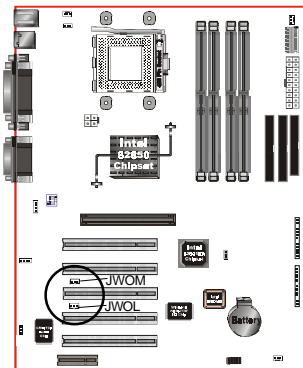

JWOL: WOL (Wake On LAN) Connector



JWOM: WOM (Wake On Modem) Connector



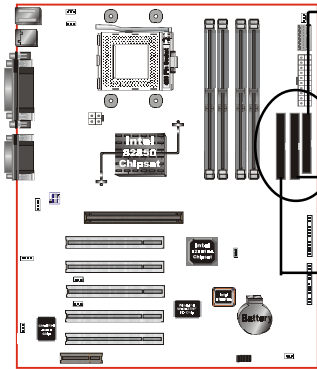

FDD1: Floppy Controller Connector (Black color)

IDE2: Ultra 66/100 Primary IDE Connector (Blue color)

IDE1: Ultra 66/100 Secondary IDE Connector (Black color)

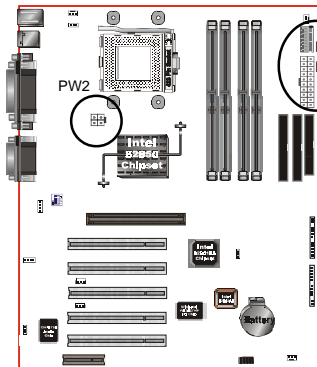

PW1: ATX12V Power Connector
 • 20-pin power connector

PW2: ATX12V Power Connector
 • 12V 4-pin power connector

PW3: ATX12V Power Connector
 • 6-pin Auxiliary power connector

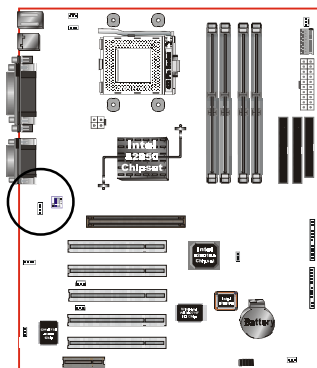

CD_IN: CD Audio_IN Connector

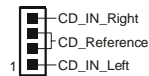

Installation

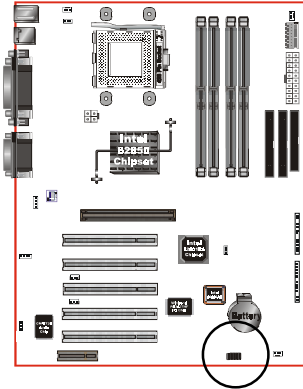

USBCON1: USB port header pins for share with two USB ports.

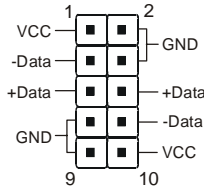

USB port header pin descriptions.

PIN#	Wire color	Signal Name	Comment
1	Red	Vcc	Cable Power
2	Black	Ground	Case Ground
3	White	-Data	Data
4	Black	Ground	Cable Ground
5	Green	+Data	Data
6	Green	+Data	Data
7	Black	Ground	Cable Ground
8	White	-Data	Data
9	Black	Ground	Case Ground
10	Red	Vcc	Cable Power

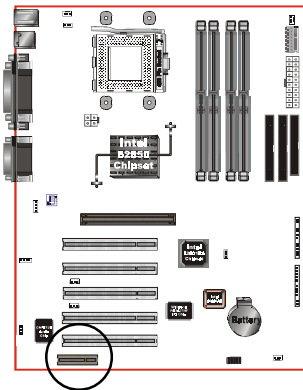

CNR Conn.: The board supports one CNR connector to provide a Modem Code (MC) or Phone-line base network and 10/100 Ethernet base networking configuration.

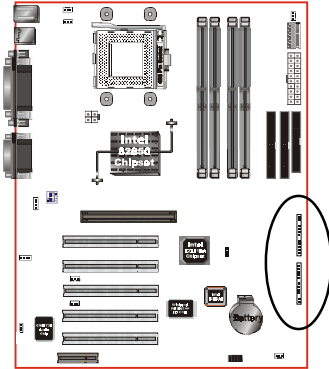

◆ Power On/Off

(This is connected to the power button on the case. Using the Soft-Off by Pwr-BTTN feature, you can choose either Instant Off (turns system off immediately), or 4 sec delay (you need to push the button down for 4 seconds before the system turns off). When the system is in 4 sec delay mode, suspend mode is enabled by pushing the button momentarily.)

◆ Turbo LED indicator

LED ON when higher speed is selected

◆ IDE LED indicator

LED ON when Onboard PCI IDE Hard disks is activate

◆ IR Connector

- | | |
|---------|---------|
| 1. VCC | 4. GND |
| 2. NC | 5. IRTX |
| 3. IRRX | |

◆ KeyLock

Keyboard lock switch & Power LED connector

- | | |
|-----------------|--------|
| 1. Power LED(+) | 4. NC |
| 2. N/C | 5. GND |
| 3. GND | |

* The power LED lights when the system is powered on and blinks in SLEEP Mode or STR Mode.

◆ Speaker

Connect to the system's speaker for beeping

- | | |
|------------|--------|
| 1. Speaker | 3. GND |
| 2. N/C | 4. GND |

◆ Reset

Closed to restart system.

J3

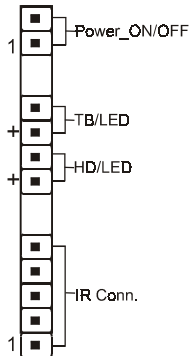

J2

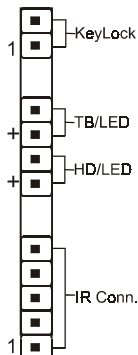

Installation

Section 3-5 External Modem Ring-in Power ON and Keyboard Power ON Functions (KBPO)

On the basis of bounded functions in I/O chipset, the two serial ports are able to support the External Modem Ring-in Power ON function. Once users connect the external modem to COM1 or COM2, the mainboard allows users to turn on their system through the remote and host's dial-up control.

Exclusive Keyboard Power ON Function

To innovate a unique feature to benefit users, we devoted the easiest and most convenient way to turn on your system based on the the ATX power supply.

How to work with it

Step 1: Please check JP13 at the position 1-2 after you finished the system installation.

JKBPO  Keyboard Power On Function
1-2 Enabled
2-3 Disabled (Default)

Step 2: Push the momentary switch (J3 PW-ON) to turn on your system and then push again to hold for more than 4 seconds to turn it off after counting memory as soon as you turn it on.

Step 3: You can enjoy the Keyboard Power ON function (KBPO) by *pressing any 1 key, Hot key (Ctrl-F1, F2.....F12), Password (A maximum of 5 characters can be entered.) and BUTTON only to turn on your system. Please refer to the BIOS Integrated peripherals setup for detail. The BIOS Default is keyboard Hot key <Ctrl> - <F1> to turn on the system. Your system will be turned on automatically, after releasing the keys. To power off you system, you can use the Soft-OFF function under Windows 95/98/2000.*

Notes:

1. Intel ATX version 2.0 specification recommended you use the power supply with $\geq 1.0A$ in 5.0VSB. With our mainboard, *the 5.0VSB standby power only has to be $\geq 0.1A$ (100mA)* then you can enjoy this unique benefit. However, an ATX power supply which is $< 0.1A$ (100mA) is still usable to your system by placed JKBPO at the position 2-3 to disable this feature.
2. We recommended you use the power supply with 1.0A in 5.0VSB. Because this supported PCI 2.1 specification for remote power-on and wake-up function.

Installation

3-6 STR (Suspend To RAM) Function

The board supports the STR power management state by maintaining the appropriate states on the RDRAM interface signals. The power source must be kept alive to the RDRAM during STR (ACPI S3). Advanced Configuration Power Interface (ACPI) provides more Energy Saving Features for operating systems that supporting Instant ON and QuickStart™ function.

1. To enable the ACPI function and use the STR functionally to save your system energy, you are recommended to confirm the following requirements:
 - a. Please do install all ACPI qualified add-on cards such as AGP, LAN, Modem cards.
 - b. In BIOS, please select “ACPI function: Enable” and “ACPI Suspend Type: S3(STR)” in the Power Management Setup menu.
 - c. Then, please install the Windows® 98SE/ME or Windows® 2000.
 - d. Restart your system.
 - e. Getting in to the “Advanced” of the Power Management icon of Control Panel, and selecting the “Stand By” in the Power Buttons.
2. Getting start with STR function, please click the START button and choose Shut Down. Then, select the Stand By option in the Shut Down Windows box to get into STR mode.

Here are the differences between STR power saving mode and Green (or Suspend) mode:

- a. It is the most advanced Power Management mode
- b. It cuts all the power supplied to peripherals except to Memory - max. power saving
- c. It saves and keeps all on-screen data including any executed applications to RDRAM.
- d. You must push the Power button connected with onboard J3 pin to wake up you system (not to click to mouse or press keyboard to wake up the system).

Just pushing Power button, your system will quickly back to the last screen for you.

Section 4 BIOS SETUP

Main Menu

Once you enter the AwardBIOS™ CMOS Setup Utility, the Main Menu will appear on the screen. The Main Menu allows you to select from several setup functions and two exit choices. Use the arrow keys to select among the items and press <Enter> to accept and enter the sub-menu.

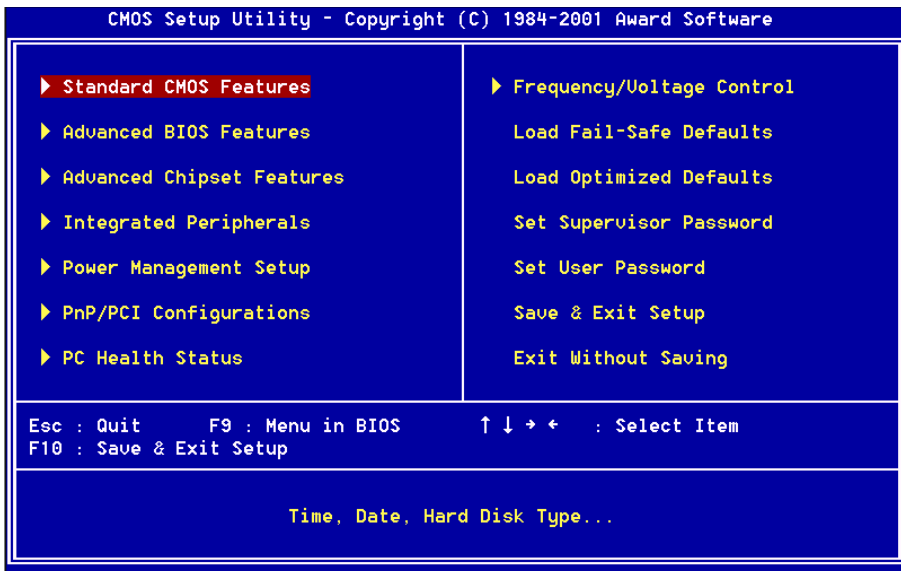

Note that a brief description of each highlighted selection appears at the bottom of the screen.

Setup Items

The main menu includes the following main setup categories. Recall that some systems may not include all entries.

Standard CMOS Features

Use this menu for basic system configuration.

BIOS

Advanced BIOS Features

Use this menu to set the Advanced Features available on your system.

Advanced Chipset Features

Use this menu to change the values in the chipset registers and optimize your system's performance.

Integrated Peripherals

Use this menu to specify your settings for integrated peripherals.

Power Management Setup

Use this menu to specify your settings for power management.

PnP / PCI Configuration

This entry appears if your system supports PnP / PCI.

PC Health Status

This item is only show the system health status (include Voltage, Fan speed, CPU temperature...)

Frequency/Voltage Control

Use this menu to specify your settings for frequency/voltage control.

Load Fail-Safe Defaults

Use this menu to load the BIOS default values for the minimal/stable performance for your system to operate.

Load Optimized Defaults

Use this menu to load the BIOS default values that are factory settings for optimal performance system operations. While Award has designed the custom BIOS to maximize performance, the factory has the right to change these defaults to meet their needs.

Supervisor / User Password

Use this menu to set User and Supervisor Passwords.

Save & Exit Setup

Save CMOS value changes to CMOS and exit setup.

Exit Without Save

Abandon all CMOS value changes and exit setup.

4-1 Standard CMOS Setup

The items in Standard CMOS Setup Menu are divided into 10 categories. Each category includes no, one or more than one setup items. Use the arrow keys to highlight the item and then use the <PgUp> or <PgDn> keys to select the value you want in each item.

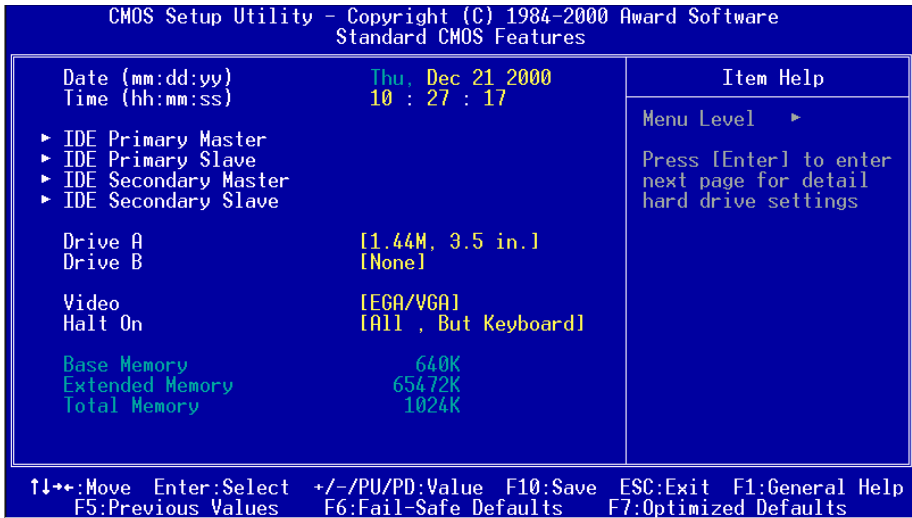

Figure 1: The Main Menu

Main Menu Selections

This table shows the selections that you can make on the Main Menu

Item	Options	Description
Date	Month DD YYYY	Set the system date. Note that the 'Day' automatically changes when you set the date
Time	HH : MM : SS	Set the system time
IDE Primary Master	Options are in its sub menu (described in Table 3)	Press <Enter> to enter the sub menu of detailed options
IDE Primary Slave	Options are in its sub menu (described in Table 3)	Press <Enter> to enter the sub menu of detailed options
IDE Secondary Master	Options are in its sub menu (described in Table 3)	Press <Enter> to enter the sub menu of detailed options
IDE Secondary Slave	Options are in its sub menu (described in Table 3)	Press <Enter> to enter the sub menu of detailed options
Drive A Drive B	None 360K, 5.25 in 1.2M, 5.25 in 720K, 3.5 in 1.44M, 3.5 in 2.88M, 3.5 in	Select the type of floppy disk drive installed in your system
Video	EGA/VGA CGA 40 CGA 80 MONO	Select the default video device
Halt On	All Errors No Errors All, but Keyboard All, but Diskette All, but Disk/Key	Select the situation in which you want the BIOS to stop the POST process and notify you
Base Memory	N/A	Displays the amount of conventional memory detected during boot up
Extended Memory	N/A	Displays the amount of extended memory detected during boot up
Total Memory	N/A	Displays the total memory available in the system

Table 2 Main Menu Selections

IDE Adapters

The IDE adapters control the hard disk drive. Use a separate sub menu to configure each hard disk drive.

Figure 2 shows the IDE primary master sub menu.

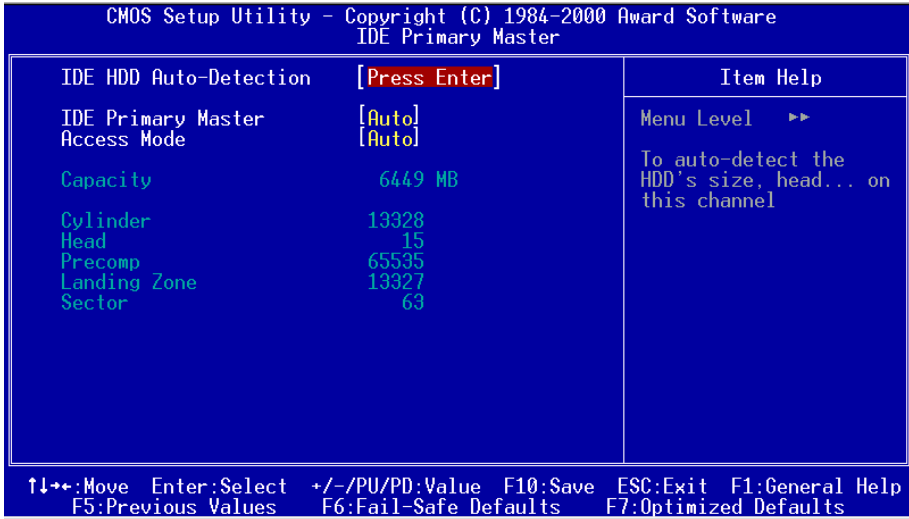

Figure 2 IDE Primary Master sub menu

BIOS

Use the legend keys to navigate through this menu and exit to the main menu. Use Table 3 to configure the hard disk.

<i>Item</i>	<i>Options</i>	<i>Description</i>
IIDE HDD Auto-detection	Press Enter	Press Enter to auto-detect the HDD on this channel. If detection is successful, it fills the remaining fields on this menu.
IDE Primary Master	None Auto Manual	Selecting 'manual' lets you set the remaining fields on this screen. Selects the type of fixed disk. "User Type" will let you select the number of cylinders, heads, etc. Note: PRECOMP=65535 means NONE !
Capacity	Auto Display your disk drive size	Disk drive capacity (Approximated). Note that this size is usually slightly greater than the size of a formatted disk given by a disk checking program.
Access Mode	Normal LBA Large Auto	Choose the access mode for this hard disk
The following options are selectable only if the 'IDE Primary Master' item is set to 'Manual'		
Cylinder	Min = 0 Max = 65535	Set the number of cylinders for this hard disk.
Head	Min = 0 Max = 255	Set the number of read/write heads
Precomp	Min = 0 Max = 65535	**** Warning: Setting a value of 65535 means no hard disk
Landing zone	Min = 0 Max = 65535	****
Sector	Min = 0 Max = 255	Number of sectors per track

Table 3 Hard disk selections

4-2 Advanced BIOS Features

This section allows you to configure your system for basic operation. You have the opportunity to select the system's default speed, boot-up sequence, keyboard operation, shadowing and security.

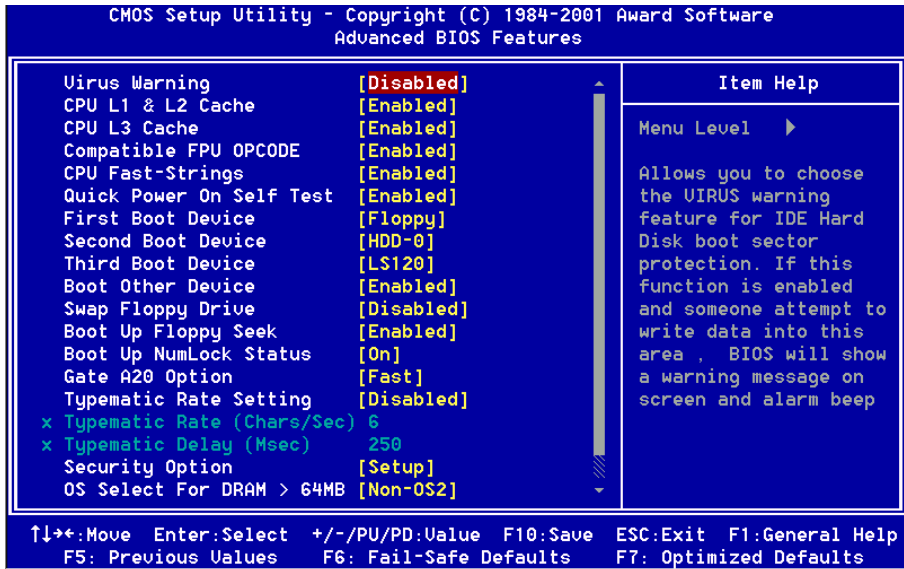

Virus Warning

Allows you to choose the VIRUS Warning feature for IDE Hard Disk boot sector protection. If this function is enabled and someone attempt to write data into this area, BIOS will show a warning message on screen and alarm beep.

Enabled: Activates automatically when the system boots up causing a warning message to appear when anything attempts to access the boot sector or hard disk partition table.

Disabled: No warning message will appear when anything attempts to access the boot sector or hard disk partition table.

CPU L1/L2/L3 Cache

These three categories speed up memory access. However, it depends on CPU/ chipset design.

The choice: Enabled/Disabled.

BIOS

Quick Power On Self Test

This category speeds up Power On Self Test (POST) after you power up the computer. If it is set to Enable, BIOS will shorten or skip some check items during POST.

Enabled: Enable quick POST

Disabled: Normal POST

Compatible FPU OPCODE

The choice: Enabled/Disabled.

CPU Fast-Strings

The choice: Enabled/Disabled.

First/Second/Third/Other Boot Device

The BIOS attempts to load the operating system from the devices in the sequence selected in these items.

The Choice: Floppy, LS120, HDD-0, SCSI, CDROM, HDD-1, HDD-2, HDD-3, ZIP100, LAN, Disabled.

Swap Floppy Drive

If the system has two floppy drives, you can swap the logical drive name assignments.

The choice: Enabled/Disabled.

Boot Up Floppy Seek

Seeks disk drives during boot up. Disabling speeds boot up.

The choice: Enabled/Disabled.

Boot Up NumLock Status

Select power on state for NumLock.

The choice: On/Off.

Typematic Rate Setting

Key strokes repeat at a rate determined by the keyboard controller. When enabled, the typematic rate and typematic delay can be selected.

The choice: Enabled/Disabled.

Typematic Rate (Chars/Sec)

Sets the number of times a second to repeat a key stroke when you hold the key down.

The choice: 6, 8, 10, 12, 15, 20, 24, 30.

Typematic Delay (Msec)

Sets the delay time after the key is held down before it begins to repeat the keystroke. The choice: 250, 500, 750, 1000.

Security Option

Select whether the password is required every time the system boots or only when you enter setup.

System The system will not boot and access to Setup will be denied if the correct password is not entered at the prompt.

Setup The system will boot, but access to Setup will be denied if the correct password is not entered at the prompt.

Note: To disable security, select PASSWORD SETTING at Main Menu and then you will be asked to enter password. Do not type anything and just press <Enter>, it will disable security. Once the security is disabled, the system will boot and you can enter Setup freely.

OS Select For DRAM > 64MB

Select the operating system that is running with greater than 64MB of RAM on the system. The choice: Non-OS2, OS2.

Report No FDD For WIN95

Whether report no FDD for Win95 or not.

The choice: Yes, No.

Small Logo (EPA) Show

The choice: Enabled/Disabled.

4-3 Advanced Chipset Features

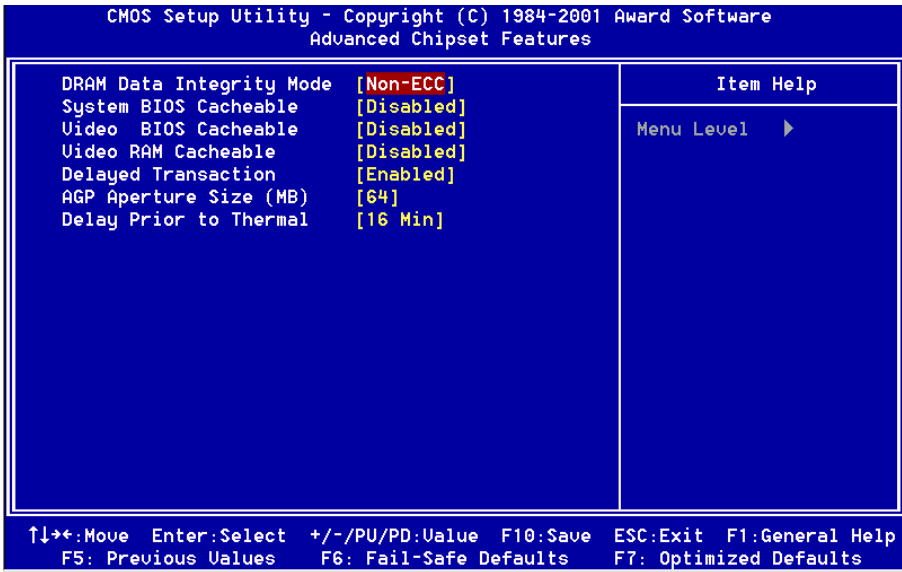

This section allows you to configure the system based on the specific features of the installed chipset. This chipset manages bus speeds and access to system memory resources, such as DRAM and the external cache. It also coordinates communications between the conventional ISA bus and the PCI bus. It must be stated that these items should never need to be altered. The default settings have been chosen because they provide the best operating conditions for your system. The only time you might consider making any changes would be if you discovered that data was being lost while using your system.

DRAM Data Integrity Mode

Use this option to configure the type of DRAM in your system.

The choice: No-ECC, ECC.

System BIOS Cacheable

Selecting *Enabled* allows caching of the system BIOS ROM at F0000h-FFFFFh, resulting in better system performance. However, if any program writes to this memory area, a system error may result.

The choice: Enabled, Disabled.

Video BIOS Cacheable

Select Enabled allows caching of the video BIOS , resulting in better system performance. However, if any program writes to this memory area, a system error may result.

The Choice: Enabled, Disabled.

Video RAM Cacheable

This option allows the CPU to cache read/writes of the video RAM. The default is Disabled

Enabled: This option allows for faster video access.

Disabled: Reduced video performance.

AGP Graphics Aperture Size (MB)

The amount of system memory that the AGP card is allowed to share. The default is 64.

32: 32MB of systems memory accessible by the AGP card.

64: 64MB of systems memory accessible by the AGP card.

128: 128MB of systems memory accessible by the AGP card.

256: 256MB of systems memory accessible by the AGP card.

Delayed Transaction

The chipset has an embedded 32-bit posted write buffer to support delay transactions cycles. Select *Enabled* to support compliance with PCI specification version 2.1.

The Choice: Enabled, Disabled.

Delay Prior to Thermal

The Choice: 4 Min, 8 Min, 16 Min, 32 Min.

4-4 Integrated Peripherals

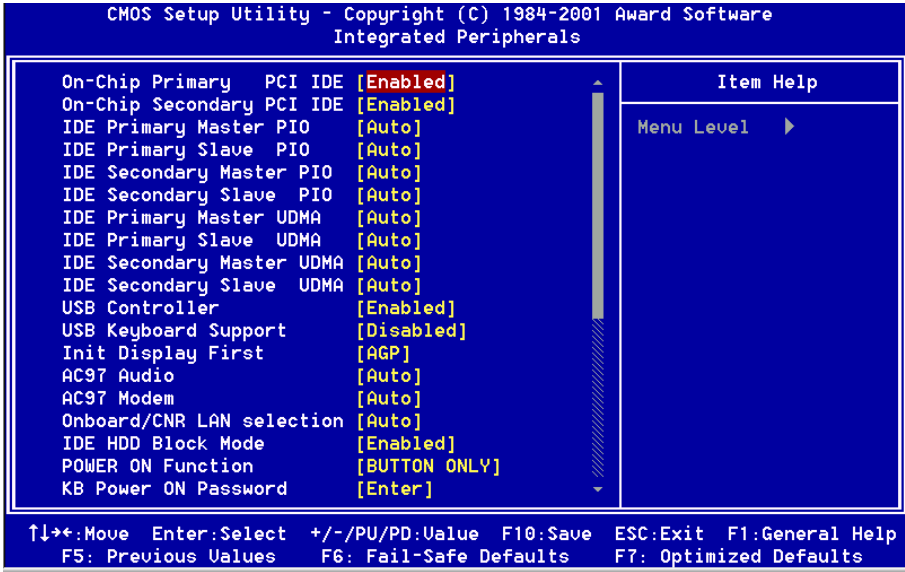

OnChip Primary/Secondary PCI IDE

The integrated peripheral controller contains an IDE interface with support for two IDE channels. Select *Enabled* to activate each channel separately. The choice: Enabled, Disabled.

Primary/Secondary Master/Slave PIO

The four IDE PIO (Programmed Input/Output) fields let you set a PIO mode (0-4) for each of the four IDE devices that the onboard IDE interface supports. Modes 0 through 4 provide successively increased performance. In Auto mode, the system automatically determines the best mode for each device. The choice: Auto, Mode 0, Mode 1, Mode 2, Mode 3, Mode 4.

Primary/Secondary Master/Slave UDMA

Ultra DMA/33 implementation is possible only if your IDE hard drive supports it and the operating environment includes a DMA driver (Windows 95 OSR2 or a third-party IDE bus master driver). If your hard drive and your system software both support Ultra DMA/33, select Auto to enable BIOS support. The Choice: Auto, Disabled.

USB Controller

Select *Enabled* if your system contains a Universal Serial Bus (USB) controller and you have USB peripherals.

The choice: Enabled, Disabled.

USB Keyboard Support

Select *Enabled* if your system contains a Universal Serial Bus (USB) controller and you have a USB Keyboard Device.

The choice: Enabled, Disabled.

Init Display First

This item allows you to decide to active whether PCI Slot or on-chip VGA first

The choice: PCI Slot, Onboard .

AC97 Audio

This item allows you to decide to Auto/disable the chipset family to support AC97 Audio.

The function setting AC97 Audio Codec states. The system default is Auto.

AC97 Modem

This item allows you to decide to enable/disable the chipset family to support AC97 Modem.

Select Enable of AC97 Modem item, you must be primary Modem Riser Card (MR) in hardware.

The choice: Auto, Disabled.

Onboard/CNR LAN selection

This item allows you to decide to select Onboard/CNR LAN.

The choice: Auto, Onboard, Ext. CNR.

IDE HDD Block Mode

Block mode is also called block transfer, multiple commands, or multiple sector read/write. If your IDE hard drive supports block mode (most new drives do), select Enabled for automatic detection of the optimal number of block read/writes per sector the drive can support.

The choice: Enabled, Disabled

BIOS

Power On Function

There are “**Button Only**”, “**Hot Key**” and “**Any key**” can be chosen by this field that allows users to select one of these various functions as Power On Method for their requirement. The default value in this selection is “Hot Key”. (Ctrl-F1)

Hot Key: User can press “Control Key” (Ctrl) and “Function Key” (from F1 to F12) individually to power on the system. The interval between “Ctrl” key and function Key (F1-F12) must be short.

Anykey: Press anykey to power on the system.

Button Only: This power on function controlled by J3 (pw-on.) Use Power On Button to power on the system.

Password: User can Power On the System by password, the password can be entered from 1 to 5 characters. The maximum of password is 5 characters. If user forget / lost the password, please turn off the system and open case to clear CMOS by JP1 to re-setting the power on function. When set the password to turn on the system, than can't power on by J3(PW-ON).

KB Power On Password

When the option of “Power On Function” is password selected, user uses the item to key in password.

Hot Key Power On

Use this option with the above “Power On Function” to set a combination of keys that can be used to power the system on. The default is Ctrl-F1.

Options: Ctrl-F1, Ctrl-F2, Ctrl-F3, Ctrl-F4, Ctrl-F5, Ctrl-F6, Ctrl-F7, Ctrl-F8, Ctrl-F9, Ctrl-F10, Ctrl-F11, and Ctrl-F12.

Onboard FDC Controller

Select Enabled if your system has a floppy disk controller (FDC) installed on the system board and you wish to use it. If you install and-in FDC or the system has no floppy drive, select Disabled in this field.

The choice: Enabled, Disabled.

Onboard Serial Port 1/Port 2

Select an address and corresponding interrupt for the first and second serial ports.

The choice: 3F8/IRQ4, 2E8/IRQ3, 3E8/IRQ4, 2F8/IRQ3, Disabled.

UART Mode Select

This field allows the users to configure what IR mode the 2nd serial port should use. The default is Normal.

Optional: Normal, IrDA and ASKIR.

RxD, TxD Active

This field configures the receive and transmit signals generated from the IR port. The default is Hi Lo (when UART Mode Select is not set to Normal).

Options: Hi Hi, Hi Lo, Lo Hi, and Lo Lo.

IR Transmission delay

The default is Enabled (when UART Mode Select is not set to Normal).

Options: Enabled and Disabled.

UR2 Duplex Mode

This item allows you to select IR half/full duplex function.

The choice: Half, Full

Use IR Pins

This item allows you to select IR transmission routes, one is RxD2, TxD2 (COM Port) and the other is IR-Rx2Tx2.

The choice: IR-Rx2Tx2, RxD2, TxD2.

Onboard Parallel port

This field allows the user to configure the LPT port.

The default is 378H / IRQ7.

378H: Enable Onboard LPT port and address is 378H and IRQ7.

278H: Enable Onboard LPT port and address is 278H and IRQ5.

3BCH: Enable Onboard LPT port and address is 3BCH and IRQ7.

Disabled: Disable Onboard LPT port.

Parallel Port Mode

This field allows the user to select the parallel port mode.

The default is EPP+ECP.

Normal: Standard mode. IBM PC/AT Compatible bidirectional parallel port.

EPP: Enhanced Parallel Port mode.

ECP: Extended Capabilities Port mode.

EPP+ECP: ECP Mode & EPP Mode.

BIOS

EPP Mode Select

This item allows you to determine the IR transfer mode of onboard I/O chip.
options: EPP1.9, EPP1.7.

ECP Mode USE DMA

This field allows the user to select DMA1 or DMA3 for the ECP mode.
The default is DMA3.

DMA1: This field selects the routing of DMA1 for the ECP mode.

DMA3: This field selects the routing of DMA3 for the ECP mode.

PWRON After PW-Fail

The system will stay of or power on after a power interrupte.
The default is OFF.

Fomer-Status: Stay off or power on depend on system safe shut-down or
power fail.

ON: System always power on after a power interrupte.

OFF: System always stay off after a power interrupte.

Game Port Address

Select an address for the Game port.
The choice: 201, 209, Disabled.

Midi Port Address

Select an address for the Midi port.
The choice: 290, 300, 330, Disabled.

Midi Port IRQ

Select an interrupt for the Midi port.
The choice: 5, 10.

4-5 Power Management Setup

The Power Management Setup allows you to configure your system to most effectively save energy while operating in a manner consistent with your own style of computer use.

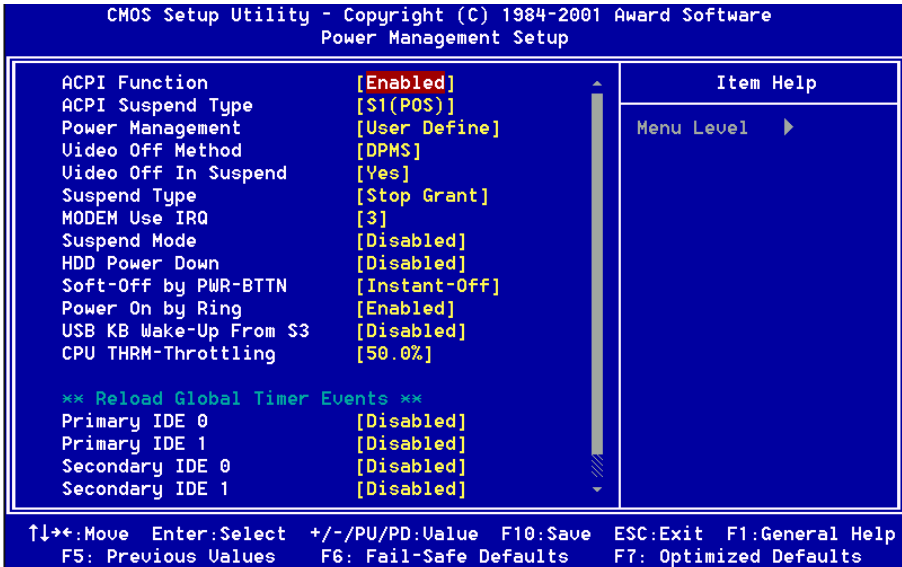

ACPI Function

This item allows you to enable/disable the Advanced Configuration and Power Management (ACPI).

The choice: Enabled, Disabled.

ACPI Suspend Type

This item allows you to select S1(POS) or S3(STR) function.

The choice: S1(POS), S3(STR).

Power Management

This category allows you to select the type (or degree) of power saving and is directly related to the following modes:

1. HDD Power Down
2. Doze Mode
3. Suspend Mode

BIOS

There are four selections for Power Management, three of which have fixed mode settings.

Disable (default)	No power management. Disables all four modes
Min. Power Saving	Minimum power management. Doze Mode = 1 hr. Standby Mode = 1 hr., Suspend Mode = 1 hr., and HDD Power Down = 15 min.
Max. Power Saving	Maximum power management -- ONLY AVAILABLE FOR SL CPU's . Doze Mode = 1 min., Standby Mode = 1 min., Suspend Mode = 1 min., and HDD Power Down = 1 min.
User Defined	Allows you to set each mode individually. When not disabled, each of the ranges are from 1 min. to 1 hr. except for HDD Power Down which ranges from 1 min. to 15 min. and disable.

Video Off Method

This determines the manner in which the monitor is blanked.

V/H SYNC+Blank	This selection will cause the system to turn off the vertical and horizontal synchronization ports and write blanks to the video buffer.
Blank Screen	This option only writes blanks to the video buffer.
DPMS	Initial display power management signaling.

Video Off In Suspend

This determines the manner in which the monitor is blanked.

The choice: Yes, No.

Suspend Type

Select the Suspend Type.

The choice: PWRON Suspend, Stop Grant.

MODEM Use IRQ

This determines the IRQ in which the MODEM can use.

The choice: 3, 4, 5, 7, 9, 10, 11, NA.

Suspend Mode

When enabled and after the set time of system inactivity, all devices except the CPU will be shut off.

The choice: Enabled, Disabled.

HDD Power Down

When enabled and after the set time of system inactivity, the hard disk drive will be powered down while all other devices remain active.

The choice: Enabled, Disabled.

Soft-Off by PWR-BTTN

Pressing the power button for more than 4 seconds forces the system to enter the Soft-Off state when the system has “hung.” The default is Instant-off.

The choice: Delay 4 Sec, Instant-Off.

PowerOn By Ring

This option is used to set the remote ring in and Wake on LAN (WOL) features.

The choice: Enabled, Disabled.

USB KB Wake-Up From S3

This item allows you to select wake-up the system by USB Keyboard when you save the computer power at S3 mode.

The choice: Enabled, Disabled.

CPU THRM-Throttling

Select the CPU THRM-Throttling rate.

The choice: 25.0%, 37.5%, 50.0%, 62.5%, 75.0%, 87.5%.

**** PM Events ****

PM events are I/O events whose occurrence can prevent the system from entering a power saving mode or can awaken the system from such a mode. In effect, the system remains alert for anything which occurs to a device which is configured as *Enabled*, even when the system is in a power down mode.

Primary IDE 0

Primary IDE 1

Secondary IDE 0

Secondary IDE 1

FDD, COM, LPT Port

PCI PIRQ[A-D] #

4-6 PnP/PCI Configuration Setup

This section describes configuring the PCI bus system. PCI, or **P**ersonal **C**omputer **I**nterconnect, is a system which allows I/O devices to operate at speeds nearing the speed the CPU itself uses when communicating with its own special components. This section covers some very technical items and it is strongly recommended that only experienced users should make any changes to the default settings.

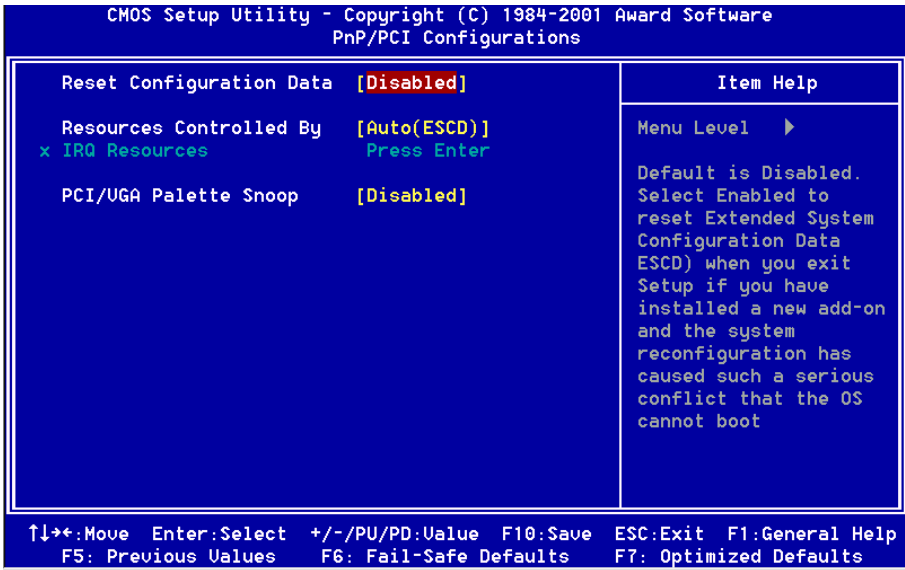

Reset Configuration Data

Normally, you leave this field Disabled. Select Enabled to reset Extended System Configuration Data (ESCD) when you exit Setup if you have installed a new add-on and the system reconfiguration has caused such a serious conflict that the operating system can not boot.

The choice: Enabled, Disabled .

Resource controlled by

The Award Plug and Play BIOS has the capacity to automatically configure all of the boot and Plug and Play compatible devices. However, this capability means absolutely nothing unless you are using a Plug and Play operating system such as Windows95. If you set this field to “manual” choose specific resources by going

into each of the sub menu that follows this field (a sub menu is preceded by a “Ø”).

The choice: Auto(ESCD), Manual.

PCI/VGA Palette Snoop

Leave this field at *Disabled*.

Choices are Enabled, Disabled.

4-7 PC Health Status

CMOS Setup Utility - Copyright (C) 1984-2001 Award Software	
PC Health Status	
CPU Warning Temperature	[Disabled]
Current CPU Temp.	[33°C/91°F]
Current System Temp.	[59°C/138°F]
Current Chassis Fan Speed	[0 RPM]
Current CPU Fan Speed	[0 RPM]
Current Power Fan Speed	[0 RPM]
Vagp (U)	[2.51V]
Vcore(U)	[2.09V]
2.50 (U)	[2.52V]
+ 5 U	[4.97V]
+12 U	[12.12V]
-12 U	[-12.28V]
- 5 U	[-5.09V]
UBAT(U)	[3.48V]
5USB(U)	[4.89V]
Shutdown Temperature	[Disabled]

Item Help
Menu Level ▶

↑↓←→:Move	Enter:Select	+/-/PU/PD:Value	F10:Save	ESC:Exit	F1:General Help
F5: Previous Values	F6: Fail-Safe Defaults	F7: Optimized Defaults			

CPU Warning Temperature

This is the temperature that the computer will respond to an overheating CPU. The default is Disabled.

Enabled: Temperature is monitored on the CPU.

Disabled: This feature is turned off.

Current CPU / System Temperature

This is the current temperature of the CPU/System.

Current CPU Fan / Chassis Fan / Power Fan Speed

The current CPU/Chassis/Power fan speed in RPMs.

Vagp

The voltage level of Power supplied to AGP card.

1.52V: for 4X AGP card.

3.3V : for 2X AGP card.

Vcore

The voltage level of the Vcore.

2.5V

The voltage level of the RDRAM.

+5V, +12V, -5V, -12V, VBAT(V), 5VSB(V): The voltage level of the switch power supply.

Shutdown Temperature

This is the temperature that the computer will turn off the power to combat the effects of an overheating system. (requires ACPI to be enabled in Power Management BIOS and ACPI compliant operating system.) The default is Disabled.

Options available are 60°C/140°F to 75°C/167°F in increments of 5°C.

4-8 Frequency/Voltage Control

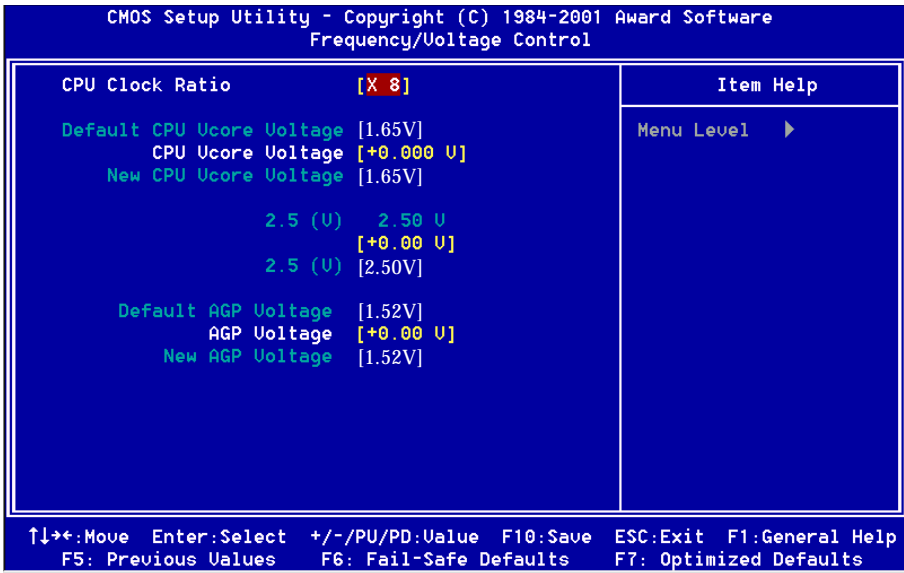

CPU Clock Ratio

This item allows you to select the CPU ratio. If the CPU ratio is fixed. This item was no function. Configuration options: [8.x]...[23x].

CPU Vcore Voltage

This item allows you to increase the CPU Vcore Voltage.
The option: $\pm 0.025V$ increment.

2.5V

This item allows you to increase the RDRAM Voltage.
The option: $+0.1V$ increment.

AGP Voltage

This item allows you to increase the Vagp Voltage. (Applicable when you plug in AGP card).

The option: $+0.1V$ increment.

4-9 Defaults Menu

Selecting “Defaults” from the main menu shows you two options which are described below

Load Fail-Safe Defaults

When you press <Enter> on this item you get a confirmation dialog box with a message similar to:

Load Fail-Safe Defaults (Y/N) ? N

Pressing ‘Y’ loads the BIOS default values for the most stable, minimal-performance system operations.

Load Optimized Defaults

When you press <Enter> on this item you get a confirmation dialog box with a message similar to:

Load Optimized Defaults (Y/N) ? N

Pressing ‘Y’ loads the default values that are factory settings for optimal performance system operations.

4-10 Supervisor/User Password Setting

You can set either supervisor or user password, or both of them. The differences between are:

supervisor password : can enter and change the options of the setup menus.

user password : just can only enter but do not have the right to change the options of the setup menus. When you select this function, the following message will appear at the center of the screen to assist you in creating a password.

ENTER PASSWORD:

Type the password, up to eight characters in length, and press <Enter>. The password typed now will clear any previously entered password from CMOS memory. You will be asked to confirm the password. Type the password again and press <Enter>. You may also press <Esc> to abort the selection and not enter a password. To disable a password, just press <Enter> when you are prompted to enter the password. A message will confirm the password will be disabled. Once the password is disabled, the system will boot and you can enter Setup freely.

PASSWORD DISABLED.

When a password has been enabled, you will be prompted to enter it every time you try to enter Setup. This prevents an unauthorized person from changing any part of your system configuration.

Additionally, when a password is enabled, you can also require the BIOS to request a password every time your system is rebooted. This would prevent unauthorized use of your computer.

You determine when the password is required within the BIOS Features Setup Menu and its Security option (see Section 3). If the Security option is set to "System", the password will be required both at boot and at entry to Setup. If set to "Setup", prompting only occurs when trying to enter Setup.

4-11 Exit Selecting

Save & Exit Setup

Pressing <Enter> on this item asks for confirmation:

Save to CMOS and EXIT (Y/N)? Y

Pressing “Y” stores the selections made in the menus in CMOS – a special section of memory that stays on after you turn your system off. The next time you boot your computer, the BIOS configures your system according to the Setup selections stored in CMOS. After saving the values the system is restarted again.

Exit Without Saving

Pressing <Enter> on this item asks for confirmation:

Quit without saving (Y/N)? Y

This allows you to exit Setup without storing in CMOS any change. The previous selections remain in effect. This exits the Setup utility and restarts your computer.

Section 5
850 and Sound Driver Installation

Easy Driver Installation



Insert the bundled autorun driver CD-disk.

Step 1 : Click the **INTEL CHIPSET INF FILES/INSTALLATION UTILITIES.** Install all components recommended.

Step 2 : Click the **INTEL ULTRA STORAGE DRIVER** to install ultra storage.

Step 3 : Click the **C-MEDIA 8738 AUDIO DIVER** to install audio sound driver.

CMI8738 Features:

- **Special Features**

PCI Plug and Play (PnP) bus interface, 32 bit PCI bus master.

Full duplex playback and recording, built-in 16 bits CODEC.

HRTF 3D positional audio, supports both Direct Sound 3D® & A3D® interfaces, supports earphones, two and four channel speakers mode.

Support Windows 3.1 / 95 / 98 and Windows NT 4.0.

Built-in 32 OHM Earphone buffer and 3D surround.

MPU-401 Game/Midi port and legacy audio SB16 support.

Downloadable Wave Table Synthesizer, supports Direct Music®.

- **Stereo Mixer and FM Music Synthesizer**

Stereo analog mixing from CD-Audio, Line-in

Stereo digital mixing from Voice, FM/Wave-table, Digital CD-Audio

Mono mixing from MIC and software adjustable volume

OPL3 FM synthesizer (4 operators)

Up to 15 melody sounds and 5 rhythm sounds (20 voices)

- **Game and Midi Interface**

Fully compatible with MPU-401 Midi UART and Sound Blaster Midi mode/ Standard IBM PC joystick/game port (dual channels)

PCI Audio Sound

Connectors and Jumper setting informations

Connector	Function
AUX-IN	AUX_IN Port (Signals:L-G-G-R)
CD-IN	Analog CD_IN Port (Signals:L-G-G-R)
MODEM_IN	Telephony Connector (Signals Audio-In-G-G-MIC-out to Modem)
LINE_IN	Connect with the audio output port of stereo or normal line in. Turn on or turn off by 4SPK in the Audio Rack Appc.
MIC	Connect with the Microphone (Mono)
LINE_OUT	Output to speakers with the amplifier or earphones or Audio_IN of home stereo
GAME/MIDI	Connect with Joystick or devices that use MIDI interface

Dos Installation

Before beginning the installation, please make sure that your hard disk has sufficient space(min. 4MB). Insert the Driver CD into the CD-ROM Drive.

1. Change directory to PCI audio DOS drivers folder (ex. D:\DOSDRV) at DOS prompt, and type:

INSTALL [Enter]

2. Type DOS utilities path which you want to install.
3. Program will expand the file to the path which you've specified.
4. Install program will add initial drivers into AUTOEXEC.BAT file.

Win95/98 Installation

We recommend that you install Microsoft Windows before you install this PCI sound card, and you not install any other sound card device drivers in your current system.

1. Power off your system, install the PCI sound card, audio cable, speaker, microphone, and insert driver CD into the CD-ROM drive.
2. Turn on the computer, and enter the Microsoft Windows 95 / 98.
3. You will see a windows prompt like this:
"New Hardware Found
PCI Multimedia Audio Device
Windows has found new hardware and is installing the software for it", then the dialog box shown. Click "Next" button to go on.
4. Click on "Other Locations..." button to specify drivers path.
5. When CMI8738/C3DX PCI Audio Device found, click "Finish".
6. Now, system is installing device drivers automatically. After a while, the system will finish the installation includes the following device drivers.
CMI8738/C3DX PCI Audio Device
CMI8738/C3DX PCI Audio Joystick Device
CMI8738/C3DX PCI Audio Legacy Device
DOS mode MPU-401 Emulator

PCI Audio Sound

8. Click “start” key
9. Select “Run”
10. Key in the drive and path for Windows application installation program, for example, “D:\W95-98\APP\SETUP.EXE”
11. Click “OK” to start the installation procedure, and follow the on-screen instructions to finish the installation. When all the application softwares have been installed, please shut down Windows 95/98 system, and reboot your system.

Win95/98 Un-Installation

If you install Win95/98 and a sound card at the same time, you might experience some technical difficulties(the device might not function properly). It is suggested that you proceed with the un-install procedure:

1. Click “start” button.
2. Select “run” item.
3. Find UINSTDRV.EXE in driver disk under Win95/98 drivers folder.
4. Run it.
5. Follow the on-screen instructions to re-install the hardware.

If you want to completely remove the drivers, you can also run the un-install procedure as described previously. Remove the sound card from the slot, and then reboot the system.

Windows NT 4.0 Installation

We recommend that you install Windows NT 4.0 before you install this onboard's PCI audio , and you not install any other sound card device drivers in your current system.

1. Click "Start" button, move the highlight bar to "Setting" item, and select the "Control Panel".
2. Double-click "Multimedia" icon.
3. Select "Devices" page, and press "Add" button.
4. Select "Unlisted or Updated Driver" item in "List of Drivers".
5. Specify the drive and the path where NT drivers are in (such as D:\NT40\DRV).
6. Select "C-Media CM8738" item and press "OK" button.
7. Select proper I/O value.
8. Press "OK" button.
9. Restart the system when being asked.
10. Now, you have already installed the PCI Audio Adapter under Microsoft Windows NT 4.0 successfully. if you want to install the Windows applications, continue the following steps:
11. Click "start" key.
12. Select "Run" item.
13. Key in drive and path for Windows NT application installation program, for example, "D:\NT40\APP\SETUP.EXE"
14. Click "OK" to start the installation procedure, and follow the on-screen instructions to finish the installation. When all of application softwares have been installed, shut down the Windows NT system, and then reboot your system.

PCI Audio Sound

Windows Appc. (The Audio Rack)

Introduction

By means of a user-friendly interface(as easy as operating your home stereo system), this PCI audio rack provides you with the control over your PC's audio functions, including the advantage of four speakers mode enable/ disable.



This Audio Rack consists of several major components:

Control Center: Controls the display of the PCI Audio Rack's components.



MIDI Player: Plays MIDI music files, and allows you to create your personal song playlists, and play the song files.

MP3/Wave Player: Records and plays digital audio (mp3/wave) files. Allows you to create wave file playlists, and playback the wave files.

CD Player: Plays standard audio CDs. Allows you to create your favorite song playlists.

System Mixer: Controls the volume level of your audio inputs and outputs.

Showing or Hiding Audio Rack Components

To remove or add a component from the display, click on the component's button on the Control Center's Button Bar or toggle it off.

MIDI Player, Wave Player, and CD Player



CD Player (above, similar to Wave Player and MIDI Player)

Sel (or Trk) field: If you have multiple selections in your playlist, this shows the number of the current selection or CD track.

Current File or Track: The name of the current MIDI file, wave audio file, or CD track.

Total Length field: displays the total length of files or tracks in minutes and seconds.

Current Time field: displays the current time of files or tracks in minutes and seconds when playback or recording.

Please refer to the help screen for more detail button function descriptions.
(click on help “  ” button on the player)

PCI Audio Sound

System Mixer

System Mixer allows you to control all the audio output and input levels. System Mixer displays the volume controls which your audio drivers make available. *The names for these controls may vary.*



Mixer panel while the four speakers mode is enabled.



Mixer panel while the four speakers mode is disabled.

Volume Control: Clicking on this button shows and allows you to use the output level controls.

Recording Control: Clicking on this button shows and allows you use the input level controls.



Input and Output Level Sliders and Buttons: For each input or output signal type, the control slider controls the loudness whereas the horizontal slider controls the balance between the two speakers. The mute button temporarily stops input or output without changing slider positions.

Control types and names might vary. The common types are listed below:

- **Vol:** The master control for all outputs. The strength of an output signal is determined by both the Vol slider and the slider for the individual output. To affect *all* outputs, move the Vol slider. To change the output of an *individual* output type, move *its* slider.
- **Line-in/Rear:** Controls the audio hardware's Line In or Line Out levels. Line levels might be for an externally attached cassette player, for instance, while the four speakers mode is enabled, this control becomes the Rear speaker volume control.

- **Mic:** Controls the microphone input level.
- **Wave:** Controls wave (voice) playback or the recording levels.
- **FM:** Controls the FM music playback or the recording level.
- **Aux-in:** Controls the Aux-in music play or the recording level.
- **CD:** Controls the CD drive output level, for CD drives configured to play their audio output through the PC's audio hardware.
- **4SPK:** Turn on or turn off the Rear speakers effect.
- **Surround:** Turn on or turn off the 3D surround sound effect.

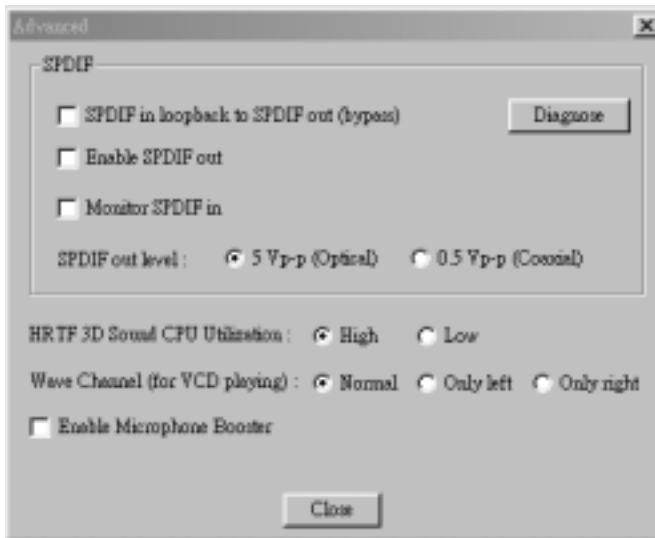

Mute Buttons: Toggle between muting and enabling the signal. A button with a lit LED is enabled, and when it is not lit, it means it is mute. Several *output* signals can usually be enabled at once.

PCI Audio Sound

The 4 Speakers System

This Audio Adapter provides 2 wave channels(front/rear), known as the 4 speakers system. When games or application programs via DirectSound® 3D or A3D® interface locate the sound sources to the listener's back, the two rear speakers will work to enhance the rear audio positional effect, so as to complement the insufficiency of using only two front speakers to emulate the audio effect. The following is the hardware installation and the software setups:

1. The speaker installation.

Connect the front pair speakers to the Line-out jack of the audio adapter, and then connect rear pair speakers to Line-in/Rear jack of the audio adapter. The original Line-in can be moved to Aux-in.

2. The positions of the speakers

Put your speakers the way the following picture suggests, so as to avail yourself to the best audio result.

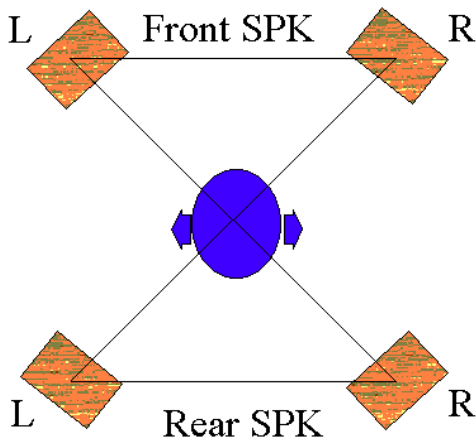

3. The mixer setup

There is a 4 speakers option in the volume control of the mixer, and when you enable this option, it means the rear speakers are connected to Line-in/Rear jack. When Line-in/Rear jack is connected to other external Line-in sources, please DO NOT enable this option in order to avoid hardware conflicts. Regarding rear speaker option, you can turn on or turn off the output of the back speakers, and adjust the volume, to have the rear/front speakers have the same volume.

4. The demo

Execute the “Helicopter” demo within the C3D HRTF Positional Audio Demos of this audio adapter. When the helicopter flies behind you, the rear speakers will work.



DEMO1: Present to you the complete 4-speaker surround sound effect.

DEMO2: Present to you the sound effects of each speaker.

You may also use the mouse to select any speaker and click it to make it work.

A-1 Update Your System BIOS

Download the xxxxx.EXE file corresponding to your model form the our website to an empty directory on your hard disk or floppy. Run the downloaded xxxxx.EXE file and it will self extract. Copy these extracted files to a bootable DOS floppy disk.

Note: The DOS floppy disk should contain NO device drivers or other programs.

1. Type "A:\AWDFLASH and press <Enter> Key.
2. You will see the following setup on screen.
3. Please key in the xxxxx.bin BIOS file name.

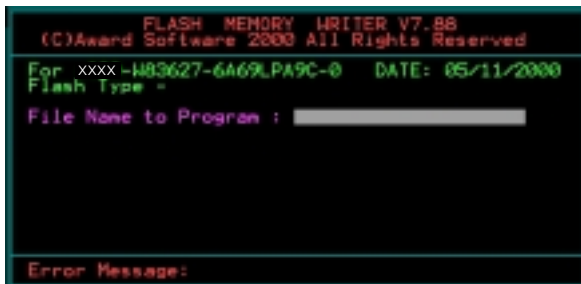

```
FLASH MEMORY WRITER V7.8B
(C)Award Software 2000 All Rights Reserved

For xxxxx-M83627-6A69LPA9C-0  DATE: 05/11/2000
Flash Type -
File Name to Program : _____

Error Message:
```

4. If you want to save the previous BIOS data to the diskette, please key in [Y], otherwise please key in [N].



```
FLASH MEMORY WRITER V7.8B
(C)Award Software 2000 All Rights Reserved

For xxxxx-M83627-6A69LPA9C-0  DATE: 05/11/2000
Flash Type - xxxxxx  E82B02AB /3.3V
File Name to Program : xxxxx.bin

Error Message: Do You Want To Save Bios (Y/N)
```

Appendix

5. Key in File Name to save previous BIOS to file.

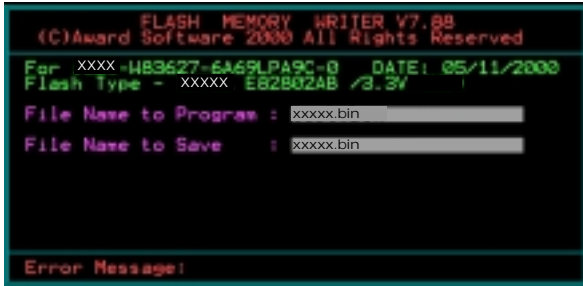

6. Are you sure to program (y/n), please key in [Y] to start the programming.

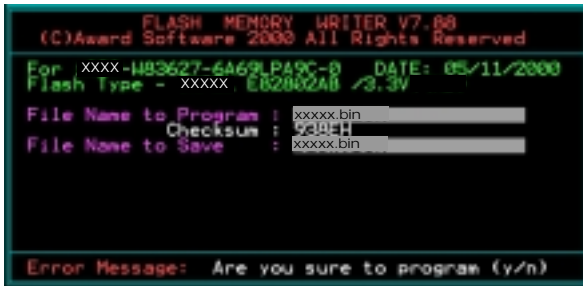

7. The programming is finished.

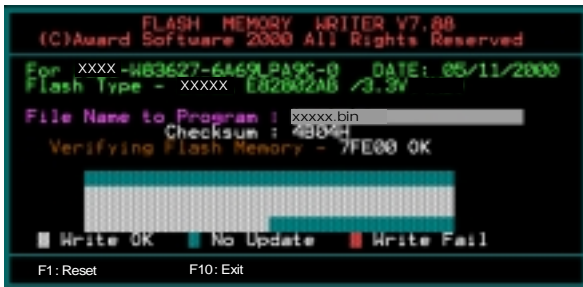

B-1 GHOST 5.1/6.03 Quick User's Guide

Installation is very easy. You only need to copy the **Ghost5** folder or **Ghost.exe** to your hard disk.

The current market version is for single **Client**, so the LPT and NetBios portions will not be explained further.

Description of Menus

Ghost clones and backs up **Disk** and **Partition**.

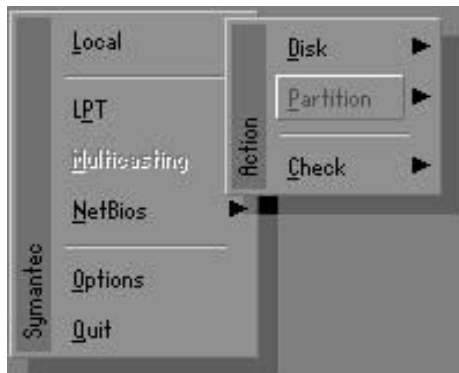

In which **Disk** indicates hard disk options
Partition indicates partition options
Check indicates check options

Disk

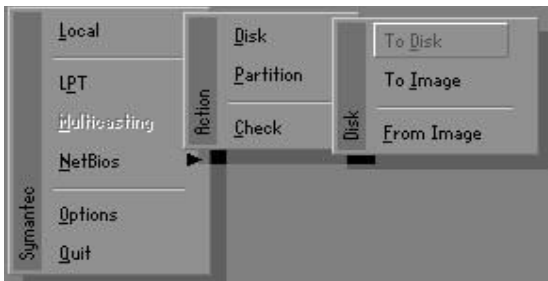

Appendix

There are 3 hard disk functions:

1. Disk To Disk (disk cloning)
2. Disk To Image (disk backup)
3. Disk From Image (restore backup)

Important!

1. To use this function, the system must have at least 2 disks. Press the **Tab** key to move the cursor.
2. When restoring to a destination disk, all data in that disk will be completely destroyed.

Disk To Disk (Disk Cloning)

1. Select the location of the **Source drive**.
2. Select the location of the **Destination drive**.

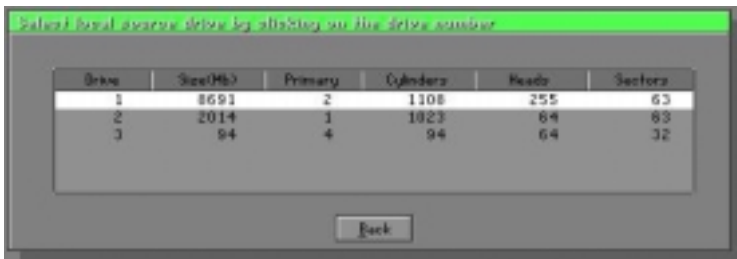

3. When cloning a disk or restoring the backup, set the required partition size as shown in the following figure.

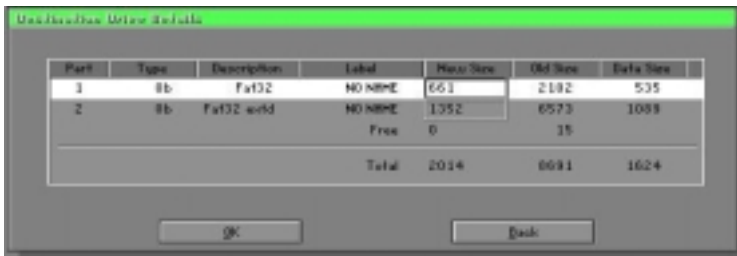

- Click OK to display the following confirmation screen. Select **Yes** to start.

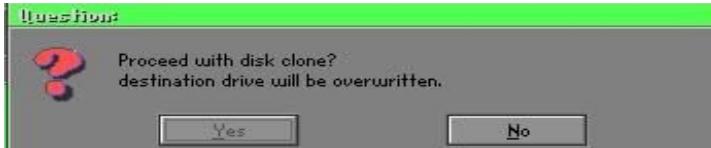

Disk To Image (Disk Backup)

- Select the location of the Source drive.

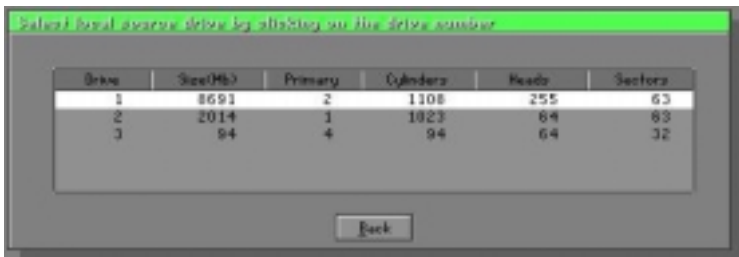

- Select the location for storing the backup file.

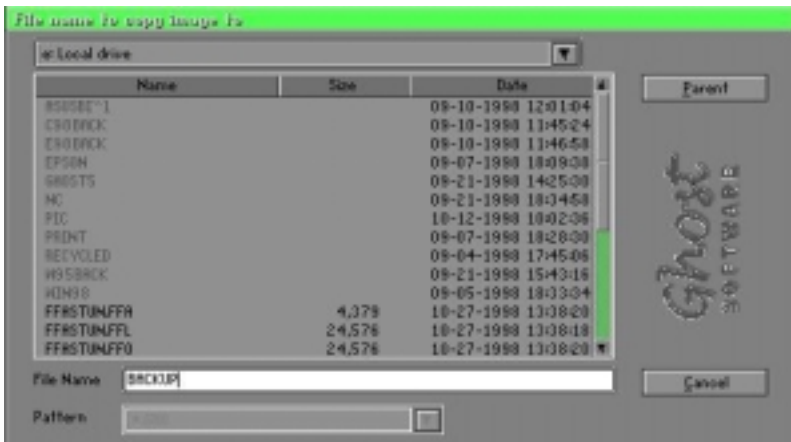

Appendix

3. Click **OK** to display the following confirmation screen. Select **Yes** to start.



Disk From Image (Restore Backup)

1. Select the Restore file.

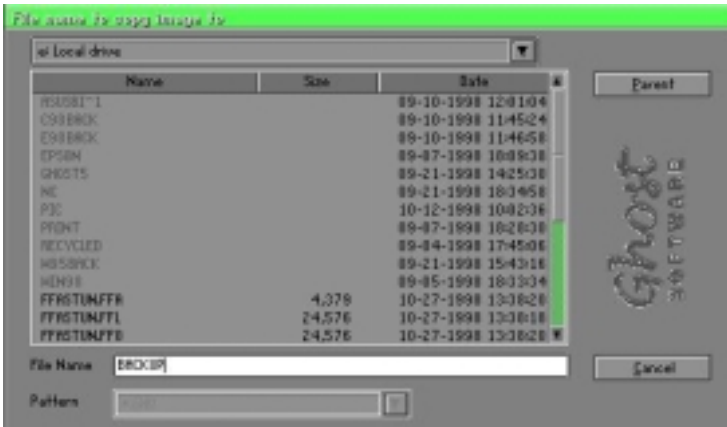

2. Select the **Destination drive** of the disk to be restored.

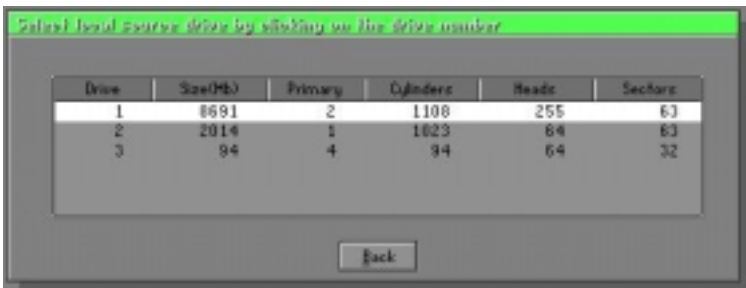

- When restoring disk backup, set the required partition size as shown in the following figure.

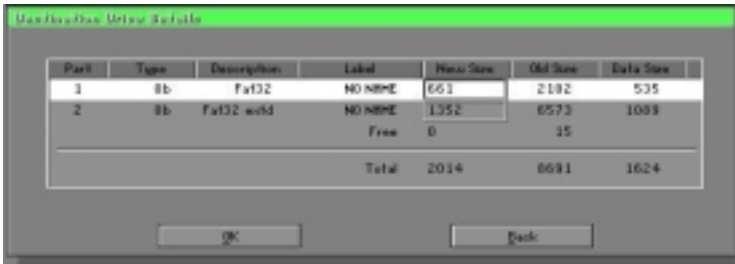

- Click **OK** to display the following confirmation screen. Select **Yes** to start.

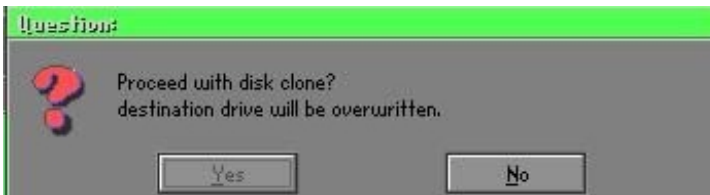

Partition

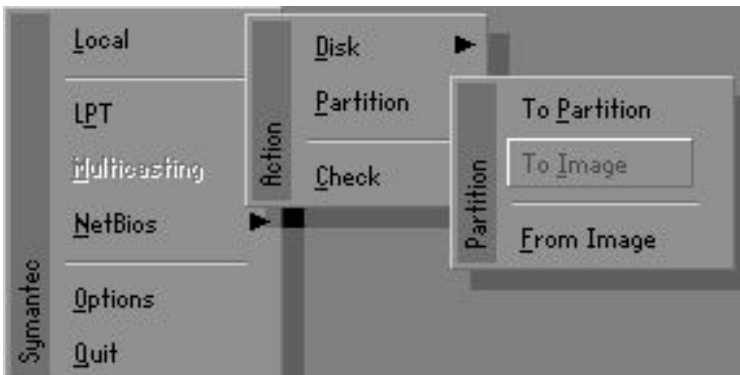

Appendix

There are 3 partition functions:

1. **Partition To Partition** (partition cloning)
2. **Partition To Image** (partition backup)
3. **Partition From Image** (restore partition)

Partition To Partition (Partition Cloning)

The basic unit for partition cloning is a partition. Refer to disk cloning for the operation method.

Partition To Image (Partition Backup)

1. Select the disk to be backed up.

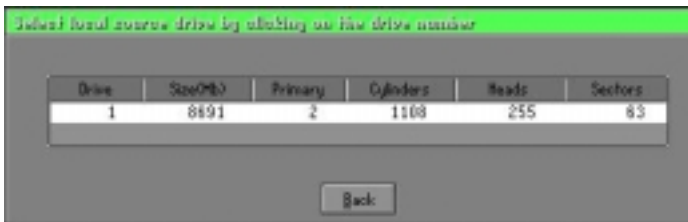

2. Select the first partition to be backed up. This is usually where the operating system and programs are stored.

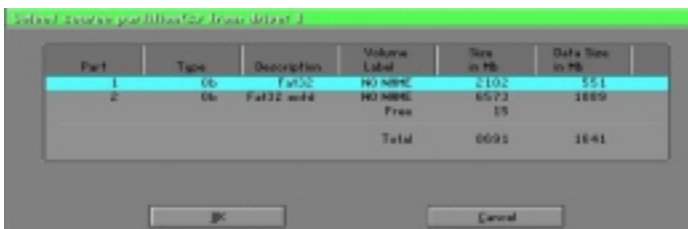

3. Select the path and file name for storing the backup file.

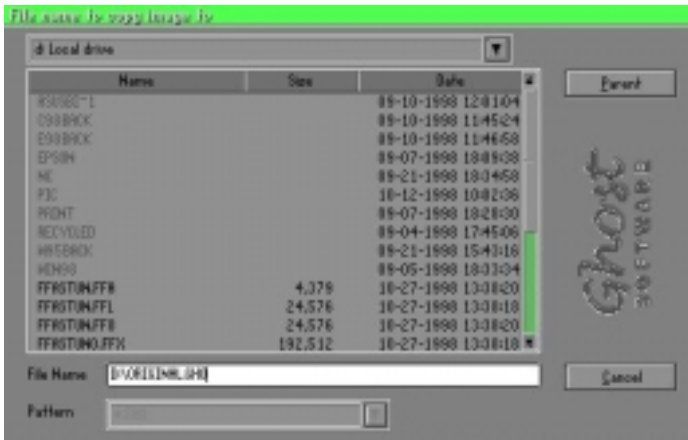

4. Is the file compressed? There are 3 options:

(1) No: do not compress data during backup

(2) Fast: Small volume compression

(3) High: high ratio compression. File can be compressed to its minimum, but this requires longer execution time.

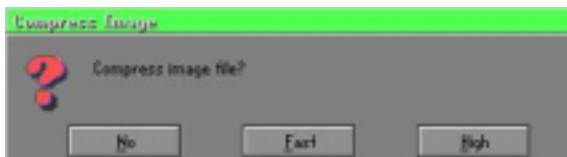

5. During confirmation, select Yes to start performing backup.



Appendix

Partition From Image (Restore Partition)

1. Select the backup file to be restored.

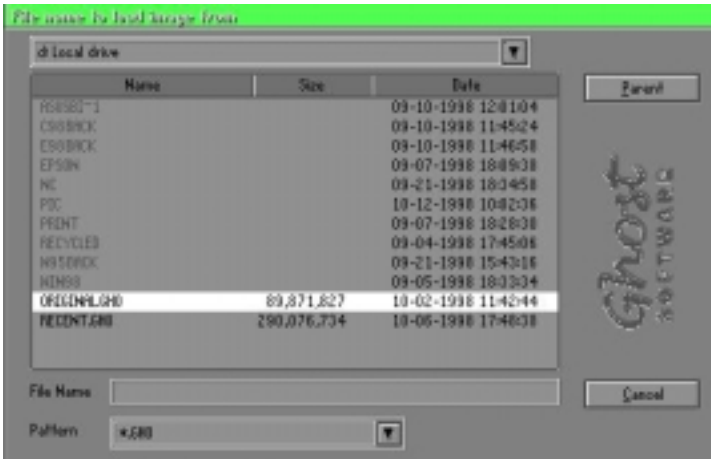

2. Select the source partition.

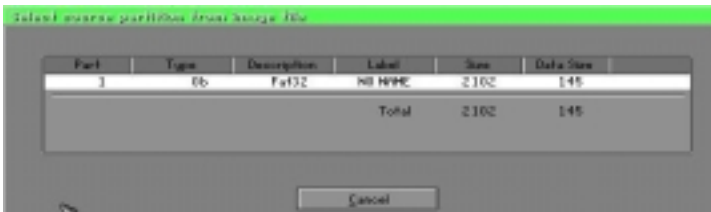

3. Select the disk to be restored.

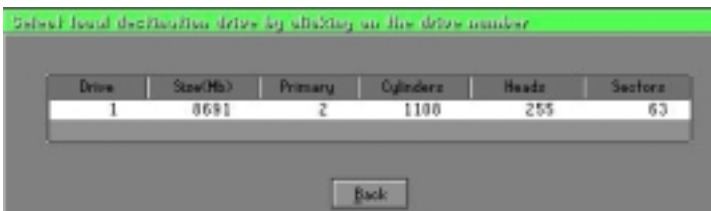

4. Select the partition to be restored.

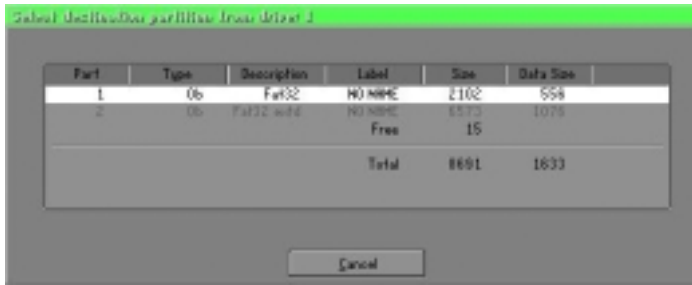

5. Select Yes to start restoring.

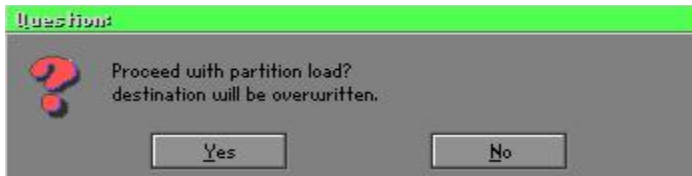

Check

This function checks the hard disk or backup file for backup or restoration error due to FAT or track error.

How to Reinstall Windows in 2 Minutes

This chapter teaches you how to set your computer properly and, if necessary, reinstall Windows in 2 minutes. Ghost can use different methods to complete this task. The following two sections explain the creation of the emergency Recover Floppy and Recover CD:

Emergency Recover Floppy

Divide a hard disk into two partitions. The first partition is for storing the operating system and application programs. The second partition is for backing up the operating system and data. The size of the partition can be set according to the backup requirements. For example, the **Windows** operating system needs 200MB of hard disk space, while the complete **Office** installation requires 360MB. The remaining space can be used to store other data.

After installing **Windows**, use **Ghost** to create a backup of the source system and store the file (Image file) in drive D. The file is named as **Original.gho**. Then, create a recover floppy disk containing:

- ◆ Bootable files (Command.com, Io.sys, and MSDOS.SYS)
- ◆ Config.sys (configuration setup file)
- ◆ Autoexec.bat (auto-execution batch file)
- ◆ Ghost.exe (Ghost execution file)

There are two ways to set the content of the recover floppy for restoration:

- (1) To load **Windows** automatically after booting, set the **Autoexec.bat** command as:

```
Ghost.exe clone, mode=pload, src=d:\original.gho:2,dst=1:1 -fx -sure -rb
```

Description: Runs the restore function automatically using the Image File. After execution, it exits Ghost and boots the system automatically.

Refer to the [Introducing Ghosts Functions].

- (2) After booting, the screen displays the Menu. Select Backup or Restore: Since the user may install other applications in the future, he/she may design **Autoexec.bat** as a Menu to back up or restore the user-defined Image file as follows:

Backup

Back up Windows and application programs as a file (Recent.gho). Command is:

```
Ghost -clone,mode=pdump,src=1:1,dst=d:\Recent.gho -fx -sure -rb
```

Restore

Restore types include [**General Windows**] and [**Windows and Application Programs**]. If you select [**General Windows**], the system is restored to the general **Windows** operation condition. The command is:

```
Ghost.exe -clone,mode=pload,src=d:\Original.gho,dst=1:1 -fx -sure -rb
```

If you select [**Windows and Application Programs**], the latest backup file (Recent.gho) is restored, skipping the installation and setup of application programs.

For description of relevant parameters, refer to [**Introducing Ghosts Functions**].

For more information about menu design, refer to Config.sys and Autoexec.bat under /Menu in the CD. You can also create a backup CD containing Ghost.exe and these two files.

Recover CD

In recent years, well-known computer manufacturers (such as IBM, Acer, Compaq, etc.) bundle Recover CDs with their computers to reduce the cost resulting from servicing, while at the same time increasing their market competitiveness.

The following is a simple guide to how to create a recover CD:

1. For extremely easy creation of the recover floppy disk, use the copy program for example "Easy CD Creator " (Note 2). First, create a recover floppy disk containing:

Bootable files (Command.com and Io.sys and MSDOS.SYS)

Config.sys (Configuration setup file)

Autoexec.bat (Auto-execution batch file)

Mscdex.exe (CD-Rom execution file)

Ghost.exe (Ghost execution file)

Oakcdrom.sys (ATAPI CD-ROM compatible driver)

The content of Config.sys is:

```
DEVICE=Oakcdrom.sys /d:idecd001
```

The content of Autoexec.bat includes:

```
MSCDEX.EXE /D:IDECD001 /L:Z
```

```
Ghost.exe clone,mode=load,src=z:\original.gho,dst=1 -sure -rb
```

2. Write the backup image file (original.gho) of the entire hard disk or partition into the recover CD. Use the Recover CD to boot up the system and restore the backup files automatically.

For description of relevant parameters, refer to **[Introducing Ghosts Functions]**.

Note: For more details regarding the creation program and method for creating the recover CD, please refer to the legal software and relevant operation manual.

Ghost Command Line Switches Reference

Ghost may be run in interactive or in batch mode. Batch mode is useful for automating installations for backups using Ghost. Most of the Ghost switches are used to assist with batch mode operation. To list switches from Ghost, type `ghost.exe -h`.

-clone

The full syntax for this switch is:

```
clone,MODE={ copy|load|dump|pcopy|pload|pdump },SRC=
{ drive|file|drive:partition|,DST={ drive|file|drive:partition } ,SIZE{ F|L|n=
{ nnnnM|nnP|F|V }
```

Clone using arguments. This is the most useful of the batch switches and has a series of arguments that define:

- a) **MODE** This defines the type of clone command to be used:
- | | |
|--------------|-----------------------------|
| COPY | disk to disk copy |
| LOAD | file to disk load |
| DUMP | disk to file dump |
| PCOPY | partition to partition copy |
| PLOAD | file to partition load |
| PDUMP | partition to file dump |
- b) **SRC** This defines the source location for the operation:
- | Mode | Meaning: |
|---------------|-------------------------------------------------------------------------------------------------------------------------------------------|
| COPY/ | |
| DUMP | Source drive (e.g, 1 for drive one) |
| LOAD | Disk image filename or device (e.g, g:\Images\system2.img) |
| PCOPY/ | |
| PDUMP | Source partition e.g, 1:2 indicates the second partition on drive one. |
| PLOAD | Partition image filename or device and partition number. Example: g:\images\disk1.img:2 indicates the second partition in the Image file. |

Appendix

- c) **DST** This defines the destination location for the operation:
- | Mode | Meaning |
|---------------|-------------------------------------------------------------------------------|
| COPY/ | |
| LOAD | Destination drive (e.g, 2 for drive two) |
| DUMP | Disk image filename or device,(e.g, g:\images\system2.img) |
| PCOPY/ | |
| PLOAD | Destination partition,(e.g, 2:2 indicates the second partition on drive two). |
| PDUMP | Partition image filename (e.g, g:\images\part1.img). |
- c) **SIZEy** Used to set the size of the destination partitions for either a disk load or disk copy operation.

Available y Options:

- F** Resizes the first partition to maximum size allowed based on file system t type.
- L** Resizes the last partition to maximum size allowed based on file system type.
- n=xxxxM** - indicates that the nth destination partition is to have a size of xxxx Mb. (e.g, **SZE2=800M** indicates partition two is to have 800 mb.)
- n=mmP** - indicates that the nth destination partition is to have a size of mm percent of the target disk.
- n=F** - indicates that the nth destination partition is to remain fixed in size.
- n=V** - Indicates that the partition will be resized according to the following rules:
 - Rule 1** - If the destination disk is larger than the original source disk, then the partition(s) will be expanded to have the maximum amount of space subject to the free space available and the partition type (e.g, FAT16 partitions will have a maximum size of 2048Mb.)
 - Rule 2** - If the destination disk is smaller than the original source disk, (but still large enough to accommodate the data from the source disk), the free space left over after the

data space has been satisfied will be distributed between the destination partitions in proportion to the data usage in the source partitions. Some examples follow that will help illustrate:

- fx flag Exit. Normally when Ghost has finished copying a new system to a disk, it prompts the user to reboot with a press Ctrl-Alt-Del to reboot window. However, if Ghost is being run as part of a batch file it is sometimes useful to have it just exist back to the DOS prompt after completion so that further batch commands may be processed. -fx enables this. See -rb for another option on completing a clone.
- ia Image All. The Image All switch forces Ghost to do a sector by sector copy of all partitions. When copying a partition from a disk to an image file or to another disk, Ghost examines the source partition and decides whether to copy just the files and directory structure, or to do an image (sector by sector) copy. If it understands the internal format of the partition it defaults to copying the files and directory structure. Generally this is the best option, but occasionally if a disk has been set up with special hidden security files that are in specific positions on the partition, the only way to reproduce them accurately on the target partition is via an image or sector-by-sector copy.
- span enables spanning across volumes.
- split=x splits image file into 'x' Mb? Mb spans. Use this to create a 'forced' size volume set. For example, if you would like to force smaller image files from a 1024 Megabyte drive, you could specify 200 megabyte segments. For example, ghost.exe -split=200 will divide the image into 200 Megabyte segments.
- sure use the -sure switch in conjunction with -clone to avoid being prompted with the final 'Proceed with disk clone destination drive will be overwritten?' question. This command is useful in batch mode.

Appendix

Example 1:

To copy drive one to drive two on a PC, without final prompt if OK to proceed.

```
ghost.exe -clone,mode=copy,src=1,dst=2 -sure
```

Example 2:

To connect via NetBIOS to another PC running Ghost in slave mode, and dump a disk image of local drive two to the remote file c:\drive2.gho

```
ghost.exe -clone,mode=dump,src=2,dst=C:\drive2.gho -nbm
```

Note: The slave Ghost can be started with `ghost -nbs`

Example 3:

To copy drive one, second partition on a PC to drive two, first partition the same PC, without final prompt

```
ghost.exe -clone,mode=pcopy,src=1:2,dst=2:1 -sure
```

Example 4:

To dump the second partition of drive one to an image file on a mapped drive g:

```
ghost.exe -clone,mode=pdump,src=1:2,dst=g:\part2.gho
```

Example 5:

To load partition 2 from a two-partition image file on a mapped drive g: onto the second partition of the local disk

```
ghost -clone,mode=pload,src=g:\part2.gho:2,dst=1:2
```

Example 6:

To load drive 2 from an image file and resize the destination partitions into a 20:40 allocation

```
ghost.exe -clone,mode=load,src=g:\2prtdisk.gho,dst=2,size1=60P,  
size2=40P
```

C-1 EEPROM BIOS Remover

Do not remove the BIOS chip, unless instructed by a technician and only with a PLCC IC extractor tool.

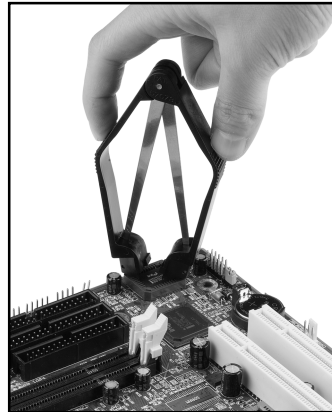
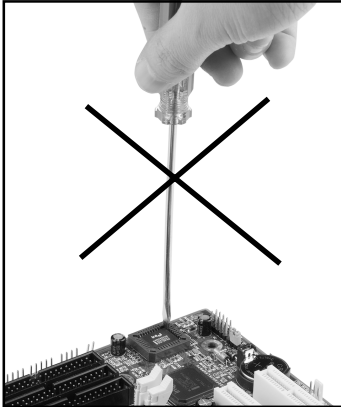

The BIOS socket may be damaged if using an improper method to replace the BIOS chip.

