



# User's Manual

**A Socket 370 Processor based  
mainboard (133/100/66 MHz)**

**Supports PC133/VC133 Memory Modules**

## **TRADEMARK**

All products and company names are trademarks or registered trademarks of their respective holders.

*These specifications are subject to change without notice.*

*Manual Revision 1.0  
June 19, 2001*



---

# Table of Contents

---

		<i>Page</i>
<b><i>Section 1</i></b>	<b><i>Introduction</i></b>	
	Components Checklist .....	1-1
	Form-Factor .....	1-2
	I/O Shield Connector .....	1-3
	Power-On/Off (Remote) .....	1-3
	System Block Diagram .....	1-4
<b><i>Section 2</i></b>	<b><i>Features</i></b>	
	Mainboard Features .....	2-1
<b><i>Section 3</i></b>	<b><i>Installation</i></b>	
	Mainboard Detailed Layout .....	3-2
	<b><i>Easy Installation Procedure</i></b>	
	CPU Insertion .....	3-3
	Jumper Settings .....	3-5
	System Memory Configuration .....	3-7
	Device Connectors .....	3-9
	Keyboard Power ON Function (KBPO) .....	3-12
<b><i>Section 4</i></b>	<b><i>Award BIOS Setup</i></b>	
	Main Menu .....	4-1
	Standard CMOS Setup .....	4-2
	Advanced BIOS Features .....	4-3
	Advanced Chipset Features .....	4-7
	Integrated Peripherals .....	4-11
	Power Management Setup .....	4-15
	PNP/PCI Configuration .....	4-18
	PC Health Status .....	4-20
	Frequency/Voltage Control .....	4-21

---

---

Defaults Menu .....	4-22
Supervisor/User Password Setting .....	4-23
Exit Selecting .....	4-24

***Section 5***

***Driver Installation***

Easy Driver Installation .....	5-1
--------------------------------	-----

***Appendix***

***Appendix A***

GHOST 5.1/6.03 Quick User's Guide .....	A-1
-----------------------------------------	-----

***Appendix B***

Update Your System BIOS .....	B-1
-------------------------------	-----

---

Section 1  
INTRODUCTION

Components Checklist

- ✓ A. (1) Mainboard
- ✓ B. (1) User's manual
- ✓ C. (1) Floppy ribbon cable
- ✓ D. (1) ATA-66/100 Hard drive ribbon cable
- E. (1) USB Cable (Optional)
- ✓ F. (1) Driver and utility

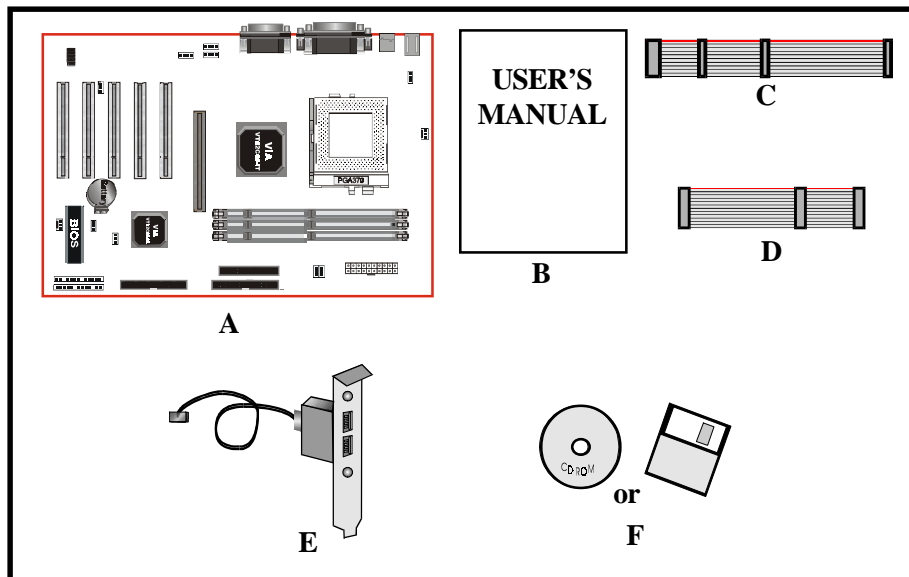

# Introduction

---

## Mainboard Form-Factor

---

The board is designed with ATX form factor - the new industry standard of chassis. ATX form factor is essentially a Baby-AT baseboard rotated 90 degrees within the chassis enclosure and a new mounting configuration for the power supply. With these changes the processor is relocated away from the expansion slots, allowing them all to hold full length add-in cards. ATX defines a double height aperture to the rear of the chassis which can be used to host a wide range of onboard I/O. Only the size and position of this aperture is defined, allowing PC manufacturers to add new I/O features (e.g.; TV input, TV output, joystick, modem, LAN, etc.) to systems. This will help systems integrators differentiate their products in the marketplace, and better meet your needs.

- Smaller size promotes a smaller system size.
- I/O shield does not need to be retooled in an ATX 2.01 or later. The mainboard should be used in an ATX 2.01 (or later) compliant case.
- A smaller power supply can be used. High integration on mainboard reduces the system costs.

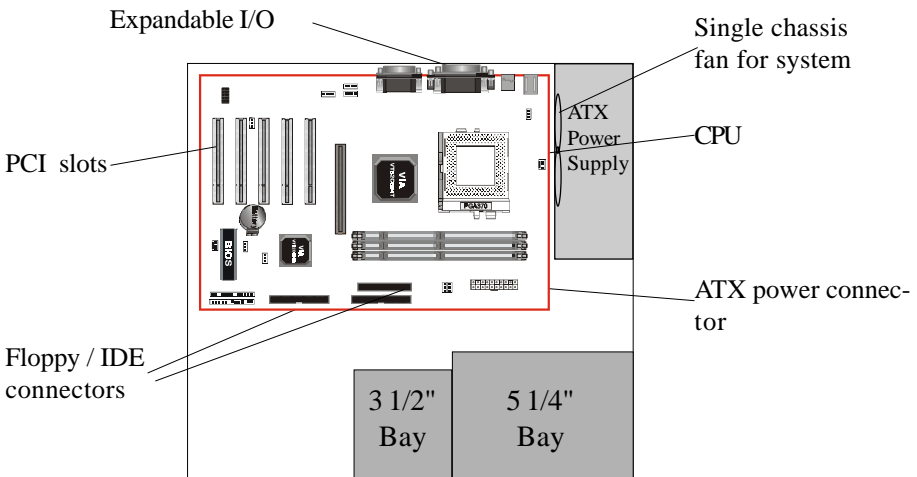

Figure 2: Summary of ATX chassis features

## I/O Shield Connector

The board is equipped with an I/O back panel. Please use the appropriate I/O shield (figure 3).

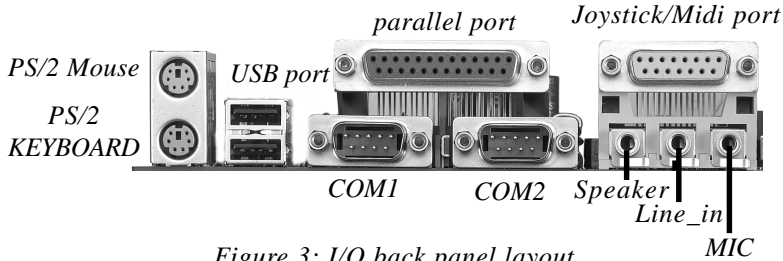

Figure 3: I/O back panel layout

## Power-On/Off (Remote)

The board has a single 20-pin connector for ATX power supplies. For ATX power supplies that support the **Remote On/Off** feature, this should be connected to the systems front panel for system Power On/Off button. The systems power On/Off button should be a momentary button that is normally open.

The board has been designed with "Soft Off" functions. You can turn Off the system from one of two sources: The first is the front panel Power On/Off button, and the other is the "Soft Off" function (coming from the M/B's onboard circuit controller) that can be controlled by the operating system such as Windows® 95/98/SE/ME or Windows® 2000.

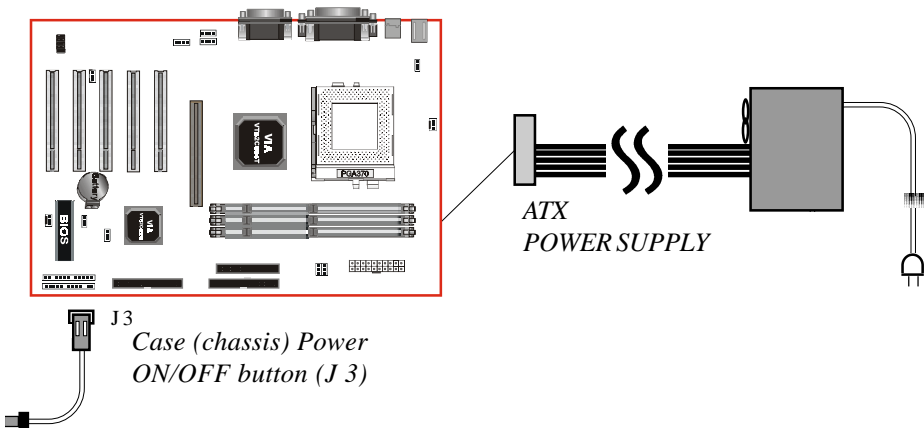

Figure 4: Simple ATX Power ON/OFF Controller

# Introduction

## System Block Diagram

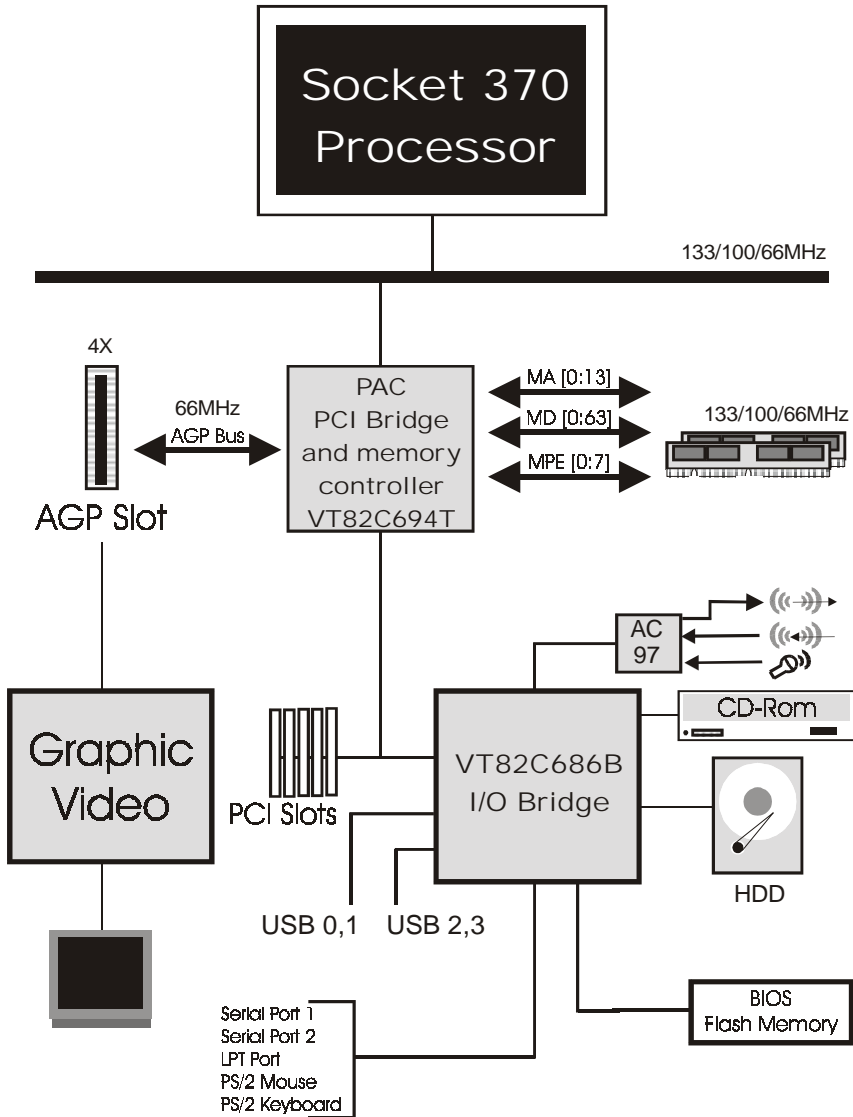

Figure 5: System Block Diagram



### Mainboard Features:

#### ◆ PROCESSOR

- Intel Celeron™ II Processors with FC-PGA socket 370 packing: operating at 533MHz ~ 850MHz
- Intel Pentium® III /Coppermine™ Processors with FC-PGA socket 370 packing: operating at 500MHz ~ 1.13GHz
- Intel Pentium® III /Tualatin™ Processors with FC-PGA socket 370 packing: operating at 1.13GHz ~ 1.26GHz
- VIA C3 Samuel 2 Processors with FC-PGA socket 370 packing: operating at 733MHz ~ 850MHz

#### ◆ CHIPSET

- VIA Apollo Pro133T AGPset (VT82C694T + VT82C686B)

#### ◆ DRAM MODULE

- 168pin DIMM x 3 for PC133/VC133 Memory
- DRAM Size: 32MB to 1.5GB

#### ◆ EXPANSION SLOT

- PCI x 5, 4X AGP x 1

#### ◆ ONBOARD I/O

- On-Chip Multi I/O integrated with K/B, mouse, FDD, Parallel and Serial, Fast IR and Power-ON controllers

#### ◆ ONBOARD PCI / IDE

- PCI Bus IDE Port with PIO / Ultra DMA-100 x 2 (Up to 4 Devices)

## Features

---

### ◆ I/O CONNECTOR

- PS/2 Mouse and PS/2 style Keyboard

### ◆ USB

- USB connector x 4 (2 for Opt.)

### ◆ BIOS

- Award Plug & Play BIOS

### ◆ Built-in AC97 Digital Audio

- Dual full-duplex Direct Sound channels
- H/W Sound Blaster Pro for DOS legacy compatibility
- FM synthesis for legacy compatibility
- Supports game and MIDI port

### ◆ EXTENDED FUNCTION

- Supports exclusive USDM(Unified System Diagnostic Manager) and Hardware Monitoring Function by VT82C686B
- Supports exclusive KBPO (KeyBoard Power On)
- Supports CPU Clock setting via Jumper & BIOS
- Supports Wake-On-LAN Function

### ◆ FORM FACTOR

- 305mm x 200mm ATX Size

Section 3  
INSTALLATION

Mainboard Detailed Layout

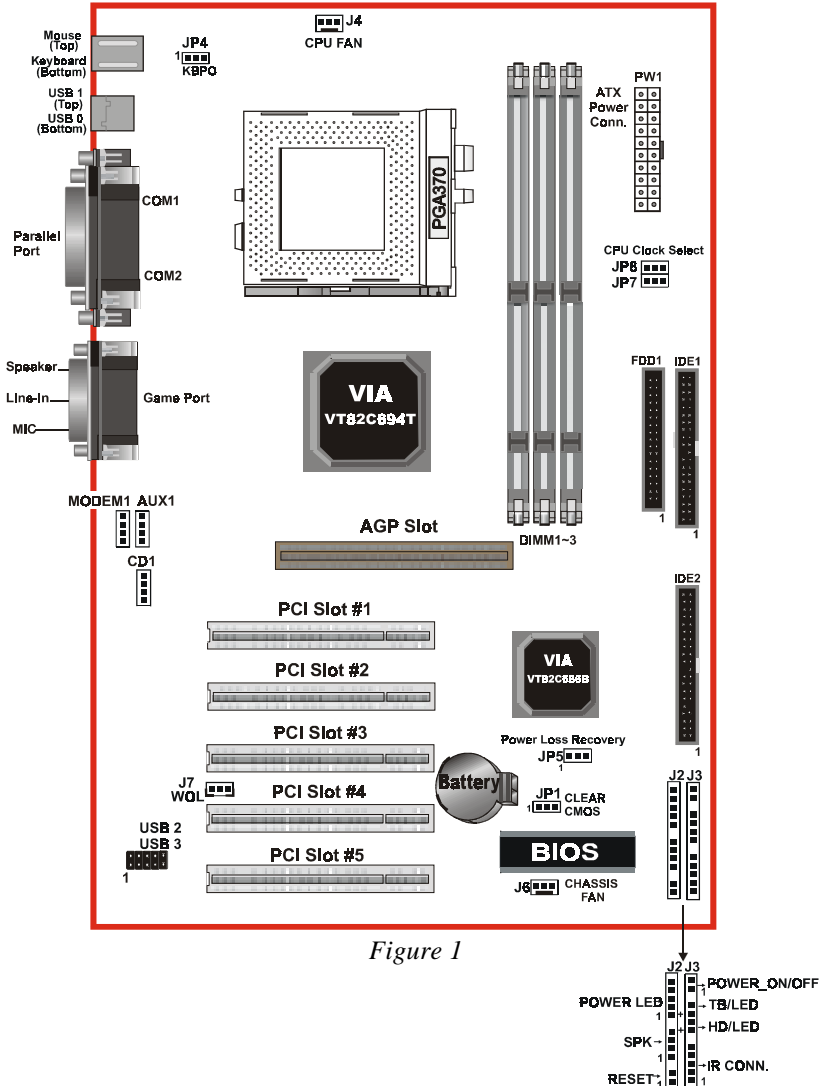

# Installation

---

## Easy Installation Procedure

The following must be completed before powering on your new system:

- 3-1. CPU Insertion**
- 3-2. Jumper Settings**
- 3-3. System memory Configuration**
- 3-4. Device Connectors**
- 3-5. External Modem Ring-in Power ON and Keyboard Power ON Functions (KBPO)**

### Section 3-1 CPU Insertion

---

#### CPU Insertion

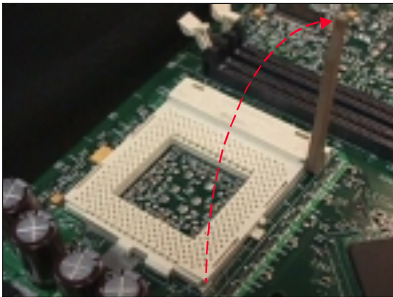

*Figure 2*

#### **Step 1**

Open the socket by raising the actuation lever.

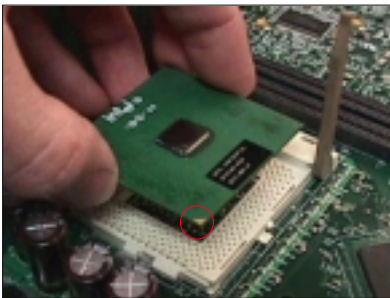

*Figure 3*

#### **Step 2**

Insert the processor.

Ensure proper pin 1 orientation by aligning the FC-PGA corner marking with the socket corner closest to the actuation arm tip. The pin field is keyed to prevent mis-oriented insertion.

Don't force processor into socket. If it does not go in easily, check for mis-orientation and debris. Make sure the processor is fully inserted into the socket on all sides.

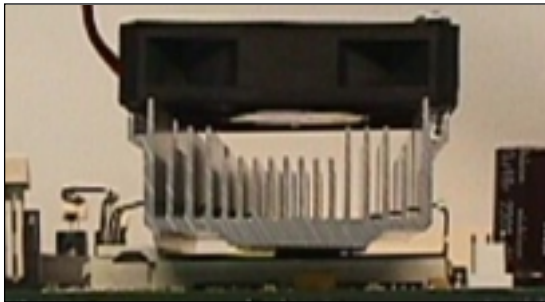

*Figure 4*

### Step 3

Close the socket by lowering and locking the actuation lever.

Note: Intel's reference design thermal solution is an active heatsink; an extruded aluminum heatsink based and a fan attached to the top on the fin array. (See Figure 5)



*Figure 5*

# Installation

---

## Section 3-2 Jumper Settings

---

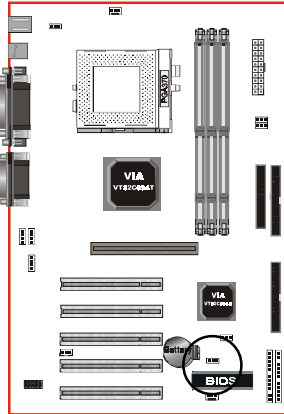

JP1



CMOS Clear

JP1 =1-2 Normal (Default)

=2-3 Clear CMOS

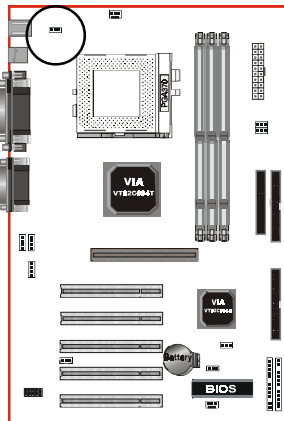

JP4



Keyboard Power-ON Function

JP4 =1-2 Disabled (Default)

=2-3 Enabled

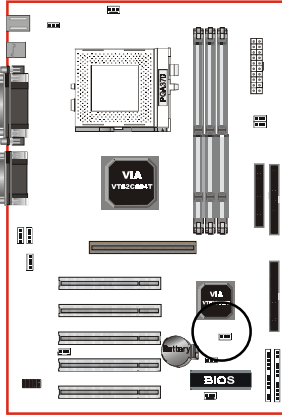

JP5



Power Loss Recovery  
 JP5 =1-2 Disabled (Default)  
 =2-3 Enabled

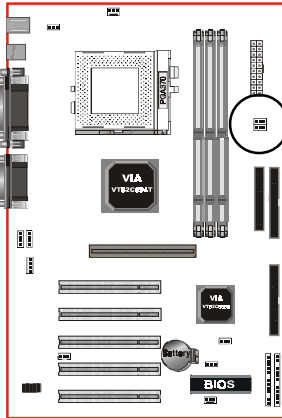

JP8  
 JP7



CPU Host Clock Select

JP7	JP8	CPU Clock Select
1-2	1-2	AUTO
2-3	2-3	66MHz
None	2-3	100MHz
None	None	133MHz

(Default)

# Installation

## Section 3-3 System Memory Configuration

### Memory Layout

The board supports (3) PC133/VC133 168-pin DIMMs (Dual In-line Memory Module). The DIMMs is for SDRAM (Synchronous DRAM) .

- DIMM SDRAM may be 83MHz (12ns), 100MHz (10ns), 125MHz (8ns) or 133MHz (7.5ns)bus speed.
- When using Synchronous DRAM we recommend using the 4 clock variety over the 2 clock.

Figure 6 and Table 1 show several possible memory configuration.

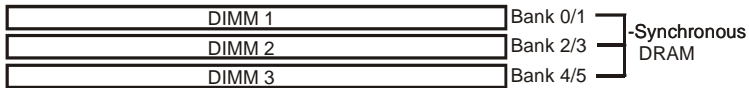

Figure 6

Total Memory	DIMM 1 (Bank 0/1)	DIMM 2 (Bank 2/3)	DIMM 3 (Bank 4/5)
= 512MB Maximum	SDRAM* 32MB, 64MB, 128MB, 256MB, 512MB X 1	None	None
= 1GB Maximum	SDRAM* 32MB, 64MB, 128MB, 256MB, 512MB X 1	SDRAM* 32MB, 64MB, 128MB, 256MB, 512MB X 1	None
= 1.5GB Maximum	SDRAM* 32MB, 64MB, 128MB, 256MB, 512MB X 1	SDRAM* 32MB, 64MB, 128MB, 256MB, 512MB X 1	SDRAM* 32MB, 64MB, 128MB, 256MB, 512MB X 1

Table 1

- \* SDRAM supports 32, 64, 128, 256, 512MB DIMM modules.
- \* We recommend to use PC100/VC100 Memory Module for bus speed between 66MHz and 100MHz and PC133/VC133 Memory for bus speed over 100MHz.
- \* Using non-compliant memory with higher bus speed (over clocking) may severely compromise the integrity of the system.



## DIMM Module Installation

Figure 7 displays the notch marks and what they should look like on your DIMM memory module.

DIMMs have 168-pins and two notches that will match with the onboard DIMM socket. DIMM modules are installed by placing the chip firmly into the socket at a 90 degree angle and pressing straight down (figure 8) until it fits tightly into the DIMM socket (figure 9).

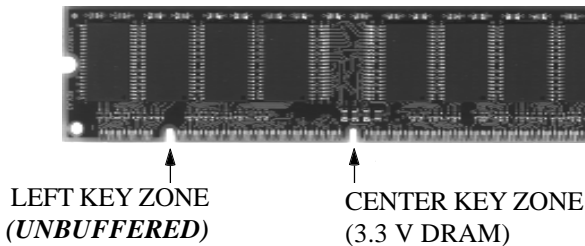

Figure 7

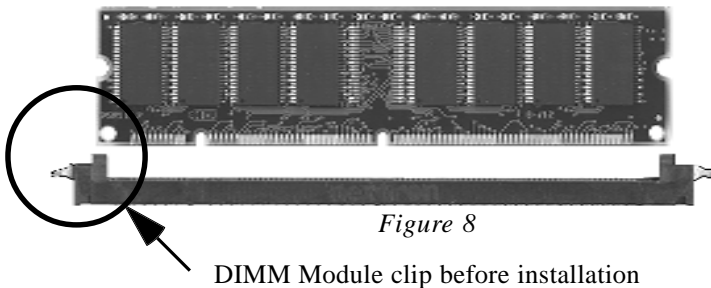

Figure 8

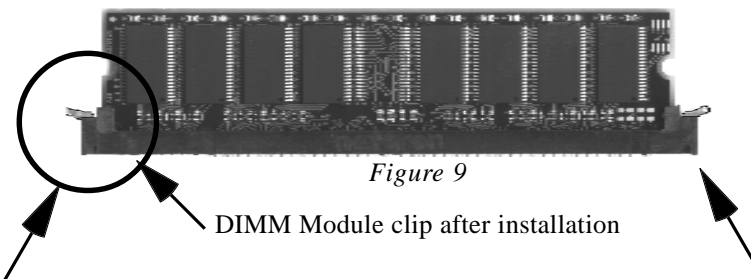

Figure 9

To remove the DIMM module simply press down both of the white clips on either side and the module will be released from the socket.

# Installation

---

## Section 3-4 Device Connectors

---

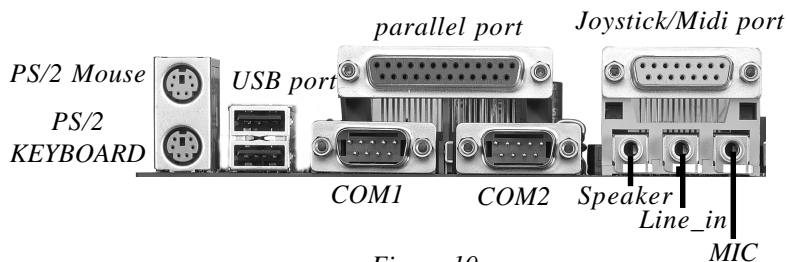

Figure 10

**J2,J3:** Chassis Panel Connector

- Power\_LED, Speaker, Reset, Power On/Off, Turbo LED, HDD LED, IR Conn.

**J4:** CPU Fan

- A plug-in for the CPU Fan Power

**J6:** Chassis Fan

- A plug-in for the chassis Fan Power

**J7:** WOL (Wake On Lan) Connector

**IDE1:** Ultra ATA-66/100 Primary IDE Connector (Blue color)

**IDE2:** Ultra ATA-66/100 Secondary IDE Connector (Blue color)

**FDD1:** Floppy Controller Connector (Black color)

**PW1:** ATX Power Connector

- 20-pin power connector

**CD1:** CD Audio\_IN Connector

- Pin1(CD\_IN\_Left), Pin2/Pin3(CD\_Reference), Pin4(CD\_IN\_Right)

**AUX1:** Auxiliary Line\_IN Connector

- Pin1(Left Line\_IN), Pin2/Pin3(GND), Pin4(Right Line-IN)

**MODEM1:** Telephony Connector for Modem audio output

- Pin1(Audio\_in), Pin2/Pin3(GND), Pin4(Mic-out to Modem)

**USB2:** USB port header pins for adding two additional USB ports.

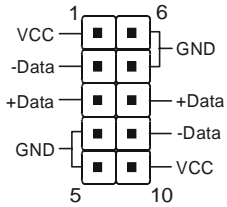

USB port header pin descriptions.

PIN#	Wire color	Signal Name	Comment
1	Red	Vcc	Cable Power
2	White	-Data	Data
3	Green	+Data	Data
4	Black	Ground	Cable Ground
5	Black	Ground	Case Ground
6	Black	Ground	Case Ground
7	Black	Ground	Cable Ground
8	Green	+Data	Data
9	White	-Data	Data
10	Red	Vcc	Cable Power

# Installation

---

## Device Connectors (continued)

(This is connected to the power button on the case. Using the Soft-Off by Pwr-BTTN feature, you can choose either Instant Off (turns system off immediately), or 4 sec delay (you need to push the button down for 4 seconds before the system turns off). When the system is in 4 sec delay mode, suspend mode is enabled by pushing the button momentarily.)

**J3**

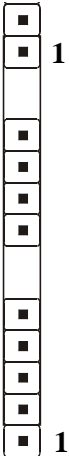

**Power On/Off**

**Turbo LED indicator** - LED ON when higher speed is selected

**IDE LED indicator** - LED ON when Onboard PCI IDE Hard disks is activate

**IR Connector**

- |         |         |
|---------|---------|
| 1. VCC  | 4. GND  |
| 2. NC   | 5. IRTX |
| 3. IRRX |         |

**J2**

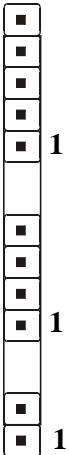

**Power LED** - Power LED connector

- |                 |        |
|-----------------|--------|
| 1. Power LED(+) | 4. NC  |
| 2. N/C          | 5. GND |
| 3. GND          |        |

**Speaker** - Connect to the system's speaker for beeping

- |            |        |
|------------|--------|
| 1. Speaker | 3. GND |
| 2. N/C     | 4. GND |

**Reset** - Closed to restart system.

## Section 3-5 External Modem Ring-in Power ON and Keyboard Power ON Functions (KBPO)

---

On the basis of bounded functions in I/O chipset, the two serial ports are able to support the External Modem Ring-in Power ON function. Once users connect the external modem to COM1 or COM2, the mainboard allows users to turn on their system through the remote and host's dial-up control.

### **Exclusive Keyboard Power ON Function**

To innovate a unique feature to benefit users, we devoted the easiest and most convenient way to turn on your system based on the the ATX power supply.

How to work with it

**Step 1:** Please check JP4 at the position 2-3 after you finished the system installation.

**JP4**



Keyboard Power-ON Function

JP4 = 1-2 Disabled (Default)

= 2-3 Enabled

**Step 2:** You can enjoy the Keyboard Power ON function (KBPO) by *pressing any key and BUTTON only to turn on your system*. Your system will be turned on automatically, after releasing the keys. To power off you system, you can use the Soft-OFF function under Windows® 95/98/SE/ME or Windows® 2000.

**Notes:** Intel ATX version 2.0 specification recommended you use the power supply with 0.72A(720mA) in 5.0VSB. With our mainboard, *the 5.0VSB standby power only has to be  $\geq 0.2A$  (200mA)* then you can enjoy this unique benefit. However, an ATX power supply which is  $< 0.2A$  (200mA) is still useable to your system by placed JP4 at the position 1-2 to disable this feature.

---

## Section 4

# AWARD BIOS SETUP

---

### Main Menu

---

Award's ROM BIOS provides a built-in Setup program which allows user to modify the basic system configuration and hardware parameters. The modified data will be stored in a battery-backed CMOS, so that data will be retained even when the power is turned off. In general, the information saved in the CMOS RAM will stay unchanged unless there is a configuration change in the system, such as hard drive replacement or a device is added.

It is possible for the CMOS battery to fail, this will cause data loss in the CMOS only. If this does happen you will need to reconfigure your BIOS settings.

#### To enter the Setup Program :

Power on the computer and press the <Del> key immediately, this will bring you into the BIOS CMOS SETUP UTILITY.

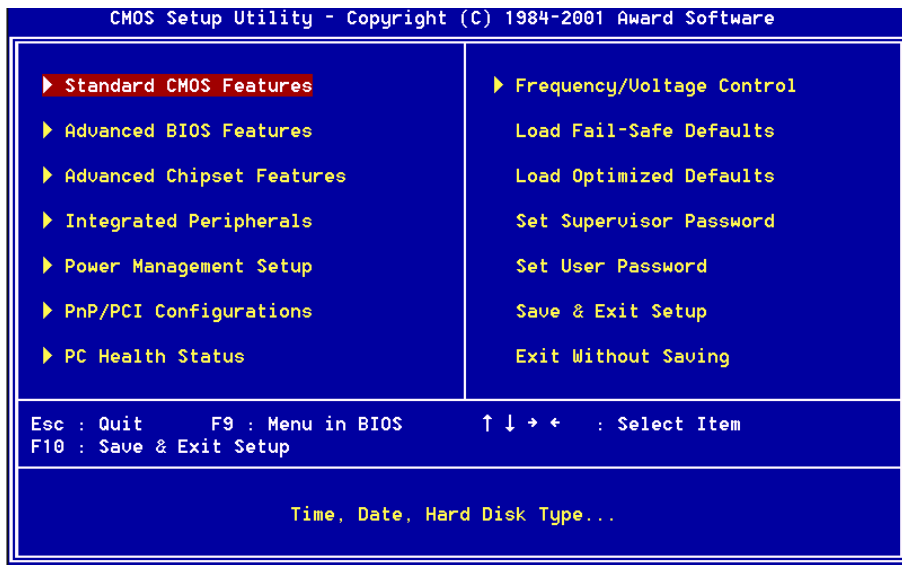

Figure 1: CMOS Setup Utility

# BIOS

The menu displays all the major selection items. Select the item you need to reconfigure. The selection is made by moving the cursor (press any direction key ) to the item and pressing the 'Enter' key. An on-line help message is displayed at the bottom of the screen as the cursor is moved to various items which provides a better understanding of each function. When a selection is made, the menu of the selected item will appear so that the user can modify associated configuration parameters.

## 4-1 Standard CMOS Setup

Choose "Standard CMOS Setup" in the CMOS SETUP UTILITY Menu (Figure 2). The Standard CMOS Setup allows the user to configure system settings such as the current date and time, type of hard disk drive installed, floppy drive type, and display type. Memory size is auto-detected by the BIOS and displayed for your reference. When a field is highlighted (use direction keys to move the cursor and the <Enter> key to select), the entries in the field can be changed by pressing the <PgDn> or the <PgUp> key.

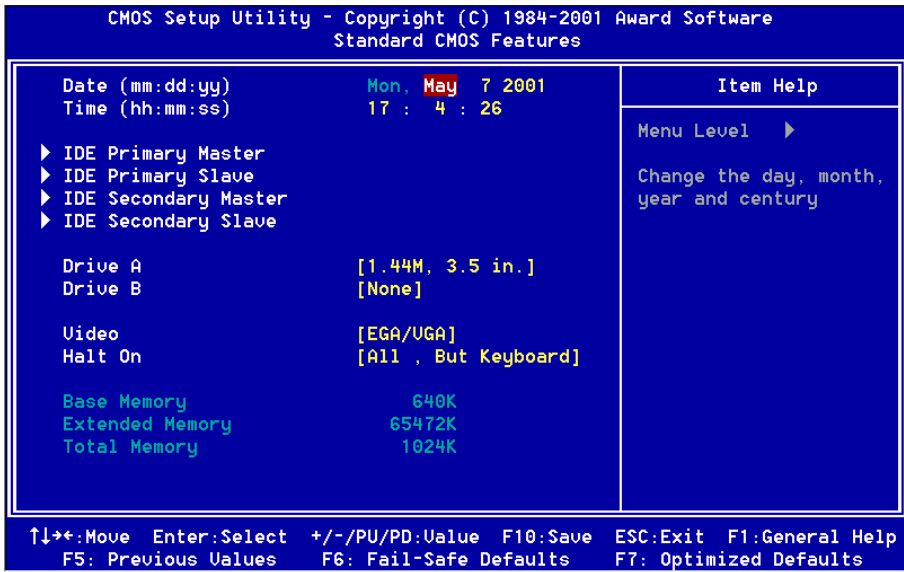

Figure 2: Standard CMOS Setup

*NOTE: If the hard disk Primary Master/Slave and Secondary Master/Slave are set to Auto, then the hard disk size and model will be auto-detected.*

*NOTE: The “Halt On:” field is used to determine when to halt the system by the BIOS if an error occurs.*

*NOTE: Floppy 3 Mode support is a mode used to support a special 3.5” drive used in Japan. This is a 3.5” disk that stores only 1.2 MB, the default setting for this is disabled.*

## 4-2 Advanced BIOS Features

Selecting the “BIOS FEATURES SETUP” option in the CMOS SETUP UTILITY menu allows users to change system related parameters in the displayed menu. This menu shows all of the manufacturer’s default values for the board.

Pressing the [F1] key will display a help message for the selected item.

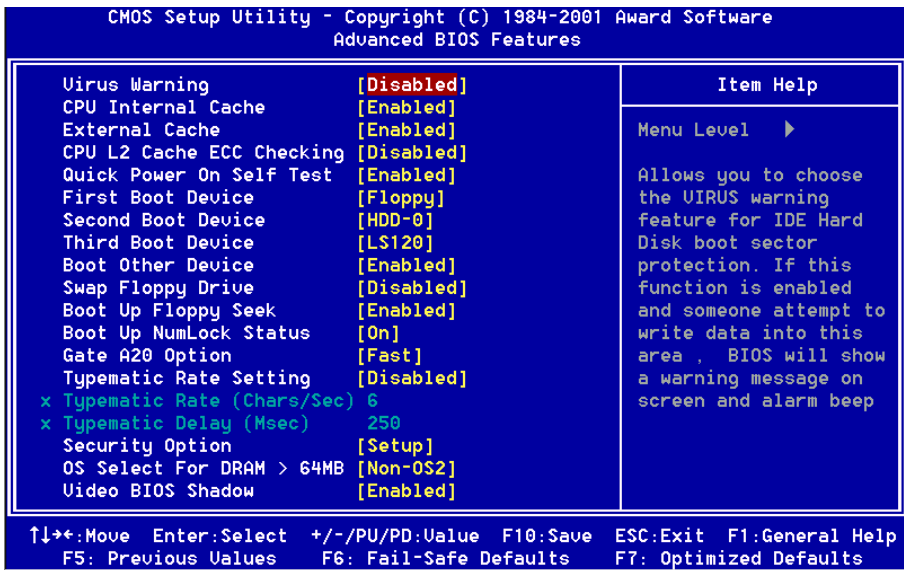

Figure 3: BIOS Features Setup



# BIOS

---

**Virus Warning:** During and after the system boots up, any attempt to write to the boot sector or partition table of the hard disk drive will halt the system and an error message will appear.

You should then run an anti-virus program to locate the virus. Keep in mind that this feature protects only the boot sector, not the entire hard drive.

The default value is Disabled.

**Enabled:** Activates automatically when the system boots up causing a warning message to appear when anything attempts to access the boot sector.

**Disabled:** No warning message will appear when anything attempts to access the boot sector.

*Note: Many disk diagnostic programs that access the boot sector table can trigger the virus warning message. If you plan to run such a program, we recommend that you first disable the virus warning.*

**CPU Internal Cache:** This controls the status of the processor's internal cache area. The default is Enabled.

**Enabled:** This activates the processor's internal cache thereby increasing performance.

**Disabled:** This deactivates the processor's internal cache thereby lowering performance.

**External (L2) Cache:** This controls the status of the external (L2) cache area. The default is Enabled.

**Enabled:** This activates the CPU's L2 cache thereby increasing performance.

**Disabled:** This deactivates the CPU's L2 cache thereby lowering performance.

**CPU L2 Cache ECC Checking:** This control if the CPU's L2 Cache will support Error Checking and Correcting (ECC). The default is Disabled.

**Enabled:** Enables ECC support for the CPU's L2 cache. Performance will decrease 2% ~ 4%.

**Disabled:** Disables ECC support for the CPU's L2 cache.

**Quick Power On Self Test:** This category speeds up the Power On Self Test (POST). The default is Enabled.

**Enabled:** This setting will shorten or skip of the items checked during POST.

**Disabled:** Normal POST.

**First /Second/Third/Other Boot Device:** The BIOS attempts to load the operating system from the devices in the sequence selected in these items.  
The choice: Floppy, LS120, HDD, SCSI, CDROM, Disabled.

**Swap Floppy Drive:** This will swap your physical drive letters A & B if you are using two floppy disks. The default is Disabled.

**Enabled:** Floppy A & B will be swapped under the O/S.

**Disabled:** Floppy A & B will be not swapped.

**Boot Up Floppy Seek:** During Power-On-Self-Test (POST), BIOS will determine if the floppy disk drive installed is 40 or 80 tracks. Only 360K type is 40 tracks while 760K, 1.2MB and 1.44MB are all 80 tracks. The default is Enabled.

**Enabled:** The BIOS will search the floppy disk drive to determine if it is 40 or 80 tracks.

**Disabled:** The BIOS will not search for the type of floppy disk drive by track number.

*Note: BIOS can not tell the difference between 720K, 1.2MB and 1.44MB drive types as they are all 80 tracks.*

**Boot Up NumLock Status:** This controls the state of the NumLock key when the system boots. The default is On.

**On:** The keypad acts as a 10-key pad.

**Off:** The keypad acts like the cursor keys.

**Gate A20 Option:** This refers to the way the system addresses memory above 1MB (extended memory). The default is Normal.

**Normal:** The A20 signal is controlled by the keyboard controller or chipset hardware.

**Fast:** The A20 signal is controlled by Port 92 or chipset specific method.

**Typematic Rate Setting:** This determines the keystrokes repeat rate. The default is Disabled.

**Enabled:** Allows typematic rate and typematic delay programming.

**Disabled:** The typematic rate and typematic delay will be controlled by the keyboard controller in your system.

# BIOS

---

**Typematic Rate (Chars/Sec):** This is the number of characters that will be repeated by a keyboard press. The default is 6.

**6:** 6 characters per second.

**8:** 8 characters per second.

**10:** 10 characters per second.

**12:** 12 characters per second.

**15:** 15 characters per second.

**20:** 20 characters per second.

**24:** 24 characters per second.

**30:** 30 characters per second.

**Typematic Delay (msec):** This setting controls the time between the first and the second character displayed by typematic auto-repeat. The default is 250.

**250:** 250 msec.

**500:** 500 msec.

**750:** 750 msec.

**1000:** 1000 msec.

**Security Option:** This category allows you to limit access to the System and Setup, or just to Setup. The default is Setup.

**System:** The system will not boot and the access to Setup will be denied if the correct password is not entered at the prompt.

**Setup:** The system will boot; but the access to Setup will be denied if the incorrect password is not entered at the prompt.

**OS Select For DRAM > 64MB:** Some operating systems require special handling. Use this option only if your system has greater than 64MB of memory. The default is Non-OS2.

**OS2:** Select this if you are running the OS/2 operating system with greater than 64MB of RAM.

**Non-OS2:** Select this for all other operating systems and configurations.

**Video BIOS Shadow:** This option allows video BIOS to be copied into RAM. Video Shadowing will increase the video performance of your system. The default is Enabled.

**Enabled:** Video shadow is enabled.

**Disabled:** Video shadow is disabled.

### 4-3 Advanced Chipset Features

Choose the “CHIPSET FEATURES SETUP” in the CMOS SETUP UTILITY menu to display following menu.

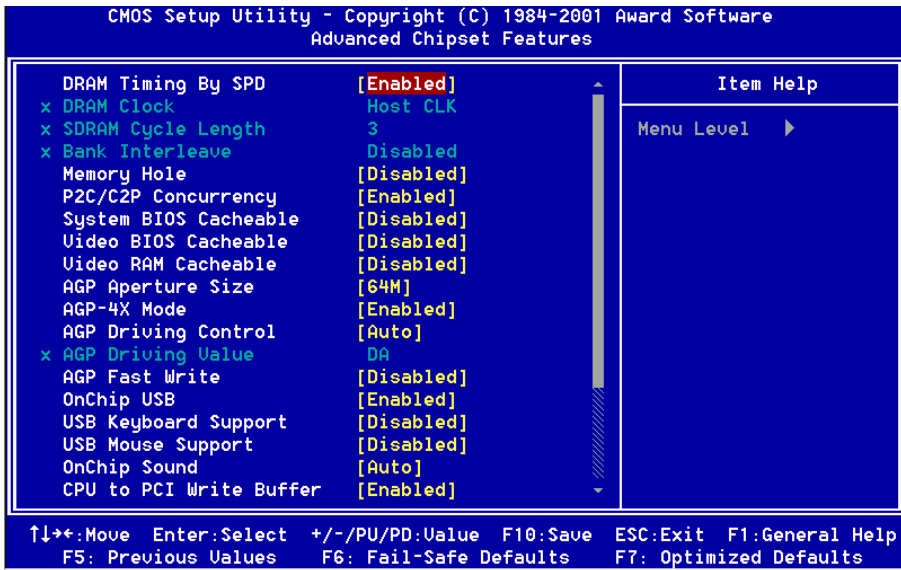

Figure 4: Chipset Features Setup

**DRAM Timing By SPD:** Select Enabled for setting SDRAM timing by SPD. The Choice: Enabled, Disabled.

**DRAM Clock :** The item will synchronize/asynchronize DRAM clock operation.

**Host CLK:** Sets the memory to run at the same speed with the processor’s front side bus. If you have CPU at 133MHz FSB & PC133 memory, please use this selection.

**HCLK+ 33M:** Sets the memory to run at 33MHz faster than the processor’s front side bus. We recommend to select this item while your CPU is running at 100MHz FSB and memory is PC133 specification to optimize your system performance.

**HCLK - 33M:** Sets the memory to run at 33MHz slower than the processor’s front side bus. This selection is suggested to be used under CPU at 133MHz FSB and PC100 memory configuration.

# BIOS

---

**SDRAM Cycle length:** This setting defines the CAS timing parameter of the SDRAM in terms of clocks. Default is by SPD.

- 2: Provides faster memory performance.
- 3: Provides better memory compatibility.

**Bank Interleave:** The item allows you to set how many banks of SDRAM support in your mainboard. Default is by SPD.

The Choice: 2 Bank, 4 Bank, Disabled.

**Memory Hole :** You can reserve this memory area for the use of ISA adaptor ROMs. The default is Disabled.

*Enabled:* This field enables the main memory (15~16MB) to remap to ISA BUS.

*Disabled:* Normal Setting.

*Note: If this feature is enabled you will not be able to cache this memory segment.*

**P2C/C2P Concurrency:** This item allows you to enable/disable the PCI to CPU, CPU to PCI concurrency.

**System BIOS Cacheable:** This allows you to copy your BIOS code from slow ROM to fast RAM. The default is Disabled.

**Enabled:** The option will improve system performance. However, if any program writes to this memory area, a system error may result.

**Disabled:** System BIOS non-cacheable.

**Video BIOS Cacheable:** This option copies the video ROM BIOS to fast RAM (C0000h to C7FFFh). The default is Enabled.

**Enabled:** Enables the Video BIOS Cacheable to speed up the VGA Performance.

**Disabled:** Will not use the Video BIOS Cacheable function.

**Video RAM Cacheable:** This option allows the CPU to cache read/writes of the video RAM. The default is Enabled.

**Enabled:** This option allows for faster video access.

**Disabled:** Reduced video performance.

**AGP Aperture Size:** The amount of system memory that the AGP card is allowed to share. The default is 64.

- 4:** 4MB of systems memory accessible by the AGP card.
- 8:** 8MB of systems memory accessible by the AGP card.
- 16:** 16MB of systems memory accessible by the AGP card.
- 32:** 32MB of systems memory accessible by the AGP card.
- 64:** 64MB of systems memory accessible by the AGP card.
- 128:** 128MB of systems memory accessible by the AGP card
- 256:** 256MB of systems memory accessible by the AGP card.

**AGP-4x Mode:** Chipset AGP Mode support.

Options: x1 , x2 and x4.

**AGP Driving Control:** This item allows you to adjust the AGP driving force. Choose Manual to key in a AGP Driving Value in the next selection. This field is recommended to set in Auto for avoiding any error in your system.

**AGP Fast Write:** Selecting Enabled allows to use Fast Write Protocol for 4X AGP.

**OnChip USB:** USB Connector.

The choice: Enabled, Disabled.

**USB Keyboard Support:** This controls the activation status of an optional USB keyboard that may be attached. The default is disabled.

**Enabled:** Enable USB keyboard support.

**Disabled:** Disable USB keyboard support.

**OnChip Sound:** Turn on/off onchip sound device.

**CPU to PCI Write Buffer:** When enabled, up to four D words of data can be written to the PCI bus without interrupting the CPU. When disabled, a write buffer is not used and the CPU read cycle will not be completed until the PCI bus signals that it is ready to receive the data.

The Choice: Enabled, Disabled.

**PCI Dynamic Bursting:** When Enabled, data transfers on the PCI bus, where possible, make use of the high-performance PCI bust protocol, in which graeater amounts of data are transferred at a single command.

The Choice: Enabled, Disabled.

# BIOS

---

**PCI Master 0 WS Write:** When Enabled, writes to the PCI bus are command with zero wait states.

The Choice: Enabled, Disabled.

**PCI Delay Transaction:** The chipset has an embedded 32-bit posted write buffer to support delay transactions cycles. Select Enabled to support compliance with PCI specification version 2.1.

The Choice: Enabled, Disabled.

**PCI #2 Access #1 Retry:** This item allows you enabled/disable the PCI #2 Access #1 Retry.

The Choice: Enabled, Disabled.

**AGP Master 1 WS Write:** When Enabled, writes to the AGP (Accelerated Graphics Port) are executed with one wait states.

The Choice: Enabled, Disabled.

**AGP Master 1 WS Read:** When Enabled, read to the AGP (Accelerated Graphics Port) are executed with one wait states.

The Choice: Enabled, Disabled.

**Memory Parity/ECC Check:** If the DRAM chip in your system support Parity/ECC check, select Enabled.

## 4-4 Integrated Peripherals

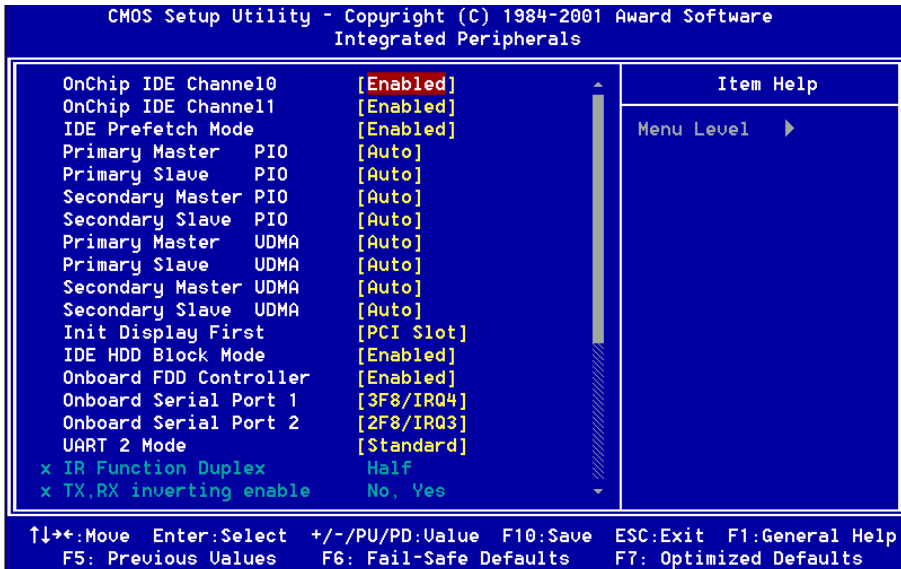

Figure 5: Integrated Peripherals

**Note:** If you do not use the Onboard IDE connector, then you will need to set Onboard Primary PCI IDE: Disabled and Onboard Secondary PCI IDE: Disabled

**Note:** The Onboard PCI IDE cable should be equal to or less than 18 inches (45 cm.).

**OnChip IDE Channel0/1:** The default value is Enabled.

**Enabled:** Enables Onboard IDE primary port.

**Disabled:** Disables Onboard IDE primary port.

**IDE Prefetch Mode:** Enable prefetching for IDE drive interfaces that support its faster drive accesses. If you are getting disk drive errors, change the setting to omit the drive interface where the errors occur. Depending on the configuration of your IDE subsystem, this field may not appear, and it does not appear when the Internal PCI/IDE field, above, is Disabled.

The Choice: Enabled, Disabled.



# BIOS

---

**Primary Master PIO:** The default is Auto.

**Auto:** BIOS will automatically detect the Onboard Primary Master PCI IDE HDD Accessing mode.

**Mode 0~4:** Manually set the IDE Programmed interrupt mode.

**Primary Slave PIO:** The default is Auto.

**Auto:** BIOS will automatically detect the Onboard Primary Slave PCI IDE HDD Accessing mode.

**Mode 0~4:** Manually set the IDE Programmed interrupt mode.

**Secondary Master PIO:** The default is Auto.

**Auto:** BIOS will automatically detect the Onboard Secondary Master PCI IDE HDD Accessing mode.

**Mode 0~4:** Manually set the IDE Programmed interrupt mode.

**Secondary Slave PIO:** The default is Auto.

**Auto:** BIOS will automatically detect the Onboard Secondary Slave PCI IDE HDD Accessing mode.

**Mode 0~4:** Manually set the IDE Programmed interrupt mode.

**Primary Master UDMA:** This allows you to select the mode of operation for the hard drive. The default is Auto.

**Auto:** The computer will select the optimal setting.

**Disabled:** The hard drive will run in normal mode.

**Primary Slave UDMA:** This allows you to select the mode of operation for the hard drive. The default is Auto.

**Auto:** The computer will select the optimal setting.

**Disabled:** The hard drive will run in normal mode.

**Secondary Master UDMA:** This allows you to select the mode of operation for the hard drive. The default is Auto.

**Auto:** The computer will select the optimal setting.

**Disabled:** The hard drive will run in normal mode.

**Secondary Slave UDMA:** This allows you to select the mode of operation for the hard drive. The default is Auto.

**Auto:** The computer will select the optimal setting.

**Disabled:** The hard drive will run in normal mode.

**Init Display First:** If two video cards are used (1 AGP and 1 PCI) this specifies which one will be the primary display adapter. The default is PCI Slot.

**PCI Slots:** PCI video card will be primary adapter.

**AGP:** AGP video card will be primary adapter.

**IDE HDD Block Mode:** IDE Block Mode allows the controller to access blocks of sectors rather than a single sector at a time. The default is Enabled.

**Enabled:** Enabled IDE HDD Block Mode. Provides higher HDD transfer rates.

**Disabled:** Disable IDE HDD Block Mode.

**Onboard FDD Controller:** This controls the state of the onboard floppy controller. The default value is Enabled.

**Enabled:** Enable the Onboard VIA686B's floppy drive interface controller.

**Disabled:** Disable the Onboard VIA686B's floppy drive interface controller.

**Onboard Serial Port 1:** This field allows the user to configure the 1st serial port.

**COM1:** Enable Onboard Serial port 1 and address is 3F8H/IRQ4.

**COM2:** Enable Onboard Serial port 1 and address is 2F8H/IRQ3.

**COM3:** Enable Onboard Serial port 1 and address is 3E8H/IRQ4.

**COM4:** Enable Onboard Serial port 1 and address is 2E8H/IRQ3.

**Disabled:** Disable Onboard VIA686B's Serial port 1.

**Onboard Serial Port 2:** This field allows the user to configure the 2nd serial port.

**COM1:** Enable Onboard Serial port 2 and address is 3F8H/IRQ4.

**COM2:** Enable Onboard Serial port 2 and address is 2F8H/IRQ3.

**COM3:** Enable Onboard Serial port 2 and address is 3E8H/IRQ4.

**COM4:** Enable Onboard Serial port 2 and address is 2E8H/IRQ3.

**Disabled:** Disable Onboard VIA686B's Serial port 2.

**UART 2 Mode:** This item allows you to determine which Infra Red (IR) function of onboard I/O chip.

The Choice: Standard, ASKIR, HPSIR.

**Onboard Parallel port:** This field allows the user to configure the LPT port.

The default is 378H / IRQ7.

---

# BIOS

---

**378H:** Enable Onboard LPT port and address is 378H and IRQ7.

**278H:** Enable Onboard LPT port and address is 278H and IRQ5.

**3BCH:** Enable Onboard LPT port and address is 3BCH and IRQ7.

**Disabled:** Disable Onboard VIA686B's LPT port.

**Onboard Parallel Port Mode:** This field allows the user to select the parallel port mode.

The default is Normal.

**Normal:** Standard mode. IBM PC/AT Compatible bidirectional parallel port.

**EPP:** Enhanced Parallel Port mode.

**ECP:** Extended Capabilities Port mode.

**EPP+ECP:** ECP Mode & EPP Mode.

**ECP Mode USE DMA:** This field allows the user to select DMA1 or DMA3 for the ECP mode. The default is DMA3.

**DMA1:** This field selects the routing of DMA1 for the ECP mode.

**DMA3:** This field selects the routing of DMA3 for the ECP mode.

**Parallel Port EPP Type:** This item allows you to determine the IR transfer mode of onboard I/O chip.

The Choice: EPP1.9, EPP1.7.

**Onboard Legacy Audio:** Legacy Audio enabled/disabled.

**Sound Blaster:** Sound Blaster compatible device enabled/disabled.

**SB I/O Base Address:** Sound Blaster I/O resource selection.

**SB IRQ Select:** Legacy audio device IRQ selection.

**SB DMA Select:** Sound Blaster DMA channel selection.

**MPU-401:** MPU-401 function enabled/disabled.

**MPU-401 I/O Address:** Built-in MPU-401 compatible MIDI I/O port selection:

*300-303H*

*310-313H*

*320-323H*

*330-333H (default)*

**Game Port (200-207H):** Built-in joystick port support disabled/enabled(default).

## 4-5 Power Management Setup

Choose the “POWER MANAGEMENT SETUP” in the CMOS SETUP UTILITY to display the following screen. This menu allows the user to modify the power management parameters and IRQ signals. In general, these parameters should not be changed unless it’s absolutely necessary.

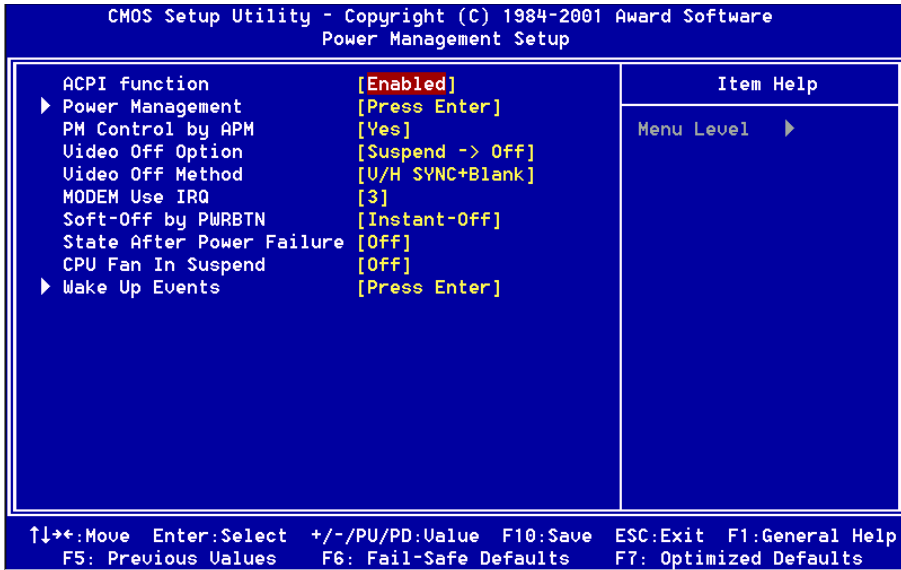

Figure 6: Power Management Setup

**ACPI Function:** This option allows you to select ACPI Function. The default is Enabled.

**Enabled:** Support ACPI function for new O.S

**Disabled:** No Support ACPI function.

You can only change the content of Doze Mode, Standby Mode, and Suspend Mode when the Power Management is set to ‘User Define’.

**Power Management:** Use this to select your Power Management selection. The default is User define.

**Disabled:** The system operates in NORMAL conditions (Non-GREEN), and the Power Management function is disabled.

**Max. saving:** Maximum power savings. Inactivity period is 1 minute in each mode.

# BIOS

---

**Min. saving:** Minimum power savings. Inactivity period is 1 hour in each mode.

**User define:** Allows user to define PM Timers parameters to control power saving mode.

**PM controlled by APM:** This option shows whether or not you want the Power Management to be controlled the Advanced Power Management (APM).

The default is Yes.

**Yes:** APM controls your PM

**No:** APM does not control your PM

**Video Off Option:** Tells you what time frame that the video will be disabled under current power management settings. The default is Standby.

**All Modes-> Off:** Video powers off after time shown in doze mode setting.

**Suspend->Off:** Video powers off after time shown in suspend mode setting.

**Always On:** Video power off not controlled by power management.

**Video Off Method:** This option allows you to select how the video will be disabled by the power management. The default is V/H Sync + Blank

**V/H Sync + Blank:** System turns off vertical and horizontal synchronization ports and writes blanks to the video buffer.

**DPMS:** Select this option if your monitor supports the Display Power Management Signaling (DPMS) standard of the Video Electronics Standards Association (VESA). Use the software supplied for your video subsystem to select video power management values.

**Blank Screen:** System only writes blanks to the video buffer.

**MODEM Use IRQ:** Name the interrupt request (IRQ) line assigned to the modem (if any) on your system. Activity of the selected IRQ always awakens the system.

Default is IRQ 3.

**N/A:** No IRQ is used.                   **3:** IRQ 3

**4:** IRQ 4                                   **5:** IRQ 5

**7:** IRQ 7                                   **9:** IRQ 9

**10:** IRQ 10                               **11:** IRQ 11

**Soft-Off by PWRBTN:** Use this to select your soft-off function.

The default is Instant Off.

---

**Instant Off:** Turns off the system instantly.

**Delay 4 Second :** Turns off the system after a 4 second delay. If momentary press of button, the system will go into Suspend Mode. Press the power button again to take system out of Suspend Mode.

**State After Power Failure:** This field lets you determine the state that your PC returns to after a power failure. If set to Off, the PC will not boot after a power failure, if set to On, the PC will restart after a power failure.

**CPU FAN In Suspend:** This option is used to set if the CPU fans will turn off during suspend mode. The default is Off.

On: The system will turn off the CPU fans during suspend mode.

Off: The system will not turn off the CPU fans during suspend mode.

**VGA:** When set to On (default), any event occurring at a VGA port will awaken a system which has been powered down.

**LPT & COM:** When set to *On* (default), any event occurring at a COM(serial)/LPT (printer) port will awaken a system which has been powered down.

**HDD & FDD:** When set to *On* (default), any event occurring at a hard or floppy drive port will awaken a system which has been powered down.

**PCI Master:** When set to *On* (default), any event occurring to the DMA controller will awaken a system which has been powered down.

**PowerOn by PS/2 Keyboard:** This item allows you to select wake-up the system by PS2 keyboard.

**PowerOn by PCI Card:** In input signal form PME on the PCI card awakens the system form a soft off state.

**PowerOn by LAN/Ring:** When set to *Enabled*, any event occurring to the LAN/Ring will awaken a system which has been powered down.

**RTC Alarm Resume:** When set to *Enable rtc alarm resume*, you could set the date (of month) and timer (hh:mm:ss), any event occurring at will awaken a system which has been powered down.

**Primary INTR:** When set to *On* (default), any event occurring at will awaken a system which has been powered down.

## 4-6 PNP/PCI Configuration

The PNP/PCI configuration program is for the user to modify the PCI/ISA IRQ signals when various PCI/ISA cards are inserted in the PCI or ISA slots.

**WARNING:** *Conflicting IRQ's may cause the system to not find certain devices.*

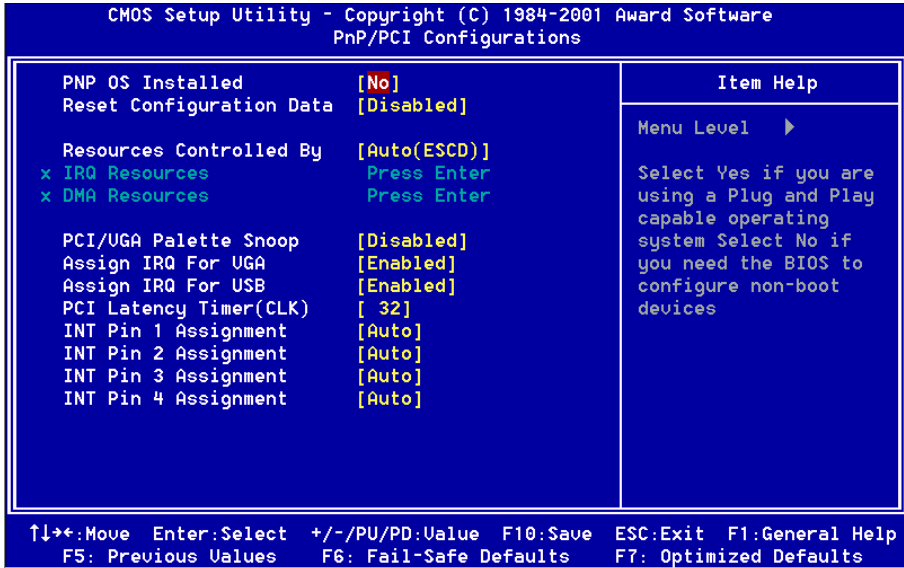

Figure 7: PCI Configuration Setup

**PNP OS Installed:** Do you have a PNP OS installed on your system. The default is No.

**Yes:** Select if you are using a PNP OS.

**No:** Select if your OS does not support PNP.

**Resources Controlled By:** Who controlled the system PNP/PCI resources. The default is Auto.

**Manual:** PNP Card's resources will be controlled manually. You can set which IRQ-X and DMA-X are assigned to PCI/ISA PNP or Legacy ISA Cards.

**Auto:** If your ISA card and PCI card are all PNP cards, BIOS will assign the interrupt resource automatically.

**Reset Configuration Data:** This setting allows you to clear ESCD data.

The default is Disabled

**Disabled:** Normal Setting.

**Enabled:** If you have plugged in some Legacy cards to the system and they were recorded into ESCD (Extended System Configuration Data), you can set this field to Enabled in order to clear ESCD.

**PCI/VGA Palette Snoop:** Leave this field at Disabled.

The choice: Enabled, Disabled.

**Assign IRQ For VGA/USB:** This item allows BIOS to assign whether IRQ is with VGA/USB or not. If you have not connect the VGA/USB device. Can release the IRQ for other device. The default is Enabled.

**Enabled:** Provides IRQ for VGA/USB device.

**Disabled:** Release IRQ for other device.

**PCI Latency Timer (CLK):** The latency timer defines the minimum amount of time, in PCI clock cycles, that the bus master can retain the ownership of the bus. The Choice: 0-255.

**INT Pin 1 to Pin 4 Assignment :** These settings allow the user to specify what IRQ will be assigned to PCI devices in the chosen slot. Options available: Auto,3, 4,5,7,9,10,11,12,14 & 15. The defaults are Auto.



# BIOS

## 4-7 PC Health Status

CMOS Setup Utility - Copyright (C) 1984-2001 Award Software		
PC Health Status		
Current CPU Temp.	31°C/87°F	Item Help
Current System Temp.	0°C/32°F	
Current CPU Fan Speed	6135 RPM	Menu Level ▶
Current Chassis Fan Speed	0 RPM	
Ucore	1.62V	
Vtt	1.52V	
3.3V	3.22V	
5V	5.01V	
12V	12.12V	

↑↓←→:Move Enter:Select +/-/PU/PD:Ualue F10:Save ESC:Exit F1:General Help  
F5: Previous Values F6: Fail-Safe Defaults F7: Optimized Defaults

**Current CPU Temperature:** This is the current temperature of the CPU.

**Current System Temperature:** This is the Current temperature of the system.

**Current CPU FAN Speed:** The current CPU fan speed in RPMs.

**Current Chassis FAN Speed:** The current chassis fan speed in RPMs.

**CPU(V):** The voltage level of the CPU(Vcore/Vtt).

**3.3V, 5V, 12V:** The voltage level of the switch power supply.

## 4-8 Frequency/Voltage Control

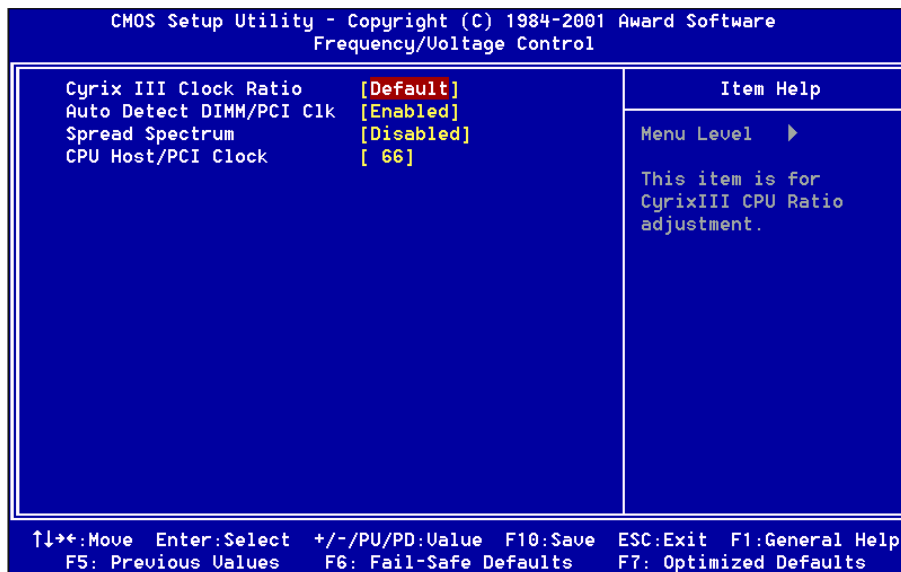

**Cyrix III Clock Ratio:** This item is for Cyrix III CPU ratio adjustment.

**Auto Detect DIMM/PCI Clk:** When enabled the motherboard will automatically disable the clock source for a DIMM socket which does not have a module in it. Same applies for PCI slots. The default is Enabled.

**CPU Host/PCI Clock :** The mainboard is designed to set the CPU Host/PCI clock via BIOS. This item allows you to select the CPU Host and PCI clock speed by “Enter” key. The CPU Host speed is auto detected.

**Note: Overclocking failure will cause system No display problem. At this moment, please press “Insert” key to back to the initial or default setting to boot up your system.**

# BIOS

---

## 4-9 Defaults Menu

---

Selecting “Defaults” from the main menu shows you two options which are described below

### **Load Fail-Safe Defaults**

When you press <Enter> on this item you get a confirmation dialog box with a message similar to:

Load Fail-Safe Defaults (Y/N) ? N

Pressing ‘Y’ loads the BIOS default values for the most stable, minimal-performance system operations.

### **Load Optimized Defaults**

When you press <Enter> on this item you get a confirmation dialog box with a message similar to:

Load Optimized Defaults (Y/N) ? N

Pressing ‘Y’ loads the default values that are factory settings for optimal performance system operations.

## 4-10 Supervisor/User Password Setting

---

You can set either supervisor or user password, or both of them. The differences between are:

**supervisor password** : can enter and change the options of the setup menus.

**user password** : just can only enter but do not have the right to change the options of the setup menus. When you select this function, the following message will appear at the center of the screen to assist you in creating a password.

### ENTER PASSWORD:

Type the password, up to eight characters in length, and press <Enter>. The password typed now will clear any previously entered password from CMOS memory. You will be asked to confirm the password. Type the password again and press <Enter>. You may also press <Esc> to abort the selection and not enter a password. To disable a password, just press <Enter> when you are prompted to enter the password. A message will confirm the password will be disabled. Once the password is disabled, the system will boot and you can enter Setup freely.

### PASSWORD DISABLED.

When a password has been enabled, you will be prompted to enter it every time you try to enter Setup. This prevents an unauthorized person from changing any part of your system configuration.

Additionally, when a password is enabled, you can also require the BIOS to request a password every time your system is rebooted. This would prevent unauthorized use of your computer.

You determine when the password is required within the BIOS Features Setup Menu and its Security option. If the Security option is set to "System", the password will be required both at boot and at entry to Setup. If set to "Setup", prompting only occurs when trying to enter Setup.

## BIOS

---

### 4-11 Exit Selecting

---

#### **Save & Exit Setup**

Pressing <Enter> on this item asks for confirmation:

**Save to CMOS and EXIT (Y/N)? Y**

Pressing “Y” stores the selections made in the menus in CMOS – a special section of memory that stays on after you turn your system off. The next time you boot your computer, the BIOS configures your system according to the Setup selections stored in CMOS. After saving the values the system is restarted again.

#### **Exit Without Saving**

Pressing <Enter> on this item asks for confirmation:

**Quit without saving (Y/N)? Y**

This allows you to exit Setup without storing in CMOS any change. The previous selections remain in effect. This exits the Setup utility and restarts your computer.

Easy Driver Installation



**Insert the bundled autorun driver CD-disk.**

- Step 1 :** Click **SERVICE PACK 4IN1 DRIVER**. Install all components recommended.
- Step 2 :** Click **AC'97 686A/B AUDIO DRIVER** to install Audio Sound Driver.
- Step 3 :** Click **BUS MASTER PCI IDE DRIVER** to install Bus Master PCI IDE.
- Step 4 :** Click **USB Driver** to install USB.



A-1 GHOST 5.1/6.03 Quick User's Guide

Installation is very easy. You only need to copy the **Ghost5** folder or **Ghost.exe** to your hard disk.

The current market version is for single **Client**, so the LPT and NetBios portions will not be explained further.

**Description of Menus**

**Ghost** clones and backs up **Disk** and **Partition**.

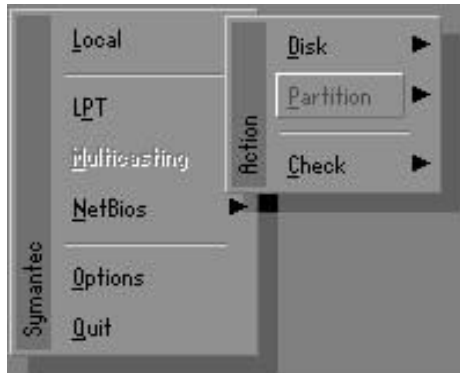

In which **Disk** indicates hard disk options  
**Partition** indicates partition options  
**Check** indicates check options

**Disk**

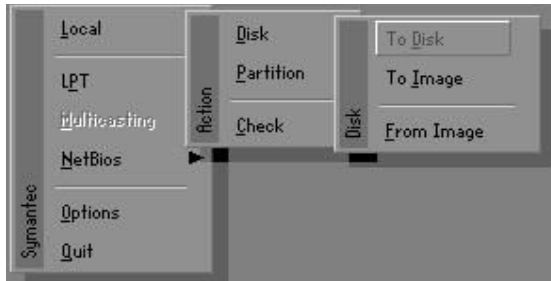



# Appendix

---

## There are 3 hard disk functions:

1. Disk To Disk (disk cloning)
2. Disk To Image (disk backup)
3. Disk From Image (restore backup)

## Important!

1. To use this function, the system must have at least 2 disks. Press the **Tab** key to move the cursor.
2. When restoring to a destination disk, all data in that disk will be completely destroyed.

## Disk To Disk (Disk Cloning)

1. Select the location of the **Source** drive.
2. Select the location of the **Destination** drive.

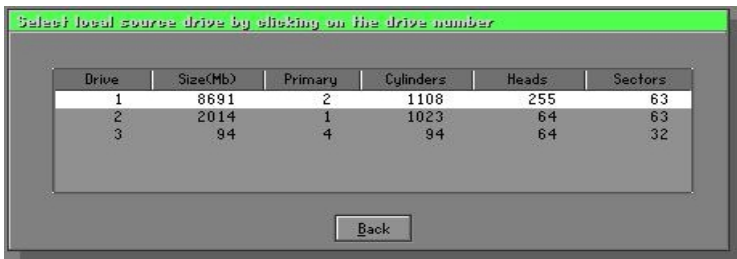

3. When cloning a disk or restoring the backup, set the required partition size as shown in the following figure.

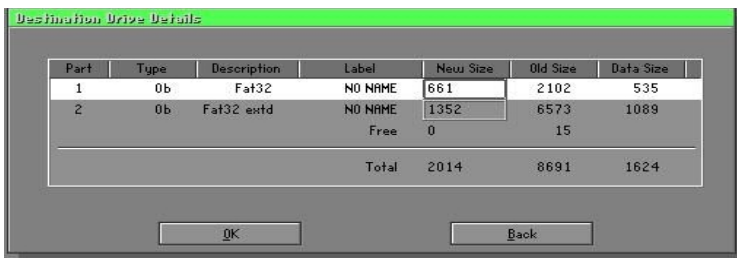

- Click OK to display the following confirmation screen. Select **Yes** to start.

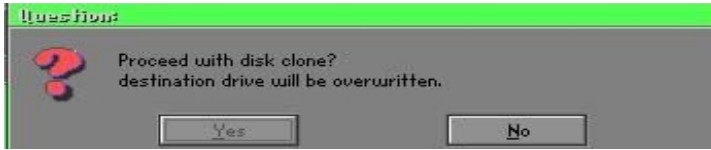

## Disk To Image (Disk Backup)

- Select the location of the Source drive.

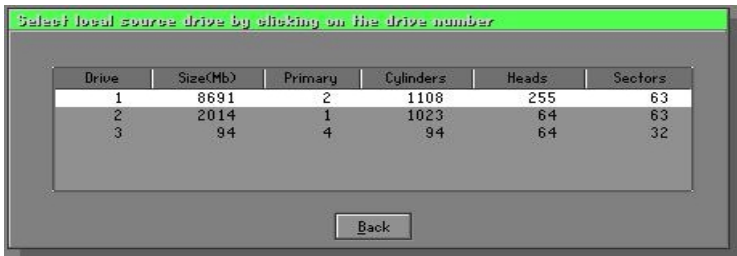

- Select the location for storing the backup file.

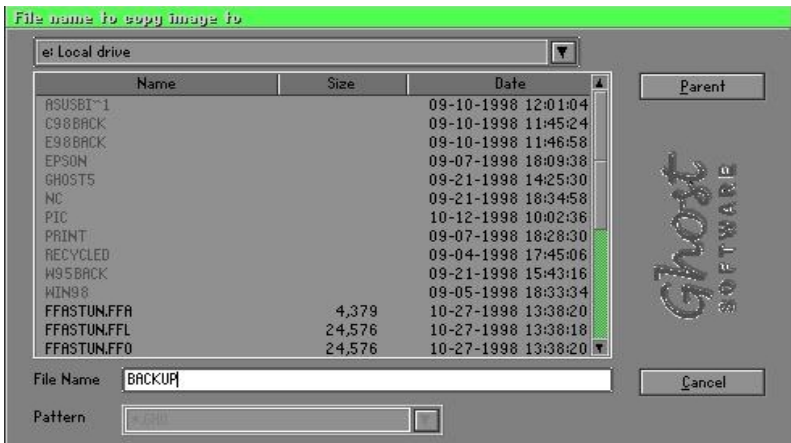

# Appendix

- Click **OK** to display the following confirmation screen. Select **Yes** to start.



## Disk From Image (Restore Backup)

- Select the Restore file.

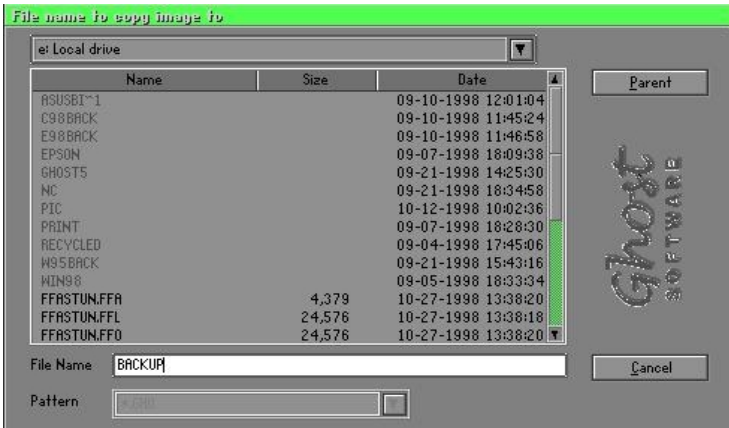

- Select the **Destination drive** of the disk to be restored.

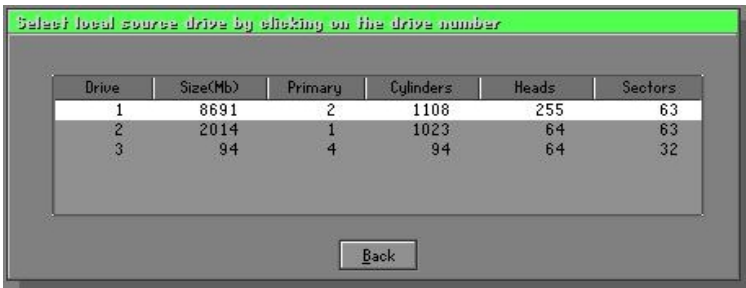

- When restoring disk backup, set the required partition size as shown in the following figure.



- Click **OK** to display the following confirmation screen. Select **Yes** to start.

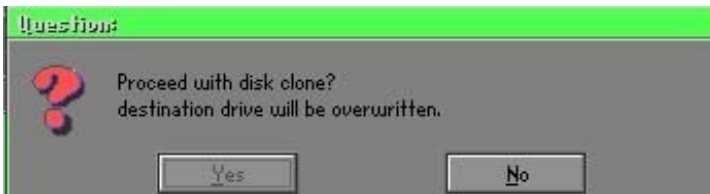

## Partition

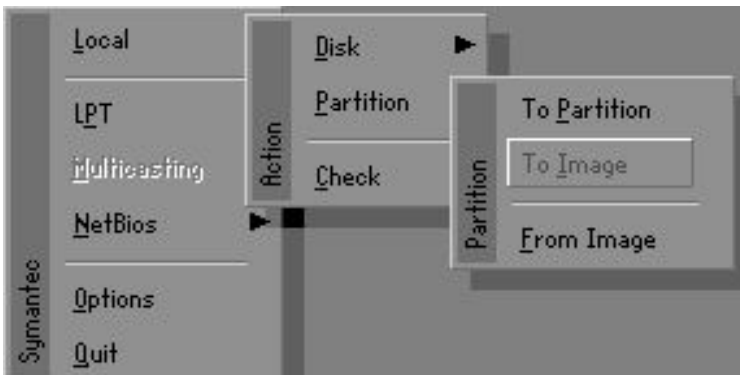

# Appendix

---

There are 3 partition functions:

1. **Partition To Partition** (partition cloning)
2. **Partition To Image** (partition backup)
3. **Partition From Image** (restore partition)

## Partition To Partition (Partition Cloning)

The basic unit for partition cloning is a partition. Refer to disk cloning for the operation method.

## Partition To Image (Partition Backup)

1. Select the disk to be backed up.

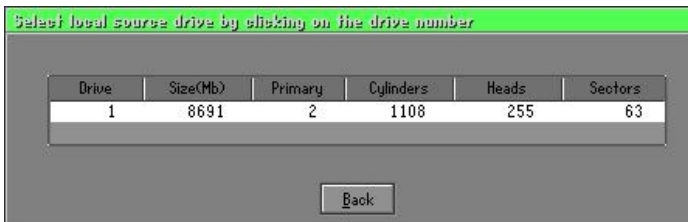

2. Select the first partition to be backed up. This is usually where the operating system and programs are stored.



3. Select the path and file name for storing the backup file.



4. Is the file compressed? There are 3 options:

(1) No: do not compress data during backup

(2) Fast: Small volume compression

(3) High: high ratio compression. File can be compressed to its minimum, but this requires longer execution time.

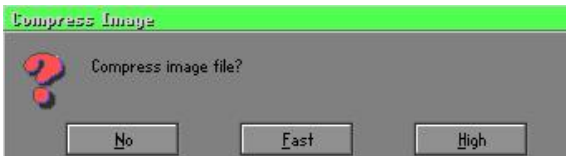

5. During confirmation, select Yes to start performing backup.



# Appendix

---

## Partition From Image (Restore Partition)

1. Select the backup file to be restored.

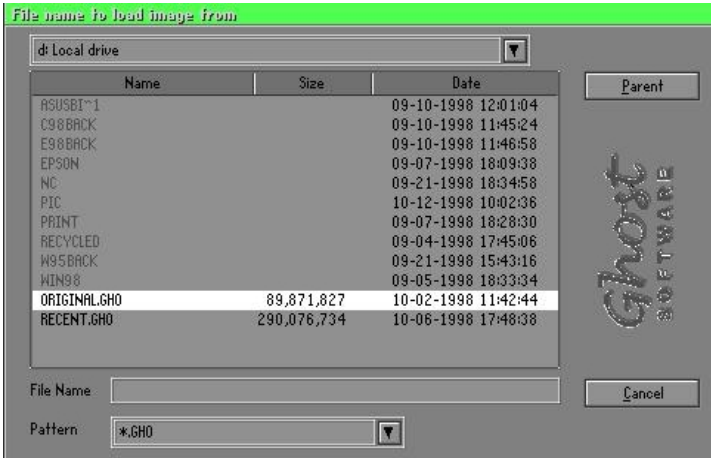

2. Select the source partition.



3. Select the disk to be restored.

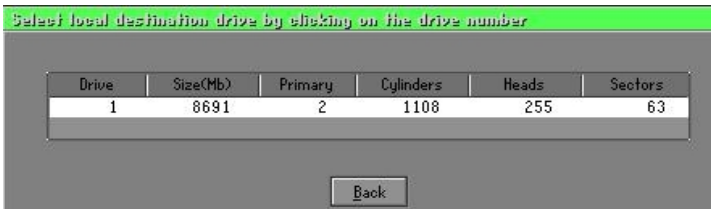

4. Select the partition to be restored.



5. Select Yes to start restoring.

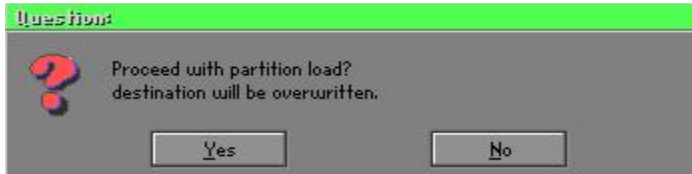

## Check

This function checks the hard disk or backup file for backup or restoration error due to FAT or track error.



### How to Reinstall Windows in 2 Minutes

**This chapter teaches you how to set your computer properly and, if necessary, reinstall Windows in 2 minutes. Ghost can use different methods to complete this task. The following two sections explain the creation of the emergency Recover Floppy and Recover CD:**

#### Emergency Recover Floppy

Divide a hard disk into two partitions. The first partition is for storing the operating system and application programs. The second partition is for backing up the operating system and data. The size of the partition can be set according to the backup requirements. For example, the **Windows** operating system needs 200MB of hard disk space, while the complete **Office** installation requires 360MB. The remaining space can be used to store other data.

After installing **Windows**, use **Ghost** to create a backup of the source system and store the file (Image file) in drive D. The file is named as **Original.gho**. Then, create a recover floppy disk containing:

- ◆ Bootable files (Command.com, Io.sys, and MSDOS.SYS )
- ◆ Config.sys (configuration setup file)
- ◆ Autoexec.bat (auto-execution batch file)
- ◆ Ghost.exe (Ghost execution file)

There are two ways to set the content of the recover floppy for restoration:

- (1) To load **Windows** automatically after booting, set the **Autoexec.bat** command as:

```
Ghost.exe clone, mode=pload, src=d:\original.gho:2,dst=1:1 -fx -sure -rb
```

Description: Runs the restore function automatically using the Image File. After execution, it exits Ghost and boots the system automatically.

Refer to the [Introducing Ghosts Functions].

- (2) After booting, the screen displays the Menu. Select Backup or Restore: Since the user may install other applications in the future, he/she may design **Autoexec.bat** as a Menu to back up or restore the user-defined Image file as follows:

### **Backup**

Back up Windows and application programs as a file (Recent.gho). Command is:

```
Ghost -clone,mode=pdump,src=1:1,dst=d:\Recent.gho -fx -sure -rb
```

### **Restore**

Restore types include [**General Windows**] and [**Windows and Application Programs**]. If you select [**General Windows**], the system is restored to the general **Windows** operation condition. The command is:

```
Ghost.exe -clone,mode=pload,src=d:\Original.gho,dst=1:1 -fx -sure -rb
```

If you select [**Windows and Application Programs**], the latest backup file (Recent.gho) is restored, skipping the installation and setup of application programs.

For description of relevant parameters, refer to [**Introducing Ghosts Functions**].

For more information about menu design, refer to Config.sys and Autoexec.bat under /Menu in the CD. You can also create a backup CD containing Ghost.exe and these two files.

### Recover CD

In recent years, well-known computer manufacturers (such as IBM, Acer, Compaq, etc.) bundle Recover CDs with their computers to reduce the cost resulting from servicing, while at the same time increasing their market competitiveness.

The following is a simple guide to how to create a recover CD:

1. For extremely easy creation of the recover floppy disk, use the copy program for example "Easy CD Creator " (Note 2). First, create a recover floppy disk containing:

Bootable files (Command.com and Io.sys and MSDOS.SYS)

Config.sys (Configuration setup file)

Autoexec.bat (Auto-execution batch file)

Mscdex.exe (CD-Rom execution file)

Ghost.exe (Ghost execution file)

Oakcdrom.sys (ATAPI CD-ROM compatible driver)

The content of Config.sys is:

```
DEVICE=Oakcdrom.sys /d:idecd001
```

The content of Autoexec.bat includes:

```
MSCDEX.EXE /D:IDECD001 /L:Z
```

```
Ghost.exe clone,mode=load,src=z:\original.gho,dst=1 -sure -rb
```

2. Write the backup image file (original.gho) of the entire hard disk or partition into the recover CD. Use the Recover CD to boot up the system and restore the backup files automatically.

For description of relevant parameters, refer to **[Introducing Ghosts Functions]**.

Note: For more details regarding the creation program and method for creating the recover CD, please refer to the legal software and relevant operation manual.

## Ghost Command Line Switches Reference

Ghost may be run in interactive or in batch mode. Batch mode is useful for automating installations for backups using Ghost. Most of the Ghost switches are used to assist with batch mode operation. To list switches from Ghost, type `ghost.exe -h`.

### **-clone**

The full syntax for this switch is:

```
clone,MODE={ copy|load|dump|pcopy|pload|pdump },SRC=
{ drive|file|drive:partition|,DST={ drive|file|drive:partition } ,SIZE{ F|L|n=
{ nnnnM|nnP|F|V } }
```

Clone using arguments. This is the most useful of the batch switches and has a series of arguments that define:

- a) **MODE** This defines the type of clone command to be used:
- |              |                             |
|--------------|-----------------------------|
| <b>COPY</b>  | disk to disk copy           |
| <b>LOAD</b>  | file to disk load           |
| <b>DUMP</b>  | disk to file dump           |
| <b>PCOPY</b> | partition to partition copy |
| <b>PLOAD</b> | file to partition load      |
| <b>PDUMP</b> | partition to file dump      |
- b) **SRC** This defines the source location for the operation:
- | <b>Mode</b>   | <b>Meaning:</b>                                                                                                                           |
|---------------|-------------------------------------------------------------------------------------------------------------------------------------------|
| <b>COPY/</b>  |                                                                                                                                           |
| <b>DUMP</b>   | Source drive (e.g, 1 for drive one)                                                                                                       |
| <b>LOAD</b>   | Disk image filename or device (e.g, g:\Images\system2.img)                                                                                |
| <b>PCOPY/</b> |                                                                                                                                           |
| <b>PDUMP</b>  | Source partition e.g, 1:2 indicates the second partition on drive one.                                                                    |
| <b>PLOAD</b>  | Partition image filename or device and partition number. Example: g:\images\disk1.img:2 indicates the second partition in the Image file. |

# Appendix

---

- c) **DST**            This defines the destination location for the operation:
- | <b>Mode</b>   | <b>Meaning</b>                                                                |
|---------------|-------------------------------------------------------------------------------|
| <b>COPY/</b>  |                                                                               |
| <b>LOAD</b>   | Destination drive (e.g, 2 for drive two)                                      |
| <b>DUMP</b>   | Disk image filename or device,(e.g, g:\images\system2.img)                    |
| <b>PCOPY/</b> |                                                                               |
| <b>PLOAD</b>  | Destination partition,(e.g, 2:2 indicates the second partition on drive two). |
| <b>PDUMP</b>  | Partition image filename (e.g, g:\images\part1.img).                          |
- c) **SIZEy**            Used to set the size of the destination partitions for either a disk load or disk copy operation.

## Available y Options:

- F**                    Resizes the first partition to maximum size allowed based on file system t type.
- L**                    Resizes the last partition to maximum size allowed based on file system type.
- n=xxxxM**        - indicates that the n<sup>th</sup> destination partition is to have a size of xxxx Mb. (e.g, **SIZE2=800M** indicates partition two is to have 800 mb.)
- n=mmP**            - indicates that the n<sup>th</sup> destination partition is to have a size of mm percent of the target disk.
- n=F**                - indicates that the n<sup>th</sup> destination partition is to remain fixed in size.
- n=V**                - Indicates that the partition will be resized according to the following rules:
- Rule 1** - If the destination disk is larger than the original source disk, then the partition(s) will be expanded to have the maximum amount of space subject to the free space available and the partition type (e.g, FAT16 partitions will have a maximum size of 2048Mb.)
- Rule 2** - If the destination disk is smaller than the original source disk, (but still large enough to accommodate the data from the source disk), the free space left over after the

data space has been satisfied will be distributed between the destination partitions in proportion to the data usage in the source partitions. Some examples follow that will help illustrate:

- fx flag Exit. Normally when Ghost has finished copying a new system to a disk, it prompts the user to reboot with a press Ctrl-Alt-Del to reboot window. However, if Ghost is being run as part of a batch file it is sometimes useful to have it just exist back to the DOS prompt after completion so that further batch commands may be processed. -fx enables this. See -rb for another option on completing a clone.
- ia Image All. The Image All switch forces Ghost to do a sector by sector copy of all partitions. When copying a partition from a disk to an image file or to another disk, Ghost examines the source partition and decides whether to copy just the files and directory structure, or to do an image (sector by sector) copy. If it understands the internal format of the partition it defaults to copying the files and directory structure. Generally this is the best option, but occasionally if a disk has been set up with special hidden security files that are in specific positions on the partition, the only way to reproduce them accurately on the target partition is via an image or sector-by-sector copy.
- span enables spanning across volumes.
- split=x splits image file into 'x' Mb? Mb spans. Use this to create a 'forced' size volume set. For example, if you would like to force smaller image files from a 1024 Megabyte drive, you could specify 200 megabyte segments. For example, ghost.exe -split=200 will divide the image into 200 Megabyte segments.
- sure use the -sure switch in conjunction with -clone to avoid being prompted with the final 'Proceed with disk clone destination drive will be overwritten?' question. This command is useful in batch mode.

## Appendix

---

### Example 1:

To copy drive one to drive two on a PC, without final prompt if OK to proceed.

```
ghost.exe -clone,mode=copy,src=1,dst=2 -sure
```

### Example 2:

To connect via NetBIOS to another PC running Ghost in slave mode, and dump a disk image of local drive two to the remote file c:\drive2.gho

```
ghost.exe -clone,mode=dump,src=2,dst=C:\drive2.gho -nbm
```

Note: The slave Ghost can be started with ghost -nbs

### Example 3:

To copy drive one, second partition on a PC to drive two, first partition the same PC, without final prompt

```
ghost.exe -clone,mode=pcopy,src=1:2,dst=2:1 -sure
```

### Example 4:

To dump the second partition of drive one to an image file on a mapped drive g:

```
ghost.exe -clone,mode=pdump,src=1:2,dst=g:\part2.gho
```

### Example 5:

To load partition 2 from a two-partition image file on a mapped drive g: onto the second partition of the local disk

```
ghost -clone,mode=pload,src=g:\part2.gho:2,dst=1:2
```

### Example 6:

To load drive 2 from an image file and resize the destination partitions into a 20:40 allocation

```
ghost.exe -clone,mode=load,src=g:\2prtdisk.gho,dst=2,size1=60P,  
size2=40P
```

## B-1 Update Your System BIOS

Download the xxxxx.EXE file corresponding to your model from our website to an empty directory on your hard disk or floppy. Run the downloaded xxxxx.EXE file and it will self extract. Copy these extracted files to a bootable DOS floppy disk.

Note: The DOS floppy disk should contain NO device drivers or other programs.

1. Type "A:\AWDFLASH and press <Enter> Key.
2. You will see the following setup on screen.
3. Please key in the xxxxx.bin BIOS file name.

```
FLASH MEMORY WRITER V7.88
(C)Award Software 2000 All Rights Reserved

For xxxx-W83627-6A69LPA9C-0  DATE: 05/11/2000
Flash Type -
File Name to Program : _____

Error Message:
```

4. If you want to save the previous BIOS data to the diskette, please key in [Y], otherwise please key in [N].

```
FLASH MEMORY WRITER V7.88
(C)Award Software 2000 All Rights Reserved

For xxxx-W83627-6A69LPA9C-0  DATE: 05/11/2000
Flash Type - xxxxx E82802AB /3.3V
File Name to Program : xxxxx.bin

Error Message: Do You Want To Save Bios (Y/N)
```



# Appendix

---

5. Key in File Name to save previous BIOS to file.

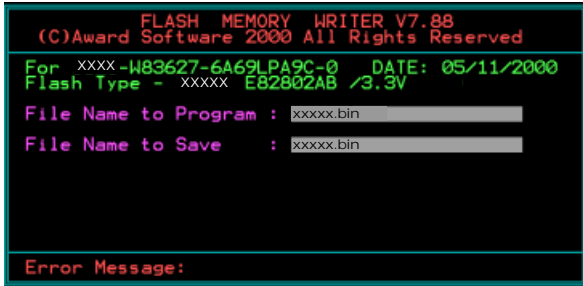

6. Are you sure to program (y/n), please key in [Y] to start the programming.

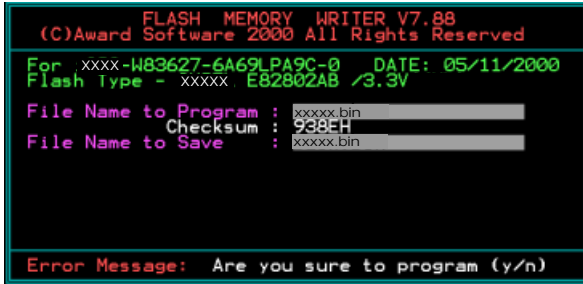

7. The programming is finished.

