



User's Manual

A Socket 370 Processor based
mainboard (133/100/66 MHz)

Supports PC133/VC133 Memory Modules

TRADEMARK

All products and company names are trademarks or registered
trademarks of their respective holders.

These specifications are subject to change without notice.

*Manual Revision 1.0
January 29, 2001*

Table of Contents

		<i>Page</i>
<i>Section 1</i>	<i>Introduction</i>	
	Components Checklist	1-1
	Form-Factor	1-2
	I/O Shield Connector	1-3
	Power-On/Off (Remote)	1-3
	System Block Diagram	1-4
<i>Section 2</i>	<i>Features</i>	
	Mainboard Features	2-1
<i>Section 3</i>	<i>Installation</i>	
	Mainboard Detailed Layout	3-2
	<i>Easy Installation Procedure</i>	
	CPU Insertion	3-3
	Jumper Settings	3-5
	System Memory Configuration	3-7
	Device Connectors	3-9
	Keyboard Power ON Function (KBPO)	3-12
<i>Section 4</i>	<i>Award BIOS Setup</i>	
	BIOS Instructions	4-1
	Standard CMOS Setup	4-2
	BIOS Features Setup	4-3
	Chipset Features Setup	4-8
	Power Management Setup	4-11
	PNP/PCI Configuration	4-14
	Integrated Peripherals	4-17
	Load Setup Defaults	4-21
	Sensor and CPU Speed Setup	4-22

Change Supervisor or User Password	4-23
IDE HDD Auto Detection	4-24
Save & Exit Setup	4-26
Exit Without Saving	4-26

Appendix

Appendix A

GHOST 5.1/6.03 Quick User's Guide	A-1
---	-----

Section 1
INTRODUCTION

Components Checklist

- ✓ A. (1) Mainboard
- ✓ B. (1) User's manual
- ✓ C. (1) Floppy ribbon cable
- ✓ D. (1) ATA-66/100 Hard drive ribbon cable
- E. (1) USB Cable (Optional)
- ✓ F. (1) Driver and utility

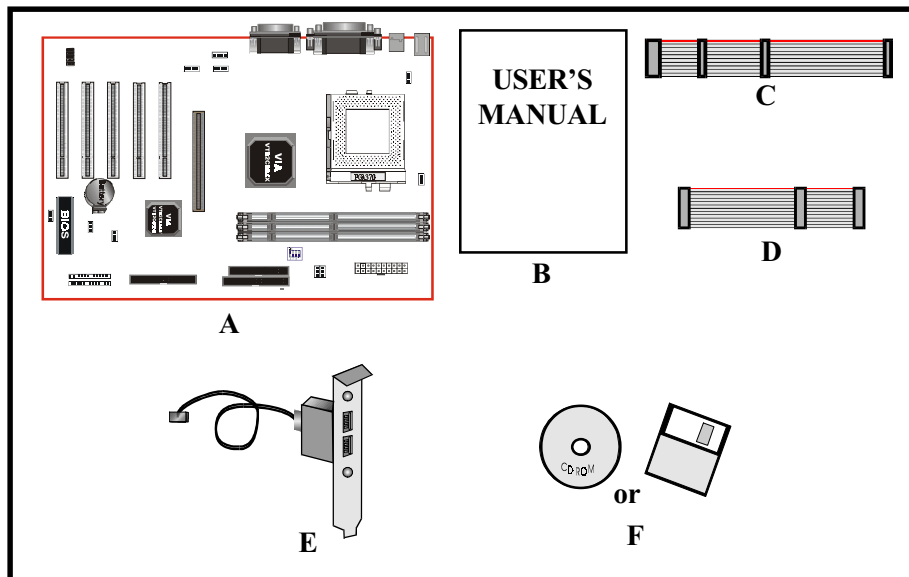

Introduction

Mainboard Form-Factor

The board is designed with ATX form factor - the new industry standard of chassis. ATX form factor is essentially a Baby-AT baseboard rotated 90 degrees within the chassis enclosure and a new mounting configuration for the power supply. With these changes the processor is relocated away from the expansion slots, allowing them all to hold full length add-in cards. ATX defines a double height aperture to the rear of the chassis which can be used to host a wide range of onboard I/O. Only the size and position of this aperture is defined, allowing PC manufacturers to add new I/O features (e.g.; TV input, TV output, joystick, modem, LAN, etc.) to systems. This will help systems integrators differentiate their products in the marketplace, and better meet your needs.

- Smaller size promotes a smaller system size.
- I/O shield does not need to be retooled in an ATX 2.01 or later. The mainboard should be used in an ATX 2.01 (or later) compliant case.
- A smaller power supply can be used. High integration on mainboard reduces the system costs.

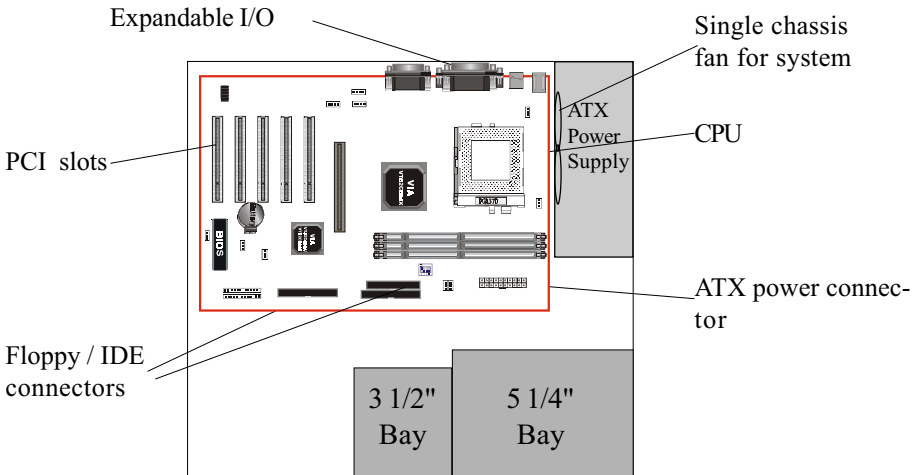

Figure 2: Summary of ATX chassis features

I/O Shield Connector

The board is equipped with an I/O back panel. Please use the appropriate I/O shield (figure 3).

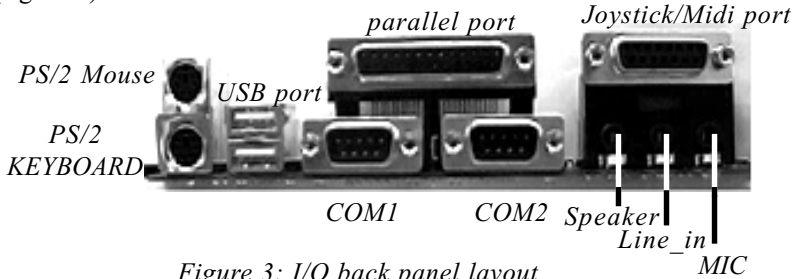

Figure 3: I/O back panel layout

Power-On/Off (Remote)

The board has a single 20-pin connector for ATX power supplies. For ATX power supplies that support the **Remote On/Off** feature, this should be connected to the systems front panel for system Power On/Off button. The systems power On/Off button should be a momentary button that is normally open.

The board has been designed with “Soft Off” functions. You can turn Off the system from one of two sources: The first is the front panel Power On/Off button, and the other is the "Soft Off" function (coming from the M/B's onboard circuit controller) that can be controlled by the operating system such as Windows® 95/98/SE/ME or Windows® 2000.

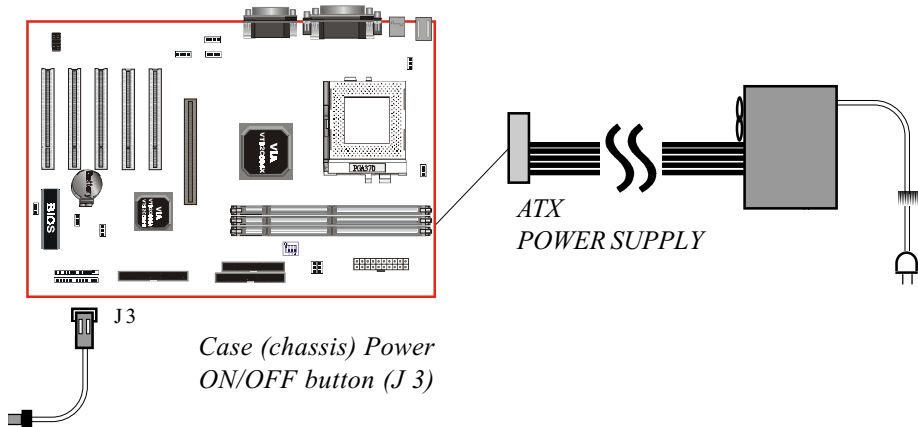

Figure 4: Simple ATX Power ON/OFF Controller

Introduction

System Block Diagram

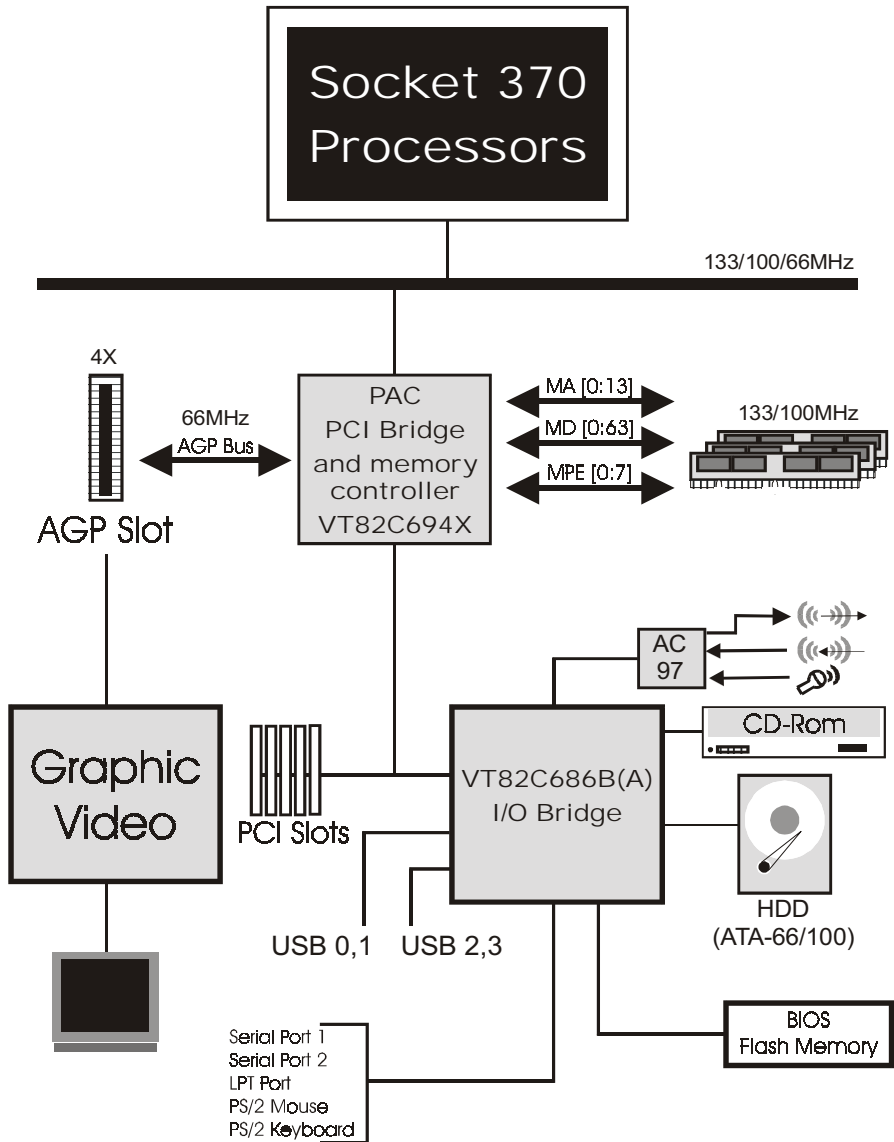

Figure 5: System Block Diagram

Mainboard Features:

◆ PROCESSOR

- Intel Celeron™ Processors with PPGA / FC-PGA socket 370 packing, operating at 433 ~ 766MHz
- Intel Pentium® III /Coppermine™ Processor with FC-PGA socket 370 packing, operating at 500 ~ 933MHz
- VIA Cyrix III Processor with PPGA socket370 packing, operating at 500 ~ 600MHz

◆ CHIPSET

- VIA Apollo Pro133A AGPset (694X + 686A or 694X + 686B)

◆ DRAM MODULE

- 168pin DIMM x 3 for PC133/VC133 Memory
- DRAM Size: 32MB to 768MB

◆ EXPANSION SLOT

- PCI x 5
- 4XAGP x 1

◆ ONBOARD I/O

- On-Chip Multi I/O integrated with K/B, mouse, FDD, Parallel and Serial, Fast IR and Power-ON controllers

◆ ONBOARD PCI / IDE

- PCI Bus IDE Port with PIO / Ultra DMA-66/100 x 2 (Up to 4 Devices), if uses VT82C686A chipset, it supports Ultra DMA-66 only.

Features

◆ I/O CONNECTOR

- PS/2 Mouse and PS/2 style Keyboard

◆ USB

- USB connector x 4 (2 for Opt.)

◆ BIOS

- Award Plug & Play BIOS

◆ Built-in AC97 Digital Audio

- Dual full-duplex Direct Sound channels
- H/W Sound Blaster Pro for DOS legacy compatibility
- FM synthesis for legacy compatibility
- Supports game and MIDI port

◆ EXTENDED FUNCTION

- Supports exclusive USDM(Unified System Diagnostic Manager) and Hardware Monitoring Function by VT82C686A or VT82C686B
- Supports exclusive KBPO (KeyBoard Power On)
- Supports CPU Clock setting via Jumper & BIOS
- Supports Wake-On-LAN Function

◆ FORM FACTOR

- 305mm x 190mm ATX Size

Section 3
INSTALLATION

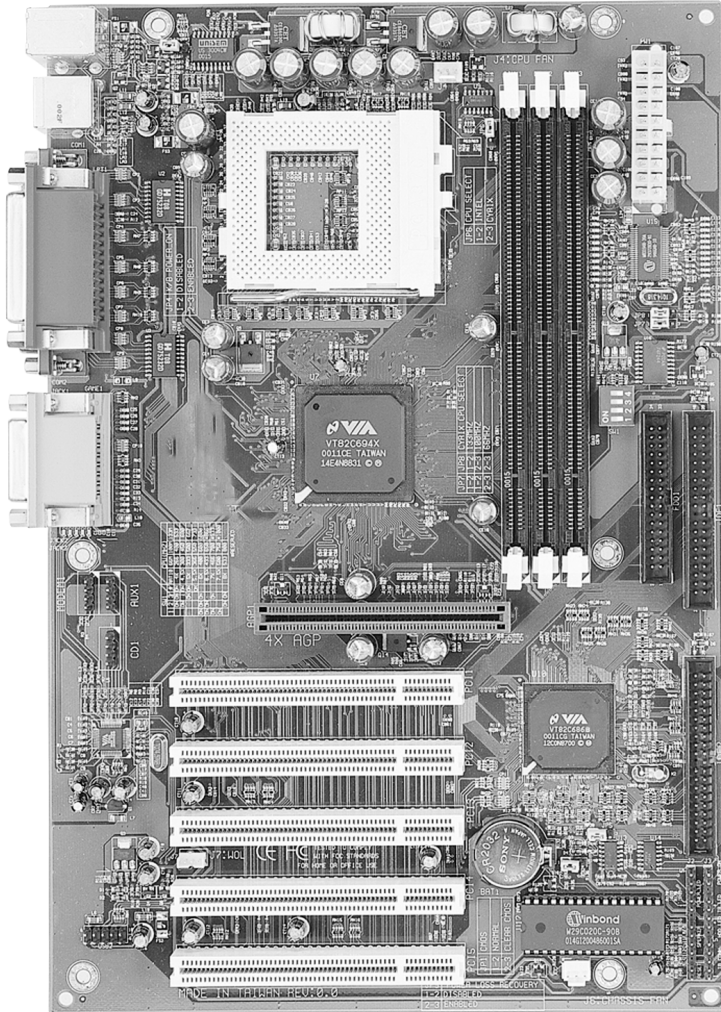

Mainboard Detailed Layout

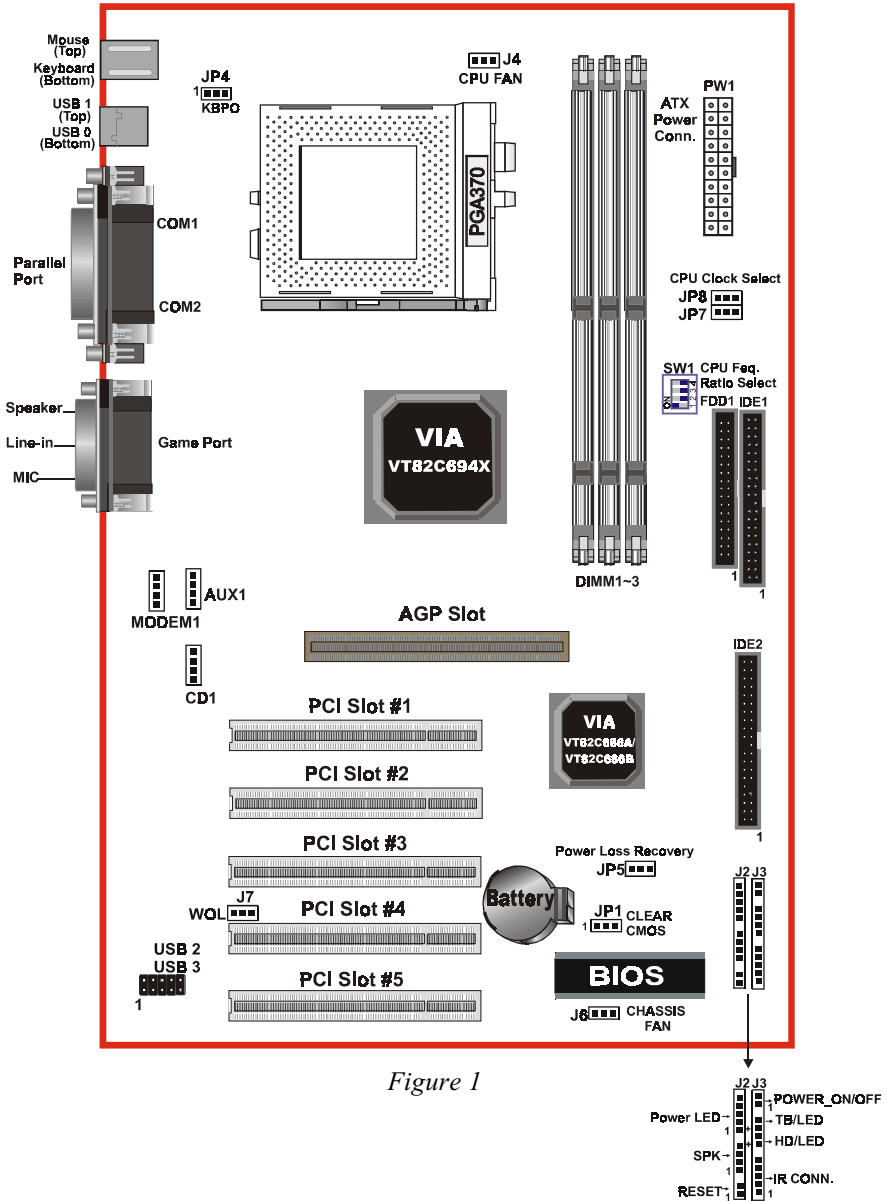

Easy Installation Procedure

The following must be completed before powering on your new system:

- 3-1. CPU Insertion**
- 3-2. Jumper Settings**
- 3-3. System memory Configuration**
- 3-4. Device Connectors**
- 3-5. External Modem Ring-in Power ON and Keyboard Power ON Functions (KBPO)**

Section 3-1 CPU Insertion

CPU Insertion

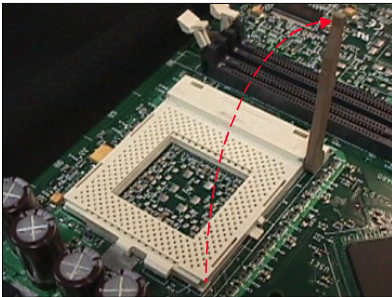

Figure 2

Step 1

Open the socket by raising the actuation lever.

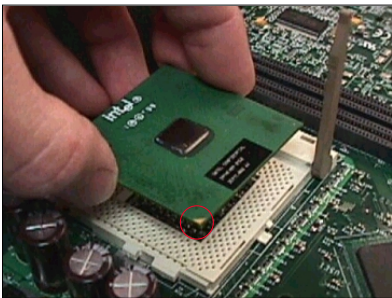

Figure 3

Step 2

Insert the processor.

Ensure proper pin 1 orientation by aligning the FC-PGA corner marking with the socket corner closest to the actuation arm tip. The pin field is keyed to prevent mis-oriented insertion.

Don't force processor into socket. If it does not go in easily, check for mis-orientation and debris. Make sure the processor is fully inserted into the socket on all sides.

Installation



Figure 4

Step 3

Close the socket by lowering and locking the actuation lever.

Note: Intel's reference design thermal solution is an active heatsink; an extruded aluminum heatsink based and a fan attached to the top on the fin array. (See Figure 5)

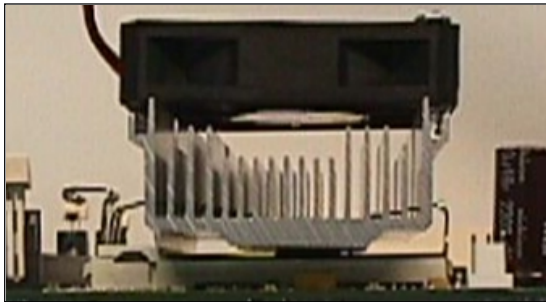
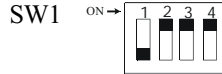
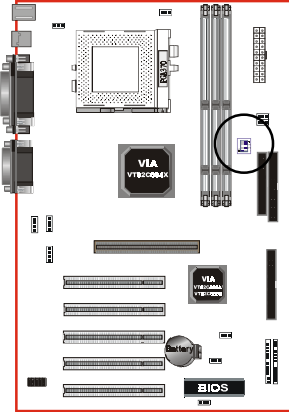

Figure 5

Section 3-2 Jumper Settings



CPU Multiple Frequency Selection

SW1				CPU(MHz)			
1	2	3	4	Ratio	66MHz	100MHz	133MHz
	ON	ON	ON	4X	266	400	533
	ON		ON	4.5X	300	450	600
		ON	ON	5X	333	500	667
			ON	5.5X	366	550	733
ON	ON	ON		6X	400	600	800
ON	ON			6.5X	433	650	866
ON		ON		7X	466	700	933
ON				7.5X	500	750	*1000
	ON	ON		8X	533	800	

*reserved

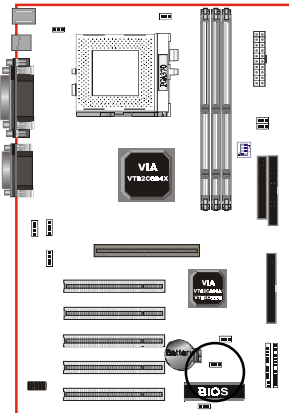

CMOS Clear

JP1 =1-2 Normal (Default)

=2-3 Clear CMOS

Installation

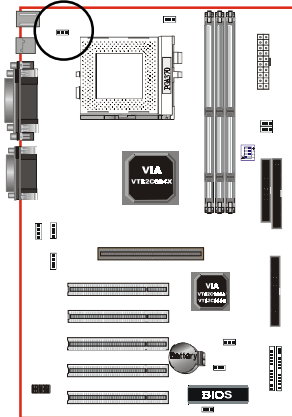

JP4



Keyboard Power-ON Function

JP4 =1-2 Disabled (Default)

=2-3 Enabled

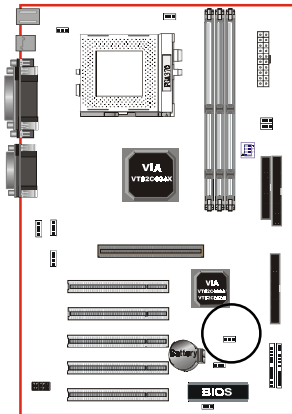

JP5



Power Loss Recovery

JP5 =1-2 Disabled (Default)

=2-3 Enabled

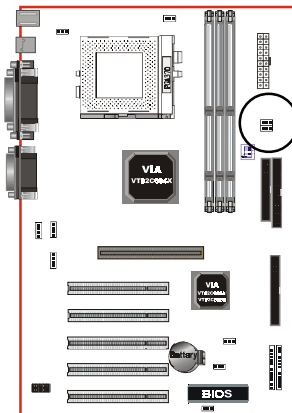

JP8

JP7



CPU Host Clock Select

JP7	JP8	CPU Clock Select	(Default)
1-2	1-2	AUTO	
2-3	2-3	66MHz	
None	2-3	100MHz	
None	None	133MHz	

Section 3-3 System Memory Configuration

Memory Layout

The board supports (3) PC133/VC133 168-pin DIMMs (Dual In-line Memory Module). The DIMMs is for SDRAM (Synchronous DRAM) .

- DIMM SDRAM may be 83MHz (12ns), 100MHz (10ns), 125MHz (8ns) or 133MHz (7.5ns)bus speed.
- If you use both 50ns and 60ns memory you must configure your BIOS to read 60ns.
- When using Synchronous DRAM we recommend using the 4 clock variety over the 2 clock.

Figure 6 and Table 1 show several possible memory configuration.

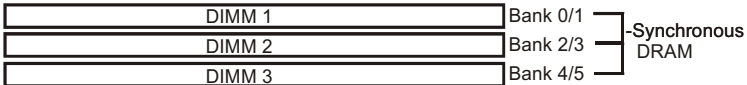

Figure 6

Total Memory	DIMM 1 (Bank 0/1)	DIMM 2 (Bank 2/3)	DIMM 3 (Bank 4/5)
= 256MB Maximum	SDRAM* 32MB, 64MB, 128MB, 256MB X 1	None	None
= 512MB Maximum	SDRAM* 32MB, 64MB, 128MB, 256MB X 1	SDRAM* 32MB, 64MB, 128MB, 256MB X 1	None
= 768MB Maximum	SDRAM* 32MB, 64MB, 128MB, 256MB X 1	SDRAM* 32MB, 64MB, 128MB, 256MB X 1	SDRAM* 32MB, 64MB, 128MB, 256MB X 1

Table 1

- * SDRAM supports 32, 64, 128, 256MB DIMM modules.
- * We recommend to use PC100/VC100 Memory Module for bus speed between 66MHz and 100MHz and PC133/VC133 Memory for bus speed over 100MHz.
- * Using non-compliant memory with higher bus speed (over clocking) may severely compromise the integrity of the system.

Installation

DIMM Module Installation

Figure 7 displays the notch marks and what they should look like on your DIMM memory module.

DIMMs have 168-pins and two notches that will match with the onboard DIMM socket. DIMM modules are installed by placing the chip firmly into the socket at a 90 degree angle and pressing straight down (figure 8) until it fits tightly into the DIMM socket (figure 9).

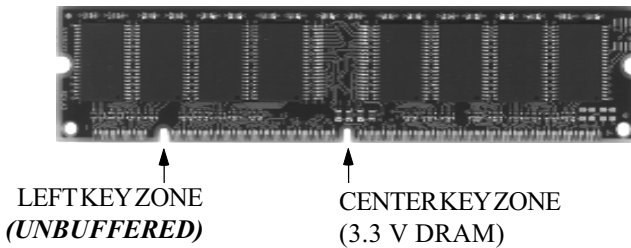

Figure 7

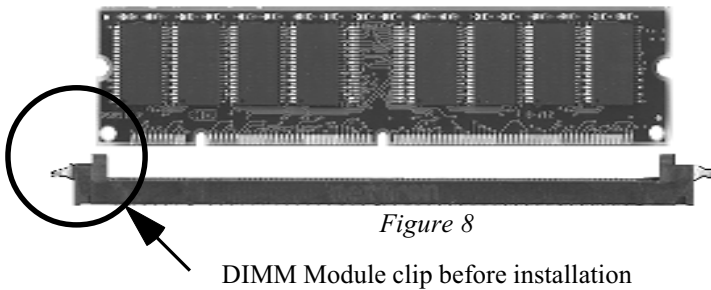

Figure 8

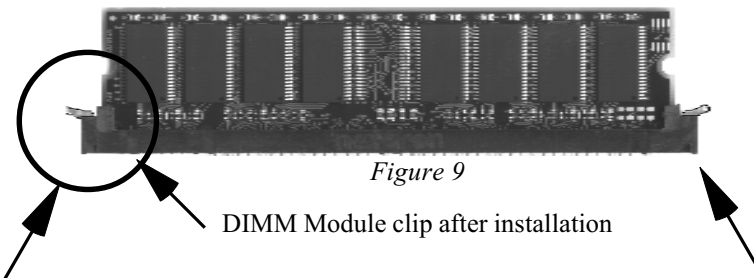
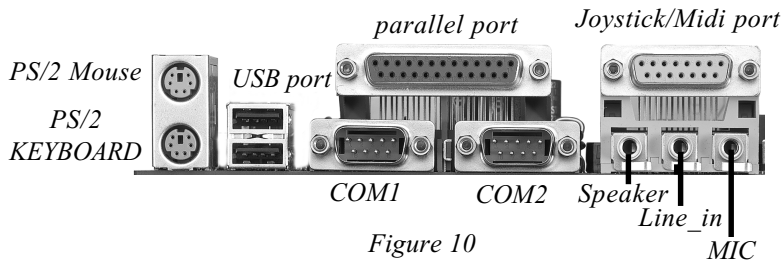

Figure 9

To remove the DIMM module simply press down both of the white clips on either side and the module will be released from the socket.

Section 3-4 Device Connectors



J2,J3: Chassis Panel Connector

- Power_LED, Speaker, Reset, Power On/Off, Turbo LED, HDD LED, IR Conn.

J4: CPU Fan

- A plug-in for the CPU Fan Power

J6: Chassis Fan

- A plug-in for the chassis Fan Power

J7: WOL (Wake On Lan) Connector

IDE1: Ultra ATA-66/100 Primary IDE Connector (Blue color)

(uses VT82C686A chipset, support ATA-66 only, White color)

IDE2: Ultra ATA-66/100 Secondary IDE Connector (Blue color)

(uses VT82C686A chipset, support ATA-66 only, Black color)

FDD1: Floppy Controller Connector (Black color)

PW1: ATX Power Connector

- 20-pin power connector

CD1: CD Audio_IN Connector

- Pin1(CD_IN_Left), Pin2/Pin3(CD_Reference), Pin4(CD_IN_Right)

AUX1: Auxiliary Line_IN Connector

- Pin1(Left Line_IN), Pin2/Pin3(GND), Pin4(Right Line-IN)

Installation

MODEM1: Telephony Connector for Modem audio output

- Pin1(Audio_in), Pin2/Pin3(GND), Pin4(Mic-out to Modem)

USB2: USB port header pins for adding two additional USB ports.

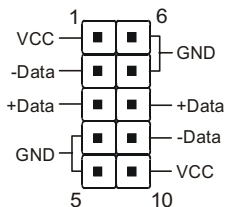

USB port header pin descriptions.

PIN#	Wire color	Signal Name	Comment
1	Red	Vcc	Cable Power
2	White	-Data	Data
3	Green	+Data	Data
4	Black	Ground	Cable Ground
5	Black	Ground	Case Ground
6	Black	Ground	Case Ground
7	Black	Ground	Cable Ground
8	Green	+Data	Data
9	White	-Data	Data
10	Red	Vcc	Cable Power

Device Connectors (continued)

(This is connected to the power button on the case. Using the Soft-Off by Pwr-BTTN feature, you can choose either Instant Off (turns system off immediately), or 4 sec delay (you need to push the button down for 4 seconds before the system turns off). When the system is in 4 sec delay mode, suspend mode is enabled by pushing the button momentarily.)

J3

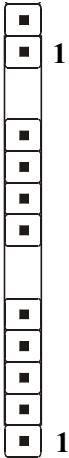

Power On/Off

Turbo LED indicator - LED ON when higher speed is selected

IDE LED indicator - LED ON when Onboard PCI IDE Hard disks is activate

IR Connector

- | | |
|---------|---------|
| 1. VCC | 4. GND |
| 2. NC | 5. IRTX |
| 3. IRRX | |

J2

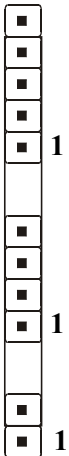

Power LED - Power LED connector

- | | |
|-----------------|--------|
| 1. Power LED(+) | 4. NC |
| 2. N/C | 5. GND |
| 3. GND | |

Speaker - Connect to the system's speaker for beeping

- | | |
|------------|--------|
| 1. Speaker | 3. GND |
| 2. N/C | 4. GND |

Reset - Closed to restart system.

Installation

Section 3-5 External Modem Ring-in Power ON and Keyboard Power ON Functions (KBPO)

On the basis of bounded functions in I/O chipset, the two serial ports are able to support the External Modem Ring-in Power ON function. Once users connect the external modem to COM1 or COM2, the mainboard allows users to turn on their system through the remote and host's dial-up control.

Exclusive Keyboard Power ON Function

To innovate a unique feature to benefit users, we devoted the easiest and most convenient way to turn on your system based on the the ATX power supply.

How to work with it

Step 1: Please check JP4 at the position 2-3 after you finished the system installation.

JP4



Keyboard Power-ON Function

JP4 = 1-2 Disabled (Default)

= 2-3 Enabled

Step 2: You can enjoy the Keyboard Power ON function (KBPO) by *pressing any key and BUTTON only to turn on your system*. Your system will be turned on automatically, after releasing the keys. To power off you system, you can use the Soft-OFF function under Windows® 95/98/SE/ME or Windows® 2000.

Notes: Intel ATX version 2.0 specification has recommended you use the power supply with 0.72A(720mA) in 5.0VSB. With our mainboard, *the 5.0VSB standby power only has to be > = 0.2A (200mA)* then you can enjoy this unique benefit. However, the ATX power supply which is < 0.2 (200mA) is still applicable to your system by placed JP4 at the position 1-2 to disable this feature.

Section 4

AWARD BIOS SETUP

BIOS Instructions

Award's ROM BIOS provides a built-in Setup program which allows user to modify the basic system configuration and hardware parameters. The modified data will be stored in a battery-backed CMOS, so that data will be retained even when the power is turned off. In general, the information saved in the CMOS RAM will stay unchanged unless there is a configuration change in the system, such as hard drive replacement or a device is added.

It is possible for the CMOS battery to fail, this will cause data loss in the CMOS only. If this does happen you will need to reconfigure your BIOS settings.

To enter the Setup Program :

Power on the computer and press the key immediately, this will bring you into the BIOS CMOS SETUP UTILITY.

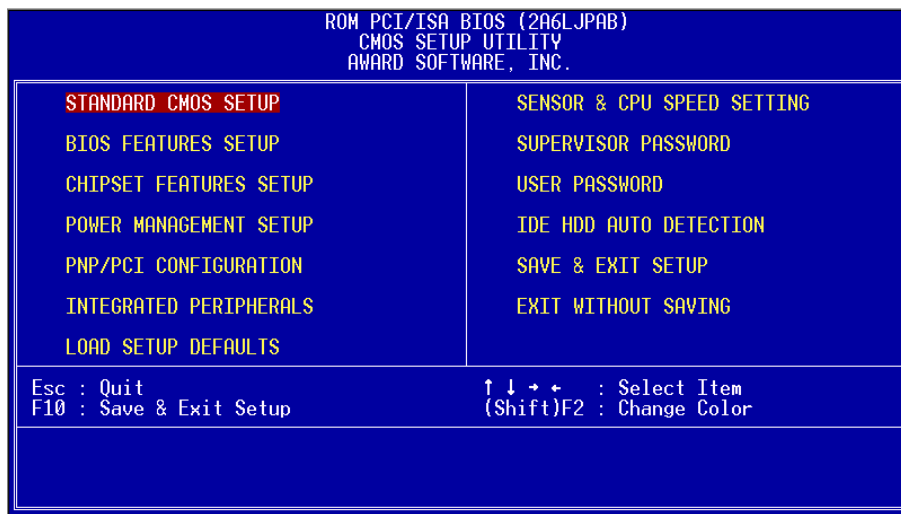

Figure 1: CMOS Setup Utility

BIOS

The menu displays all the major selection items. Select the item you need to reconfigure. The selection is made by moving the cursor (press any direction key) to the item and pressing the 'Enter' key. An on-line help message is displayed at the bottom of the screen as the cursor is moved to various items which provides a better understanding of each function. When a selection is made, the menu of the selected item will appear so that the user can modify associated configuration parameters.

4-1 Standard CMOS Setup

Choose "Standard CMOS Setup" in the CMOS SETUP UTILITY Menu (Figure 2). The Standard CMOS Setup allows the user to configure system settings such as the current date and time, type of hard disk drive installed, floppy drive type, and display type. Memory size is auto-detected by the BIOS and displayed for your reference. When a field is highlighted (use direction keys to move the cursor and the <Enter> key to select), the entries in the field can be changed by pressing the <PgDn> or the <PgUp> key.

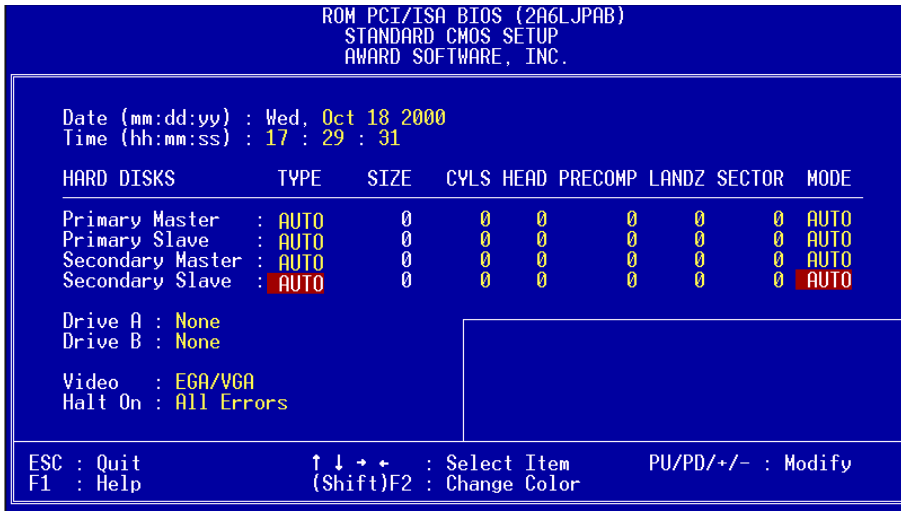

Figure 2: Standard CMOS Setup

NOTE: *If the hard disk Primary Master/Slave and Secondary Master/Slave are set to Auto, then the hard disk size and model will be auto-detected.*

NOTE: *The “Halt On:” field is used to determine when to halt the system by the BIOS if an error occurs.*

NOTE: *Floppy 3 Mode support is a mode used to support a special 3.5” drive used in Japan. This is a 3.5” disk that stores only 1.2 MB, the default setting for this is disabled.*

4-2 BIOS Features Setup

Selecting the “BIOS FEATURES SETUP” option in the CMOS SETUP UTILITY menu allows users to change system related parameters in the displayed menu.

This menu shows all of the manufacturer’s default values for the board.

Pressing the [F1] key will display a help message for the selected item.

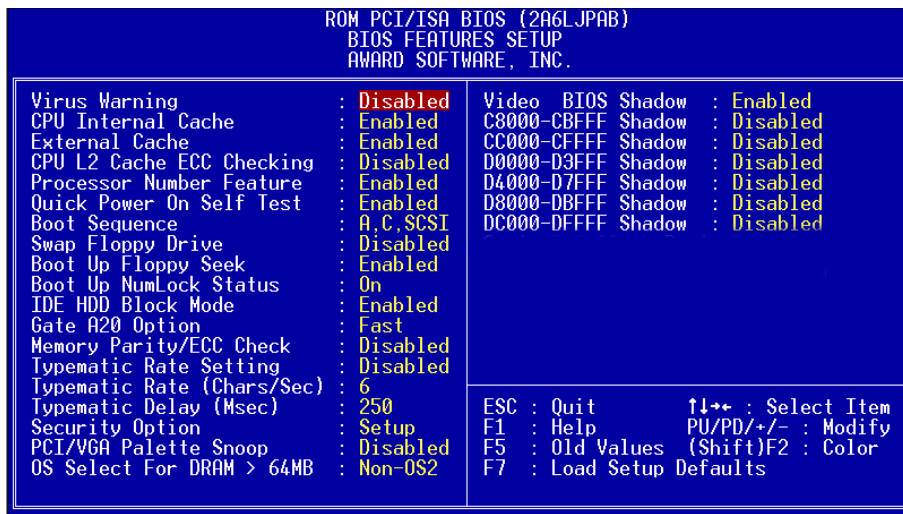

Figure 3: BIOS Features Setup

BIOS

Virus Warning: During and after the system boots up, any attempt to write to the boot sector or partition table of the hard disk drive will halt the system and an error message will appear.

You should then run an anti-virus program to locate the virus. Keep in mind that this feature protects only the boot sector, not the entire hard drive.

The default value is Disabled.

Enabled: Activates automatically when the system boots up causing a warning message to appear when anything attempts to access the boot sector.

Disabled: No warning message will appear when anything attempts to access the boot sector.

Note: Many disk diagnostic programs that access the boot sector table can trigger the virus warning message. If you plan to run such a program, we recommend that you first disable the virus warning.

CPU Internal Cache: This controls the status of the processor's internal cache area. The default is Enabled.

Enabled: This activates the CPU's internal cache thereby increasing performance.

Disabled: This deactivates the CPU's internal cache thereby lowering performance.

External (L2) Cache: This controls the status of the external (L2) cache area. The default is Enabled.

Enabled: This activates the CPU's L2 cache thereby increasing performance.

Disabled: This deactivates the CPU's L2 cache thereby lowering performance.

CPU L2 Cache ECC Checking: This control if the CPU's L2 Cache will support Error Checking and Correcting (ECC). The default is Disabled.

Enabled: Enables ECC support for the CPU's L2 cache. Performance will decrease 2% ~ 4%.

Disabled: Disables ECC support for the CPU's L2 cache.

Processor Number Feature: Pentium III or later CPU new feature. The default is Enabled.

Enabled: Processor serial number readable.

Disabled: Processor serial number disabled.

Quick Power On Self Test: This category speeds up the Power On Self Test (POST). The default is Enabled.

Enabled: This setting will shorten or skip of the items checked during POST.

Disabled: Normal POST.

Boot Sequence: This category determines which drive is searched first by the O/S (Operating System). The default is A,C,SCSI.

The following is your list of options:

[A, C, SCSI] - [C, A, SCSI] - [C, CD-ROM, A] - [CD-ROM, C, A]

[D, A,CD-ROM],[E, A, CD-ROM] - [F, A, CD-ROM] - [SCSI, A, C]

[SCSI C, A] - [C Only]

Swap Floppy Drive: This will swap your physical drive letters A & B if you are using two floppy disks. The default is Disabled.

Enabled: Floppy A & B will be swapped under the O/S.

Disabled: Floppy A & B will be not swapped.

Boot Up Floppy Seek: During Power-On-Self-Test (POST), BIOS will determine if the floppy disk drive installed is 40 or 80 tracks. Only 360K type is 40 tracks while 760K, 1.2MB and 1.44MB are all 80 tracks. The default is Enabled.

Enabled: The BIOS will search the floppy disk drive to determine if it is 40 or 80 tracks.

Disabled: The BIOS will not search for the type of floppy disk drive by track number.

Note: BIOS can not tell the difference between 720K, 1.2MB and 1.44MB drive types as they are all 80 tracks.

Boot Up NumLock Status: This controls the state of the NumLock key when the system boots. The default is On.

On: The keypad acts as a 10-key pad.

Off: The keypad acts like the cursor keys.

IDE HDD Block Mode: IDE Block Mode allows the controller to access blocks of sectors rather than a single sector at a time. The default is Enabled.

Enabled: Enabled IDE HDD Block Mode. Provides higher HDD transfer rates.

Disabled: Disable IDE HDD Block Mode.

BIOS

Gate A20 Option: This refers to the way the system addresses memory above 1MB (extended memory). The default is Fast.

Normal: The A20 signal is controlled by the keyboard controller or chipset hardware.

Fast: The A20 signal is controlled by Port 92 or chipset specific method.

Memory Parity/ECC Check: If the DRAM chip in your system support Parity/ECC check, select Enabled.

Typematic Rate Setting: This determines the keystrokes repeat rate. The default is Disabled.

Enabled: Allows typematic rate and typematic delay programming.

Disabled: The typematic rate and typematic delay will be controlled by the keyboard controller in your system.

Typematic Rate (Chars/Sec): This is the number of characters that will be repeated by a keyboard press. The default is 6.

6: 6 characters per second.

8: 8 characters per second.

10: 10 characters per second.

12: 12 characters per second.

15: 15 characters per second.

20: 20 characters per second.

24: 24 characters per second.

30: 30 characters per second.

Typematic Delay (msec): This setting controls the time between the first and the second character displayed by typematic auto-repeat. The default is 250.

250: 250 msec.

500: 500 msec.

750: 750 msec.

1000: 1000 msec.

Security Option: This category allows you to limit access to the System and Setup, or just to Setup. The default is Setup.

System: The system will not boot and the access to Setup will be denied if the correct password is not entered at the prompt.

Setup: The system will boot; but the access to Setup will be denied if the incorrect password is not entered at the prompt.

PCI/VGA Palette Snoop: This field controls the ability of a primary PCI VGA controller to share a common palette (When a snoop write cycles) with an ISA video card. The default is Disabled.

Enabled: If an ISA card is connected to a PCI VGA card via the VESA connector, and that ISA card connects to a VGA monitor, then that ISA card uses the RAMDAC of the PCI card.

OS Select For DRAM > 64MB: Some operating systems require special handling. Use this option only if your system has greater than 64MB of memory. The default is Non-OS2.

OS2: Select this if you are running the OS/2 operating system with greater than 64MB of RAM.

Non-OS2: Select this for all other operating systems and configurations.

Video BIOS Shadow: This option allows video BIOS to be copied into RAM. Video Shadowing will increase the video performance of your system. The default is Enabled.

Enabled: Video shadow is enabled.

Disabled: Video shadow is disabled.

C8000 - CBFFF Shadow:

CC000 - CFFFF Shadow:

D0000 - D3FFF Shadow:

D4000 - D7FFF Shadow:

D8000 - DBFFF Shadow:

DC000 - DFFFF Shadow:

These categories determine whether ROMs from option cards will be copied into RAM. This will be in 16K byte or 32K byte units, and the size will depend on chipset of the option card.

Enabled: Optional shadow is enabled.

Disabled: Optional shadow is disabled.

4-3 Chipset Features Setup

Choose the “CHIPSET FEATURES SETUP” in the CMOS SETUP UTILITY menu to display following menu.

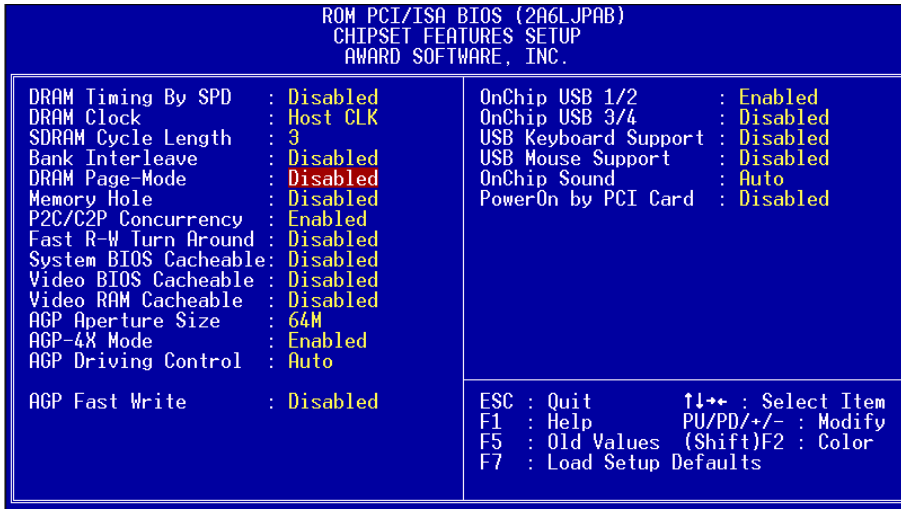

Figure 4: Chipset Features Setup

DRAM Timing By SPD: Select Enabled for setting SDRAM timing by SPD.
The Choice: Enabled, Disabled.

DRAM Clock : The item will synchronize/asynchronize DRAM operation clock.

Host CLK: Sets the memory to run at the same speed with the processor’s front side bus. If you have CPU at 133MHz FSB & PC133 memory, please use this selection.

HCLK+33M: Sets the memory to run at 33MHz faster than the processor’s front side bus. We recommend to select this item while your CPU is running at 100MHz FSB and memory is PC133 specification to optimize your system performance.

HCLK -33M: Sets the memory to run at 33MHz slower than the processor’s front side bus. This selection is suggested to be used under CPU at 133MHz FSB and PC100 memory configuration.

SDRAM Cycle length: This setting defines the CAS timing parameter of the SDRAM in terms of clocks. The default is 3.

- 2: Provides faster memory performance.
- 3: Provides better memory compatibility.

SDRAM Bank Interleave: The item allows you to set how many banks of SDRAM support in your mainboard.

The Choice: 2 Bank, 4 Bank, Disabled.

DRAM Page-Mode: The item will active or inactive chipset page registers.

Enabled: Page-Mode Enabled.

Disabled: No page registers update and non Page-Mode operation.

Memory Hole : You can reserve this memory area for the use of ISA adaptor ROMs. The default is Disabled.

Enabled: This field enables the main memory (15~16MB) to remap to ISA BUS.

Disabled: Normal Setting.

Note: If this feature is enabled you will not be able to cache this memory segment.

P2C/C2P Concurrency: This item allows you to enable/disable the PCI to CPU, CPU to PCI concurrency.

Fast R-W Turn Around: This item controls the DRAM timing. It allows you to enable/disable the fast read/write turn around.

System BIOS Cacheable: This allows you to copy your BIOS code from slow ROM to fast RAM. The default is Disabled.

Enabled: The option will improve system performance. However, if any program writes to this memory area, a system error may result.

Disabled: System BIOS non-cacheable.

Video BIOS Cacheable: This option copies the video ROM BIOS to fast RAM (C0000h to C7FFFh). The default is Enabled.

Enabled: Enables the Video BIOS Cacheable to speed up the VGA Performance.

Disabled: Will not use the Video BIOS Cacheable function.

BIOS

Video RAM Cacheable: This option allows the CPU to cache read/writes of the video RAM. The default is Enabled.

Enabled: This option allows for faster video access.

Disabled: Reduced video performance.

AGP Aperture Size: The amount of system memory that the AGP card is allowed to share. The default is 64.

Options: 4, 8, 16, 32, 64, 128, 256MB.

AGP-4X Mode: Chipset AGP Mode support.

Options: Enabled, Disabled.

AGP Driving Control: This item allows you to adjust the AGP driving force. Choose Manual to key in a AGP Driving Value in the next selection. This field is recommended to set in Auto for avoiding any error in your system.

AGP Fast Write: Selecting Enabled allows to use Fast Write Protocol for 4X AGP.

OnChip USB 1/2,3/4: USB Connector (Port 1-2)/(Port 3-4).

The choice: Enabled, Disabled.

USB Keyboard/Mouse Support: This controls the activation status of an optional USB keyboard/Mouse that may be attached. The default is disabled.

Enabled: Enable USB keyboard/Mouse support.

Disabled: Disable USB keyboard/Mouse support.

OnChip Sound: Turn on/off onchip sound device.

PowerOn by PCI Card: An input signal from PME on the PCI card awakens the system from a soft off state.

4-4 Power Management Setup

Choose the “POWER MANAGEMENT SETUP” in the CMOS SETUP UTILITY to display the following screen. This menu allows the user to modify the power management parameters and IRQ signals. In general, these parameters should not be changed unless it’s absolutely necessary.

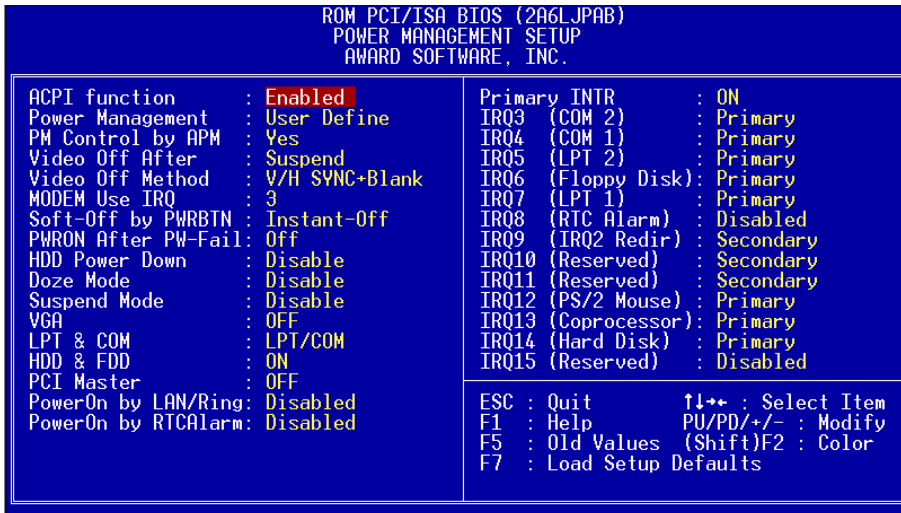

Figure 5: Power Management Setup

ACPI Function: This option allows you to select ACPI Function.

The default is Enabled.

Enabled: Support ACPI function for new O.S

Disabled: No Support ACPI function.

You can only change the content of Doze Mode, Standby Mode, and Suspend Mode when the Power Management is set to ‘User Define’.

Power Management: Use this to select your Power Management selection.

Max. saving: Maximum power savings. Inactivity period is 1 minute in each mode.

Min. saving: Minimum power savings. Inactivity period is 1 hour in each mode.

User define: Allows user to define PM Timers parameters to control power saving mode.

BIOS

PM controlled APM: This option shows whether or not you want the Power Management to be controlled by the Advanced Power Management (APM).
Options: Yes, No.

Video Off After: Tells you what time frame that the video will be disabled under current power management settings. The default is Standby.

Doze: Video powers off after time shown in doze mode setting.

Suspend: Video powers off after time shown in suspend mode setting.

N/A: Video power off not controlled by power management.

Video Off Method: This option allows you to select how the video will be disabled by the power management. The default is V/H Sync + Blank

V/H Sync + Blank: System turns off vertical and horizontal synchronization ports and writes blanks to the video buffer.

DPMS: Select this option if your monitor supports the Display Power Management Signaling (DPMS) standard of the Video Electronics Standards Association (VESA). Use the software supplied for your video subsystem to select video power management values.

Blank Screen: System only writes blanks to the video buffer.

MODEM Use IRQ: Name the interrupt request (IRQ) line assigned to the modem (if any) on your system. Activity of the selected IRQ always awakens the system. Default is IRQ 3.

N/A: No IRQ is used.	3: IRQ 3
4: IRQ 4	5: IRQ 5
7: IRQ 7	9: IRQ 9
10: IRQ 10	11: IRQ 11

Soft-Off by PWRBTN: Use this to select your soft-off function.

Instant Off: Turns off the system instantly.

Delay 4 Second : Turns off the system after a 4 second delay. If momentary press of button, the system will go into Suspend Mode. Press the power button again to take system out of Suspend Mode.

PWRON After PW-Fail: The system will stay off or power on after a power interrupted.

ON: System always power on after a power interrupted.

OFF: System always stay off after a power interrupted.

HDD Power Down: HDD Standby timer can be set from 1 to 15 minute(s).

Doze Mode: The “Doze” mode timer starts to count when no “PM events” have occurred.

Suspend Mode: This function works only when the Pentium II Processor is installed. The timer starts to count when “System Standby” mode timer is timed out and no “PM Events” are occurring. Valid range is from 1 minute up to 1 hour.

VGA: When set to On (default), any event occurring at a VGA port will awaken a system which has been powered down.

LPT & COM: When set to *On* (default), any event occurring at a COM(serial)/LPT (printer) port will awaken a system which has been powered down.

HDD & FDD: When set to *On* (default), any event occurring at a hard or floppy drive port will awaken a system which has been powered down.

PCI Master: When set to *On* (default), any event occurring to the DMA controller will awaken a system which has been powered down.

PowerOn by LAN/Ring: When set to *Enabled*, any event occurring to the LAN/Modem Ring will awaken a system which has been powered down.

PowerOn by RTCAlarm: When set to *Enable rtc alarm resume*, you could set the date (of month) and timer (hh:mm:ss), any event occurring at will awaken a system which has been powered down.

Primary INTR: When set to *On* (default), any event occurring at will awaken a system which has been powered down.

4-5 PNP/PCI Configuration

The PNP/PCI configuration program is for the user to modify the PCI/ISA IRQ signals when various PCI/ISA cards are inserted in the PCI or ISA slots.

WARNING: *Conflicting IRQ's may cause the system to not find certain devices.*

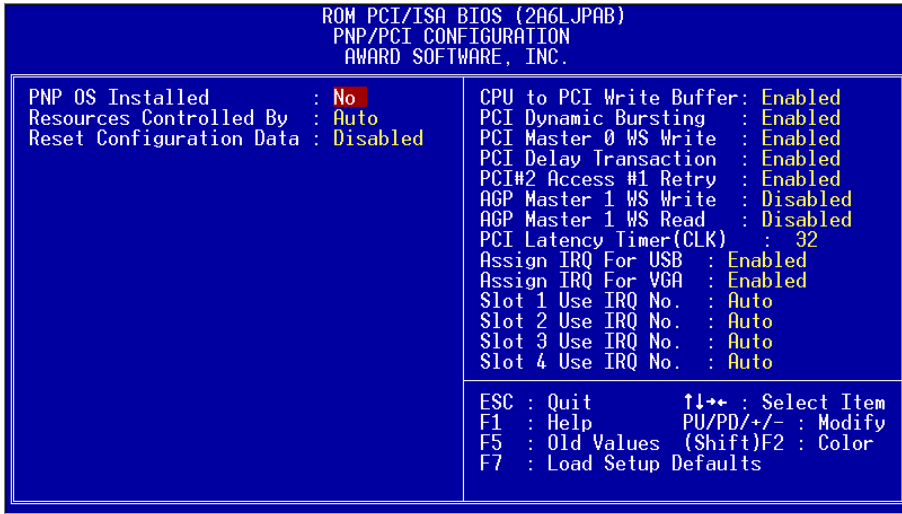

Figure 6: PCI Configuration Setup

PNP OS Installed: Do you have a PNP OS installed on your system. The default is No.

Yes: Select if you are using a PNP OS.

No: Select if your OS does not support PNP.

Resources Controlled By: Who controlled the system PNP/PCI resources. The default is Auto.

Manual: PNP Card's resources will be controlled manually. You can set which IRQ-X and DMA-X are assigned to PCI/ISA PNP or Legacy ISA Cards.

Auto: If your ISA card and PCI card are all PNP cards, BIOS will assign the interrupt resource automatically.

Reset Configuration Data: This setting allows you to clear ESCD data.

The default is Disabled

Disabled: Normal Setting.

Enabled: If you have plugged in some Legacy cards to the system and they were recorded into ESCD (Extended System Configuration Data), you can set this field to Enabled in order to clear ESCD.

CPU to PCI Write Buffer: When enabled, up to four D words of data can be written to the PCI bus without interrupting the CPU. When disabled, a write buffer is not used and the CPU read cycle will not be completed until the PCI bus signals that it is ready to receive the data.

The Choice: Enabled, Disabled.

PCI Dynamic Bursting: When Enabled, data transfers on the PCI bus, where possible, make use of the high-performance PCI bus protocol, in which greater amounts of data are transferred at a single command.

The Choice: Enabled, Disabled.

PCI Master 0 WS Write: When Enabled, writes to the PCI bus are command with zero wait states.

The Choice: Enabled, Disabled.

PCI Delay Transaction: The chipset has an embedded 32-bit posted write buffer to support delay transactions cycles. Select Enabled to support compliance with PCI specification version 2.1.

The Choice: Enabled, Disabled.

PCI #2 Access #1 Retry: This item allows you enabled/disable the PCI #2 Access #1 Retry.

The Choice: Enabled, Disabled.

AGP Master 1 WS Write: When Enabled, writes to the AGP are executed with one wait states.

The Choice: Enabled, Disabled.

AGP Master 1 WS Read: When Enabled, read to the AGP are executed with one wait states.

The Choice: Enabled, Disabled.

BIOS

PCI Latency Timer (CLK): The latency timer defines the minimum amount of time, in PCI clock cycles, that the bus master can retain the ownership of the bus.
The Choice: 0-255.

Assign IRQ For VGA/USB: This item allows BIOS to assign whether IRQ is with VGA/USB or not. If you have not connect the VGA/USB device. Can release the IRQ for other device. The default is Enabled.

Enabled: Provides IRQ for VGA/USB device.

Disabled: Release IRQ for other device.

Slot 1 to Slot 4 Use IRQ No: These settings allow the user to specify what IRQ will be assigned to PCI devices in the chosen slot. Options available: Auto,3,4,5, 7,9,10,11,12,14 & 15. The defaults are Auto.

4-6 Integrated Peripherals

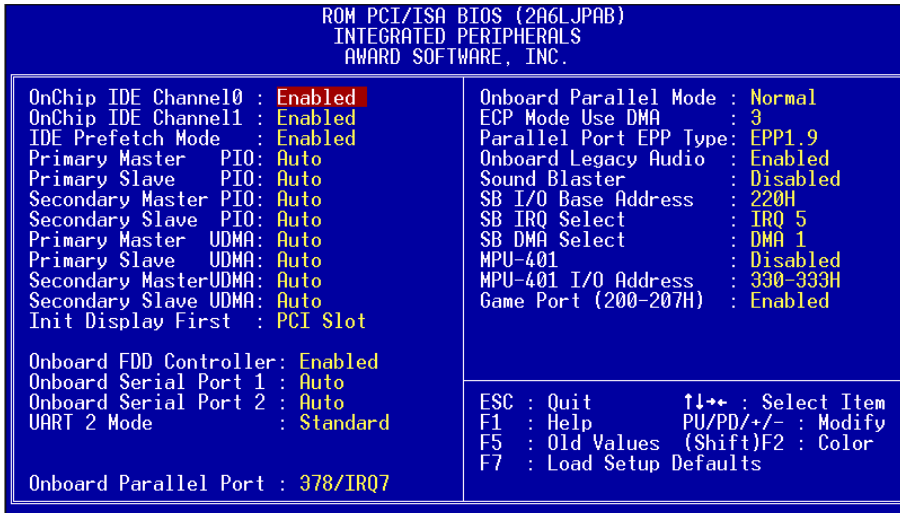

Figure 8: Integrated Peripherals

Note: If you do not use the Onboard IDE connector, then you will need to set Onboard Primary PCI IDE: Disabled and Onboard Secondary PCI IDE: Disabled

Note: The Onboard PCI IDE cable should be equal to or less than 18 inches (45 cm.).

OnChip IDE Channel0/1: The default value is Enabled.

Enabled: Enables Onboard IDE primary port.

Disabled: Disables Onboard IDE primary port.

IDE Prefetch Mode: Enable prefetching for IDE drive interfaces that support its faster drive accesses. If you are getting disk drive errors, change the setting to omit the drive interface where the errors occur. Depending on the configuration of your IDE subsystem, this field may not appear, and it does not appear when the Internal PCI/IDE field, above, is Disabled.

The Choice: Enabled, Disabled.

BIOS

Primary Master PIO: The default is Auto.

Auto: BIOS will automatically detect the Onboard Primary Master PCI IDE HDD Accessing mode.

Mode 0~4: Manually set the IDE Programmed interrupt mode.

Primary Slave PIO: The default is Auto.

Auto: BIOS will automatically detect the Onboard Primary Slave PCI IDE HDD Accessing mode.

Mode 0~4: Manually set the IDE Programmed interrupt mode.

Secondary Master PIO: The default is Auto.

Auto: BIOS will automatically detect the Onboard Secondary Master PCI IDE HDD Accessing mode.

Mode 0~4: Manually set the IDE Programmed interrupt mode.

Secondary Slave PIO: The default is Auto.

Auto: BIOS will automatically detect the Onboard Secondary Slave PCI IDE HDD Accessing mode.

Mode 0~4: Manually set the IDE Programmed interrupt mode.

Primary Master UDMA: This allows you to select the mode of operation for the hard drive. The default is Auto.

Auto: The computer will select the optimal setting.

Disabled: The hard drive will run in normal mode.

Primary Slave UDMA: This allows you to select the mode of operation for the hard drive. The default is Auto.

Auto: The computer will select the optimal setting.

Disabled: The hard drive will run in normal mode.

Secondary Master UDMA: This allows you to select the mode of operation for the hard drive. The default is Auto.

Auto: The computer will select the optimal setting.

Disabled: The hard drive will run in normal mode.

Secondary Slave UDMA: This allows you to select the mode of operation for the hard drive. The default is Auto.

Auto: The computer will select the optimal setting.

Disabled: The hard drive will run in normal mode.

Init Display First: If two video cards are used (1 AGP and 1 PCI) this specifies which one will be the primary display adapter. The default is PCI Slot.

PCI Slots: PCI video card will be primary adapter.

AGP: AGP video card will be primary adapter.

Onboard FDD Controller: This controls the state of the onboard floppy controller. The default value is Enabled.

Enabled: Enable the Onboard VIA686A(B)'s floppy drive interface controller.

Disabled: Disable the Onboard VIA686A(B)'s floppy drive interface controller.

Onboard Serial Port 1: This field allows the user to configure the 1st serial port. The default is Auto.

AUTO: Enable Onboard Serial port 1 and address is Auto adjusted.

COM1: Enable Onboard Serial port 1 and address is 3F8H/IRQ4.

COM2: Enable Onboard Serial port 1 and address is 2F8H/IRQ3.

COM3: Enable Onboard Serial port 1 and address is 3E8H/IRQ4.

COM4: Enable Onboard Serial port 1 and address is 2E8H/IRQ3.

Disabled: Disable Onboard VIA686A(B)'s Serial port 1.

Onboard Serial Port 2: This field allows the user to configure the 2nd serial port. The default is Auto.

AUTO: Enable Onboard Serial port 2 and address is Auto adjusted.

COM1: Enable Onboard Serial port 2 and address is Auto.

COM2: Enable Onboard Serial port 2 and address is 2F8H/IRQ3.

COM3: Enable Onboard Serial port 2 and address is 3E8H/IRQ4.

COM4: Enable Onboard Serial port 2 and address is 2E8H/IRQ3.

Disabled: Disable Onboard VIA686A(B)'s Serial port 2.

UART 2 Mode: This item allows you to determine which Infra Red (IR) function of onboard I/O chip.

The Choice: Standard, ASKIR, HPSIR.

Onboard Parallel port: This field allows the user to configure the LPT port. The default is 378H/IRQ7.

378H: Enable Onboard LPT port and address is 378H and IRQ7.

278H: Enable Onboard LPT port and address is 278H and IRQ5.

BIOS

3BCH: Enable Onboard LPT port and address is 3BCH and IRQ7.

Disabled: Disable Onboard VIA686A(B)'s LPT port.

Parallel Port Mode: This field allows the user to select the parallel port mode. The default is Normal.

Normal: Standard mode. IBM PC/AT Compatible bidirectional parallel port.

EPP: Enhanced Parallel Port mode.

ECP: Extended Capabilities Port mode.

EPP+ECP: ECP Mode & EPP Mode.

ECP Mode USE DMA: This field allows the user to select DMA1 or DMA3 for the ECP mode. The default is DMA3.

DMA1: This field selects the routing of DMA1 for the ECP mode.

DMA3: This field selects the routing of DMA3 for the ECP mode.

Parallel Port EPP Type: This item allows you to determine the IR transfer mode of onboard I/O chip.

The Choice: EPP1.9, EPP1.7.

Onboard Legacy Audio: Legacy Audio enabled/disabled.

Sound Blaster: Sound Blaster compatible device enabled/disabled.

SB I/O Base Address: Sound Blaster I/O resource selection.

SB IRQ Select: Legacy audio device IRQ selection.

SB DMA Select: Sound Blaster DMA channel selection.

MPU-401: MPU-401 function enabled/disabled.

MPU-401 I/O Address: Built-in MPU-401 compatible MIDI I/O port selection:

300-303H

310-313H

320-323H

330-333H (default)

Game Port (200-207H): Built-in joystick port support disabled/enabled(default).

4-7 Load Setup Defaults

The “LOAD SETUP DEFAULTS” function loads the system default data directly from ROM and initializes the associated hardware properly. This function will be necessary only when the system CMOS data is corrupted.

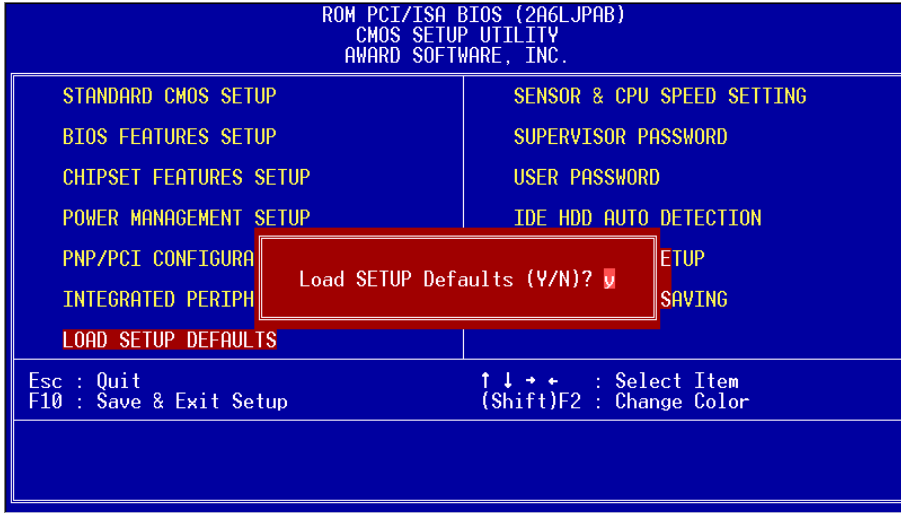
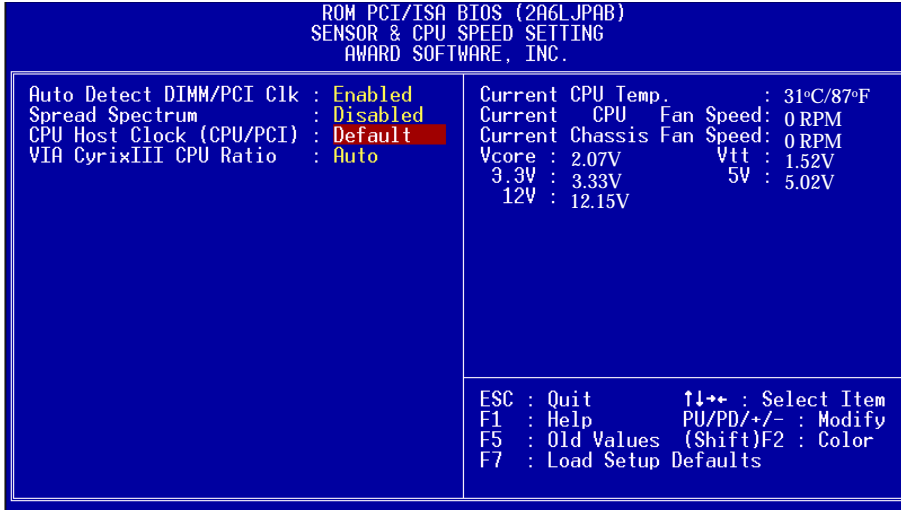

Figure 7: Load Setup Defaults

BIOS

4-8 Sensor and CPU Speed Setup



Auto Detect DIMM/PCI Clk: When enabled the motherboard will automatically disable the clock source for a DIMM socket which does not have a module in it. Same applies for PCI slots. This setting will reduce the EMI. The default is Enabled.

Spread Spectrum: The default is Disabled.

CPU Host Clock (CPU/PCI): The mainboard is designed to set the CPU Host /PCI clock via BIOS. This item allows you to select the CPU Host, PCI clock speed by “Enter” key. “Default” means the CPU Host speed is auto detected.

Cyrix III Clock Ratio: Cyrix III CPU Ratio adjust (for CyrixIII CPU only).

Current CPU Temperature: This is the current temperature of the CPU.

Current CPU FAN Speed: The current CPU fan speed in RPMs.

Current Chassis FAN Speed: The current chassis fan speed in RPMs.

CPU(V): The voltage level of the CPU(Vio/Vcore).

Vtt, +3.3V, +5V, +12V: The voltage level of the switch power supply.

4-9 Change Supervisor or User Password

To change the password, choose the “SUPERVISOR PASSWORD or USER PASSWORD” option from the CMOS SETUP UTILITY menu and press [Enter].

Note: Either “Setup” or “System” must be selected in the “Security Option” of the BIOS FEATURES SETUP menu.

1. If CMOS is corrupted or the option was not used, a default password stored in the ROM will be used. The screen will display the following message:

Enter Password:

Press the [Enter] key to continue after the proper password is given.

2. If the CMOS is corrupted or the option was used earlier and the user wishes to change the default password, the SETUP UTILITY will display a message and ask for a confirmation.

Confirm Password:

3. After pressing the [Enter] key (ROM password if the option was not used) or current password (user-defined password), the user can change the password and store new one in CMOS RAM. A maximum of 8 characters can be entered.

4-10 IDE HDD Auto Detection

The “IDE HDD auto detection” utility is a very useful tool, especially when you do not know which kind of hard disk type you are using. You can use this utility to detect the correct disk type installed in the system automatically. But now you can set HARD DISK TYPE to Auto in the STANDARD CMOS SETUP. You don’t need the “IIDE HDD AUTO DETECTION” utility. The BIOS will Auto-detect the hard disk size and model on display during POST.

ROMPCI/ISABIOS(2A6LJPAB)
CMOSSETUPUTILITY
AWARDSOFTWARE,INC.

HARD DISKS	TYPE	SIZE	CYLS	HEADS	PRECOMP	LANDZONE	SECTORS	MODE
Primary Master :								
Select Secondary Slave Option (N=Skip) : N								
OPTIONS	SIZE	CYLS	HEAD	PRECOMP	LANDZ	SECTORMODE		
2 (Y)	4310	524	255	0	14847	63 LBA		
1	4310	14848	9	65535	14847	63 NORMAL		
3	4310	928	144	65535	14847	63 LARGE		
Note: Some OSes (like SCO-UNIX) must use NORMAL for installation								
ESC : Skip								

Figure 8: IDE HDD Auto Detection

Note: HDD Modes

The Award BIOS supports 3 HDD modes : NORMAL, LBA & LARGE NORMAL mode

Generic access mode in which neither the BIOS nor the IDE controller will make any transformations during accessing.

The maximum number of cylinders, head & sectors for NORMAL mode are 1024, 16 & 63.

no. Cylinder (1024)
x no. Head (16)
x no. Sector (63)
x no. per sector (512)
528 Megabytes

If user set his HDD to NORMAL mode, the maximum accessible HDD size will be 528 Megabytes even though its physical size may be greater than that!

LBA (Logical Block Addressing) mode: A new HDD accessing method to overcome the 528 Megabyte bottleneck. The number of cylinders, heads & sectors shown in setup may not be the number physically contained in the HDD. During HDD accessing, the IDE controller will transform the logical address described by sector, head & cylinder into its own physical address inside the HDD. The maximum HDD size supported by LBA mode is 8.4 GigaBytes which is obtained by the following formula:

$$\begin{array}{r} \text{no. Cylinder} \quad \quad \quad (1024) \\ \text{x no. Head} \quad \quad \quad (255) \\ \text{x no. Sector} \quad \quad \quad (63) \\ \hline \text{x bytes per sector} \quad \quad (512) \\ \hline \quad \quad \quad \quad \quad \quad 8.4 \text{ GigaBytes} \end{array}$$

LARGE mode: Extended HDD access mode supported by Award Software.

Some IDE HDDs contain more than 1024 cylinder without LBA support (in some cases, user do not want LBA). The Award BIOS provides another alternative to support these kinds of LARGE mode.

<u>CYLS</u>	<u>HEADS</u>	<u>SECTOR</u>	<u>MODE</u>
1120	16	59	NORMAL
560	32	59	LARGE

BIOS tricks DOS (or other OS) that the number of cylinders is less than 1024 by dividing it by 2. At the same time, the number of heads is multiplied by 2. A reverse transformation process will be made inside

INT 12h in order to access the right HDD address!

Maximum HDD size:

$$\begin{array}{r} \text{no. Cylinder} \quad \quad \quad (1024) \\ \text{x no. Head} \quad \quad \quad (32) \\ \text{x no. Sector} \quad \quad \quad (63) \\ \hline \text{x bytes per sector} \quad \quad (512) \\ \hline \quad \quad \quad \quad \quad \quad 1 \text{ GigaByte} \end{array}$$

Note: To support LBA or LARGE mode of HDDs, there must be some software involved. All the software is located in the Award HDD Service Routine

BIOS

(INT 13h). It may fail to access a HDD with LBA (LARGE) mode selected if you are running under an Operating System which replaces the whole INT 13h.

UNIX operating systems do not support either LBA or LARGE and must utilize the Standard mode. UNIX can support drives larger than 528MB.

4-11 Save & Exit Setup

The “SAVE & EXIT SETUP” option will bring you back to the boot up procedure with all the changes you just recorded in the CMOS RAM.

4-12 Exit Without Saving

The “EXIT WITHOUT SAVING” option will bring you back to normal boot up procedure without saving any data into CMOS RAM.

All old data in the CMOS will not be destroyed.

A-1 GHOST 5.1/6.03 Quick User's Guide

Installation is very easy. You only need to copy the **Ghost5** folder or **Ghost.exe** to your hard disk.

The current market version is for single **Client**, so the LPT and NetBios portions will not be explained further.

Description of Menus

Ghost clones and backs up **Disk** and **Partition**.

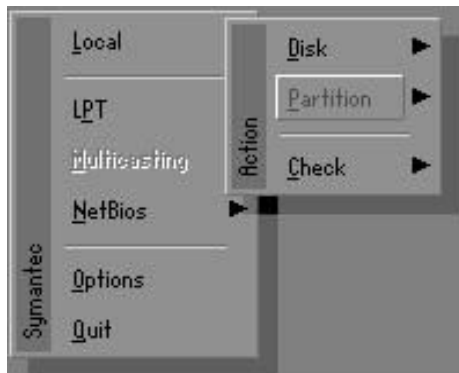

In which **Disk** indicates hard disk options
Partition indicates partition options
Check indicates check options

Disk

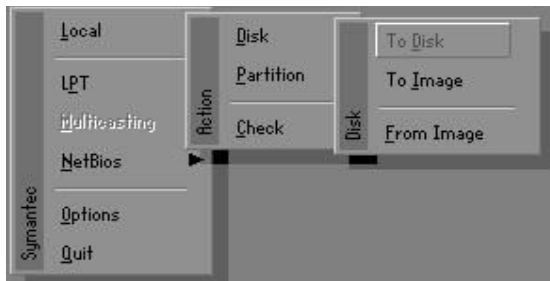

Appendix

There are 3 hard disk functions:

1. Disk To Disk (disk cloning)
2. Disk To Image (disk backup)
3. Disk From Image (restore backup)

Important!

1. To use this function, the system must have at least 2 disks. Press the **Tab** key to move the cursor.
2. When restoring to a destination disk, all data in that disk will be completely destroyed.

Disk To Disk (Disk Cloning)

1. Select the location of the **Source** drive.
2. Select the location of the **Destination** drive.

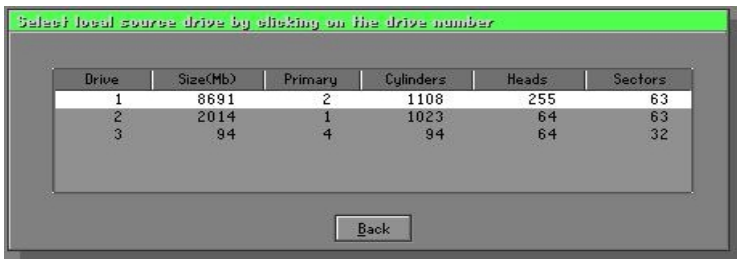

3. When cloning a disk or restoring the backup, set the required partition size as shown in the following figure.



- Click OK to display the following confirmation screen. Select **Yes** to start.

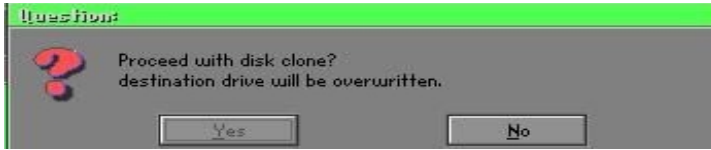

Disk To Image (Disk Backup)

- Select the location of the Source drive.

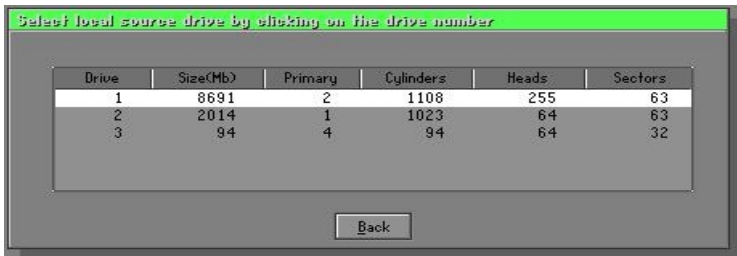

- Select the location for storing the backup file.

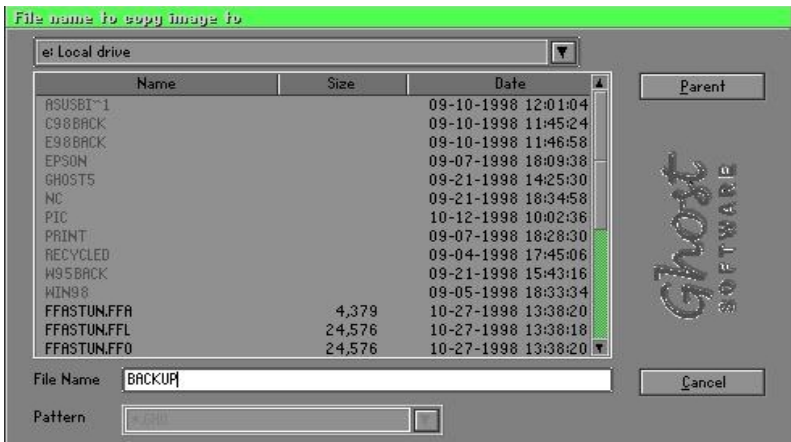

Appendix

3. Click **OK** to display the following confirmation screen. Select **Yes** to start.



Disk From Image (Restore Backup)

1. Select the Restore file.

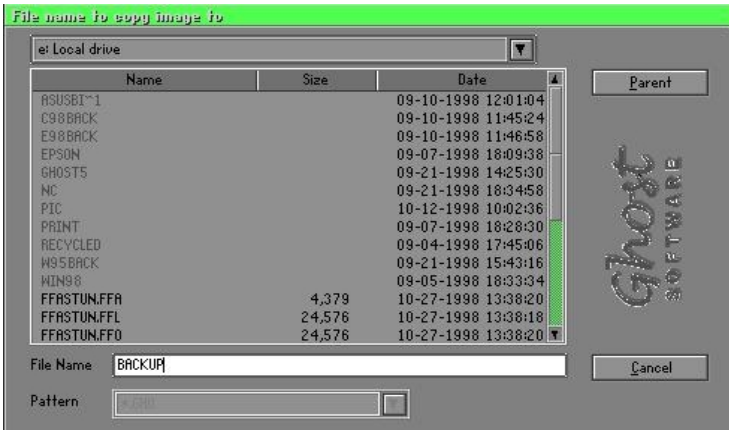

2. Select the **Destination** drive of the disk to be restored.

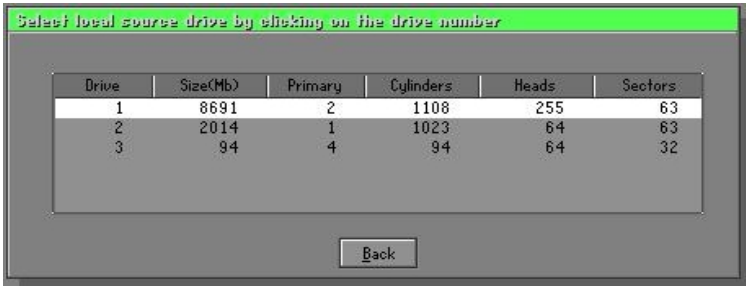

- When restoring disk backup, set the required partition size as shown in the following figure.

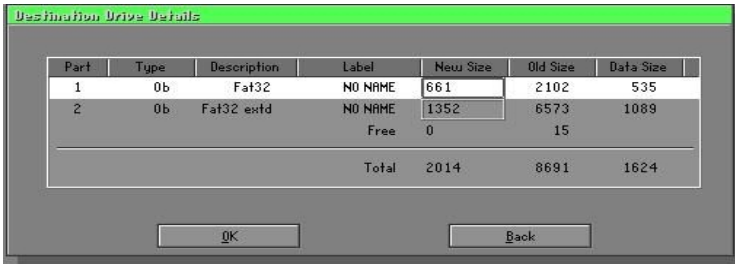

- Click **OK** to display the following confirmation screen. Select **Yes** to start.

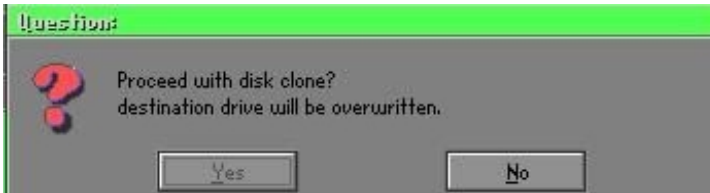

Partition

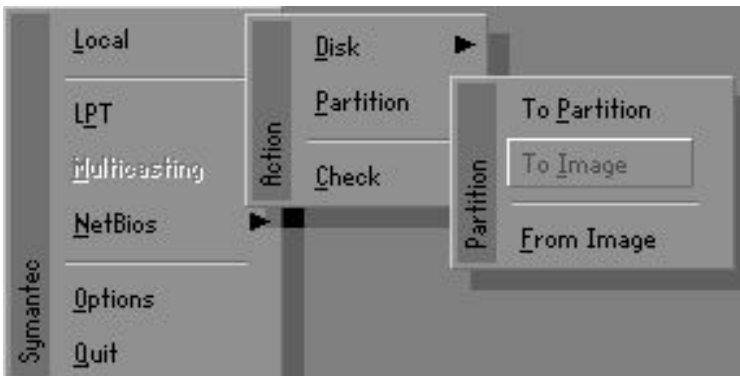

Appendix

There are 3 partition functions:

1. **Partition To Partition** (partition cloning)
2. **Partition To Image** (partition backup)
3. **Partition From Image** (restore partition)

Partition To Partition (Partition Cloning)

The basic unit for partition cloning is a partition. Refer to disk cloning for the operation method.

Partition To Image (Partition Backup)

1. Select the disk to be backed up.

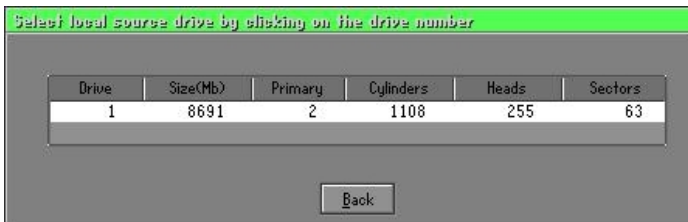

2. Select the first partition to be backed up. This is usually where the operating system and programs are stored.



3. Select the path and file name for storing the backup file.

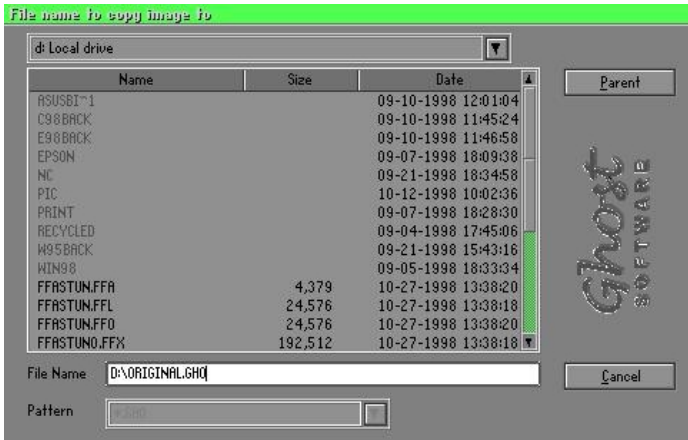

4. Is the file compressed? There are 3 options:

(1) No: do not compress data during backup

(2) Fast: Small volume compression

(3) High: high ratio compression. File can be compressed to its minimum, but this requires longer execution time.

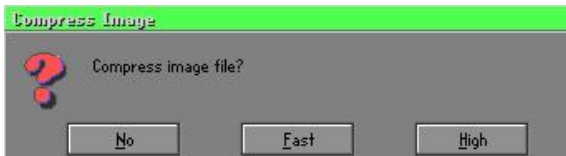

5. During confirmation, select Yes to start performing backup.



Appendix

Partition From Image (Restore Partition)

1. Select the backup file to be restored.

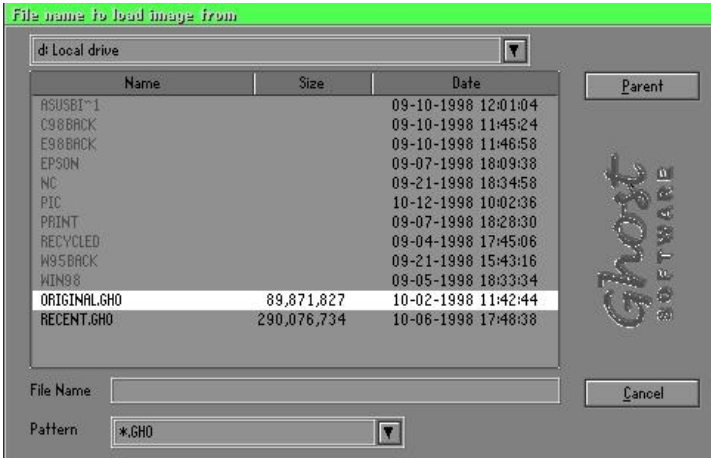

2. Select the source partition.



3. Select the disk to be restored.

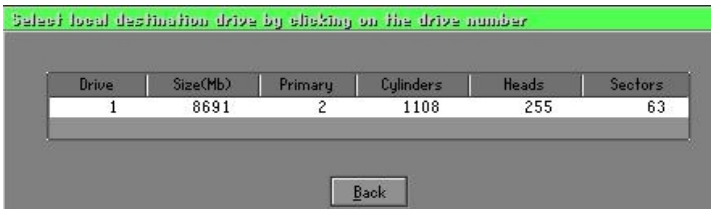

4. Select the partition to be restored.



5. Select Yes to start restoring.

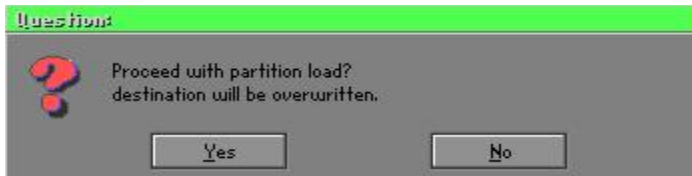

Check

This function checks the hard disk or backup file for backup or restoration error due to FAT or track error.

How to Reinstall Windows in 2 Minutes

This chapter teaches you how to set your computer properly and, if necessary, reinstall Windows in 2 minutes. Ghost can use different methods to complete this task. The following two sections explain the creation of the emergency Recover Floppy and Recover CD:

Emergency Recover Floppy

Divide a hard disk into two partitions. The first partition is for storing the operating system and application programs. The second partition is for backing up the operating system and data. The size of the partition can be set according to the backup requirements. For example, the **Windows** operating system needs 200MB of hard disk space, while the complete **Office** installation requires 360MB. The remaining space can be used to store other data.

After installing **Windows**, use **Ghost** to create a backup of the source system and store the file (Image file) in drive D. The file is named as **Original.gho**. Then, create a recover floppy disk containing:

- ◆ Bootable files (Command.com, Io.sys, and MSDOS.SYS)
- ◆ Config.sys (configuration setup file)
- ◆ Autoexec.bat (auto-execution batch file)
- ◆ Ghost.exe (Ghost execution file)

There are two ways to set the content of the recover floppy for restoration:

- (1) To load **Windows** automatically after booting, set the **Autoexec.bat** command as:

```
Ghost.exe clone, mode=pload, src=d:\original.gho:2,dst=1:1 -fx -sure -rb
```

Description: Runs the restore function automatically using the Image File. After execution, it exits Ghost and boots the system automatically.

Refer to the [Introducing Ghosts Functions].

- (2) After booting, the screen displays the Menu. Select Backup or Restore: Since the user may install other applications in the future, he/she may design **Autoexec.bat** as a Menu to back up or restore the user-defined Image file as follows:

 **Backup**

Back up Windows and application programs as a file (Recent.gho). Command is:

```
Ghost -clone,mode=pdump,src=1:1,dst=d:\Recent.gho -fx -sure -rb
```

 **Restore**

Restore types include [**General Windows**] and [**Windows and Application Programs**]. If you select [**General Windows**], the system is restored to the general **Windows** operation condition. The command is:

```
Ghost.exe -clone,mode=pload,src=d:\Original.gho,dst=1:1 -fx -sure -rb
```

If you select [**Windows and Application Programs**], the latest backup file (Recent.gho) is restored, skipping the installation and setup of application programs.

For description of relevant parameters, refer to [**Introducing Ghosts Functions**].

For more information about menu design, refer to Config.sys and Autoexec.bat under /Menu in the CD. You can also create a backup CD containing Ghost.exe and these two files.

Recover CD

In recent years, well-known computer manufacturers (such as IBM, Acer, Compaq, etc.) bundle Recover CDs with their computers to reduce the cost resulting from servicing, while at the same time increasing their market competitiveness.

The following is a simple guide to how to create a recover CD:

1. For extremely easy creation of the recover floppy disk, use the copy program for example “Easy CD Creator “ (Note 2). First, create a recover floppy disk containing:

Bootable files (Command.com and Io.sys and MSDOS.SYS)

Config.sys (Configuration setup file)

Autoexec.bat (Auto-execution batch file)

Mscdex.exe (CD-Rom execution file)

Ghost.exe (Ghost execution file)

Oakcdrom.sys (ATAPI CD-ROM compatible driver)

The content of Config.sys is:

```
DEVICE=Oakcdrom.sys /d:idecd001
```

The content of Autoexec.bat includes:

```
MSCDEX.EXE /D:IDECD001 /L:Z
```

```
Ghost.exe clone,mode=load,src=z:\original.gho,dst=1 -sure -rb
```

2. Write the backup image file (original.gho) of the entire hard disk or partition into the recover CD. Use the Recover CD to boot up the system and restore the backup files automatically.

For description of relevant parameters, refer to **[Introducing Ghosts Functions]**.

Note: For more details regarding the creation program and method for creating the recover CD, please refer to the legal software and relevant operation manual.

Ghost Command Line Switches Reference

Ghost may be run in interactive or in batch mode. Batch mode is useful for automating installations for backups using Ghost. Most of the Ghost switches are used to assist with batch mode operation. To list switches from Ghost, type `ghost.exe -h`.

-clone

The full syntax for this switch is:

```
clone,MODE={copy|load|dump|pcopy|pload|pdump},SRC={drive|file|drive:partition},DST={drive|file|drive:partition},SIZE {F|L|n={nnnnM|nnP|F|V}}
```

Clone using arguments. This is the most useful of the batch switches and has a series of arguments that define:

- a) MODE** This defines the type of clone command to be used:
- | | |
|--------------|-----------------------------|
| COPY | disk to disk copy |
| LOAD | file to disk load |
| DUMP | disk to file dump |
| PCOPY | partition to partition copy |
| PLOAD | file to partition load |
| PDUMP | partition to file dump |
- b) SRC** This defines the source location for the operation:
- | Mode | Meaning: |
|---------------|---|
| COPY/ | |
| DUMP | Source drive (e.g, 1 for drive one) |
| LOAD | Disk image filename or device (e.g, g:\Images\system2.img) |
| PCOPY/ | |
| PDUMP | Source partition e.g, 1:2 indicates the second partition on drive one. |
| PLOAD | Partition image filename or device and partition number. Example: g:\images\disk1.img:2 indicates the second partition in the Image file. |

Appendix

- c) **DST** This defines the destination location for the operation:
- | Mode | Meaning |
|---------------|---|
| COPY/ | |
| LOAD | Destination drive (e.g, 2 for drive two) |
| DUMP | Disk image filename or device,(e.g, g:\images\system2.img) |
| PCOPY/ | |
| PLOAD | Destination partition,(e.g, 2:2 indicates the second partition on drive two). |
| PDUMP | Partition image filename (e.g, g:\images\part1.img). |
- c) **SZEy** Used to set the size of the destination partitions for either a disk load or disk copy operation.

Available y Options:

- F Resizes the first partition to maximum size allowed based on file system t type.
- L Resizes the last partition to maximum size allowed based on file system type.
- n=xxxxM - indicates that the n?h destination partition is to have a size of xxxx Mb. (e.g, SZE2=800M indicates partition two is to have 800 mb.) n=mmP - indicates that the n?h destination partition is to have a size of mm percent of the target disk.
- n=F - indicates that the n?h destination partition is to remain fixed in size.
- n=V - Indicates that the partition will be resized according to the following rules:
- Rule 1** - If the destination disk is larger than the original source disk, then the partition(s) will be expanded to have the maximum amount of space subject to the free space available and the partition type (e.g, FAT16 partitions will have a maximum size of 2048Mb.)
- Rule 2** - If the destination disk is smaller than the original source disk, (but still large enough to accommodate the data from the source disk), the free space left over after the

data space has been satisfied will be distributed between the destination partitions in proportion to the data usage in the source partitions. Some examples follow that will help illustrate:

- fx flag Exit. Normally when Ghost has finished copying a new system to a disk, it prompts the user to reboot with a press Ctrl-Alt-Del to reboot window. However, if Ghost is being run as part of a batch file it is sometimes useful to have it just exist back to the DOS prompt after completion so that further batch commands may be processed. -fx enables this. See -rb for another option on completing a clone.
- ia Image All. The Image All switch forces Ghost to do a sector by sector copy of all partitions. When copying a partition from a disk to an image file or to another disk, Ghost examines the source partition and decides whether to copy just the files and directory structure, or to do an image (sector by sector) copy. If it understands the internal format of the partition it defaults to copying the files and directory structure. Generally this is the best option, but occasionally if a disk has been set up with special hidden security files that are in specific positions on the partition, the only way to reproduce them accurately on the target partition is via an image or sector-by-sector copy.
- span enables spanning across volumes.
- split=x splits image file into 'x' Mb? Mb spans. Use this to create a 'forced' size volume set. For example, if you would like to force smaller image files from a 1024 Megabyte drive, you could specify 200 megabyte segments. For example, ghost.exe -split=200 will divide the image into 200 Megabyte segments.
- sure use the -sure switch in conjunction with -clone to avoid being prompted with the final 'Proceed with disk clone destination drive will be overwritten?' question. This command is useful in batch mode.

Appendix

Example 1:

To copy drive one to drive two on a PC, without final prompt if OK to proceed.

```
ghost.exe -clone,mode=copy,src=1,dst=2 -sure
```

Example 2:

To connect via NetBIOS to another PC running Ghost in slave mode, and dump a disk image of local drive two to the remote file c:\drive2.gho

```
ghost.exe -clone,mode=dump,src=2,dst=C:\drive2.gho -nbm
```

Note: The slave Ghost can be started with ghost -nbs

Example 3:

To copy drive one, second partition on a PC to drive two, first partition the same PC, without final prompt

```
ghost.exe -clone,mode=pcopy,src=1:2,dst=2:1 -sure
```

Example 4:

To dump the second partition of drive one to an image file on a mapped drive g:

```
ghost.exe -clone,mode=pdump,src=1:2,dst=g:\part2.gho
```

Example 5:

To load partition 2 from a two-partition image file on a mapped drive g: onto the second partition of the local disk

```
ghost -clone,mode=pload,src=g:\part2.gho:2,dst=1:2
```

Example 6:

To load drive 2 from an image file and resize the destination partitions into a 20:40 allocation

```
ghost.exe -clone,mode=load,src=g:\2prtdisk.gho,dst=2,size1=60P,  
size2=40P
```

User Notice

No part of this product, including the product and software may be reproduced, transmitted, transcribed, stored in a retrieval system, or translated into any language in any form without the express written permission of EPoX Computer Company (hereinafter referred to as EPoX) except for documentation kept by the purchaser for backup purposes.

We provide this manual “as is” without warranty of any kind, either expressed or implied, including but not limited to the implied warranties or conditions of merchantability or fitness for a particular purpose. In no event shall EPoX be liable for any loss of profits, loss of business, loss of use or data, interruption of business or for indirect, special incidental, or consequential damages of any kind, even if EPoX has been advised of the possibility of such damages arising from any defect or error in the manual or product. EPoX may revise this manual from time to time without notice. For updated BIOS, drivers, or product release information you may visit our websites at <http://www.epox.com> or <http://www.epox.com.tw>.

Products mentioned in this manual are mentioned for identification purposes only. Product names appearing in this manual may or may not be registered trademarks or copyrights of their respective companies. **The product name and revision number are both printed on the mainboard itself.**

Handling Procedures

Static electricity can severely damage your equipment. Handle the CU-133A/CU-133A+ and any other device in your system with extreme care and avoid unnecessary contact with system components on the mainboard. Always work on an antistatic surface to avoid possible damage to the mainboard from static discharge. Always have the power supply unplugged and powered off when inserting and removing devices within the computer chassis. EPoX assumes no responsibility for any damage to the CU-133A/CU-133A+ mainboard that results from failure to follow instruction or failure to observe safety precautions.



CAUTION



The CU-133A/CU-133A+ mainboard is subject to damage by static electricity. Always observe the handling procedures.

Technical Support Services

If you need additional information, help during installation or normal use of this product, please contact your retailer. Your retailer will have the most current information about your configuration. If your retailer cannot help, you may visit our online technical support website and/or contact our support technicians at the locations listed below.

Record your serial number before installing your CU-133A/CU-133A+ mainboard. (The serial number is located near the PCI slots at the edge of the board.)

CU-133A/CU-133A+ serial number: _____

Contacting Technical Support

EPoX technical support is working hard to answer all of your questions online. From our website you can find answers to many common questions, drivers, BIOS updates, tech notes, and important technical bulletins. If you are still unable to locate the solution you are seeking, you always have the option to contact our support technicians directly.

North American website (English language)

<http://www.epox.com>

sales@epox.com

support@epox.com

European website (Multi-language)

<http://www.epox.nl>

sales@epox.nl

support@epox.nl

info@elito-epox.com

Taiwan website (Chinese language)

<http://www.epox.com.tw>

sales@epox.com.tw

support@epox.com.tw

Thank you for using EPoX mainboards!

Copyright 2001 EPoX Computer Company. All rights reserved.
