

P5BV3+/e

Rev. A+ System Board User's Manual

Copyright

This publication contains information that is protected by copyright. No part of it may be reproduced in any form or by any means or used to make any transformation/adaptation without the prior written permission from the copyright holders.

This publication is provided for informational purposes only. The manufacturer makes no representations or warranties with respect to the contents or use of this manual and specifically disclaims any express or implied warranties of merchantability or fitness for any particular purpose. The user will assume the entire risk of the use or the results of the use of this document. Further, the manufacturer reserves the right to revise this publication and make changes to its contents at any time, without obligation to notify any person or entity of such revisions or changes.

All Rights Reserved. © 1999

Trademarks

Microsoft® MS-DOS®, Windows™, Windows® 95 and Windows® 98 are registered trademarks of Microsoft Corporation. Intel, Pentium and Pentium with MMX technology are registered trademarks of Intel Corporation. Cyrix, 6x86L, 6x86MX and M II are registered trademarks of Cyrix Corporation. AMD, K5, K6, K6-2 and K-III are registered trademarks of Advanced Micro Devices, Inc. IBM 6x86MX is a registered trademark of International Business Machine Corporation. IDT C6, WinChip2 and WinChip3 are registered trademarks of IDT Corporation. Award is a registered trademark of Award Software, Inc. Other trademarks and registered trademarks of products appearing in this manual are the properties of their respective holders.

Caution:

Danger of explosion if battery incorrectly replaced.

Replace only with the same or equivalent type recommended by the manufacturer:

Dispose of used batteries according to the battery manufacturer's instructions.

FCC and DOC Statement on Class B

This equipment has been tested and found to comply with the limits for a Class B digital device, pursuant to Part 15 of the FCC rules. These limits are designed to provide reasonable protection against harmful interference when the equipment is operated in a residential installation. This equipment generates, uses and can radiate radio frequency energy and, if not installed and used in accordance with the instruction manual, may cause harmful interference to radio communications. However, there is no guarantee that interference will not occur in a particular installation. If this equipment does cause harmful interference to radio or television reception, which can be determined by turning the equipment off and on, the user is encouraged to try to correct the interference by one or more of the following measures:

- Reorient or relocate the receiving antenna.
- Increase the separation between the equipment and the receiver.
- Connect the equipment into an outlet on a circuit different from that to which the receiver is connected.
- Consult the dealer or an experienced radio TV technician for help.

Notice:

1. The changes or modifications not expressly approved by the party responsible for compliance could void the user's authority to operate the equipment.
2. Shielded interface cables must be used in order to comply with the emission limits.

Table of Contents

Chapter 1 - Introduction

1.1 Features and Specifications	6
1.2 Package Checklist	9

Chapter 2 - Hardware Installation

2.1 System Board Layout	10
2.2 System Memory	11
2.3 DIP Switch Settings of the Processors	11
2.4 Jumper Settings for Clearing CMOS Data	18
2.5 Jumper Settings for SDRAM Clock (DIMM)	19
2.6 Connecting the Ribbon Cables and Wires of the Ports and Connectors	20

Chapter 3 - Award BIOS Setup Utility

3.1 The Basic Input/Output System	28
3.1.1 Standard CMOS Setup	28
3.1.2 BIOS Features Setup	31
3.1.3 Chipset Features Setup	35
3.1.4 Power Management Setup	36
3.1.5 PNP/PCI Configuration	38
3.1.6 Load Fail-Safe Settings	40
3.1.7 Load Optimal Settings	40
3.1.8 Integrated Peripherals	41
3.1.9 Supervisor Password	44
3.1.10 User Password	45
3.1.11 IDE HDD Auto Detection	45
3.1.12 Save & Exit Setup	46
3.1.13 Exit Without Saving	46

Chapter 4 - Supported Softwares

4.1 Desktop Management Interface	47
4.2 Drivers	50

Appendix A - Identifying Processors

A.1 Intel Processors	51
A.2 Cyrix Processors	51
A.3 IBM Processors	52
A.4 AMD Processors	52
A.5 IDT Processors	53

Appendix B - System Error Messages

B.1 POST Beep	54
B.2 Error Messages	54

Appendix C - Troubleshooting

C.1 Troubleshooting Checklist	56
-------------------------------------	----

Chapter 1 - Introduction

1.1 Features and Specifications

1.1.1 Features

Chipset

- VIA® Apollo 598MVP AGP system chipset

Processor

The system board is equipped with a 321-pin ZIF socket (Super Socket 7). It is also equipped with a switching voltage regulator that supports 2.0V to 3.5V core voltage for various processors.

- AMD® K5 PR90/PR100/PR120/PR133/PR166, K6-166/200/233/266/300, K6-2/250/266/300/333/350/366/380/400/450 or K6-III/400
- Intel Pentium® 90/100/120/133/150/166/200MHz or Intel Pentium® processor with MMX™ technology-166/200/233MHz
- Cyrix® 6x86L PR150+/PR166+/PR200+, 6x86MX-PR166/PR200/PR233/PR266 or M II-200/266/300/333/366/380/400
- IBM® 6x86MX-PR200/PR233/PR266/PR300/PR333
- IDT® C6-180/200/225/240, WinChip2-200/225/233/240/266/300 or future WinChip3 series

System Memory

- 16MB to 256MB memory using unbuffered DIMMs
- Two 168-pin DIMM sockets using x64 SDRAM, 3.3V
- PC-100 SDRAM DIMM for 100MHz external system bus clock processors

DIMMs	Memory Size
2MBx64	16MB
4MBx64	32MB
8MBx64	64MB
16MBx64	128MB

Level 2 Cache Memory

- 512KB pipeline burst, direct map write-through cache installed on the system board.

Expansion Slots

The system board is equipped with 1 dedicated AGP slot. AGP is an interface designed to support high performance 3D graphics cards. It utilizes a dedicated pipeline to access system memory for texturing, z-buffering and alpha blending; delivering up to 533MB/sec. bandwidth for 3D graphics applications. AGP in this system board will deliver faster and better graphics with your PC.

The system board is equipped with 1 dedicated AGP slot, 2 dedicated PCI slots, 1 dedicated 16-bit ISA slot and 1 shared PCI/ISA slot. All PCI and ISA slots are bus masters.

Desktop Management Interface (DMI)

The system board comes with a DMI 2.0 built into the BIOS. The DMI utility in the BIOS automatically records various information about your system configuration and stores these information in the DMI pool, which is a part of the system board's Plug and Play BIOS. DMI, along with the appropriately networked software, is designed to make inventory, maintenance and troubleshooting of computer systems easier. Refer to Chapter 4 for instructions on using the DMI utility.

Connectors

- 2 connectors for external USB ports
- 1 connector for IrDA interface
- 2 serial ports
- 1 parallel port
- 2 IDE connectors
- 1 floppy connector
- 1 PS/2 mouse port
- 1 PS/2 or AT keyboard port
- 1 12-pin standard AT power supply connector
- 1 fan connector for CPU fan

PCI Bus Master IDE Controller

- Two PCI IDE interfaces support up to four IDE devices
- Ultra DMA/33 supported (Synchronous Ultra DMA mode - data transfer rate up to a maximum of 33MB/sec.)
- PIO Mode 3 and Mode 4 Enhanced IDE (data transfer rate up to 16.6MB/sec.)
- Bus mastering reduces CPU utilization during disk transfer
- ATAPI CD-ROM, LS-120, ZIP supported and SCSI sequential boot-up.

IrDA Interface

The system board is equipped with an IrDA connector for wireless connectivity between your computer and peripheral devices. It supports infrared peripheral devices that meet the ASKIR or HPSIR standard.

USB Ports

The system board is equipped with two connectors for external USB ports. USB allows data exchange between your computer and a wide range of simultaneously accessible external Plug and Play peripherals.

BIOS

- Award BIOS, Windows® 95/98 Plug and Play compatible
- Flash EPROM for easy BIOS upgrades
- 1MB flash memory (2MB - optional, includes SDMS function)

1.1.2 Intelligence

Virus Protection

Most viruses today destroy data stored in hard drives. The system board is designed to protect the boot sector and partition table of your hard disk drive.

I.2 Package Checklist

The system board package contains the following items:

- The system board
- A user's manual
- Serial, mouse and printer port cables
 - Option 1:
 - One card-edge bracket with a 9-pin and 25-pin serial port cables
 - One card-edge bracket with a 25-pin printer port cable and a PS/2 mouse port cable
 - Option 2:
 - One card-edge bracket with two 9-pin serial port cables and a PS/2 mouse port cable
 - One 25-pin printer port cable for chassis mounting
- One 40-pin IDE hard disk cable
- One 34-pin floppy disk drive cable
- One CD
- One card-edge bracket with two USB ports (optional)

If any of these items are missing or damaged, please contact your dealer or sales representative for assistance.

Chapter 2 - Hardware Installation

2.1 System Board Layout

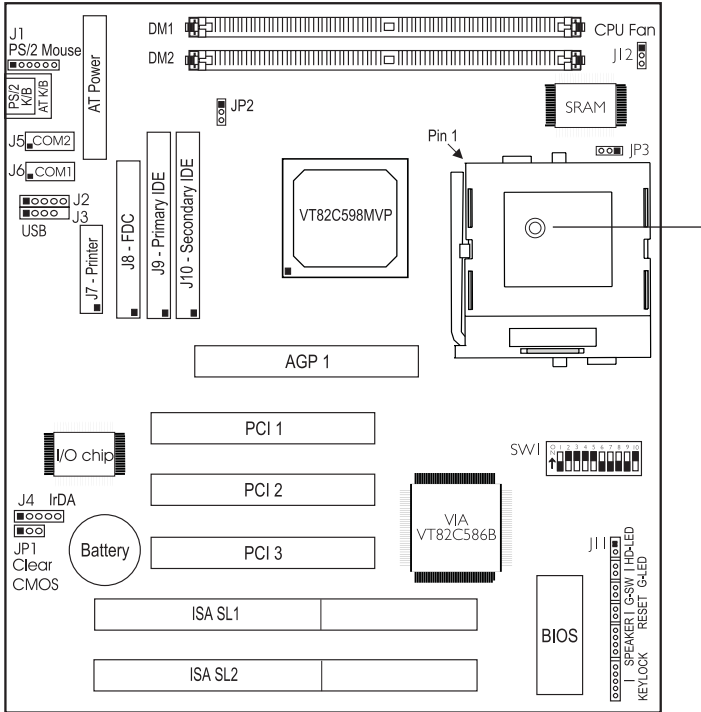

■ Square denotes pin 1

Mounting hole used for installing a mounting screw to secure the system board to the chassis.



Warning:

Remember to remove the mounting screw located underneath the processor prior to removing the system board from the chassis. To access the mounting screw, you must first loosen the fan/heatsink and remove the processor.

2.2 System Memory

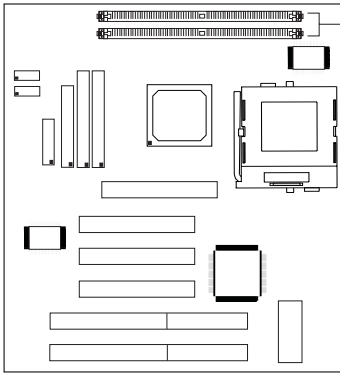

DIMM sockets



Important:

If you are using a 100MHz external system bus clock processor, make sure that you use PC-100 SDRAM DIMM **ONLY**. Just in case you encounter compatibility problems, we recommend that you try setting the SDRAM clock according to the AGP clock (JP2 pins 1 and 2 On). This may help solve some compatibility problems.

2.3 DIP Switch Settings of the Processors

Make sure SW1 and JP3 are set correctly before applying power or you may damage the processor or system board. There are 10 switches on SW1. The black rectangle in the diagram denotes the part that is protruding, the “adjustable” switch.

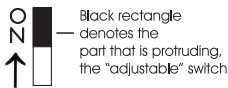

In the example on the left:

- Switch 1: Off
- Switch 2: On
- Switch 3: On
- Switch 4: On
- Switch 5: On
- Switch 6: Off
- Switch 7: Off
- Switch 8: Off
- Switch 9: Off
- Switch 10: On

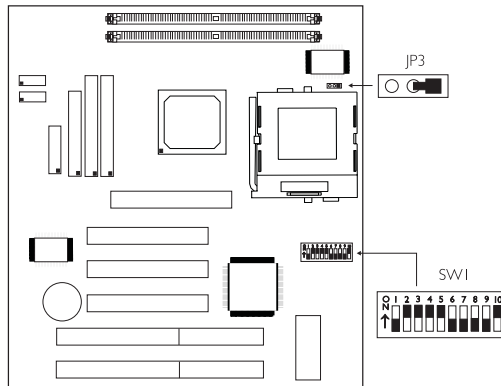

DIP Switch Settings for Intel Processors







Intel Processors	SW1: 1-6	Intel Processors	SW1: 1-6
90MHz - 60MHz - 1.5x		166MHz - 66MHz - 2.5x	
100MHz - 66MHz - 1.5x		200MHz - 66MHz - 3x	
120MHz - 60MHz - 2x		MMX166MHz* - 66MHz - 2.5x	
133MHz - 66MHz - 2x		MMX200MHz - 66MHz - 3x	
150MHz - 60MHz - 2.5x		MMX233MHz - 66MHz - 3.5x	

* Default



















DIP Switch Settings for IDT Processors

IDT Processors	SW1: 1-6	IDT Processors	SW1: 1-6
C6-180 - 60MHz - 3x		WinChip2-225 - 75MHz - 3x	
C6-200 - 66MHz - 3x		WinChip2-233 - 66MHz - 3.5x	
C6-225 - 75MHz - 3x		WinChipP2-240 - 60MHz - 4x	
C6-240 - 60MHz - 4x		WinChip2-266 - 100MHz - 2.33x	
WinChip2-200 - 66MHz - 3x		WinChip2-300 - 100MHz - 2.5x	



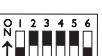















DIP Switch Settings for IBM Processors

IBM Processors	SW1: 1-6	IBM Processors	SW1: 1-6
6x86MX-PR200 - 66MHz - 2.5x		6x86MX-PR300 - 66MHz - 3.5x	
6x86MX-PR233 - 75MHz - 2.5x		6x86MX-PR300 - 75MHz - 3x	
6x86MX-PR266 - 83MHz - 2.5x		6x86MX-PR333 - 83MHz - 3x	

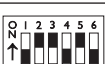
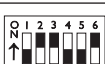
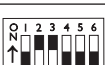
DIP Switch Settings for Cyrix Processors

Cyrix Processors	SW1: 1-6	Cyrix Processors	SW1: 1-6
6x86L PR150+ - 60MHz - 2x		M II-300 - 66MHz - 3.5x	
6x86L PR166+ - 66MHz - 2x		M II-300 - 75MHz - 3x	
6x86L PR200+ - 75MHz - 2x		M II-333 - 66MHz - 4x	
6x86MX-PR166 - 60MHz - 2.5x		M II-333 - 75MHz - 3.5x	
6x86MX-PR200 - 66MHz - 2.5x		M II-333 - 83MHz - 3x	
6x86MX-PR233 - 75MHz - 2.5x		M II-366 - 83MHz - 3.5x	
6x86MX-PR266 - 83MHz - 2.5x		M II-366 - 100MHz - 2.5x	
M II-200 - 66MHz - 2.5x		M II-380 - 100MHz - 3x	
M II-266 - 66MHz - 3x		M II-400 - 95MHz - 3.5x	

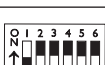
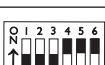
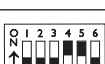





DIP Switch Settings for AMD Processors

AMD Processors	SW1: 1-6	AMD Processors	SW1: 1-6
K5 PR90 - 60MHz - 1.5x		K6-2/266 - 66MHz - 4x	
K5 PR100 - 66MHz - 1.5x		K6-2/300 - 66MHz - 4.5x	
K5 PR120 - 60MHz - 2x		K6-2/300 - 100MHz - 3x	
K5 PR133 - 66MHz - 2x		K6-2/333 - 66MHz - 5x	
K5 PR166 - 66MHz - 2.5x		K6-2/333 - 95MHz - 3.5x	
K6-166 - 66MHz - 2.5x		K6-2/350 - 100MHz - 3.5x	
K6-200 - 66MHz - 3x		K6-2/366 - 66MHz - 5.5x	
K6-233 - 66MHz - 3.5x		K6-2/380 - 95MHz - 4x	
K6-266 - 66MHz - 4x		K6-2/400 - 100MHz - 4x	
K6-300 - 66MHz - 4.5x		K6-2/450 - 100MHz - 4.5x	
K6-2/250 - 100MHz - 2.5x		K6-III/400 - 100MHz - 4x	

External System Bus Clock / Frequency Ratio - DIP Switch Settings

If the processor you are using is not included in the previous tables, please refer to the following tables and set SW1 according to the external system bus clock and frequency ratio of your processor.

External System Bus Clock Settings









External System Bus Clock	SW1: 1-3	External System Bus Clock	SW1: 1-3
60MHz		83MHz	
66MHz		95MHz	
75MHz		100MHz	











Warning:

We do not guarantee that 75MHz, 83MHz, 95MHz and 100MHz external system bus clock processors will work with all types of add-in cards, memory modules or other devices.

































Frequency Ratio Settings for Intel, IBM, Cyrix and AMD Processors

Frequency Ratio	SW1: 4-6	Frequency Ratio	SW1: 4-6
1.5x / 3.5x		4x	
2x		4.5x	
2.5x		5x	
3x		5.5x	

Frequency Ratio Settings for IDT Processors

Frequency Ratio	SW1: 4-6	Frequency Ratio	SW1: 4-6
3.5x		4x	
2x/3.3x		4.5x	
2.5x		2.33x/5x	
3x		2.66x/5.5x	

DIP Switch and Jumper Settings for Core Voltage

Voltage	JP3	SW1: 7-10	Voltage	JP3	SW1: 7-10
2.0V			2.8V*		
2.1V			2.9V		
2.2V			3.0V		
2.3V			3.1V		
2.4V			3.2V		
2.5V			3.3V		
2.6V			3.4V		
2.7V			3.5V		

* Default

2.4 Jumper Settings for Clearing CMOS Data

Jumper JPI

Clear CMOS Data

If, for some reason, the CMOS data becomes corrupted, the system can be reconfigured with the default values stored in the ROM BIOS. To load the default values, power off your system. Set JPI pins 1 and 2 to On. Wait for a few seconds and set JPI back to its default setting, pins 2 and 3 On. You may now power-on your system.

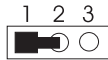
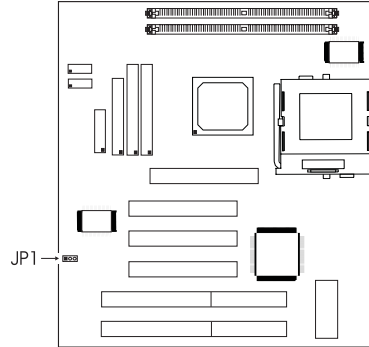

1-2 On:
Clear CMOS Data

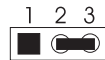

2-3 On: Normal
(default)

2.5 Jumper Settings for SDRAM Clock (DIMM)

Jumper JP2

SDRAM Clock

JP2 is used to set the SDRAM's clock according to the CPU clock or AGP clock. If you are using PC SDRAM DIMMs, it is recommended that you set the SDRAM clock according to the CPU clock (2-3 On). This setting will provide better system performance specially when used with 75/83/95/100MHz

processors. However, if you encounter compatibility problems with PC-100 SDRAM DIMMs or you are using EDO/PC-66 SDRAM DIMMs, set the SDRAM clock according to the AGP clock (1-2 On).

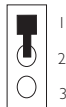
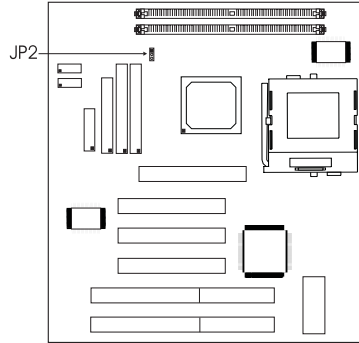

1-2 On:
SDRAM CLK = AGP CLK
(default)

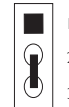

2-3 On:
SDRAM CLK = CPU CLK

↓

CPU CLK	SDRAM CLK	AGP CLK
60MHz	60MHz	60MHz
66MHz	66MHz	66MHz
75MHz	60MHz	60MHz
83MHz	66MHz	66MHz
95MHz	66MHz	66MHz
100MHz	66MHz	66MHz

↓

CPU CLK	SDRAM CLK	AGP CLK
60MHz	60MHz	60MHz
66MHz	66MHz	66MHz
75MHz	75MHz	60MHz
83MHz	83MHz	66MHz
95MHz	95MHz	66MHz
100MHz	100MHz	66MHz

2.6 Connecting the Ribbon Cables and Wires of the Ports and Connectors

2.6.1 Serial Ports

The built-in serial ports are RS-232C asynchronous communication ports with 16C550A-compatible UARTs that can be used with modems, serial printers, remote display terminals, and other serial devices. You can set the serial ports' I/O address in the Integrated Peripherals setup of the Award BIOS.

Connecting the Serial Ports

Two serial port cables mounted on a card-edge bracket are provided with the system board. Connect one serial port cable to connector J6 for COM 1 primary serial port and the other serial port cable to connector J5 for the COM 2 secondary serial port. Make sure the colored stripes on the ribbon cables are aligned with pins 1 of connectors J5 and J6. Mount the card-edge bracket to the system chassis.

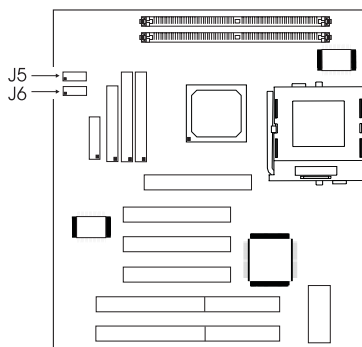

2.6.2 PS/2 Mouse Port

The PS/2 mouse port is a 6-pin connector on the system board. Attach the 6-pin mouse port cable, which is mounted on a card-edge bracket, to connector J1. Make sure the red wire on the PS/2 mouse connector is aligned with pin 1 of connector J1. Mount the card-edge bracket to the system chassis.

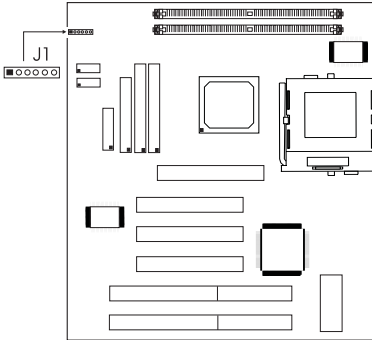

Pin	Function
1	Mouse Data
2	Reserved
3	Ground
4	+5V
5	Mouse Clock
6	Reserved

2.6.3 Parallel Port

The system board has a standard printer port for interfacing your PC to a parallel printer. It supports SPP, ECP and EPP modes. You can set the port's mode in the Integrated Peripherals setup of the Award BIOS.

Connecting the Parallel Printer Port

Attach the DB-25 printer port cable to connector J7 on the system board. Make sure the colored stripe on the ribbon cable aligns with pin 1 of J7. Use a small nutdriver to mount the cable into a DB-25 cutout in the system chassis. If your printer port cable is attached to a card-edge bracket, connect the cable to connector J7 on the system board and mount the card-edge bracket to the system chassis.

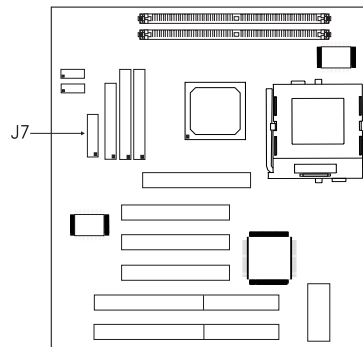

2.6.4 Floppy Disk Drive Controller

1. Install the 34-pin header connector into the shrouded floppy disk header (J8) on the system board. The colored edge of the ribbon should be aligned with pin 1 of connector J8.

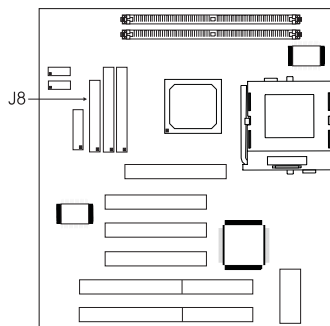

2. Install the other 34-pin header connector(s) into the disk drive(s). Align the colored edge of the daisy chained ribbon cable with pin 1 of the drive edge connector(s). The end-most connector should be attached to the drive you want to designate as Drive A.

2.6.5 IDE Hard Disk Interface

1. If you are connecting two hard drives, install the 40-pin connector of the IDE cable into the primary shrouded IDE header (connector J9). If you are adding a third or fourth IDE device, install the 40-pin connector of the other IDE cable into the secondary shrouded IDE header (connector J10).

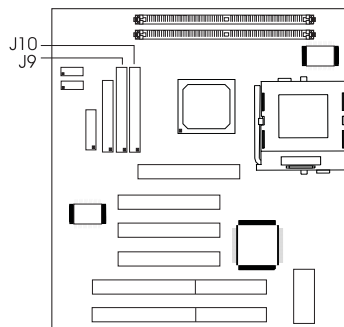

2. Install the other 40-pin header connector(s) into the device with the colored edge of the ribbon cable aligned with pin 1 of the drive edge connector(s).



Note:

Refer to your disk drive user's manual for information about selecting proper drive switch settings.

Adding a Second IDE Hard Drive

When using two IDE drives, one must be set as the master and the other as the slave. Follow the instructions provided by the drive manufacturer for setting the jumpers and/or switches on the drives.

We recommend that you use Enhanced IDE or ATA-2, ATA-3 and Ultra DMA hard drives be from the same manufacturer. In a few cases, drives from two different manufacturers will not function properly when used together. The problem lies in the hard drives, not the system board.



Important:

If you encountered problems while using an ATAPI CD-ROM drive that is set in Master mode, please set the CD-ROM drive to Slave mode. Some ATAPI CD-ROMs may not be recognized and cannot be used if incorrectly set in Master mode.

2.6.6 Universal Serial Bus Ports

The system board is equipped with two headers, at locations J2 and J3 on the system board, for external USB ports. USB allows data exchange between your computer and a wide range of simultaneously accessible external Plug and Play peripherals.

You must have the proper drivers installed in your operating system to use these ports. Refer to your operating system's manual or documentation.

Pin	J2	J3
1	+5V	+5V
2	-Data	-Data
3	+Data	+Data
4	Ground	Ground
5	Ground	Key

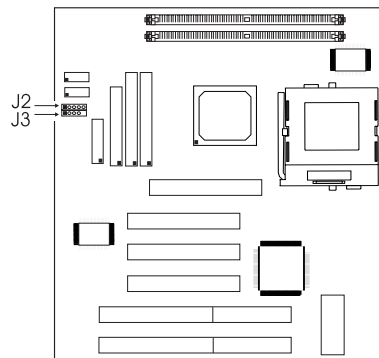

Connecting the USB Ports

As an option, one card-edge bracket mounted with two USB port cables may be provided with the system board. The ends of the cables are attached to a connector. Connect the USB cable connector to J2 and J3 on the system board. The USB port cables can be inserted only if pin 1 of the cable (red wire) is aligned with pin 1 of J2 and J3. Pin 5 of J3 has been removed and the hole in the USB cable connector, which corresponds to pin 5, has been plugged to prevent incorrectly inserting the connector. Mount the card-edge bracket to the system chassis.

2.6.7 IrDA Connector

The system board is equipped with an IrDA connector for wireless connectivity between your computer and peripheral devices. Connect your IrDA cable to connector J4 on the system board. Make sure "Onboard UART 2 Mode" in the Integrated Peripherals setup of the Award BIOS is set to the type of IrDA standard supported by your IrDA peripheral/device.

You must have the proper drivers installed in your operating system to use this connector. Refer to your operating system's manual or documentation.

Pin	Function
1	IRTX
2	GND
3	IRRX
4	IRR3
5	VCC

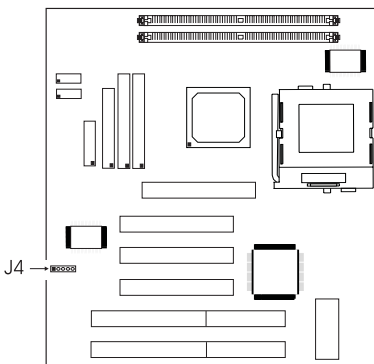
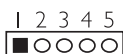

2.6.8 CPU Fan Connector

The processor must be kept cool by using a fan with heatsink. Connect the CPU fan to the 3-pin fan connector at location J12 on the system board.

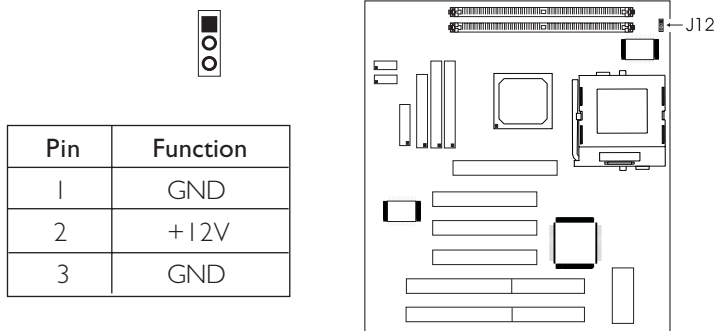

Important:

There are 2 points to consider prior to installing an AGP card into the AGP slot.

1. The length of the AGP card must not exceed 16.5cm. You will not be able to install a card longer than this length because of the processor/fan/heatsink located near the AGP slot.
2. When you install the AGP card and it hits the fan/heatsink, it may be that the clip of the heatsink on this side is too high. Try to re-orient the fan/heatsink so that the lower clip of the heatsink is on the side closest to the AGP slot.

2.6.9 J11 (LEDs and Switches)

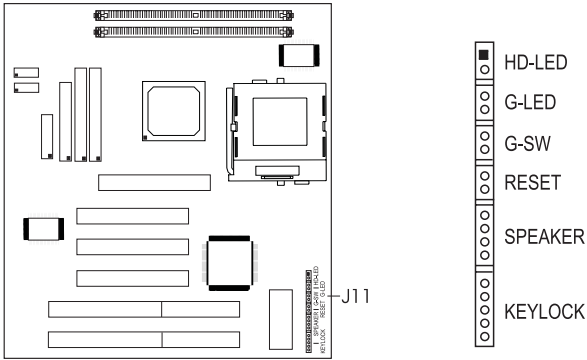

HD-LED - Primary/Secondary IDE LED

This LED will light when the hard drive is being accessed.

G-LED - Green LED

This LED will light when the system is in the Suspend mode.

G-SW - Green Switch

This switch will allow your system to enter the Suspend mode. To wake up the system, "PM Events" in the Power Management Setup (Chapter 3) must be enabled so that access to the specified IRQ will allow the system to wake up completely from the Suspend mode.

RESET - Reset Switch

This switch allows you to reboot without having to power off the system thus prolonging the life of the power supply or system.

SPEAKER - Speaker Connector

This connects to the speaker installed in the system chassis.

KEYLOCK - Keylock and Power LED Connector

This is used to connect to the keyboard lock (located on the front panel of the system chassis) for locking the keyboard. **Use pins 18 to 20 to connect to the Power LED.**

	Pin	Pin Assignment
HD-LED (Primary/Secondary IDE LED)	1	HDD
	2	HDD LED Power
	3	N. C.
G-LED (Green LED)	4	Green LED Power
	5	Green
	6	N. C.
G-SW (Green switch)	7	SMI
	8	Ground
	9	N. C.
RESET (Reset switch)	10	H/W Reset
	11	Ground
	12	N. C.
SPEAKER (Speaker connector)	13	Speaker Power
	14	Ground
	15	N. C.
	16	Speaker
	17	N. C.
KEYLOCK (Keylock and Power LED connector)	18	LED Power
	19	N.C.
	20	Ground
	21	Keylock
	22	Ground
		Use pins 18 to 20 for the Power LED.

Chapter 3 - Award BIOS Setup Utility

3.1 The Basic Input/Output System

The Basic Input/Output System (BIOS) is a program that takes care of the basic level of communication between the processor and peripherals. In addition, the BIOS also contain codes for various advanced features found in this system board. This chapter explains the Setup Utility for the Award BIOS.

After you power up your system, the BIOS message appears on your screen and the memory count begins. After the memory test, the following message will appear on the screen:

Press DEL to enter setup

If the message disappears before you respond, restart your system or press the "Reset" button. You may also restart the system by pressing the <Ctrl> <Alt> and keys simultaneously.

When you press , the main program screen will appear:

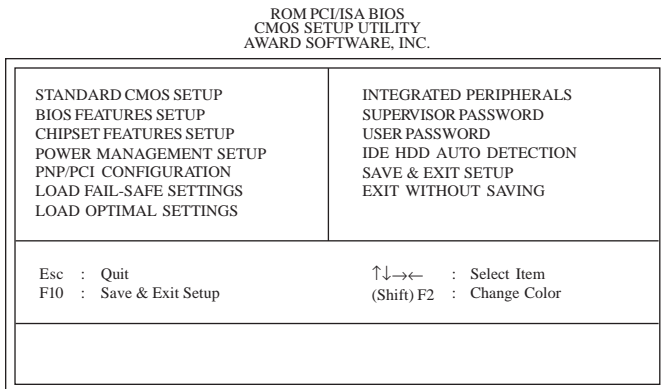

3.1.1 Standard CMOS Setup

Use the arrow keys to highlight "Standard CMOS Setup" and press <Enter>. A screen similar to the one on the next page will appear:

ROM PCI/ISA BIOS
STANDARD CMOS SETUP
AWARD SOFTWARE, INC.

Date (mm:dd:yy) : Thu, Jan 1 1998							
Time (hh:mm:ss) : 20 : 10 : 28							
HARD DISKS	TYPE	SIZE	CYLS	HEAD	PRECOMP	LANDZ	SECTOR MODE
Primary Master	: Auto	0	0	0	0	0	0 Auto
Primary Slave	: Auto	0	0	0	0	0	0 Auto
Secondary Master	: Auto	0	0	0	0	0	0 Auto
Secondary Slave	: Auto	0	0	0	0	0	0 Auto
Drive A : 1.44M, 3.5 in.							
Drive B : None							
Video : EGA/VGA						Base Memory : 640K	
Halt on : All Errors						Extended Memory : 130048K	
						Other Memory : 384K	
						Total Memory : 131072K	
Esc : Quit		↑↓→← : Select Item			PU/PD/+/- : Modify		
F1 : Help		(Shift)F2 : Change Color					

The settings on the screen are for reference only. Your version may not be identical to this one.

Date

The date format is <day>, <month>, <date>, <year>. Day displays a day, from Sunday to Saturday. Month displays the month, from January to December. Date displays the date, from 1 to 31. Year displays the year, from 1994 to 2079.

Time

The time format is <hour>, <minute>, <second>. The time is based on the 24-hour military-time clock. For example, 1 p.m. is 13:00:00. Hour displays hours from 00 to 23. Minute displays minutes from 00 to 59. Second displays seconds from 00 to 59.

Primary Master, Primary Slave, Secondary Master and Secondary Slave

These categories allow you to enter the appropriate specifications for the type of hard disk drive(s) installed in your system. Press <PgUp> or <PgDn> to select a numbered hard disk type or type the number and press <Enter>. The hard disk will not work properly if you enter improper information for this category. You can use Type "User" to define your own drive type manually. This information should be included in the documentation from your hard disk vendor. If you select Type "Auto", the BIOS will auto-detect the HDD & CD-ROM drive at the POST stage and show the IDE for the HDD & CD-ROM drive. If a hard disk has not been installed, select "None" and press <Enter>.

Drive A and Drive B

These categories identify the types of floppy disk drives installed.

<i>None</i>	No floppy drive is installed
<i>360K, 5.25 in.</i>	5-1/4 in. standard drive; 360KB capacity
<i>1.2M, 5.25 in.</i>	5-1/4 in. AT-type high-density drive; 1.2MB capacity
<i>720K, 3.5 in.</i>	3-1/2 in. double-sided drive; 720KB capacity
<i>1.44M, 3.5 in.</i>	3-1/2 in. double-sided drive; 1.44MB capacity
<i>2.88M, 3.5 in.</i>	3-1/2 in. double-sided drive; 2.88MB capacity

Video

This category selects the type of video adapter used for the primary system monitor. Although secondary monitors are supported, you do not have to select the type in Setup. The default setting is EGA/VGA (BIOS default, Setup default).

<i>EGA/VGA</i>	Enhanced Graphics Adapter/Video Graphics Array. For EGA, VGA, SVGA and PGA monitor adapters.
<i>CGA 40</i>	Color Graphics Adapter. Power up in 40-column mode.
<i>CGA 80</i>	Color Graphics Adapter. Power up in 80-column mode.
<i>Mono</i>	Monochrome adapter. Includes high resolution monochrome adapters.

Halt On

This category determines whether the system will stop if an error is detected during power up. The default setting is All Errors (BIOS default, Setup default).

<i>No Errors</i>	The system boot will not stop for any errors detected.
<i>All Errors</i>	The system boot will stop whenever the BIOS detects a non-fatal error.
<i>All, But Keyboard</i>	The system boot will not stop for a keyboard error; it will stop for all other errors.
<i>All, But Diskette</i>	The system boot will not stop for a disk error; it will stop for all other errors.
<i>All, But Disk/Key</i>	The system boot will not stop for a disk or keyboard error; it will stop for all other errors.

3.1.2 BIOS Features Setup

The BIOS Features Setup allows you to configure your system for basic operation. Some entries are defaults required by the system board, while others, if enabled, will improve the performance of your system or let you set some features according to your preference.

ROM PCI/ISA BIOS BIOS FEATURES SETUP AWARD SOFTWARE, INC.			
Virus Warning	: Disabled	Video BIOS Shadow	: Enabled
CPU Internal Cache	: Enabled	C8000-CBFFF Shadow	: Disabled
External Cache	: Enabled	CC000-CFFFF Shadow	: Disabled
Quick Power On Self Test	: Enabled	D0000-D3FFF Shadow	: Disabled
Boot Sequence	: A, C, SCSI	D4000-D7FFF Shadow	: Disabled
Swap Floppy Drive	: Disabled	D8000-DBFFF Shadow	: Disabled
Boot Up Floppy Seek	: Disabled	DC000-DFFFF Shadow	: Disabled
Boot Up NumLock Status	: On		
Typematic Rate Setting	: Disabled		
Typematic Rate (Chars/Sec)	: 6		
Typematic Delay (Msec)	: 250		
Security Option	: Setup		
PCI/VGA Palette Snoop	: Disabled	ESC : Quit	↑↓←→ : Select Item
OS Select For DRAM > 64MB	: Non-OS2	F1 : Help	PU/PD/+/- : Modify
HDD S.M.A.R.T. Capability	: Disabled	F5 : Old Values (Shift) F2	: Color
		F6 : Load Fail-Safe Settings	
		F7 : Load Optimal Settings	

The settings on the screen are for reference only. Your version may not be identical to this one.

Virus Warning

This category protects the boot sector and partition table of your hard disk drive. When this item is enabled, the Award BIOS will monitor the boot sector and partition table of the hard disk drive. If an attempt is made to write to the boot sector or partition table of the hard disk drive, the BIOS will halt the system and an error message will appear.

After seeing the error message, if necessary, you will be able to run an anti-virus program to locate and remove the problem before any damage is done.

Many disk diagnostic programs which attempt to access the boot sector table will cause the warning message to appear. If you are running such a program, we recommend that you first disable this category. Also, disable this category if you are installing or running certain operating systems like Windows® 95 or the operating system may not install nor work.

CPU Internal Cache and External Cache

These categories speed up the memory access. The default value is enabled. Enable the External Cache for better performance.

Quick Power On Self Test

This category speeds up Power On Self Test (POST) after you power on your system. When Enabled, the BIOS will shorten or skip some check items during POST.

Boot Sequence

This category determines which drive to search first for the disk operating system. The default is A, C, SCSI. The options are:

<i>A, C, SCSI;</i>	<i>C, A, SCSI;</i>	<i>C, CDROM, A;</i>	<i>CDROM, C, A;</i>
<i>D, A, SCSI;</i>	<i>E, A, SCSI;</i>	<i>F, A, SCSI;</i>	<i>SCSI, A, C;</i>
<i>SCSI, C, A;</i>	<i>C only;</i>	<i>LSI/ZIP, C.</i>	

Swap Floppy Drive

When this option is enabled and the system is booting from the floppy drive, the system will boot from drive B instead of drive A. When this option is disabled and the system is booting from the floppy drive, the system will boot from drive A. You must have two floppy drives to use this function.

Boot Up Floppy Seek

When enabled, the BIOS will check whether the floppy disk drive installed is 40 or 80 tracks. Note that the BIOS cannot distinguish between 720K, 1.2M, 1.44M and 2.88M drive types as they are all 80 tracks. When disabled, the BIOS will not search for the type of floppy disk drive by track number. Note that there will not be any warning message if the drive installed is 360KB.

Boot Up NumLock Status

This allows you to determine the default state of the numeric keypad. By default, the system boots up with NumLock on wherein the function of the numeric keypad is the number keys. When set to Off, the function of the numeric keypad is the arrow keys.

Typematic Rate Setting

When disabled, continually holding down a key on your keyboard will cause the BIOS to report that the key is down. When the typematic rate is enabled, the BIOS will not only report that the key is down, but will first wait for a moment, and, if the key is still down, it will begin to report that the key has been depressed repeatedly. For example, you would use such a feature to accelerate cursor movements with the arrow keys.

Typematic Rate (Chars/Sec)

This selection allows you to select the rate at which the keys are accelerated.

Typematic Delay (Msec)

This selection allows you to select the delay between when the key was first depressed and when the acceleration begins.

Security Option

System The system will not boot and access to Setup will be denied if the correct password is not entered at the prompt.

Setup The system will boot, but access to Setup will be denied if the correct password is not entered at the prompt.

PCI/VGA Palette Snoop

It determines whether the MPEG ISA/VESA VGA Cards can work with PCI/VGA or not. The default value is Disabled.

Enabled PCI/VGA working with MPEG ISA/VESA VGA cards.

Disabled PCI/VGA not working with MPEG ISA/VESA VGA cards.

OS Select for DRAM > 64MB

This item allows you to access the memory that is over 64MB in OS/2. The options are: Non-OS/2 and OS/2.

HDD S.M.A.R.T. Capability

The system board supports SMART (Self-Monitoring, Analysis and Reporting Technology) hard drives. SMART is a reliability prediction technology for ATA/IDE and SCSI drives. The drive will provide sufficient notice to the system or user to backup data prior to the drive's failure. The default is Disabled. If you are using hard drives that support S.M.A.R.T., set this field to Enabled. SMART is supported in ATA-3 or later hard drives.

Video BIOS Shadow

Determines whether video BIOS will be copied to RAM. Video Shadow will increase the video speed. Note that some graphics boards require that this option be disabled. The default value is Enabled.

Enabled Video shadow is enabled.

Disabled Video shadow is disabled.

C8000-CBFFF Shadow to DC000-DFFFF Shadow

These categories determine whether option ROMs will be copied to RAM.

Enabled Optional shadow is enabled.

Disabled Optional shadow is disabled.

3.1.3 Chipset Features Setup

ROM PCI/ISA BIOS
CHIPSET FEATURES SETUP
AWARD SOFTWARE, INC.

DIMM 1 DRAM Timing	: Normal	CPU to PCI Write Buffer	: Enabled
DIMM 2 DRAM Timing	: Normal	PCI Dynamic Bursting	: Enabled
SDRAM CAS Latency	: 3	PCI Master 0 WS Write	: Enabled
SDRAM Bank Interleave	: Disabled	PCI Delay Transaction	: Enabled
DRAM Read Pipeline	: Enabled	PCI Master Read Prefetch	: Enabled
Cache Pipeline	: Enabled	PCI#2 Access #1 Retry	: Disabled
Video BIOS Cacheable	: Enabled	AGP Master 1 WS Write	: Disabled
System BIOS Cacheable	: Disabled	AGP Master 1 WS Read	: Disabled
Memory Hole at 15M-16M	: Disabled		
AGP Aperture Size (MB)	: 64		
AGP 2x Mode	: Disabled		
		ESC : Quit	↑ ↓ → ← : Select Item
		F1 : Help	PU/PD/+/- : Modify
		F5 : Old Values (Shift)	F2 : Color
		F6 : Load Fail-Safe Settings	
		F7 : Load Optimal Settings	

The settings on the screen are for reference only. Your version may not be identical to this one.

This section gives you functions to configure the system based on the specific features of the chipset. The chipset manages bus speeds and access to system memory resources. It also coordinates communications between the conventional ISA bus and the PCI bus. These items should not be altered unless necessary. Depending on your add-in cards, you may not or should not enable some of those features. The default settings have been chosen because they provide the best operating conditions for your system. The only time you might consider making any changes would be if you discovered some incompatibility or that data was being lost while using your system.

3.1.4 Power Management Setup

The Power Management Setup allows you to configure your system to most effectively save energy. If you like to use the soft power down feature of Windows 95, you must enable the Power Management below. Select Min. Power, Max. Power or User Defined. Either one can be used as long as it is NOT disabled.

ROM PCI/ISA BIOS POWER MANAGEMENT SETUP AWARD SOFTWARE, INC.			
Power Management	: User Define	** PM Events **	
PM Control by APM	: Yes	IRQ3 (COM 2)	: Primary
Video Off Method	: DPMS	IRQ4 (COM 1)	: Primary
Video Off After	: Suspend	IRQ5 (LPT 2)	: Primary
Standby Mode	: Disabled	IRQ6 (Floppy Disk)	: Primary
Suspend Mode	: Disabled	IRQ7 (LPT 1)	: Primary
HDD Power Down	: Disabled	IRQ8 (RTC Alarm)	: Disabled
		IRQ9 (IRQ2 Redir)	: Secondary
		IRQ10 (Reserved)	: Secondary
		IRQ11 (Reserved)	: Secondary
		IRQ12 (PS/2 Mouse)	: Secondary
		IRQ13 (Coprocessor)	: Primary
		IRQ14 (Hard Disk)	: Primary
		IRQ15 (Reserved)	: Disabled
		ESC : Quit	↑ ↓ → ← : Select Item
		F1 : Help	PU/PD/+/- : Modify
		F5 : Old Values (Shift)	F2 : Color
		F6 : Load Fail-Safe Settings	
		F7 : Load Optimal Settings	

The settings on the screen are for reference only. Your version may not be identical to this one.

Power Management

This category allows you to select the type (or degree) of power saving by changing the length of idle time that elapses before the Standby mode and Suspend mode are activated.

<i>Disable</i>	No power management. Disables the Standby and Suspend modes.
<i>Min. Power Saving</i>	Minimum power management. Standby Mode = 1 hr., and Suspend Mode = 1 hr.
<i>Max. Power Saving</i>	Maximum power management. Standby Mode = 1 min., and Suspend Mode = 1 min.
<i>User Define</i>	Allows you to set each mode individually. When enabled, each option ranges from 1 min. to 1 hr.

PM Control by APM

- Yes** An Advanced Power Management device will be activated to enhance the Max. Power Saving mode and stop the CPU's internal clock. Use this option in Windows® 95. (default)
- No** The system BIOS will ignore APM when initiating the Power Management mode.

Video Off Method

This determines the manner in which the monitor is blanked.

- VIH SYNC + Blank* This selection will cause the system to turn off the vertical and horizontal synchronization ports and write blanks to the video buffer.
- Blank Screen* This option only writes blanks to the video buffer.
- DPMS* Initializes display power management signaling. Use this option if your video board supports it.

Video Off After

- N/A* The system BIOS will never turn off the screen.
- Suspend* The screen is off when the system is in the Suspend mode.
- Standby* The screen is off when the system is in the Standby mode.

Standby Mode

This is user configurable only when the Power Management category is set to User Defined. When enabled and after the set time of system inactivity, the CPU clock will run at a slower speed (1/2 of full speed) while all other devices still operate at full speed.

Suspend Mode

This is user configurable only when the Power Management category is set to User Defined. When enabled and after the set time of system inactivity, the CPU and onboard peripherals will be shut off.

HDD Power Down

This is user configurable only when the Power Management category is set to User Define. When enabled and after the set time of system inactivity, the hard disk drive will be powered down while all other devices remain active.

PM Events

When enabled, access to the specified IRQ will cause the system to wake up completely from the power management mode. When disabled, the system will not wake up from the power management mode despite access to the specified IRQ.

3.1.5 PNP/PCI Configuration

This section describes configuring the PCI bus system. It covers some very technical items and it is strongly recommended that only experienced users should make any changes to the default settings.

ROM PCI/ISA BIOS PNP/PCI CONFIGURATION AWARD SOFTWARE, INC.			
Resources Controlled By	: Auto	PCI IRQ Activated By	: Level
Reset Configuration Data	: Disabled	Assign IRQ for VGA	: Enabled
		PCI Slot 1 Use IRQ	: Auto
		PCI Slot 2 Use IRQ	: Auto
		PCI Slot 3 Use IRQ	: Auto
		ESC : Quit	↑ ↓ → ← : Select Item
		F1 : Help	PU/PD/+/- : Modify
		F5 : Old Values (Shift)	F2 : Color
		F6 : Load Fail-Safe Settings	
		F7 : Load Optimal Settings	

The settings on the screen are for reference only. Your version may not be identical to this one.

Resources Controlled By

The Award Plug and Play BIOS has the capability to automatically configure all of the boot and Plug and Play compatible devices.

- Auto* The system will automatically detect the settings for you. The categories that follow will not be shown on the screen.
- Manual* This will allow you to set the IRQ/DMA (you have assigned your add-in card) to Legacy ISA or PCI/ISA PnP. For non-PnP ISA cards, select Legacy ISA. For PnP ISA or PCI cards, select PCI/ISA PnP.

Reset Configuration Data

- Enabled* The BIOS will reset the configuration data once automatically. It will then recreate a new set of configuration data.
- Disabled* The BIOS will not reset the configuration data.

PCI IRQ Activated By

This category is used to set the method by which the PCI bus recognizes that an IRQ service is being requested by a device. Under all circumstances, you should retain the default configuration unless a different setting is needed.

Assign IRQ for VGA

When Enabled, the system automatically assigns an IRQ for the VGA card installed. Your VGA card will need an IRQ only when using the video capture function of the card. If you are not using this function and a new device requires an IRQ, you can set this function to Disabled. The IRQ (previously occupied by the VGA card) will be available for your new device.



Note:

When Disabled, a "Yellow" mark will appear in Windows® 95's Device Manager.

PCI Slot 1 Use IRQ, PCI Slot 2 Use IRQ and PCI Slot 3 Use IRQ

By default, an IRQ will automatically be assigned to PCI slots 1, 2 and 3. You may manually assign an IRQ to these slots by selecting one of the available options.

3.1.6 Load Fail-Safe Settings

The “Load Fail-Safe Settings” option loads the troubleshooting default values permanently stored in the ROM chips. These settings are not optimal and turn off all high performance features. You should use these values only if you have hardware problems. Highlight this option on the main menu and press <Enter>. The message below will appear:

Load Fail-Safe Settings (Y/N)? N

If you want to proceed, type <Y> and press <Enter>. The default settings will be loaded.

3.1.7 Load Optimal Settings

The “Load Optimal Settings” option loads optimized settings from the BIOS ROM. Use the Setup default values as standard values for your system. Highlight this option on the main menu and press <Enter>. The message below will appear:

Load Optimal Settings (Y/N)? N

Type <Y> and press <Enter> to load the Setup default values.

3.1.8 Integrated Peripherals

ROM PCI/ISA BIOS INTEGRATED PERIPHERALS AWARD SOFTWARE, INC.	
Onboard Primary PCI IDE : Enabled	Onboard FDC Controller : Enabled
Onboard Secondary PCI IDE : Enabled	Onboard UART 1 : 3F8/IRQ4
IDE Prefetch Mode : Enabled	Onboard UART 2 : 2F8/IRQ3
IDE HDD Block Mode : Enabled	Onboard UART 2 Mode : Standard
IDE Primary Master PIO : Auto	
IDE Primary Slave PIO : Auto	
IDE Secondary Master PIO : Auto	Onboard Parallel Port : 378/IRQ7
IDE Secondary Slave PIO : Auto	Parallel Port Mode : ECP+EPP
IDE Primary Master UDMA : Auto	ECP Mode Use DMA : 3
IDE Primary Slave UDMA : Auto	Parallel Port EPP Type : EPP1.7
IDE Secondary Master UDMA : Auto	
IDE Secondary Slave UDMA : Auto	
USB Controller : Enabled	
USB Keyboard Support : Disabled	
ESC : Quit ↑ ↓ → ← : Select Item F1 : Help PU/PD/+/- : Modify F5 : Old Values (Shift) F2 : Color F6 : Load Fail-Safe Settings F7 : Load Optimal Settings	

The settings on the screen are for reference only. Your version may not be identical to this one.

Onboard Primary PCI IDE and Onboard Secondary PCI IDE

These categories allow you to enable or disable the primary and secondary IDE controller. The default is Enabled. Select Disabled if you want to add a different hard drive controller.

IDE Prefetch Mode

This allows data and addresses to be stored in the internal buffer of the chip, thus reducing access time. Enable this field to achieve better performance.

IDE HDD Block Mode

Enabled The IDE HDD uses the block mode. The system BIOS will check the hard disk drive for the maximum block size the system can transfer. The block size will depend on the type of hard disk drive.

Disabled The IDE HDD uses the standard mode.

IDE Primary Master/Slave PIO and IDE Secondary Master/Slave PIO

PIO means Programmed Input/Output. Rather than have the BIOS issue a series of commands to effect a transfer to or from the disk drive, PIO allows the BIOS to tell the controller what it wants and

then let the controller and the CPU perform the complete task by themselves. Your system supports five modes, 0 (default) to 4, which primarily differ in timing. When Auto is selected, the BIOS will select the best available mode after checking your drive.

- Auto* The BIOS will automatically set the system according to your hard disk drive's timing.
- 0-4* You can select a mode that matches your hard disk drive's timing. Caution: Do not use the wrong setting or you will have drive errors.

IDE Primary Master/Slave UDMA and IDE Secondary Master/Slave UDMA

These categories allow you to set the Ultra DMA in use. When Auto is selected, the BIOS will select the best available option after checking your hard drive or CD-ROM.

- Auto* The BIOS will automatically detect the settings for you.
- Disabled* The BIOS will not detect these categories.

USB Controller

We recommend that you leave this field in its default setting - Enabled.

USB Keyboard Support

By default, this field is Disabled. If you are using a USB keyboard, please enable this function.

Onboard FDC Controller

- Enabled* Enables the onboard floppy disk controller.
- Disabled* Disables the onboard floppy disk controller.

Onboard UART 1 and Onboard UART 2

- Auto* The system will automatically select an I/O address for the onboard serial port 1 and serial port 2.
- 3F8/IRQ4, 2F8/IRQ3, 3E8/IRQ4, 2E8/IRQ3* Allows you to manually select an I/O address for the onboard serial port 1 and serial port 2.
- Disabled* Disables the onboard serial port 1 and/or serial port 2.

Onboard UART 2 Mode

The system board supports IrDA function for wireless connectivity between your computer and peripheral devices. You may not use IrDA (J4) and the COM 2 serial port (J5) at the same time. If you are using the COM 2 serial port, make sure "Onboard UART 2 Mode" is set to Standard.

To use the IrDA function, follow the steps below.

1. Connect your IrDA cable to connector J4 on the system board.
2. Set "Onboard UART 2 Mode" to the type of IrDA standard supported by your IrDA peripheral/device (HPSIR or ASKIR).
3. The following will appear right below "Onboard UART 2 Mode".

IR Duplex Mode

Half Data is completely transmitted before receiving data.
Full Transmits and receives data simultaneously.

Use IR Pins

Set this field according to the IR pins of your IrDA peripheral/device.

Onboard Parallel Port

378H//IRQ7, 3BCH//IRQ7, 278H//IRQ5 Selects the I/O address and IRQ for the onboard parallel port.
Disabled Disables the onboard parallel port.

Parallel Port Mode

Parallel Port Mode will appear only if you selected an I/O address and IRQ in the Onboard Parallel Port field. This option applies to a standard specification and will depend on the type and speed of your device. Refer to your peripheral's manual for the best option. Select the parallel port mode according to the type of printer device connected to your onboard parallel port.

The parallel modes are Normal, EPP, ECP and ECP+EPP. The default is ECP+EPP. Both "ECP Mode Use DMA" and "Parallel Port EPP Type" will appear on the screen.

If you selected EPP, "Parallel Port EPP Type" will appear. This field applies to standard specification. The options are EPP1.9 and EPP1.7. Default setting: EPP1.7.

If you selected ECP, "ECP Mode Use DMA" will appear. This is used to select a DMA channel for the parallel port. The options are 1 and 3. Default setting: 3.

3.1.9 Supervisor Password

If you want to protect your system and setup from unauthorized entry, set a supervisor's password with the "System" option selected in the BIOS Features Setup. If you want to protect access to setup only, but not your system, set a supervisor's password with the "Setup" option selected in the BIOS Features Setup. You will not be prompted for a password when you cold boot the system.

Use the arrow keys to highlight the "Supervisor Password" option and press <Enter>. The message below will appear:

Enter Password:

Type in the password. You are limited to eight characters. When done, the message below will appear:

Confirm Password:

You are asked to verify the password. Type in exactly the same password. If you type in a wrong password, you will be prompted to enter the correct password again. To delete or disable the password function, highlight "Supervisor Password" and press <Enter>, instead of typing in a new password. Press the <Esc> key to return to the main menu.

3.1.10 User Password

If you want another user to have access only to your system but not to setup, set a user's password with the "System" option selected in the BIOS Features Setup. If you want a user to enter a password when trying to access setup, set a user's password with the "Setup" option selected in the BIOS Features Setup. Using user's password to enter Setup allows a user to access only the "User Password" option that appears on the main screen. Access to all other options is denied. To set, confirm, verify, disable or delete a user's password, follow the procedures described in the section "Supervisor Password". If you forget your password, refer to the procedure described in the same section.

3.1.11 IDE HDD Auto Detection

Use this option to detect the parameters for the hard disk drives installed in your system. These parameters will then be automatically entered into the "Standard CMOS Setup". The IDE HDD Auto Detection screen displays the following categories of information: Size, Cylinders, Heads, Precomp, LandZone, Sectors and Mode.

ROM PCI/ISA BIOS
CMOS SETUP UTILITY
AWARD SOFTWARE, INC.

HARD DISKS	TYPE	SIZE	CYLS	HEAD	PRECOMP	LANDZ	SECTOR	MODE
Primary Master:								
Select Primary Master Option (N=Skip): N								
OPTIONS	SIZE	CYLS	HEAD	RECOMP	LANDZ	SECTOR	MODE	
2 (Y)	3501	848	128	0	7236	63	LBA	
1	3501	7237	15	65535	7236	63	Normal	
3	3499	904	120	65535	7236	63	Large	
Note: Some OS (like SCO-UNIX) must be "NORMAL" for installation								
ESC: Skip								

The settings on the screen are for reference only. Your version may not be identical to this one.

For hard drives larger than 528MB, you would typically select the LBA type. Certain operating systems require that you select Normal or Large. Please check your operating system's manual or Help desk on which one to select.

3.1.12 Save & Exit Setup

When all the changes have been made, highlight "Save & Exit Setup" and press <Enter>. The message below will appear:

Save to CMOS and Exit (Y/N)? N

Type "Y" and press <Enter>. The modifications you have made will be written into the CMOS memory, and the system will reboot. You will once again see the initial diagnostics on the screen. If you wish to make additional changes to the setup, press <Ctrl> <Alt> <Esc> simultaneously or after memory testing is done.

3.1.13 Exit Without Saving

When you do not want to save the changes you have made, highlight "Exit Without Saving" and press <Enter>. The message below will appear:

Quit Without Saving (Y/N)? N

Type "Y" and press <Enter>. The system will reboot and you will once again see the initial diagnostics on the screen. If you wish to make any changes to the setup, press <Ctrl> <Alt> <Esc> simultaneously or after memory testing is done.

Chapter 4 - Supported Softwares

4.1 Desktop Management Interface (DMI)

The system board comes with a DMI built into the BIOS. DMI, along with the appropriately networked software, is designed to make inventory, maintenance and troubleshooting of computer systems easier. With DMI, a network administrator or MIS engineer can remotely access some information about a particular computer system without physically going to it. Quite often a service call may be unnecessary as the problem can be solved remotely.

The DMI utility in the BIOS automatically records various information about your system configuration. Information about the type and speed of CPU, type and amount of memory for each memory slot, BIOS revision level, types of add-in PCI boards and components, certain revision numbers of hardware installed, etc. are automatically detected and stored in the DMI pool, which is a part of the system board's Plug and Play BIOS. Additional information, such as ISA based peripherals, which may not be automatically detected, can be manually recorded in the DMI pool by using the Add DMI menu. The DMI pool data is then verified or updated whenever the system hardware or setup is altered.

4.1.1 Running the DMI Utility

To run the DMI utility, type: DMICFG.EXE. You can download this utility from <http://www.dfiweb.com> - BIOS & DRIVERS section or <ftp.dfiusa.com> - /pub/DMI directory.

The DMI utility must run in real mode with at least 180K of base memory. Memory managers like HIMEM.SYS (required by Windows) must not be installed. You may do this by using one of the 3 methods listed below.

1. Boot up from a system diskette without the AUTOEXEC.BAT and CONFIG.SYS files,
2. "REM" HIMEM.SYS in the CONFIG.SYS, or
3. Press <F5> during bootup to bypass your AUTOEXEC.BAT and CONFIG.SYS files.

4.1.2 Using the DMI Utility

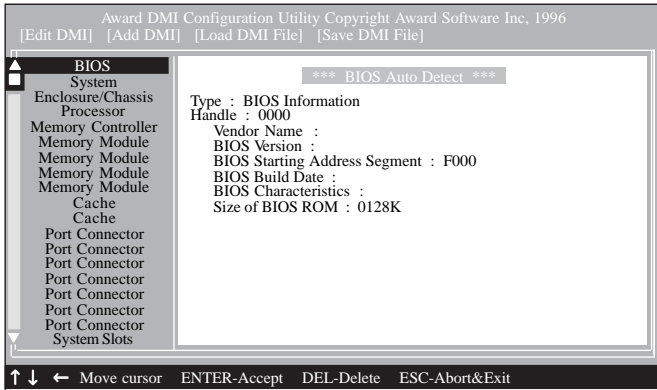

The four menus located on top of the DMI Configuration Utility screen are Edit DMI, Add DMI, Load DMI File and Save DMI File. Use the ← or → (left or right) arrow keys to select a menu from the Menu bar.

On the left side of the screen is a list of the system configuration items. Use the ↑ or ↓ (up or down) arrow keys to select an item.

The commands at the bottom of the screen will allow you to navigate through the various setup menus.

Edit DMI

1. Use the ← or → arrow keys to select the Edit DMI menu.
2. Highlight the item on the left screen that you would like to edit by using the ↑ or ↓ arrow keys, then press <Enter>.
3. The cursor will move to the screen you select allowing you to edit information. The screen will also display the auto-detected information.
4. Press <F10> to update the edited information into the flash ROM.

Add DMI

1. Use the ← or → arrow keys to select the Add DMI menu.
2. Highlight the item on the left screen that you would like to add by using the ↑ or ↓ arrow keys, then press <Enter>.
3. The cursor will move to the screen you select allowing you to enter information about the added item.
4. Press <F10> to save information into the flash ROM.

To view information about the added items, go to the Edit DMI menu.

Load DMI File

1. Use the ← or → arrow keys to select the Load DMI File menu.
2. The following message will appear:

Press [Enter] to select DMI file for load

Press <Enter>.

3. The DMI files will appear on the screen. Select the file you would like to load and press <Enter>.
4. The following message will appear:

Do you want to execute? (Y/N)

Type <Y>. All previous DMI structures will be destroyed and the new file will be saved into the flash ROM.

Save DMI File

1. Use the ← or → arrow keys to select the Save DMI File menu.
2. The following message will appear:

Press [Enter] to select DMI file for save

Press <Enter>.

3. Enter the directory and filename under which you would like the DMI file saved.

4.2 Drivers

The system board package comes with drivers contained in the provided CD. To install the drivers, please refer to the “readme” file in the CD.

All steps or procedures to install software drivers are subject to change without notice as the softwares are occasionally updated. Please refer to the readme files for the latest information.

Appendix A - Identifying Processors

A.1 Intel Processors



SXXXX/RSS
 |
R (voltage range)
 V for VRE voltage range
 S for Standard voltage range



SXXXX/KLM
 |
K = **V** for VRE voltage range, **S** for Standard voltage range
L = **M** for min valid MD timings, **S** for min valid standard timings
M = **U** is not tested for DP, **S** is tested for DP, UP and MP

A.2 Cyrix Processors



6x86MX-PR166 60MHz Bus 2.5x 2.9V (or as marked)
 | | |
 Product P-rating Processor Core
 name clock voltage
 speed



M II-300GP 75MHz Bus 3x 2.9V (or as marked)
 | | |
 Product Processor Core
 name clock voltage
 speed

A.3 IBM Processor



6x86MX-PR266

Product P-rating
name

2.5x 83MHz-2.9V CORE

Processor Core
clock voltage
speed

A.4 AMD Processors



AMD-K6-233ANR

K6 = Processor core

233 = Performance rating

A = Package type: Type A = CPGA

B = Operating voltage:

N: 3.1V-3.3V (core)/3.135V-3.6V (I/O)

L: 2.755V-3.045V (core)/3.135V-3.6V (I/O)

X = Case temperature

W: 55°C R: 70°C Q: 65°C

Y: 75°C X: 65°C Z: 85°C



AMD-K6-2/300AFR

K6-2 = Processor core

300 = Performance rating

A = Package type: Type A = 321-pin CPGA

F = Operating voltage:

2.1-2.3V Core/3.135-3.6V I/O

X = Case temperature

W: 55°C R: 70°C Q: 65°C

Y: 75°C X: 65°C Z: 85°C

A.5 IDT Processors



C6-PSME200GA
 | |
 Product Processor
 name clock speed

3.52Vcc (66MHz clock)
 | |
 Processor External system bus clock
 voltage



WinChip2-233
 | |
 Product Processor
 name clock speed

3.5 X 66MHz Clock
 | |
 Processor External system bus clock
 voltage

Appendix B - System Error Message

When the BIOS encounters an error that requires the user to correct something, either a beep code will sound or a message will be displayed in a box in the middle of the screen and the message, PRESS F1 TO CONTINUE, CTRL-ALT-ESC or DEL TO ENTER SETUP, will be shown in the information box at the bottom. Enter Setup to correct the error.

B.1 POST Beep

There are two kinds of beep codes in the BIOS. One code indicates that a video error has occurred and the BIOS cannot initialize the video screen to display any additional information. This beep code consists of a single long beep followed by three short beeps. The other code indicates that a DRAM error has occurred. This beep code consists of a single long beep.

B.2 Error Messages

One or more of the following messages may be displayed if the BIOS detects an error during the POST. This list indicates the error messages for all Awards BIOSes:

CMOS BATTERY HAS FAILED

The CMOS battery is no longer functional. It should be replaced.



Caution:

Danger of explosion if battery incorrectly replaced. Replace only with the same or equivalent type recommended by the manufacturer. Dispose of used batteries according to the battery manufacturer's instructions.

CMOS CHECKSUM ERROR

Checksum of CMOS is incorrect. This can indicate that CMOS has become corrupt. This error may have been caused by a weak battery. Check the battery and replace if necessary.

DISPLAY SWITCH IS SET INCORRECTLY

The display switch on the motherboard can be set to either monochrome or color. This indicates the switch is set to a different

setting than indicated in Setup. Determine which setting is correct, either turn off the system and change the jumper or enter Setup and change the VIDEO selection.

FLOPPY DISK(S) fail (80)

Unable to reset floppy subsystem.

FLOPPY DISK(S) fail (40)

Floppy type mismatch.

Hard Disk(s) fail (80)

HDD reset failed.

Hard Disk(s) fail (40)

HDD controller diagnostics failed.

Hard Disk(s) fail (20)

HDD initialization error.

Hard Disk(s) fail (10)

Unable to recalibrate fixed disk.

Hard Disk(s) fail (08)

Sector Verify failed.

Keyboard is locked out - Unlock the key

The BIOS detects that the keyboard is locked. Keyboard controller is pulled low.

Keyboard error or no keyboard present

Cannot initialize the keyboard. Make sure the keyboard is attached correctly and no keys are being pressed during the boot.

Manufacturing POST loop

System will repeat POST procedure infinitely while the keyboard controller is pull low. This is also used for the M/B burn in test at the factory.

BIOS ROM checksum error - System halted

The checksum of ROM address F0000H-FFFFFFH is bad.

Memory test fail

The BIOS reports memory test fail if the memory has error(s).

Appendix C - Troubleshooting

C.1 Troubleshooting Checklist

This chapter of the manual is designed to help you with problems that you may encounter with your personal computer. To efficiently troubleshoot your system, treat each problem individually. This is to ensure an accurate diagnosis of the problem in case a problem has multiple causes.

Some of the most common things to check when you encounter problems while using your system are listed below.

1. The power switch of each peripheral device is turned on.
2. All cables and power cords are tightly connected.
3. The electrical outlet to which your peripheral devices are connected is working. Test the outlet by plugging in a lamp or other electrical device.
4. The monitor is turned on.
5. The display's brightness and contrast controls are adjusted properly.
6. All add-in boards in the expansion slots are seated securely.
7. Any add-in board you have installed is designed for your system and is set up correctly.

Monitor/Display

If the display screen remains dark after the system is turned on:

1. Make sure that the monitor's power switch is on.
2. Check that one end of the monitor's power cord is properly attached to the monitor and the other end is plugged into a working AC outlet. If necessary, try another outlet.
3. Check that the video input cable is properly attached to the monitor and the system's display adapter.
4. Adjust the brightness of the display by turning the monitor's brightness control knob.

The picture seems to be constantly moving.

1. The monitor has lost its vertical sync. Adjust the monitor's vertical sync.
2. Move away any objects, such as another monitor or fan, that may be creating a magnetic field around the display.
3. Make sure your video card's output frequencies are supported by this monitor.

The screen seems to be constantly wavering.

1. If the monitor is close to another monitor; the adjacent monitor may need to be turned off. Fluorescent lights adjacent to the monitor may also cause screen wavering.

Power Supply

When the computer is turned on, nothing happens.

1. Check that one end of the AC power cord is plugged into a live outlet and the other end properly plugged into the back of the system.
2. Make sure that the voltage selection switch on the back panel is set for the correct type of voltage you are using.
3. The power cord may have a "short" or "open". Inspect the cord and install a new one if necessary.

Floppy Drive

The computer cannot access the floppy drive.

1. The floppy diskette may not be formatted. Format the diskette and try again.
2. The diskette may be write-protected. Use a diskette that is not write-protected.
3. You may be writing to the wrong drive. Check the path statement to make sure you are writing to the targeted drive.
4. There is not enough space left on the diskette. Use another diskette with adequate storage space.

Hard Drive

Hard disk failure.

1. Make sure the correct drive type for the hard disk drive has been entered in the BIOS.
2. If the system is configured with two hard drives, make sure the bootable (first) hard drive is configured as Master and the second hard drive is configured as Slave. The master hard drive must have an active/bootable partition.

Excessively long formatting period.

1. If your hard drive takes an excessively long period of time to format, it is likely a cable connection problem. However, if your hard drive has a large capacity, it will take a longer time to format.

Parallel Port

The parallel printer doesn't respond when you try to print.

1. Make sure that your printer is turned on and that the printer is on-line.
2. Make sure your software is configured for the right type of printer attached.
3. Verify that the onboard LPT port's I/O address and IRQ settings are configured correctly.
4. Verify that the attached device works by attaching it to a parallel port that is working and configured correctly. If it works, the printer can be assumed to be in good condition. If the printer remains inoperative, replace the printer cable and try again.

Serial Port

The serial device (modem, printer) doesn't output anything or is outputting garbled characters.

1. Make sure that the serial device's power is turned on and that the device is on-line.
2. Verify that the device is plugged into the correct serial port on the rear of the computer:
3. Verify that the attached serial device works by attaching it to a serial port that is working and configured correctly. If the serial device does not work, either the cable or the serial device has a problem. If the serial device works, the problem may be due to the onboard I/O or the address setting.
4. Make sure the COM settings and I/O address are configured correctly.

Keyboard

Nothing happens when a key on the keyboard was pressed.

1. Make sure the keyboard is properly connected.
2. Make sure there are no objects resting on the keyboard and that no keys are pressed during the booting process.

System Board

1. Make sure the add-in card is seated securely in the expansion slot. If the add-in card is loose, power off the system, re-install the card and power up the system.
2. Check the jumper settings to ensure that the jumpers are properly set.
3. Verify that all memory modules are seated securely into the memory sockets.
4. Make sure the memory modules are in the correct locations.
5. If the board fails to function, place the board on a flat surface and seat all socketed components. Gently press each component into the socket.
6. If you made changes to the BIOS settings, re-enter setup and load the BIOS defaults.