



G586VPM
Rev. A
System Board
User's Manual



- D25141203 -





❖ **Copyright 1994, by DFI Inc.**

All rights reserved.

No part of this document may be copied or reproduced in any form or by any means without the prior written consent of DFI, Inc.

DFI, Inc. makes no warranties with respect to this documentation and disclaims any implied warranties of merchantability, quality, or fitness for any particular purpose. The information in this document is subject to change without notice. DFI, Inc. reserves the right to make revisions to this publication and to make changes to any and/or all parts of its content, at any time, without obligation to notify any person or entity of such changes. Further, DFI, Inc. assumes no responsibility for any errors that may appear in this document.

DFI is a registered trademark, and G586VPM is a trademark of Diamond Flower, Inc. All other product names mentioned are trademarks or registered trademarks of their respective companies.



❖ **FCC Statement on Class B**

This equipment has been tested and complies with the limits for a Class B digital device, pursuant to Part 15 of the FCC rules. These limits are designed to provide reasonable protection against harmful interference when the equipment is operated in a residential installation. This equipment generates, uses, and can radiate radio frequency energy and if not installed and used in accordance with the instruction manual may cause harmful interference to radio communications. However, there is no guarantee that interference will not occur in a particular installation. If this equipment does cause harmful interference to radio or television reception, which can be determined by turning the equipment off and on, the user is encouraged to try to correct the interference by one or more of the following measures.

- *Reorient or relocate the receiving antenna*
- *Increase the separation between the equipment and the receiver*
- *Connect the equipment into an outlet on a circuit different from that to which the receiver is connected*
- *Consult the dealer or an experienced radio TV technician for help*

Notice:

1. *The changes or modification not expressly approved by the party responsible for compliance could void the user's authority to operate the equipment.*
2. *Shielded interface cables must be used in order to comply with the emission limits.*



❖ Table of Contents ❖

Introduction	1-1
Features and Specifications	1-2
Package Checklist	1-4
Installation Overview	2-1
Preparing the Area	2-1
	2-2
Precautions in Handling the System Board	2-2
Tips in Handling the System Board	2-2
Hardware Installation	2-2
Memory Installation	2-6
Installing the Modules	2-7
Board Configuration	2-8
Jumper Settings for Display Type and PS/2	
Mouse.....	2-9
PCI IDE Controller.....	2-11
Cache Memory	2-13
CPU Installation	2-16
Jumper Settings for CPU	2-17
Installing Upgrade CPU.....	2-20
Built-in Ports	2-25
Serial Ports	2-26
Parallel Port	2-27
Floppy Disk Drive Connector	2-29
IDE Hard Disk Connector	2-30
PS/2 Mouse Port	2-33
Installing Expansion Cards	2-34
Installing the System Board	2-35



Initial Setup Program	3-1
Award BIOS CMOS Setup Utilities	3-2
Standard CMOS Setup	3-2
BIOS Features Setup	3-5
Chipset Features Setup	3-7
Power Management Setup	3-8
PCI Configuration Setup	3-9
Load BIOS Defaults	3-10
Load Setup Defaults	3-10
Password Setting	3-11
IDE HDD Auto Detection	3-12
Save & Exit Setup	3-13
Exit Without Saving	3-14
IDE Device Drivers	4-1
Troubleshooting Checklist	5-1
Appendix A: Types of Modules	A-1
Appendix B: System Error Report	B-1
Appendix C: Memory & I/O Maps	C-1
Appendix D: PCI I/O Pin Assignments	D-1
Appendix E: ISA I/O Pin Assignments	E-1
Appendix F: Connector Pin Assignments	F-1
Appendix G: Award BIOS Hard Disk Table	G-1



❖ Introduction

The G586VPM system board offers several advanced features integrated into the system board. Its design is based on the new Peripheral Component Interconnect (PCI) local bus and Industry Standard Architecture (ISA) standards.

The G586VPM supports a 320-pin Zero Insertion Force (ZIF) CPU socket for Pentium™ processors running at 75MHz, 90MHz or 100MHz frequency. This ZIF socket allows users to easily upgrade their CPUs. It also supports Flash EPROM for easy BIOS upgrades. Flash EPROM is a memory chip for the storage of BIOS which can be erased in bulk or modified using a software utility.

The G586VPM is equipped with four PCI and four ISA slots, of which one pair is shared.

Equipped with two built-in PCI IDE connectors, the G586VPM system board can control four drives and supports fast Mode 3 hard drives and hard drives larger than 528MB under DOS. The system board is also equipped with two NS16C550 serial ports, an ECP/EPP parallel port, a floppy disk drive controller, and one mini-DIN-6 connector for the PS/2 mouse.

The G586VPM can be configured to 22 different memory sizes ranging from 4MB to 256MB using 256Kx36, 512Kx36, 1Mx36, 2Mx36, 4Mx36 and 8Mx36 SIM modules.



G586VPM

Features and Specifications

Processor

- Intel's Pentium™ 75/90/100MHz OverDrive Pentium Processor

Chipset

- VLSI chipset
VL82C591 - system and cache controller
VL82C592 (2) - data buffer
VL82C593 - PCI bridge

Architecture

- PCI/ISA

Energy Efficient Design

- Supports 3.3V CPUs
- Supports system power management
- Supports CPU stopped clock
- Provides highly efficient 3.3V/5A Switching Power Supply to CPU and chipsets

Power Management

- Three powersaving stages: Doze, Standby and Suspend
- Microsoft APM supported

BIOS

- Award Plug & Play BIOS (Flash EPROM)
- Supports IDE HDDs larger than 528MB under DOS (LBA mode only)

Cache Memory

- 160-pin socket for cache module
- Supports 3.3V or 5V/3.3V asynchronous (burst) SRAM



PC/ISA System Board

- Supports 3.3V or 5V/3.3V synchronous (burst) SRAM
- 256K, 512K or 1MB direct map buffered write-through cache
- Uses 256K, 512K or 1MB cache modules
- Supports 32 byte or 64 byte line size to allow the use of optional cache-tag RAM size

Memory Onboard

- Up to 256MB
- Eight 72-pin SIMM sockets
- Supports single and/or double density SIMMs
- 256Kx36, 512Kx36, 1Mx36, 2Mx36, 4Mx36 or 8Mx36 SIMMs
- Supports 60ns or 70ns fast page mode DRAM

PCI IDE Interface

- Supports two PCI IDE connectors controlling four drives (e.g., 2 HDDs, 1 tape drive and 1 CD-ROM)
- Supports fast Mode 3 (Enhanced IDE) hard drives
- Uses NS PC87410 PCI IDE chipset

Super I/O Interface

- Uses NS PC87334 super I/O controller
- Two serial ports (NS16C550 compatible)
- One parallel port (with EPP and ECP support)
- Supports 360K, 720K, 1.2MB, 1.44MB and 2.88MB floppy drives

Expansion Slots

- Three dedicated PCI slots
- One shared PCI/ISA slot
- Three dedicated 16-bit ISA slots

ZIF Socket

- One 320-pin ZIF socket (Intel Socket 5)



G586VPM

Board Dimensions

- 33cm (12.87") x 22cm (8.58")
Baby AT form factor

Package Parts List

The G586VPM package contains the following items:

- G586VPM system board
- G586VPM user's manual
- Two IDE driver diskettes
- One 34-pin floppy disk drive cable
- Two 40-pin IDE hard disk cables
- One 25-pin printer port cable for chassis mounting
- One card-edge bracket with serial and mouse port cables

If any of these items are missing or damaged, please contact your dealer or sales representative for assistance.



❖ *Installation Overview*

This chapter summarizes the steps in installing the G586VPM system board into your system unit. It also includes a description of the area in which you must work and directions for memory installation. Before installing the system board, obtain the memory you plan to install. Please refer to the memory chart on pages 2-4 and 2-5 for the number and type of SIM modules needed for the amount of memory you require.

Preparing the Area

Before unpacking the system board, make sure the location you have selected is relatively free of dust and static electricity. Excessive exposure to dust, static electricity, direct sunlight, excessive humidity, extreme cold and water can damage the system board. Avoid soft surfaces such as beds and carpeted floors which can hinder air circulation. These areas also attract static electricity which can damage some circuits on your system board.

Be sure that the power source has a properly grounded, three-pronged socket. It is essential that the power connection be properly grounded for correct functioning of your system board. For further protection, we recommend that you use a surge suppressor. This will protect the system board from damage that may result from a power surge on the line.

Move items that generate magnetic fields away from your system board, since magnetic fields can also damage your system board. Once you have selected the ideal location, unpack the G586VPM system board carefully.

2-1 ◆ Installation Overview



G586VPM

Precautions in Handling the System Board

It is quite easy to inadvertently damage your system board even before installing it in your system case. Static electrical discharge can damage computer components without causing any signs of physical damage. You must take extra care in handling the system board to ensure that no static build-up is present.

Tips in Handling the System Board

- 1) To prevent electrostatic build-up, leave the board in its anti-static bag until you are ready to install it.
- 2) Wear an antistatic wriststrap.
- 3) Do all preparation work on a static-free surface with components facing up.
- 4) Hold the system board by its edges only. Be careful not to touch any of the components, contacts or connections, especially gold contacts on the board.
- 5) Avoid touching the pins or contacts on all modules and connectors. Hold modules and connectors by their ends.

Hardware Installation

Memory Installation

The G586VPM system board can support 2MB to 256MB of memory using SIM modules.



PC/ISA System Board

A SIM module consists of several RAM chips soldered onto a small circuit board. A SIM module connects to the system board via a 72-pin card-edge connector.

With 64-bit access, the G586VPM system board uses 256Kx36, 512Kx36, 1Mx36, 2Mx36, 4Mx36 or 8Mx36 SIMM modules. It uses 256K bit, 1M bit, 4M bit, or 16M bit depth DRAM.

The SIM sockets are divided into four 64-bit banks on the system board. Each bank consists of 2 SIMM sockets. You can insert single-sided or double-sided SIM modules to any of the banks located on the system board.

The following table summarizes the bank locations and modules needed for the corresponding memory sizes.



2-3 ♦ Installation Overview





G586VPM

MemorySize	Bank0	Bank1	Bank2	Bank3
2MB	256Kx36	-	-	-
4MB	256Kx36	256Kx36	-	-
4MB	512Kx36	-	-	-
6MB	256Kx36	256Kx36	256Kx36	-
6MB	512Kx36	256Kx36	-	-
8MB	256Kx36	256Kx36	256Kx36	256Kx36
8MB	512Kx36	256Kx36	256Kx36	-
8MB	512Kx36	512Kx36	-	-
8MB	1Mx36	-	-	-
10MB	512Kx36	512Kx36	256Kx36	-
10MB	1Mx36	256Kx36	-	-
12MB	512Kx36	512Kx36	256Kx36	256Kx36
12MB	512Kx36	512Kx36	512Kx36	-
12MB	1Mx36	512Kx36	-	-
16MB	512Kx36	512Kx36	512Kx36	512Kx36
16MB	1Mx36	512Kx36	512Kx36	-
16MB	1Mx36	1Mx36	-	-
16MB	2Mx36	-	-	-
18MB	2Mx36	256Kx36	-	-
20MB	1Mx36	1Mx36	256Kx36	256Kx36
20MB	2Mx36	512Kx36	-	-
22MB	1Mx36	1Mx36	512Kx36	-
24MB	1Mx36	1Mx36	512Kx36	512Kx36
24MB	1Mx36	1Mx36	1Mx36	-
24MB	2Mx36	1Mx36	-	-
32MB	1Mx36	1Mx36	1Mx36	1Mx36
32MB	2Mx36	2Mx36	-	-
32MB	4Mx36	-	-	-
34MB	4Mx36	256Kx36	-	-
36MB	2Mx36	2Mx36	256Kx36	256Kx36
36MB	2Mx36	2Mx36	512Kx36	-
36MB	4Mx36	512Kx36	-	-
40MB	2Mx36	2Mx36	512Kx36	512Kx36
40MB	2Mx36	2Mx36	1Mx36	-
40MB	4Mx36	1Mx36	-	-
48MB	2Mx36	2Mx36	1Mx36	1Mx36
48MB	2Mx36	2Mx36	2Mx36	-
48MB	4Mx36	2Mx36	-	-
64MB	2Mx36	2Mx36	2Mx36	2Mx36



PC/ISA System Board

MemorySize	Bank0	Bank1	Bank2	Bank3
64MB	4Mx36	2Mx36	2Mx36	-
64MB	4Mx36	4Mx36	-	-
64MB	8Mx36	-	-	-
66MB	8Mx36	256Kx36	-	-
68MB	4Mx36	4Mx36	256Kx36	256Kx36
68MB	8Mx36	512Kx36	-	-
72MB	8Mx36	1Mx36	-	-
80MB	4Mx36	4Mx36	1Mx36	1Mx36
80MB	8Mx36	1Mx36	1Mx36	-
80MB	8Mx36	2Mx36	-	-
96MB	4Mx36	4Mx36	2Mx36	2Mx36
96MB	4Mx36	4Mx36	4Mx36	-
96MB	8Mx36	4Mx36	-	-
128MB	4Mx36	4Mx36	4Mx36	4Mx36
128MB	8Mx36	4Mx36	4Mx36	-
128MB	8Mx36	8Mx36	-	-
132MB	8Mx36	8Mx36	256Kx36	256Kx36
136MB	8Mx36	8Mx36	512Kx36	512Kx36
144MB	8Mx36	8Mx36	1Mx36	1Mx36
144MB	8Mx36	8Mx36	2Mx36	-
160MB	8Mx36	8Mx36	2Mx36	2Mx36
160MB	8Mx36	8Mx36	4Mx36	-
192MB	8Mx36	8Mx36	8Mx36	-
196MB	8Mx36	8Mx36	4Mx36	4Mx36
256MB	8Mx36	8Mx36	8Mx36	8Mx36

2-5 ◆ Installation Overview

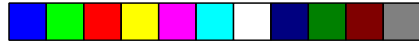

G586VPM

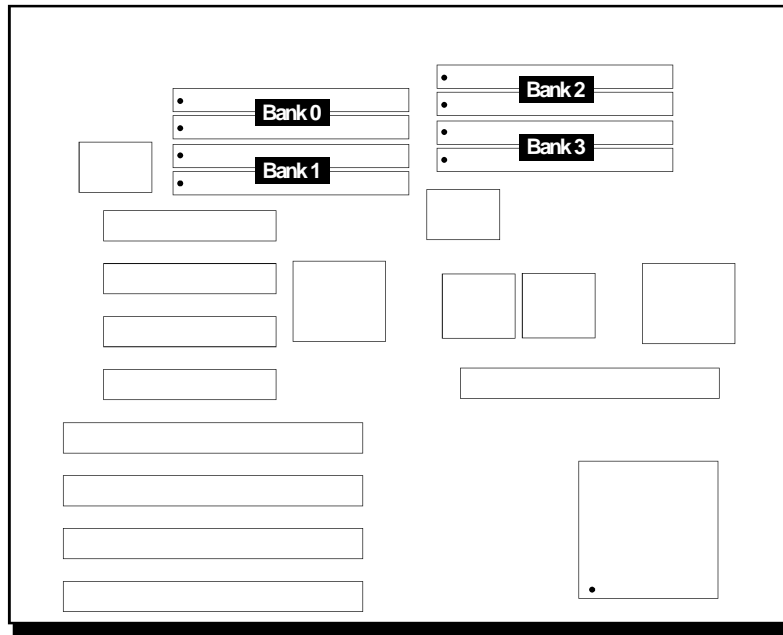

• Pin 1 of the SIMM socket

Locations of the SIM Sockets on the System Board

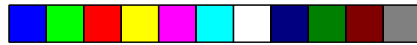

PC/ISA System Board

Installing the Modules

A SIM module simply snaps into a socket on the system board. Pin 1 of the SIM module must correspond with Pin 1 of the socket.

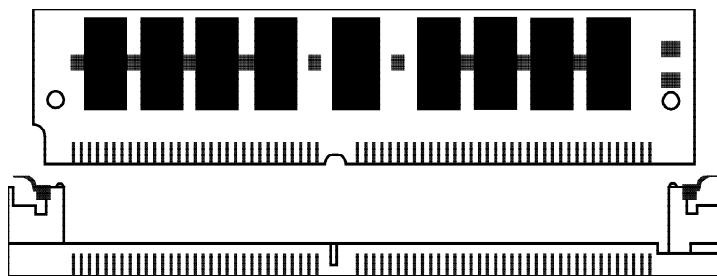

1. Position the SIM module above the socket with the “notch” in the module aligned with the “key” on the socket.
2. Seat the module at a 45° angle into the bank. Make sure it is completely seated. Tilt the module upright until it locks in place in the socket.

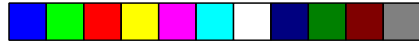

Board Configuration

The G586VPM is designed with jumpers and connectors onboard. Make sure that the jumpers are set correctly before installing the system board into your system unit.

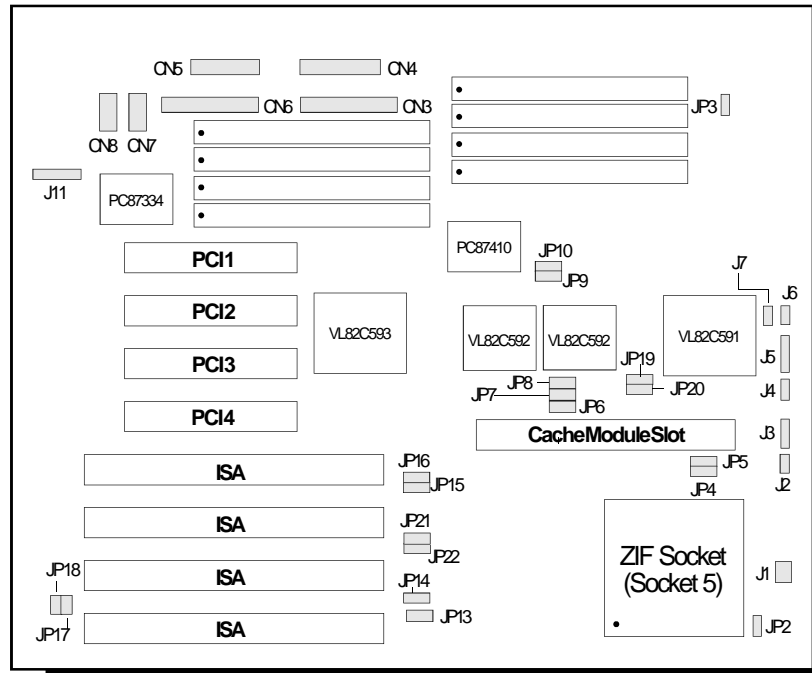

Locations of Jumpers and Connectors on the G586VPM System Board



PC/ISA System Board

Jumper Settings

Jumper Settings for Display Type and Mouse Port

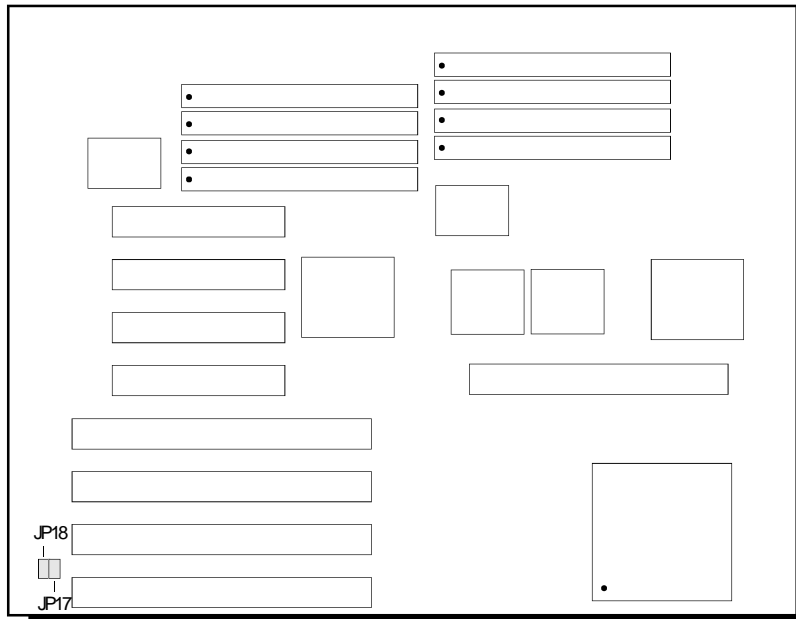

**Locations of Jumpers JP17 and JP18
on the G586VPM System Board**



G586VPM

Jumper JP17 Display Type Select

Jumper JP17 sets the display adapter to color or mono. This jumper must match the type of display adapter installed. If you change your video adapter, make sure this jumper is changed accordingly.



On: Color
(Default)



Off: Mono

Jumper JP18 PS/2 Mouse

The G586VPM package includes a card-edge bracket with serial and mouse port. The PS/2 mouse port uses IRQ12. If you set Jumper JP18 to IRQ12 enable, make sure you connect the PS/2 mouse port to Connector J11. When IRQ12 is disabled and a PS/2 mouse is not used, the IRQ12 interrupt is available for other devices.



On: IRQ12 Enabled
(Default)



Off: IRQ12 Disabled



PC/ISA System Board

Jumper Settings for PCI IDE Controller

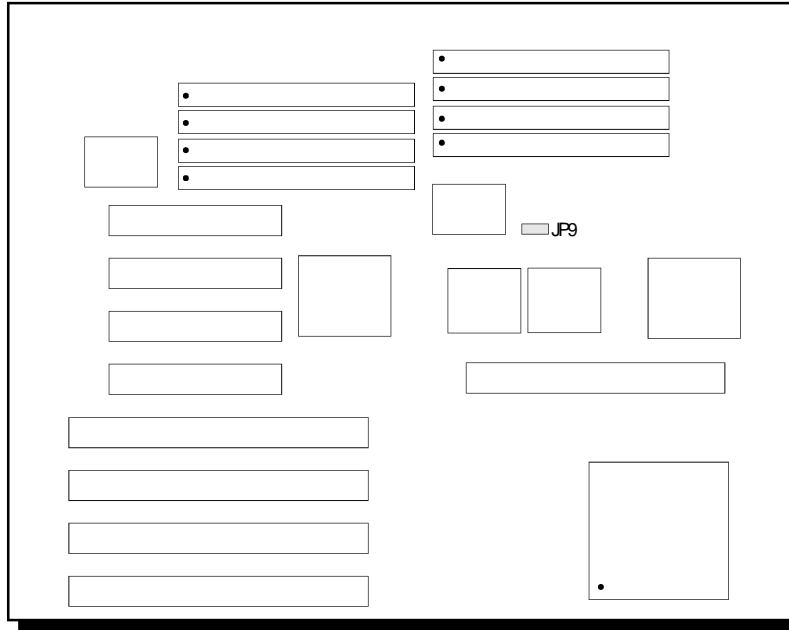

Location of Jumper JP9 on the G586VPM System Board



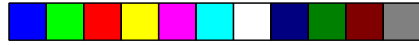

G586VPM

Jumper JP9 PCI IDE

The G586VPM uses NS PC87410 PCI IDE chip that supports two IDE controllers. Set Jumper JP9 to Off if you are using other chips.

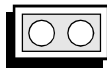

On: PCI IDE Enabled
(Default)



Off: PCI IDE Disabled

Note:

The setting of JP9 and the Onboard PCI IDE Chip option under the Chipset Features Setting should be similar.

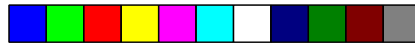

PC/ISA System Board

Cache Memory

The G586VPM system board provides a cache module slot rather than a build-in cache. The mainboard can be configured to three different cache sizes: 256KB (Default), 512KB and 1MB. Insert the cache module into the cache module slot as shown on the next page

The size of the cache module will depend on the number of tag RAM installed on the system board. Use 256K cache module if the system board is installed with one tag RAM (U6). You can insert 256K, 512K or 1M cache module if the system board is installed with two tag RAMs (U6 and U7).

We recommend that you use the following brands of cache module and use JP13 to select your CPU speed accordingly.

Brand/Model	Size	CPU Speed
IDT/7MPV6186-S15M	256KB Async.	100/66MHz, 90/60MHz
IDT/7MP6181-S9M	256KB Sync.	100/66MHz, 90/60MHz
IDT/7MP6182-S9M	512KB Sync.	100/66MHz, 90/60MHz
IDT/7MP6181-S10M	256KB Sync.	90/60MHz
IDT/7MP6182-S10M	512KB Sync.	90/60MHz



G586VPM

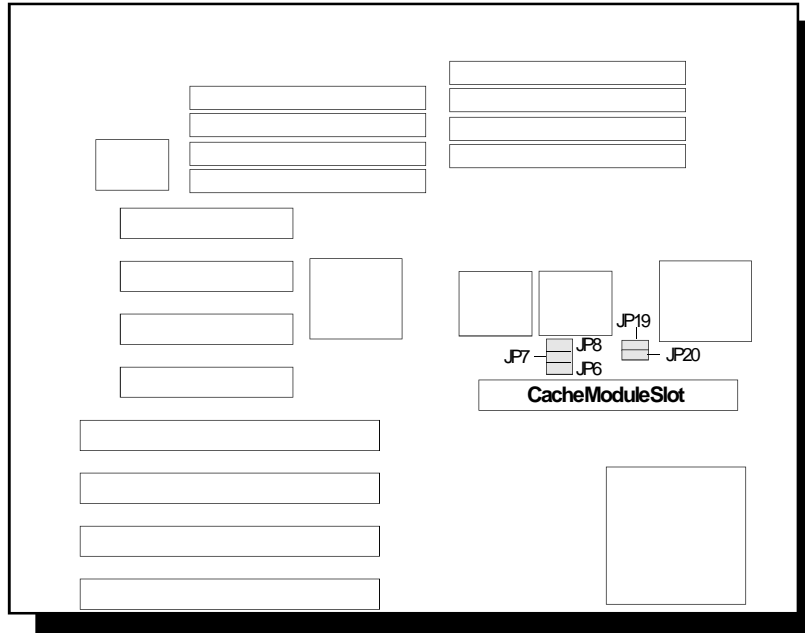

**Locations of Jumpers JP6-JP8, JP19, and JP20
on the G586VPM System Board**



PC/ISA System Board

Jumpers JP6-JP8, JP19, and JP20 Cache Memory

Jumpers JP6-JP8, JP19, and JP20 should be set according to the cache size shown below.

	JP6	JP7	JP8	JP19	JP20	Tag
256KB with 32-byte line size*	1-2 On	1-2 On	1-2 On	1-2 On	1-2 On	U6
512KB with 32-byte line size	2-3 On	1-2 On	2-3 On	2-3 On	1-2 On	U6 & U7
512KB with 64-byte line size	2-3 On	2-3 On	2-3 On	2-3 On	1-2 On	U6 & U7
1MB with 64-byte line size	2-3 On	1-2 On	2-3 On	2-3 On	2-3 On	U6 & U7

*Default setting

Cacheable Memory Range

256KB with 32-byte line size	0-64MB
512KB with 32-byte line size	0-128MB
512KB with 64-byte line size	0-128MB
1MB with 64-byte line size	0-256MB

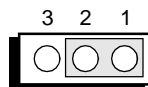

1-2: On

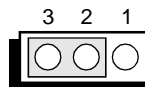

2-3: On



CPU Installation

The G586VPM is equipped with a 320-pin Zero Insertion Force (ZIF) socket at location U5 of the system board. This socket is designed for easy removal of an old CPU. This socket allows you to carefully put the CPU into place. If you need to apply force to insert the CPU, the installation is being done incorrectly. Make sure the jumpers are set correctly before applying power, or you may damage the CPU or system board.

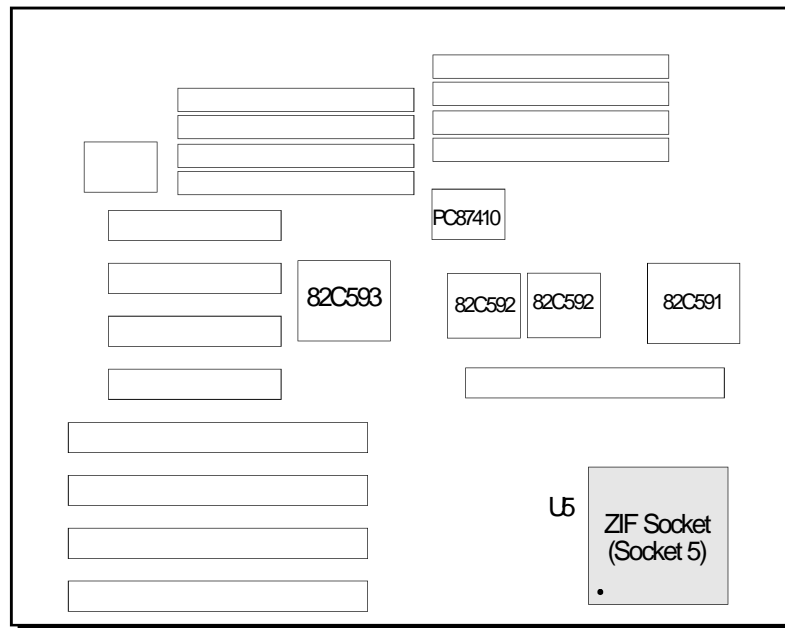

• Pin 1 of the socket

Location of the ZIF Socket on the G586VPM System Board



PC/ISA System Board

Jumper Settings for CPU

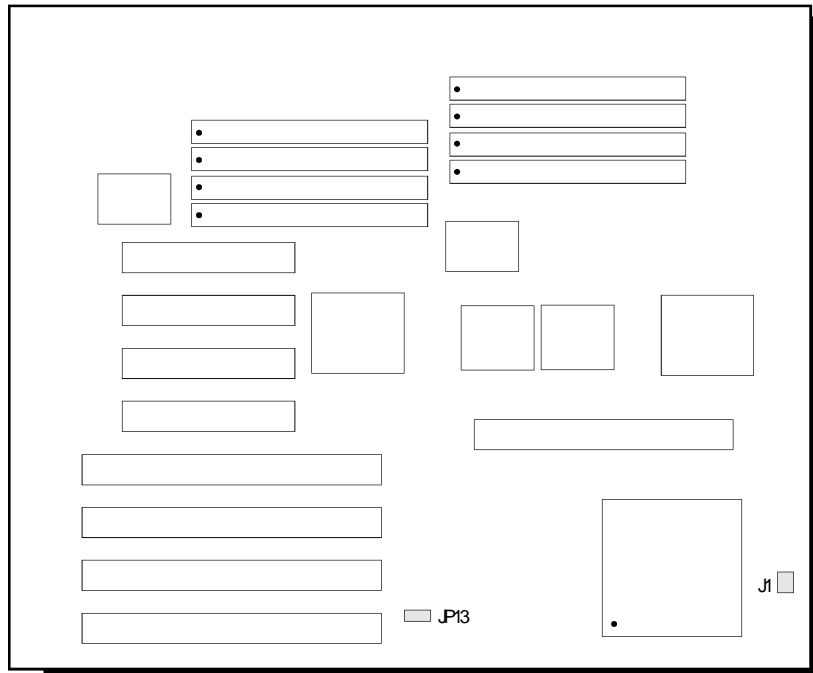

**Locations of Jumpers J1 and JP13
on the G586VPM System Board**



Jumper J1 CPU Speed Select

The G586VPM supports CPU speeds of 50MHz, 60MHz and 66.66MHz. Set Jumper J1 according to the speed of the CPU installed on the system board. For 75/100MHz, 90/120MHz and 100/132MHz CPUs, use the 50MHz, 60MHz and 66.66MHz settings, respectively.

	Pins 1-2	Pins 3-4	Pins 5-6
50MHz	On	Off	Off
60MHz*	On	Off	On
66.66MHz	On	On	On

* Default setting

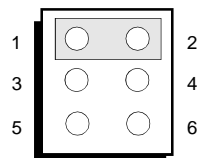

1-2: On

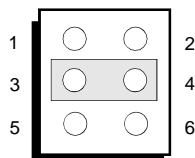

3-4: On

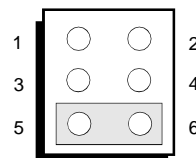

5-6: On



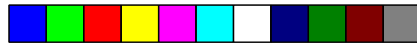

PC/ISA System Board

Jumper JP13 CPU Speed Select

Set JP13 according to the speed of the CPU installed in the CPU socket.

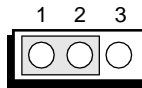

1-2 On: 50MHz/100MHz,
60MHz/120MHz or
66MHz/132MHz CPU

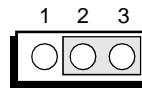

2-3 On: 50MHz/75MHz,
60MHz/90MHz or
66MHz/100MHz CPU
(Default)

The jumpers below are for factory testing only and should always be set to their default configurations. Reconfiguring these jumpers will cause problems with your system board.

JP2, JP3, JP16: 2-3 On
JP4, JP5, JP14, JP15: 1-2 On
J8, JP10, JP21, JP22: Off



Installing Upgrade CPUs

The G586VPM is equipped with a 320-pin Zero Insertion Force (ZIF) socket at location U5 of the system board. This socket has a latching/unlatching mechanism that is located on the lower side of the ZIF socket (Socket 5). The socket must be in the open position before you can install the CPU.

To unlatch (open) the socket, lightly press the ZIF socket handle down while gently moving it horizontally to the right. After the handle is freed from the locking tab, move it to the highest vertical upright position. If the ZIF socket lever action is obstructed or prevented from extending to its fully open position, damage may occur to the CPU during removal/installation.

To install the CPU, line up pin 1 of the CPU to pin 1 of the ZIF socket. (The CPU has one notched edge and that is the edge where pin 1 is located.) Place the CPU on top of the ZIF socket assuring that the CPU is level and has made contact with the pin holes. To relatch the ZIF socket, move the ZIF socket handle down to its lowest vertical position. Once in this position, lightly press the handle down and move it horizontally to the left catching it under the locking tab.

If the handle is not completely latched, damage to the CPU or motherboard may result.

Warning:

Open the socket only if actually installing a CPU. The warranty on the original CPU will be voided if the S/N seal is broken. Installation of OverDrive™ Processors will not affect the original system warranty.



PC/ISA System Board

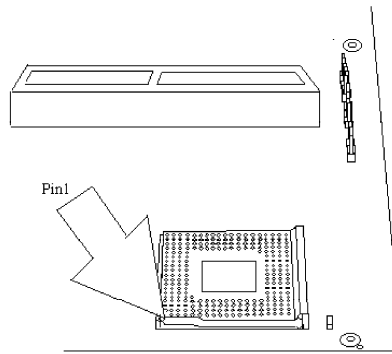

Zero Insertion Force (ZIF) Socket

To install an upgrade CPU in the G586VPM, carefully follow the steps below.

1. Lift the handle on the side of the ZIF socket completely upward. Do not use screwdrivers or other tools to open the socket, or damage may occur to the system or socket. It may be necessary to initially apply a small amount of sideways force to free the lever from its retaining “tab.” Once clear of the “tab,” the lever will open easy.



G586VPM

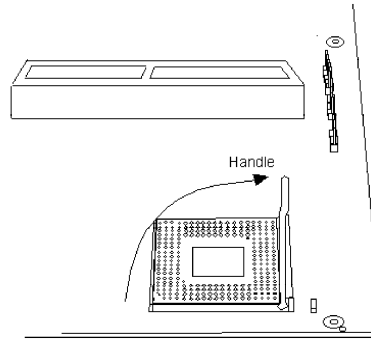

Lifting the Handle

2. Once the lever is completely up, remove the old CPU by carefully lifting it straight out of the socket. You are now ready to insert the new CPU.

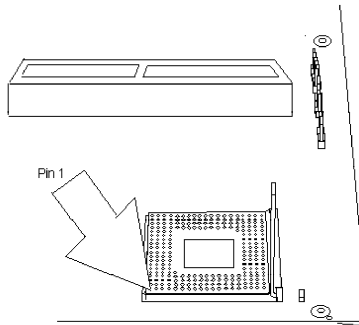

Pin 1 of the ZIF Socket

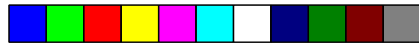

PC/ISA System Board

3. Position the CPU above the ZIF socket. Make sure pin 1 of the CPU is aligned with pin 1 of the socket. Lower the chip until the pins are inserted properly in their corresponding holes. Remember that no force is needed to install the CPU. If the CPU will not easily insert, please verify you have pin 1 of the CPU aligned with pin 1 of the socket. Applying pressure can damage the CPU or the socket.

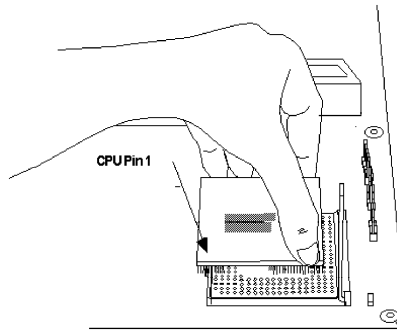

Positioning the CPU Above the ZIF Socket



4. Gently relatch the handle down until it locks into place. You will hear a click when the handle is secure. It may require gentle pressure for the handle to lock under its retaining "tab." If the handle is not completely closed, damage to the motherboard and/or CPU may result.

Horizontal/Vertical Clearance

The absolute horizontal minimum for space clearance around the CPU is 0.2" on at least three of the four sides when the system is fully configured.

The absolute vertical minimum for space clearance around the active fan/heatsink on the CPU is 0.4". An area extending 1.4" perpendicular from the socket surface must be kept clear of all immovable obstructions.

Fan Exhaust

The CPU must be kept cool by using a fan exhaust configuration in connection with the heatsink. The temperature of the air entering the fan/heatsink cannot exceed 45°C.

In order to provide proper airflow to the CPU, all movable obstructions (power supply cables, cards, floppy disk cables) must be clear of the CPU heatsink/fan component in accordance with the clearance discussed in the CPU installation section of this manual.



PC/ISA System Board

Built-in Ports

The G586VPM system board is equipped with two serial ports, one ECP/EPP parallel printer port, one FDD connector, two IDE hard disk connectors and one PS/2 mouse port.

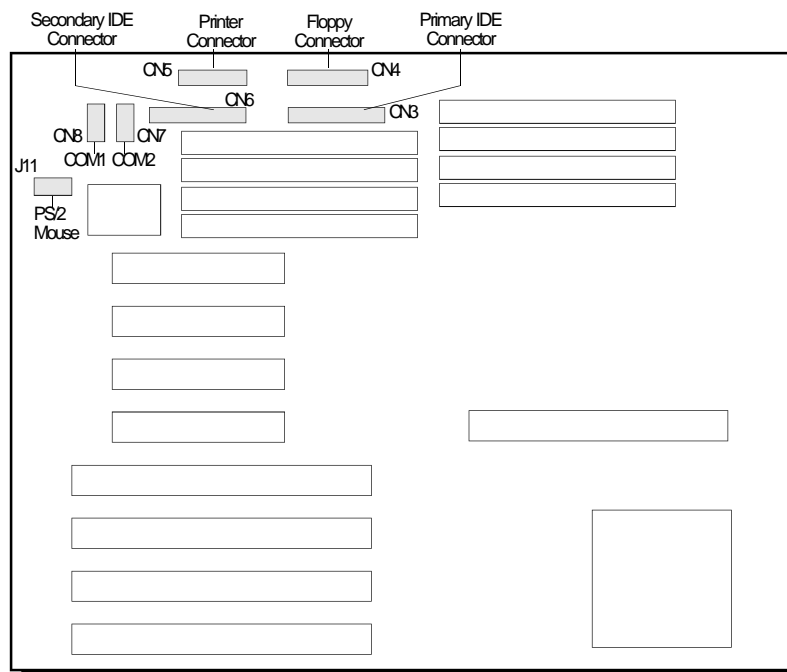

Locations of the Built-in Ports on the System Board



Serial Ports

The built-in serial ports are RS-232C asynchronous communication ports with NS16C550-compatible UARTs that can be used with modems, serial printers, remote display terminals, and other serial devices. The G586VPM system board supports IRQ4 and IRQ5 for the primary serial port and IRQ3 and IRQ9 for the secondary serial port. These serial ports use the following system I/O addresses:

Port Configuration	I/O Address
COM1	3F8h
COM2	2F8h

Connecting the Serial Ports

Two DB-9P serial port cables are provided with the motherboard. They are mounted on a card-edge bracket along with the PS/2 mouse cable. The upper serial port cable should be used for the COM-A primary serial port; connect it to Connector CN8 on the motherboard. The lower serial port cable should be used for the COM-B secondary serial port; connect it to Connector CN7 on the motherboard. Make sure the colored stripes on the ribbon cables align with pin 1 of Connectors CN7 and CN8. Mount the card-edge bracket to the system chassis.



PC/ISA System Board

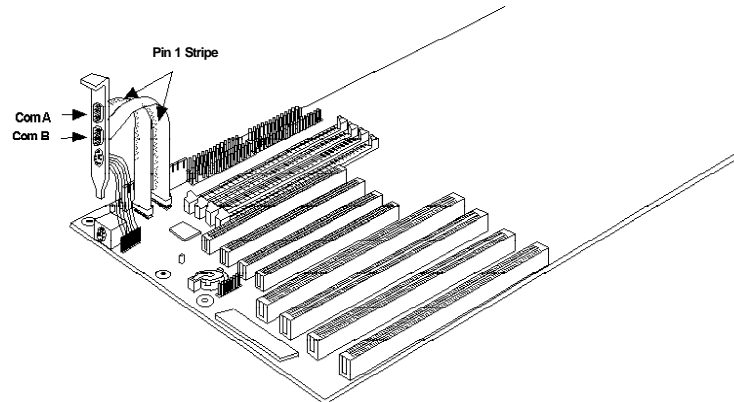

The Primary and Secondary Serial Ports on the G586VPM System Board

Parallel Port

The G586VPM system board has a standard connector to a parallel printer. This port is compatible with both IBM AT printer ports and the new, high speed, bi-directional Extended Capabilities Port standard. The parallel port on your system board can be set to any of the following system I/O addresses:

Port Configuration	I/O Address
LPT1	3BC-3BE Hex
LPT2*	378-37A Hex
LPT3	278-27A Hex

** Default setting*



G586VPM

Connecting the Parallel Printer Port

Attach the DB-25S printer port cable, which came with the motherboard, to Connector CN5 on the G586VPM system board. Make sure the colored stripe on the ribbon cable aligns with pin 1 of Connector CN5. Use a small nutdriver to mount the cable into a DB-25 cutout in the system chassis.

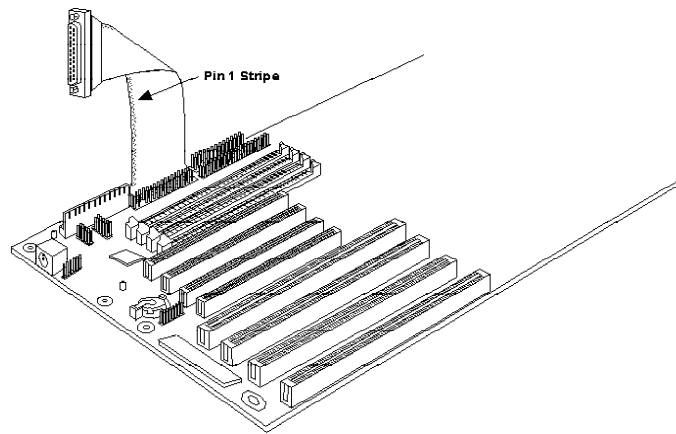

The Parallel Printer Port on the G586VPM System Board

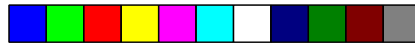

PC/ISA System Board

Floppy Disk Drive Controller

The G586VPM system board has a built-in floppy disk controller that supports two standard floppy disk drives. You can install any 360KB/720KB/1.2MB/1.44MB/2.88MB floppy disk drives.

Connecting the Floppy Disk Cable

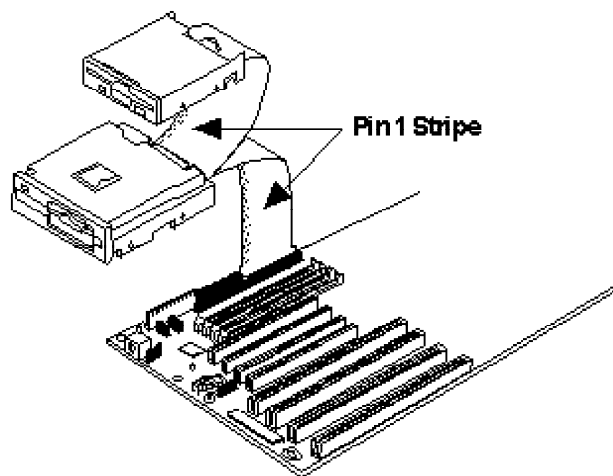

**The Floppy Disk Connector on the
G586VPM System Board**

Step 1

Install the 34-pin header connector into the floppy disk connector (CN4) on the G586VPM system board with the colored edge of the ribbon aligned to pin 1.



G586VPM

Step 2

Install the other 34-pin header connector(s) into the disk drive(s) with the colored edge of the daisy chained ribbon cable aligned to pin 1 of the drive edge connector(s). The end-most connector should be attached to the drive you want to be Drive A.

IDE Hard Disk Interface

The G586VPM system board is equipped with two PCI IDE connectors that will interface four IDE (Integrated Drive Electronics) hard disk drives. An IDE drive is a hard drive with the controller electronics built into the disk assembly. The integration of the controller and the drive as a single unit increases reliability and performance by eliminating redundant circuitry.

Note:

Only IDE drives can be connected to the IDE interface.

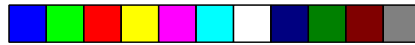

PC/ISA System Board

Connecting the IDE Hard Disk Interface

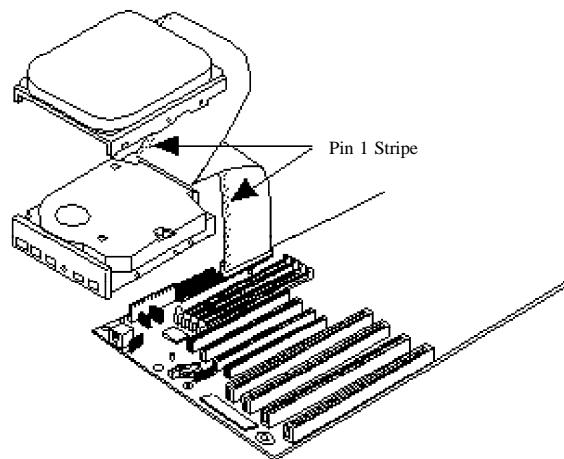

**The IDE Hard Disk Connector on the
G586VPM System Board**

Step 1

If you are connecting two hard drives, install the 40-pin connector of the IDE cable into the primary disk connector (CN3). If you are adding a third or fourth IDE device, install the 40-pin connector of the other IDE cable into the secondary connector (CN6). Make sure the colored edge of the ribbon is aligned to pin 1.

Step 2

Install the other 40-pin header connector(s) into the device with the colored edge of the ribbon cable aligned to pin 1 of the drive edge connector(s).



Note:

Refer to your disk drive user's manual for information about selecting proper drive switch settings.

Adding a Second IDE Hard Drive

When using two IDE drives, one must be set as the master and the other as the slave. Follow the instructions provided by the drive manufacturer for setting the jumpers and/or switches on the drives. No changes are needed on the G586VPM system board when adding a second hard drive.

We recommend that the IDE hard drives be from the same manufacturer. In a few cases, drives from two manufacturers will not function properly when used together. The problem lies in the hard drives, not the G586VPM system board.

Preparing an IDE Drive for Use

IDE disk drives are already low-level formatted, with any bad-track errors entered, when shipped by the drive manufacturer. Do not attempt to do a low-level format, or you may cause serious damage to the drive.

To use an IDE drive, you need to enter the drive type (this information is provided by the drive manufacturer) into the system's CMOS setup table. Then run FDISK and FORMAT provided with DOS.

Note:

Do not run FDISK and FORMAT programs on a drive that has already been formatted, or you will lose all programs and data stored on the drive.

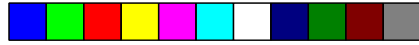

PC/ISA System Board

PS/2 Mouse Port

The PS/2 mouse port is a 6-pin connector on the G586VPM system board. Attach the 6-pin mouse port cable, which came in the G586VPM box, to connector J11. Make sure the brown wire on the PS/2 mouse connector aligns with pin 1 of connector J11. The other end of the wires are attached to the card-edge bracket that also holds the two serial port cables.

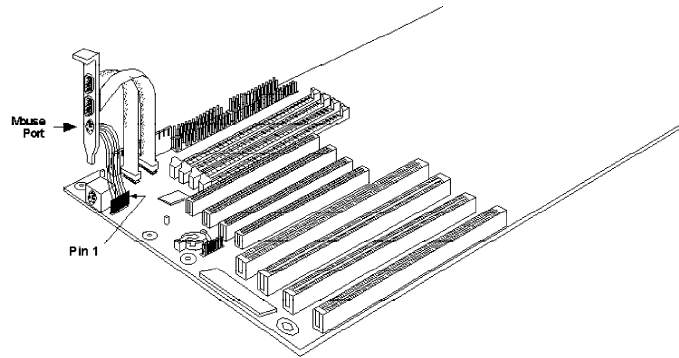

The PS/2 Mouse Port on the G586VPM System Board



Installing Expansion Cards

The G586VPM is equipped with three dedicated ISA and three dedicated PCI slots. There is one shared ISA/PCI slot. You can only install a card in one or the other of the shared slot at a time. The location of the expansion slots are shown below. Due to the size of the CPU, card size is limited. Refer to the Features and Specifications section for limitations.

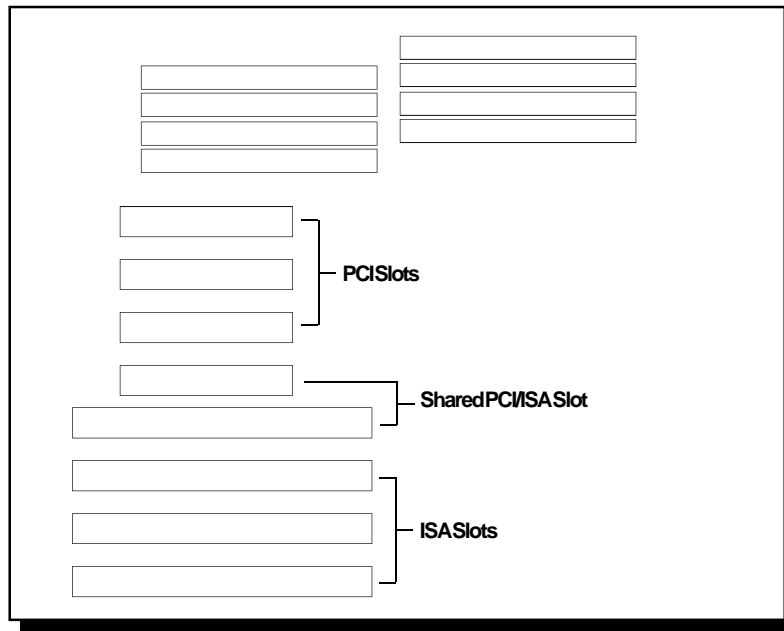

Note:

The BIOS needs to be configured for the PCI add-on cards installed in the PCI slots. Refer to the PCI Configuration Setup on page 3-9 for more information.

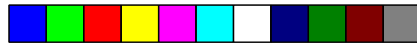

PC/ISA System Board

Installing the System Board

Before installing the system board into your system unit, you should gather the tools you need:

You will need:

- *one medium, flat-bladed screwdriver*
- *one medium Phillips screwdriver*

Step 1

Unlock your system unit. Turn off the power and disconnect all power cords and cables.

Step 2

Remove the system unit cover. Refer to the manufacturer's instructions if necessary.

Step 3

Remove expansion cards seated in any of the expansion slots and detach all connectors from the old system board.

Step 4

Loosen the screws holding the original system board and remove the board from the system. Save the screws.



G586VPM

Step 5

Remove the G586VPM from its original packing box. Be careful to avoid touching all connectors and pins on the board. Please refer to the handling instructions on page 2-2 for proper handling techniques.

Step 6

Insert the SIM modules into the SIMM banks on the G586VPM. The quantity and location of the SIM modules is dependent upon the memory configuration and type of modules you intend to use.

Step 7

Set the corresponding jumpers.

Step 8

Install the prepared G586VPM system board into the case and replace the screws.

Step 9

Reinstall all cards and connectors and replace the system unit cover. Reconnect all power cords and cables.



PC/ISA System Board

❖ *Initial Setup Program*

After you power up your system, the BIOS message appears on your screen and the memory count begins.

After the memory test, the following message will appear on the screen:

Press DEL to enter setup

If the message disappears before you respond, restart your system or press the “Reset” button. You may also restart the system by pressing the <Ctrl> <Alt> keys. If you do not press these keys at the correct time and the system does not boot, the following error message will appear:

Press Del to enter Setup

If you have set a password and selected “System” in the Security Option of the BIOS Feature Setup menu, you will be prompted for the password everytime the system is rebooted or any time you try to enter Setup. Type in the correct password and press <Enter>.

If you selected “Setup” in the Security Option, you will be prompted for the password only when you try to enter Setup. Refer to the “BIOS Features Setup” section for more information.



G586VPM

Award BIOS CMOS Setup Utility

Press <Ctrl> <Alt> <Esc> or simultaneously to enter the Setup utility. A screen similar to the one below will appear.

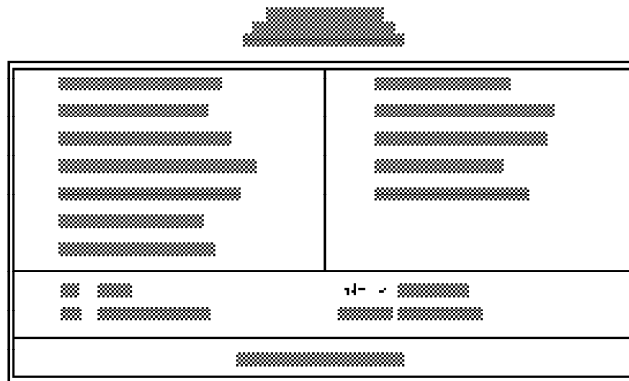

Use the arrow keys to highlight the option you want and press <Enter>.

Standard CMOS Setup

Use the arrow keys to highlight “Standard CMOS Setup” and press <Enter>, a screen similar to the one on the next page will appear.



PC/ISA System Board

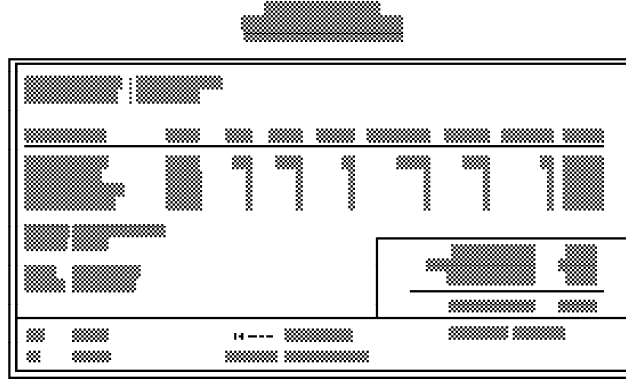

Date and Time

Sets the time and date for the system. Press <F3> for the calendar.

Primary Master, Primary Slave, Secondary Master and Secondary Slave

If you have added an IDE drive, you must select the appropriate type for the drive. You may use the "IDE HDD Auto Detection" from the main CMOS setup menu or you can set it manually. The G586VPM has 46 pre-set types and one user-definable type. Use the <Page Up> or <Page Down> keys to select the appropriate type for the drive.

The table in Appendix G gives a complete listing of the available drive types. Any given drive must be set to one specific drive-type number. Please refer to your IDE drive documentation to find the appropriate type number.

If none of the pre-set types are appropriate for your drive, choose "User", which is the user-definable type. To use this type, highlight either the drive you want to set:

3-3 ◆ Initial Setup Program



Primary Master, Primary Slave, Secondary Master or Secondary Slave. Use the arrow keys until type “User” is showing. Fill in all the parameters as specified by the drive manufacturer. If a drive is not installed, select “None” and press <Enter>.

Drive A and Drive B

These options are used to select the type of floppy disk drives installed in your system. If either of the drives is not present, select “None.” Make sure you choose the correct drive type; otherwise, your system might improperly format the device.

Video

This is used to select the type of video adapter installed in your system.

Halt on

The system will halt if an error is detected during power up.

No Errors: The system boot will not stop for any detected errors.

All Errors: The system will stop whenever the BIOS detects a non-fatal error.

All, But Keyboard: The system will stop for any errors except a keyboard error.

All, But Diskette: The system will stop for any errors except a disk error.

All, But Disk/Key: The system will stop for any errors except a keyboard or disk error.



PC/ISA System Board

Memory

The lower right hand corner shows the base memory size, extended memory size, and the other memory size of your system. You cannot alter these items; your computer automatically detects and displays them.

The Other Memory size refers to the memory located in the 2MB to 256MB address space. This is the memory used for different applications. DOS uses this area to load device drivers to keep as much base memory free for application programs. Most use this for the Shadow RAM.

When you are through making changes in the Standard CMOS Setup, press <Esc> to return to the main menu.

BIOS Features Setup

Use the arrow keys to highlight “BIOS Features Setup” and press <Enter>, a screen similar to the one on the next page will appear.





G586VPM

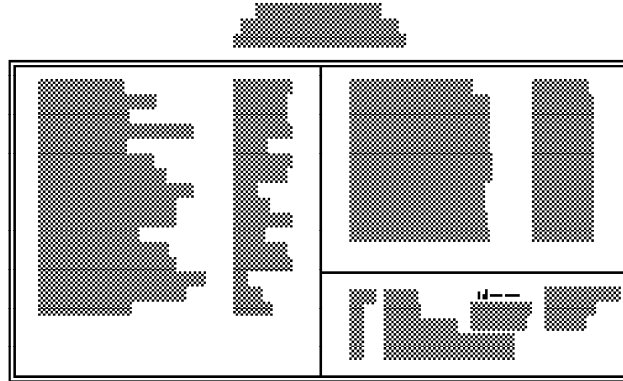

The Virus Warning option may be set to “enabled” or “disabled”. When enabled, the BIOS issues a warning when any program or virus sends a Disk Format command or attempts to write to the boot sector of the hard disk drive.

If you choose “System” in the Security Option, you will be prompted for a password every time you cold boot your system or access setup. If you choose “Setup”, you will be prompted for a password only when trying to access setup.

If the changes you made are incorrect or you change your mind, press <F6> or <F7> to return to the default settings. Press <Esc> after making the changes to return to the main menu.



PCMSA System Board

Chipset Features Setup

The G586VPM uses VLSI chipset. The Chipset Features Setup allows you to modify some functions to optimize system performance. It also allows you to enable, disable or select the port address of the built-in serial ports, parallel port, floppy disk controller and hard disk controller.

If you press <Enter>, a screen similar to the one below will appear.

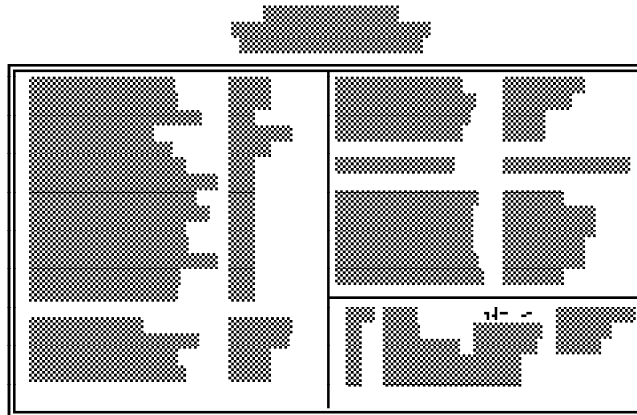

Use the arrow keys to move the highlight bar to the option you wish to change or modify. Use the <Page Up>, <Page Down>, <+> or <-> keys to make the corresponding changes.

If the changes you made are incorrect or you change your mind, press <F6> or <F7> to return to the default settings. Press <Esc> after making the changes to return to the main menu.



Power Management Setup

Use the arrow keys to highlight the “Power Management Setup” and press <Enter>, a screen similar to the one below will appear.

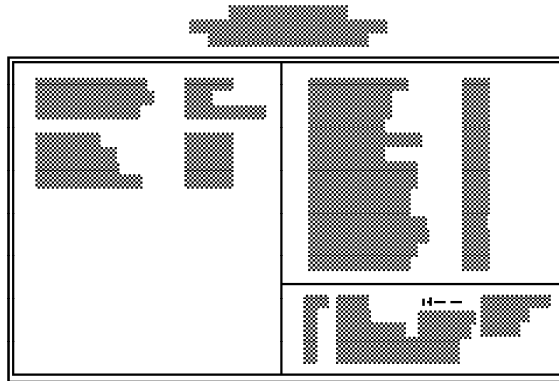

Choosing “User Defined” in the Power Management option will allow you to set the time of the power management features. “Min Power Saving” and “Max Power Saving” will set the minimum and maximum value of these options respectively. Choose “Disabled” if you do not wish your system to enter the power saving mode.

Note:

The above Power Management Setup configuration will not use any of the power management features at all since Power Management is disabled.



PC/ISA System Board

If you want your computer to resume an IRQ event, you can enable that IRQ. For example, if you have a network card installed that uses IRQ 5, you may want to turn IRQ 5 to ON to allow the computer to resume when the network polls the system.

PCI Configuration Setup

Use the arrow keys to highlight “PCI Configuration Setup” and press <Enter>, a screen similar to the one below will appear.

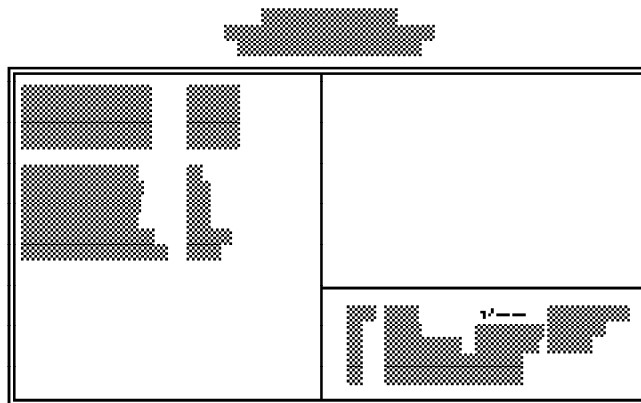

The G586VPM system board supports four PCI master/slave slots. Each slot may be assigned INT A, B, C, D or Auto if the card installed in the slot requires an interrupt. Each INT may then be assigned an IRQ value.

Note:

We recommend that you assign all slots to Auto.

3-9 ♦ Initial Setup Program



Load BIOS Defaults

If, for some reason, the CMOS becomes corrupted, the system can be reconfigured with the default values stored in the ROM chips. The BIOS Setup default values provide the slowest but most reliable system performance.

Highlight this option on the main menu and press <Enter>. The message below will appear.

Load BIOS Defaults (Y/N)? N

Type “Y” and press <Enter> to return to the BIOS setup default values. After pressing <Enter>, you will be returned to the main menu.

Load Setup Defaults

The Setup defaults are similar to the BIOS Setup defaults. These defaults are the most stable and are the standard values for the system.

Highlight this option on the main menu and press <Enter>. The message below will appear.

Load Setup Defaults (Y/N)? N

Type “Y” and press <Enter> to return to the Setup default values. After pressing <Enter>, you will be returned to the main menu.

To configure your system for optimum performance, you must reset the options under the Chipset Features Setup. It is advised you seek help from a technical engineer, otherwise, the system will not function properly.

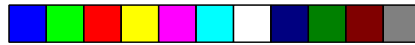

PC/ISA System Board

Password Setting

If you want to set a password, make sure that the Security Option under the BIOS Features Setup is set to “System” or “Setup”. Refer to the BIOS Features Setup option for more information.

Use the arrow keys to highlight the Password Setting option and press <Enter>. The message below will appear.

Enter Password:

Type in the password. You are limited to eight characters. Type in a password that is eight characters long or shorter. When done, the message below will appear:

Confirm Password:

You are asked to verify the password. Type in exactly the same password. If you type in a wrong password, you will be prompted to enter the correct password again. Otherwise, enter a new password.

To delete or disable the password function, simply press <Enter> instead of typing in a new password. Press the <Esc> key to return to the main menu.

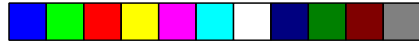

G586VPM

IDE HDD Auto Detection

This option detects the hard disk parameters for the hard disk drives installed in your system. Highlight this option and press <Enter>. A screen similar to the one below will appear.

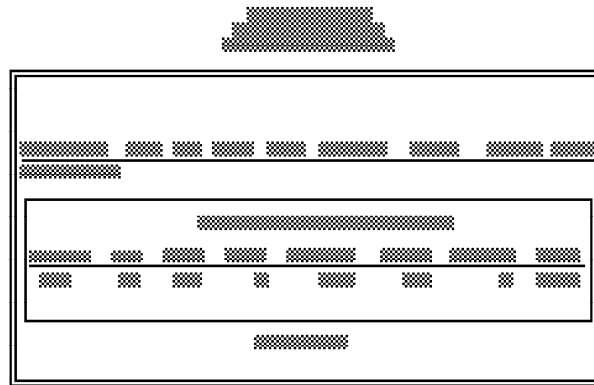

The screen displays the parameters detected and allows you to accept or reject the parameters. Type “Y” and press <Enter> to accept the parameters or press <Esc> to abort. If you select “Y”, the parameters of the hard disk will be displayed in the Standard CMOS Setup.

HDD Low Level Format

This option will format, set the interleave mode and do a media analysis of your hard drives. Highlight this option and press <Enter>. A screen similar to the one on the next page will appear.



PC/ISA System Board

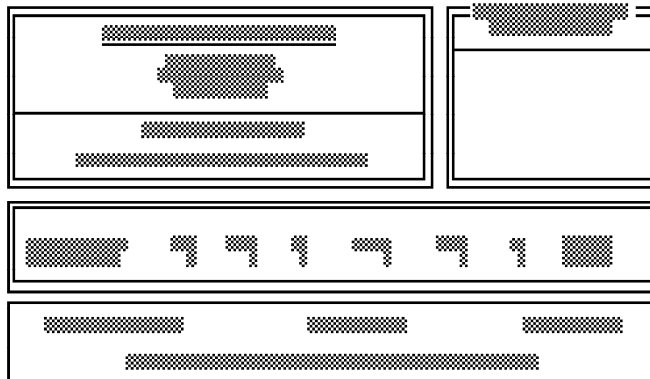

Warning:

Do not attempt to do a low-level format, or you may cause serious damage to the drive. IDE disk drives are already low-level formatted, with any bad-track errors entered, when shipped by the drive manufacturer.

Use the arrow keys to select an option and press <Enter> to accept the option. Press <Esc> when done.

Save & Exit Setup

When all the changes have been made, highlight “Save & Exit Setup” and press <Enter>. The following message will appear:

Save to CMOS and Exit (Y/N)? N



G586VPM

Type “Y” and press <Enter>. The following message will appear:

Reboot System (Y/N)? N

Type “Y” and press <Enter>. The modifications you have made will be written into the CMOS memory, and the system will reboot. You will once again see the initial diagnostics on the screen. If you wish to make additional changes to the setup, press <Ctrl> <Alt> <Esc> or simultaneously after the memory testing is completed.

Exit Without Saving

When you do not want to save the changes you have made, highlight this option and press <Enter>. The following message will appear:

Quit Without Saving (Y/N)? N

Type “Y” and press <Enter>. The system will reboot and you will once again see the initial diagnostics on the screen. If you wish to make any changes to the setup, press <Ctrl> <Alt> <Esc> or simultaneously after the memory testing is completed.



❖ IDE Device Drivers

The G586VPM system board incorporates a high performance PCI IDE interface. It uses the NS PC87410 PCI IDE chip and is equipped with two 40-pin IDE connectors.

The G586VPM comes with two PCI IDE driver diskettes. The "PC87410 PCI IDE Device Drivers" diskette includes drivers for DOS, Windows 3.1x and Windows for Workgroups 3.1x, Windows NT, OS/2 2.1x, and Novell NetWare 3.1x and 4.x. The "PC87410 PCI IDE SCO UNIX Drivers" diskette includes drivers for SCO UNIX 3.2.2 and 3.2.4.

Installation Utility

To run the Installation Utility, type:

A:\INSTALLBAT

The Installation Utility includes the following options.

1. **R/W Multiple** - This option is for setting the "multiple sectors transfer per interrupt". This is not supported by all drives. "Disabled" will be shown in this field if a drive does not support this option. The default value for HDDs supporting this option would be the largest allowed multiple sectors transfer per interrupt.
2. **Track Remapping** - Required to support HDDs larger than 528MB capacity or cylinders greater than 1024. Operating systems other than NetWare require device drivers to work with drives larger than 528MB.



For operating systems that require track remapping, the drive type must be set to “Not Installed” in the CMOS setup.

Example:

A user has four 806MB drives with the following parameters: CYL=1600, HEAD=16, SECTOR=63.

Case 1:

Drive 0 = Master drive of primary IDE	MB Drive C = type 47
Drive 1 = Slave drive of primary IDE	MB Drive D = non-installed
Drive 2 = Master drive of secondary IDE	Unrelated to MB CMOS setup
Drive 3 = Slave drive of secondary IDE	Unrelated to MB CMOS setup

Drive 0 is controlled by the system BIOS. No track remapping is allowed. The maximum capacity that can be used under DOS/Windows is 528MB.

Drives 1, 2 and 3 are not initially controlled by the system BIOS. Track remapping is allowed. The drive's full capacity is available under DOS/Windows.

Case 2:

Drive 0 = Master drive of primary IDE	MB Drive C = type 47
Drive 1 = Slave drive of primary IDE	MB Drive D = type 47
Drive 2 = Master drive of secondary IDE	Unrelated to MB CMOS setup
Drive 3 = Slave drive of secondary IDE	Unrelated to MB CMOS setup

Drives 0 and 1 are initially controlled by the system BIOS. No track remapping is allowed. The maximum capacity that can be used under DOS/Windows is 528MB.

Drives 2 and 3 are not controlled by the system BIOS. Track remapping is allowed. The drive's full capacity is available under DOS/Windows.



PC/ISA System Board

3. **Mode 3** - This option is only for HDDs that support Mode 3.
4. **Logical Block Addressing (LBA)** - This option is only for HDDs that support LBA mode.
5. **Drive Speed** - INSTALL.EXE, under the DOSDRV directory get the hard drive's speed from the DEVICE.LOG file if the information is already present in the file. If the drive's speed information is not present in the DEVICE.LOG file, run "Test" to find out the optimized speed. If you choose "Auto," the controller will select the speed according to the drive's PIO mode. Refer to the on-line Help for more information.

Mode 0:	speed = 1	600ns cycle time
Mode 1:	speed = 6	390ns
Mode 2:	speed = 11	240ns
Mode 3:	speed = 13	180ns

Note:

For a more accurate speed test, a local bus clock greater than or equal to 33MHz is highly recommended.

The following is a table of the drive's speed based on a 33MHz system. Other local bus clocks will give slightly different results.



G586VPM

Speed	CycleTime
0	630ns
1	600ns
2	540ns
3	480ns
4	450ns
5	420ns
6	390ns
7	360ns
8	330ns
9	300ns
10	270ns
11	240ns
12	210ns
13	180ns

Note:

You must reinstall the drivers everytime you add or change your hard drive to gain the maximum performance, otherwise, the driver will use 600ns cycle time for the added or changed drive.

The Installation Utility also includes information about:

1. **Drive #:** [Ch0-M] is Master device on the Primary channel. [Ch0-S] is Slave device on the Primary channel. [Ch1-M] and [Ch1-S] are Master and Slave devices on the Secondary channel.
2. **PIO Mode:** HDD's supported timing mode.
3. **Drive Information:** Model #, Parameter (cylinder/head/sector), and capacity.



PC/ISA System Board

The following explains the INSTALL.BAT and DEVICE.LOG files.

INSTALL.BAT

This is used to configure working hard drives for future installation under DOS, Windows NT and OS/2. The HDD's parameter information includes: R/W Multiple, Track Remapping, Mode 3, LBA, and Drive Speed. After confirming "Yes", the DOS drive will be installed and the configuration information for OS/2 and Windows NT will also be updated to the following files.

DOS:	A:\DOSDRVNSIDE.EXE
Windows NT:	A:\NTDRVATDIS.SYS
OS/2:	A:\OS2DRVNSIDEOS2.ADD

DEVICE.LOG

The DEVICE.LOG file is contained in the DOSDRV directory of the "PC87410 PCI IDE Device Drivers" diskette. By running INSTALL.BAT, you can use the DEVICE.LOG file to log drive speed information. INSTALL.EXE, under the DOSDRV directory, will update a new drive speed information to the DEVICE.LOG file. If it doesn't exist, copy the DEVICE.LOG file to Drive C for future use. For drives that don't have speed information available in the DEVICE.LOG file, you must run "Test" under the "Drive_Speed" option of the Installation Utility. Execute INSTALL.BAT to run the Installation Utility.

Installing the DOS Driver

1. Insert the "PC87410 PCI IDE Device Drivers" diskette into drive A.
2. Type INSTALL.BAT.



G586VPM

Installing the Windows 3.1x and Windows for Workgroups Driver

To install:

1. You must first install the DOS driver. (Run INSTALL.EXE, under the DOSDRV directory, to install the DOS driver).
2. Use Windows File Manager to run:
A:\WINDRV\INSTALL.EXE

To remove:

1. When you install the Windows driver, the original SYSTEM.INI under the Windows directory will be renamed to SYSTEM.001

To remove the Windows driver, rename:
SYSTEM.001 to SYSTEM.INI

The Windows 32-bit driver supports:

1. Two channels with two drives for each channel. This totals to a maximum of four drives.
2. Track Remapping to support hard disk larger than 528MB.
3. Microsoft's 32-bit driver does not support a secondary channel and track remapping. It also does not enable the 32-bit disk access during installation if the target disk is connected to the secondary channel. The 32-bit disk access will be enabled after the Windows driver is installed.

Installing NetWare 3.11, 3.12, SFT-III, 4.00, 4.01 Driver

1. You must first install the DOS driver. (Run INSTALL.EXE, under the DOSDRV directory, to install the DOS driver).
2. Follow the installation procedures of the NetWare installation manual.

Installing the Windows NT v3.x Driver

To install:

1. Insert the "PC87410 PCI IDE Device Drivers" diskette into a floppy drive.
2. Run INSTALL.EXE, under the DOSDRV directory, to configure and choose not to copy files to drive C.
3. After installing the driver, run Windows NT and use the File Manager to run A:\NTDRV\SETUP.EXE.
4. Reboot the system.

To remove:

1. Use the Windows NT File Manager to run:
A:\NTDRV\UNINSTALE.EXE
2. Reboot the system.



Installing the OS/2 v2.1x Driver

To install:

1. Insert the "PC87410 PCI IDE Device Drivers" diskette into a floppy drive.
2. After OS/2 is installed, click the OS/2 System icon. The OS/2 System - Icon View screen will appear. Select the System Setup icon. Another screen will appear. Select the Device Driver Install icon to proceed with the driver installation.
3. The OS/2 2.1 Device Driver Installation screen will appear. Change the source directory to A:\OS2.DRV and select Install.

To remove:

1. When you install the OS/2 driver, the original CONFIG.SYS under the C:\ directory will be renamed as CONFIG.1

To remove the OS/2 driver, rename CONFIG.1 to CONFIG.SYS

C:\COPY CONFIG.1 CONFIG.SYS

2. Reboot the system.

Installing the SCO UNIX Driver

To install:

1. Insert the "PC87410 PCI IDE Device Drivers" diskette into a floppy drive.



PC/ISA System Board

2. Copy the DEVICE.LOG file from the DOSDRV directory of the diskette to /etc by typing the following at the prompt: **doscp a:/dosdrv/device.log /etc**

3. Type:

```
cd /dev  
mv dsk/finstall dsk/finstall.org ; mknod dsk/finstall b 2 164  
mv rdk/finstall rdk/finstall.org ; mknod rdk/finstall c 2 164
```

4. Type: **installpkg**

Note:

It may take a while for the system to respond. Do not touch the keyboard during this operation.

5. Insert the “PC87410 PCI IDE SCO UNIX Drivers” diskette into a floppy drive.
6. Press <Enter> to copy from floppy drive 0.
7. Press <Enter> to install the driver.
8. Type “Y” twice to make the newly built kernel as the booting default.
9. For SCO 3.2.2, type:

```
cd /dev  
mv dsk/f0.org dsk/f0  
mv rdk/f0.org rdk/f0
```

For SCO 3.2.4

```
cd /dev  
mv dsk/finstall.org dsk/finstall  
mv rdk/finstall.org rdk/finstall
```



9. Reboot the system by typing: **haltsys**

To remove:

1. At the UNIX prompt, type: **removepkg**
2. Type “NS-IDE NS (PC87410) PCI-IDE Driver Package.”
3. Press <Enter> to remove the NS-IDE driver.
4. Type “Y” twice to make the newly built kernel as the booting default.
5. Reboot the system by typing: **haltsys**

Installing the CD-ROM Driver

To install:

1. Under Windows 3.1x, run **INSTALL.EXE**.
2. Under the Main group of the Program Manager, double-click the Control Panel icon.
3. The Control Panel screen will appear. Click the Drivers icon.
4. The Drivers screen will appear. Select "Add[MCI] CD Audio" and insert the "PC87410 PCI IDE Device Drives" diskette when prompted.
5. Restart Windows.

❖ *Troubleshooting Checklist*

If you experience difficulty with the G586VPM system board, please refer to the checklist below. If you still cannot isolate the problem, please contact your dealer.

- 1) Check the jumper settings to ensure that the jumpers are properly set. If in doubt, refer to the “Board Configuration” section.
- 2) Verify that all SIM modules are seated securely into the bank sockets.
- 3) Make sure that the SIM modules are in the correct locations.
- 4) Check that all populated memory banks are filled with valid size SIM modules.
- 5) If your board fails to function, place the board on a flat surface and seat all socketed components (gently press each component into the socket).
- 6) If you made changes to the BIOS settings, re-enter setup and load the BIOS defaults.



❖ *Appendix A: Types of Modules*

The G586VPM system board allows you to populate memory with 1Mx36, 2Mx36, 4Mx36 and 8Mx36 SIM modules. The following modules have been tested with this board. Most untested brands will work but a few may fail to do so.

For SIM 1Mx36 Modules

Brand	Chip Number
Toshiba	TC511000AJL
OKI	GT-1M*36B
Fujitsu	81C1000A-70

For SIM 2Mx36 Modules

Brand	Chip Number
OKI	M511000B

For SIM 4Mx36 Modules

Brand	Chip Number
OKI	M514100A-70S

For SIM 8Mx36 Modules

Brand	Chip Number
OKI	M514100AL-70K



❖ *Appendix B: System Error Report*

When the BIOS encounters an error that requires the user to correct something, either a beep code will sound or a message will be displayed in a box in the middle of the screen and a message **PRESS F1 TO CONTINUE**, **CTRL-ALT-ESC** or **DEL TO ENTER SETUP** will be shown in the information box at the bottom.

POST Beep

Currently, there is only one beep code in BIOS. This code indicates that a video error has occurred and the BIOS cannot initialize the video screen to display any additional information. This beep code consists of a single long beep followed by two short beeps.

Error Messages

One or more of the following messages may be displayed if the BIOS detects an error during the POST.

CMOS BATTERY HAS FAILED

CMOS battery is no longer functional. It should be replaced. The replacement battery is a Lithium watch battery, 3 Volt or equivalent. Replacing the battery will clear the CMOS and return the CMOS settings to the default values. Refer to the Jumper J13 section of this manual to reset the CMOS.

CMOS CHECKSUM ERROR

Checksum of CMOS is incorrect. This can indicate that CMOS has become corrupt. This error may have been caused by a weak battery. Check the battery and replace if necessary. (See above for battery replacement).

**DISK BOOT FAILURE, INSERT SYSTEM DISK AND PRESS ENTER**

No boot device was found. Insert a system disk into Drive A and press <Enter>. Assuming the system is booted from the hard drive, make sure the controller is inserted correctly and all cables are properly attached. Also, be sure the disk is formatted as a boot device. Then reboot the system.

DISKETTE DRIVES OR TYPES MISMATCH ERROR - RUN SETUP

The type of diskette drive installed in the system is different from the CMOS definition. Run setup to reconfigure the drive type correctly.

DISPLAY SWITCH IS SET INCORRECTLY

Display switch on the motherboard can be set to either monochrome or color. This indicates the switch is set to a different setting than indicated in Setup. Determine which setting is correct, and then either turn off the system and change the jumper, or enter Setup and change the VIDEO selection.

DISPLAY TYPE HAS CHANGED SINCE LAST BOOT

Since last powering off the system, the display adapter has been changed. You must configure the system for the new display type.

ERROR ENCOUNTERED INITIALIZING HARD DRIVE

Hard drive cannot be initialize. Be sure the adapter is installed correctly and all cables are correctly and firmly attached. Also, be sure the correct hard drive type is selected in Setup (refer to Appendix G).

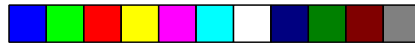

PC/ISA System Board

ERROR INITIALIZING HARD DISK CONTROLLER

Cannot initialize controller. Make sure the card is correctly and firmly installed in the bus. Be sure the correct hard drive type is selected in Setup. Also, check to see if any jumper needs to be set correctly on the hard drive.

FLOPPY DISK CNTRLR ERROR OR NO CNTRLR PRESENT

Cannot find or initialize the floppy drive controller. Make sure the controller is installed correctly and firmly. If there are no floppy drives installed, be sure the Diskette Drive selection in Setup is set to NONE.

KEYBOARD ERROR OR NO KEYBOARD PRESENT

Cannot initialize the keyboard. Make sure the keyboard is attached correctly and no keys are being pressed during the boot.

If you are purposely configuring the system without a keyboard, set the error halt condition in Setup to **HALT ON ALL, BUT KEYBOARD**. This will cause the BIOS to ignore the missing keyboard and continue the boot.

MEMORY ADDRESS ERROR AT...

Indicates a memory address error at a specific location. You can use this location along with the memory map for your system to find and replace the bad memory chips.

MEMORY PARITY ERROR AT...

Indicates a memory parity error at a specific location. You can use this location along with the memory map for your system to find and replace the bad memory chips.



MEMORY SIZE HAS CHANGED SINCE LAST BOOT

Memory has been added or removed since the last boot. Enter Setup and enter the new memory size in the memory fields.

MEMORY VERIFY ERROR AT...

Indicates an error verifying a value already written to memory. Use the location along with your system's memory map to locate the bad chip.

OFFENDING ADDRESS NOT FOUND

This message is used in conjunction with the I/O CHANNEL CHECK and RAM PARITY ERROR messages when the segment that has caused the problem cannot be isolated.

OFFENDING SEGMENT

This message is used in conjunction with the I/O CHANNEL CHECK and RAM PARITY ERROR messages when the segment that has caused the problem has been isolated.

PRESS A KEY TO REBOOT

This will be displayed at the bottom screen when an error occurs that requires a reboot. Press any key and the system will reboot.

PRESS F1 TO DISABLE NMI, F2 TO REBOOT

When BIOS detects a Non-maskable Interrupt condition during boot, this will allow NMI to be disabled and continue to boot. You can also reboot the system with the NMI enabled.



PC/ISA System Board

RAM PARITY ERROR - CHECKING FOR SEGMENT

Indicates a parity error in Random Access Memory.

SYSTEM HALTED, (CTRL-ALT-DEL) TO REBOOT...

Indicates the present boot attempt has been aborted and the system must be rebooted. Press and hold down the CTRL and ALT keys and press DEL simultaneously.





G586VPM

❖ *Appendix C: Memory & I/O Maps*

Memory Address Map

Address	Name	Function
0000000 to 009FFFF	640K System Board RAM	System Board Memory
00A0000 to 00BFFFF	128K Video Display Memory	Reserved for Graphics Display Memory
00C0000 to 00EFFFF	192K I/O Expansion ROM	Reserved for ROM on I/O Adapter Card
00F0000 to 00FFFFFF	64K ROM on the System Board	System Board BIOS
0100000 to 3FFFFFF	Maximum Memory 128M	System Board Memory



PC/ISA System Board

I/O Address Map

I/O Address	Function
000-01F	DMA Controller 1, 8237A-5
020-03F	Interrupt Controller 1, 8259A, Master
040-05F	Timer, 8254-2
060-06F	8742 (Keyboard Controller)
070-07F	Real-time Clock, NMI (Non-maskable Interrupt) Mask
080-09F	DMA Page Memory, 74LS612
0A0-0BF	Interrupt Controller 2, 8259A
0C0-0DF	DMA Controller 2, 8237A-5
0E8	Shadow RAM and Cache Control Bit
0F0	Clear Numeric Processor Extension Busy
0F1	Reset Numeric Processor Extension
0F8-0FF	Numeric Processor Extension
1F0-1F8	Fixed Disk
200-207	Game I/O
278-27F	Parallel Printer Port 2
2F8-2FF	Serial Port 2
300-31F	Prototype Card
360-36F	Reserved
378-37F	Parallel Printer Port 1
380-38F	SDLC, Bisynchronous 2
3A0-3AF	Bisynchronous 1
3B0-3BF	Monochrome Display and Printer Adapter
3C0-3CF	Reserved
3D0-3DF	Color/Graphics Monitor Adapter
3F0-3F7	Diskette Controller
3F8-3FF	Serial Port 1

Note:

The I/O address hex 000 to 0FF are reserved for the system board I/O. Hex 100 to 3FF are available on the I/O channels.

❖ Appendix D: PCI I/O Pin Assignments

Component Side	B	A	Solder Side
	-12V	-01 -	TRST#
	TCK	-02 -	+12V
	Ground	-03 -	TMS
	TDO	-04 -	TDI
	+5V	-05 -	+5V
	+5V	-06 -	INTA#
	INTB#	-07 -	INTC#
	INTD#	-08 -	+5V
	PRSNT1#	-09 -	Reserved
	Reserved	-10 -	+5V (I/O)
	PRSNT2#	-11 -	Reserved
	Ground	-12 -	Ground
	Ground	-13 -	Ground
	Reserved	-14 -	Reserved
	Ground	-15 -	RST#
	CLK	-16 -	+5V (I/O)
	Ground	-17 -	GNT#
	REQ#	-18 -	Ground
	+5V (I/O)	-19 -	Reserved
	AD[31]	-20 -	AD[30]
	AD[29]	-21 -	+3.3V
	Ground	-22 -	AD[28]
	AD[27]	-23 -	AD[26]
	AD[25]	-24 -	Ground
	+3.3V	-25 -	AD[24]
	C/BE[3]#	-26 -	IDSEL
	AD[23]	-27 -	+3.3V
	Ground	-28 -	AD[22]
	AD[21]	-29 -	AD[20]
	AD[19]	-30 -	Ground
	+3.3V	-31 -	AD[18]
	AD[17]	-32 -	AD[16]
	C/BE[2]#	-33 -	+3.3V
	Ground	-34 -	FRAME#
	IRDY#	-35 -	Ground
	+3.3V	-36 -	TRDY#
	DEVSEL#	-37 -	Ground
	Ground	-38 -	STOP#
	LOCK#	-39 -	+3.3V
	PERR#	-40 -	SDONE
	+3.3V	-41 -	SBO#
	SERR#	-42 -	Ground
	+3.3V	-43 -	PAR
	C/BE[1]#	-44 -	AD[15]
	AD[14]	-45 -	+3.3V
	Ground	-46 -	AD[13]
	AD[12]	-47 -	AD[11]
	AD[10]	-48 -	Ground
	Ground	-49 -	AD[09]
	AD[08]	-52 -	C/BE[0]#
	AD[07]	-53 -	+3.3V
	+3.3V	-54 -	AD[06]
	AD[05]	-55 -	AD[04]
	AD[03]	-56 -	Ground
	Ground	-57 -	AD[02]
	AD[01]	-58 -	AD[00]
	+5V (I/O)	-59 -	+5V (I/O)
	ACK64#	-60 -	REQ64#
	+5V	-61 -	+5V
	+5V	-62 -	+5V



PC/ISA System Board

❖ Appendix E: ISA I/O Pin Assignments

B		A
Gnd	- 01 -	-I/OChck
ResetDrv	- 02 -	SD7
+5VDC	- 03 -	SD6
IRQ9	- 04 -	SD5
-5VDC	- 05 -	SD4
DRQ2	- 06 -	SD3
-12VDC	- 07 -	SD2
OAS	- 08 -	SD1
+12VDC	- 09 -	SD0
Gnd	- 10 -	-I/OChrdy
-SEMEMW	- 11 -	AEN
-SEMEMR	- 12 -	SA19
-IOW	- 13 -	SA18
-IOR	- 14 -	SA17
-Dack3	- 15 -	SA16
-DRQ3	- 16 -	SA15
-Dack1	- 17 -	SA14
DRQ1	- 18 -	SA13
-Refresh	- 19 -	SA12
CLK	- 20 -	SA11
IRQ7	- 21 -	SA10
IRQ6	- 22 -	SA9
IRQ5	- 23 -	SA8
IRQ4	- 24 -	SA7
IRQ3	- 25 -	SA6
-Dack2	- 26 -	SA5
T/C	- 27 -	SA4
Bale	- 28 -	SA3
+5VDC	- 29 -	SA2
O/S	- 30 -	SA1
Gnd	- 31 -	SA0

D		C
-MemCS16	- 01 -	SBHE
-I/OCS16	- 02 -	LA23
IRQ10	- 03 -	LA22
IRQ11	- 04 -	LA21
IRQ12	- 05 -	LA20
IRQ13	- 06 -	LA19
IRQ14	- 07 -	LA18
-Dack0	- 08 -	LA17
DRQ0	- 09 -	-Memr
-Dack5	- 10 -	-Memw
DRQ5	- 11 -	SD08
-Dack6	- 12 -	SD09
DRQ6	- 13 -	SD10
-Dack7	- 14 -	SD11
DRQ7	- 15 -	SD12
+5VDC	- 16 -	SD13
-Master	- 17 -	SD14
Gnd	- 18 -	SD15

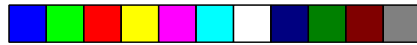

G586VPM

❖ *Appendix F: Connector Pin Assignments*

Connectors

Connector J2
Reset Switch Connector

Pin	Function
1	Reset
2	Ground

Connector J3
Speaker Connector

Pin	Function
1	Signal
2	None
3	Ground
4	+5V

Connector J4
Turbo Switch Connector

Pin	Function
1	Not connected
2-3 On	Low Speed
2-3 Off	Turbo (Normal) Speed



PC/ISA System Board

Connector J5
Keylock Connector

Pin	Function
1	LED Signal
2	Reserved
3	Ground
4	Keylock Signal
5	Ground

Connector J6
PCI IDE LED

Pin	Function
1	LED (+)
2	LED (-)

Connector J7
Disk Active

Pin	Function
1	Signal
2	Grd



G586VPM

Connector J11
PS/2 Mouse Connector

Pin	Function
1	Mouse Data
2	Reserved
3	Ground
4	+5V
5	Mouse Clock
6	Reserved

Connectors CN3 and CN6
Primary and Secondary IDE Hard Disk Drive Connectors

Pin	Function
1	-Reset
2	Ground
3	D7
4	D8
5	D6
6	D9
7	D5
8	D10
9	D4
10	D11
11	D3
12	D12
13	D2
14	D13
15	D1
16	D14

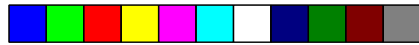

PC/ISA System Board

Pin	Function
17	D0
18	D15
19	Ground
20	Reserved
21	Reserved
22	Ground
23	-IOW
24	Ground
25	-IOR
26	Ground
27	Reserved
28	BALE
29	Reserved
30	Ground
31	IRQ14
32	IOCS16
33	SA1
34	Reserved
35	SA0
36	SA2
37	HCS0
38	HCS1
39	LED
40	Ground

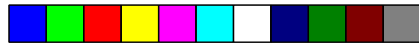

G586VPM

Connector CN4
Floppy Disk Drive Connector

Pin	Function
1	Ground
2	DENSEL
3	Ground
4	Reserved
5	Ground
6	Drate0
7	Ground
8	Index
9	Ground
10	MTR0
11	Ground
12	DR1
13	Ground
14	DR0
15	Ground
16	MTR1
17	Drate1
18	Dir
19	Ground
20	Step
21	Ground
22	Write Data
23	Ground
24	Write Gate
25	Ground

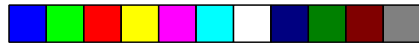

PC/ISA System Board

Pin	Function
26	Track 0
27	MSEN
28	Wr Protect
29	Ground
30	Read Data
31	Ground
32	Head Select
33	Ground
34	Disk Change

Connector CN5 Parallel Printer Port

Pin	Function
1	-Strobe
2	Data 0
3	Data 1
4	Data 2
5	Data 3
6	Data 4
7	Data 5
8	Data 6
9	Data 7
10	-Ack
11	Busy
12	Paper Empty
13	Select
14	-Autofd
15	-Error
16	-Init

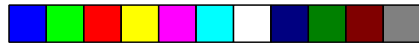

G586VPM

Pin	Function
17	-Sctin
18	Ground
19	Ground
20	Ground
21	Ground
22	Ground
23	Ground
24	PNF
25	Ground

Connectors CN7 and CN8

Primary (COM-A) and Secondary (COM-B) Serial Ports

Pin	Function
1	DCD (Data Carrier Detect)
2	RX (Receive Data)
3	TX (Transmit Data)
4	DTR (Data Terminal Ready)
5	Ground (Signal Ground)
6	DSR (Data Set Ready)
7	RTS (Request to Send)
8	CTS (Clear to Send)
9	RI (Ring Indicator)



PCMSA System Board

❖ Appendix G: Award BIOS Hard Disk Table

Type	Size (MB)	Cylinders	Heads	Sectors	Write Precomp	Land Zone	Example Model
1	10	306	4	17	128	305	TEAC SD510, MMI 112, 5412
2	20	615	4	17	300	615	Seagate ST225, ST4026
3	30	615	6	17	300	615	
4	62	940	8	17	512	940	
5	46	940	6	17	512	940	
6	20	615	4	17	None	615	Seagate ST125, Tandon TM262
7	30	462	8	17	256	511	
8	30	733	5	17	None	733	Tandon TM 703
9	112	900	15	17	None	901	
10	20	820	3	17	None	820	
11	35	855	5	17	None	855	
12	49	855	7	17	None	855	
13	20	306	8	17	128	319	Disctron 526, MMI M125
14	42	733	7	17	None	733	
15				(Reserved)			
16	20	612	4	17	0	663	Microscience HH725, Syquest 3250, 3425
17	40	977	5	17	300	977	
18	56	977	7	17	None	977	
19	59	1024	7	17	512	1023	
20	30	733	5	17	300	732	
21	42	733	7	17	300	732	
22	30	306	5	17	300	733	Seagate ST4038
23	10	977	4	17	0	336	
24	40	1024	5	17	None	976	Seagate ST4051
25	76	1224	9	17	None	1023	Seagate ST4096
26	71	1224	7	17	None	1223	Maxtor 2085
27	111	1224	11	17	None	1223	Maxtor 2140, Priam S14
28	152	1024	15	17	None	1223	Maxtor 2190, Priam S19



G586VPM

Type	Size (MB)	Cylinders	Heads	Sectors	Write Precomp	Land Zone	Example Model
29	68	1024	8	17	None	1023	Maxtor 1085, Micropolis 1325
30	93	918	11	17	None	1023	Maxtor 1105 1120, 4780
31	83	925	11	17	None	1023	Maxtor 1170
32	69	1024	9	17	None	926	CDC 9415
33	85	1024	10	17	None	1023	
34	102	1024	12	17	None	1023	
35	110	1024	13	17	None	1023	
36	119	1024	14	17	None	1023	
37	17	1024	2	17	None	1023	
38	136	1024	16	17	None	1023	
39	114	918	15	17	None	1023	Maxtor 1140, 4380
40	40	820	6	17	None	820	Seagate ST251
41	42	1024	5	17	None	1023	Seagate 4053
42	65	1024	5	26	None	1023	Miniscribe 3053/6053 RLL
43	40	809	6	17	None	852	Miniscribe 3650
44	61	809	6	26	None	852	Miniscribe 3675 RLL
45	100	776	8	33	None	775	Conner CP3104
46	203	684	16	38	None	685	Conner CP3204
User Defined							



G586VPM

Rev. A
System Board
User's Manual



- 25141203 -

