



G586SP

G586SP AIO

Rev. 0+
System Board
User's Manual



- D29160527 -





❖ **Copyright 1996 by DFI, Inc.**

All rights reserved.

No part of this document may be copied, reproduced in any form, or by any means or used to make any transformation/adaptation without the prior written consent of DFI, Inc.

DFI, Inc. makes no warranties with respect to this documentation and disclaims any implied warranties of merchantability, quality, or fitness for any particular purpose. The information in this document is subject to change without notice. DFI, Inc. reserves the right to make revisions to this publication and to make changes to any and/or all parts of its content, at any time, without obligation to notify any person or entity of such changes. Further, DFI, Inc. assumes no responsibility for any errors that may appear in this document.

DFI is a registered trademark, G586SP and G586SP AIO are trademarks of Diamond Flower, Inc. All other product names mentioned are trademarks or registered trademarks of their respective companies.



❖ **FCC Statement on Class B**

This equipment has been tested and found to comply with the limits for a Class B digital device, pursuant to Part 15 of the FCC rules. These limits are designed to provide reasonable protection against harmful interference when the equipment is operated in a residential installation. This equipment generates, uses and can radiate radio frequency energy and, if not installed and used in accordance with the instruction manual, may cause harmful interference to radio communications. However, there is no guarantee that interference will not occur in a particular installation. If this equipment does cause harmful interference to radio or television reception, which can be determined by turning the equipment off and on, the user is encouraged to try to correct the interference by one or more of the following measures:

- *Reorient or relocate the receiving antenna.*
- *Increase the separation between the equipment and the receiver.*
- *Connect the equipment into an outlet on a circuit different from that to which the receiver is connected.*
- *Consult the dealer or an experienced radio TV technician for help.*

Notice:

1. *The changes or modifications not expressly approved by the party responsible for compliance could void the user's authority to operate the equipment.*
2. *Shielded interface cables must be used in order to comply with the emission limits.*



❖Table of Contents❖

Introduction	6
Features and Specifications	7
Package Checklist	9
Installation Overview	10
Preparing the Area	10
Handling the System Board	11
Tips in Handling the System Board	11
Hardware Installation	12
Board Layout	13
Memory Installation	14
Installing the Modules	16
Jumper Settings	17
Cache Configuration	21
CPU Installation	23
Installation Procedure	24
Clearance Requirements	26
Fan Exhaust	26
Built-in Ports	27
Serial Ports	27
PS/2 Mouse Port	27
Parallel Port	28
Floppy Disk Drive Controller	29
IDE Hard Disk Interface	29
Installing Expansion Cards	32
Software Installation	32
Troubleshooting Checklist	33



Award BIOS CMOS Setup Utility	34
Standard CMOS Setup	35
BIOS Features Setup	38
Chipset Features Setup	39
Power Management Setup	40
PCI Configuration Setup	41
Load BIOS Defaults	42
Load Setup Defaults	42
Password Setting	42
IDE HDD Auto Detection	43
HDD Low Level Format	46
Save & Exit Setup	47
Exit Without Saving	47
System Error Report	48
Appendix A: Award BIOS Hard Disk Table	52
Appendix B: Memory & I/O Maps	54
Appendix C: PCI I/O Pin Assignments	56
Appendix D: ISA I/O Pin Assignments	57
Appendix E: System Overview	58
Appendix F: Connector Pin Assignments	61
Appendix G: VGA MPEG Support Mode List	72

❖ Introduction

The G586SP/G586SP AIO system board offers several advanced features integrated into the system board. Its design is based on the new Peripheral Component Interconnect (PCI) local bus and Industry Standard Architecture (ISA) standards.

The G586SP/G586SP AIO system board provides a 321-pin Zero Insertion Force (ZIF) CPU socket for Pentium™ processors running at 75MHz, 90MHz, 100MHz, 120MHz, 133MHz or 150MHz frequencies. This ZIF socket allows users to easily upgrade CPUs.

The difference between the G586SP and G586SP AIO is that the G586SP AIO comes with a built-in video accelerator for ultimate graphic displays. The VGA controller can display graphic resolutions up to 1024 x 768, 256 colors, 75Hz at 1MB DRAM, and up to 1280x1024, 256 colors, 60Hz at 2MB DRAM. The built-in VGA function also supports video playback, VESA DDC1 and DDC2B.

Both the G586SP and G586SP AIO are equipped with three dedicated PCI slots, two dedicated ISA slots, and one shared PCI/ISA slot. The board has two bus master PCI IDE connectors. Bus mastering reduces CPU utilization during disk transfer resulting more efficient use of CPU resources. The system board is also equipped with two NS16C550A-compatible serial ports, one SPP/ECP/EPP parallel port, one analog VGA port (G586SP AIO model only), a floppy disk drive controller, and one PS/2 keyboard or AT keyboard connector.

The board can support 2MB to 256MB of EDO or fast page mode DRAM (x32 or x36, 60 or 70ns) using 72-pin SIMMs (Single In-line Memory Module).



Features and Specifications

Processor

- Intel® Pentium™ Processor 75/90/100/120/133/150MHz
- Future Pentium™ OverDrive Processor

Chipset

- SiS chipset:
 - SiS5511: PCI/ISA system and cache memory controller
 - SiS5512: PCI local data buffer
 - SiS5513: PCI system I/O
 - SiS6205 PCI graphics and video accelerator (G586SP AIO)
- Winbond W83787F/83877F super I/O controller

System Design

- Unified Memory Architecture (G586SP AIO): 64-bit main memory is shared between the CPU and the graphics controller
- Four 72-pin SIMM sockets
- 2MB to 256MB onboard memory
- Uses EDO or fast page mode x32 or x36 DRAM, 60 or 70ns
- Supports 256KB, 512KB, or 1MB L2 cache, direct-map WB or WT
- Uses 32Kx8, 64Kx8, or 128Kx8 SRAM
- Onboard asynchronous SRAM cache
- Uses Intel® COAST-compatible (Rev. 1.2) 160-pin cache module slot for optional pipelined burst or synchronous cache
- Award BIOS, Windows 95 Plug and Play compatible
- Flash EPROM for easy BIOS upgrades

Energy Efficient Design

- System power management supported
- CPU stopped clock control
- Hardware supports SMI green mode
- Microsoft/Intel APM 1.1 compliant



G586SP/G586SP AIO

- Four power saving modes: Normal, Doze, Sleep, and Suspend

High-Performance 64-Bit Graphics Accelerator (G586SP AIO)

- Accelerated 64-bit graphics controller
- Built-in video accelerator
- Supports VESA DDC1 and DDC2B
- Graphic resolutions (Non-interlaced mode):
 - 1MB: 640x480, 16M colors, 60Hz
 - 800x600, 64K colors, 60Hz
 - 1024x768, 256 colors, up to 75Hz
 - 2MB: 640x480, 16M colors, 75Hz
 - 800x600, 16M colors, 75Hz
 - 1024x768, 64K colors, 75Hz
 - 1280x1024, 256 colors, 60Hz

Two Bus Master PCI IDE Connectors

- PIO Mode 3 & 4 Enhanced IDE (data transfer rate up to 16.6MB/sec.)
- DMA Mode 2 Bus Master IDE (data transfer rate up to 22.2MB/sec.)
- Bus mastering reduces CPU utilization during disk transfer
- ATAPI IDE CD-ROM supported

I/O Interface

- Winbond super I/O controller
- Supports 360KB, 720KB, 1.2MB, and 1.44MB floppy drives
- Two NS 16C550A-compatible enhanced serial ports
- One SPP/ECP/EPP parallel port
- One analog VGA port (G586SP AIO)

Mouse/Keyboard Connectors

- One mini-DIN-6 PS/2 or AT keyboard connector
- One PS/2 mouse port (optional)





G586SP/G586SP AIO

Expansion Slots

- Three dedicated PCI slots
- Two dedicated 16-bit ISA slots
- One shared ISA/PCI slot

PCI Bus Master Drivers

- DOS 5.0 - 6.x
- Windows 95, Windows 3.x
- Windows NT
- OS/2 2.x
- Novell NetWare 3.1x, 4.x
- SCO 2.x, UNIX 3.x

CPU Socket

- 321-pin ZIF socket (Intel Socket 7)
- Option: VRM header

PCB

- 280mm (11.02") x 220mm (8.66")

Package Checklist

The G586SP/G586SP AIO package contains the following items:

- G586SP/G586SP AIO system board
- G586SP/G586SP AIO user's manual
- One 34-pin floppy disk drive cable
- One 40-pin hard disk drive cable
- One 25-pin printer port cable for chassis mounting
- One card-edge bracket for mounting the printer port cable
- One card-edge bracket with serial port cables
- One card-edge bracket with mouse port cable (optional)
- One 16-pin cable for the VGA connector
- One IDE driver diskette
- One set of VGA drivers (G586SP AIO only)
- Cache module (optional)

If any of these items is missing or damaged, please contact your dealer or sales representative for assistance.

❖ Installation Overview

This chapter summarizes the steps in installing the board into your system unit. It also includes a description of the area in which you must work and directions for memory installation. Before installing the system board, obtain the memory you plan to install. Please refer to the memory chart on page 9 for the type of SIM modules needed.

Note:

Do not use 5V SRAM cache as they will not function properly on the system board.

Preparing the Area

Before unpacking the system board, make sure the location you have selected is free of dust and static electricity. Excessive exposure to dust, static electricity, direct sunlight, excessive humidity, extreme cold, and water can damage the operational capabilities of your system board. Avoid placing the unit on surfaces such as carpeted floors. These areas also attract static electricity which can damage some circuits on your system board.

Make sure the power source has a properly grounded, three-pronged socket. It is essential that the power connection be properly grounded for correct functioning of your system board. For further protection, we recommend that you use a surge suppressor. This will protect the system board from damage that may result from a power surge on the electrical line.

Move items that generate magnetic fields away from your system board since magnetic fields can also damage your system board. Once you have selected the ideal location, unpack the system board carefully.



Handling the System Board

Static electrical discharge can damage computer components without causing any signs of physical damage. You must take extra care in handling the system board to ensure against electrostatic buildup.

Tips in Handling the System Board

1. To prevent electrostatic buildup, leave the board in its antistatic bag until you are ready to install it.
2. Wear an antistatic wrist strap.
3. Do all preparation work on a static-free surface with components facing up.
4. Hold the system board by its edges only. Be careful not to touch any of the components, contacts or connections, especially gold contacts, on the board.
5. Avoid touching the pins or contacts on all modules and connectors. Hold modules and connectors by their ends.

Warning:

Electrostatic discharge (ESD) can damage your processor, disk drives, add-in boards, and other components. Perform the upgrade instruction procedures described at an ESD workstation only. If such a station is not available, you can provide some ESD protection by wearing an antistatic wrist strap and attaching it to a metal part of the system chassis. If a wrist strap is unavailable, establish and maintain contact with the system chassis throughout any procedures requiring ESD protection.

Hardware Installation

The following summarizes the basic installation instructions. Before installing the system board into your system unit, you should prepare the tools you will need one medium size, flat-blade screwdriver and one medium Phillips screwdriver.

1. Unlock your system unit. Turn off the power and disconnect all power cords and cables.
2. Remove the system unit cover. Refer to the manufacturer's instructions if necessary.
3. Remove expansion cards seated in any of the expansion slots and detach all connectors from the old system board.
4. Loosen the screws holding the original system board and remove the board from the system. Save the screws.
5. Remove the system board from its original packing box. Be careful to avoid touching all connectors and pins on the board. Please refer to the handling instructions on page 6 for proper handling techniques.
6. Insert the SIMMs into the SIMM banks on the system board. The quantity and location of the SIMMs is dependent upon the memory configuration and type of modules you intend to use.
7. Install the CPU. Be sure pin 1 of the CPU is aligned with pin 1 of the socket.
8. Set the corresponding jumpers.
9. Install the prepared system board into the case and replace the screws.
10. Reinstall all cards and connectors and replace the system unit cover. Reconnect all power cords and cables.



G586SP/G586SP AIO

Board Layout

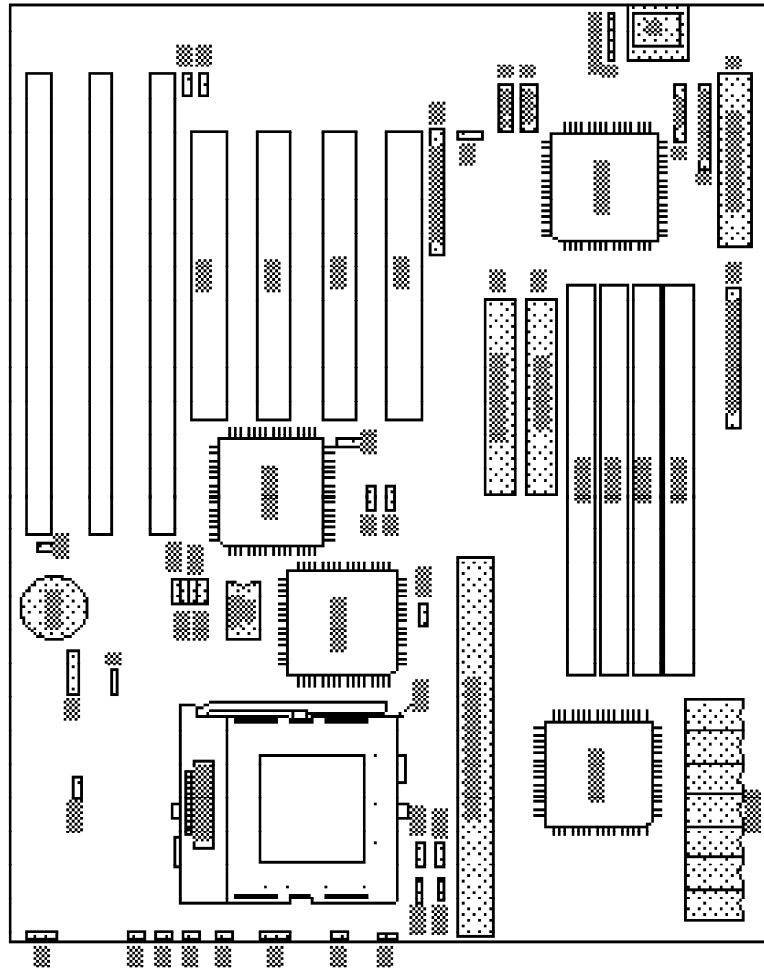

Memory Installation

The system board supports 2MB to 256MB of memory using 72-pin SIMMs (Single In-line Memory Module) with the following two types of memory and sizes: (1) Single-sided SIMMs: 1MB, 4MB, 16MB, and 64MB; (2) Double-sided SIMMs: 2MB, 8MB, and 32MB.

The SIM sockets are divided into two banks on the system board. Each bank consists of 2 SIMM sockets. The board uses x32 or x36, 60 Or 70ns SIMMs. You will need 2 or 4 pieces of SIM modules, depending on the amount of memory you intend to install.

The following table summarizes the bank locations and possible memory configurations:

Memory Size	Bank0		Bank1	
	SIMM1	SIMM2	SIMM3	SIMM4
32-bit mode				
4MB	1Mx36	—	—	—
8MB	2Mx36	—	—	—
16MB	4Mx36	—	—	—
32MB	8Mx36	—	—	—
64MB	16Mx36	—	—	—
64-bit mode				
2MB	256Kx36	256Kx36	—	—
4MB	256Kx36	256Kx36	256Kx36	256Kx36
4MB	512Kx36	512Kx36	—	—
6MB	512Kx36	512Kx36	256Kx36	256Kx36
8MB	512Kx36	512Kx36	512Kx36	512Kx36
8MB	1Mx36	1Mx36	—	—



G586SP/G586SP AIO

Memory Size	Bank0		Bank1	
	SIMM1	SIMM2	SIMM3	SIMM4
10MB	1Mx36	1Mx36	256Kx36	256Kx36
12MB	1Mx36	1Mx36	512Kx36	512Kx36
16MB	1Mx36	1Mx36	1Mx36	1Mx36
16MB	2Mx36	2Mx36	—	—
18MB	2Mx36	2Mx36	256Kx36	256Kx36
20MB	2Mx36	2Mx36	512Kx36	512Kx36
24MB	2Mx36	2Mx36	1Mx36	1Mx36
32MB	2Mx36	2Mx36	2Mx36	2Mx36
32MB	4Mx36	4Mx36	—	—
34MB	4Mx36	4Mx36	256Kx36	256Kx36
36MB	4Mx36	4Mx36	512Kx36	512Kx36
40MB	4Mx36	4Mx36	1Mx36	1Mx36
48MB	4Mx36	4Mx36	2Mx36	2Mx36
64MB	4Mx36	4Mx36	4Mx36	4Mx36
64MB	8Mx36	8Mx36	—	—
66MB	8Mx36	8Mx36	256Kx36	256Kx36
68MB	8Mx36	8Mx36	512Kx36	512Kx36
72MB	8Mx36	8Mx36	1Mx36	1Mx36
80MB	8Mx36	8Mx36	2Mx36	2Mx36
96MB	8Mx36	8Mx36	4Mx36	4Mx36
128MB	8Mx36	8Mx36	8Mx36	8Mx36
128MB	16Mx36	16Mx36	—	—
130MB	16Mx36	16Mx36	256Kx36	256Kx36

Memory Size	Bank0		Bank1	
	SM3	SM4	SM1	SM2
132MB	16Mx36	16Mx36	512Kx36	512Kx36
136MB	16Mx36	16Mx36	1Mx36	1Mx36
144MB	16Mx36	16Mx36	2Mx36	2Mx36
160MB	16Mx36	16Mx36	4Mx36	4Mx36
192MB	16Mx36	16Mx36	8Mx36	8Mx36
256MB	16Mx36	16Mx36	16Mx36	16Mx36

Installing the Modules

A SIM module simply snaps into a socket on the system board. Pin 1 of the SIM module must correspond with Pin 1 of the socket.

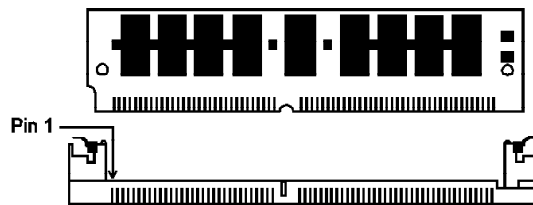

1. Position the SIMM above the socket with the “notch” in the module aligned with the “key” on the socket.
2. Seat the module at a 45° angle into the bank. Make sure it is completely seated. Tilt the module upright until it locks in place in the socket.



Jumper Settings

Jumpers JP7 & JP8, and JP20 & JP21

CPU External Clock Speed and CPU Internal/External Speed Ratio

CPU Speed	CPU External Speed	JP7	JP8	Frequency Ratio	JP20	JP21
75MHz	50MHz	On	On	1.5x	Off	Off
90MHz*	60MHz	On	Off	1.5x	Off	Off
100MHz	66MHz	Off	On	1.5x	Off	Off
120MHz	60MHz	On	Off	2x	Off	On
133MHz	66MHz	Off	On	2x	Off	On
150MHz	60MHz	On	Off	2.5x	On	On
166MHz	66MHz	Off	On	2.5x	On	On
180MHz	60MHz	On	Off	3x	On	Off
200MHz	66MHz	Off	On	3x	On	Off

Jumper JP16

CPU Voltage Type

Set JP16 pins 1-2 On if the voltage of your CPU is 3.3V (Std/VR). Set JP16 pins 3-4 to On if the voltage of your CPU is 3.45 (VRE), which is the default setting.

Jumpers JP10 and JP11

Onboard Cache Memory

Jumper	256KB*	512KB	1MB
JP10	1-2 On	1-2 On	2-3 On
JP11	1-2 On	2-3 On	2-3 On

*Default

G586SP/G586SP AIO

Cache Size	Data SRAM	Tag SRAM	Cacheable Range	
			8 Tag Bits	7 Tag Bits 1 Dirty Bit
256KB	32KBx8x8	8KBx8x1	64MB	32MB
512KB	64KBx8x8	16/32KBx8x1	128MB	64MB
1MB	128KBx8x8	32KBx8x1	256MB	128MB

Note:

You can change the cacheable range settings by using the “L2 (WB) Tag Bit Length” option in the Chipset Features Setup of the Award BIOS utility.

Jumper JP14

Cache Type

Set JP14 pins 1-2 to On if your system board is installed with asynchronous cache SRAM. Set pins 2-3 to On if the system board is installed with burst/pipeline burst cache SRAM. The default is set to pins 2-3 On. If you are installing a cache module, make sure the cache chips have been removed from the SRAM sockets.

Jumper JP18

L1 Cache Mode

Jumper JP18 is used to select the level 1 cache mode. Set pins 1-2 to On for write-back cache and pins 2-3 to On for write-through cache. The default is write-back cache. If you change the setting of JP18, the “L1 Cache Update Mode” option in the Chipset Features Setup menu of the BIOS utility must be changed accordingly.



G586SP/G586SP AIO

Jumper JP2 Display Type Select

Jumper JP2 sets the display adapter to color or mono. The default setting is On which is on the color mode. This jumper must match the type of display adapter installed. If you change your video adapter, make sure this jumper is changed accordingly.

Jumper JP3 PS/2 Mouse

The G586SP/G586SP AIO package includes one optional card-edge bracket with mouse port cable. If you set JP3 to On, Enabled, make sure you connect the PS/2 mouse port to Connector J3. The default is set to On, enabled. If you want to disable this function, set JP3 to Off.

Jumper JP5 (G586SP AIO only) Onboard VGA Interrupt

Set JP5 to On, VGA interrupt enabled, only when using the VGA feature connector. By enabling JP5, you will lose INTA# of PCI Slot 1. The default is set to Off, disabled.

Jumper JP6 PCI Bus Clock

The default of jumper JP6 is Off, CPU Bus Clock/2. If JP6 is set to Off, the CPU's external speed will be divided into 2. You can set JP6 to On, 32MHz, if you are using a 75MHz CPU.

Jumper JP9 Internal/External Battery Selection

The system board comes with an internal lithium battery. The default setting is set to Off for battery conservation during shipment of the board. If you wish to use the internal lithium battery, set JP9 to On. Leave JP9 in its default setting, Off, if you wish to use an external lithium battery (3.6V).



G586SP/G586SP AIO

Jumper JP12 Password/CMOS Clear

If you set a password in the CMOS “Password Setting” option and forgot your password, you can use the CMOS Clear function to return the CMOS back to default and reset your password.

To reset your password, first power off the computer and set pins 2-3 to On. Wait at least one minute and set pins 1-2 to On, then turn on your computer. The password has now been cleared and the CMOS is back to its default. You may enter a new password and/or change to a new setting.

Jumper JP13 Flash EPROM Type

Set JP13 pins 1-2 to On if you are using a 5V Flash EPROM (29F010/29EE010). Set pins 2-3 to On if you are using a 12V Flash EPROM (28F010).



Cache Configuration

The system board supports 3.3V pipeline burst or asynchronous cache SRAM installed in the 160-pin cache module slot. The board can be configured to the following cache sizes: 256KB, 512KB, or 1MB.

Installing the Cache Module

1. Locate the 160-pin cache module slot on the system board. Position the cache module above the slot. Make sure pin 1 of the cache module is aligned with pin 1 of the slot. Carefully slide the module into the slot. Press firmly on top of it to seat it properly.

Note:

Do not use 5V SRAM as they will not function properly. You must first remove the onboard SRAM and/or TAG SRAM and select the appropriate module type on JP14 before installing the cache module.

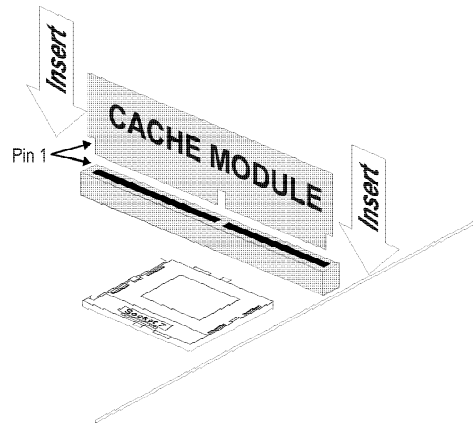



G586SP/G586SP AIO

2. Once the cache module has been installed, make sure the “External Cache” option in the BIOS Features Setup menu of the Award PnP BIOS CMOS Setup Utility is set to “Enabled”.

Note:

With the cache module installed in the cache module slot, the length of the add-on card in PCI Slot 4 is limited to 205 mm only if its components protrude more than 5 mm from the components and/or solder side of the card.





CPU Installation

The system board is equipped with a 321-pin Zero Insertion Force (ZIF) socket (see page 8 for socket location). This socket is designed for easy removal of an old CPU and easy insertion of an upgrade CPU. If you need to apply excessive force to insert the CPU, you are not installing the CPU correctly.

Warning:

Open the socket only if you are actually installing a CPU. The warranty on the original CPU will be voided if the S/N seal is broken.

Do not change any factory CPU speed jumper settings. You do not need to change any jumpers to properly install the 3.3V Pentium Upgrade Processor.

Before proceeding with the upgrade, take note of the following. The microprocessor and heat sink may be hot if the system has been running. To avoid the possibility of a burn, power the system off and let the processor and heat sink cool for 10 minutes.

The 321-pin ZIF socket consists of five rows of pin holes on each side. To prevent improper OverDrive Processor installation, the ZIF socket has a Plug/Keying mechanism. Several holes in the socket are plugged so that OverDrive Processors will go in only one way. If you cannot easily insert the OverDrive Processor, verify that pin 1 of the CPU is aligned with pin 1 of the socket. Be extremely careful to match pin 1 of the CPU with pin 1 of the socket. Only Intel's OverDrive Processor is keyed to prevent improper placement in the ZIF socket. Other Intel CPUs, as well as CPUs from other vendors, can be placed incorrectly and will be permanently damaged if incorrectly placed. Usually, pin 1 of the CPU is marked by a dot or a cut corner.

Installation Procedure

To install a CPU, do the following.

1. Make sure the handle on the side of the ZIF socket is up. To raise the handle, push it down, slightly pull it out to the side, then raise it as far as it will go. The top plate will slide back. Do not use screwdrivers or other tools to open the socket, or you may damage the system or socket. It may be necessary to initially apply a small amount of sideways force to free the handle from its retaining "tab." Once clear of the "tab," the handle will open relatively easily.

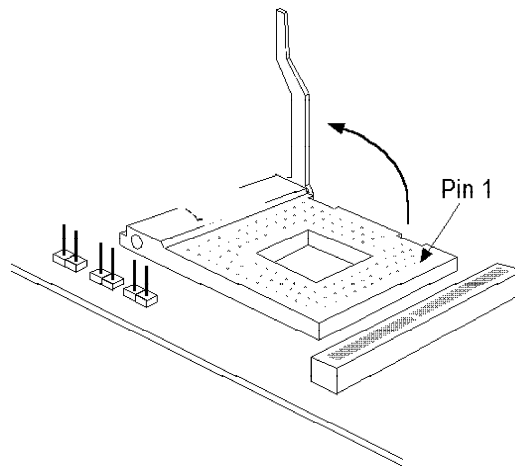

2. Once the lever is completely up, remove the old CPU by carefully lifting it straight out of the socket. You are now ready to insert the new CPU.



G586SP/G586SP AIO

3. Position the CPU above the ZIF socket. Make sure pin 1 of the CPU is aligned with pin 1 of the socket. Lower the chip until the pins are inserted properly in their corresponding holes. Remember that very little force is needed to install the CPU. If the CPU will not insert easily, verify pin 1 of the CPU is aligned with pin 1 of the socket. Applying too much pressure can damage the CPU or the socket.

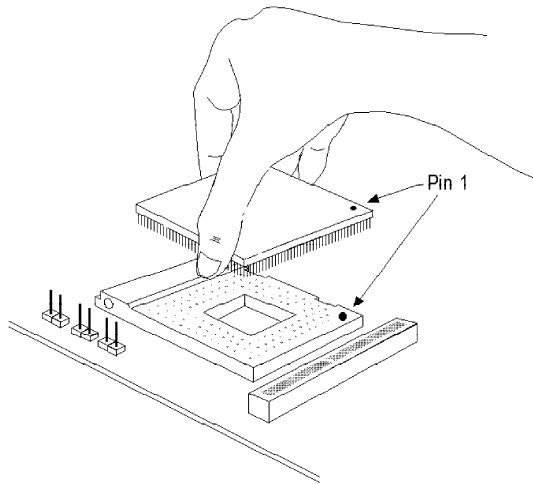

4. Push the handle down until the handle locks into place. The top plate will slide forward. You will feel some resistance as the pressure starts to secure the CPU in the socket. This is normal and will not damage the CPU. However, if the handle is not completely closed, damage to the CPU and/or system board may result.



G586SP/G586SP AIO

Clearance Requirements

The 3.3V Pentium OverDrive Processor comes with a heat sink mounted on top. To maintain proper airflow once the upgrade is installed on the system board, the processor and heatsink require certain space clearances.

The clearance above 3.3V Pentium OverDrive Processor's fan/heatsink must be at least 0.4 inches. The clearance on at least 3 of 4 sides of the processor must be at least 0.2 inches. The cables (for floppy drive, hard drive, CD-ROM, etc.) must be routed clear of the CPU and its airspace.

Fan Exhaust

The CPU must be kept cool by using a fan exhaust configuration in connection with the heatsink. The temperature of the air entering the fan/heatsink cannot exceed 45°C (113°F). The ambient or room temperature must be below 37°C (99°F) for a system installed with the 3.3V Pentium Upgrade Processor.

In order to provide proper airflow to the CPU, all movable obstructions (power supply cables, cards, floppy disk cables) must be clear of the CPU fan/heatsink component in accordance with the space clearance discussed in the CPU installation section of this manual.



Built-in Ports

The system board is equipped with two serial ports, one SPP parallel printer port, one FDD connector, two IDE hard disk shrouded headers, and one optional PS/2 mouse port.

Serial Ports

The built-in serial ports are RS-232C asynchronous communication ports with 16C550A-compatible UARTs that can be used with modems, serial printers, remote display terminals, and other serial devices. They use the following system I/O addresses: (1) COM 1: 3F8h; (2) COM 2: 2F8h.

Connecting the Serial Ports

A 9-pin and 25-pin serial port cables are provided with the motherboard. They are mounted on a card-edge bracket. The upper serial port cable should be used for the COM 1 primary serial port; connect it to Connector J4 on the motherboard. The lower serial port cable should be used for the COM 2 secondary serial port; connect it to Connector J5 on the motherboard. Make sure the colored stripes on the ribbon cables are aligned with pin 1 of Connectors J4 and J5. Please refer to the illustration on the next page.

PS/2 Mouse Port (optional)

The PS/2 mouse port is a 6-pin connector on the system board. Attach the 6-pin mouse port cable, which is mounted on a card-edge bracket, to Connector J3. Make sure the brown wire on the PS/2 mouse port is aligned with pin 1 of Connector J3. Mount the card-edge bracket to the system chassis. Please refer to the illustration on the next page.





G586SP/G586SP AIO

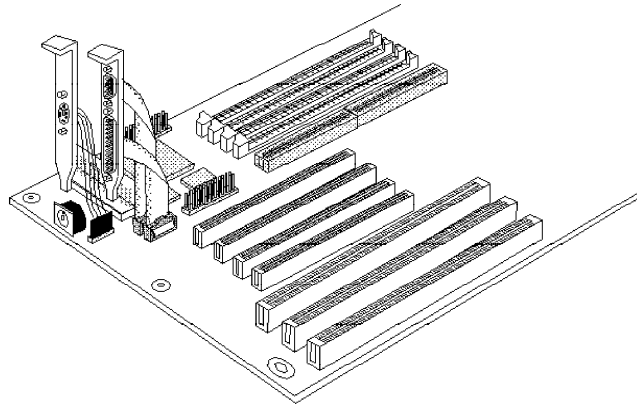

The Serial and Mouse Port Cables

Parallel Port

The system board has a standard connector for interfacing your PC to a parallel printer. This port is compatible with both IBM AT printer ports and the new, high speed, bidirectional Extended Capabilities Port standard. The parallel port on your system board can be set to any of the following system I/O addresses: (1) 3BC-3BE Hex; (2) 378-37A Hex (Default); (3) 278-27A Hex.

Connecting the Parallel Printer Port

Attach the DB-25S printer port cable, which came with the motherboard, to Connector J8. Make sure the colored stripe on the ribbon cable aligns with pin 1 of Connector J8. Use a small nutdriver to mount the cable into a DB-25 cutout in the system chassis.

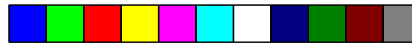

Floppy Disk Drive Controller

The system board has a built-in floppy disk controller that supports two standard floppy disk drives. You can install any 720KB/1.2MB/1.44MB floppy disk drives.

Connecting the Floppy Disk

Step 1

Install the 34-pin header connector into the floppy disk connector (J11) on the system board. The colored edge of the ribbon should be aligned with pin 1 of connector J11.

Step 2

Install the other 34-pin header connector(s) into the disk drive(s) with the colored edge of the daisy chained ribbon cable aligned with pin 1 of the drive edge connector(s). The end-most connector should be attached to the drive you want to designate as Drive A.

IDE Hard Disk Interface

To prevent improper IDE cable installation, each PCI IDE shrouded header has a keying mechanism. The 40-pin connector on the IDE cable can be placed into the header only if pin 1 of the connector is aligned with pin 1 of the header.

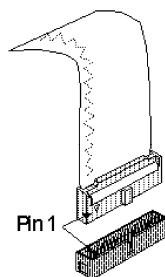

Step 1

If you are connecting two hard drives, install the 40-pin connector of the IDE cable into the primary IDE shrouded header (Connector J12). If you are adding a third or fourth IDE device, install the 40-pin connector of the other IDE cable into the secondary IDE shrouded header (Connector J13).

Step 2

Install the other 40-pin header connector(s) into the device with the colored edge of the ribbon cable aligned with pin 1 of the drive edge connector(s).

Note:

Refer to your disk drive user's manual for information about selecting proper drive switch settings.

Adding a Second IDE Hard Drive

When using two IDE drives, one must be set as the master and the other as the slave. Follow the instructions provided by the drive manufacturer for setting the jumpers, drive type, and/or switches on the drives. No changes are needed on the system board when adding a second hard drive.

It is recommended that the IDE hard drives be from the same manufacturer. In a few cases, drives from two different manufacturers will not function properly when used together. The problem lies in the hard drives, not the system board.

Preparing an IDE Drive for Use

IDE disk drives are already low-level formatted, with any bad-track errors entered, when shipped by the drive manufacturer. Do not attempt to do a low-level format or you may cause serious damage to the drive. To use an IDE drive, you need to enter the drive type into the system's CMOS setup table. Then run FDISK and FORMAT provided with DOS.



G586SP/G586SP AIO

Warning:

Do not run FDISK and FORMAT programs on a drive that has already been formatted or you will lose all programs and data stored on the drive.

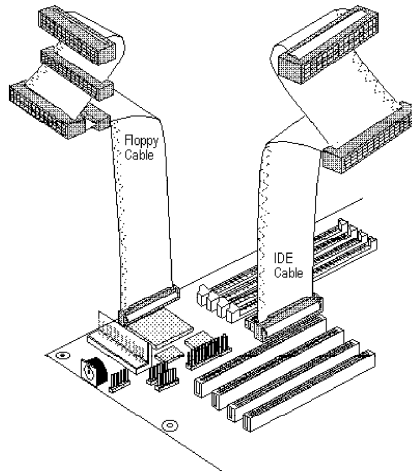

The Floppy Disk Drive and Hard Disk Drive Cables



G586SP/G586SP AIO

Installing Expansion Cards

The system board is equipped with four PCI and three ISA slots. All four PCI slots are bus masters. One PCI slot and one ISA slot are shared. You can only install one card in one or the other of the shared slots at a time; you cannot install devices in both slots.

Due to the size of the CPU with its accompanying heatsink/fan component, the length of the add-in cards in PCI slots 1, 2, and 3 is limited to 205mm (measured from the bracket of the card).

The length of the add-in card in PCI slot 4 is limited to 205mm only if its components protrude more than 5mm from the components and/or solder side of the card. The locations of the expansion slots are shown on page 8.

Note:

The BIOS needs to be configured for the PCI add-on cards installed in the PCI slots. Refer to the "PCI Configuration Setup" chapter presented in the "Initial Setup Program" section of the manual.

Software Driver Installation

To install the IDE and/or VGA driver and utilities supported by the system board, please refer to the "Readme" files provided in the provided diskettes.





❖ Troubleshooting Checklist

If you experience difficulty with the system board, refer to the checklist below. If you still cannot isolate the problem, please contact your dealer.

1. Check the jumper settings to ensure that the jumpers are properly set. If in doubt, refer to the “Board Configuration” section.
2. Verify that all SIMMs are seated securely into the bank sockets.
3. Make sure the SIMMs are in the correct locations.
4. Check that all populated memory banks are filled with correctly sized SIMMs.
5. If your board fails to function, place the board on a flat surface and seat all socketed components (gently press each component into the socket).
6. If you made changes to the BIOS settings, reenter setup and load the BIOS defaults.

❖ Award BIOS CMOS Setup Utility

After you power up your system, the BIOS message appears on your screen and the memory count begins. After the memory test, the following message will appear on the screen:

Press DEL to enter setup

If the message disappears before you respond, restart your system or press the “Reset” button on the front of your computer. You may also restart the system by pressing the <Ctrl> <Alt> and keys at the same time. If you do not press these keys at the correct time and the system does not boot, the following error message will appear:

Press Del to enter Setup

If you have set a password and selected “System” in the Security Option of the BIOS Feature Setup menu, you will be prompted for the password everytime the system is rebooted or any time you try to enter Setup. Type in the correct password and press <Enter>.

If you selected “Setup” in the Security Option, you will be prompted for the password only when you try to enter Setup. Refer to the “BIOS Features Setup” section for more information.

Date and Time

This selection sets the time and date for the system. Press <F3> for the calendar. These items cannot be altered; they are detected and displayed automatically.

Hard Drive Type

This allows you to enter the appropriate specifications for the type of hard disk drive(s) installed in your system. Under the "Type" category, you can select Auto, User, one of 46 predefined drive specifications or None.

Auto

This option indicates that the parameters for your hard disk drive(s) will be automatically detected and displayed when you boot your system.

By default, the LBA mode is selected for a hard disk drive larger than 528 megabytes. If you decide not to accept the LBA mode, you can either specify your selection in the "IDE HDD Auto Detection" menu, or use the User option described below.

User

This type is user definable and allows you to enter the specifications yourself directly from the keyboard. Six categories of information are required: Size, Cylinders, Heads, Precomp, LandZone and Sectors. This information should be provided by your hard disk vendor or system manufacturer. However, we recommend you use the "IDE HDD Auto Detection" which provides a more efficient way to setup your hard drive.

46 Predefined Drive Specifications

The table in Appendix A gives complete listings of the available drive types. Please refer to your hard disk documentation for the appropriate type number.



None

Select <None> and press <Enter> if a hard drive is not installed.

Drive A and Drive B

These options are used to select the type of floppy disk drives installed in your system. If neither drive is present, select "None". Make sure you choose the correct drive type; otherwise, your system might format the device improperly.

Video

This is used to select the type of video adapter installed in your system.

Halt on

This category controls whether the system will halt in case an error is detected during power up.

No Errors:

The system boot will not stop for any detected errors.

All Errors:

The system will stop whenever the BIOS detects a nonfatal error.

All, But Keyboard:

The system will stop for any error except a keyboard error.

All, But Diskette:

The system will stop for any error except a disk error.

All, But Disk/Key:

The system will stop for any error except a keyboard or disk error.





G586SP/G586SP AIO

Memory

The lower right hand corner shows the base memory size, extended memory size, and the other memory size of your system. You cannot alter these items; your computer automatically detects and displays them.

The Other Memory size refers to the memory located in the 640K to 1024K address space. This is the memory used for different applications. DOS uses this area to load device drivers to free base memory for application programs.

When you are through making changes in the Standard CMOS Setup, press <Esc> to return to the main menu.

BIOS Features Setup

Use the arrow keys to highlight “BIOS Features Setup” and press <Enter>, a screen similar to the one below will appear.



ROM PC11S A BIOS(2AS1D D49)
BIOS FEATURES SETUP
AWARD SOFTWARE, INC.



Virus Warning	: Disabled	Video BIOS Shadow	: Enabled
CPU Internal Cache	: Enabled	C8000-CBFFF Shadow	: Disabled
External Cache	: Enabled	CC000-CFFFF Shadow	: Disabled
Quick Power On Self Test	: Disabled	D0000-D3FFF Shadow	: Disabled
Boot Sequence	: A, C	D4000-D7FFF Shadow	: Disabled
Swap Floppy Drive	: Disabled	D8000-DBFFF Shadow	: Disabled
Boot Up Floppy Seek	: Enabled	DC000-DFFFF Shadow	: Disabled
Boot Up NumLock Status	: On		
Boot Up System Speed	: High		
Gate A20 Option	: Fast		
Memory Parity Check	: Disabled		
Typematic Rate Setting	: Disabled		
Typematic Rate (Chars/Sec)	: 6		
Typematic Delay (Msec)	: 250		
Security Option	: Setup	ESC : Quit	↑↓←→ : Select Item
PCI/VGA Palette Snoop	: Disabled	F1 : Help	F10/F11 : Modify
		F5 : Old Values (Shift F2)	: Color
		F6 : Load BIOS Defaults	
		F7 : Load Setup Defaults	



The Virus Warning option may be set to “Enabled” or “Disabled”. When enabled, the BIOS issues a warning when any program or virus sends a Disk Format command or attempts to write to the boot sector of the hard disk drive. If you are installing or running certain operating systems such as Windows 95, please disable the Virus Warning or the operating system may not install nor work.

If you choose “System” in the Security Option, you will be prompted for a password every time you cold boot your system or access setup. If you choose “Setup”, you will be prompted for a password only when trying to access setup.

Use the arrow keys to move the highlight bar to the option you wish to change or modify. Use the <Page Up>, <Page Down>, <+> or <-> keys to make the corresponding changes. Press <Esc> after making the changes to return to the main menu.

Chipset Features Setup

The system board uses the SiS chipset. The Chipset Features Setup allows you to modify some functions to optimize system performance. It also allows you to enable, disable or select the port address of the built-in serial ports, parallel port, floppy disk controller and hard disk controller. If you press <Enter>, a screen similar to the one below will appear.

ROM PCI/ISA BIOS (2A51DD49)
 CHIPSET FEATURES SETUP
 AWARD SOFTWARE, INC.

Auto Configuration	: Enabled	Slow Refresh (1:4)	: Disabled
L1 Cache Update Mode	: WB	ISA Bus Clock Frequency	: PCI/CLK4
L2 Cache Update Mode	: WB	System BIOS Cacheable	: Disabled
L2 (WB) Tag Bit Length	: 7bits	Video BIOS Cacheable	: Enabled
Asyn. SRAM Leadoff Tim.	: R4-W4 CK	Memory Hole At 15M-16M	: Disabled
Asyn. SRAM Burst Tim.	: 2 Ck	VGA Shared Memory Size	: 1MB
Sync. SRAM Leadoff Tim.	: 3 Ck	VGA Memory Clock (MHz)	: 55
DRAM RAS to CAS Delay	: 3 Ck		
RAS Active When Refresh	: 3 Ck		
CAS Delay In Posted-WR	: 1 Ck		
FP DRAMCAS Prec. Timing	: 1 Ck		
FP DRAMRAS Prec. Timing	: 4 Ck		
EDO CAS Pulse Width	: R1-W2 CK		
EDO CAS Precharge Time	: 1 Ck		
EDO MDLE Timing	: 1 Ck		
EDO BRDY# Timing	: 1 Ck		
EDO RAS Precharge Timing	: 3 Ck	ESC : Quit	↑↓←→ : Select Item
EDO RAMW# Power Saving	: Disabled	F1 : Help	PU/PD+/- : Modify
CPU Address Preceding	: Disabled	F5 : Old Values (Shift) F2 : Color	
		F6 : Load BIOS Defaults	
		F7 : Load Setup Defaults	



G586SP/G586SP AIO

Use the arrow keys to move the highlight bar to the option you wish to change or modify. Use the <Page Up>, <Page Down>, <+> or <-> keys to make the corresponding changes.

If the changes you made are incorrect or you change your mind, press <F6> or <F7> to return to the default settings. Press <Esc> after making the changes to return to the main menu.

Power Management Setup

Use the arrow keys to highlight “Power Management Setup” and press <Enter>. A screen similar to the one below will appear.

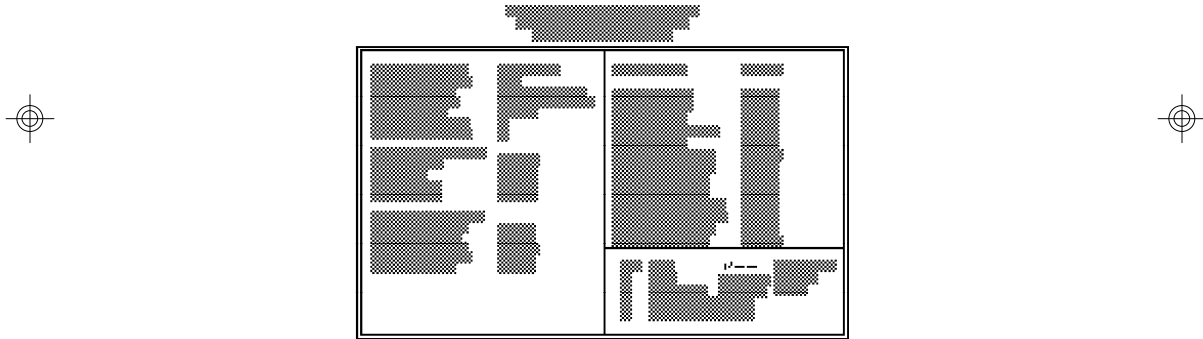

Choosing “Enabled” in the Power Management option will allow you to set Doze Mode, Standby Mode and Suspend Mode. Choose “Disabled” if you do not want your system to enter the power saving mode.



PCI Configuration Setup

Use the arrow keys to highlight “PCI Configuration Setup” and press <Enter>; a screen similar to the one below will appear.

ROMPCMS A BIOS (2ASIDD49)
PCI & ONBOARD I/O SETUP
AWARD SOFTWARE, INC.

PnPBIOS Auto-Config. : Disabled	Primary IDE Prefetch : Both
1st Available IRQ : 10	Secondary IDE Prefetch : Both
2nd Available IRQ : 11	IDE Burst Mode : Disabled
3rd Available IRQ : 9	IDE Post Write : Disabled
4th Available IRQ : 5	IDE HDD Block Mode : Enabled
PCI IRQ Activated By : Level	Onboard FDD Controller : Enabled
PCI IDE IRQ Map To : Enabled	Onboard Serial Port 1 : COM1/3F8
Primary IDE INT# : PCI-Auto	Onboard Serial Port 2 : COM2/2F8
Secondary IDE INT# : A	Onboard Parallel Port : 378H/IRQ7
	Onboard Parallel Mode : Normal
CPU-PCI Post Write Rate : 4 Ck	Serial Port 1 MIDI : Disabled
Latency for CPU-PCI : 2 Ck	Serial Port 2 MIDI : Disabled
CPU-PCI Burst Mem Write : Disabled	
CPU-PCI Post Mem Write : Enabled	
Internal PCI IDE : Both	ESC : Quit ← → : Select Item
IDE Primary Master PIO : Auto	F1 : Help PU/PD/+/ : Modify
IDE Primary Slave PIO : Auto	F5 : Oh Values (Shift) F2 : Color
IDE Secondary Master PIO : Auto	F6 : Load BIOS Defaults
IDE Secondary Slave PIO : Auto	F7 : Load Setup Defaults

The system board supports four PCI slots. Each slot may be assigned INT A, B, C, D if the card installed in the slot requires an interrupt. Each INT may then be assigned an IRQ value. This is done automatically if the “PnP BIOS Auto-Config” option is enabled.



G586SP/G586SP AIO

Load BIOS Defaults

The “Load BIOS Defaults” option loads the troubleshooting default values permanently stored in the ROM chips. These settings are non-optimal and turn off all high performance features. You should use these values only if you have hardware problems. Highlight this option in the main screen and press <Enter>. The message below will appear.

Load BIOS Defaults (Y/N)? N

If you want to proceed, press <Y> and the default settings will be loaded.

Load Setup Defaults

The “Load Setup Defaults” option loads optimized settings from the BIOS ROM. Use the Setup default values as standard values for your system.

Highlight this option on the main menu and press <Enter>. The message below will appear.

Load Setup Defaults (Y/N)? N

Type <Y> and press <Enter> to load the Setup default values.

Password Setting

If you want to set a password, make sure that the Security Option under the BIOS Features Setup is set to “System” or “Setup”. Refer to the BIOS Features Setup option for more information.

Use the arrow keys to highlight the Password Setting option and press <Enter>. The message below will appear.

Enter Password:

Type in the password. You are limited to eight characters.
Type in a password that is eight characters long or shorter.
When done, the message below will appear:

Confirm Password:

You are asked to verify the password. Type in exactly the same password. If you type in a wrong password, you will be prompted to enter the correct password again. Otherwise, enter a new password.

To delete or disable the password function, simply press <Enter> instead of typing in a new password. Press the <Esc> key to return to the main menu.

IDE HDD Auto Detection

This option detects the hard disk parameters for the hard disk drives installed in your system. Highlight this option and press <Enter>. A screen similar to the one on the next page will appear.

ROM PCI/ISA BIOS (2A5IDD49)
CMOS SETUP UTILITY
AWARD SOFTWARE, INC.

HARD DISKS	TYPE	SIZE	CYLS.	HEADS	PRECOMP	LANDZ	SECTOR	MODE
Primary Master :								
Select Primary Master Option (N=Skip): N								
OPTIONS	SIZE	CYLS.	HEADS	PRECOMP	LANDZ	SECTORS	MODE	
1 (Y)	212	683	16	65535	682	38	NORMAL	

Note: Some OSes (like SCO-UNIX) must use "NORMAL" for installation
ESC: Skip



G586SP/G586SP AIO

Enter your choice, and press <Enter> to accept the parameters or press <Esc> to abort. The parameters of the hard disk will be displayed in the Standard CMOS Setup.

Hard Drive Mode

The board supports three HDD modes: Normal, LBA and Large. If your hard disk drive does not support LBA mode, the “LBA” option will not be displayed. If your HDD has 1024 or fewer cylinders, the “Large” option will not be displayed.

Normal Mode

The Normal mode is the generic access mode in which neither the BIOS nor the IDE controller will make any transformations during hard-drive access.

The maximum number of cylinders, heads and sectors for Normal mode are 1024, 16 and 63, respectively.

no.Cylinders	(1024)
x no. Heads	(16)
x no.Sectors	(63)
x bytes per sector	(512)

528 Megabyte

If you set your HDD to Normal mode, the maximum accessible HDD size will be 528 Megabytes even though its physical size may be greater than that.

LBA (Logical Block Addressing) Mode

The LBA mode is a new HDD accessing method to overcome the 528 megabyte limitation. The number of cylinders, heads and sectors shown on the screen may not be the actual number for the HDD.



G586SP/G586SP AIO

During the HDD accessing, the IDE controller will transform the logical address described by the sector, head and cylinder number into its own physical address inside the HDD.

The maximum HDD size supported by the LBA mode is 8.4 Gigabytes. It is obtained by the following formula.

$$\begin{array}{r} \text{no.Cylinders} \quad (1024) \\ \times \text{ no. Heads} \quad (225) \\ \times \text{ no.Sectors} \quad (63) \\ \times \text{ bytes per sector} \quad (512) \\ \hline \end{array}$$

8.4 Gigabyte

Large Mode

The Large mode is the extended HDD access mode supported by the G586SP AIO system board. Some IDE HDDs have more than 1024 cylinders without LBA support (in some cases, you may not want the LBA mode). The system board provides another alternative to support these kinds of HDD.

The BIOS tells the operating system that the number of cylinders is 1/2 of actual and that the number of heads is double the actual. During the disk access, the reverse conversion is done by the INT13h routine.

Example of Large mode:

<u>CYLS.</u>	<u>HEADS</u>	<u>SECTORS</u>	<u>MODE</u>
1120	16	59	NORMAL
560	32	59	LARGE

Maximum HDD size:

$$\begin{array}{r} \text{no.Cylinders} \quad (1024) \\ \times \text{ no. Heads} \quad (32) \\ \times \text{ no.Sectors} \quad (63) \\ \times \text{ bytes per sector} \quad (512) \\ \hline \end{array}$$

1 Gigabyte



Note:

To support LBA or Large mode, address translation software is included in the Award BIOS HDD Service Routine (INT13h). If you are running an operating system that bypasses the BIOS Int13 Service Routine, LBA and Large Mode may fail.

HDD Low Level Format

This option will format, set the interleave mode and do a media analysis of your hard drives. Highlight this option and press <Enter>. A screen similar to the one below will appear.

Hard Disk Low Level Format Utility SELECT DRIVE BAD TRACK LIST PREFORMAT <hr/> Current select drive is : C DRIVE : C CYLINDER : 0 HEAD : 0		NO. C YLS. HEAD <hr/>																																
<table border="1"> <tr> <td>Primary Master</td> <td>: 342</td> <td>332</td> <td>32</td> <td>0</td> <td>664</td> <td>63</td> <td>LBA</td> </tr> <tr> <td>Primary Slave</td> <td>: 0</td> <td>0</td> <td>0</td> <td>0</td> <td>0</td> <td>0</td> <td>Normal</td> </tr> <tr> <td>Secondary Master</td> <td>: 0</td> <td>0</td> <td>0</td> <td>0</td> <td>0</td> <td>0</td> <td>Normal</td> </tr> <tr> <td>Secondary Slave</td> <td>: 0</td> <td>0</td> <td>0</td> <td>0</td> <td>0</td> <td>0</td> <td>Normal</td> </tr> </table>			Primary Master	: 342	332	32	0	664	63	LBA	Primary Slave	: 0	0	0	0	0	0	Normal	Secondary Master	: 0	0	0	0	0	0	Normal	Secondary Slave	: 0	0	0	0	0	0	Normal
Primary Master	: 342	332	32	0	664	63	LBA																											
Primary Slave	: 0	0	0	0	0	0	Normal																											
Secondary Master	: 0	0	0	0	0	0	Normal																											
Secondary Slave	: 0	0	0	0	0	0	Normal																											
Up/Down-Select item ENTER-Accept ESC-Exit/Abort Copyright (c) Award Software, Inc. 1992-94 All Rights Reserved																																		

Warning:

Do not attempt to do a low-level format, or you may cause serious damage to the drive. IDE disk drives are already low-level formatted, with any bad-track errors entered, when shipped by the drive manufacturer.

Use the arrow keys to select an option and press <Enter> to accept the option. Press <Esc> when done.



Save & Exit Setup

When all the changes have been made, highlight “Save & Exit Setup” and press <Enter>. The message below will appear:

Save to CMOS and Exit (Y/N)? N

Type “Y” and press <Enter>. The following message will appear:

Reboot System (Y/N)? N

Type “Y” and press <Enter>. The modifications you have made will be written into the CMOS memory, and the system will reboot. You will once again see the initial diagnostics on the screen. If you wish to make additional changes to the setup, press <Ctrl> <Alt> <Esc> simultaneously or <Del.> after memory testing is done.

Exit Without Saving

When you do not want to save the changes you have made, highlight this option and press <Enter>. The message below will appear:

Quit Without Saving (Y/N)? N

Type “Y” and press <Enter>. The system will reboot and you will once again see the initial diagnostics on the screen. If you wish to make any changes to the setup, press <Ctrl> <Alt> <Esc> simultaneously or <Del.> after memory testing is done.



❖ System Error Report

When the BIOS encounters an error that requires the user to correct something, either a beep code will sound or a message will be displayed in a box in the middle of the screen and a message PRESS F1 TO CONTINUE, CTRL-ALT-ESC or DEL TO ENTER SETUP will be shown in the information box at the bottom.

POST Beep

There is one beep code in BIOS. This code indicates that a video error has occurred and the BIOS cannot initialize the video screen to display any additional information. This beep code consists of a single long beep followed by two short beeps.

Error Messages

One or more of the following messages may be displayed if the BIOS detects an error during the POST.

DISK BOOT FAILURE, INSERT SYSTEM DISK AND PRESS ENTER

No boot device was found. Insert a system disk into Drive A and press <Enter>. If the system normally boots from the hard drive, make sure the controller is inserted correctly and all cables are properly attached. Also be sure the disk is formatted as a boot device. Then reboot the system.

DISKETTE DRIVES OR TYPES MISMATCH ERROR - RUN SETUP

Type of diskette drive installed in the system is different from the CMOS definition. Run setup to reconfigure the drive type correctly.

DISPLAY SWITCH IS SET INCORRECTLY

The display switch on the motherboard can be set to either monochrome or color. This indicates the switch is set to a





different setting than indicated in Setup. Determine which setting is correct, and then either turn off the system and change the jumper, or enter Setup and change the VIDEO selection.

DISPLAY TYPE HAS CHANGED SINCE LAST BOOT

Since last powering off the system, the display adapter has been changed. You must configure the system for the new display type.

ERROR ENCOUNTERED INITIALIZING HARD DRIVE

Hard drive cannot be initialized. Be sure the adapter is installed correctly and all cables are correctly and firmly attached. Also, be sure the correct hard drive type is selected in Setup.

ERROR INITIALIZING HARD DISK CONTROLLER

Cannot initialize controller. Make sure the card is correctly and firmly installed in the bus. Be sure the correct hard drive type is selected in Setup. Also, check to see if any jumper needs to be set correctly on the hard drive.

FLOPPY DISK CNTRLR ERROR OR NO CNTRLR PRESENT

Cannot find or initialize the floppy drive controller. Make sure the controller is installed correctly and firmly. If no floppy drive is installed, be sure the Diskette Drive selection in Setup is set to NONE.

MEMORY SIZE HAS CHANGED SINCE LAST BOOT

Memory has been added or removed since the last boot. Enter Setup and enter the new memory size in the memory fields.

MEMORY VERIFY ERROR AT...

Indicates an error verifying a value already written to memory. Use the location along with your system's memory map to locate the bad chip.





G586SP/G586SP AIO

OFFENDING ADDRESS NOT FOUND

This message is used in conjunction with the I/O CHANNEL CHECK and RAM PARITY ERROR messages when the segment that has caused the problem cannot be isolated.

KEYBOARD ERROR OR NO KEYBOARD PRESENT

Cannot initialize the keyboard. Make sure the keyboard is attached correctly and no keys are being pressed during the boot. If you are purposely configuring the system without a keyboard, set the error halt condition in Setup to HALT ON ALL, BUT KEYBOARD. This will cause the BIOS to ignore the missing keyboard and continue the boot.

MEMORY ADDRESS ERROR AT...

Indicates a memory address error at a specific location. You can use this location along with the memory map for your system to find and replace the bad memory chips.

MEMORY PARITY ERROR AT...

Indicates a memory parity error at a specific location. You can use this location along with the memory map for your system to find and replace the bad memory chips.

OFFENDING SEGMENT

This message is used in conjunction with the I/O CHANNEL CHECK and RAM PARITY ERROR messages when the segment that has caused the problem has been isolated.

PRESS A KEY TO REBOOT

This will be displayed at the bottom screen when an error occurs that requires a reboot. Press any key and the system will reboot.

PRESS F1 TO DISABLE NMI, F2 TO REBOOT

When BIOS detects a Non-Maskable Interrupt condition during boot, this will allow NMI to be disabled and continue to boot. You can also reboot the system with the NMI enabled.



G586SP/G586SP AIO

RAM PARITY ERROR - CHECKING FOR SEGMENT

Indicates a parity error in Random Access Memory.

SYSTEM HALTED, (CTRL-ALT-DEL) TO REBOOT...

Indicates the present boot attempt has been aborted and the system must be rebooted. Press and hold down the CTRL and ALT keys and press DEL simultaneously.



❖ **Appendix A: Award BIOS Hard Disk Table**

Type	Size (MB)	Cylinders	Heads	Sectors	Write Precomp	Land Zone	Example Model
1	10	306	4	17	128	305	TEAC SD510, MMI 112, 5412
2	20	615	4	17	300	615	Seagate ST225, ST4026
3	30	615	6	17	300	615	
4	62	940	8	17	512	940	
5	46	940	6	17	512	940	
6	20	615	4	17	None	615	Seagate ST125, Tandon TM262
7	30	462	8	17	256	511	
8	30	733	5	17	None	733	Tandon TM 703
9	112	900	15	17	None	901	
10	20	820	3	17	None	820	
11	35	855	5	17	None	855	
12	49	855	7	17	None	855	
13	20	306	8	17	128	319	Disctron 526, MMI M125
14	42	733	7	17	None	733	
15				(Reserved)			
16	20	612	4	17	0	663	Microscience HH725,
17	40	977	5	17	300	977	Syquest 3250, 3425
18	56	977	7	17	None	977	
19	59	1024	7	17	512	1023	
20	30	733	5	17	300	732	
21	42	733	7	17	300	732	
22	30	306	5	17	300	733	Seagate ST4038
23	10	977	4	17	0	336	
24	40	1024	5	17	None	976	Seagate ST4051
25	76	1224	9	17	None	1023	Seagate ST4096
26	71	1224	7	17	None	1223	Maxtor 2085
27	111	1224	11	17	None	1223	Maxtor 2140, Priam S14
28	152	1024	15	17	None	1223	Maxtor 2190, Priam S19



G586SP/G586SP AIO

Type	Size (MB)	Cylinders	Heads	Sectors	Write Precomp	Land Zone	Example Model
29	68	1024	8	17	None	1023	Maxtor 1085, Micropolis 1325
30	93	918	11	17	None	1023	Maxtor 1105 1120, 4780
31	83	925	11	17	None	1023	Maxtor 1170
32	69	1024	9	17	None	926	CDC 9415
33	85	1024	10	17	None	1023	
34	102	1024	12	17	None	1023	
35	110	1024	13	17	None	1023	
36	119	1024	14	17	None	1023	
37	17	1024	2	17	None	1023	
38	136	1024	16	17	None	1023	
39	114	918	15	17	None	1023	Maxtor 1140, 4380
40	40	820	6	17	None	820	Seagate ST251
41	42	1024	5	17	None	1023	Seagate 4053 Miniscribe 3053/ 6053
42	65	1024	5	26	None	1023	Miniscribe 3053/ 6053 RLL
43	40	809	6	17	None	852	Miniscribe 3650
44	61	809	6	26	None	852	Miniscribe 3675 RLL
45	100	776	8	33	None	775	Conner CP3104
46	203	684	16	38	None	685	Conner CP3204
User Defined							

❖ Appendix B: Memory & I/O Maps

Memory Map

Address	Name	Function
0000000 to 009FFFF	640KB System Board RAM	System Board Memory
00A0000 to 00BFFFF	128KB Video Display Memory	Reserved for Graphics Display Memory
00C0000 to 00E7FFF	160KB I/O Expansion ROM	Reserved for ROM on I/O Adapter Card
00E8000 to 00FFFFFF	96KB ROM on the System Board	System Board BIOS
0100000 to 3FFFFFF	Maximum Memory 128MB	System Board Memory



I/O Address Map

000-01F	DMA Controller 1, 8237A-5
020-03F	Interrupt Controller 1, 8259A, Master
040-05F	Timer, 8254-2
060-06F	8742 (Keyboard Controller)
070-07F	Real-time Clock, NMI (Non-maskable Interrupt) Mask
080-09F	DMA Page Memory, 74LS612
0A0-08F	Interrupt Controller 2, 8259A
0C0-0DF	DMA Controller 2, 8237A-5
0E8	Shadow RAM and Cache Control Bit
0F0	Clear Numeric Processor Extension Busy
0F1	Reset Numeric Processor Extension
0F8-0FF	Numeric Processor Extension
1F0-1F8	Primary Fixed Disk
170-178	Secondary Fixed Disk
200-207	Game I/O
278-27F	Parallel Printer Port 2
2F8-2FF	Serial Port 2
300-31F	Prototype Card
360-36F	Reserved
378-37F	Parallel Printer Port 1
380-38F	SDLC, Bisynchronous 2
3A0-3AF	Bisynchronous 1
3B0-3BF	Monochrome Display and Printer Adapter
3C0-3CF	Reserved
3D0-3DF	Color/Graphics Monitor Adapter
3F0-3F7	Diskette Controller
3F8-3FF	Serial Port 1

Note:

The I/O address hex 000 to 0FF are reserved for the system board I/O. Hex 100 to 3FF are available on the I/O channels.



❖ Appendix C: PCI I/O Pin Assignments

Component Side	B	A	Solder Side
	-12V	-01 -	TRST#
	TCK	-02 -	+12V
	Ground	-03 -	TMS
	TDO	-04 -	TDI
	+5V	-05 -	+5V
	+5V	-06 -	INTA#
	INTB#	-07 -	INTC#
	INTD#	-08 -	+5V
	PRSNT1#	-09 -	Reserved
	Reserved	-10 -	+5V (I/O)
	PRSNT2#	-11 -	Reserved
	Ground	-12 -	Ground
	Ground	-13 -	Ground
	Reserved	-14 -	Reserved
	Ground	-15 -	RST#
	CLK	-16 -	+5V (I/O)
	Ground	-17 -	GNT#
	REQ#	-18 -	Ground
	+5V (I/O)	-19 -	Reserved
	AD[31]	-20 -	AD[30]
	AD[29]	-21 -	+3.3V
	Ground	-22 -	AD[28]
	AD[27]	-23 -	AD[26]
	AD[25]	-24 -	Ground
	+3.3V	-25 -	AD[24]
	C/BE[3]#	-26 -	IDSEL
	AD[23]	-27 -	+3.3V
	Ground	-28 -	AD[22]
	AD[21]	-29 -	AD[20]
	AD[19]	-30 -	Ground
	+3.3V	-31 -	AD[18]
	AD[17]	-32 -	AD[16]
	C/BE[2]#	-33 -	+3.3V
	Ground	-34 -	FRAME#
	IRDY#	-35 -	Ground
	+3.3V	-36 -	TRDY#
	DEVSEL#	-37 -	Ground
	Ground	-38 -	STOP#
	LOCK#	-39 -	+3.3V
	PERR#	-40 -	SDONE
	+3.3V	-41 -	SBO#
	SERR#	-42 -	Ground
	+3.3V	-43 -	PAR
	C/BE[1]#	-44 -	AD[15]
	AD[14]	-45 -	+3.3V
	Ground	-46 -	AD[13]
	AD[12]	-47 -	AD[11]
	AD[10]	-48 -	Ground
	Ground	-49 -	AD[09]
	AD[08]	-52 -	C/BE[0]#
	AD[07]	-53 -	+3.3V
	+3.3V	-54 -	AD[06]
	AD[05]	-55 -	AD[04]
	AD[03]	-56 -	Ground
	Ground	-57 -	AD[02]
	AD[01]	-58 -	AD[00]
	+5V (I/O)	-59 -	+5V (I/O)
	ACK64#	-60 -	REQ64#
	+5V	-61 -	+5V
	+5V	-62 -	+5V

❖ Appendix D: ISA I/O Pin Assignments

B	A
Gnd	- 01 -
ResetDrv	- 02 -
+5VDC	- 03 -
IRQ9	- 04 -
-5VDC	- 05 -
DRQ2	- 06 -
-12VDC	- 07 -
O/S	- 08 -
+12VDC	- 09 -
Gnd	- 10 -
-SEMEMV	- 11 -
-SEMEMR	- 12 -
-IOW	- 13 -
-IOR	- 14 -
-Dack3	- 15 -
-DRQ3	- 16 -
-Dack1	- 17 -
DRQ1	- 18 -
-Refresh	- 19 -
CLK	- 20 -
IRQ7	- 21 -
IRQ6	- 22 -
IRQ5	- 23 -
IRQ4	- 24 -
IRQ3	- 25 -
-Dack2	- 26 -
T/C	- 27 -
Bale	- 28 -
+5VDC	- 29 -
CSC	- 30 -
Gnd	- 31 -

D	C
-MemCS16	- 01 -
-I/OCS16	- 02 -
IRQ10	- 03 -
IRQ11	- 04 -
IRQ12	- 05 -
IRQ13	- 06 -
IRQ14	- 07 -
-Dack0	- 08 -
DRQ0	- 09 -
-Dack5	- 10 -
DRQ5	- 11 -
-Dack6	- 12 -
DRQ6	- 13 -
-Dack7	- 14 -
DRQ7	- 15 -
+5VDC	- 16 -
-Master	- 17 -
Gnd	- 18 -

❖ Appendix E: System Overview

DMA Channels

DMA Controller 1	DMA Controller 2
Ch0-Reserved for User	Ch4-Cascade for CTRL 1
Ch1-Reserved for User	Ch5-Reserved for User
Ch2-Diskette	Ch6-Reserved for User
Ch3-Reserved for User	Ch7-Reserved for User

Note:

DMA controller 1 supports 8-bit data transfer.

DMA controller 2 supports 16-bit data transfer.

Address Generation for DMA Channels 3 to 0

Source	DMA Page Memory	DMA Controller 1
Address	A23 « A16	A15 « A0

Address Generation for DMA Channels 7 to 5

Source	DMA Page Memory	DMA Controller 2
Address	A23 « A17	A16 « A1



Page Memory Address

I/O Port Address	Page Memory
0081H	DMA Channel 2
0082H	DMA Channel 3
0083H	DMA Channel 1
0087H	DMA Channel 0
0089H	DMA Channel 6
008AH	DMA Channel 7
008BH	DMA Channel 5

System Interrupts

Interrupt Controller 1	Interrupt Controller 2
IRQ0-Timer Output (Out 0)	IRQ8-Realtime Clock INT
IRQ1-Keybaord (Output Buffer Full)	IRQ9-Software Redirected to INT 0AH (IRQ2)
IRQ2-Interrupt from INTR2	IRQ10-Reserved
IRQ3-Serial Port 2	IRQ11-Reserved
IRQ4-Serial Port 1	IRQ12-PS/2 Mouse
IRQ5-Parallel Port 2 or 3 *	IRQ13-Coprocessor
IRQ6-Diskette Controller	IRQ14-Primary Fixed Disk Controller (1F0)
IRQ7-Parallel Port 1 or 2 *	IRQ15-Secondary Fixed Disk Controller (170)

* The one on-board parallel port can be configured to either Parallel Port 1, 2 or 3. Parallel Port 1 uses I/O address 3BCh, Parallel Port 2 I/O address 378h, and Parallel Port 3 uses I/O address 278H.

Note:

The 16 levels of system interrupts have the following priority: IRQ0>IRQ1>IRQ8>IRQ9>IRQ10>IRQ11>IRQ12>IRQ13>IRQ14>IRQ15>IRQ3>IRQ4>IRQ5>IRQ6>IRQ7.

System Timers

Channel 0	System Timer (IRQ0)
Channel 1	Refresh Request Generator (15us Rate Generator Period Signal)
Channel 2	Tone Generation for Speaker

Real-Time Clock

Address	Function
00	Seconds
01	Second Alarm
02	Minutes
03	Minute Alarm
04	Hours
05	Hour Alarm
06	Day of Week
07	Date of Month
08	Month
09	Year
0A	Register A
0B	Register B
0C	Register C
0D	Register D



❖ Appendix F: Connector Pin Assignments

Connector J2 PS/2 Keyboard Connector

Pin	Function
1	Keyboard Data
2	Reserved
3	Ground
4	+5V
5	Keyboard Clock
6	Reserved

Connector J2 AT Keyboard Connector

Pin	Function
1	Keyboard Clock
2	Keyboard Clock
3	Not Connected
4	Ground
5	+5V

Connector J3 PS/2 Mouse Connector

Pin	Function
1	Mouse Data
2	Reserved
3	Ground
4	+5V
5	Mouse Clock
6	Reserved

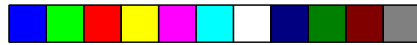

G586SP/G586SP AIO

J4 and J5

Primary (COM1) AND Secondary (COM2) Serial Ports

Pin	Function
1	DCD (Data Carrier Detect)
2	RX (Receive Data)
3	TX (Transmit Data)
4	DTR (Data Terminal Ready)
5	Ground (Signal Ground)
6	DSR (Data Set Ready)
7	RTS (Request to Send)
8	CTS (Clear to Send)
9	RI (Ring Indicator)

Connector J6

12V Fan Connector

Pin	Function
1	+12V
2	Ground

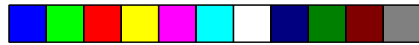

G586SP/G586SP AIO

Connector J7 (G586SP AIO)
Analog Connector

Pin	Function
1	Red
2	Green
3	Blue
4	Monitor ID bit 2 (Not Used)
5	Ground
6	Red Return (ground)
7	Green Return (ground)
8	Blue Return (ground)
9	Key
10	Sync Return (ground)
11	Not used
12	DDCDAT
13	Horizontal Sync
14	Vertical Sync
15	DDCCCK
16	Not used

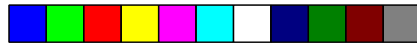

G586SP/G586SP AIO

Connector J8
Parallel Printer Port

Pin	Function
1	-Strobe
2	Data 0
3	Data 1
4	Data 2
5	Data 3
6	Data 4
7	Data 5
8	Data 6
9	Data 7
10	-Ack
11	Busy
12	Paper Empty
13	Select
14	-Autofd
15	-Error
16	-Init
17	-Slctin
18	Ground
19	Ground
20	Ground
21	Ground
22	Ground
23	Ground
24	Ground
25	Ground

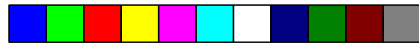

G586SP/G586SP AIO

Connector J9
Power Connector

Pin	Function
1	Power Good
2	+5V
3	+12V
4	-12V
5	Ground
6	Ground
7	Ground
8	Ground
9	-5V
10	+5V
11	+5V
12	+5V

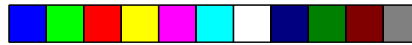

G586SP/G586SP AIO

Connector J10 (G586SP AIO)
Feature Connector

Pin	Function
1	PD0
2	PD1
3	PD2
4	PD3
5	PD4
6	PD5
7	PD6
8	PD7
9	Enpdk
10	EBlank
11	EHSync
12	EVSync
13	Ground
14	Ground
15	Ground
16	Ground
17	EnVideo
18	EnSync
19	EnPdk
20	Not used
21	Ground
22	Ground
23	Ground
24	Ground
25	Not used
26	Ground



G586SP/G586SP AIO

Connector J11
Floppy Disk Drive Connector

Pin	Function
1	Ground
2	DENSEL
3	Ground
4	Reserved
5	Ground
6	Drate0
7	Ground
8	Index
9	Ground
10	MTR0
11	Ground
12	DR1
13	Ground
14	DR0
15	Ground
16	MTR1
17	Drate1
18	Dir
19	Ground
20	Step
21	Ground
22	Write Data
23	Ground
24	Write Gate
25	Ground
26	Track 0
27	MSEN
28	Wr Protect
29	Ground
30	Read Data
31	Ground
32	Head Select
33	Ground
34	Disk Change

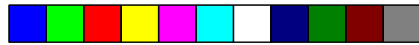

G586SP/G586SP AIO

Connector J12 and J13

Primary/Secondary IDE Hard Disk Drive Connectors

Pin	Function
1	-Reset
2	Ground
3	D7
4	D8
5	D6
6	D9
7	D5
8	D10
9	D4
10	D11
11	D3
12	D12
13	D2
14	D13
15	D1
16	D14
17	D0
18	D15
19	Ground
20	Reserved
21	Reserved
22	Ground
23	-IOW
24	Ground
25	-IOR
26	Ground
27	Reserved
28	BALE
29	Reserved
30	Ground
31	IRQ
32	IOCS16
33	SA1

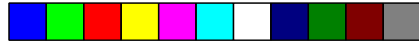

G586SP/G586SP AIO

Pin	Function
34	Reserved
35	SA0
36	SA2
37	HCS0
38	HCS1
39	LED
40	Ground

Connector J14
External Battery

Pin	Function
1	3.6V Lithium Battery
2	Key
3	GND
4	GND



G586SP/G586SP AIO

Connector J17
IDE LED

Pin	Function
1	Signal
2	LED Power

Connector J18
Suspend Switch

Pin	Function
1	Signal
2	GND

Connector J19
Green LED

Pin	Function
1	Signal
2	LED Power

Connector J20
Turbo LED

Pin	Function
1	Signal
2	LED Power

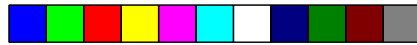

G586SP/G586SP AIO

Connector J21
Turbo Button

Pin	Function
1	GND
2	Signal

Connector J22
Reset Switch

Pin	Function
1	Ground
2	Reset

Connector J23
Speaker

Pin	Function
1	Signal
2	Reserved
3	Ground
4	+5V

Connector J24
Power LED/Keylock

Pin	Function
1	LED Signal
2	Reserved
3	Ground
4	Leylock Signal
5	Ground



G586SP/G586SP AIO

❖ Appendix G: VGA Video Playback Support Mode G586SP AIO: Shared Memory Configuration (1)

Resolution	Colors	Frame Rate	VGA Memory	Normal Size	Full Screen	Video Only
640X480	16	60	1 MB			
640X480	256	60	1 MB	✓	✓	✓
640X480	256	72	1 MB	✓	✓	✓
640X480	256	75	1 MB	✓	✓	✓
640X480	32K	60	1 MB			✓
640X480	32K	72	1 MB			✓
640X480	32K	75	1 MB			✓
640X480	64K	60	1 MB			✓
640X480	64K	72	1 MB			✓
640X480	64K	75	1 MB			✓
640X480	16.7M	60	1 MB			✓
800X600	16	56	1 MB			
800X600	16	60	1 MB			
800X600	16	72	1 MB			
800X600	16	75	1 MB			
800X600	256	56	1 MB	✓	✓	✓
800X600	256	60	1 MB		✓	✓
800X600	256	72	1 MB		✓	✓
800X600	256	75	1 MB		✓	✓
800X600	32K	56	1 MB			✓
800X600	32K	60	1 MB			✓
800X600	64K	56	1 MB			✓
800X600	64K	60	1 MB			✓
1024X768	16	60	1 MB			
1024X768	16	70	1 MB			
1024X768	16	75	1 MB			
1024X768	16	87 I	1 MB			
1024X768	256	60	1 MB			✓
1024X768	256	70	1 MB			✓
1024X768	256	75	1 MB			✓
1024X768	256	87 I	1 MB			
1280X1024	16	60	1 MB			
1280X1024	16	75	1 MB			
1280X1024	16	87 I	1 MB			
640X480	16	60	2 MB			
640X480	16	72	2 MB			
640X480	16	75	2 MB			
640X480	256	60	2 MB	✓	✓	✓
640X480	256	72	2 MB	✓	✓	✓
640X480	256	75	2 MB	✓	✓	✓
640X480	32K	60	2 MB	✓	✓	✓
640X480	32K	72	2 MB	✓	✓	✓
640X480	32K	75	2 MB	✓	✓	✓
640X480	64K	60	2 MB	✓	✓	✓
640X480	64K	72	2 MB	✓	✓	✓
640X480	64K	75	2 MB	✓	✓	✓



G586SP AIO: Shared Memory Configuration (2)

Resolution	Colors	Frame Rate	VGA Memory	Normal Size	Full Screen	Video Only
640X480	16.7M	60	2MB	✓	✓	✓
640X480	16.7M	72	2MB	✓	✓	✓
640X480	16.7M	75	2MB	✓	✓	✓
800X600	16	56	2MB			
800X600	16	60	2MB			
800X600	16	72	2MB			
800X600	16	75	2MB			
800X600	256	56	2MB	✓	✓	✓
800X600	256	60	2MB	✓	✓	✓
800X600	256	72	2MB	✓	✓	✓
800X600	256	75	2MB	✓	✓	✓
800X600	32K	56	2MB	✓	✓	✓
800X600	32K	60	2MB	✓	✓	✓
800X600	32K	72	2MB		✓	✓
800X600	32K	75	2MB		✓	✓
800X600	64K	56	2MB	✓	✓	✓
800X600	64K	60	2MB	✓	✓	✓
800X600	64K	72	2MB		✓	✓
800X600	64K	75	2MB		✓	✓
800X600	16.7M	56	2MB	✓	✓	✓
800X600	16.7M	60	2MB		✓	✓
800X600	16.7M	72	2MB		✓	✓
800X600	16.7M	75	2MB		✓	✓
1024X768	16	60	2MB			
1024X768	16	70	2MB			
1024X768	16	75	2MB			
1024X768	16	87 I	2MB			
1024X768	256	60	2MB	✓	✓	✓
1024X768	256	70	2MB		✓	✓
1024X768	256	75	2MB		✓	✓
1024X768	256	87 I	2MB			
1024X768	32K	60	2MB		✓	✓
1024X768	32K	70	2MB		✓	✓
1024X768	32K	75	2MB			✓
1024X768	32K	87 I	2MB			
1024X768	64K	60	2MB		✓	✓
1024X768	64K	70	2MB		✓	✓
1024X768	64K	75	2MB			✓
1024X768	64K	87 I	2MB			
1280X1024	16	60	2MB			
1280X1024	16	75	2MB			
1280X1024	16	87 I	2MB			
1280X1024	256	60	2MB			✓
1280X1024	256	75	2MB			✓
1280X1024	256	87 I	2MB			