



G5860PA

Rev. 0
System Board
User's Manual



- D26250223 -





❖ **Copyright 1995 by DFI, Inc.**

All rights reserved.

No part of this document may be copied, reproduced in any form or by any means or used to make any transformation/adaptation without the prior written consent of DFI, Inc.

DFI, Inc. makes no warranties with respect to this documentation and disclaims any implied warranties of merchantability, quality, or fitness for any particular purpose. The information in this document is subject to change without notice. DFI, Inc. reserves the right to make revisions to this publication and to make changes to any and/or all parts of its content, at any time, without obligation to notify any person or entity of such changes. Further, DFI, Inc. assumes no responsibility for any errors that may appear in this document.

DFI is a registered trademark, and G586OPA is a trademark of Diamond Flower, Inc. All other product names mentioned are trademarks or registered trademarks of their respective companies.



❖ **FCC Statement on Class B**

This equipment has been tested and found to comply with the limits for a Class B digital device, pursuant to Part 15 of the FCC rules. These limits are designed to provide reasonable protection against harmful interference when the equipment is operated in a residential installation. This equipment generates, uses and can radiate radio frequency energy and, if not installed and used in accordance with the instruction manual, may cause harmful interference to radio communications. However, there is no guarantee that interference will not occur in a particular installation. If this equipment does cause harmful interference to radio or television reception, which can be determined by turning the equipment off and on, the user is encouraged to try to correct the interference by one or more of the following measures:

- *Reorient or relocate the receiving antenna.*
- *Increase the separation between the equipment and the receiver.*
- *Connect the equipment into an outlet on a circuit different from that to which the receiver is connected.*
- *Consult the dealer or an experienced radio TV technician for help.*

Notice:

1. *The changes or modifications not expressly approved by the party responsible for compliance could void the user's authority to operate the equipment.*
2. *Shielded interface cables must be used in order to comply with the emission limits.*



❖ Table of Contents ❖

Introduction	1-1
Features and Specifications	1-2
Package Checklist	1-5
Installation Overview	2-1
Preparing the Area	2-1
Handling the System Board	2-2
Tips in Handling the System Board	2-2
Hardware Installation	2-3
Memory Installation	2-3
Installing the Modules	2-6
Board Configuration	2-7
Jumper Settings for Flash EPROM, PS/2 Mouse and Display Type.....	2-8
Jumper Settings for Parallel Port	2-11
Cache Configuration	2-13
Jumper Settings for Cache Memory	2-14
CPU Installation	2-17
Jumper Settings for CPU	2-18
Installing Upgrade CPUs	2-21
Built-in Ports	2-26
Serial Ports	2-27
Parallel Port	2-28
Floppy Disk Drive Connector	2-30
IDE Hard Disk Connector	2-31
PS/2 Mouse Port	2-34
Installing Expansion Cards	2-35
Installing the System Board	2-36



Initial Setup Program	3-1
Award BIOS CMOS Setup Utilities	3-2
Standard CMOS Setup	3-2
BIOS Features Setup	3-5
Chipset Features Setup	3-7
Power Management Setup	3-8
PCI Configuration Setup	3-9
Load BIOS Defaults	3-16
Load Setup Defaults	3-17
Password Setting	3-17
IDE HDD Auto Detection	3-18
Save & Exit Setup	3-19
Exit Without Saving	3-20
IDE Device Drivers	4-1
Troubleshooting Checklist	5-1
Appendix A: Types of Modules	A-1
Appendix B: System Error Report	B-1
Appendix C: Memory & I/O Maps	C-1
Appendix D: PCI I/O Pin Assignments	D-1
Appendix E: ISA I/O Pin Assignments	E-1
Appendix F: Connector Pin Assignments	F-1
Appendix G: Award BIOS Hard Disk Table	G-1



PC/ISA System Board

❖ *Introduction*

The G586OPA system board offers several advanced features integrated into the system board. Its design is based on the new Peripheral Component Interconnect (PCI) local bus and Industry Standard Architecture (ISA) standards.

The G586OPA supports a 320-pin Zero Insertion Force (ZIF) CPU socket for Pentium™ processors running at 75MHz, 90MHz or 100MHz frequency. This ZIF socket allows users to easily upgrade their CPUs. It also supports a Flash EPROM for easy BIOS upgrades. Flash EPROM is a memory chip for the storage of BIOS which can be erased in bulk or modified using a software utility.

The G586OPA is equipped with three PCI slots, three ISA slots and one shared PCI/ISA slot.

Equipped with two built-in PCI IDE connectors, the G586OPA system board can control four drives and supports fast Mode 3 hard drives and hard drives larger than 528MB under DOS. The system board is also equipped with two serial ports, an ECP/EPP parallel port, a floppy disk drive controller, and one mini-DIN-6 connector for the PS/2 mouse.

The G586OPA can support 2MB to 128MB of memory using 256Kx36, 512Kx36, 1Mx36, 2Mx36, 4Mx36 and 8Mx36 72-pin SIM modules.



G5860PA

Features and Specifications

Processor

- Intel Pentium™ 75/90/100MHz

Chipset

- OPTI: Viper chipset
 - 82C556 - data buffer
 - 82C557 - system controller
 - 82C558 - Integrated Peripheral Controller

Energy Efficient Design

- Supports 3.3V CPUs
- Supports system power management
- Supports CPU stopped clock

Power Management

- Three power-saving stages: Doze, Standby and Suspend
- Microsoft APM 1.1 supported
- EPA Energy Star compliant design

PCI IDE Interface

- Fast PCI local-bus interface
- Supports Mode 3 (Enhanced IDE) hard drives
- Two IDE connectors to control four drives (e.g. two HDDs, one tape drive and one CD-ROM)
- Uses NS PC87410 PCI IDE chip

Super I/O Interface

- Two NS16C550A-compatible serial ports
- PS/2 mouse port
- One parallel port with EPP and ECP support
- Supports 360KB, 720KB, 1.2MB, 1.44MB and 2.88MB floppy drives
- Uses NS PC87332VF super-I/O controller

Introduction ◆ 1-2



PCI/ISA System Board

BIOS

- Award Plug & Play BIOS
- Flash EPROM for easy BIOS upgrades
- Supports IDE HDDs larger than 528MB under DOS (LBA mode only)

Architecture

- PCI/ISA

Cache Memory

- 256K, 512K or 1MB direct map write-back or write-through cache
- Uses 32Kx8, 64Kx8 or 128Kx8 SRAM
- Supports 3.3V or 3V/5V mixed mode SRAM

Memory Onboard

- Up to 128MB
- Four 72-pin SIMM sockets
- Supports single and/or double density SIMMs
- 256Kx36, 512Kx36, 1Mx36, 2Mx36, 4Mx36 or 8Mx36 SIMMs
- Supports 60ns or 70ns fast page mode DRAM

Expansion Slots

- Three dedicated PCI slots
- One shared PCI/ISA slot
- Three dedicated 16-bit ISA slots

Due to the height of the heat sink, once the 3.3V Pentium Upgrade Processor is in place, you cannot install full-length add-in cards in slot connectors 1, 2 & 4 (ISA), and 1 & 2 (PCI). These slots are limited to 2/3 length of add-in cards.



G586OPA

ZIF Socket

- 320-pin ZIF socket (Intel Socket 5)

Board Dimensions

- 33cm (12.87") x 22cm (8.58")
Baby AT form factor



Introduction ◆ 1-4





PC/ISA System Board

Package Checklist

The G586OPA package contains the following items:

- The G586OPA system board
- The G586OPA user's manual
- Two IDE driver diskettes
- One 34-pin floppy disk drive cable
- Two 40-pin IDE hard disk cables
- One 25-pin printer port cable for chassis mounting
- One card-edge bracket with serial and mouse port cables

If any of these items are missing or damaged, please contact your dealer or sales representative for assistance.





❖ *Installation Overview*

This chapter summarizes the steps in installing the G586OPA system board into your system unit. It also includes a description of the area in which you must work and directions for memory installation. Before installing the system board, obtain the memory you plan to install. Please refer to the memory chart, on pages 2-3 and 2-4, for the number and type of SIM modules needed for the amount of memory you require.

Preparing the Area

Before unpacking the system board, make sure the location you have selected is relatively free of dust and static electricity. Excessive exposure to dust, static electricity, direct sunlight, excessive humidity, extreme cold, and water can damage the operational capabilities of your system board. Avoid placing the unit on soft surfaces such as beds and carpeted floors which can hinder air circulation. These areas also attract static electricity which can damage some circuits on your system board.

Make sure that the power source has a properly grounded, three-pronged socket. It is essential that the power connection be properly grounded for correct functioning of your system board. For further protection, we recommend that you use a surge suppressor. This will protect the system board from damage that may result from a power surge on the electrical line.

Move items that generate magnetic fields away from your system board, since magnetic fields can also damage your system board. Once you have selected the



PC/ISA System Board

ideal location, unpack the G586OPA system board carefully.

Handling the System Board

It is quite easy to inadvertently damage your system board even before installing it to your system unit. Static electrical discharge can damage computer components without causing any signs of physical damage. You must take extra care in handling the system board to ensure against electrostatic build-up.

Tips in Handling the System Board

- 1) To prevent electrostatic build-up, leave the board in its anti-static bag until you are ready to install it.
- 2) Wear an antistatic wriststrap.
- 3) Do all preparation work on a static-free surface with components facing up.
- 4) Hold the system board by its edges only. Be careful not to touch any of the components, contacts or connections, especially gold contacts on the board.
- 5) Avoid touching the pins or contacts on all modules and connectors. Hold modules and connectors by their ends.

Warning:

Electrostatic discharge (ESD) can damage your upgrade processor, disk drives, add-in boards, and other components. Perform the upgrade instruction procedures described at an ESD workstation only. If such a station is not available, you can provide some



G586OPA

ESD protection by wearing an antistatic wrist strap and attaching it to a metal part of the system chassis. If a wrist strap is unavailable, establish and maintain contact with the system chassis throughout any procedures requiring ESD protection.

Hardware Installation

Memory Installation

The G586OPA system board can support 2MB to 128MB of memory using HSIM modules. HSIM is an acronym for High Density Single In-line Memory.

A SIM module consists of several RAM chips soldered onto a small circuit board. A SIM module connects to the system board via a 72-pin card-edge connector.

The SIM sockets are divided into two banks on the system board. The G586OPA system board uses 256Kx36, 512Kx36, 1Mx36, 2Mx36, 4Mx36 and 8Mx36 HSIM modules.

You will need 2 or 4 pieces of SIM modules, depending on the amount of memory you intend to install. Your system board can be configured with 2MB, 4MB, 6MB, 8MB, 10MB, 12MB, 16MB, 18MB, 20MB, 24MB, 32MB, 34MB, 36MB, 40MB, 48MB, 64MB, 66MB, 68MB, 72MB, 80MB, 96MB or 128MB of onboard memory.

To install the SIM modules, first populate Bank 0 and then Bank 1. Failure to do so will cause the system board to work improperly.



PC/ISA System Board

The following table summarizes the bank locations and modules needed for the corresponding memory sizes. Each bank consists of 2 SIMM sockets.

MemorySize	Bank0	Bank1
2MB	256Kx36	-
4MB	256Kx36	256Kx36
4MB	512Kx36	-
6MB	256Kx36	512Kx36
8MB	512Kx36	512Kx36
8MB	1Mx36	-
10MB	256Kx36	1Mx36
12MB	512Kx36	1Mx36
16MB	1Mx36	1Mx36
16MB	2Mx36	-
18MB	256Kx36	2Mx36
20MB	512Kx36	2Mx36
24MB	1Mx36	2Mx36
32MB	2Mx36	2Mx36
32MB	4Mx36	-
34MB	256Kx36	4Mx36
36MB	512Kx36	4Mx36
40MB	1Mx36	4Mx36
48MB	2Mx36	4Mx36
64MB	4Mx36	4Mx36
64MB	8Mx36	-
66MB	256Kx36	8Mx36
68MB	512Kx36	8Mx36
72MB	1Mx36	8Mx36
80MB	2Mx36	8Mx36
96MB	4Mx36	8Mx36
128MB	8Mx36	8Mx36



G5860PA

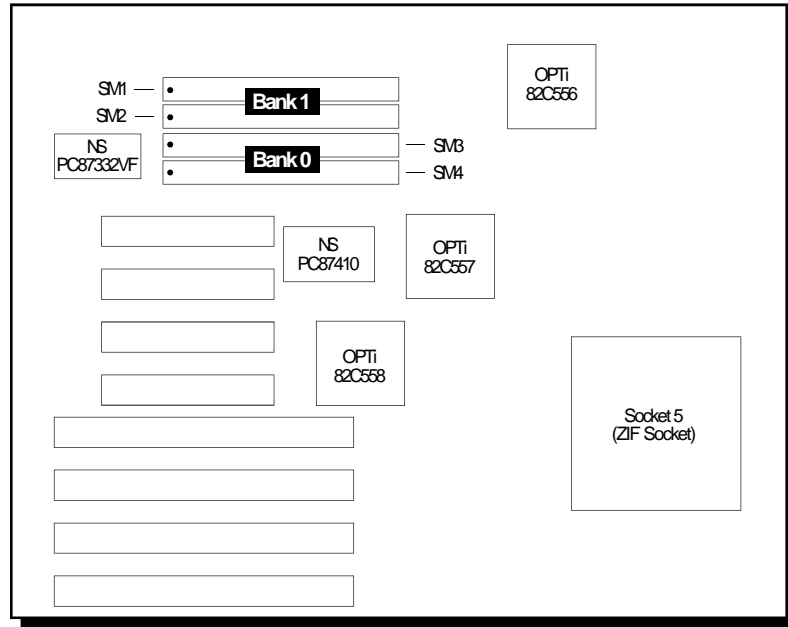

- Pin 1 of the SIMM socket

Locations of the SIM Sockets on the System Board



PC/ISA System Board

Installing the Modules

A SIM module simply snaps into a socket on the system board. Pin 1 of the SIM module must correspond with Pin 1 of the socket.

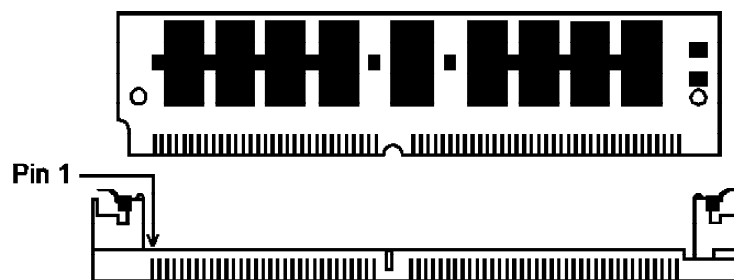

1. Position the HSIM module above the socket with the “notch” in the module aligned with the “key” on the socket.
2. Seat the module at a 45° angle into the bank. Make sure it is completely seated. Tilt the module upright until it locks in place in the socket.



Board Configuration

The G586OPA is designed with jumpers and connectors onboard. Make sure that the jumpers are set correctly before installing the system board into your system unit.

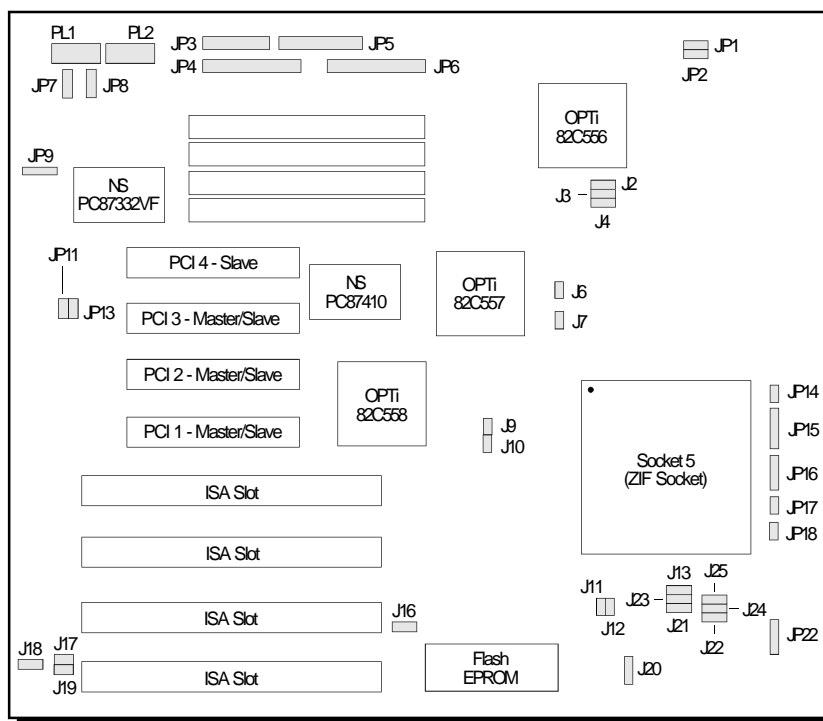

Locations of Jumpers and Connectors on the G586OPA System Board



PC/ISA System Board

Jumper Settings

Jumper Settings for Flash EPROM, PS/2 Mouse and Display Type

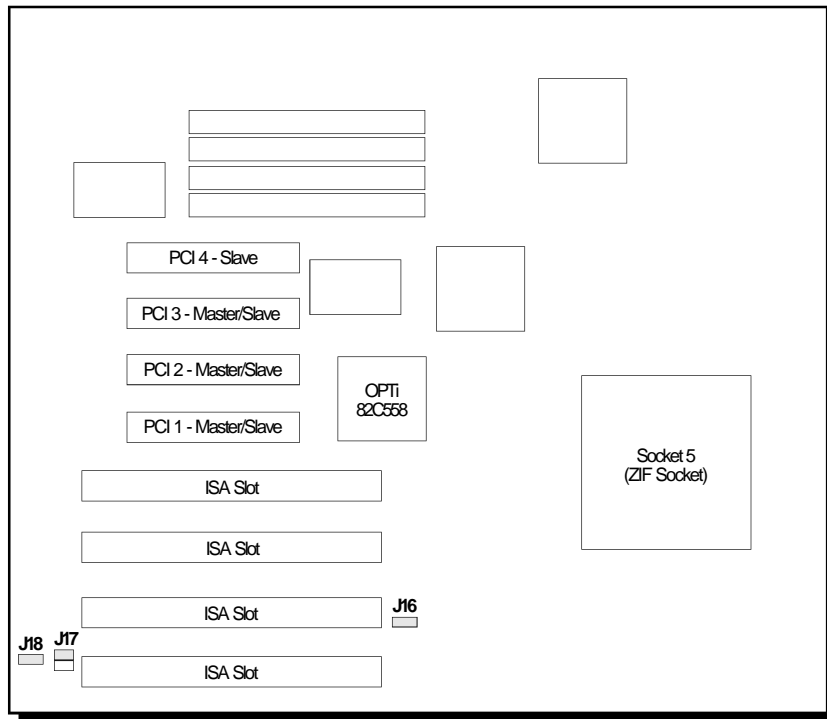

**Locations of Jumpers J16, J17 and J18
on the G586OPA System Board**



Jumper J16 Flash EPROM Voltage

The G586OPA supports 5 Volt and 12 Volt Flash EPROM. Set Jumper J16 according to the voltage of the Flash EPROM installed on the system board. Refer to page 2-7 for the locaton of the Flash EPROM.

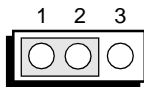

1-2 On: 5V Flash EPROM
(Default)

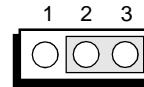

2-3 On: 12V Flash EPROM

Jumper J17 PS/2 Mouse

The G586OPA package includes a card-edge bracket with serial and mouse port. The PS/2 mouse port uses IRQ12. If you set Jumper J17 to IRQ12 enable, make sure you connect the PS/2 mouse port to Connector JP9. When IRQ12 is disabled and a PS/2 mouse is not used, the IRQ12 interrupt is available for other devices.

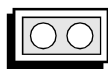

On: IRQ12 Enabled
(Default)



Off: IRQ12 Disabled



PC/ISA System Board

Jumper J18
Display Type Select

Jumper J18 sets the display adapter to color or mono. This jumper must match the type of display adapter installed. If you change your video adapter, make sure this jumper is changed accordingly.

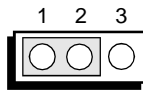

1-2 On: Mono

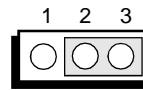

2-3 On: Color
(Default)



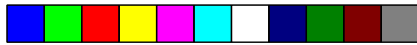

G586OPA

Jumper Settings for Parallel Port

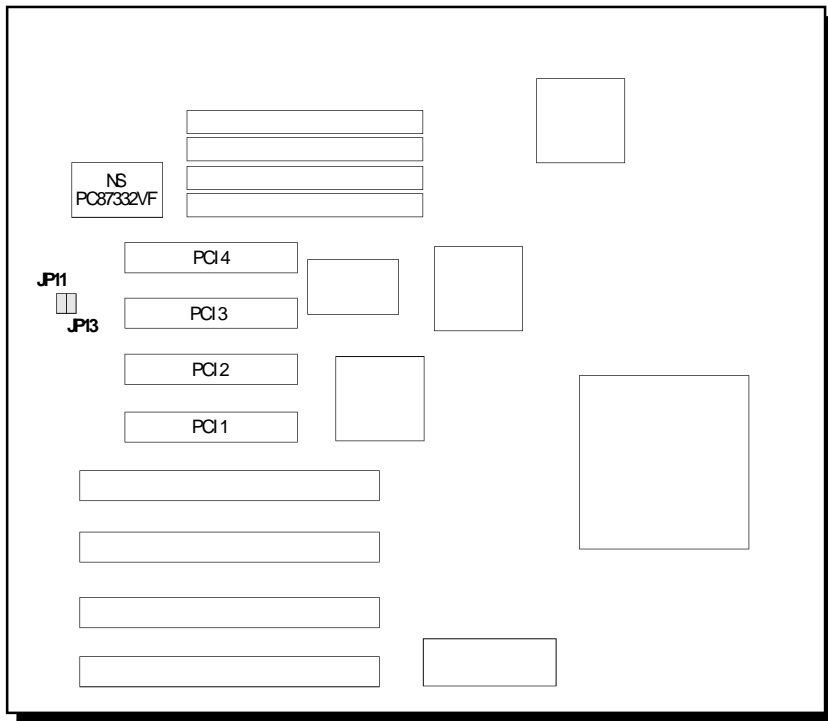

**Locations of Jumpers JP11 and JP13
on the G586OPA System Board**



PC/ISA System Board

Jumper JP11 ECP DACK Select

The G586OPA system board supports an ECP parallel port that allows you to use DMA Acknowledge (DACK) Channel 1 or 3. Set Jumper JP11 according to the DACK channel used by the system board.

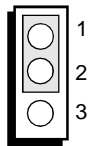

1-2 On: DACK 3

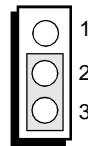

2-3 On: DACK 1
(Default)

Jumper JP13 ECP DRQ Select

The G586OPA system board supports an ECP parallel port that allows you to use DMA Request (DRQ) Channel 1 or 3. Set Jumper JP13 according to the DMA channel used by the system board.

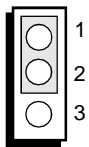

1-2 On: DRQ 3

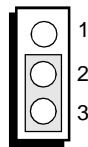

2-3 On: DRQ 1
(Default)



Cache Configuration

The G586OPA system board can be configured to three different cache sizes: 256KB, 512KB and 1MB. 256KB is the default size. The SRAM sockets allow you to install either 32Kx8, 64Kx8 or 128Kx8 SRAM. Regardless of the amount of cache memory installed, one 32Kx8 (U30) is needed for tag RAM to store the cacheable addresses. The locations of the SRAM sockets on the system board are shown below.

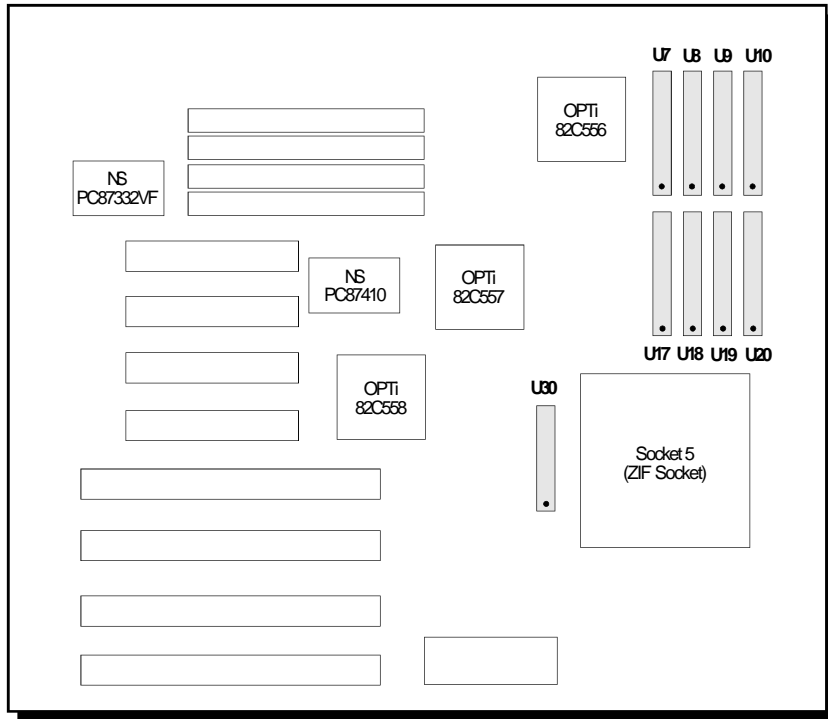

• Pin 1 of the SRAM socket

Locations of the SRAM Sockets on the System Board



PC/ISA System Board

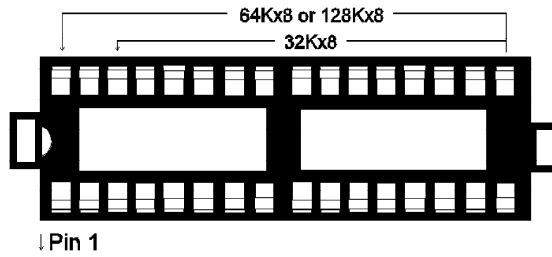

SRAM Socket

Jumper Setting for Cache Memory

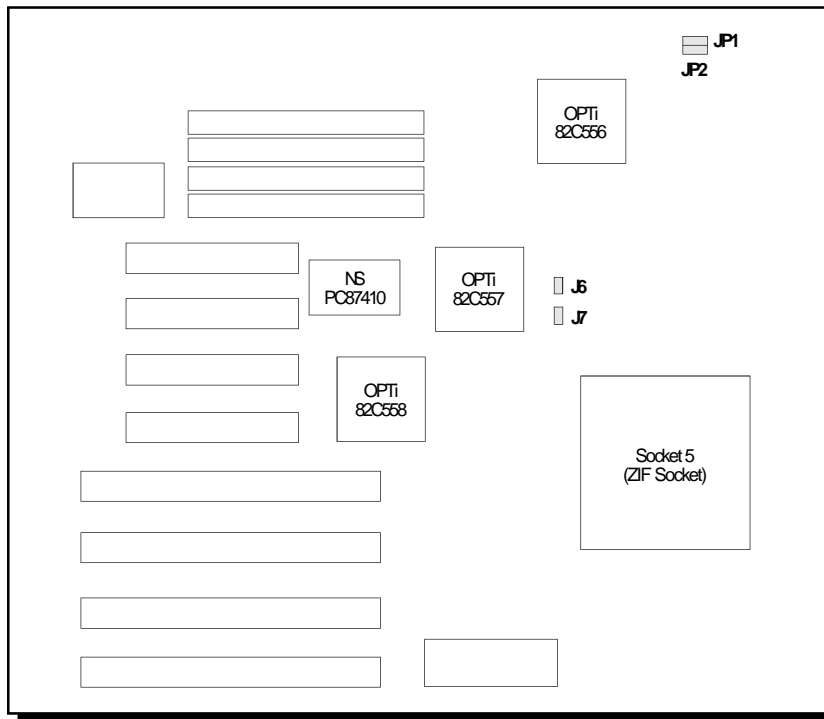

Locations of Jumpers J6, J7, JP1 and JP2 on the System Board





G5860PA

Jumpers J6 and J7 Level 2 Cache

Jumpers J6 and J7 should be set according to the cache size as shown below.

L2 Cache	J6	J7
256K*	Off	Off
512K	Off	On
1MB	On	On

* Default setting

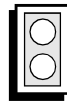

On

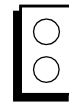

Off

CacheSize	U7-U10,U17-U20
256KB*	32Kx8
512KB	64Kx8
1MB	128Kx8

* Default setting



PC/ISA System Board

Jumpers JP1 and JP2 Level 2 Cache Voltage Select

Set Jumpers JP1 and JP2 according to the voltage of the SRAM installed on the G586OPA system board.

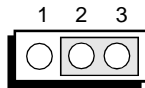

2-3 On: 3V/5V Mix
Mode SRAM
(Default)

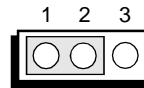

1-2 On: 3V SRAM

Note:

Locations U7-U10 and U17-U20 are SRAM sockets that allow you to insert 3V or 3V/5V mix mode SRAM.

The 32Kx8 SRAM (tag RAM) on location U30 is a 5V SRAM. Do not insert this into U7-U10 or U17-U20 SRAM socket.



CPU Installation

The G586OPA is equipped with a 320-pin Zero Insertion Force (ZIF) socket at location U22 of the system board. The ZIF socket allows for easy installation of upgrade CPUs as your system needs grow. Make sure all jumpers are set correctly before applying power, or you may damage the CPU or system board.

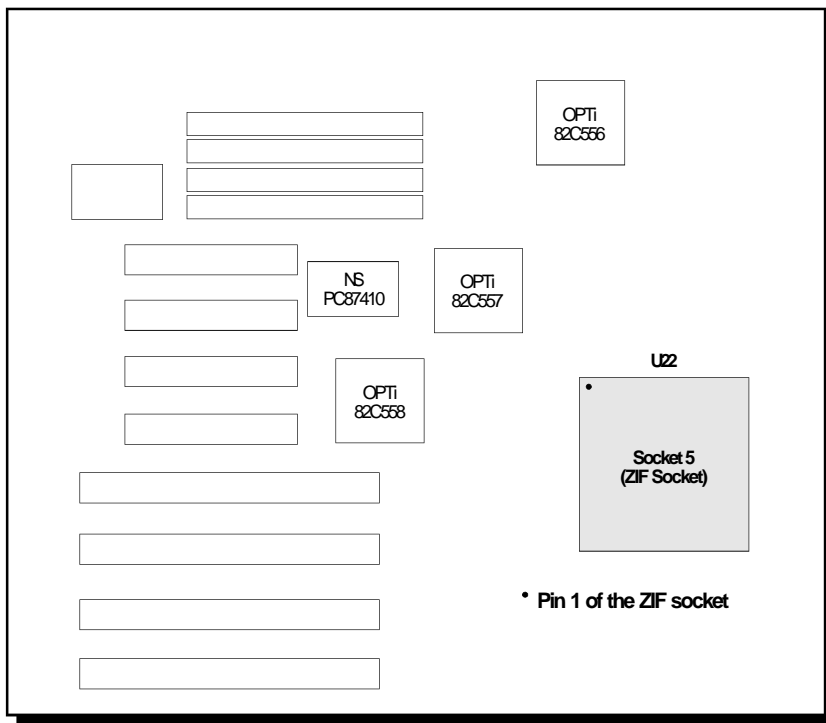

Location of the ZIF Socket on the G586OPA System Board



PC/ISA System Board

Jumper Settings for CPU

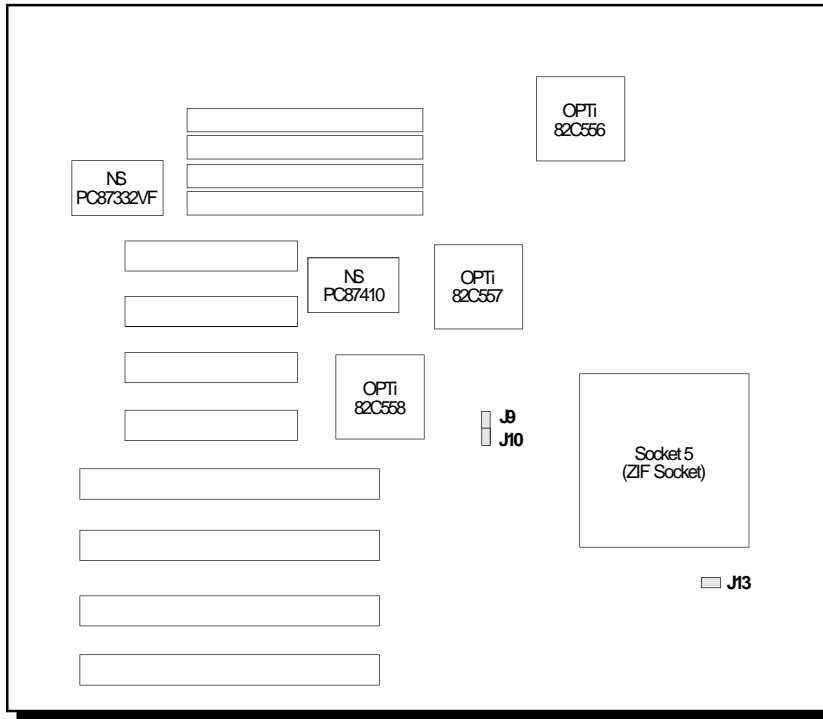

**Locations of Jumpers J9, J10 and J13
on the G586OPA System Board**





G586OPA

Jumpers J9 and J10 CPU Speed Select

The G586OPA supports CPU speeds of 75MHz, 90MHz and 100MHz. Set Jumpers J9 and J10 according to the speed of the CPU installed on the system board. For 75/100MHz, 90/120MHz and 100/132MHz CPUs, use the 50MHz, 60MHz and 66MHz settings, respectively.

Clock Speed	J9	J10	Pentium CPU	Pentium CPU (future version)
50MHz	Off	Off	75MHz	100MHz
60MHz*	On	On	90MHz	120MHz
66MHz	Off	On	100MHz	132MHz

* Default setting

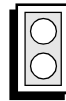

On

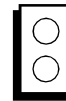

Off





PC/ISA System Board

Jumper J13 CPU Speed Select

Set J13 according to the speed of the CPU installed in the CPU socket.

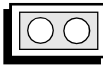

On: 50MHz/100MHz,
60MHz/120MHz or
66MHz/132MHz CPU



Off: 50MHz/75MHz,
60MHz/90MHz or
66MHz/100MHz CPU
(Default)

The jumpers below are for factory testing only and should always be set to their default configurations. Reconfiguring these jumpers will cause problems with your system board.

J2, J3, J4 and J20: 2-3 On
J8, J11 and J12: On
JP21, JP22, JP23, JP24 and JP25: On
J19: Off



G586OPA

Installing Upgrade CPUs

The G586OPA is equipped with a 320-pin Zero Insertion Force (ZIF) socket at location U22 of the system board. This socket is designed for easy removal of the old CPU and easy insertion of the upgrade CPU. The socket allows you to carefully place the new CPU into its position. If you need to apply excessive force to insert the CPU, the installation is being done incorrectly.

Warning:

Open the socket only if actually installing a CPU. The warranty on the original CPU will be voided if the S/N seal is broken.

Do not change any factory CPU speed jumper settings. You do not need to change any jumpers to properly install the 3.3V Pentium Upgrade Processor.

Before proceeding with the upgrade, take note of the following. The microprocessor and heat sink may be hot if the system has been running. To avoid the possibility of a burn, power the system off and let the processor and heat sink cool for 10 minutes.

The 320-pin ZIF socket consists of the four rows of pin holes on each side. To avoid improper installation, the ZIF socket is designed with a Plug/Keying mechanism. There are several holes in the socket that are plugged so the CPU will only go in one way. If you are unable to easily insert the CPU, please verify that pin 1 of the CPU is being plugged into pin 1 of the socket. The location of the pin 1 is shown on the next page.

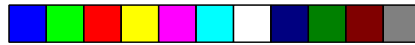

PC/ISA System Board

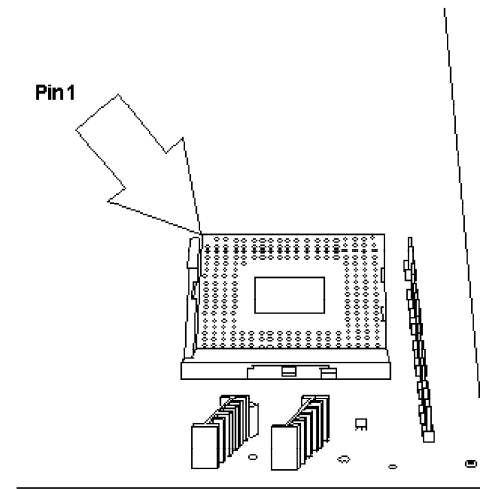

Zero Insertion Force (ZIF) Socket

To install an upgrade CPU in the G586OPA, follow the steps below.

1. Make sure the handle on the side of the ZIF socket is up. To raise the handle, push down and pull it out to the side a little and raise it as far as it will go. The top plate will slide back. Do not use screw drivers or other tools to open the socket, or damage may occur to the system or socket. It may be necessary to initially apply a small amount of sideways force to free the handle from its retaining “tab.” Once clear of the “tab,” the lever will open easily.



G5860PA

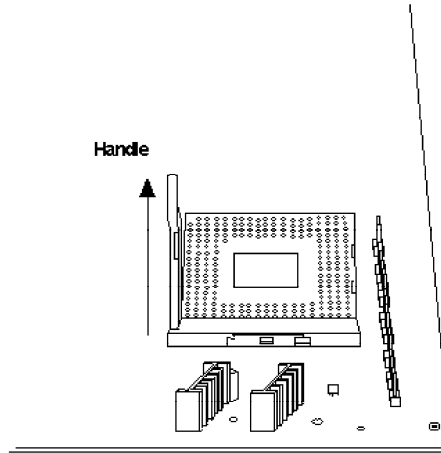

Lifting the Handle

2. Once the lever is completely up, remove the old CPU by carefully lifting it straight out of the socket. You are now ready to insert the new CPU.

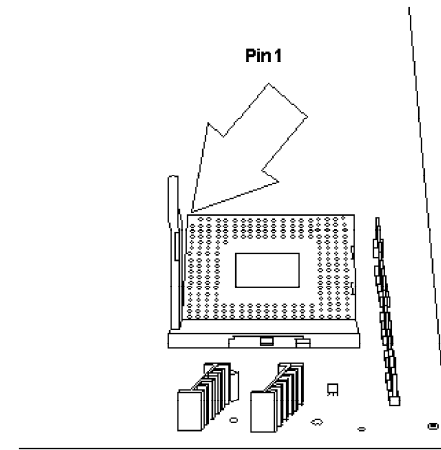

Pin 1 of the ZIF Socket

PC/ISA System Board

3. Position the CPU above the ZIF socket. Make sure pin 1 of the CPU is aligned with pin 1 of the socket. Lower the chip until the pins are inserted properly in their corresponding holes. Remember that no force is needed to install the CPU. If the CPU will not easily insert, please verify you have pin 1 of the CPU aligned with pin 1 of the socket. Applying too much pressure can damage the CPU or the socket.

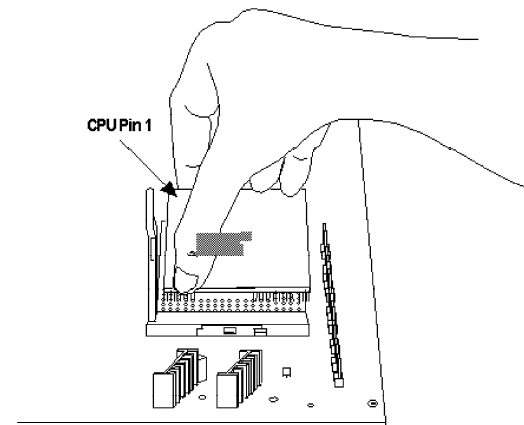

Positioning the CPU Above the ZIF Socket

4. Push the handle down until the handle locks into its place. Top plate will slide forward. You will feel some resistance as the pressure starts to secure the CPU in the socket. This is normal and will not damage the CPU. However, if the handle is not completely closed, damage to the CPU and/or system board may result.



G5860PA

Clearance Requirements

The 3.3V Pentium Upgrade Processor comes with a heat sink mounted on top. To maintain proper airflow once the upgrade is installed on the system board, the processor and sink require certain space clearances.

The clearance above 3.3V Pentium Upgrade Processor's fan/heat-sink must be at least 0.4 in. The clearance on at least 3 of 4 sides of the processor must be at least 0.2 in. The cables (for floppy drive, hard drive, CD-ROM, etc.) must be routed clear of the CPU and its airspace.

Fan Exhaust

The CPU must be kept cool by using a fan exhaust configuration in connection with the heatsink. The temperature of the air entering the fan/heatsink cannot exceed 45°C. The ambient or room temperature must be below 37°C (99°F) for a system installed with the 3.3V Pentium Upgrade Processor.

In order to provide proper airflow to the CPU, all movable obstructions (power supply cables, cards, floppy disk cables) must be clear of the CPU heatsink/fan component in accordance with the space clearance discussed in the CPU installation section of this manual.



PC/ISA System Board

Built-in Ports

The G586OPA system board is equipped with two serial ports, one ECP/EPP parallel printer port, one FDD connector, two IDE hard disk connectors and one PS/2 mouse port.

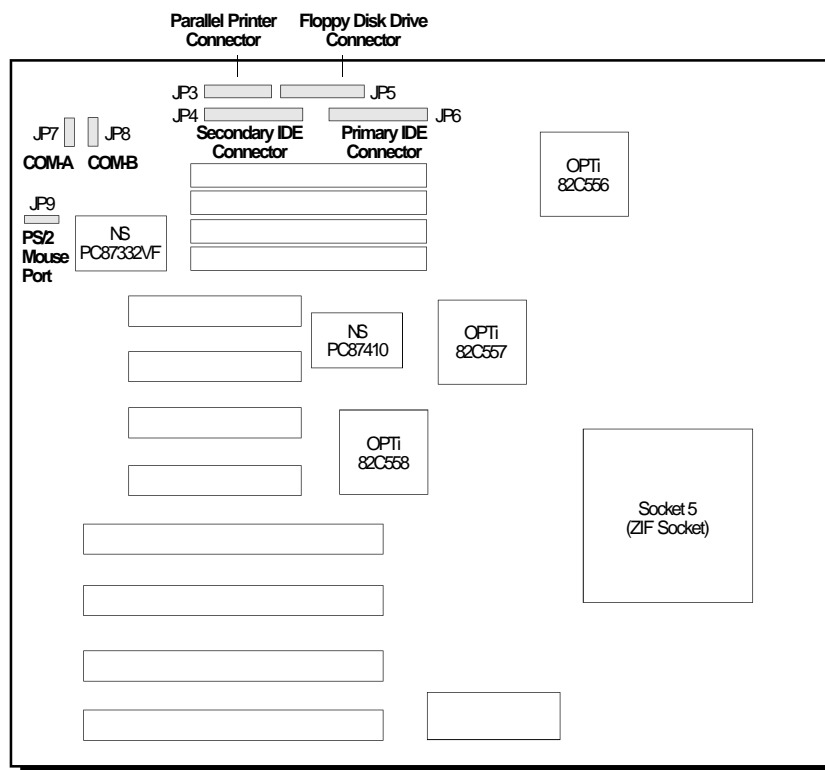

Locations of the Built-in Ports on the System Board



Serial Ports

The built-in serial ports are RS-232C asynchronous communication ports with 16C550-compatible UARTs that can be used with modems, serial printers, remote display terminals, and other serial devices. The G586OPA system board supports IRQ4 and IRQ5 for the primary serial port and IRQ3 and IRQ9 for the secondary serial port. These serial ports use the following system I/O addresses:

Port Configuration	I/O Address
COM1 COM2 COM3/COM4	3F8h 2F8h 220h/228h, 2E8h/2E0h, 3E8h/2E8h or 338h/238h

Connecting the Serial Ports

Two DB-9P serial port cables are provided with the motherboard. They are mounted on a card-edge bracket along with the PS/2 mouse cable. The upper serial port cable should be used for the COM-A primary serial port; connect it to Connector JP7 on the motherboard. The lower serial port cable should be used for the COM-B secondary serial port; connect it to Connector JP8 on the motherboard. Make sure the colored stripes on the ribbon cables align with pin 1 of Connectors JP7 and JP8. Mount the card-edge bracket to the system chassis.



PC/ISA System Board

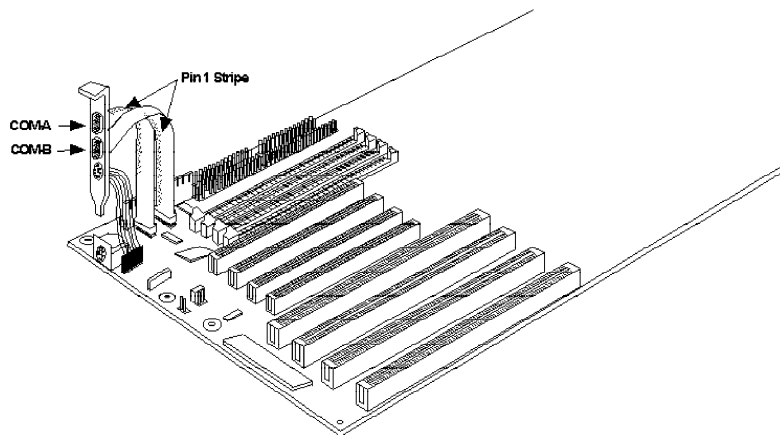

The Primary and Secondary Serial Ports on the G586OPA System Board

Parallel Port

The G586OPA system board has a standard connector for interfacing your PC to a parallel printer. This port is compatible with both IBM AT printer ports and the new, high speed, bi-directional Extended Capabilities Port standard. The parallel port on your system board can be set to any of the following system I/O addresses:

Port Configuration	I/O Address
LPT1	3BC-3BE Hex
LPT2*	378-37A Hex
LPT3	278-27A Hex

* Default setting



G586OPA

Connecting the Parallel Printer Port

Attach the DB-25S printer port cable, which came with the motherboard, to Connector JP3 on the G586OPA system board. Make sure the colored stripe on the ribbon cable aligns with pin 1 of Connector JP3. Use a small nutdriver to mount the cable into a DB-25 cutout in the system chassis.

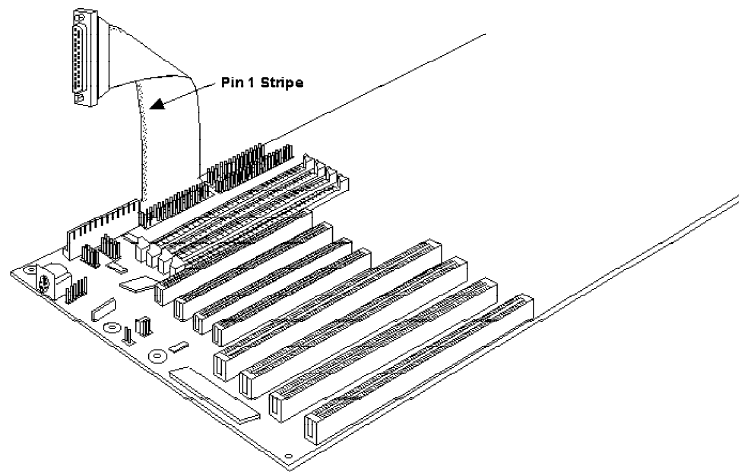

The Parallel Printer Port on the G586OPA System Board



PC/ISA System Board

Floppy Disk Drive Controller

The G586OPA system board has a built-in floppy disk controller that supports two standard floppy disk drives. You can install any 360KB/720KB/1.2MB/1.44MB/2.88MB floppy disk drives.

Connecting the Floppy Disk Cable

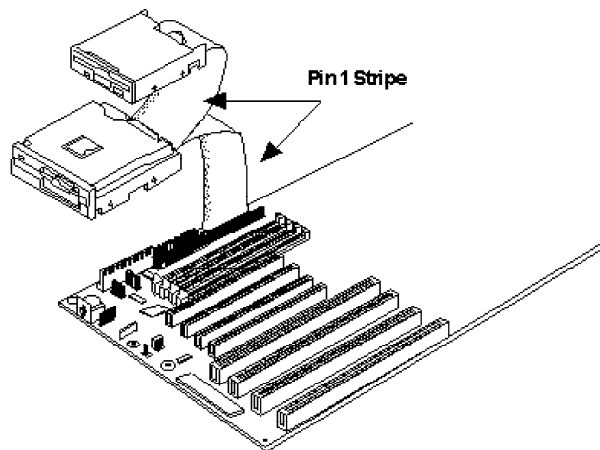

**The Floppy Disk Connector on the
G586OPA System Board**

Step 1

Install the 34-pin header connector into the floppy disk connector (JP5) on the system board. The colored edge of the ribbon should be aligned to pin 1 of the JP5 connector.



G586OPA

Step 2

Install the other 34-pin header connector(s) into the disk drive(s) with the colored edge of the daisy chained ribbon cable aligned to pin 1 of the drive edge connector(s). The end-most connector should be attached to the drive you want to be Drive A.

IDE Hard Disk Interface

The G586OPA system board is equipped with two PCI IDE connectors that will interface four IDE (Integrated Drive Electronics) hard disk drives. An IDE drive is a hard drive with the controller electronics built into the disk assembly. The integration of the controller and the drive as a single unit increases both the reliability and performance by eliminating redundant circuitry.

Note:

Only IDE drives can be connected to the IDE interface.



PC/ISA System Board

Connecting the IDE Hard Disk Interface

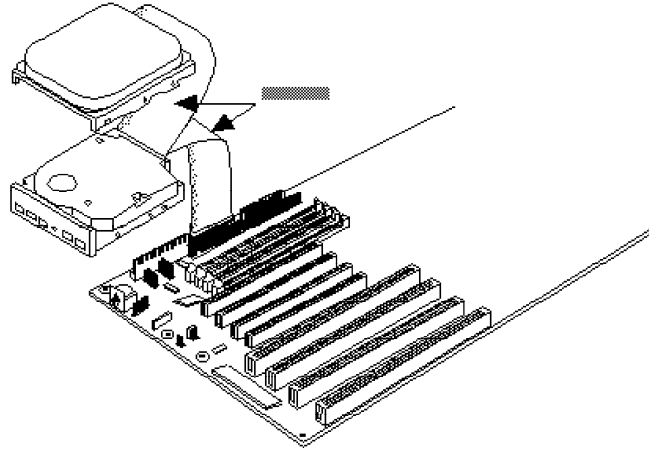

**The IDE Hard Disk Connector on the
G586OPA System Board**

Step 1

If you are connecting two hard drives, install the 40-pin connector of the IDE cable into the primary disk connector (JP6). If you are adding a third or fourth IDE device, install the 40-pin connector of the other IDE cable into the secondary connector (JP4). Make sure the colored edge of the ribbon is aligned to pin 1.

Step 2

Install the other 40-pin header connector(s) into the device with the colored edge of the ribbon cable aligned to pin 1 of the drive edge connector(s).



G586OPA

Note:

Refer to your disk drive user's manual for information about selecting proper drive switch settings.

Adding a Second IDE Hard Drive

When using two IDE drives, one must be set as the master and the other as the slave. Follow the instructions provided by the drive manufacturer for setting the jumpers and/or switches on the drives. No changes are needed on the G586OPA system board when adding a second hard drive.

We recommend that the IDE hard drives be from the same manufacturer. In a few cases, drives from two manufacturers will not function properly when used together. The problem lies in the hard drives, not the G586OPA system board.

Preparing an IDE Drive for Use

IDE disk drives are already low-level formatted, with any bad-track errors entered, when shipped by the drive manufacturer. Do not attempt to do a low-level format, or you may cause serious damage to the drive.

To use an IDE drive, you need to enter the drive type (this information is provided by the drive manufacturer) into the system's CMOS setup table. Then run FDISK and FORMAT provided with DOS.

Note:

Do not run FDISK and FORMAT programs on a drive that has already been formatted, or you will lose all programs and data stored on the drive.

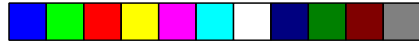

PC/ISA System Board

PS/2 Mouse Port

The PS/2 mouse port is a 6-pin connector on the system board. Attach the 6-pin mouse port cable, which came in the G586OPA box, to Connector JP9. Make sure the brown wire on the PS/2 mouse connector aligns with pin 1 of connector JP9. The other end of the wires are attached to the card-edge bracket that also holds the two serial port cables.

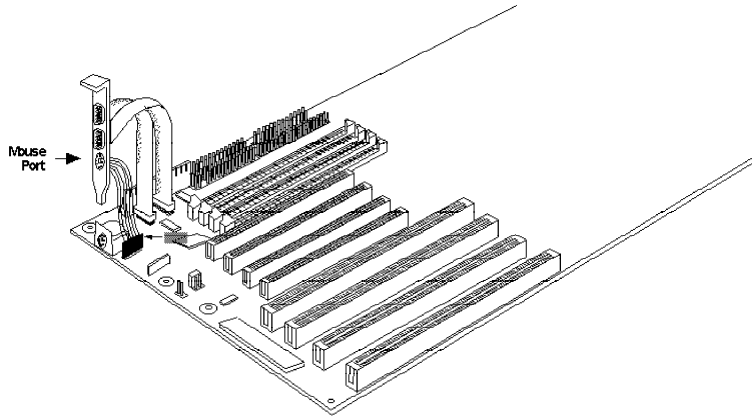

The PS/2 Mouse Port on the G586OPA System Board



Installing Expansion Cards

The G586OPA is equipped with three dedicated PCI and three dedicated ISA slots. One PCI slot and one ISA slot are shared. You can only install a card in one or the other of the shared slots at a time, you cannot install devices in both slots. Due to the size of the CPU and heatsink/fan component, card size is limited. Refer to the Features and Specifications section for limitations. The location of the expansion slots are shown below.

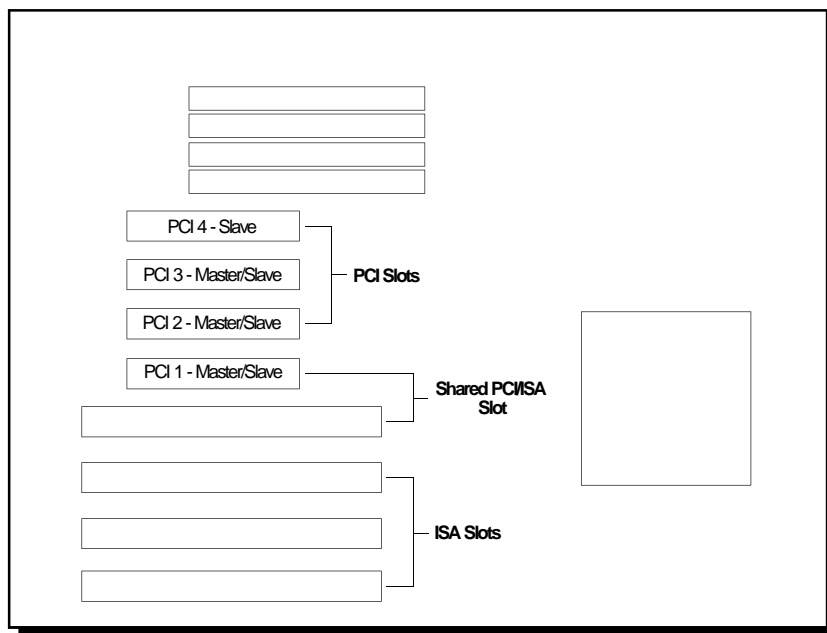

Note:

The BIOS needs to be configured for the PCI add-on cards installed in the PCI slots. Refer to the PCI Configuration Setup on page 3-9 for more information.



PC/ISA System Board

Installing the System Board

Before installing the system board into your system unit, you should prepare the tools you will need:

You will need:

- *one medium size, flat-bladed screwdriver*
- *one medium Phillips screwdriver*

Step 1

Unlock your system unit. Turn off the power and disconnect all power cords and cables.

Step 2

Remove the system unit cover. Refer to the manufacturer's instructions if necessary.

Step 3

Remove expansion cards seated in any of the expansion slots and detach all connectors from the old system board.

Step 4

Loosen the screws holding the original system board and remove the board from the system. Save the screws.

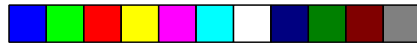

G586OPA

Step 5

Remove the G586OPA from its original packing box. Be careful to avoid touching all connectors and pins on the board. Please refer to the handling instructions on pages 2-1 and 2-2 for proper handling techniques.

Step 6

Insert the HSIM modules into the SIMM banks on the G586OPA. The quantity and location of the SIM modules is dependent upon the memory configuration and type of modules you intend to use.

Step 7

Set the corresponding jumpers.

Step 8

Install the prepared G586OPA system board into the case and replace the screws.

Step 9

Reinstall all cards and connectors and replace the system unit cover. Reconnect all power cords and cables.



❖ *Initial Setup Program*

After you power up your system, the BIOS message appears on your screen and the memory count begins.

After the memory test, the following message will appear on the screen:

Press DEL to enter setup

If the message disappears before you respond, restart your system or press the “Reset” button. You may also restart the system by pressing the <Ctrl> <Alt> keys. If you do not press these keys at the correct time and the system does not boot, the following error message will appear:

Press Del to enter Setup

If you have set a password and selected “System” in the Security Option of the BIOS Feature Setup menu, you will be prompted for the password everytime the system is rebooted or any time you try to enter Setup. Type in the correct password and press <Enter>.

If you selected “Setup” in the Security Option, you will be prompted for the password only when you try to enter Setup. Refer to the “BIOS Features Setup” section for more information.



Award BIOS CMOS Setup Utility

Press <Ctrl> <Alt> <Esc> or simultaneously to enter the Setup utility. A screen similar to the one below will appear.

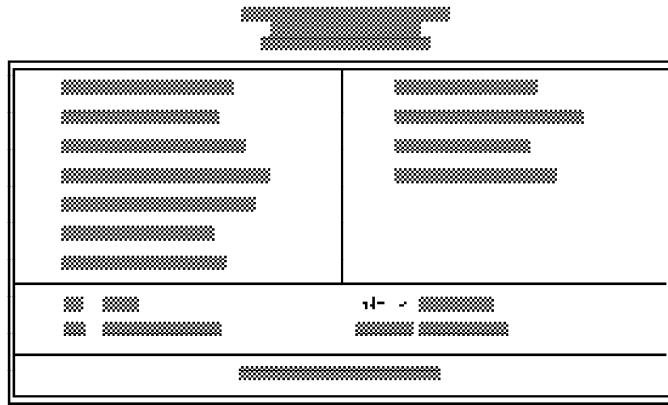

Use the arrow keys to highlight the option you want and press <Enter>.

Standard CMOS Setup

Use the arrow keys to highlight “Standard CMOS Setup” and press <Enter>, a screen similar to the one on the next page will appear.



PC/ISA System Board

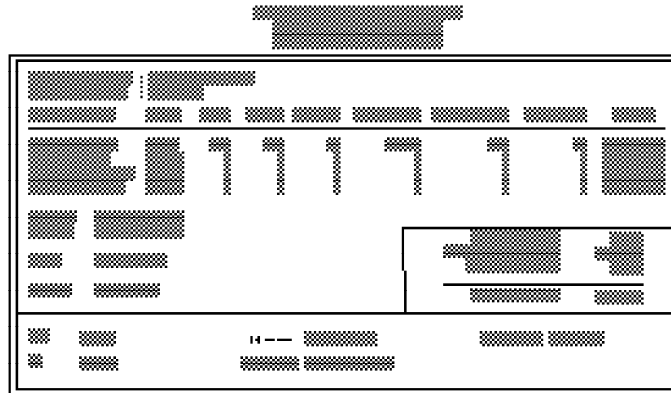

Date and Time

Sets the time and date for the system. Press <F3> for the calendar.

Primary Master, Primary Slave, Secondary Master and Secondary Slave

If you have added an IDE drive, you must select the appropriate type for the drive. You may use the "IDE HDD Auto Detection" from the main CMOS setup menu or you can set it manually. The G586OPA has 46 pre-set types and one user-definable type. Use the <Page Up> or <Page Down> keys to select the appropriate type for the drive.

The table in Appendix G gives a complete listing of the available drive types. Any given drive must be set to one specific drive-type number. Please refer to your IDE drive documentation to find the appropriate type number.



If none of the pre-set types is appropriate for your drive, choose “User”, which is the user-definable type. To use this type, highlight either the drive you want to set: Primary Master, Primary Slave, Secondary Master or Secondary Slave. Use the arrow keys until type “User” is showing. Fill in all the parameters as specified by the drive manufacturer. If a drive is not installed, select “None” and press <Enter>.

Drive A and Drive B

These options are used to select the type of floppy disk drives installed in your system. If either of the drives is not present, select “None.” Make sure you choose the correct drive type; otherwise, your system might format the device improperly.

Video

This is used to select the type of video adapter installed in your system.

Halt on

The system will halt if an error is detected during power up.

No Errors: The system boot will not stop for any detected errors.

All Errors: The system will stop whenever the BIOS detects a non-fatal error.

All, But Keyboard: The system will stop for any errors except a keyboard error.

All, But Diskette: The system will stop for any errors except a disk error.

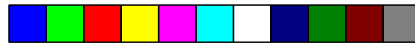

PC/ISA System Board

All, But Disk/Key: The system will stop for any errors except a keyboard or disk error.

Memory

The lower right hand corner shows the base memory size, extended memory size, and the other memory size of your system. You cannot alter these items; your computer automatically detects and displays them.

The Other Memory size refers to the memory located in the 640K to 1024K address space. This is the memory used for different applications. DOS uses this area to load device drivers to keep as much base memory free for application programs.

When you are through making changes in the Standard CMOS Setup, press <Esc> to return to the main menu.

BIOS Features Setup

Use the arrow keys to highlight “BIOS Features Setup” and press <Enter>, a screen similar to the one on the next page will appear.



G5860PA

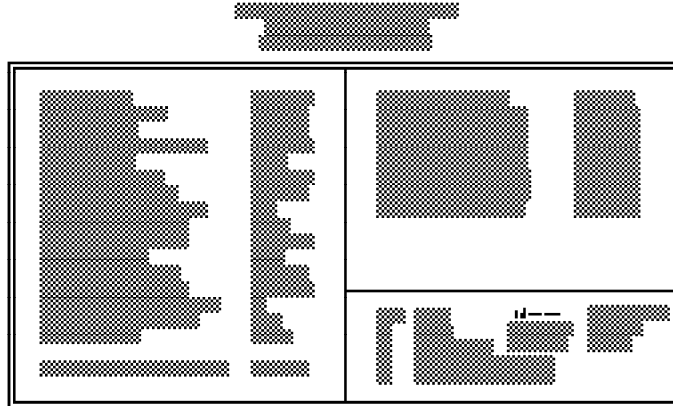

The Virus Warning option may be set to “enabled” or “disabled”. When enabled, the BIOS issues a warning when any program or virus sends a Disk Format command or attempts to write to the boot sector of the hard disk drive.

If you choose “System” in the Security Option, you will be prompted for a password every time you cold boot your system or access setup. If you choose “Setup”, you will be prompted for a password only when trying to access setup.

If you forget your password, you should use the Default Password "AWARD_SW" to clear any previously set password. Simply type **AWARD_SW**, press <Enter> and the password would be disabled.

If the changes you made are incorrect or you change your mind, press <F6> or <F7> to return to the default settings. Press <Esc> after making the changes to return to the main menu.



PC/ISA System Board

Chipset Features Setup

The G586OPA uses OPTi Viper chipset. The Chipset Features Setup allows you to modify some functions to optimize system performance. It also allows you to enable, disable or select the port address of the built-in serial ports, parallel port, floppy disk controller and hard disk controller.

If you press <Enter>, a screen similar to the one below will appear.

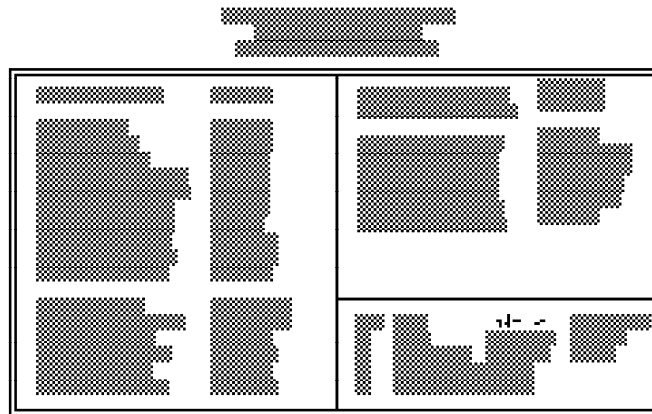

Use the arrow keys to move the highlight bar to the option you wish to change or modify. Use the <Page Up>, <Page Down>, <+> or <-> keys to make the corresponding changes.

If the changes you made are incorrect or you change your mind, press <F6> or <F7> to return to the default settings. Press <Esc> after making the changes to return to the main menu.

3-7 ◆ Initial Setup Program



PC/ISA System Board

PCI Configuration Setup

Use the arrow keys to highlight “PCI Configuration Setup” and press <Enter>, a screen similar to the one below will appear.

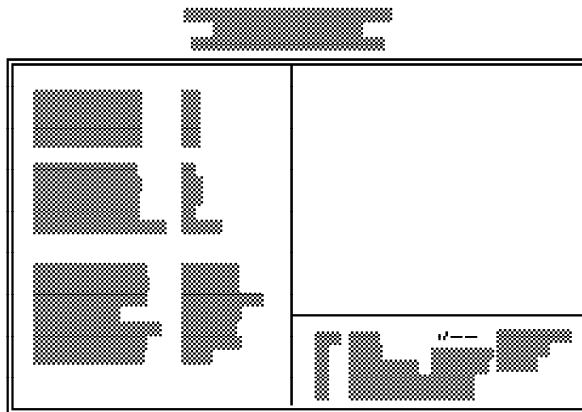

The G586OPA system board supports four PCI slots. Each slot may be assigned INT A, B, C, D if the card installed in the slot requires an interrupt. Each INT may then be assigned an IRQ value.

Most PCI cards can be installed successfully if you configure the required PCI interrupt to INT A as shown above. However, if you experience difficulty using the standard setup, refer to the following examples. Examples 1-7 show how to match the interrupt on the PCI adapter with BIOS.



G5860PA

Example 1:

	DFI SHA-1000P (NCR 53C810)	DFI NET-800P (AMD 79C970)
PCI Slot	PC2	PC1
System IRQ	IRQ9	IRQ10
INT on Adapter	INT C	INT B

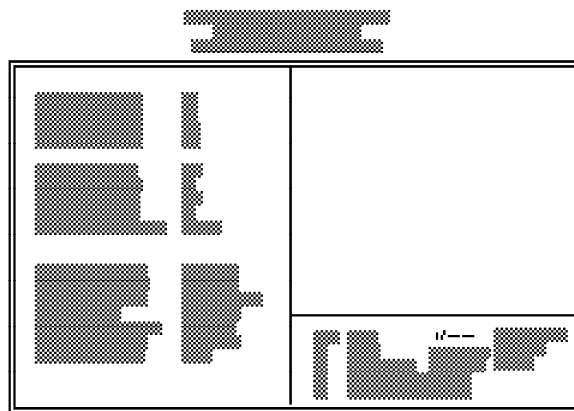

Example 2:

	Adaptec AHA-2940	DFI NET-800P (AMD 79C970)	WG-9140P (Power 9100)
PCI Slot	PC2	PC3	PC4
System IRQ	IRQ11	IRQ10	None
INT on Adapter	INT A	INT B	None



PC/ISA System Board

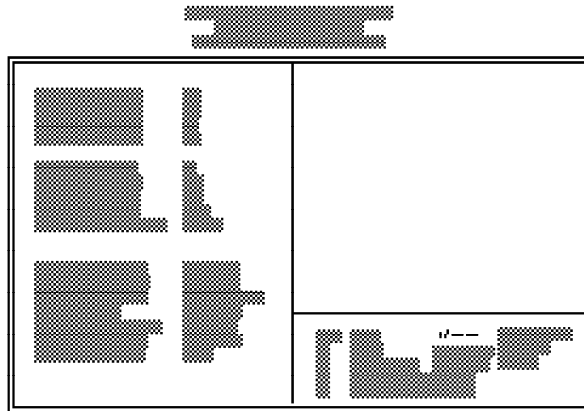

Example 3:

	Buslogic BT-946C	DFI NET-800P (AMD 79C970)	WG-9140P (Power 9100)
PCI Slot	PC1	PC2	PC3
System IRQ	IRQ11	IRQ10	None
INT on Adapter	INT C	INT A	None

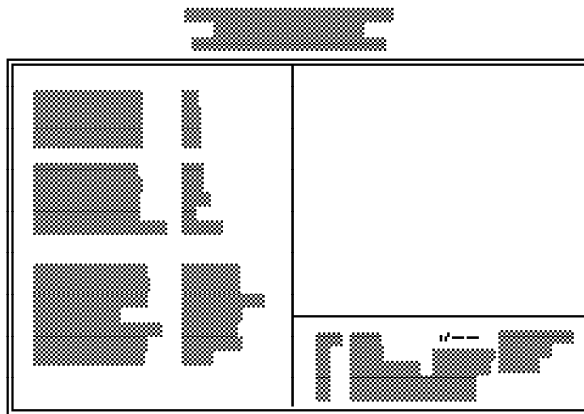

3-11 ♦ Initial Setup Program



G5860PA

Example 4:

	DFI SHA-1000P (NCR 53C810)	DFI NET-800P (AMD 79C970)	WG-3120P (S3 Trio64)
PCI Slot	PCI2	PCI3	PCI4
System IRQ	IRQ11	IRQ10	None
INT on Adapter	INT B	INT C	None

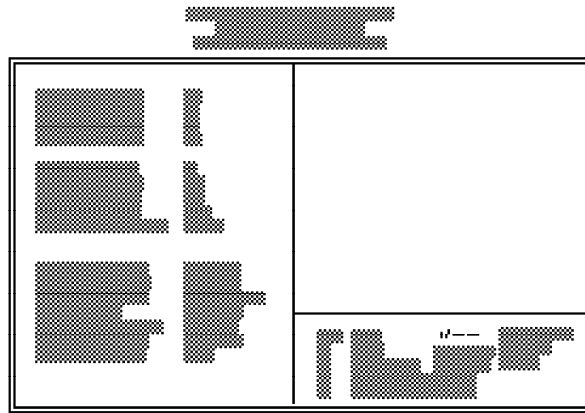



PC/ISA System Board

Example 5:

	WG-300P (S3 82C864P)	DFI NET-800P (AMD 79C970)
PCI Slot	PCI4	PCI3
System IRQ	None	IRQ11
INT on Adapter	None	INT B
Card Type (Master/Slave)	Slave	Master

	DFI NET-800P (AMD 79C970)	DFI SHA-1000P (NCR 53C810)
PCI Slot	PCI2	PCI1
System IRQ	IRQ10	IRQ9
INT on Adapter	INT B	INT A
Card Type (Master/Slave)	Master	Master

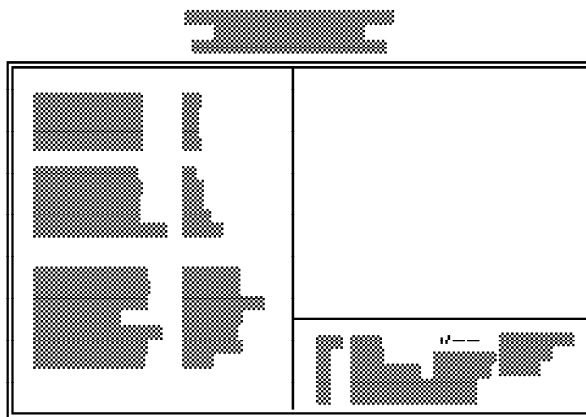

Note:
PCI Slot 4 can support Slave PCI cards only.

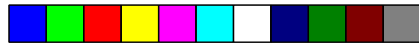

G5860PA

Example 6:

	SHA-1X00P (NCR 53C81X)	WG-3000P (S3 82C860-P)
PCI Slot	PCI2	PCI4
System IRQ	IRQ10	None
INT on Adapter	INT C	None
Card Type (Master/Slave)	Master	Slave

	SHA-1X00P (NCR 53C81X)	NET-800P (AMD 79C970)
PCI Slot	PCI3	PCI1
System IRQ	IRQ11	IRQ9
INT on Adapter	INT A	INT B
Card Type (Master/Slave)	Master	Master

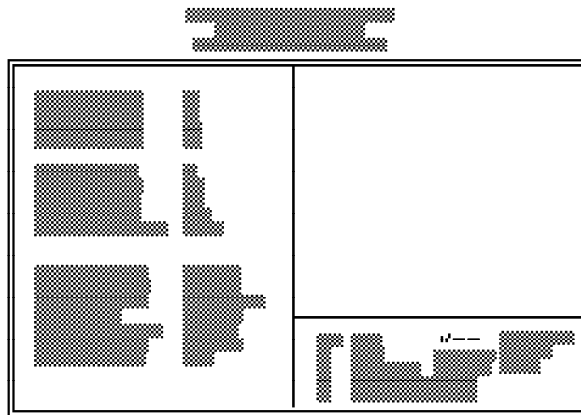

Note:
PCI Slot 4 can support Slave PCI cards only.



PC/ISA System Board

Example 7:

	NET-800P (AMD 79C970)	NET-800P (AMD 79C970)
PCI Slot	PC1	PC2
System IRQ	IRQ5	IRQ9
INT on Adapter	INT A	INT B
Card Type (Master/Slave)	Master	Master

	NET-800P (AMD 79C970)	WG-3000P (S3 82C864P)
PCI Slot	PC3	PC4
System IRQ	IRQ10	None
INT on Adapter	INT C	None
Card Type (Master/Slave)	Master	Master

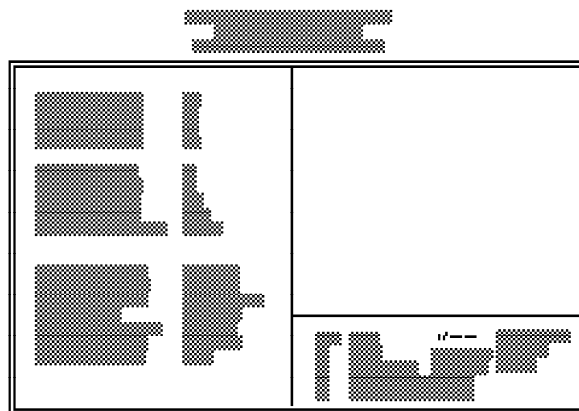



Use the arrow keys to move the highlight bar to the option you wish to change or modify. Use the <Page Up>, <Page Down>, <+> or <-> keys to make the corresponding changes.

If the changes you made are incorrect or you change your mind, press <F6> or <F7> to return to the default settings. Press <Esc> after making the changes to return to the main menu.

Load BIOS Defaults

If, for some reason, the CMOS setting becomes corrupted, the system can be reconfigured with the default values stored in the ROM chips. The BIOS Setup default values should provide the slowest but the most reliable performance for the system.

Highlight this option on the main menu and press <Enter>. The message below will appear.

Load BIOS Defaults (Y/N)? N

Type “Y” and press <Enter> to return to the BIOS setup default values. After pressing <Enter>, you will be returned to the main menu.



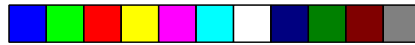

PC/ISA System Board

Load Setup Defaults

The Setup defaults are similar to the BIOS Setup defaults. These defaults are the most stable and are the standard values for the system.

Highlight this option on the main menu and press <Enter>. The message below will appear.

Load Setup Defaults (Y/N)? N

Type “Y” and press <Enter> to return to the Setup default values. After pressing <Enter>, you will be returned to the main menu.

To configure your system for optimum performance, you must reset the options under the Chipset Features setup. You are advised to do so only under the instruction of a technical engineer, otherwise, failure may occur.

Password Setting

If you want to set a password, make sure that the Security Option under the BIOS Features Setup is set to “System” or “Setup”. Refer to the BIOS Features Setup option for more information.

Use the arrow keys to highlight the Password Setting option and press <Enter>. The message below will appear.

Enter Password:



G5860PA

Type in the password. You are limited to eight characters. Type in a password that is eight characters long or shorter. When done, the message below will appear:

Confirm Password:

You are asked to verify the password. Type in exactly the same password. If you type in a wrong password, you will be prompted to enter the correct password again. Otherwise, enter a new password.

To delete or disable the password function, simply press <Enter> instead of typing in a new password. Press the <Esc> key to return to the main menu.

If you forget your password, you should use the Default Password "AWARD_SW" to clear any previously set password. Simply type **AWARD_SW**, press <Enter> and the password would be disabled.

IDE HDD Auto Detection

This option detects the hard disk parameters for the hard disk drives installed in your system. Highlight this option and press <Enter>. A screen similar to the one shown on the next page will appear.



PC/ISA System Board

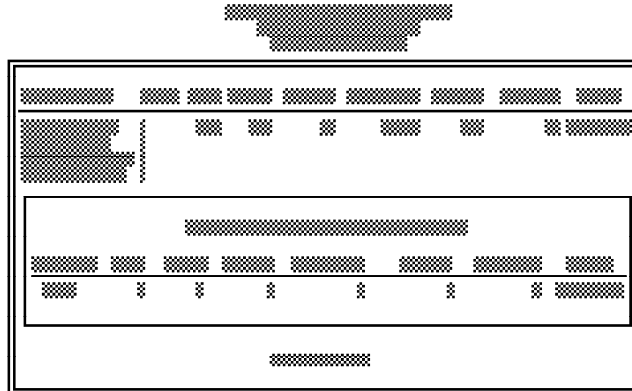

The screen displays the parameters detected and allows you to accept or reject the parameters. Type “Y” and press <Enter> to accept the parameters or press <Esc> to abort. If you select “Y”, the parameters of the hard disk will be displayed in the Standard CMOS Setup.

Save & Exit Setup

When all the changes have been made, highlight “Save & Exit Setup” and press <Enter>. The message below will appear:

Save to CMOS and Exit (Y/N)? N

Type “Y” and press <Enter>. The following message will appear:

Reboot System (Y/N)? N



G5860PA

Type “Y” and press <Enter>. The modifications you have made will be written into the CMOS memory, and the system will reboot. You will once again see the initial diagnostics on the screen. If you wish to make additional changes to the setup, press <Ctrl> <Alt> <Esc> or simultaneously after memory testing is done.

Exit Without Saving

When you do not want to save the changes you have made, highlight this option and press <Enter>. The message below will appear:

Quit Without Saving (Y/N)? N

Type “Y” and press <Enter>. The system will reboot and you will once again see the initial diagnostics on the screen. If you wish to make any changes to the setup, press <Ctrl> <Alt> <Esc> or simultaneously after memory testing is done.



❖ IDE Device Drivers

The G586OPA system board incorporates a high performance PCI IDE interface. It uses the NS PC87410 PCI IDE chip and is equipped with two 40-pin IDE connectors.

The G586OPA comes with two PCI IDE driver diskettes. The “PC87410 PCI IDE Device Drivers” diskette includes drivers for DOS, Windows 3.1x and Windows for Workgroups 3.1x, Windows NT, OS/2 2.1x, and Novell NetWare 3.1x and 4.x. The “PC87410 PCI IDE SCO UNIX Drivers” diskette includes drivers for SCO UNIX 3.2.2 and 3.2.4.

Installation Utility

To run the Installation Utility, type:

A:\INSTALLBAT

The Installation Utility includes the following options.

1. **R/W Multiple** - This option is for setting the “multiple sectors transfer per interrupt”. This is not supported by all drives. “Disabled” will be shown in this field if a drive does not support this option. The default value for HDDs supporting this option would be the largest allowed multiple sectors transfer per interrupt.
2. **Track Remapping** - Required to support HDDs larger than 528MB capacity or cylinders greater than 1024. Operating systems other than NetWare require device drivers to work with drives larger than 528MB.



For operating systems that require track remapping, the drive type must be set to “Not Installed” in the CMOS setup.

Example:

A user has four 806MB drives with the following parameters: CYL=1600, HEAD=16, SECTOR=63.

Case 1:

Drive 0 = Master drive of primary IDE	MB Drive C = type 47
Drive 1 = Slave drive of primary IDE	MB Drive D = non-installed
Drive 2 = Master drive of secondary IDE	Unrelated to MB CMOS setup
Drive 3 = Slave drive of secondary IDE	Unrelated to MB CMOS setup

Drive 0 is controlled by the system BIOS, no track remapping is allowed and the maximum capacity that can be used under DOS/Windows is 528MB.

Drives 1, 2 and 3 are not initially controlled by the system BIOS: track remapping is allowed and the drive's full capacity is available under DOS/Windows.

Case 2:

Drive 0 = Master drive of primary IDE	MB Drive C = type 47
Drive 1 = Slave drive of primary IDE	MB Drive D = type 47
Drive 2 = Master drive of secondary IDE	Unrelated to MB CMOS setup
Drive 3 = Slave drive of secondary IDE	Unrelated to MB CMOS setup

Drives 0 and 1 are initially controlled by the system BIOS, no track remapping is allowed and the maximum capacity that can be used under DOS/Windows is 528MB.

Drives 2 and 3 are not controlled by the system BIOS; track remapping is allowed and the drive's full capacity is available under DOS/Windows.



PC/ISA System Board

3. **Mode 3** - This option is only for HDDs that support Mode 3.
4. **Logical Block Addressing (LBA)** - This option is only for HDDs that support LBA mode.
5. **Drive Speed** - INSTALL.EXE, under the DOSDRV directory get the hard drive's speed from the DEVICE.LOG file if the information is already present in the file. If the drive's speed information is not present in the DEVICE.LOG file, run "Test" to find out the optimized speed. If you choose "Auto," the controller will select the speed according to the drive's PIO mode. Refer to the on-line Help for more information.

Mode 0:	speed = 1	600ns cycle time
Mode 1:	speed = 6	390ns
Mode 2:	speed = 11	240ns
Mode 3:	speed = 13	180ns

Note:

For a more accurate speed test, a local bus clock greater than or equal to 33MHz is highly recommended.

The following is a table of the drive's speed based on a 33MHz system. Other local bus clocks will give slightly different results.



G586OPA

Speed	CycleTime
0	630ns
1	600ns
2	540ns
3	480ns
4	450ns
5	420ns
6	390ns
7	360ns
8	330ns
9	300ns
10	270ns
11	240ns
12	210ns
13	180ns

Note:

You must reinstall the drivers everytime you add or change your hard drive to gain the maximum performance, otherwise, the driver will use 600ns cycle time for the added or changed drive.

The Installation Utility also includes information about:

1. **Drive #:** [Ch0-M] is Master device on the Primary channel. [Ch0-S] is Slave device on the Primary channel. [Ch1-M] and [Ch1-S] are Master and Slave devices on the Secondary channel.
2. **PIO Mode:** HDD's supported timing mode.
3. **Drive Information:** Model #, Parameter (cylinder/head/sector), and capacity.



PC/ISA System Board

The following explains the INSTALL.BAT and DEVICE.LOG files.

INSTALL.BAT

This is used to configure working hard drives for future installation under DOS, Windows NT and OS/2. The HDD's parameter information includes: R/W Multiple, Track Remapping, Mode 3, LBA, and Drive Speed. After confirming "Yes", the DOS drive will be installed and the configuration information for OS/2 and Windows NT will also be updated to the following files.

DOS:	A:\DOSDRVNSIDE.EXE
Windows NT:	A:\NTDRVATDIS.SYS
OS/2:	A:\OS2DRVNSIDEOS2.ADD

DEVICE.LOG

The DEVICE.LOG file is contained in the DOSDRV directory of the "PC87410 PCI IDE Device Drivers" diskette. By running INSTALL.BAT, you can use the DEVICE.LOG file to log drive speed information. INSTALL.EXE, under the DOSDRV directory, will update a new drive speed information to the DEVICE.LOG file. If it doesn't exist, copy the DEVICE.LOG file to Drive C for future use. For drives that don't have speed information available in the DEVICE.LOG file, you must run "Test" under the "Drive_Speed" option of the Installation Utility. Execute INSTALL.BAT to run the Installation Utility.

Installing the DOS Driver

1. Insert the "PC87410 PCI IDE Device Drivers" diskette into drive A.
2. Type INSTALL.BAT.



G5860PA

Installing the Windows 3.1x and Windows for Workgroups Driver

To install:

1. You must first install the DOS driver. (Run INSTALL.EXE, under the DOSDRV directory, to install the DOS driver).
2. Use Windows File Manager to run A:\WINDRV\INSTALL.EXE.

To remove:

1. When you install the Windows driver, the original SYSTEM.INI under the Windows directory will be renamed as SYSTEM.001.

To remove the installed Windows driver, rename SYSTEM.001 to SYSTEM.INI.

The Windows 32-bit driver supports:

1. Two channels with two drives for each channel. This totals to a maximum of four drives.
2. Track Remapping to support hard disk larger than 528MB.
3. Microsoft's 32-bit driver does not support a secondary channel and track remapping. It also does not enable the 32-bit disk access during installation if the target disk is connected to the secondary channel. The 32-bit disk access will be enabled after the Windows driver is installed.



PC/ISA System Board

Installing NetWare 3.11, 3.12, SFT-III, 4.00, 4.01 Driver

1. You must first install the DOS driver. (Run INSTALL.EXE, under the DOSDRV directory, to install the DOS driver).
2. Follow the installation procedures of the NetWare installation manual.

Installing the Windows NT v3.x Driver

To install:

1. Insert the "PC87410 PCI IDE Device Drivers" diskette into a floppy drive.
2. Run INSTALL.EXE, under the DOSDRV directory, to configure and choose not to copy files to drive C.
3. After installing the driver, run Windows NT and use the File Manager to run A:\NTDRV\SETUP.EXE.
4. Reboot the system.

To remove:

1. Use Windows NT's File Manager to run A:\NTDRV\UNINSTALE.EXE.
2. Reboot the system.



G586OPA

Installing the OS/2 v2.1x Driver

To install:

1. Insert the "PC87410 PCI IDE Device Drivers" diskette into a floppy drive.
2. After OS/2 is installed, click the OS/2 System icon. The OS/2 System - Icon View screen will appear. Select the System Setup icon. Another screen will appear. Select the Device Driver Install icon to proceed with the driver installation.
3. The OS/2 2.1 Device Driver Installation screen will appear. Change the source directory to A:\OS2.DRV and select Install.

To remove:

1. When you install the OS/2 driver, the original CONFIG.SYS under the C:\ directory will be renamed as CONFIG.1.

To remove the installed OS/2 driver, rename CONFIG.1 to CONFIG.SYS.

C:\COPY CONFIG.1 CONFIG.SYS

2. Reboot the system.

Installing the SCO UNIX Driver

To install:

1. Insert the "PC87410 PCI IDE Device Drivers" diskette into a floppy drive.



PC/ISA System Board

2. Copy the DEVICE.LOG file from the DOSDRV directory of the diskette to /etc by typing the following at the prompt: **doscp a:/dosdrv/device.log /etc**

3. Type:

```
cd /dev  
mv dsk/finstall dsk/finstall.org ; mknod dsk/finstall b 2  
164  
mv rdsk/finstall rdsk/finstall.org ; mknod rdsk/finstall c 2  
164
```

4. Type: **installpkg**

Note:

It may take a while for the system to respond. Do not hit any key during this period.

5. Insert the “PC87410 PCI IDE SCO UNIX Drivers” diskette into a floppy drive.
6. Press <Enter> to copy from floppy drive 0.
7. Press <Enter> to install the driver.
8. Type “Y” twice to make the newly built kernel as the booting default.
9. For SCO 3.2.2, type:

```
cd /dev  
mv dsk/f0.org dsk/f0  
mv rdsk/f0.org rdsk/f0
```

For SCO 3.2.4

```
cd /dev  
mv dsk/finstall.org dsk/finstall  
mv rdsk/finstall.org rdsk/finstall
```



G5860PA

9. Reboot the system by typing: **haltsys**

To remove:

1. At the UNIX prompt, type:**removepkg**
2. Type “NS-IDE NS (PC87410) PCI-IDE Driver Package.”
3. Press <Enter> to remove the NS-IDE driver.
4. Type “Y” twice to make the newly built kernel as the booting default.
5. Reboot the system by typing: **haltsys**

Installing the CD-ROM Driver

To install:

1. Under Windows 3.1x, run **INSTALL.EXE**.
2. Under the Main group of the Program Manager, double-click the Control Panel icon.
3. The Control Panel screen will appear. Click the Drivers icon.
4. The Drivers screen will appear. Select "Add[MCI] CD Audio" and insert the "PC87410 PCI IDE Device Drives" diskette when prompted.
5. Restart Windows.



❖ *Troubleshooting Checklist*

If you experience difficulty with the G586OPA system board, please refer to the checklist below. If you still cannot isolate the problem, please contact your dealer.

- 1) Check the jumper settings to ensure that the jumpers are properly set. If in doubt, refer to the “Board Configuration” section.
- 2) Verify that all SIM modules are seated securely into the bank sockets.
- 3) Make sure that the SIM modules are in the correct locations.
- 4) Check that all populated memory banks are filled with valid size SIM modules.
- 5) If your board fails to function, place the board on a flat surface and seat all socketed components (gently press each component into the socket).
- 6) If you made changes to the BIOS settings, re-enter setup and load the BIOS defaults.



❖ *Appendix A: Types of Modules*

The G586OPA system board allows you to populate memory with 256Kx36, 512Kx36, 1Mx36, 2Mx36, 4Mx36 and 8Mx36 SIM modules. The following modules have been tested with this board. Most untested brands will work but a few may fail to do so.

For SIM 256Kx36 Modules

Brand	Chip Number
OKI	M51C256A-70

For SIM 512Kx36 Modules

Brand	Chip Number
OKI	M514256B-70J

For SIM 1Mx36 Modules

Brand	Chip Number
Toshiba	TC511000AJL
OKI	GT-1M*36B
Fujitsu	81C1000A-70



PC/ISA System Board

For SIM 2Mx36 Modules

Brand	Chip Number
OKI	M511000B

For SIM 4Mx36 Modules

Brand	Chip Number
OKI	M514100A-70S

For SIM 8Mx36 Modules

Brand	Chip Number
OKI	M514100AL-70K



❖ **Appendix B: System Error Report**

When the BIOS encounters an error that requires the user to correct something, either a beep code will sound or a message will be displayed in a box in the middle of the screen and a message **PRESS F1 TO CONTINUE**, **CTRL-ALT-ESC** or **DEL TO ENTER SETUP** will be shown in the information box at the bottom.

POST Beep

Currently, there is only one beep code in BIOS. This code indicates that a video error has occurred and the BIOS cannot initialize the video screen to display any additional information. This beep code consists of a single long beep followed by two short beeps.

Error Messages

One or more of the following messages may be displayed if the BIOS detects an error during the POST.

CMOS CHECKSUM ERROR

Checksum of CMOS is incorrect. This can indicate that CMOS has become corrupt. This error may have been caused by a weak battery. Check the battery and replace if necessary.

DISK BOOT FAILURE, INSERT SYSTEM DISK AND PRESS ENTER

No boot device was found. Insert a system disk into Drive A and press <Enter>. Assuming the system is booted from the hard drive, make sure the controller is inserted correctly and all cables are properly attached. Also be sure the disk is formatted as a boot device.



PC/ISA System Board

Then reboot the system.

DISKETTE DRIVES OR TYPES MISMATCH ERROR - RUN SETUP

Type of diskette drive installed in the system is different from the CMOS definition. Run setup to reconfigure the drive type correctly.

DISPLAY SWITCH IS SET INCORRECTLY

Display switch on the motherboard can be set to either monochrome or color. This indicates the switch is set to a different setting than indicated in Setup. Determine which setting is correct, and then either turn off the system and change the jumper, or enter Setup and change the VIDEO selection.

DISPLAY TYPE HAS CHANGED SINCE LAST BOOT

Since last powering off the system, the display adapter has been changed. You must configure the system for the new display type.

ERROR ENCOUNTERED INITIALIZING HARD DRIVE

Hard drive cannot be initialized. Be sure the adapter is installed correctly and all cables are correctly and firmly attached. Also, be sure the correct hard drive type is selected in Setup (refer to Appendix G).

ERROR INITIALIZING HARD DISK CONTROLLER

Cannot initialize controller. Make sure the card is correctly and firmly installed in the bus. Be sure the correct hard drive type is selected in Setup. Also, check to see if any jumper needs to be set correctly on the hard drive.

**FLOPPY DISK CNTRLR ERROR OR NO CNTRLR PRESENT**

Cannot find or initialize the floppy drive controller. Make sure the controller is installed correctly and firmly. If there are no floppy drives installed, be sure the Diskette Drive selection in Setup is set to NONE.

KEYBOARD ERROR OR NO KEYBOARD PRESENT

Cannot initialize the keyboard. Make sure the keyboard is attached correctly and no keys are being pressed during the boot.

If you are purposely configuring the system without a keyboard, set the error halt condition in Setup to HALT ON ALL, BUT KEYBOARD. This will cause the BIOS to ignore the missing keyboard and continue the boot.

MEMORY ADDRESS ERROR AT..

Indicates a memory address error at a specific location. You can use this location along with the memory map for your system to find and replace the bad memory chips.

MEMORY PARITY ERROR AT..

Indicates a memory parity error at a specific location. You can use this location along with the memory map for your system to find and replace the bad memory chips.

MEMORY SIZE HAS CHANGED SINCE LAST BOOT

Memory has been added or removed since the last boot. Enter Setup and enter the new memory size in the memory fields.



PC/ISA System Board

MEMORY VERIFY ERROR AT...

Indicates an error verifying a value already written to memory. Use the location along with your system's memory map to locate the bad chip.

OFFENDING ADDRESS NOT FOUND

This message is used in conjunction with the I/O CHANNEL CHECK and RAM PARITY ERROR messages when the segment that has caused the problem cannot be isolated.

OFFENDING SEGMENT

This message is used in conjunction with the I/O CHANNEL CHECK and RAM PARITY ERROR messages when the segment that has caused the problem has been isolated.

PRESS A KEY TO REBOOT

This will be displayed at the bottom screen when an error occurs that requires a reboot. Press any key and the system will reboot.

PRESS F1 TO DISABLE NMI, F2 TO REBOOT

When BIOS detects a Non-Maskable Interrupt condition during boot, this will allow NMI to be disabled and continue to boot. You can also reboot the system with the NMI enabled.

RAM PARITY ERROR - CHECKING FOR SEGMENT

Indicates a parity error in Random Access Memory.

SYSTEM HALTED, (CTRL-ALT-DEL) TO REBOOT...

Indicates the present boot attempt has been aborted and the system must be rebooted. Press and hold down the CTRL and ALT keys and press DEL simultaneously.



G5860PA

❖ *Appendix C: Memory & I/O Maps*

Memory Address Map

Address	Name	Function
0000000 to 009FFFF	640K System Board RAM	System Board Memory
00A0000 to 00BFFFF	128K Video Display Memory	Reserved for Graphics Display Memory
00C0000 to 00EFFFF	192K I/O Expansion ROM	Reserved for ROM on I/O Adapter Card
00F0000 to 00FFFFFF	64K ROM on the System Board	System Board BIOS
0100000 to 3FFFFFF	Maximum Memory 128M	System Board Memory



PC/ISA System Board

I/O Address Map

I/O Address	Function
000-01F	DMA Controller 1, 8237A-5
020-03F	Interrupt Controller 1, 8259A, Master
040-05F	Timer, 8254-2
060-06F	8742 (Keyboard Controller)
070-07F	Real-time Clock, NMI (Non-maskable Interrupt) Mask
080-09F	DMA Page Memory, 74LS612
0A0-0BF	Interrupt Controller 2, 8259A
0C0-0DF	DMA Controller 2, 8237A-5
0E8	Shadow RAM and Cache Control Bit
0F0	Clear Numeric Processor Extension Busy
0F1	Reset Numeric Processor Extension
0F8-0FF	Numeric Processor Extension
1F0-1F8	Fixed Disk
200-207	Game I/O
278-27F	Parallel Printer Port 2
2F8-2FF	Serial Port 2
300-31F	Prototype Card
360-36F	Reserved
378-37F	Parallel Printer Port 1
380-38F	SDLC, Bisynchronous 2
3A0-3AF	Bisynchronous 1
3B0-3BF	Monochrome Display and Printer Adapter
3C0-3CF	Reserved
3D0-3DF	Color/Graphics Monitor Adapter
3F0-3F7	Diskette Controller
3F8-3FF	Serial Port 1

Note:

The I/O address hex 000 to 0FF are reserved for the system board I/O. Hex 100 to 3FF are available on the I/O channels.

❖ Appendix D: PCI I/O Pin Assignments

Component Side	B	A	Solder Side
	-12V	-01 -	TRST#
	TCK	-02 -	+12V
	Ground	-03 -	TMS
	TDO	-04 -	TDI
	+5V	-05 -	+5V
	+5V	-06 -	INTA#
	INTB#	-07 -	INTC#
	INTD#	-08 -	+5V
	PRSNT1#	-09 -	Reserved
	Reserved	-10 -	+5V (I/O)
	PRSNT2#	-11 -	Reserved
	Ground	-12 -	Ground
	Ground	-13 -	Ground
	Reserved	-14 -	Reserved
	Ground	-15 -	RST#
	CLK	-16 -	+5V (I/O)
	Ground	-17 -	GNT#
	REQ#	-18 -	Ground
	+5V (I/O)	-19 -	Reserved
	AD[31]	-20 -	AD[30]
	AD[29]	-21 -	+3.3V
	Ground	-22 -	AD[28]
	AD[27]	-23 -	AD[26]
	AD[25]	-24 -	Ground
	+3.3V	-25 -	AD[24]
	C/BE[3]#	-26 -	IDSEL
	AD[23]	-27 -	+3.3V
	Ground	-28 -	AD[22]
	AD[21]	-29 -	AD[20]
	AD[19]	-30 -	Ground
	+3.3V	-31 -	AD[18]
	AD[17]	-32 -	AD[16]
	C/BE[2]#	-33 -	+3.3V
	Ground	-34 -	FRAME#
	IRDY#	-35 -	Ground
	+3.3V	-36 -	TRDY#
	DEVSEL#	-37 -	Ground
	Ground	-38 -	STOP#
	LOCK#	-39 -	+3.3V
	PERR#	-40 -	SDONE
	+3.3V	-41 -	SBO#
	SERR#	-42 -	Ground
	+3.3V	-43 -	PAR
	C/BE[1]#	-44 -	AD[15]
	AD[14]	-45 -	+3.3V
	Ground	-46 -	AD[13]
	AD[12]	-47 -	AD[11]
	AD[10]	-48 -	Ground
	Ground	-49 -	AD[09]
	AD[08]	-52 -	C/BE[0]#
	AD[07]	-53 -	+3.3V
	+3.3V	-54 -	AD[06]
	AD[05]	-55 -	AD[04]
	AD[03]	-56 -	Ground
	Ground	-57 -	AD[02]
	AD[01]	-58 -	AD[00]
	+5V (I/O)	-59 -	+5V (I/O)
	ACK64#	-60 -	REQ64#
	+5V	-61 -	+5V
	+5V	-62 -	+5V



PC/ISA System Board

❖ Appendix E: ISA I/O Pin Assignments

B	A
Gnd	- 01 -
Reset.Drv	- 02 -
+5VDC	- 03 -
IRQ9	- 04 -
-5VDC	- 05 -
DRQ2	- 06 -
-12VDC	- 07 -
OAS	- 08 -
+12VDC	- 09 -
Gnd	- 10 -
-SEMEMM	- 11 -
-SEMEMR	- 12 -
-IOW	- 13 -
-IOR	- 14 -
-Dack3	- 15 -
-DRQ3	- 16 -
-Dack1	- 17 -
-DRQ1	- 18 -
-Refresh	- 19 -
CLK	- 20 -
IRQ7	- 21 -
IRQ6	- 22 -
IRQ5	- 23 -
IRQ4	- 24 -
IRQ3	- 25 -
-Dack2	- 26 -
TC	- 27 -
Bale	- 28 -
+5VDC	- 29 -
OCS	- 30 -
Gnd	- 31 -

D	C
-MemCS16	- 01 -
-I/OCS16	- 02 -
IRQ10	- 03 -
IRQ11	- 04 -
IRQ12	- 05 -
IRQ13	- 06 -
IRQ14	- 07 -
-Dack0	- 08 -
DRQ0	- 09 -
-Dack5	- 10 -
DRQ5	- 11 -
-Dack6	- 12 -
DRQ6	- 13 -
-Dack7	- 14 -
DRQ7	- 15 -
+5VDC	- 16 -
-Master	- 17 -
Gnd	- 18 -

-I/OChck
SD7
SD6
SD5
SD4
SD3
SD2
SD1
SD0
-I/OChrdy
AEN
SA19
SA18
SA17
SA16
SA15
SA14
SA13
SA12
SA11
SA10
SA9
SA8
SA7
SA6
SA5
SA4
SA3
SA2
SA1
SA0

SBHE
LA23
LA22
LA21
LA20
LA19
LA18
LA17
-Memr
-Memw
SD08
SD09
SD10
SD11
SD12
SD13
SD14
SD15



G586OPA

❖ *Appendix F: Connector Pin Assignments*

Connector JP3
Parallel Printer Port

Pin	Function
1	-Strobe
2	Data 0
3	Data 1
4	Data 2
5	Data 3
6	Data 4
7	Data 5
8	Data 6
9	Data 7
10	-Ack
11	Busy
12	Paper Empty
13	Select
14	-Autofd
15	-Error
16	-Init
17	-Sctin
18	Ground
19	Ground
20	Ground
21	Ground
22	Ground
23	Ground
24	PNF
25	Ground



PC/ISA System Board

Connectors JP4 and JP6

Primary and Secondary IDE Hard Disk Drive Connectors

Pin	Function
1	-Reset
2	Ground
3	D7
4	D8
5	D6
6	D9
7	D5
8	D10
9	D4
10	D11
11	D3
12	D12
13	D2
14	D13
15	D1
16	D14
17	D0
18	D15
19	Ground
20	Reserved
21	Reserved
22	Ground
23	-LOW
24	Ground
25	-IOR

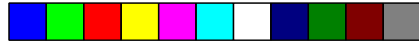

G586OPA

Pin	Function
26	Ground
27	Reserved
28	BALE
29	Reserved
30	Ground
31	IRQ14
32	IOCS16
33	SA1
34	Reserved
35	SA0
36	SA2
37	HCS0
38	HCS1
39	LED
40	Ground

Connector JP5
Floppy Disk Drive Connector

Pin	Function
1	Ground
2	DENSEL
3	Ground
4	Reserved
5	Ground
6	Drate0
7	Ground
8	Index

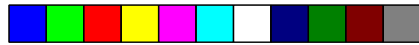

PC/ISA System Board

Pin	Function
9	Ground
10	MTR0
11	Ground
12	DR1
13	Ground
14	DR0
15	Ground
16	MTR1
17	Drate1
18	Dir
19	Ground
20	Step
21	Ground
22	Write Data
23	Ground
24	Write Gate
25	Ground
26	Track 0
27	MSEN
28	Wr Protect
29	Ground
30	Read Data
31	Ground
32	Head Select
33	Ground
34	Disk Change



G5860PA

Connectors JP7 and JP8
Primary (COM-A) and Secondary (COM-B) Serial Ports

Pin	Function
1	DCD (Data Carrier Detect)
2	RX (Receive Data)
3	TX (Transmit Data)
4	DTR (Data Terminal Ready)
5	Ground (Signal Ground)
6	DSR (Data Set Ready)
7	RTS (Request to Send)
8	CTS (Clear to Send)
9	RI (Ring Indicator)

Connector JP9
PS/2 Mouse Connector

Pin	Function
1	Mouse Data
2	Reserved
3	Ground
4	+5V
5	Mouse Clock
6	Reserved

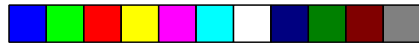

PC/ISA System Board

Connector JP14
PCI IDE LED

Pin	Function
1	LED (+)
2	LED (-)

Connector JP15
Keylock Connector

Pin	Function
1	LED Signal
2	Reserved
3	Ground
4	Keylock Signal
5	Ground

Connector JP16
Speaker Connector

Pin	Function
1	Signal
2	Connector to Buzzer
3	Ground
4	+5V

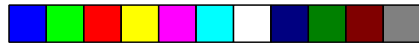

G5860PA

Connector JP17
Reset Switch Connector

Pin	Function
1	Reset
2	Ground

Connector JP18
Green LED Connector

Pin	Function
1	LED (-)
2	LED (+)

Connector J22
CPU Fan Connector

Pin	Function
1	+12V
2	Gnd
3	Gnd
4	+5V



❖ Appendix G: Award BIOS Hard Disk Table

Type	Size (MB)	Cylinders	Heads	Sectors	Write Precomp	Land Zone	Example Model
1	10	306	4	17	128	305	TEAC SD510, MMI 112, 5412
2	20	615	4	17	300	615	Seagate ST225, ST4026
3	30	615	6	17	300	615	
4	62	940	8	17	512	940	
5	46	940	6	17	512	940	
6	20	615	4	17	None	615	Seagate ST125, Tandon TM262
7	30	462	8	17	256	511	
8	30	733	5	17	None	733	Tandon TM 703
9	112	900	15	17	None	901	
10	20	820	3	17	None	820	
11	35	855	5	17	None	855	
12	49	855	7	17	None	855	
13	20	306	8	17	128	319	Disctron 526, MMI M125
14	42	733	7	17	None	733	
15				(Reserved)			
16	20	612	4	17	0	663	Microscience HH725, Syquest 3250, 3425
17	40	977	5	17	300	977	
18	56	977	7	17	None	977	
19	59	1024	7	17	512	1023	
20	30	733	5	17	300	732	
21	42	733	7	17	300	732	
22	30	306	5	17	300	733	Seagate ST4038
23	10	977	4	17	0	336	
24	40	1024	5	17	None	976	Seagate ST4051
25	76	1224	9	17	None	1023	Seagate ST4096
26	71	1224	7	17	None	1223	Maxtor 2085
27	111	1224	11	17	None	1223	Maxtor 2140, Priam S14
28	152	1024	15	17	None	1223	Maxtor 2190, Priam S19



G5860PA

Type	Size (MB)	Cylinders	Heads	Sectors	Write Precomp	Land Zone	Example Model
29	68	1024	8	17	None	1023	Maxtor 1085, Micropolis 1325
30	93	918	11	17	None	1023	Maxtor 1105 1120, 4780
31	83	925	11	17	None	1023	Maxtor 1170
32	69	1024	9	17	None	926	CDC 9415
33	85	1024	10	17	None	1023	
34	102	1024	12	17	None	1023	
35	110	1024	13	17	None	1023	
36	119	1024	14	17	None	1023	
37	17	1024	2	17	None	1023	
38	136	1024	16	17	None	1023	
39	114	918	15	17	None	1023	Maxtor 1140, 4380
40	40	820	6	17	None	820	Seagate ST251
41	42	1024	5	17	None	1023	Seagate 4053
42	65	1024	5	26	None	1023	Miniscribe 3053/6053 RLL
43	40	809	6	17	None	852	Miniscribe 3650
44	61	809	6	26	None	852	Miniscribe 3675 RLL
45	100	776	8	33	None	775	Conner CP3104
46	203	684	16	38	None	685	Conner CP3204
User Defined							



G5860PA

Rev.0
System Board
User's Manual





G5860PA

Rev. 0
System Board
User's Manual



- 26250223 -

