



G586PV

Rev. A+
System Board
User's Manual



-D31060524-





FCC Statement on Class B

This equipment has been tested and found to comply with the limits for a Class B digital device, pursuant to Part 15 of the FCC rules. These limits are designed to provide reasonable protection against harmful interference when the equipment is operated in a residential installation. This equipment generates, uses and can radiate radio frequency energy and, if not installed and used in accordance with the instruction manual, may cause harmful interference to radio communications. However, there is no guarantee that interference will not occur in a particular installation. If this equipment does cause harmful interference to radio or television reception, which can be determined by turning the equipment off and on, the user is encouraged to try to correct the interference by one or more of the following measures:

- Reorient or relocate the receiving antenna.
- Increase the separation between the equipment and the receiver.
- Connect the equipment into an outlet on a circuit different from that to which the receiver is connected.
- Consult the dealer or an experienced radio TV technician for help.

Notice:

1. The changes or modifications not expressly approved by the party responsible for compliance could void the user's authority to operate the equipment.
2. Shielded interface cables must be used in order to comply with the emission limits.

The manufacturer makes no warranties with respect to this documentation and disclaims any implied warranties of merchantability, quality, or fitness for any particular purpose. The information in this document is subject to change without notice. The manufacturer reserves the right to make revisions to this publication and to make changes to any and/or all parts of its content, at any time, without obligation to notify any person or entity of such changes. Further, the manufacturer assumes no responsibility for any errors that may appear in this document.



Table of Contents

Chapter 1: Introduction	5
Features and Specifications	6
Package Checklist	8
Chapter 2: Hardware Installation	9
Preparing the Area	9
Handling the System Board	9
Installing the System Board	10
Board Layout	12
System Memory	13
DIMM	13
SIMM	14
Jumper settings for DIMM and SIMM	15
Cache Memory	16
Installing the Cache Module	16
CPU Installation	18
Jumper Settings for CPUs	18
Installing Upgrade CPUs	22
Installing A Fan/Heatsink for Cyrix CPUs	24
Jumper Settings for Display Type	26
Built-in Ports	26
Serial Ports	27
PS/2 Mouse Port (optional)	27
Parallel Port	27
Floppy Disk Drive Controller	29
IDE Hard Disk Interface	29
Installing Expansion Cards	30
Chapter 3: Software Installation	32
Award BIOS CMOS Setup Utility	32
Standard CMOS Setup	33
BIOS Features Setup	35
Chipset Features Setup	36
Power Management Setup	37
PNP/PCI Configuration Setup	38
Load BIOS Defaults	38
Load Setup Defaults	39
Integrated Peripherals	39

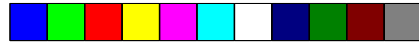

Supervisor Password	40
User Password	41
IDE HDD Auto Detection	41
HDD Low Level Detection	44
Save & Exit Setup	44
Exit Without Saving	45
System Error Report	45
IDE Device Drivers	48

Chapter 4: Troubleshooting Checklist 49

Appendix A: Types of Modules	50
Appendix B: Memory and I/O Maps	51
Appendix C: PCI I/O Pin Assignments	53
Appendix D: ISA I/O Pin Assignments	54
Appendix E: Connector Pin Assignments	55
Appendix F: Row Address of the DRAM and SDRAM	62



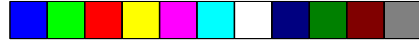

Chapter 1 Introduction

The G586IPV, equipped with a 321-pin Zero Insertion Force (ZIF) CPU socket, is a fast Pentium process class or system board supporting Intel Pentium CPUs running at 75MHz, 90MHz, 100MHz, 120MHz, 133MHz, 150MHz and 166MHz frequencies. The G586IPV also supports Cyrix P120+/P133+/P150+ /P166+, AMD 5_x86, and future 200MHz CPUs.

The G586IPV can support 8MB to 128MB of system memory. It is equipped wuith a DIMM socket using x64 EDO, fast page mode or SDRAM, and 4 SIMM sockets using EDO or fast page mode x32 DRAM. This system board also supports pipeline burst SRAM, and provides easy cache upgrades using 256KB cache module.

The G586IPV board has two bus master PCI IDE connectors. Bus mastering reduces CPU use during disk transfer. This system board is also equipped with two NS16C550A-compatible serial ports, an SPP/ECP/EPP parallel port, a floppy disk drive controller, one PS/2 mouse port and one PS/2 or AT keyboard connector.



Features and Specifications

Processor

- Intel Pentium™ 75/90/100/120/133/150/166MHz
- Future Pentium™ OverDrive processor
- Cyrix 6x86 P120+/P133+/P150+/P166+
- AMD 5x86 75/90MHz
- Future 200MHz CPUs

Chipset

- Intel 82430VX PCIsset

Cache Memory

- Supports 256KB or 512KB pipeline burst, direct map write-back cache
- One 160-pin cache module slot
- Onboard 256KB: upgradeable with a 256KB cache module for a maximum of 512KB cache

System Memory

- 8MB to 128MB onboard memory
- One 168-pin DIMM socket using x64 EDO, fast page mode, or SDRAM, 60ns or 70ns, 3.3V
- Four 72-pin SIMM sockets using EDO or fast page mode x32 DRAM, 60ns or 70ns, 5V

BIOS

- Award BIOS, Windows 95 Plug and Play compatible
- Flash EPROM for easy BIOS upgrades

Energy Efficient Design

- System power management supported
- CPU stopped clock control
- Hardware supports SMI green mode
- Microsoft/Intel APM 1.1 compliant
- External power management switch supported



PCI IDE Interface

- PIO Mode 3 and Mode 4 Enhanced IDE (data transfer rate up to 16.6MB/sec.)
- DMA Mode 2 Bus Master IDE (data transfer rate up to 22.2MB/sec.)
- Bus mastering reduces CPU utilization during disk transfer
- ATAPI IDE CD-ROM supported

Integrated I/O

- Winbond I/O controller
- Two NS16C550A-compatible high speed UARTs
- One SPP/ECP/EPP parallel port
- Supports 360KB, 720KB, 1.2MB, 1.44MB, and 2.88MB floppy drives
- IrDA TX/RX header
- Two universal serial bus connectors in future revision

CPU Socket

- 321-pin ZIF socket (Intel Socket 7)
- Supports future low-voltage CPUs

Connectors

- 2 serial ports
- 1 parallel port
- 2 IDE connectors
- 1 floppy connector
- 1 PS/2 mouse port (optional)
- 1 PS/2 or AT keyboard connector

Expansion Slots

- 4 dedicated PCI slots
- 3 dedicated 16-bit ISA slots

PCB

- 4 layers, Baby AT form factor
- 25cm (9.84") x 22cm (8.66")



Package Checklist

The G586IPV package contains the following items:

- The G586IPV system board
- The G586IPV user's manual
- One 40-pin IDE hard disk cable
- One 34-pin floppy disk drive cable
- One 25-pin printer port cable for chassis mounting
- One card-edge bracket for mounting the printer port cable
- One card-edge bracket with serial port cables
- One card-edge bracket with mouse port cable (optional)
- One IDE driver diskette
- Cache module (optional)

If any of these items are missing or damaged, please contact your dealer or sales representative for assistance.





Chapter 2 Hardware Installation

This chapter summarizes the steps to install the G586IPV system board into your system unit. It also includes a description of the area in which you must work and directions for memory installation. Before installing the system board, obtain the memory you plan to install. Refer to pages 13-15 for the number and type of memory modules needed for the amount of memory you require.

Preparing the Area

Before unpacking the system board, make sure the location you have selected is relatively free of dust and static electricity. Excessive exposure to dust, static electricity, direct sunlight, excessive humidity, extreme cold, and water can damage the operational capabilities of your system board. Avoid placing the unit on surfaces such as carpeted floors. These areas also attract static electricity which can damage some circuits on your system board.

Make sure the power source has a properly grounded, three-pronged socket. It is essential that the power connection be properly grounded for correct functioning of your system board. For further protection, we recommend that you use a surge suppressor. This will protect the system board from damage that may result from a power surge on the electrical line.

Move items that generate magnetic fields away from your system board since magnetic fields can also damage your system board. Once you have selected the ideal location, unpack the G586IPV system board carefully.

Handling the System Board

It is quite easy to inadvertently damage your system board even before installing it in your system unit. Static electrical discharge can damage computer components without causing any signs of physical damage. You must take extra care in handling the system board to ensure against electrostatic build-up.



Static Electricity Precautions

1. To prevent electrostatic build-up, leave the board in its anti-static bag until you are ready to install it.
2. Wear an antistatic wrist strap.
3. Do all preparation work on a static-free surface with the system board components facing up.
4. Hold the system board only by its edges. Be careful not to touch any of the components, contacts or connections, especially gold contacts, on the board.
5. Avoid touching the pins or contacts on all modules and connectors. Hold modules and connectors by their ends.

Warning:

Electrostatic discharge (ESD) can damage your processor, disk drives, add-in boards, and other components. Perform the upgrade instruction procedures described at an ESD workstation only. If such a station is not available, you can provide some ESD protection by wearing an anti-static wrist strap and attaching it to a metal part of the system chassis. If a wrist strap is unavailable, establish and maintain contact with the system chassis throughout any procedures requiring ESD protection.

Installing the System Board

If you are installing the G586IPV system board, the following outlines the basic installation steps. Before installing the system board into your system unit, you should prepare the tools you will need.

You will need:

- One medium size, flat-bladed screwdriver
- One medium Phillips screwdriver
- One needle-nosed pliers
- One small nutdriver



1. Unlock your system unit. Turn off the power and disconnect all power cords and cables.
2. Remove the system unit cover. Refer to the manufacturer's instructions if necessary.
3. Detach all connectors from the old system board and remove expansion cards seated in any expansion slots.
4. Loosen the screws holding the original system board and remove the board from the system. Save the screws.
5. Remove the G586IPV from its original packing box. Be careful to avoid touching all connectors and pins on the board. Please refer to the handling instructions on pages 9-10 for proper handling techniques.
6. Insert the memory modules into the memory banks on the G586IPV. The quantity and location of the memory modules depends on the memory configuration and type of modules you intend to use.
7. Insert the cache module, if any, into the cache module slot on the G586IPV. Refer to the Cache Memory section on page 16 for upgrading your cache memory.
8. Install the CPU. Be sure pin 1 of the CPU is aligned with pin 1 of the socket.
9. Set the corresponding jumpers.
10. Install the prepared G586IPV system board into the case and replace the screws.
11. Reinstall all cards and connectors and replace the system unit cover. Reconnect all power cords and cables.

Board Layout

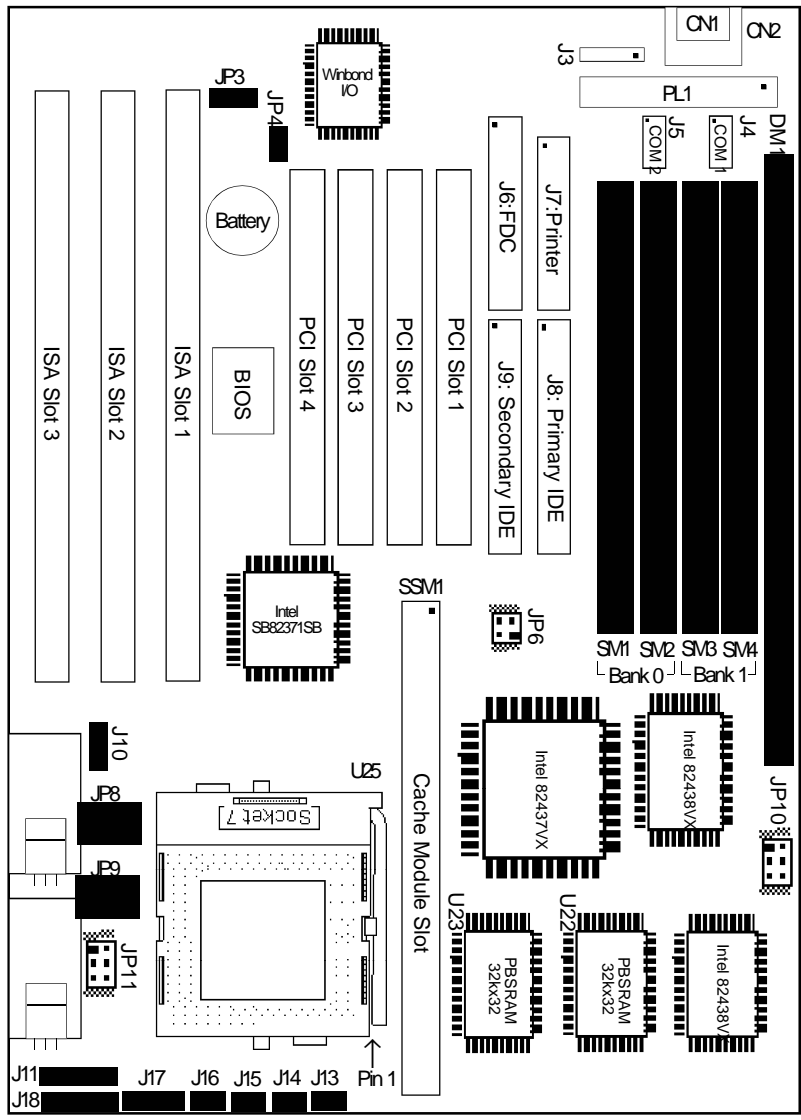

- 1. "■" refers to Pin 1 of the jumpers and connectors
- 2. PBSRAM = Pipeline Burst SRAM

System Memory

The G586IPV system board supports two kinds of memory modules: DIMM and SIMM. DIMM which uses SDRAM, performs better than SIMMs, which use DRAM.

DIMM

The DIMM (Dual In-line Memory Module) socket uses x64 EDO, FPM and SDRAM. The G586IPV system board can support 8MB to 16MB memory using 1MBx64 or 2MBx64 168-pin DIMM. Refer to page 12 for the location of the DIMM.

Installing the DIM Module

A DIM module simply snaps into the DIMM socket on the system board. Pin 1 of the DIM module must correspond with Pin 1 of the socket.

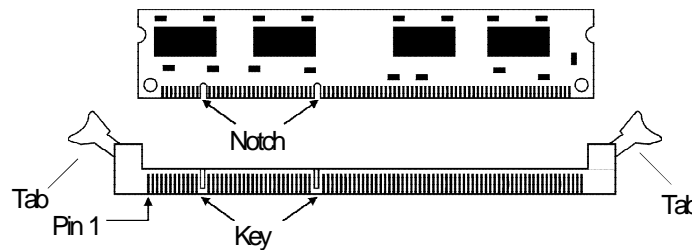

1. Pull the "tabs" which are at the ends of the socket to the side.
2. Position the DIMM above the socket with the "notches" in the module aligned with the "keys" on the socket.
3. Seat the module vertically into the socket. Make sure it is completely seated. The tabs will hold the DIMM in place.

SIMM

The SIMM (Single In-line Memory Module) sockets are divided into two banks on the system board, Bank 0 and Bank 1. Each bank consists of 2 SIMM sockets.

You will need either 2 or 4 pieces of SIM modules, depending on the amount of memory you intend to install. The system board will not work if you install 1 or 3 pieces. Make sure you insert the same type of SIMMs in one bank. You can install SIMMs in either of the banks, Bank 0 or Bank 1, but you must populate a bank first before going to the next bank.

The G586IPV system board can support 8MB to 128MB of memory using 1MBx32, 2MBx32, 4MBx32, or 8MBx32 72-pin SIMMs. The table below shows the supported SIM modules and their corresponding memory sizes.

SIMMs	Memory Size
1MBx32	4MB
2MBx32	8MB
4MBx32	16MB
8MBx32	32MB

Examples:

If you are installing 8MB of memory, you must insert two 1MBx32 SIMMs in Bank 0 or Bank 1. Inserting one 2MBx32 module will not work.

If you are installing 24MB of memory, you must insert two 1MBx32 SIMMs in Bank 0 and two 2MBx32 SIMMs in Bank 1. You may also install it vice versa by inserting two 1MBx32 SIMMs in Bank 1 and two 2MBx32 SIMMs in Bank 0.

Installing a SIM Module

A SIM module simply snaps into a socket on the system board. Pin 1 of the SIM module must correspond with Pin 1 of the socket.

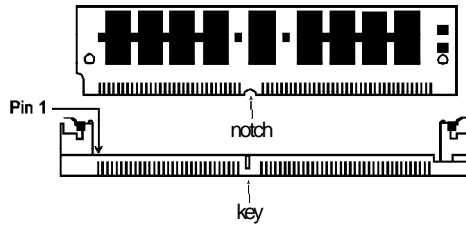

1. Position the SIMM above the socket with the “notch” in the module aligned with the “key” on the socket.
2. Seat the module at a 45° angle into the bank. Make sure it is completely seated. Tilt the module upright until it locks in place in the socket.

Warning:

The DIMM and SIMM can not exist on the G586IPV system board at the same time. You must use either a DIMM or SIMMs on your system board.

Jumper Settings for DIMM & SIMM

Jumper JP10

DIMM and SIMM Select

Jumper JP10 must match the type of module installed on the G586IPV system board. If you change your memory module, make sure this jumper is changed accordingly.

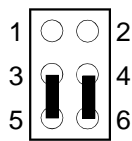

JP10: 3-5, 4-6 On
DIMM

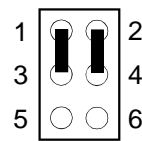

JP10: 1-3, 2-4 On
SIMM
(Default)



Cache Memory

The G586IPV system board can support 256KB or 512KB pipeline burst, direct map write-back cache SRAM. Your system board may come with 256KB or 256KB cache mounted onboard. The 160-pin cache module slot lets you upgrade your cache memory by installing a 256KB cache module.

Note:

You do not need to set any jumpers or modify the Award BIOS Setup utility when you install the cache module.

If your system board comes with 256KB cache at locations U22 and U23, you can upgrade your cache memory to 512KB by installing a 256KB cache module in the cache module slot. Refer to page 12 for the locations of the cache module slot (SSM1), U22 and U23.

Warning:

We highly recommend that you use the T2BSM32-256 cache module. If you are using a cache module other than the one recommended above, make sure your cache module meets the Intel COAST 2.x specification. Severe damage might occur on the cache module or system board if you insert modules other than the one specified above.

Installing the Cache Module

Locate the 160-pin cache module slot on the system board (SSM1). See pages 12 for the location. Position the cache module above the slot. Make sure pin 1 of the cache module is aligned with pin 1 of the slot. Carefully slide the module into the slot. Press firmly on the top of it to seat it properly.

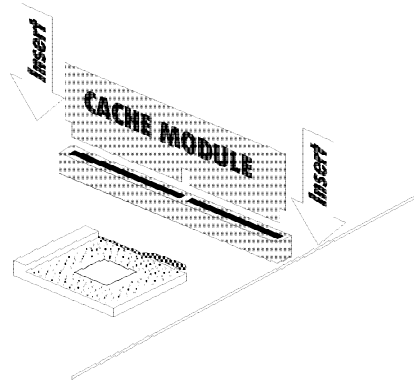

Note:

With the cache module installed in the cache module slot, the components on the solder side of the add-in card in PCI Slot 1 and 2 must not protrude more than 5mm. There is no limit to the length of the add-in card installed in PCI Slot 3.



CPU Installation

The G586IPV allows for easy installation of CPUs. Make sure all jumpers are set correctly before applying power or you may damage the CPU or system board. Please see the jumper settings on the following pages. Use the needle-nosed pliers to move the jumpers if necessary.

Jumper Settings for CPUs

Intel CPUs

Intel CPUs	CPU CLK	JP4
75MHz	50MHz	Off
90/100/120/150/166MHz	60/66MHz	On



Intel CPUs	CPU CLK	JP6	
		Pin 1-2	Pin 3-4
75MHz	50MHz	On	On
90/120/150MHz	60MHz	Off	On
100/133/166MHz	66MHz	On	Off

Intel CPUs	PCI CLK	JP8	
		Pin 1-2	Pin 3-4
75/90/100MHz	1.5x	Off	Off
120/133MHz	2x	On	Off
150/166MHz	2.5x	On	On

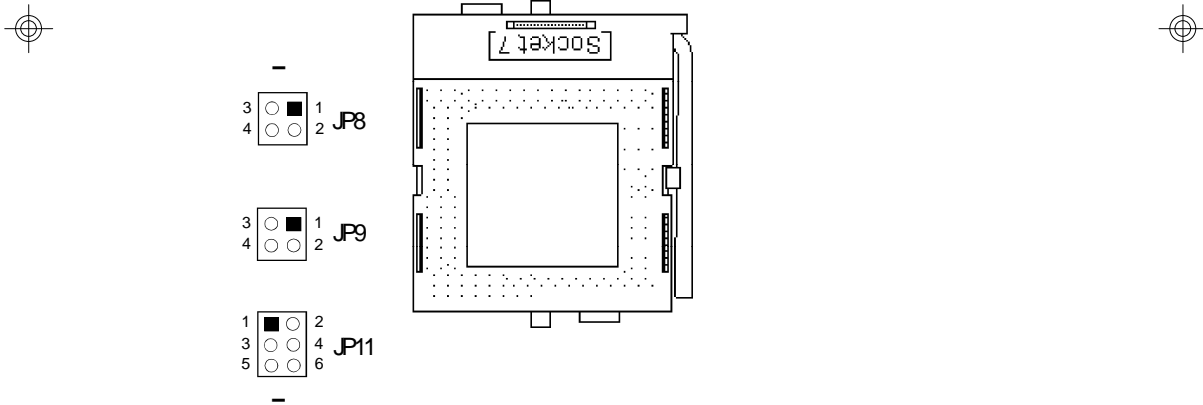
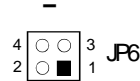

Voltage	JP9	JP11
28V	1-2 On	1-3 On, 2-4 On
3.3V*	1-2 On	3-5 On, 4-6 On
3.52V	3-4 On	3-5 On, 4-6 On

*Default



Cyrix CPUs

Cyrix CPUs	CPU CLK	JP4
P120+/P133+	50/55MHz	Off
P150+/P166+	60/66MHz	On



Cyrix CPUs	CPU CLK	JP6	
		Pin 1-2	Pin 3-4
P120+	50MHz	On	On
P133+	55MHz	Off	Off
P150+	60MHz	On	Off
P166+	66MHz	Off	On

Cyrix CPUs	PCI CLK	JP8	
		Pin 1-2	Pin 3-4
P120+/P133+/ P150+/P166+	2x	On	Off

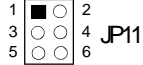
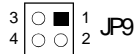
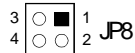
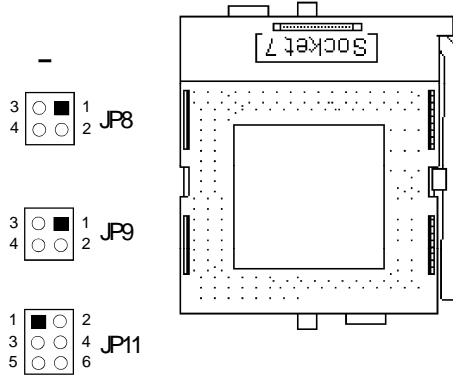
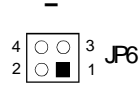

Voltage	JP9	JP11
2.8V	1-2 On	1-3 On, 2-4 On
3.3V*	1-2 On	3-5 On, 4-6 On
3.52V	3-4 On	3-5 On, 4-6 On

* Default



AMD 5_x86 CPUs

AMD 5 _x 86 CPUs	CPU CLK	JP4
75MHz	50MHz	Off
90MHz	60MHz	On



AMD 5 _x 86 CPUs	CPU CLK	JP6	
		Pin 1-2	Pin 3-4
75MHz	50MHz	On	On
90MHz	60MHz	On	Off

AMD 5 _x 86 CPUs	PCI CLK	JP8	
		Pin 1-2	Pin 3-4
75/90MHz	1.5x	Off	Off

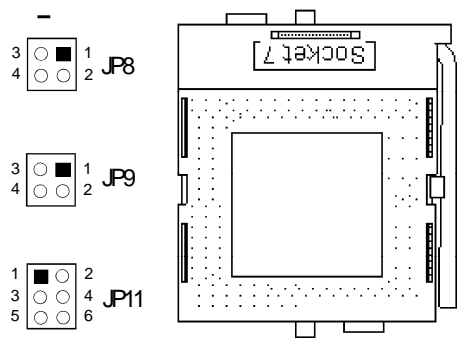
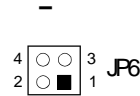

Voltage	JP9	JP11
28V	1-2 On	1-3 On, 2-4 On
3.3V*	1-2 On	3-5 On, 4-6 On
3.52V	3-4 On	3-5 On, 4-6 On

* Default

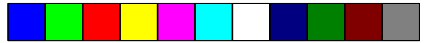

Future 200MHz CPUs

Future CPUs	CPU CLK	JP4
200MHz	66MHz	On



Future CPUs	CPU CLK	JP6	
		Pin 1-2	Pin 3-4
200MHz	66MHz	Off	On

Future CPUs	PCI CLK	JP8	
		Pin 1-2	Pin 3-4
200MHz	3x	Off	On

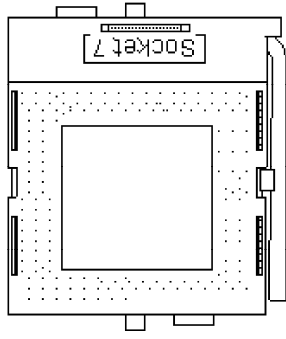
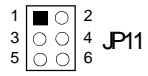
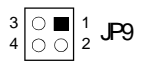
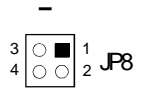
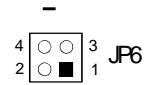

Voltage	JP9	JP11
28V	1-2 On	1-3 On, 2-4 On
3.3V*	1-2 On	3-5 On, 4-6 On
3.52V	3-4 On	3-5 On, 4-6 On

* Default

Installing Upgrade CPUs

The G586IPV is equipped with a 321-pin Zero Insertion Force (ZIF) socket at location U25 of the system board. Refer to page 12 for the location of the ZIF socket. This socket is designed for easy removal of an old CPU and easy insertion of an upgrade CPU. The socket allows you to carefully place the new CPU into its position. If you need to apply excessive force to insert the CPU, you are not installing the CPU correctly.

Warning:

Open the socket only if you are actually installing a CPU. The warranty on the original CPU will be voided if the S/N seal is broken.

Before proceeding with the upgrade, take note of the following. The microprocessor and heatsink may be hot if the system has been running. To avoid the possibility of a burn, power the system off and let the processor and heatsink cool for 10 minutes.

The 321-pin ZIF socket consists of five rows of pin holes on each side. To prevent improper CPU installation, the ZIF socket has a Plug/Keying mechanism. Several holes in the socket are plugged so that the CPU will go in only one way. If you cannot easily insert the CPU, verify that pin 1 of the CPU is aligned with pin 1 of the socket.

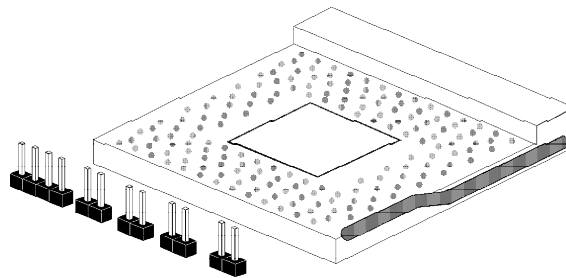

Zero Insertion Force (ZIF) Socket



To install an upgrade CPU, do the following.

1. Make sure the handle on the side of the ZIF socket is up. To raise the handle, push it down, slightly pull it out to the side, then raise it as far as it will go. It may be necessary to initially apply a small amount of sideways force to free the handle from its retaining “tab.” Once clear of the “tab,” the handle will open relatively easily. The top plate will slide back. Do not use screwdrivers or other tools to open the socket, or you may damage the system or socket.

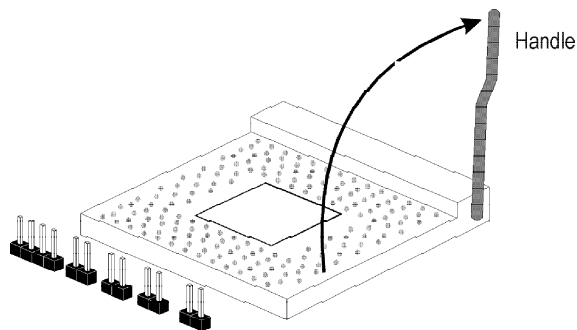

Lifting the Handle

2. Once the lever is completely up, remove the old CPU carefully by lifting it straight out of the socket. You are now ready to insert the new CPU.

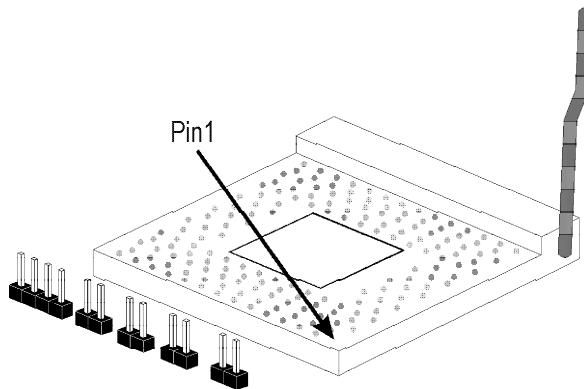



3. Position the CPU above the ZIF socket. Make sure pin 1 of the CPU is aligned with pin 1 of the socket. Lower the chip until the pins are inserted properly in their corresponding holes. Remember that very little force is needed to install the CPU. If the CPU is not easily inserted, verify whether or not pin 1 of the CPU is aligned with pin 1 of the socket. Applying too much pressure can damage the CPU or the socket.

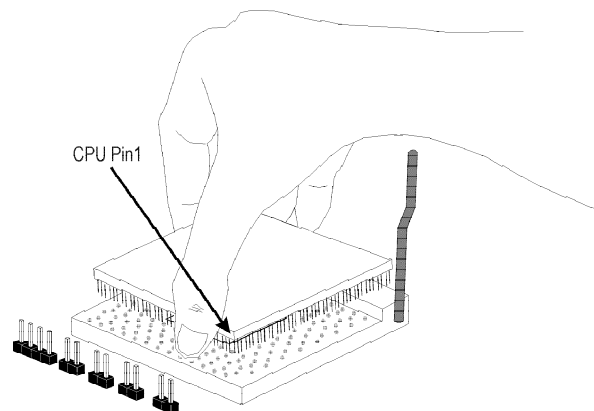

Positioning the CPU Above the ZIF Socket

4. Push the handle down until the handle locks into place. The top plate will slide forward. You will feel some resistance as the pressure starts to secure the CPU in the socket. This is normal and will not damage the CPU. However, if the handle is not completely closed, damage to the CPU and/or system board may result.

Installing A Fan/Heatsink for Cyrix CPUs

If you use a Cyrix CPU, you must choose a fan/heatsink which is made for Cyrix processors. Position the fan/heatsink on the CPU such that the air from the side of the fan/heatsink will flow across the heat regulators on the system board. See the figure on the next page.

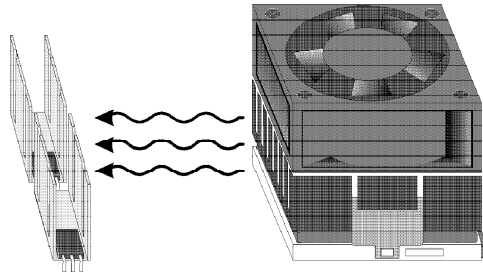

Clearance Requirements

Your CPU comes with a fan/heatsink mounted on top. To maintain proper airflow once the CPU is installed on the system board, the CPU and heatsink require certain space clearances.

The clearance above the CPU's fan/heatsink must be at least 0.4 inches. The clearance on at least 3 of 4 sides of the processor and fan/heatsink must be at least 0.2 inches. All cables (for floppy drive, hard drive, CD-ROM, etc.) must be routed clear of the CPU and its airspace.

Fan Exhaust

The CPU must be kept cool by using a fan with heatsink. The temperature of the air entering the fan/heatsink cannot exceed 45°C (113°F). The ambient or room temperature must be below 37°C (99°F).

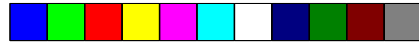

Jumper Setting for Display

Jumper JP3

Display Type Select

Jumper JP3 sets the display adapter to color or mono. This jumper must match the type of display adapter installed. If you change your video adapter, make sure this jumper is changed accordingly.

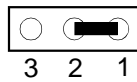

1-2 On: Color
(default)

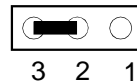

2-3 On: Mono

Built-in Ports

The G586IPV system board is equipped with two serial ports, one parallel printer port, one FDD connector, two IDE hard disk shrouded headers and one PS/2 mouse connector. Refer to page 12 for the locations of the built-in connectors and pin 1 of those connectors.

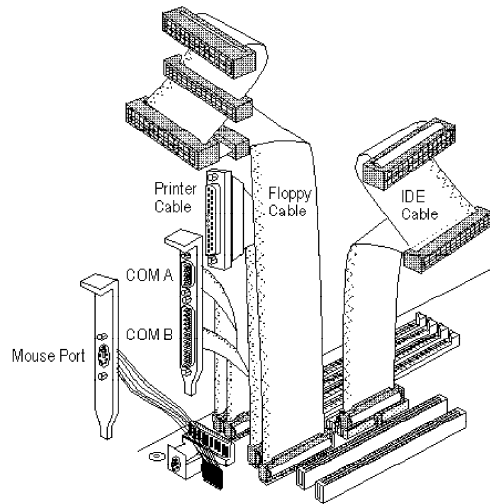

Serial Ports

The built-in serial ports are RS-232C asynchronous communication ports with 16C550A-compatible UARTs that can be used with modems, serial printers, remote display terminals, and other serial devices. They use the following system I/O addresses:

Port Configuration	COM1	COM2	COM3	COM4
Serial Port 1	3F8h*	2F8h	3E8h	2E8h
Serial Port 2	3F8h	2F8h*	3E8h	2E8h

* Default

Connecting the Serial Ports

One DB-9P and one DB-25P serial port cables are provided with the system board. They are mounted on card-edge brackets. The DB-9P serial port cable should be used for the COM 1 primary serial port; connect it to connector J4 on the system board. The DB-25P serial port cable should be used for the COM 2 secondary serial port; connect it to connector J5 on the system board. Make sure the colored stripes on the ribbon cables are aligned with pin 1 of connectors J4 and J5. Mount the card-edge bracket to the system chassis.

PS/2 Mouse Port (optional)

The PS/2 mouse port is a 6-pin connector mounted on a card-edge bracket. Attach the 6-pin mouse port cable, which came with the G586IPV, to connector J3. Make sure the brown wire on the PS/2 mouse connector is aligned with pin 1 of connector J3. Mount the card-edge bracket to the system board.

Parallel Port

The G586IPV system board has a standard connector for interfacing your PC to a parallel printer. The parallel port on your system board can be set to any of the following system I/O addresses:



I/O Address: 3BC-3BE Hex
378-37A Hex (default)
278-27A Hex

Connecting the Parallel Printer Port

Attach the DB-25S printer port cable, which came with the system board, to connector J7 on the G586IPV system board. Make sure the colored stripe on the ribbon cable aligns with pin 1 of connector J7. Use a small nutdriver to mount the cable into a DB-25 cutout in the system chassis. If the printer port cable is attached to a card-edge bracket, mount the card-edge bracket to the system chassis

Floppy Disk Drive Controller

The G586IPV system board has a built-in floppy disk controller that supports two standard floppy disk drives. You can install any 360KB, 720KB, 1.2MB, 1.44MB, or 2.88MB floppy disk drives.

Connecting the Floppy Disk Cable

1. Install the 34-pin header connector into the floppy disk connector (J6) on the system board. The colored edge of the ribbon should be aligned with pin 1 of connector J6.
2. Install the other 34-pin header connector(s) into the disk drive(s). Align the colored edge of the daisy chained ribbon cable with pin 1 of the drive edge connector(s). The end-most connector should be attached to the drive you want to designate as Drive A.

IDE Hard Disk Interface

The G586IPV system board is equipped with two PCI IDE shrouded headers that will interface four Enhanced IDE (Integrated Drive Electronics) hard disk drives.

Note:

Only Enhanced IDE hard drives or ATAPI CD-ROMs can be connected to the IDE interface.



Connecting the IDE Hard Disk Interface

To prevent improper IDE cable installation, each PCI IDE shrouded header has a keying mechanism. The 40-pin connector on the IDE cable can be placed into the header only if pin 1 of the connector is aligned with pin 1 of the header.

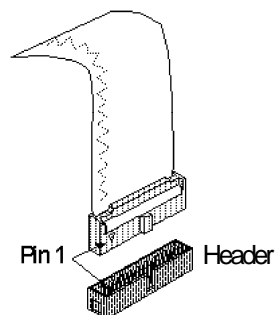

Note:

An IDE cable with a standard 40-pin connector (without the keying mechanism) can be installed in the PCI IDE shrouded header. Be extremely careful to match the colored edge of the ribbon with pin 1 of the header.

Connecting the Hard Disk Cable

1. If you are connecting two hard drives, install the 40-pin connector of the IDE cable into the primary IDE shrouded header (connector J8). If you are adding a third or fourth IDE device, install the 40-pin connector of the other IDE cable into the secondary IDE shrouded header (connector J9).
2. Install the other 40-pin header connector(s) into the device with the colored edge of the ribbon cable aligned with pin 1 of the drive edge connector(s).

Note:

Refer to your disk drive user's manual for information about selecting proper drive switch settings.



Adding a Second IDE Hard Drive

When using two IDE drives, one must be set as the master and the other as the slave. Follow the instructions provided by the drive manufacturer for setting the jumpers and/or switches on the drives.

We recommend that the Enhanced IDE hard drives be from the same manufacturer. In a few cases, drives from two different manufacturers will not function properly when used together. The problem lies in the hard drives, not the G586IPV system board.

Preparing an IDE Drive for Use

IDE disk drives are already low-level formatted, with any bad-track errors entered, when shipped by the drive manufacturer. Do not attempt to do a low-level format or you may cause serious damage to the drive. To use an IDE drive, you need to enter the drive type (this information is provided by the drive manufacturer) into the system's CMOS setup table. Then run FDISK and FORMAT provided with DOS.

Warning:

Do not run FDISK and FORMAT programs on a drive that has already been formatted or you will lose all programs and data stored on the drive.

Installing Expansion Cards

The G586IPV system board is equipped with 4 dedicated PCI slots and 3 dedicated 16-bit ISA slots. All PCI slots are bus masters.

Due to the size of the CPU with its accompanying heatsink/fan component, the length of the add-in cards in PCI slot 4 and ISA slot 1 is limited to 18cm (7.07", measured from the bracket of the card). There is no limit to the length of the add-in card installed in PCI Slot 3, but the components on the solder side of the add-in card in PCI Slot 3 must not protrude more than 5mm (0.2") to avoid interfering the cache module.

Refer to page 12 for the locations of the expansion slots.



Note:

The BIOS needs to be configured for the PCI add-in cards installed in the PCI slots. Refer to the "PCI Configuration Setup" presented in the "Software Installation" section of the manual.





Chapter 3 Software Installation

After you power up your system, the BIOS message appears on your screen and the memory count begins.

After the memory test, the following message will appear on the screen:

Press DEL to enter setup

If the message disappears before you respond, restart your system or press the “Reset” button on the front of your computer. You may also restart the system by pressing the <Ctrl> <Alt> and keys simultaneously. If you do not press these keys at the correct time and the system does not boot, the following error message will appear:

Press Del to enter Setup

If you have set a password and selected “System” in the Security Option of the BIOS Features Setup menu, you will be prompted for the password every time the system is rebooted or any time you try to enter Setup. Type in the correct password and press <Enter>.

If you selected “Setup” in the Security Option, you will be prompted for the password only when you try to enter Setup. Refer to the “BIOS Features Setup” section for more information.

Award CMOS Setup Utility

Press <Ctrl> <Alt> <Esc> simultaneously or to enter the Setup utility. A screen similar to the one on the next page will appear.

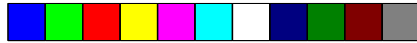

ROM PCI/ISA BIOS (2A59GD49)
CMOS SETUP UTILITY
AWARD SOFTWARE, INC.

STANDARD CMOS SETUP BIOS FEATURES SETUP CHIPSET FEATURES SETUP POWER MANAGEMENT SETUP PNP/PCI CONFIGURATION LOAD BIOS DEFAULTS LOAD SETUP DEFAULTS	INTEGRATED PERIPHERALS SUPERVISOR PASSWORD USER PASSWORD IDE HDD AUTO DETECTION HDD LOW LEVEL FORMAT SAVE & EXIT SETUP EXIT WITHOUT SAVING
ESC :Quit F10 :Sve & Exit Setup	↑↓←→ :Select Item (Shift) F2 :Change Color
Time, Date, Hard Disk Type...	

Use the arrow keys to highlight the option you want and press <Enter>. The following describes each of these options.

Standard CMOS Setup

Use the arrow keys to highlight "Standard CMOS Setup" and press <Enter>. A screen similar to the one below will appear.

ROM PCI/ISA BIOS (2A59GD49)
STANDARD CMOS SETUP
AWARD SOFTWARE, INC.

Date (mm:dd:yy) : Mon, Apr 15 1996									
Time (hh:mm:ss) : 9 : 5 : 55									
HARD DISKS	TYPE	SIZE	CYLS	HEAD	RECOMP	LANDZ	SECTOR	MODE	
Primary Master	:Auto	0	0	0	0	0	0	AUTO	
Primary Slave	:Auto	0	0	0	0	0	0	AUTO	
Secondary Master	:Auto	0	0	0	0	0	0	AUTO	
Secondary Maste	:Auto	0	0	0	0	0	0	AUTO	
Drive A :1.44M, 3.5in.									
Drive B :None									
Video :EGA/VGA									
Halt on :All Errors									
								Base Memory : 640K	
								Extended Memory : 31744K	
								Other Memory : 384K	
								Total Memory : 32768K	
ESC :Quit					↑↓←→ :Select Item	PU/PD/+/- : Modify			
F1 :Help					(Shift)F2 :Change				

Date and Time

This selection sets the time and date for the system.



Hard Drive Type

This allows you to enter the appropriate specifications for the type of hard disk drive(s) installed in your system. Under the “Type” category, you can select Auto, User, one of 46 predefined drive specifications or None.

Auto: This option indicates that the parameters for your hard disk drive(s) will be automatically detected and displayed when you boot your system. By default, the LBA mode is selected for a hard disk drive larger than 528 megabytes. If you decide not to accept the LBA mode, you can either specify your selection in the “IDE HDD Auto Detection” menu, or use the User option described below.

User: This type is user definable and allows you to enter the specifications yourself directly from the keyboard. Six categories of information are required: Size, Cylinders, Heads, Precomp, LandZone, Sectors and Mode. This information should be provided by your hard disk vendor or system manufacturer. However, we recommend you use the “IDE HDD Auto Detection” which provides a more efficient way to setup your hard drive.

46 Predefined Drive Specifications. Please refer to your hard disk documentation for the appropriate type number.

None: If a hard drive is not installed, select <None> and press <Enter>.

Drive A and Drive B

These options are used to select the type of floppy disk drives installed in your system. If neither drive is present, select “None”. Make sure you choose the correct drive type; otherwise, your system might format the device improperly.

Video

This is used to select the type of video adapter installed in your system.





Halt on

This category controls whether the system will halt in case an error is detected during power up.

No Errors: The system boot will not stop for any detected errors.

All Errors: The system will stop whenever the BIOS detects a non-fatal error.

All, But Keyboard: The system will stop for any error except a keyboard error.

All, But Diskette: The system will stop for any error except a disk error.

All, But Disk/Key: The system will stop for any error except a keyboard or disk error.

Memory

The lower right hand corner shows the base memory size, extended memory size, and the other memory size of your system. You cannot alter these items; your computer automatically detects and displays them.

The Other Memory size refers to the memory located in the 640K to 1024K address space. This is the memory used for different applications. DOS uses this area to load device drivers to free base memory for application programs.

When you are through making changes in the Standard CMOS Setup, press <Esc> to return to the main menu.

BIOS Features Setup

Use the arrow keys to highlight "BIOS Features Setup" and press <Enter>, a screen similar to the one on the next page will appear.





ROM PCI/ISA BIOS (2A59GD49)
 BIOS FEATURES SETUP
 AWARD SOFTWARE, INC.

Virus Warning	: Disabled	Video BIOS Shadow	: Enabled
CPU Internal Cache	: Enabled	C8000-CBFFF Shadow	: Disabled
External Cache	: Enabled	CC000-CFFFF Shadow	: Disabled
Quick Power On Self Test	: Enabled	D0000-D3FFF Shadow	: Disabled
Boot Sequence	: A, C	D4000-D7FFF Shadow	: Disabled
Swap Floppy Drive	: Disabled	D8000-DBFFF Shadow	: Disabled
Boot Up Floppy Seek	: Enabled	DC000-DFFFF Shadow	: Disabled
Boot Up NumLock Status	: On		
Gate A20 Option	: Fast		
Typematic Rate Setting	: Disabled	ESC :Quit	↑↓←→ :Select Item
Typematic Rate (Char/Sec)	: 6	F1 :Help	PU/PD/+/- :Modify
Typematic Delay (Msec)	: 250	F5 :Old Values (Shift) F2	:Color
Security Option	: Setup	F6	:Load BIOS Defaults
PCI/VGA Palette Snoop	: Disabled	F7	:Load Setup Defaults
OS Select For DRAM>64MB	: Non-OS2		

The Virus Warning option may be set to “Enabled” or “Disabled”. If enabled, the BIOS issues a warning when any program or virus sends a Disk Format command or attempts to write to the boot sector of the hard disk drive.

Note:

If you are installing or running certain operating systems such as Windows 95, please disable the Virus Warning or the operating system may not install nor work.

If you choose “System” in the Security Option, you will be prompted for a password every time you cold boot your system or access setup. If you choose “Setup”, you will be prompted for a password only when trying to access setup.

Use the arrow keys to move the highlight bar to the option you wish to change or modify. Use the <Page Up>, <Page Down>, <+> or <-> keys to make the corresponding changes. Press <Esc> after making the changes to return to the main menu.

Chipset Features Setup

The G586IPV uses the Intel 82430VX chipset. The Chipset Features Setup allows you to modify some functions to optimize system performance. If you press <Enter>, a screen similar to the one on the next page will appear.

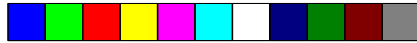

ROM PCI/ISA BIOS (2A59GD49)
CHIPSET FEATURES SETUP
AWARD SOFTWARE, INC.

Auto Configuration	: Enabled		
DRAM Timing	: 60 ns		
DRAM RAS# Precharge Time	: 3		
DRAM R/W Leadoff Timing	: 6		
Fast RAS To CAS Delay	: 3		
DRAM Read Burst (EDO/FP)	: x222/x333		
DRAM Write Burst Timing	: x222		
Fast MA to RAS# Delay CLK	: 1		
Fast EDO Path Select	: Disabled		
Refresh RAS# Assertion	: 4 Clks		
ISA Bus Clock	: PCICLK/4		
System BIOS Cacheable	: Enabled	ESC	:Quit
Video BIOS Cacheable	: Enabled		↑↓←→ :Select Item
8 Bit I/O Recovery Time	: 1	F1	:Help
16 Bit I/O Recovery Time	: 1		PU/PD/+/- :Modify
Memory Hole At 15M-16M	: Disabled	F5	:Old Values (Shift) F2 :Color
Peer Concurrency	: Enabled	F6	:Load BIOS Defaults
		F7	:Load Setup Defaults

Use the arrow keys to move the highlight bar to the option you wish to change or modify. Use the <Page Up>, <Page Down>, <+> or <-> keys to make the corresponding changes.

If the changes you made are incorrect or you change your mind, press <F6> or <F7> to return to the default settings. Press <Esc> after making the changes to return to the main menu.

Power Management Setup

Use the arrow keys to highlight "Power Management Setup" and press <Enter>. A screen similar to the one below will appear.

ROM PCI/ISA BIOS (2A59GD49)
POWER MANAGEMENT SETUP
AWARD SOFTWARE, INC.

Power Management	: Disabled	** Power Down & Resume Events **	
PM Control by APM	: Yes	IRQ3 (COM 2)	: On
Video Off Method	: V/H SYNC+Blank	IRQ4 (COM 1)	: On
		IRQ5 (LPT 2)	: On
Doze Mode	: Disabled	IRQ6 (Floppy Disk)	: On
Standby Mode	: Disabled	IRQ7 (LPT 1)	: On
Suspend Mode	: Disabled	IRQ8 (RTC Alarm)	: Off
HDD Power Down	: Disabled	IRQ9 (IRQ2 Redir)	: On
		IRQ10 (Reserved)	: On
** Wake Up Events In Doze & Standby **		IRQ11 (Reserved)	: On
IRQ3 (Wake-Up Event)	: On	IRQ12 (PS2 Mouse)	: On
IRQ4 (Wake-Up Event)	: On	IRQ13 (Coproessor)	: On
IRQ8 (Wake-Up Event)	: On	IRQ14 (Hard Disk)	: On
IRQ12 (Wake-up Event)	: On	IRQ15 (Reserved)	: Off
		ESC	:Quit
			↑↓←→ :Select Item
		F1	:Help
			PU/PD/+/- :Modify
		F5	:Old Values (Shift) F2 :Color
		F6	:Load BIOS Defaults
		F7	:Load Setup Defaults

Choosing "Enabled" in the Power Management option will allow you to set Doze Mode, Standby Mode, Suspend Mode and HDD Power Down. Choose "Disabled" if you do not want your system to enter the power saving mode.

PNP/PCI Configuration Setup

Use the arrow keys to highlight “PNP/PCI Configuration Setup” and press <Enter>; a screen similar to the one below will appear.

ROM PCI/ISA BIOS (2A59GD49)
PNP/PCI CONFIGURATION SETUP
AWARD SOFTWARE, INC.

Resources Control By : Auto	PCI IRQ Active By : Level
Reset Configuration Data : Disabled	PCI IDE IRQ Map To : PCI-AUTO
	Primary IDE INT# : A
	Secondary IDE INT# : B
ESC :Quit ↑↓←→ :Select Item	
F1 :Help PU/PD/+/- :Modify	
F5 :Old Values (Shift) F2 :Color	
F6 :Load BIOS Defaults	
F7 :Load Setup Defaults	

The PNP/PCI Configuration Setup allows you to assign INT A, B, C or D to the hard drives installed in your system. Each INT may then be assigned an IRQ value.

If the Resources Controlled By option is set to “Auto”, the system will automatically detect the settings for you. IRQ 3 - IRQ 15 and DMA 0 - DMA 7 options will not be shown in the PnP Configuration Setup screen.

Load BIOS Defaults

The “Load BIOS Defaults” option loads the troubleshooting default values permanently stored in the ROM chips. These settings are not optimal and turn off all high performance features. You should use these values only if you have hardware problems. Highlight this option on the main menu and press <Enter>. The message below will appear.

Load BIOS Defaults (Y/N)? N

If you want to proceed, press <Y> and the default settings will be loaded.

Load Setup Defaults

The “Load Setup Defaults” option loads optimized settings from the BIOS ROM. Use the Setup default values as standard values for your system

Highlight this option on the main menu and press <Enter>. The message below will appear.

Load Setup Defaults (Y/N)? N

Type <Y> and press <Enter> to load the Setup default values.

Integrated Peripherals

Use the arrow keys to highlight “Integrated Peripherals” and press <Enter>. A screen similar to the one below will appear.

ROM PCI/ISA BIOS (2A59GD49)
INTEGRATED PERIPHERALS
AWARD SOFTWARE, INC.

IDE HDD Block Mode	: Enabled	
IDE Primary Master PIO	: AUTO	
IDE Primary Slave PIO	: AUTO	
IDE Secondary Master PIO	: AUTO	
IDE Secondary Slave PIO	: AUTO	
On-Chip Primary PCI IDE	: Enabled	
On-Chip Secondary PCI IDE	: Enabled	
PCI Slot IDE 2nd Channel	: Disabled	
Onboard FDD Controller	: Enabled	
Onboard Serial Port 1	: 3F8/IRQ4	
Onboard Serial Port 2	: 2F8/IRQ3	
UART 2 Mode	: Standard	
Onboard Parallel Port	: 378H/IRQ7	
Onboard Parallel Mode	: SPP	
ESC	:Quit	↑↓←→ :Select Item
F1	:Help	PU/PD/+/- :Modify
F5	:Old Values (Shift) F2	:Color
F6	:Load BIOS Defaults	
F7	:Load Setup Defaults	

Integrated Peripherals allows you to enable, disable or select the port address of the built-in serial ports, parallel port and floppy disk controller.

IrDA

The G586IPV system boardsupports the IrDA function for wireless connectivity between your computer and peripheral devices. To use the IrDA function, follow the steps on the next page.

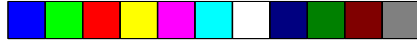

1. Connect the IrDA cable, which is attached to your computer chassis, to connector J9 of the G586IPC system board.
2. Set the onboard UART 2 Mode option in the I/O Configuration Setup of the Award BIOS utility to the type of IrDA standard supported by your computer.

You may not use IrDA (J9) and the COM 2 serial port (J3) at the same time. If you are using the COM 2 serial port, set the onboard UART 2 Mode option to "Standard". If you are using the IrDA, select "HPSIR" if your computer's IrDA is an HP standard. Select "ASKIR" if it is a Sharp standard.

Supervisor Password

If you want to protect your system and setup from unauthorized entry, set a supervisor's password with the "System" option selected in the BIOS Features Setup.

If you want to protect access to setup only, but not your system, set a supervisor's password with the "Setup" option selected in the BIOS Features Setup. You will not be prompted for a password when you cold boot the system.

Use the arrow keys to highlight the "Supervisor Password" option and press <Enter>. The message below will appear.

Enter Password:

Type in the password. You are limited to eight characters. When done, the message below will appear:

Confirm Password:

You are asked to verify the password. Type in exactly the same password. If you type in a wrong password, you will be prompted to enter the correct password again.

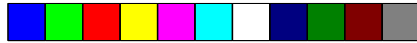

To delete or disable the password function, highlight “Supervisor Password” and press <Enter>, instead of typing in a new password. Press the <Esc> key to return to the main menu.

User Password

If you want another user to have access only to your system but not to setup, set a user’s password with the “System” option selected in the BIOS Features Setup.

If you want a user to enter a password when trying to access setup, set a user’s password with the “Setup” option selected in the BIOS Features Setup. Using user’s password to enter Setup allows a user to access only the “User Password” option that appears on the main screen. Access to all other options is denied.

To set, confirm, verify, disable or delete a user’s password, follow the procedures described in the section “Supervisor Password”. If you forget your password, refer to the procedure described in the same section.

IDE HDD Auto Detection

This option detects the hard disk parameters for the hard disk drives installed in your system. Highlight this option and press <Enter>. A screen similar to will appear below.

ROM PCI/ISA BIOS (2A59GD49)
CMOS SETUP UTILITY
AWARD SOFTWARE, INC.

HARD DISKS	TYPE	SIZE	CYLS	HEAD	RECOMP	LANDZ	SECTOR	MODE
Primary Master:								
Select Primary Master Option (N=Skip): N								
OPTIONS	SIZE	CYLS	HEAD	RECOMP	LANDZ	SECTOR	MODE	
2 (Y)	853	827	32	0	1653	63	LBA	
1	853	1654	16	65535	1653	63	Normal	
3	853	827	32	65536	1653	63	Large	
Note: Some OSs (like SCO-UNIX) must be “NORMAL” for installation								
ESC: Skip								



Enter your choice, and press <Enter> to accept the parameters or press <Esc> to abort. The parameters of the hard disk will be displayed in the Standard CMOS Setup.

Hard Drive Mode

The G586IPV supports three HDD modes: Normal, LBA and Large. If your hard disk drive does not support LBA mode, the “LBA” option will not be displayed. If your HDD has 1024 or fewer cylinders, the “Large” option will not be displayed.

Normal Mode

The Normal mode is the generic access mode in which neither the BIOS nor the IDE controller will make any transformations during hard-drive access.

The maximum number of cylinders, heads and sectors for Normal mode are 1024, 16 and 63, respectively.

	no. Cylinders	(1024)
	x no. Heads	(16)
	x no. Sectors	(63)
	x bytes per sector	(512)
528 megabytes		

If you set your HDD to Normal mode, the maximum accessible HDD will be 528 megabytes even though the physical size of the HDD may be greater than that.

LBA (Logical Block Addressing) Mode

The LBA mode is a HDD accessing method to overcome the 528 megabyte limitation. The number of cylinders, heads and sectors shown on the screen may not be the actual number for the HDD.

During the HDD accessing, the IDE controller will transform the logical address described by the sector, head and cylinder number into its own physical address inside the HDD.





The maximum HDD size supported by the LBA mode is 8.4 gigabytes.
It is obtained by the following formula.

	no. Cylinders	(1024)
x	no. Heads	(25)
x	no. Sectors	(63)
x	bytes per sector	(512)
	8.4 gigabytes	

Large Mode

Large mode is the extended HDD access mode supported by the G586IPV system board. Some IDE HDDs have more than 1024 cylinders without LBA support (in some cases, you may not want the LBA mode). This system board provides another alternative to support these kinds of HDDs.

The BIOS tells the operating system that the number of cylinders is half of the actual number and that the number of heads is double the actual number. During disk access, the reverse conversion is done by the INT13h routine.

Example of Large mode:

CYLS.	HEADS	SECTORS	MODE
1120	16	59	NORMAL
560	32	59	LARGE

Maximum HDD size:

	no. Cylinders	(1024)
x	no. Heads	(32)
x	no. Sectors	(63)
x	bytes per sector	(512)
	1 gigabyte	





Note:

To support LBA or Large mode, address translation software is included in the Award BIOS HDD Service Routine (INT13h). If you are running an operating system that bypasses the BIOS Int13 Service Routine, LBA and Large Mode may fail.

HDD Low Level Format

This option will format, set the interleave mode and do a media analysis of your hard drives. Highlight this option and press <Enter>. A screen similar to the one below will appear.

ROM PCI/ISA BIOS (2A59GD49)
CMOS SETUP UTILITY
AWARD SOFTWARE, INC.

Hard Disk Low Level Format Utility							No. CYLS HEAD
SELECT DRIVE BAD TRACK LIST PERFORMAT							
Current select drive is : C							
DRIVE: C CYLINDER: 0 HEAD: 0							
SIZE	CYLS	HEAD	RECOMP	LANDZ	SECTOR	MODE	
Primary Master:	853	1654	16	65536	1653	63	AUTO
Primary Slave:	0	0	0	0	0	0	AUTO
Secondary Master:	0	0	0	0	0	0	AUTO
Secondary Slave:	0	0	0	0	0	0	AUTO
Up/Down-Select item ENTER-Accept ESC-Exit/Abort							
Copyright (C) Award Software, Inc. 1992-94 All Rights Reserved							

Warning:

Do not attempt to do a low-level format on an IDE drive, or you may cause serious damage to the drive. IDE disk drives are already low-level formatted, with any bad-track errors entered, when shipped by the drive manufacturer.

Save & Exit Setup

When all the changes have been made, highlight "Save & Exit Setup" and press <Enter>. The message below will appear:

Save to CMOS and Exit (Y/N)? N

Type "Y" and press <Enter>. The following message will appear:

Reboot System (Y/N)? N



Type “Y” and press <Enter>. The modifications you have made will be written into the CMOS memory, and the system will reboot. You will once again see the initial diagnostics on the screen. If you wish to make additional changes to the setup, press <Ctrl> <Alt> <Esc> simultaneously or after memory testing is done.

Exit Without Saving

When you do not want to save the changes you have made, highlight “Exit Without Saving” and press <Enter>. The message below will appear:

Quit Without Saving (Y/N)? N

Type “Y” and press <Enter>. The system will reboot and you will once again see the initial diagnostics on the screen. If you wish to make any changes to the setup, press <Ctrl> <Alt> <Esc> simultaneously or after memory testing is done.

System Error Report



When the BIOS encounters an error that requires the user to correct something, either a beep code will sound or a message will be displayed in a box in the middle of the screen and the message PRESS F1 TO CONTINUE, CTRL-ALT-ESC or DEL TO ENTER SETUP, will be shown in the information box at the bottom. Enter Setup to correct the error.



POST Beep

There is one beep code in the BIOS. This code indicates that a video error has occurred and the BIOS cannot initialize the video screen to display any additional information. This beep code consists of a single long beep followed by two short beeps. If you get this error, contact your system board vendor.

Error Messages

One or more of the following messages may be displayed if the BIOS detects an error during the POST.





DISK BOOT FAILURE, INSERT SYSTEM DISK AND PRESS ENTER

No boot device was found. Insert a system disk into Drive A and press <Enter>. If the system normally boots from the hard drive, make sure the controller is inserted correctly and all cables are properly attached. Also be sure the disk is formatted as a boot device. Reboot the system.

DISKETTE DRIVES OR TYPES MISMATCH ERROR - RUN SETUP

The type of diskette drive installed in the system is different from the CMOS definition. Run setup to reconfigure the drive type correctly.

DISPLAY SWITCH IS SET INCORRECTLY

The display switch on the system board can be set to either monochrome or color. This error indicates the switch is set to a different setting than indicated in Setup. Determine which setting is correct and either turn off the system and change the jumper or enter Setup and change the Video selection.

DISPLAY TYPE HAS CHANGED SINCE LAST BOOT

Since last powering off the system, the display adapter has been changed. You must configure the system for the new display type.

ERROR ENCOUNTERED INITIALIZING HARD DRIVE

The hard drive cannot be initialized. Be sure the adapter is installed correctly and all cables are correctly and firmly attached. Also, be sure the correct hard drive type is selected in Setup.

ERROR INITIALIZING HARD DISK CONTROLLER

The system cannot initialize the controller. Make sure the card is correctly and firmly installed in the bus. Be sure the correct hard drive type is selected in Setup. Also, check to see if any jumper needs to be set correctly on the hard drive.

FLOPPY DISK CNTRLR ERROR OR NO CNTRLR PRESENT

The system cannot find or initialize the floppy drive controller. Make sure the controller is installed correctly and firmly. If no floppy drive is installed, be sure the Diskette Drive selection in Setup is set to NONE.



KEYBOARD ERROR OR NO KEYBOARD PRESENT

Cannot initialize the keyboard. Make sure the keyboard is attached correctly and no keys are being pressed during the boot.

If you are purposely configuring the system without a keyboard, set the error halt condition in Setup to HALT ON ALL, BUT KEYBOARD. This will cause the BIOS to ignore the missing keyboard and continue the boot.

MEMORY ADDRESS ERROR AT...

Indicates a memory address error at a specific location. You can use this location along with the memory map for your system to find and replace the bad memory chips.

MEMORY SIZE HAS CHANGED SINCE LAST BOOT

Memory has been added or removed since the last boot. Enter Setup and enter the new memory size in the memory fields.

MEMORY VERIFY ERROR AT...

Indicates an error verifying a value already written to memory. Use the location along with your system's memory map to locate the bad chip.

OFFENDING ADDRESS NOT FOUND

This message is used in conjunction with the I/O CHANNEL CHECK and RAM PARITY ERROR messages when the segment that has caused the problem cannot be isolated.

OFFENDING SEGMENT

This message is used in conjunction with the I/O CHANNEL CHECK and RAM PARITY ERROR messages when the segment that has caused the problem has been isolated.

PRESS A KEY TO REBOOT

This will be displayed at the bottom screen when an error occurs that requires a reboot. Press any key and the system will reboot.

SYSTEM HALTED, (CTRL-ALT-DEL) TO REBOOT...

Indicates the present boot attempt has been aborted and the system must be rebooted. Press and hold down the CTRL, ALT and DEL keys simultaneously.



IDE Device Drivers

To install the IDE device drivers supported by the G586IPV system board, please refer to the "Readme" file contained in the provided diskette.





Chapter 4 Troubleshooting Checklist

If you experience difficulty with the G586IPV system board, please refer to the checklist below. If you still cannot identify the problem, please contact your dealer.

1. Check the jumper settings to ensure that the jumpers are properly set. If in doubt, refer to the "Hardware Installation" section.
2. Verify that all SIMMs or DIMM are seated securely into the bank sockets.
3. Make sure the SIMMs are in the correct locations.
4. Check that all populated memory banks are filled with correctly sized SIMMs.
5. If your board fails to function, place the board on a flat surface and seat all socketed components (gently press each component into the socket).
6. If you made changes to the BIOS settings, re-enter setup and load the BIOS defaults.

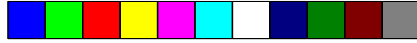

Appendix A Types of Modules

The G586IPV system board allows you to populate memory with 1MBx64 or 2MBx64 DIMM, and 1MBx32, 2MBx32, 4MBx32 and 8MBx32 SIMMs. The following modules have been tested with this board. Most untested brands will work but a few may fail to do so.

DIMM

DIMM	Brand	Chip Number
1MBx64	NEC	D4516161G5-7JF (SDRAM)

SIMM

SIMM	Brand	Chip Number
1MBx32	Fujitsu OKI	81C1000A-70 M51440A-70
2MBx32	OKI NEC Micron TI Micron Micron NEC	M511000B-70 424400-60 40447-60 TMS4400DJ-70 MT4C4007-70 (EDO) MT4C4007-60 (EDO) 4218165-60 (EDO)
4MBx32	Hitachi Fujitsu Mitsubishi Hitachi NEC NEC	7400AS-70 8117400-70 422A06-70 5117400AS-70 4217400-60 4217405-70 (EDO)
8MBx32	NEC	4217405-60 (EDO)



Appendix B Memory and I/O Maps

Memory Address Map

Address	Name	Function
0000000 to 009FFFF	640KB System Board RAM	System Board Memory
00A0000 to 00BFFFF	128KB Video Display Memory	Reserved for Graphics Display Memory
00C0000 to 00E7FFF	160KB I/O Expansion ROM	Reserved for ROM on I/O Adapter Card
00E8000 to 00FFFFFF	96KB ROM on the System Board	System Board BIOS
0100000 to 7FFFFFF	Maximum Memory 128MB	System Board Memory

I/O Address Map

I/O Address	Function
0000-001F	DMA Controller 1, 8237A-5
0020-003F	Interrupt Controller 1, 8259A, Master
0040-005F	Timer, 8254-2
0060-006F	8742 (Keyboard Controller)
0070-007F	Real-time Clock, NMI (Non-maskable Interrupt) Mask
0080-009F	DMA Page Memory, 74LS612
00A0-00BF	Interrupt Controller 2, 8259A
00C0-00DF	DMA Controller 2, 8237A-5
00E8	Shadow RAM and Cache Control Bit
00F0	Clear Numeric Processor Extension Busy
00F1	Reset Numeric Processor Extension
00F8-00FF	Numeric Processor Extension
01F0-01F8	Fixed Disk
0200-0207	Game I/O
0278-027F	Parallel Printer Port 2
02F8-02FF	Serial Port 2
0300-031F	Prototype Card
0360-036F	Reserved
0378-037F	Parallel Printer Port 1
0380-038F	SDLC, Bisynchronous 2
03A0-03AF	Bisynchronous 1
03B0-03BF	Monochrome Display and Printer Adapter
03C0-03CF	Reserved
03D0-03DF	Color/Graphics Monitor Adapter
03F0-03F7	Diskette Controller
03F8-03FF	Serial Port 1

Note:

*The I/O address hex 0000 to 00FF are reserved for the system board I/O.
Hex 0100 to 03FF are available on the I/O channels.*

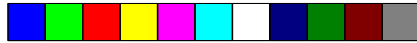

Appendix C PCI I/O Pin Assignments

Component Side	B	A	Solder Side
	-12V	-01 -	TRST#
TCK		-02 -	+12V
Ground		-03 -	TMS
TDO		-04 -	TDI
+5V		-05 -	+5V
+5V		-06 -	INTA#
INTB#		-07 -	INTC#
INTD#		-08 -	+5V
PRSNT1#		-09 -	Reserved
Reserved		-10 -	+5V (I/O)
PRSNT2#		-11 -	Reserved
Ground		-12 -	Ground
Ground		-13 -	Ground
Reserved		-14 -	Reserved
Ground		-15 -	RST#
CLK		-16 -	+5V (I/O)
Ground		-17 -	GNT#
REQ#		-18 -	Ground
+5V (I/O)		-19 -	Reserved
AD[31]		-20 -	AD[30]
AD[29]		-21 -	N. C.
Ground		-22 -	AD[28]
AD[27]		-23 -	AD[26]
AD[25]		-24 -	Ground
N. C.		-25 -	AD[24]
C/BE[3]#		-26 -	IDSEL
AD[23]		-27 -	N. C.
Ground		-28 -	AD[22]
AD[21]		-29 -	AD[20]
AD[19]		-30 -	Ground
N. C.		-31 -	AD[18]
AD[17]		-32 -	AD[16]
C/BE[2]#		-33 -	N. C.
Ground		-34 -	FRAME#
IRDY#		-35 -	Ground
N. C.		-36 -	TRDY#
DEVSEL#		-37 -	Ground
Ground		-38 -	STOP#
LOCK#		-39 -	N. C.
PERR#		-40 -	SDONE
N. C.		-41 -	SBO#
SERR#		-42 -	Ground
N. C.		-43 -	PAR
C/BE[1]#		-44 -	AD[15]
AD[14]		-45 -	N. C.
Ground		-46 -	AD[13]
AD[12]		-47 -	AD[11]
AD[10]		-48 -	Ground
Ground		-49 -	AD[09]
AD[08]		-52 -	C/BE[0]#
AD[07]		-53 -	N. C.
N. C.		-54 -	AD[06]
AD[05]		-55 -	AD[04]
AD[03]		-56 -	Ground
Ground		-57 -	AD[02]
AD[01]		-58 -	AD[00]
+5V (I/O)		-59 -	+5V (I/O)
ACK64#		-60 -	REQ64#
+5V		-61 -	+5V
+5V		-62 -	+5V

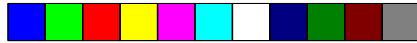

Appendix D ISA I/O Pin Assignments

B		A
Gnd	- 01 -	-I/OChck
ResetDiv	- 02 -	SD7
+5VDC	- 03 -	SD6
IRQ9	- 04 -	SD5
-5VDC	- 05 -	SD4
DRQ2	- 06 -	SD3
-12VDC	- 07 -	SD2
O/S	- 08 -	SD1
+12VDC	- 09 -	SD0
Gnd	- 10 -	-I/OChrty
-SEMEMW	- 11 -	AEN
-SEMEMR	- 12 -	SA19
-IOW	- 13 -	SA18
-IOR	- 14 -	SA17
-Dack3	- 15 -	SA16
-DRQ3	- 16 -	SA15
-Dack1	- 17 -	SA14
DRQ1	- 18 -	SA13
-Refresh	- 19 -	SA12
CLK	- 20 -	SA11
IRQ7	- 21 -	SA10
IRQ6	- 22 -	SA9
IRQ5	- 23 -	SA8
IRQ4	- 24 -	SA7
IRQ3	- 25 -	SA6
-Dack2	- 26 -	SA5
T/C	- 27 -	SA4
Bale	- 28 -	SA3
+5VDC	- 29 -	SA2
CSC	- 30 -	SA1
Gnd	- 31 -	SA0

D		C
-MemCS16	- 01 -	SBHE
-I/OCS16	- 02 -	LA23
IRQ10	- 03 -	LA22
IRQ11	- 04 -	LA21
IRQ12	- 05 -	LA20
IRQ13	- 06 -	LA19
IRQ14	- 07 -	LA18
-Dack0	- 08 -	LA17
DRQ0	- 09 -	-Memr
-Dack5	- 10 -	-Memw
DRQ5	- 11 -	SD08
-Dack6	- 12 -	SD09
DRQ6	- 13 -	SD10
-Dack7	- 14 -	SD11
DRQ7	- 15 -	SD12
+5VDC	- 16 -	SD13
-Master	- 17 -	SD14
Gnd	- 18 -	SD15

Appendix E

Connector Pin Assignments

Connector J3 PS2 Mouse Connector

Pin	Function
1	Mouse Data
2	Reserved
3	Ground
4	+5V
5	Mouse Clock
6	Reserved

J4 (COM1) and J5 (COM2) COM 1 and COM 2 Serial Ports

Pin	Function
1	DCD (Data Carrier Detect)
2	RX (Receive Data)
3	TX (Transmit Data)
4	DTR (Data Terminal Ready)
5	Ground (Signal Ground)
6	DSR (Data Set Ready)
7	RTS (Request to Send)
8	CTS (Clear to Send)
9	RI (Ring Indicator)

Connector J6 Floppy Disk Drive Connector

Pin	Function	Pin	Function
1	Ground	12	DR1
2	DENSEL	13	Ground
3	Ground	14	DR0
4	Reserved	15	Ground
5	Ground	16	MTR1
6	Drate0	17	Drate1
7	Ground	18	Dir
8	Index	19	Ground
9	Ground	20	Step
10	MTR0	21	Ground
11	Ground	22	Write Data



Pin	Function
23	Ground
24	Write Gate
25	Ground
26	Track 0
27	MSEN
28	Wr Protect

Pin	Function
29	Ground
30	Read Data
31	Ground
32	Head Select
33	Ground
34	Disk Change

Connector J7
Parallel Printer Port

Pin	Function
1	-Strobe
2	Data 0
3	Data 1
4	Data 2
5	Data 3
6	Data 4
7	Data 5
8	Data 6
9	Data 7
10	-Ack
11	Busy
12	Paper Empty
13	Select

Pin	Function
14	-Autofd
15	-Error
16	-Init
17	-Slctin
18	Ground
19	Ground
20	Ground
21	Ground
22	Ground
23	Ground
24	Ground
25	Ground

Connectors J8 and J9
Primary and Secondary IDE Hard Disk Drive Connectors

Pin	Function
1	-Reset
2	Ground
3	D7
4	D8
5	D6
6	D9
7	D5
8	D10
9	D4
10	D11
11	D3
12	D12
13	D2
14	D13
15	D1

Pin	Function
16	D14
17	D0
18	D15
19	Ground
20	Reserved
21	Reserved
22	Ground
23	-IOW
24	Ground
25	-IOR
26	Ground
27	Reserved
28	BALE
29	Reserved
30	Ground

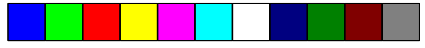

Pin	Function
31	IRQ
32	IOCS16
33	SA1
34	Reserved
35	SA0

Pin	Function
36	SA2
37	HCS0
38	HCS1
39	LED
40	Ground

Connector J10

Fan Connector

Pin	Function
1	Ground
2	+12V
3	Ground

Connector J11

Infrared Connector

Pin	Function
1	IRTX
2	GND
3	IRRX
4	Reserve
5	VCC

Connector J13

HD LED Connector

Pin	Function
1	VCC
2	Signal

Connector J14

Green LED Connector

Pin	Function
1	VCC
2	Signal



Connector J15
Green Button Connector

Pin	Function
1	Ground
2	Signal

Connector J16
Reset Switch Connector

Pin	Function
1	Ground
2	Reset

Connector J17
Speaker Connector

Pin	Function
1	Signal
2	Reserved
3	GND
4	VCC

Connector J18
Power LED/Keylock Connector

Pin	Function
1	LED Signal
2	Reserved
3	Ground
4	Keylock Signal
5	Ground

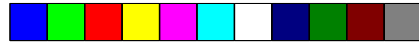

Connector CN1
PS/2 Keyboard Connector

Pin	Function
1	Keyboard Data
2	Reserved
3	Ground
4	+5V
5	Keyboard Clock
6	Reserved

Connector CN2
AT Keyboard Connector

Pin	Function
1	Keyboard Clock
2	Keyboard Data
3	Reserved
4	Ground
5	+5V

Connector PL1
Power Connector

Pin	Function
1	Power Good
2	+5V
3	+12V
4	-12V
5	Ground
6	Ground
7	Ground
8	Ground
9	-5V
10	+5V
11	+5V
12	+5V



Connector SSM1
Cache Module Slot

Pin	Function	Pin	Function
1	Ground	47	D48
2	TIO0	48	Ground
3	TIO2	49	D46
4	TIO6	50	D44
5	TIO4	51	D42
6	RSVD	52	VOC3
7	VOC3	53	D40
8	TWE#	54	D38
9	CADS#CAA3	55	D36
10	Ground	56	Ground
11	HBE4#	57	D34
12	HBE6#	58	D32
13	HBE0#	59	D30
14	HBE2#	60	VOC3
15	VOC3	61	D28
16	CCS#CAB4	62	D26
17	GVE#	63	D24
18	BVE#	64	Ground
19	Ground	65	D22
20	A3	66	D20
21	A7	67	D18
22	A5	68	VOC3
23	A11	69	D16
24	A16	70	D14
25	VOC3	71	D12
26	A18	72	Ground
27	Ground	73	D10
28	A12	74	D8
29	A13	75	D6
30	ADSP#	76	VOC3
31	ECS1#(CS#)	77	D4
32	ECS2#	78	D2
33	PD1	79	D0
34	PD3	80	Ground
35	Ground	81	Ground
36	CLK1	82	TIO1
37	Ground	83	TIO7
38	D62	84	TIO5
39	VOC3	85	TIO3
40	D60	86	RSVD
41	D58	87	VOC5
42	D56	88	RSVD
43	Ground	89	CADV#CAA4
44	D54	90	Ground
45	D52	91	COE#
46	D50	92	HBE5#



Pin	Function	Pin	Function
93	HBE7#	127	D49
94	HBE1#	128	Ground
95	VCC5	129	D47
96	HBE3#	130	D45
97	CAB3	131	D43
98	CALE	132	VCC5
99	Ground	133	D41
100	RSVD	134	D39
101	A4	135	D37
102	A6	136	Ground
103	A8	137	D35
104	A10	138	D33
105	VCC5	139	D31
106	A17	140	VCC5
107	Ground	141	D29
108	A9	142	D27
109	A14	143	D25
110	A15	144	Ground
111	RSVD	145	D23
112	PD0	146	D21
113	PD2	147	D19
114	PD4	148	VCC5
115	Ground	149	D17
116	CLK0	150	D15
117	Ground	151	D13
118	F63	152	Ground
119	VCC5	153	D11
120	D61	154	D9
121	D69	155	D7
122	D57	156	VCC5
123	Ground	157	D5
124	D65	158	D3
125	D53	159	D1
126	D51	160	Ground

Appendix F Row Address Strobe of the DRAM and SDRAM

After you power up your system, the BIOS message appears on your screen and the memory count begins.

After the memory test, the screen will appear as below:

Award Software, Inc.
System Configurations

CPU Type	: 6x86-P166+	Base Memory	: 640K
Co-Processor	: Installed	Extended Memory	: 15360K
CPU Clock	: 133MHz	Cache Memory	: 256K
Diskette Drive A	: 1.44M, 3.5in.	Display Type	: EGA/VGA
Diskette Drive B	: None	Serial Port (s)	: 3F8 2F8
Pri. Master Disk	: None	Parallel Port (s)	: 378
Pri. Slave Disk	: None	EDO DRAM at Row (s)	: 0, 1
Sec. Master Disk	: None	SDRAM at Row (s)	: None
Sec. Slave Disk	: None	PB SRAM Presence	: Yes

EDO DRAM at Row (s)

"Row (s)" refers to the Row Address Strobe of the DRAM or SDRAM. The Row Address Strobe differs according to the location and type of DRAM or SDRAM installed on the system board. The table below shows the Row Address Strobe values with their corresponding type of SIM/DIM modules and Bank locations.

"Rows"	Number/Location of SIM or DIM modules	Types of SIM/DIM module (Single/Double Density)
0	2 SIMM / Bank 0	Single density EDO DRAM
0, 1	2 SIMM / Bank 0	Double density EDO DRAM
0, 2	4 SIMM / Bank 0, 1	Single density EDO DRAM
0, 1, 2, 3	4 SIMM / Bank 0, 1	Double density EDO DRAM
2	1 DIMM / DM1	Single density SDRAM
2, 3	1 DIMM / DM1	Double density SDRAM