



# **G586PC**

**Rev. B+**  
**System Board**  
**User's Manual**



**-D30160430-**



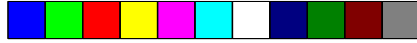

## FCC Statement on Class B

This equipment has been tested and found to comply with the limits for a Class B digital device, pursuant to Part 15 of the FCC rules. These limits are designed to provide reasonable protection against harmful interference when the equipment is operated in a residential installation. This equipment generates, uses and can radiate radio frequency energy and, if not installed and used in accordance with the instruction manual, may cause harmful interference to radio communications. However, there is no guarantee that interference will not occur in a particular installation. If this equipment does cause harmful interference to radio or television reception, which can be determined by turning the equipment off and on, the user is encouraged to try to correct the interference by one or more of the following measures:

- Reorient or relocate the receiving antenna.
- Increase the separation between the equipment and the receiver.
- Connect the equipment into an outlet on a circuit different from that to which the receiver is connected.
- Consult the dealer or an experienced radio TV technician for help.

### Notice:

1. The changes or modifications not expressly approved by the party responsible for compliance could void the user's authority to operate the equipment.
2. Shielded interface cables must be used in order to comply with the emission limits.

The manufacturer makes no warranties with respect to this documentation and disclaims any implied warranties of merchantability, quality, or fitness for any particular purpose. The information in this document is subject to change without notice. The manufacturer reserves the right to make revisions to this publication and to make changes to any and/or all parts of its content, at any time, without obligation to notify any person or entity of such changes. Further, the manufacturer assumes no responsibility for any errors that may appear in this document.

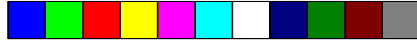

## Table of Contents

<b>Chapter 1: Introduction .....</b>	<b>5</b>
Features and Specifications .....	6
Package Checklist .....	8
<b>Chapter 2: Hardware Installation .....</b>	<b>9</b>
Preparing the Area .....	9
Handling the System Board .....	9
Installing the System Board .....	10
Board Layout .....	12
System Memory .....	13
Installing a SIM Module .....	14
Cache Memory .....	14
Installing the Cache Module .....	15
CPU Installation .....	16
Jumper Settings for Various CPUs .....	16
Installing Upgrade CPUs .....	23
Installing Fan/Heatsink for Cyrix CPUs .....	26
Jumper Settings for Password Clear .....	27
Jumper Settings for Display .....	27
Built-in Ports .....	28
Serial Ports .....	28
PS/2 Mouse Port .....	29
Parallel Port .....	29
Floppy Disk Drive Controller .....	29
IDE Hard Disk Interface .....	30
Installing Expansion Cards .....	32
<b>Chapter 3: Software Installation .....</b>	<b>33</b>
Award BIOS CMOS Setup Utility .....	33
Standard CMOS Setup .....	34
BIOS Features Setup .....	36
Chipset Features Setup .....	37
Power Management Setup .....	38
PCI Configuration Setup .....	39
Load BIOS Defaults .....	39
Load Setup Defaults .....	39
PnP Configuration Setup .....	40
I/O Configuration Setup .....	40

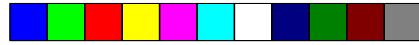

Supervisor Password .....	41
User Password .....	42
IDE HDD Auto Detection .....	42
Save & Exit Setup .....	45
Exit Without Saving .....	45
System Error Report .....	46
IDE Device Drivers .....	48
<b>Chapter 4: Troubleshooting Checklist .....</b>	<b>49</b>
<b>Appendix A: Types of SIM Modules .....</b>	<b>50</b>
<b>Appendix B: Memory and I/O Maps .....</b>	<b>51</b>
<b>Appendix C: PCI I/O Pin Assignments .....</b>	<b>53</b>
<b>Appendix D: ISA I/O Pin Assignments .....</b>	<b>54</b>
<b>Appendix E: System Overview .....</b>	<b>55</b>
<b>Appendix F: Connector Pin Assignments .....</b>	<b>57</b>





## Chapter 1 Introduction

---

The G586IPC, equipped with a 321-pin Zero Insertion Force (ZIF) CPU socket, is a fast Pentium processor system board supporting Intel Pentium CPUs running at 75MHz, 90MHz, 100MHz, 120MHz, 133MHz, 150MHz, and 166MHz frequencies. The G586IPC also supports Cyrix P120+/P133+/P150+/P166+, AMD 5x86 75MHz, and 200MHz CPUs.

The G586IPC uses the Intel 82430HX chipset. It supports Error Checking and Correction (ECC) that performs single bit error correction and parity check for multi-bit error detection.

The G586IPC can support 8MB to 256MB of system memory using EDO or fast page mode x32 or x36 DRAM. This system board also supports pipeline burst SRAM and provides easy cache upgrade using 256KB or 512KB cache modules.

The G586IPC design is based on the Peripheral Component Interconnect (PCI) local bus and Industry Standard Architecture (ISA) standards. It is equipped with 3 dedicated PCI slots, 3 dedicated 16-bit ISA slots and 1 shared PCI/ISA slot.

The G586IPC board has two bus master PCI IDE connectors. Bus mastering reduces CPU use during disk transfer. This system board is also equipped with two NS16C550A-compatible serial ports, an SPP/ECP/EPP parallel port, a floppy disk drive controller, one PS/2 mouse port and one PS/2 or AT keyboard connector.



## Features and Specifications

### Processor

- Intel Pentium™ 75/90/100/120/133/150/166MHz
- Future Pentium™ OverDrive processor
- Cyrix P120+/P133+/P150+/P166+
- AMD 5x86 75MHz
- 200MHz CPUs supported

### Chipset

- Intel 82430HX PCIsset

### Cache Memory

- Supports 0KB, 256KB or 512KB pipeline burst, direct map write-back cache
- One 160-pin cache module slot
- Two options:
  - 0KB onboard: upgradeable with a 256KB or 512KB cache module
  - 256KB onboard: upgradeable with a 256KB cache module for a maximum of 512KB cache

### System Memory

- Four 72-pin SIMM sockets
- 8MB to 256MB onboard memory
- Uses EDO or fast page mode x32 or x36 DRAM, 60 or 70ns, 5V
- ECC and Parity Check supported (uses x36 DRAM)

### BIOS

- Award BIOS, Windows 95 Plug and Play compatible
- Flash EPROM for easy BIOS upgrades

### Energy Efficient Design

- System power management supported
- CPU stopped clock control
- Hardware supports SMI green mode
- Microsoft/Intel APM 1.1 compliant
- External power management switch supported



### **PCI IDE Interface**

- PIO Mode 3 and Mode 4 Enhanced IDE (data transfer rate up to 16.6MB/sec.)
- DMA Mode 2 Bus Master IDE (data transfer rate up to 22.2MB/sec.)
- Bus mastering reduces CPU utilization during disk transfer
- ATAPI IDE CD-ROM supported

### **Integrated I/O**

- SMC super I/O controller
- Two NS16C550A-compatible high speed UARTS
- One SPP/ECP/EPP parallel port
- Supports 360KB, 720KB, 1.2MB, 1.44MB, and 2.88MB floppy drives
- Universal Serial Bus\*  
Two connectors onboard
- IrDA TX/RX header\*

### **CPU Socket**

- 321-pin ZIF socket (Intel Socket 7)
- Supports future low-voltage (2.5V) CPUs

### **Connectors**

- 2 serial ports
- 1 parallel port
- 2 IDE connectors
- 1 floppy connector
- 1 PS/2 mouse port
- 1 mini-DIN-6 PS/2 keyboard connector or AT keyboard connector

### **Expansion Slots**

- 3 dedicated PCI slots
- 3 dedicated 16-bit ISA slots
- 1 shared PCI/ISA slot

### **PCB**

- 4 layers, Baby AT form factor
- 25cm (9.84") x 22cm (8.66")

\* Supported in future revision.



## Package Checklist

The G586IPC package contains the following items:

- The G586IPC system board
- The G586IPC user's manual
- One 40-pin IDE hard disk cable
- One 34-pin floppy disk drive cable
- One 25-pin printer port cable for chassis mounting
- One card-edge bracket with serial and mouse port cables
- One IDE driver diskette
- Cache module (optional)

If any of these items are missing or damaged, please contact your dealer or sales representative for assistance.







## Chapter 2 Hardware Installation

---

This chapter summarizes the steps to install the G586IPC system board into your system unit. It also includes a description of the area in which you must work and directions for memory installation. Before installing the system board, obtain the memory you plan to install. Please refer to the information on page 13 for the number and type of SIM modules needed for the amount of memory you require.

### Preparing the Area

Before unpacking the system board, make sure the location you have selected is relatively free of dust and static electricity. Excessive exposure to dust, static electricity, direct sunlight, excessive humidity, extreme cold, and water can damage the operational capabilities of your system board. Avoid placing the unit on surfaces such as carpeted floors. These areas attract static electricity which can damage circuits on your system board.

Make sure the power source has a properly grounded, three-pronged socket. It is essential that the power connection be properly grounded for correct functioning of your system board. For further protection, we recommend that you use a surge suppressor. This will protect the system board from damage that may result from a power surge on the electrical line.

Move items that generate magnetic fields away from your system board since magnetic fields can also damage your system board. Once you have selected the ideal location, unpack the G586IPC system board carefully.

### Handling the System Board

It is quite easy to inadvertently damage your system board even before installing it in your system unit. Static electrical discharge can damage computer components without causing any signs of physical damage. You must take extra care in handling the system board to ensure against electrostatic build-up.



## Static Electricity Precautions

1. To prevent electrostatic build-up, leave the board in its anti-static bag until you are ready to install it.
2. Wear an antistatic wrist strap.
3. Do all preparation work on a static-free surface with the system board components facing up.
4. Hold the system board only by its edges. Be careful not to touch any of the components, contacts or connections, especially gold contacts, on the board.
5. Avoid touching the pins or contacts on all modules and connectors. Hold modules and connectors by their ends.

### **Warning:**

*Electrostatic discharge (ESD) can damage your processor, disk drives, add-in boards, and other components. Perform the upgrade instruction procedures described at an ESD workstation only. If such a station is not available, you can provide some ESD protection by wearing an anti-static wrist strap and attaching it to a metal part of the system chassis. If a wrist strap is unavailable, establish and maintain contact with the system chassis throughout any procedures requiring ESD protection.*

## Installing the System Board

If you are installing the G586IPC system board, the following outlines the basic installation steps. Before installing the system board into your system unit, you should prepare the tools you will need.

You will need:

- One medium size, flat-bladed screwdriver
- One medium Phillips screwdriver
- One needle-nosed pliers
- One nutdriver

1. Unlock your system unit. Turn off the power and disconnect all power cords and cables.



2. Remove the system unit cover. Refer to the manufacturer's instructions if necessary.
3. Detach all connectors from the old system board and remove expansion cards seated in any of the expansion slots.
4. Loosen the screws holding the original system board and remove the board from the system. Save the screws.
5. Remove the G586IPC from its original packing box. Be careful to avoid touching all connectors and pins on the board. Please refer to the handling instructions on pages 9-10 for proper handling techniques.
6. Insert the SIMMs into the SIMM banks on the G586IPC. The quantity and location of the SIMMs depends on the memory configuration and type of modules you intend to use.
7. Insert the cache module, if any, into the cache module slot on the G586IPC. Refer to the Cache Memory section on page 15 for upgrading your cache memory.
8. Install the CPU. Be sure pin 1 of the CPU is aligned with pin 1 of the socket.
9. Set the corresponding jumpers.
10. Install the prepared G586IPC system board into the case and replace the screws.
11. Reinstall all cards and connectors and replace the system unit cover. Reconnect all power cords and cables.



# Board Layout

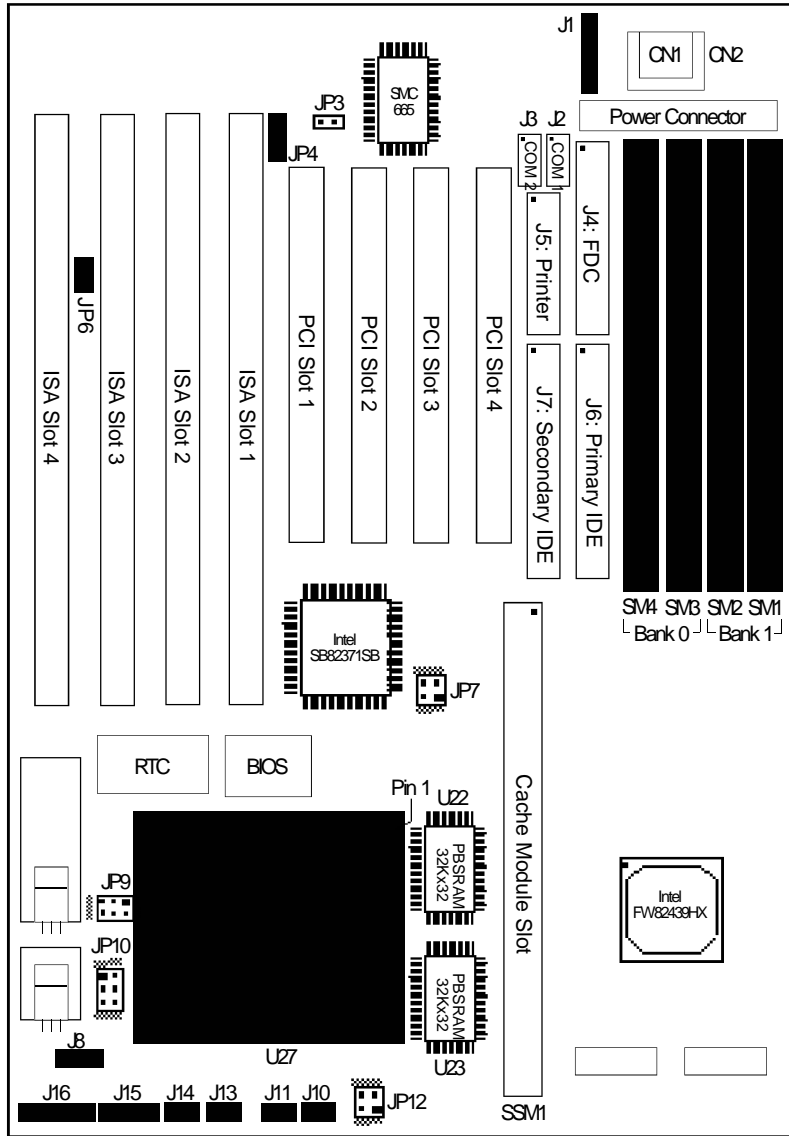

■ Pin 1  
 PBSRAM = Pipeline Burst SRAM

## System Memory

The SIMM (Single In-line Memory Module) sockets are divided into two banks on the system board, Bank 0 and Bank 1. Each bank consists of 2 SIMM sockets.

You will need either 2 or 4 pieces of SIM modules, depending on the amount of memory you intend to install. Make sure you insert the same type of SIMMs in one bank. You can install SIMMs in either of the banks, Bank 0 or Bank 1, but you must populate a bank first before going to the next bank.

The G586IPC system board can support 8MB to 256MB of memory using 1MBx36, 2MBx36, 4MBx36, 8MBx36, or 16MBx36 72-pin SIMMs. The table below shows the supported SIM modules and their corresponding memory sizes.

SIMMs	Memory Size
1MBx36	4MB
2MBx36	8MB
4MBx36	16MB
8MBx36	32MB
16MBx36	64MB

Examples:

If you are installing 8MB of memory, you must insert two 1MBx36 SIMMs in Bank 0 or Bank 1.

If you are installing 256MB of memory, you must insert four 16MBx36 SIMMs in Bank 0 and Bank 1.

If you are installing 24MB of memory, you must insert two 1MBx36 SIMMs in Bank 0 and two 2MBx36 SIMMs in Bank 1. You may also install it vice versa by inserting two 1MBx36 SIMMs in Bank 1 and two 2MBx36 SIMMs in Bank 0.

## Installing a SIM Module

A SIM module simply snaps into a socket on the system board. Pin 1 of the SIM module must correspond with Pin 1 of the socket.

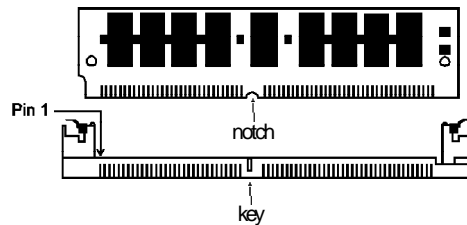

1. Position the SIMM above the socket with the “notch” in the module aligned with the “key” on the socket.
2. Seat the module at a 45° angle into the bank. Make sure it is completely seated. Tilt the module upright until it locks in place in the socket.

## Cache Memory

The G586IPC system board can support 256KB or 512KB pipeline burst, direct map write-back cache SRAM. Your system board may come with 0KB or 256KB cache mounted onboard. The 160-pin cache module slot lets you upgrade your cache memory by installing a 256KB or 512KB cache module.

### Note:

*You do not need to set any jumpers or modify the Award BIOS Setup utility when you install the cache module.*

If your system board comes with 0KB cache, you can install a 256KB or 512KB cache module in the cache module slot. If your system board comes with 256KB cache at locations U22 and U23, you can upgrade your cache memory to 512KB by installing a 256KB cache module in the cache module slot. Please refer to page 12 for the locations of the cache module slot (SSM1), U22 and U23.

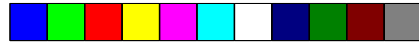

Onboard Cache	Upgradeable Cache Module
0KB	upgradeable with a 256KB or 512KB cache module
256KB	upgradeable with a 256KB cache module for a maximum of 512KB cache

**Warning:**

*We highly recommend that you use T2BSM32-256 or T2BSM32-512 cache modules. If you are using cache modules other than the ones recommended above, make sure your cache module(s) meets the Intel COAST 2.x specification. Severe damage might occur on the cache module or system board if you insert modules other than those specified above.*

**Installing the Cache Module**

Locate the 160-pin cache module slot on the system board (SSM1). See page 12 for the location. Position the cache module above the slot. Make sure pin 1 of the cache module is aligned with pin 1 of the slot. Carefully slide the module into the slot. Press firmly on the top of it to seat it properly.

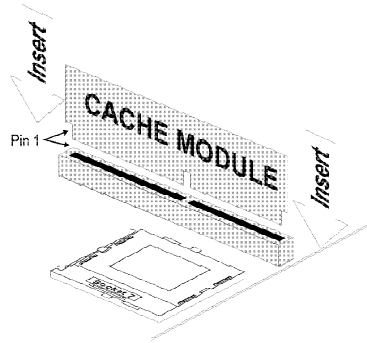

**Note:**

*With the cache module installed in the cache module slot, there is no limit to the length of the add-in card installed in PCI Slot 4, however, the components on the solder side of the add-in card in PCI Slot 4 must not protrude more than 5mm.*

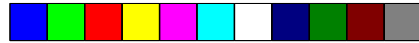

## CPU Installation

The G586IPC allows for easy installation of CPUs. Make sure all jumpers are set correctly before applying power or you may damage the CPU or system board. Use the needle-nosed pliers to move the jumpers as necessary. Please see the jumper settings on the following pages.

### Jumper Settings for Various CPUs

#### Jumpers JP6, JP7 and JP12

**Intel 75MHz CPU:** External Speed: 50MHz  
Frequency Ratio: 1.5x

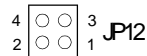
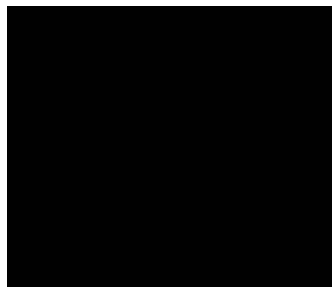
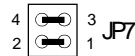



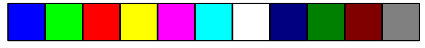

**Intel 90MHz CPU:** External Speed: 60MHz  
Frequency Ratio: 1.5x

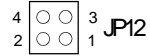
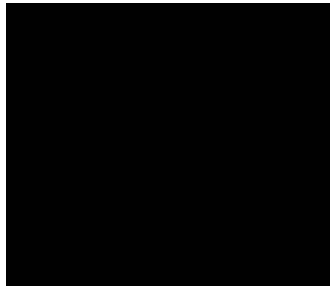
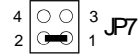

**Intel 100MHz CPU:** External Speed: 66MHz  
Frequency Ratio: 1.5x

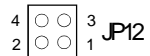
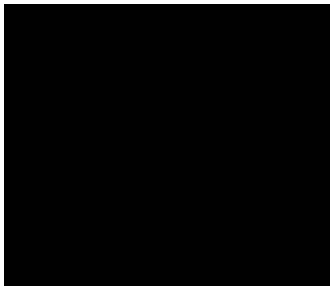
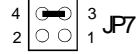

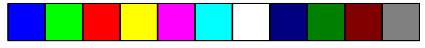

**Intel 120MHz CPU:** External Speed: 60MHz  
Frequency Ratio: 2x

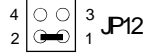

**Intel 133MHz CPU:** External Speed: 66MHz  
Frequency Ratio: 2x

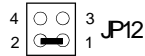
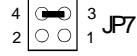

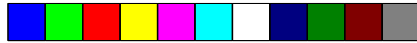

**Intel 150MHz CPU:** External Speed: 60MHz  
Frequency Ratio: 2.5x

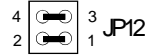
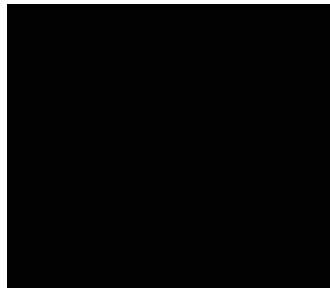
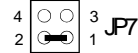

**Intel 166MHz CPU:** External Speed: 66MHz  
Frequency Ratio: 2.5x

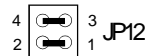
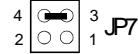

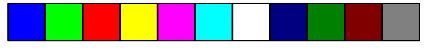

**200MHz CPUs:** External Speed: 66MHz  
Frequency Ratio: 3x

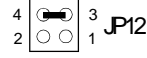
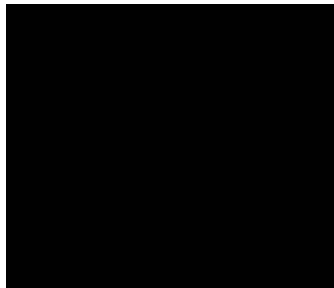
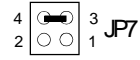

**Cyrix P120+ CPU:** External Speed: 50MHz  
Frequency Ratio: 2x

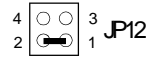
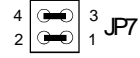

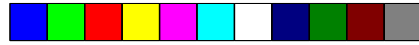

**Cyrix P133+ CPU:** External Speed: 55MHz  
Frequency Ratio: 2x

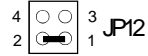
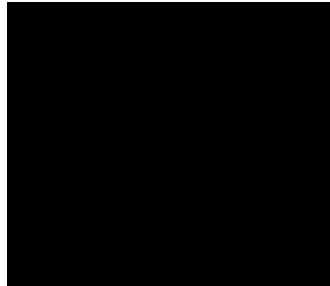
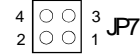

**Cyrix P150+ CPU:** External Speed: 60MHz  
Frequency Ratio: 2x

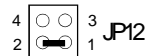
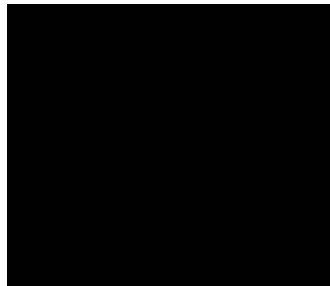
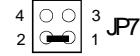

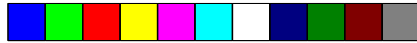

**Cyrix P166+ CPU:** External Speed: 66MHz  
Frequency Ratio: 2x

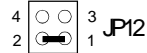
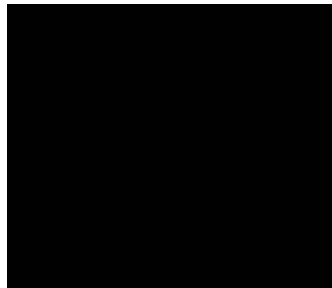
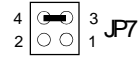

**AMD 5x86 75MHz CPU:** External Speed: 50MHz  
Frequency Ratio: 1.5x

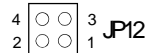
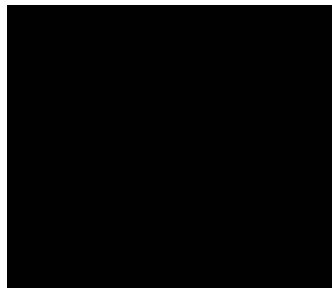
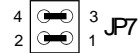



**Jumpers JP9 and JP10**  
CPU Voltage

3.3V CPUs  
(Default)

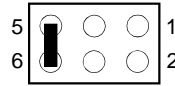

JP9: 5-6 On

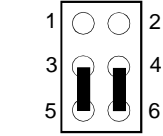

JP10: 3-5, 4-6 On

2.5V CPUs

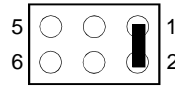

JP9: 1-2 On

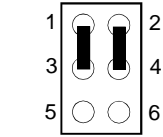

JP10: 1-3, 2-4 On

## Installing Upgrade CPUs

The G586IPC is equipped with a 321-pin Zero Insertion Force (ZIF) socket at location U27 of the system board. Refer to page 12 for the location of the ZIF socket. This socket is designed for easy removal of an old CPU and easy insertion of an upgrade CPU. The socket allows you to carefully place the new CPU into its position. If you need to apply excessive force to insert the CPU, you are not installing the CPU correctly.

### **Warning:**

*Open the socket only if you are actually installing a CPU. The warranty on the original CPU will be voided if the S/N seal is broken.*

*Before proceeding with the upgrade, take note of the following. The microprocessor and heat sink may be hot if the system has been running. To avoid the possibility of a burn, power the system off and let the processor and heat sink cool for 15 minutes.*

The 321-pin ZIF socket consists of five rows of pin holes on each side. To prevent improper CPU installation, the ZIF socket has a Plug/Keying mechanism. Several holes in the socket are plugged so that the CPU will go in only one way. If you cannot easily insert the CPU, verify that pin 1 of the CPU is aligned with pin 1 of the socket.

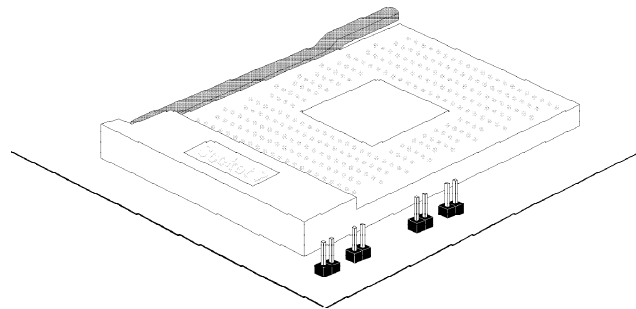

**Zero Insertion Force (ZIF) Socket**





To install an upgrade CPU, do the following.

1. Make sure the handle on the side of the ZIF socket is up. To raise the handle, push it down, slightly pull it out to the side, then raise it as far as it will go. It may be necessary to initially apply a small amount of sideways force to free the handle from its retaining "tab." Once clear of the "tab," the handle will open relatively easily. The top plate will slide back. Do not use screwdrivers or other tools to open the socket, or you may damage the system or socket.

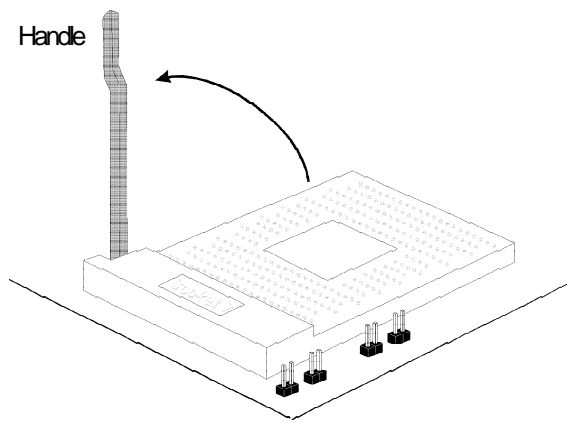

#### Lifting the Handle

2. Once the lever is completely up, remove the old CPU carefully by lifting it straight out of the socket. You are now ready to insert the new CPU.

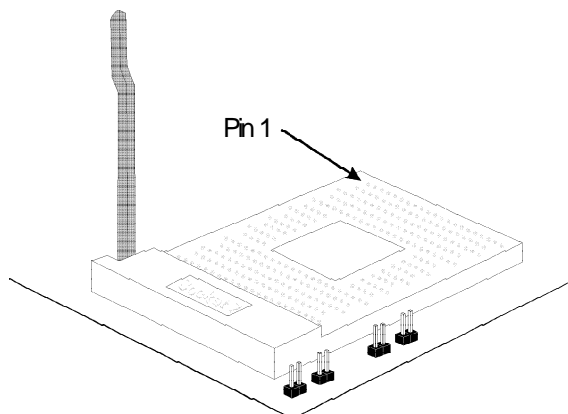



3. Position the CPU above the ZIF socket. Make sure pin 1 of the CPU is aligned with pin 1 of the socket. Lower the chip until the pins are inserted properly in their corresponding holes. Remember that very little force is needed to install the CPU. If the CPU is not easily inserted, verify whether or not pin 1 of the CPU is aligned with pin 1 of the socket. Applying too much pressure can damage the CPU or the socket.

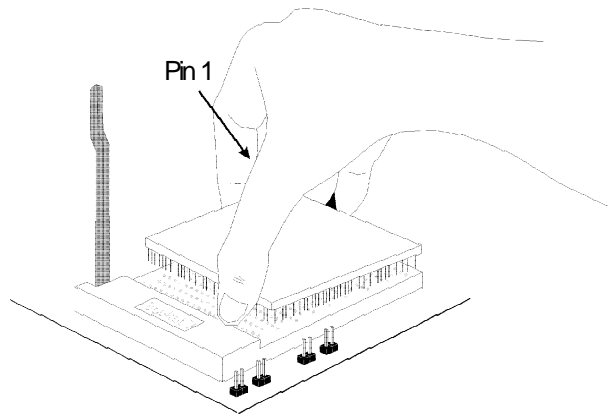

#### **Positioning the CPU Above the ZIF Socket**

4. Push the handle down until the handle locks into place. The top plate will slide forward. You will feel some resistance as the pressure starts to secure the CPU in the socket. This is normal and will not damage the CPU. However, if the handle is not completely closed, damage to the CPU and/or system board may result.

#### **Installing Fan/Heatsink for Cyrix CPUs**

The G586IPC system board supports Cyrix P120+, P133+, P150+ and P166+ CPUs. These CPUs consume 7.5A of electric current. If you use a Cyrix CPU, you should choose a fan/heatsink which is made for Cyrix processors. Position the fan/heatsink on the CPU such that the air from the side of the fan will flow across the heat regulators on the system board. See the illustration on the next page.

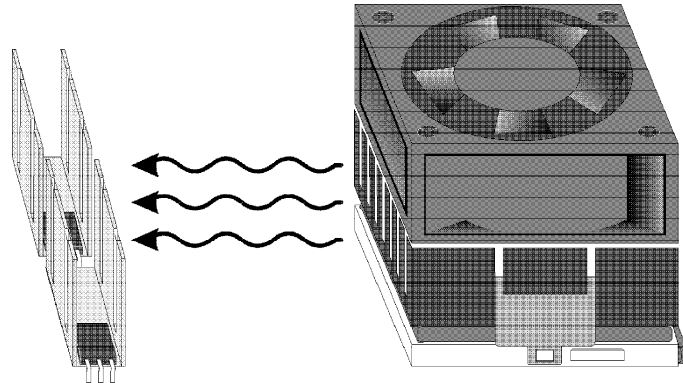
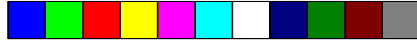

### **Clearance Requirements**

Your CPU comes with a heatsink mounted on top. To maintain proper airflow once the upgrade CPU is installed on the system board, the CPU and heatsink require certain space clearances.

The clearance above the CPU's fan/heat sink must be at least 0.4 inches. The clearance on at least 3 of 4 sides of the processor must be at least 0.2 inches. The cables (for floppy drive, hard drive, CD-ROM, etc.) must be routed clear of the CPU and its airspace.

### **Fan Exhaust**

The CPU must be kept cool by using a fan with heatsink. The temperature of the air entering the fan/heatsink cannot exceed 45°C (113°F). The ambient or room temperature must be below 37°C (99°F).

In order to provide proper airflow to the CPU, all movable obstructions (power supply cables, cards, floppy disk cables) must be clear of the CPU fan/heatsink component in accordance with the space clearance discussed in the Clearance Requirements section of this manual.



## Jumper Settings for Password Clear

### Jumper JP3 Password Clear

If you set a password in the “Password Setting” option and forget your password, power off your system and set Jumper JP3 to On to clear the password stored in your CMOS. Now power on your system. After your system has detected the floppy or hard drive, turn it off again and set JP3 to Off.



Off: Normal  
(Default)



On: Password Clear

## Jumper Settings for Display

### Jumper JP4 Display Type Select

Jumper JP4 sets the display adapter to color or mono. This jumper must match the type of display adapter installed. If you change your video adapter, make sure this jumper is changed accordingly.

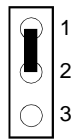

1-2 On: Color  
(Default)

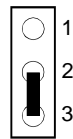

2-3 On: Mono

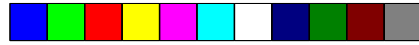

## Built-in Ports

The G586IPC system board is equipped with two serial ports, one parallel printer port, one FDD connector, two IDE hard disk shrouded headers and one PS/2 mouse connector. Refer to page 12 for the locations of the built-in connectors and pin 1 of those connectors.

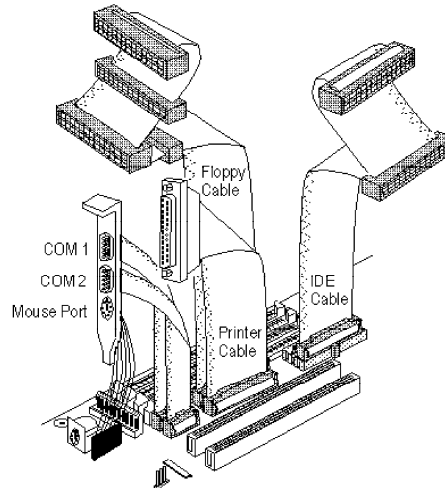

## Serial Ports

The built-in serial ports are RS-232C asynchronous communication ports with 16C550A-compatible UARTs that can be used with modems, serial printers, remote display terminals, and other serial devices. They use the following system I/O addresses:

Port Configuration	COM 1	COM 2	COM 3	COM 4
Serial Port 1	3F8h*	2F8h	3E8h	2E8h
Serial Port 2	3F8h	2F8h*	3E8h	2E8h

\* Default

## Connecting the Serial Ports

Two DB-9P serial port cables are provided with the system board. They are mounted on a card-edge bracket along with the PS/2 mouse cable. The upper serial port cable should be used for the COM 1 primary serial port; connect it to connector J2 on the system board. The lower



serial port cable should be used for the COM 2 secondary serial port; connect it to connector J3 on the system board. Make sure the colored stripes on the ribbon cables are aligned with pin 1 of connectors J2 and J3. Mount the card-edge bracket to the system chassis.

### **PS/2 Mouse Port**

The PS/2 mouse port is a 6-pin connector on the system board. Attach the 6-pin mouse port cable, which is mounted on the card-edge bracket, to connector J1. Make sure the brown wire on the PS/2 mouse connector is aligned with pin 1 of connector J1. Mount the card-edge bracket to the system chassis.

### **Parallel Port**

The G586IPC system board has a standard connector for interfacing your PC to a parallel printer. The parallel port on your system board can be set to any of the following system I/O addresses:

I/O Address: 3BC-3BE Hex  
378-37A Hex (default)  
278-27A Hex

### **Connecting the Parallel Printer Port**

Attach the DB-25S printer port cable, which came with the system board, to connector J5 on the G586IPC system board. Make sure the colored stripe on the ribbon cable aligns with pin 1 of connector J5. Use a small nutdriver to mount the cable into a DB-25 cutout in the system chassis.

### **Floppy Disk Drive Controller**

The G586IPC system board has a built-in floppy disk controller that supports two standard floppy disk drives. You can install any 360KB, 720KB, 1.2MB, 1.44MB, or 2.88MB floppy disk drives.

### **Connecting the Floppy Disk Cable**

1. Install the 34-pin header connector into the floppy disk connector (J4) on the system board. The colored edge of the ribbon should be aligned with pin 1 of connector J4.



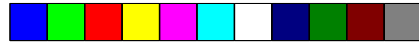

2. Install the other 34-pin header connector(s) into the disk drive(s). Align the colored edge of the daisy chained ribbon cable with pin 1 of the drive edge connector(s). The end-most connector should be attached to the drive you want to designate as Drive A.

## IDE Hard Disk Interface

The G586IPC system board is equipped with two PCI IDE shrouded headers that will interface up to four Enhanced IDE (Integrated Drive Electronics) hard disk drives.

### Note:

*Only Enhanced IDE hard drives or ATAPI CD-ROMs can be connected to the IDE interface.*

## Connecting the IDE Hard Disk Interface

To prevent improper IDE cable installation, each PCI IDE shrouded header has a keying mechanism. The 40-pin connector on the IDE cable can be placed into the header only if pin 1 of the connector is aligned with pin 1 of the header.

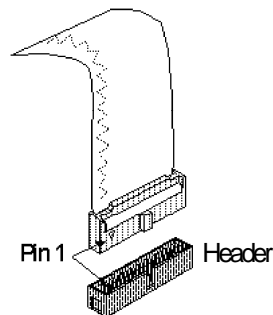

### Note:

*The IDE cable with a standard 40-pin connector (without the keying mechanism) can be installed in the PCI IDE shrouded header. Be extremely careful to match the colored edge of the ribbon with pin 1 of the header.*



## Connecting the Hard Disk Cable

1. Connect the cable to the system board. If you are connecting two hard drives, install the 40-pin connector of the IDE cable into the primary IDE shrouded header (connector J6). If you are adding a third or fourth IDE device, install the 40-pin connector of the other IDE cable into the secondary IDE shrouded header (connector J7).
2. Connect the cable to the devices. Install the other 40-pin header connector(s) into the device making sure to match the colored edge of the ribbon cable aligned with pin 1 of the drive edge connector(s).

### Note:

*Refer to your disk drive user's manual for information about selecting proper drive switch settings.*

## Adding a Second IDE Hard Drive

When using two IDE drives, one must be set as the master and the other as the slave. Follow the instructions provided by the drive manufacturer for setting the jumpers and/or switches on the drives.

We recommend that the Enhanced IDE hard drives be from the same manufacturer. In a few cases, drives from two different manufacturers will not function properly when used together. The problem lies in the hard drives, not the G586IPC system board.

## Preparing an IDE Drive for Use

IDE disk drives are already low-level formatted, with any bad-track errors entered, when shipped by the drive manufacturer. Do not attempt to do a low-level format or you may cause serious damage to the drive.

To use an IDE drive, you need to enter the drive type (this information is provided by the drive manufacturer) into the system's CMOS setup table. Then run FDISK and FORMAT provided with DOS.





**Warning:**

*Do not run FDISK and FORMAT programs on a drive that has already been formatted or you will lose all programs and data stored on the drive.*

## Installing Expansion Cards

The G586IPC system board is equipped with 3 dedicated PCI slots, 3 dedicated 16-bit ISA slots and 1 shared PCI/ISA slot. All PCI slots are bus masters. You can only install one card in one or the other of the shared slots at a time; you cannot install devices in both slots.

Due to the size of the CPU with its accompanying heatsink/fan component, the length of the add-in cards in PCI slots 1 and 2 and ISA slots 1 and 2 is limited to 18cm (measured from the bracket of the card).

The length of the add-in card in PCI slot 4 is limited to 18cm only if its components protrude more than 5mm from the solder side of the card.

Refer to page 12 for the locations of the expansion slots.

**Note:**

*The BIOS needs to be configured for the PCI add-in cards installed in the PCI slots. Refer to the "PCI Configuration Setup" presented in the "Software Installation" section of the manual.*



## Chapter 3 Software Installation

---

After you power up your system, the BIOS message appears on your screen and the memory count begins.

After the memory test, the following message will appear on the screen:

*Press DEL to enter setup*

If the message disappears before you respond, restart your system or press the “Reset” button on the front of your computer. You may also restart the system by pressing the <Ctrl> <Alt> and <Del> keys simultaneously. If you do not press these keys at the correct time and the system does not boot, the following error message will appear:

*Press Del to enter Setup*

If you have set a password and selected “System” in the Security Option of the BIOS Features Setup menu, you will be prompted for the password every time the system is rebooted or any time you try to enter Setup. Type in the correct password and press <Enter>.

If you selected “Setup” in the Security Option, you will be prompted for the password only when you try to enter Setup. Refer to the “BIOS Features Setup” section for more information.

### Award BIOS CMOS Setup Utility

Press <Ctrl>, <Alt> and <Esc> keys simultaneously or <Del> to enter the Setup utility. A screen similar to the one on the next page will appear.

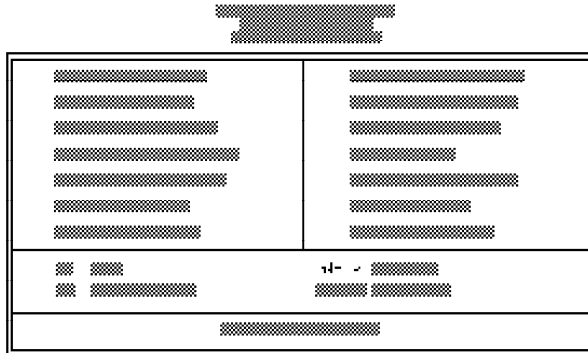
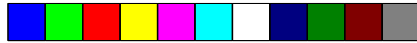

Use the arrow keys to highlight the option you want and press <Enter>. The following describes each of these options.

### Standard CMOS Setup

Use the arrow keys to highlight “Standard CMOS Setup” and press <Enter>. A screen similar to the one below will appear.

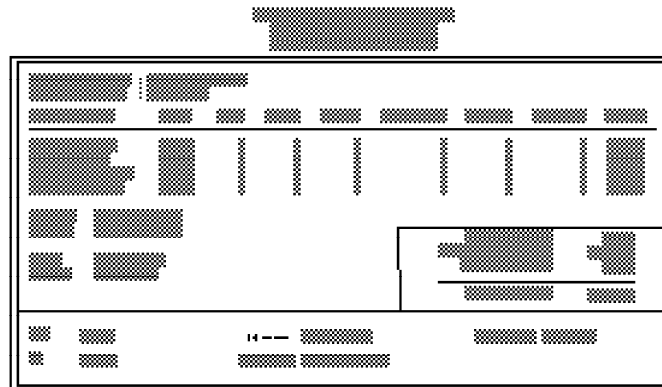

### Date and Time

This selection sets the time and date for the system. Press <F3> for the calendar.

### Hard Drive Type

This allows you to enter the appropriate specifications for the type of hard disk drive(s) installed in your system. Under the “Type” category,



you can select Auto, User, one of 46 predefined drive specifications or None.

**Auto:** This option indicates that the parameters for your hard disk drive(s) will be automatically detected and displayed when you boot your system. By default, the LBA mode is selected for a hard disk drive larger than 528 megabytes. If you decide not to accept the LBA mode, you can either specify your selection in the “IDE HDD Auto Detection” menu, or use the User option described below.

**User:** This type is user definable and allows you to enter the specifications yourself. Six categories of information are required: Size, Cylinders, Heads, Precomp, LandZone, Sectors and Mode. This information should be provided by your hard disk vendor or system manufacturer. However, we recommend you use the “IDE HDD Auto Detection” which provides a more efficient way to setup your hard drive.

**46 Predefined Drive Specifications:** Any given hard drive must be set to one specific drive type number. Please refer to your hard disk documentation for the appropriate type number.

**None:** If a hard drive is not installed, select <None> and press <Enter>.

### **Drive A and Drive B**

These options are used to select the type of floppy disk drives installed in your system. If neither drive is present, select “None”. Make sure you choose the correct drive type; otherwise, your system might format the device improperly.

### **Video**

This is used to select the type of video adapter installed in your system.

### **Halt on**

This category controls whether the system will halt when an error is detected during power up.





No Errors: The system boot will not stop for any detected errors.

All Errors: The system will stop whenever the BIOS detects a non-fatal error.

All, But Keyboard: The system will stop for any error except a keyboard error.

All, But Diskette: The system will stop for any error except a disk error.

All, But Disk/Key: The system will stop for any error except a keyboard or disk error.

### **Memory**

The lower right hand corner shows the base memory size, extended memory size, and the other memory size of your system. You cannot alter these items; your computer automatically detects and displays them.

The Other Memory size refers to the memory located in the 640K to 1024K address space. This is the memory used for different applications. DOS uses this area to load device drivers to free base memory for application programs.

When you are through making changes in the Standard CMOS Setup, press <Esc> to return to the main menu.

### **BIOS Features Setup**

Use the arrow keys to highlight "BIOS Features Setup" and press <Enter>, a screen similar to the one on the next page will appear.



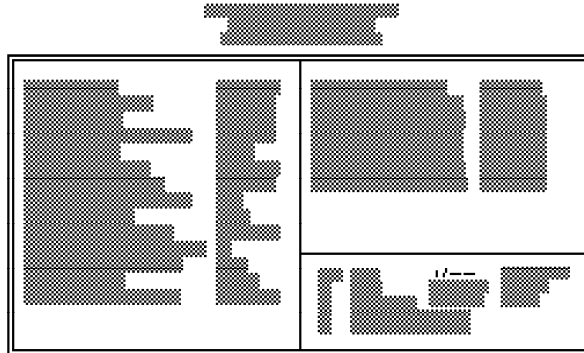
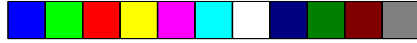

The Virus Warning option may be set to “Enabled” or “Disabled”. If enabled, the BIOS issues a warning when any program or virus sends a Disk Format command or attempts to write to the boot sector of the hard disk drive.

**Note:**

*If you are installing or running certain operating systems such as Windows 95, please disable the Virus Warning or the operating system may not install nor work.*

If you choose “System” in the Security Option, you will be prompted for a password every time you cold boot your system or access setup. If you choose “Setup”, you will be prompted for a password only when trying to access setup.

Use the arrow keys to move the highlight bar to the option you wish to change or modify. Use the <Page Up>, <Page Down>, <+> or <-> keys to make the corresponding changes. Press <Esc> after making the changes to return to the main menu.

### Chipset Features Setup

The G586IPC uses the Intel 82430HX chipset. The Chipset Features Setup allows you to modify some functions to optimize system performance. If you press <Enter>, a screen similar to the one on the next page will appear.

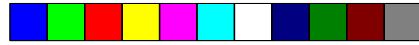

Use the arrow keys to move the highlight bar to the option you wish to change or modify. Use the <Page Up>, <Page Down>, <+> or <-> keys to make the corresponding changes.

If the changes you made are incorrect or you change your mind, press <F6> or <F7> to return to the default settings. Press <Esc> after making the changes to return to the main menu.

### Power Management Setup

Use the arrow keys to highlight "Power Management Setup" and press <Enter>. A screen similar to the one below will appear.



Choosing "Enabled" in the Power Management option will allow you to set Doze Mode, Standby Mode, Suspend Mode and HDD Power Down. Choose "Disabled" if you do not want your system to enter the power saving mode.

## PCI Configuration Setup

Use the arrow keys to highlight "PCI Configuration Setup" and press <Enter>; a screen similar to the one below will appear.

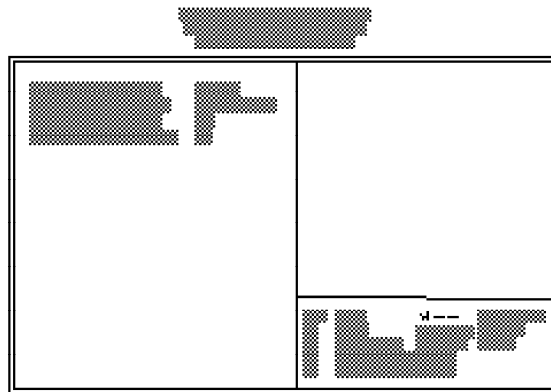

The PCI Configuration Setup allows you to assign INT A, B, C or D to the hard drives installed in your system. Each INT may then be assigned an IRQ value.

## Load BIOS Defaults

The "Load BIOS Defaults" option loads the troubleshooting default values permanently stored in the ROM chips. These settings are not optimal and turn off all high performance features. You should use these values only if you have hardware problems. Highlight this option on the main menu and press <Enter>. The message below will appear.

*Load BIOS Defaults (Y/N)? N*

If you want to proceed, press <Y> and the default settings will be loaded.

## Load Setup Defaults

The "Load Setup Defaults" option loads optimized settings from the BIOS ROM. Use the Setup default values as standard values for your system.





Highlight this option on the main menu and press <Enter>. The message below will appear.

*Load Setup Defaults (Y/N)? N*

Type <Y> and press <Enter> to load the Setup default values.

### **PnP Configuration Setup**

Use the arrow keys to highlight “PnP Configuration Setup” and press <Enter>. A screen similar to the one below will appear.

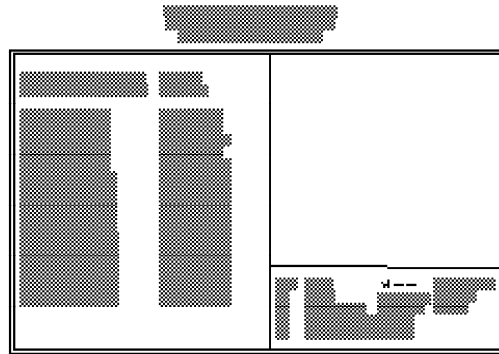

The default setting of the Resources Controlled By option is “Manual”. This will allow you to set the IRQ you have assigned your add-in card to Legacy ISA or PCI/ISA PnP (Plug and Play). For non-PnP ISA cards, select Legacy ISA. For PnP ISA or PCI cards, select PCI/ISA PnP.

If the Resources Controlled By option is set to “Auto”, the system will automatically detect the settings for you. IRQ 3 - IRQ 15 and DMA 0 - DMA 7 options will not be shown in the PnP Configuration Setup screen.

### **I/O Configuration Setup**

Use the arrow keys to highlight “I/O Configuration Setup” and press <Enter>. A screen similar to the one on the next page will appear.

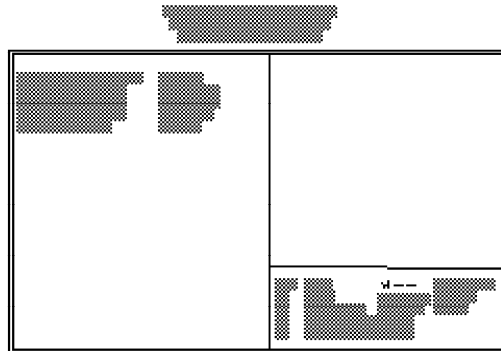

The I/O Configuration Setup allows you to enable, disable or select the port address of the built-in serial ports, parallel port and floppy disk controller.

### Supervisor Password

If you want to protect your system and setup from unauthorized entry, set a supervisor's password with the "System" option selected in the BIOS Features Setup.

If you want to protect access to setup only, but not your system, set a supervisor's password with the "Setup" option selected in the BIOS Features Setup. You will not be prompted for a password when you cold boot the system.

Use the arrow keys to highlight the "Supervisor Password" option and press <Enter>. The message below will appear.

*Enter Password:*

Type in the password. You are limited to eight characters. When done, the message below will appear:

*Confirm Password:*

You are asked to verify the password. Type in exactly the same password. If you type in a wrong password, you will be prompted to enter the correct password again.





To delete or disable the password function, highlight “Supervisor Password” and press <Enter>, instead of typing in a new password. Press the <Esc> key to return to the main menu.

If you forget your password, you should clear any previously set password by setting Jumper JP3 to On for approximately two minutes. Refer to the Jumper Settings for Password Clear on page 28 for more information.

### **User Password**

If you want another user to have access only to your system but not to setup, set a user’s password with the “System” option selected in the BIOS Features Setup.

If you want a user to enter a password when trying to access setup, set a user’s password with the “Setup” option selected in the BIOS Features Setup. Using user’s password to enter Setup allows a user to access only the “User Password” option that appears on the main screen. Access to all other options is denied.

To set, confirm, verify, disable or delete a user’s password, follow the procedures described in the section “Supervisor Password”. If you forget your password, refer to the procedure described in the same section.

### **IDE HDD Auto Detection**

This option detects the hard disk parameters for the hard disk drives installed in your system. Highlight this option and press <Enter>. A screen similar to the one on the next page will appear.

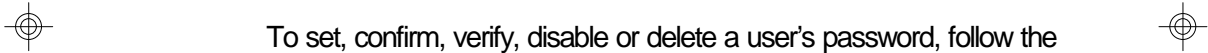

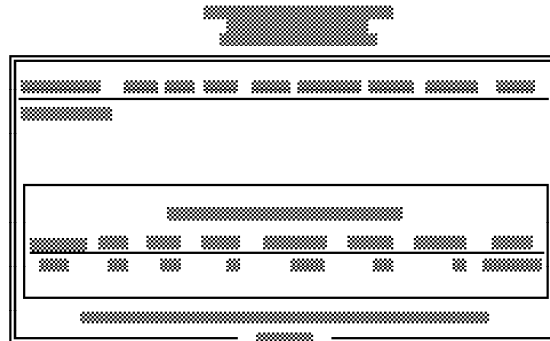
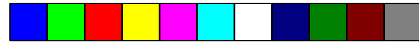

Enter your choice, and press <Enter> to accept the parameters or press <Esc> to abort. The parameters of the hard disk will be displayed in the Standard CMOS Setup.

### Hard Drive Mode

The G586IPC supports three HDD modes: Normal, LBA and Large. If your hard disk drive does not support LBA mode, the "LBA" option will not be displayed. If your HDD has 1024 or fewer cylinders, the "Large" option will not be displayed.

#### Normal Mode

The Normal mode is the generic access mode in which neither the BIOS nor the IDE controller will make any transformations during hard-drive access.

The maximum number of cylinders, heads and sectors for Normal mode are 1024, 16 and 63, respectively.

	no. Cylinders	(1024)
x	no. Heads	( 16)
x	no. Sectors	( 63)
x	bytes per sector	( 512)

---

528 megabytes

If you set your HDD to Normal mode, the maximum accessible HDD will be 528 megabytes even though the physical size of the HDD may be larger.



### LBA (Logical Block Addressing) Mode

The LBA mode is a HDD accessing method to overcome the 528 megabyte limitation. The number of cylinders, heads and sectors shown on the screen may not be the actual number for the HDD.

During the HDD accessing, the IDE controller will transform the logical address described by the sector, head and cylinder number into its own physical address inside the HDD.

The maximum HDD size supported by the LBA mode is 8.4 gigabytes. It is obtained by the following formula.

$$\begin{array}{r} \text{no. Cylinders} \quad (1024) \\ \times \text{no. Heads} \quad (225) \\ \times \text{no. Sectors} \quad (63) \\ \times \text{bytes per sector} \quad (512) \\ \hline 8.4 \text{ gigabytes} \end{array}$$

### Large Mode

The Large mode is the extended HDD access mode supported by the G5861PC system board. Some IDE HDDs have more than 1024 cylinders without LBA support (in some cases, you may not want the LBA mode). This system board provides another alternative to support these kinds of HDDs.

The BIOS tells the operating system that the number of cylinders is half of the actual number and that the number of heads is double the actual number. During disk access, the reverse conversion is done by the INT13h routine.

Example of Large mode:

CYLS.	HEADS	SECTORS	MODE
1120	16	59	NORMAL
560	32	59	LARGE



Maximum HDD size:

no. Cylinders	(1024)
x no. Heads	( 32)
x no. Sectors	( 63)
x bytes per sector	( 512)
<hr/>	
1 gigabyte	

**Note:**

To support LBA or Large mode, address translation software is included in the Award BIOS HDD Service Routine (INT13h). If you are running an operating system that bypasses the BIOS Int13 Service Routine, LBA and Large Mode may fail.

### Save & Exit Setup

When all the changes have been made, highlight “Save & Exit Setup” and press <Enter>. The message below will appear:

*Save to CMOS and Exit (Y/N)? N*

Type “Y” and press <Enter>. The following message will appear:

*Reboot System (Y/N)? N*

Type “Y” and press <Enter>. The modifications you have made will be written into the CMOS memory, and the system will reboot. You will once again see the initial diagnostics on the screen. If you wish to make additional changes to the setup, press <Ctrl>, <Alt> and <Esc> keys simultaneously or <Del> after memory testing is done.

### Exit Without Saving

When you do not want to save the changes you have made, highlight “Exit Without Saving” and press <Enter>. The message below will appear:

*Quit Without Saving (Y/N)? N*

Type “Y” and press <Enter>. The system will reboot and you will once again see the initial diagnostics on the screen. If you wish to make any changes to the setup, press <Ctrl>, <Alt> and <Esc> keys simultaneously or <Del> after memory testing is done.





## System Error Report

When the BIOS encounters an error that requires the user to correct something, either a beep code will sound or a message will be displayed in a box in the middle of the screen and the message **PRESS F1 TO CONTINUE, CTRL-ALT-ESC or DEL TO ENTER SETUP**, will be shown in the information box at the bottom. Enter Setup to correct the error.

### POST Beep

There is one beep code in the BIOS. This code indicates that a video error has occurred and the BIOS cannot initialize the video screen to display any additional information. This beep code consists of a single long beep followed by two short beeps. If you get this error, contact your system board dealer or representative.

### Error Messages

One or more of the following messages may be displayed if the BIOS detects an error during the POST.

#### **DISK BOOT FAILURE, INSERT SYSTEM DISK AND PRESS ENTER**

No boot device was found. Insert a system disk into Drive A and press <Enter>. If the system normally boots from the hard drive, make sure the controller is inserted correctly and all cables are properly attached. Also be sure the disk is formatted as a boot device. Reboot the system.

#### **DISKETTE DRIVES OR TYPES MISMATCH ERROR - RUN SETUP**

The type of diskette drive installed in the system is different from the CMOS definition. Run setup to reconfigure the drive type correctly.

#### **DISPLAY SWITCH IS SET INCORRECTLY**

The display switch on the system board can be set to either monochrome or color. This error indicates the switch is set to a different setting than indicated in Setup. Determine which setting is correct and either turn off the system and change the jumper or enter Setup and change the VIDEO selection.



#### **DISPLAY TYPE HAS CHANGED SINCE LAST BOOT**

Since last powering off the system, the display adapter has been changed. You must configure the system for the new display type.

#### **ERROR ENCOUNTERED INITIALIZING HARD DRIVE**

The hard drive cannot be initialized. Be sure all cables are correctly and firmly attached. Also, be sure the correct hard drive type is selected in Setup.

#### **ERROR INITIALIZING HARD DISK CONTROLLER**

The system cannot initialize the controller. Be sure the correct hard drive type is selected in Setup. Also, check to see if any jumper needs to be set correctly on the hard drive.

#### **FLOPPY DISK CNTRLR ERROR OR NO CNTRLR PRESENT**

The system cannot find or initialize the floppy drive controller. If no floppy drive is installed, be sure the Diskette Drive selection in Setup is set to NONE.

#### **KEYBOARD ERROR OR NO KEYBOARD PRESENT**

Cannot initialize the keyboard. Make sure the keyboard is attached correctly and no keys are being pressed during the boot.

If you are purposely configuring the system without a keyboard, set the error halt condition in Setup to HALT ON ALL, BUT KEYBOARD. This will cause the BIOS to ignore the missing keyboard and continue the boot.

#### **MEMORY ADDRESS ERROR AT..**

Indicates a memory address error at a specific location. You can use this location along with the memory map for your system to find and replace the bad memory chips.

#### **MEMORY SIZE HAS CHANGED SINCE LAST BOOT**

Memory has been added or removed since the last boot. Enter Setup and enter the new memory size in the memory fields.

#### **MEMORY VERIFY ERROR AT..**

Indicates an error verifying a value already written to memory. Use the location along with your system's memory map to locate the bad chip.





#### **OFFENDING ADDRESS NOT FOUND**

This message is used in conjunction with the I/O CHANNEL CHECK and RAM PARITY ERROR messages when the segment that has caused the problem cannot be isolated.

#### **OFFENDING SEGMENT**

This message is used in conjunction with the I/O CHANNEL CHECK and RAM PARITY ERROR messages when the segment that has caused the problem has been isolated.

#### **PRESS A KEY TO REBOOT**

This will be displayed at the bottom screen when an error occurs that requires a reboot. Press any key and the system will reboot.

#### **SYSTEM HALTED, (CTRL-ALT-DEL) TO REBOOT...**

Indicates the present boot attempt has been aborted and the system must be rebooted. Press and hold down the <CTRL>, ALT and <DEL> keys simultaneously.

### **IDE Device Drivers**

To install the IDE device drivers supported by the G586IPC system board, please refer to the "Readme" file contained in the provided diskette.



## Chapter 4 Troubleshooting Checklist

---

If you experience difficulty with the G586IPC system board, please refer to the checklist below. If you still cannot identify the problem, please contact your dealer.

1. Check the jumper settings to ensure that the jumpers are properly set. If in doubt, refer to the "Hardware Installation" section.
2. Verify that all SIMMs are seated securely into the bank sockets.
3. Make sure the SIMMs are in the correct locations.
4. Check that all populated memory banks are filled with correctly sized SIMMs.
5. If your board fails to function, place the board on a flat surface and seat all socketed components (gently press each component into the socket).
6. If you made changes to the BIOS settings, re-enter setup and load the BIOS defaults.

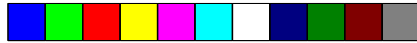

## Appendix A Types of Modules

---

The G586IPC system board allows you to populate memory with 1MBx36, 2MBx36, 4MBx36, 8MBx36, and 16MBx36 SIMMs. The following modules have been tested with this board. Most untested brands will work but a few may fail to do so.

SIMM	Brand	Chip Number
1MBx36	Fujitsu	81C1000A-70
	Hyundai	HY514400A
	Toshiba	TC511000AJL
	OKI	M51440A-70
2MBx36	OKI	M511000B-70
	NEC	424400-60
	Micron	40447-60
	TI	TMS4400DJ-70
	Micron	MT4C4007-70 (EDO)
	Micron	MT4C4007-60 (EDO)
4MBx36	Hitachi	7400AS-70
	Fujitsu	8117400-70
	Mitsubishi	422A06-70
	Hitachi	5117400AS-70
	NEC	4217400-60
	NEC	4217405-70 (EDO)



## Appendix B Memory and I/O Maps

---

### Memory Address Map

Address	Name	Function
0000000 to 009FFFF	640KB System Board RAM	System Board Memory
00A0000 to 00BFFFF	128KB Video Display Memory	Reserved for Graphics Display Memory
00C0000 to 00E7FFF	160KB I/O Expansion ROM	Reserved for ROM on I/O Adapter Card
00E8000 to 00FFFFFF	96KB ROM on the System Board	System Board BIOS
0100000 to 7FFFFFFF	Maximum Memory 128MB	System Board Memory

---

## IO Address Map

IO Address	Function
000-01F	DMA Controller 1, 8237A-5
020-03F	Interrupt Controller 1, 8259A, Master
040-05F	Timer, 8254-2
060-06F	8742 (Keyboard Controller)
070-07F	Real-time Clock, NMI (Non-maskable Interrupt) Mask
080-09F	DMA Page Memory, 74LS612
0A0-0BF	Interrupt Controller 2, 8259A
0C0-0DF	DMA Controller 2, 8237A-5
0E8	Shadow RAM and Cache Control Bit
0F0	Clear Numeric Processor Extension Busy
0F1	Reset Numeric Processor Extension
0F8-0FF	Numeric Processor Extension
1F0-1F8	Fixed Disk
200-207	Game I/O
278-27F	Parallel Printer Port 2
2F8-2FF	Serial Port 2
300-31F	Prototype Card
360-36F	Reserved
378-37F	Parallel Printer Port 1
380-38F	SDLC, Bisynchronous 2
3A0-3AF	Bisynchronous 1
3B0-3BF	Monochrome Display and Printer Adapter
3C0-3CF	Reserved
3D0-3DF	Color/Graphics Monitor Adapter
3F0-3F7	Diskette Controller
3F8-3FF	Serial Port 1

**Note:**

*The I/O address hex 000 to 0FF are reserved for the system board I/O.  
Hex 100 to 3FF are available on the I/O channels.*

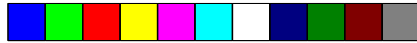

## Appendix C PCI I/O Pin Assignments

Component Side	B	A	Solder Side
	-12V	- 01 -	TRST#
	TCK	- 02 -	+12V
	Ground	- 03 -	TMS
	TDO	- 04 -	TDI
	+5V	- 05 -	+5V
	+5V	- 06 -	INTA#
	INTB#	- 07 -	INTC#
	INTD#	- 08 -	+5V
	PRSNT1#	- 09 -	Reserved
	Reserved	- 10 -	+5V (I/O)
	PRSNT2#	- 11 -	Reserved
	Ground	- 12 -	Ground
	Ground	- 13 -	Ground
	Reserved	- 14 -	Reserved
	Ground	- 15 -	RST#
	CLK	- 16 -	+5V (I/O)
	Ground	- 17 -	GNT#
	REQ#	- 18 -	Ground
	+5V (I/O)	- 19 -	Reserved
	AD[31]	- 20 -	AD[30]
	AD[29]	- 21 -	N. C.
	Ground	- 22 -	AD[28]
	AD[27]	- 23 -	AD[26]
	AD[25]	- 24 -	Ground
	N. C.	- 25 -	AD[24]
	C/BE[3]#	- 26 -	IDSEL
	AD[23]	- 27 -	N. C.
	Ground	- 28 -	AD[22]
	AD[21]	- 29 -	AD[20]
	AD[19]	- 30 -	Ground
	N. C.	- 31 -	AD[18]
	AD[17]	- 32 -	AD[16]
	C/BE[2]#	- 33 -	N. C.
	Ground	- 34 -	FRAME#
	IRDY#	- 35 -	Ground
	N. C.	- 36 -	TRDY#
	DEVSEL#	- 37 -	Ground
	Ground	- 38 -	STOP#
	LOCK#	- 39 -	N. C.
	PERR#	- 40 -	SDONE
	N. C.	- 41 -	SBO#
	SERR#	- 42 -	Ground
	N. C.	- 43 -	PAR
	C/BE[1]#	- 44 -	AD[15]
	AD[14]	- 45 -	N. C.
	Ground	- 46 -	AD[13]
	AD[12]	- 47 -	AD[11]
	AD[10]	- 48 -	Ground
	Ground	- 49 -	AD[09]
	AD[08]	- 52 -	C/BE[0]#
	AD[07]	- 53 -	N. C.
	N. C.	- 54 -	AD[06]
	AD[05]	- 55 -	AD[04]
	AD[03]	- 56 -	Ground
	Ground	- 57 -	AD[02]
	AD[01]	- 58 -	AD[00]
	+5V (I/O)	- 59 -	+5V (I/O)
	ACK64#	- 60 -	REQ64#
	+5V	- 61 -	+5V
	+5V	- 62 -	+5V

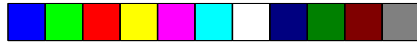

## Appendix D ISA I/O Pin Assignments

B	- 01 -	A
Grnd	- 02 -	-I/OChck
ResetDrv	- 03 -	SD7
+5VDC	- 04 -	SD6
IRQ9	- 05 -	SD5
-5VDC	- 06 -	SD4
DRQ2	- 07 -	SD3
-12VDC	- 08 -	SD2
O/S	- 09 -	SD1
+12VDC	- 10 -	SD0
Grnd	- 11 -	-I/OChrdy
-SEMEMV	- 12 -	AEN
-SEMEMR	- 13 -	SA19
-IOW	- 14 -	SA18
-IOR	- 15 -	SA17
-Dack3	- 16 -	SA16
-DRQ3	- 17 -	SA15
-Dack1	- 18 -	SA14
DRQ1	- 19 -	SA13
-Refresh	- 20 -	SA12
CLK	- 21 -	SA11
IRQ7	- 22 -	SA10
IRQ6	- 23 -	SA9
IRQ5	- 24 -	SA8
IRQ4	- 25 -	SA7
IRQ3	- 26 -	SA6
-Dack2	- 27 -	SA5
TC	- 28 -	SA4
Bale	- 29 -	SA3
+5VDC	- 30 -	SA2
O/S	- 31 -	SA1
Grnd		SA0

D	- 01 -	C
-MemCS16	- 02 -	SBHE
-I/OCS16	- 03 -	LA23
IRQ10	- 04 -	LA22
IRQ11	- 05 -	LA21
IRQ12	- 06 -	LA20
IRQ13	- 07 -	LA19
IRQ14	- 08 -	LA18
-Dack0	- 09 -	LA17
DRQ0	- 10 -	-Memr
-Dack5	- 11 -	-Memw
DRQ5	- 12 -	SD08
-Dack6	- 13 -	SD09
DRQ6	- 14 -	SD10
-Dack7	- 15 -	SD11
DRQ7	- 16 -	SD12
+5VDC	- 17 -	SD13
-Master	- 18 -	SD14
Grnd		SD15

## Appendix E System Overview

---

DMA Controller 1	DMA Controller 2
Ch0-Reserved for User	Ch4-Cascade for CTRL 1
Ch1-Reserved for User	Ch5-Reserved for User
Ch2-Diskette	Ch6-Reserved for User
Ch3-Reserved for User	Ch7-Reserved for User

**Note:**

*DMA controller 1 supports 8-bit data transfer.*

*DMA controller 2 supports 16-bit data transfer.*

### Address Generation for DMA Channels 3 to 0

Source Address	DMA Page Memory	DMA Controller 1
	A23 ↔ A16	A15 ↔ A0

### Address Generation for DMA Channels 7 to 5

Source Address	DMA Page Memory	DMA Controller 2
	A23 ↔ A17	A16 ↔ A1

### Page Memory Address

IO Port Address	Page Memory
0081H	DMA Channel 2
0082H	DMA Channel 3
0083H	DMA Channel 1
0087H	DMA Channel 0
0089H	DMA Channel 6
008AH	DMA Channel 7
008BH	DMA Channel 5



## System Interrupts

Interrupt Controller 1	Interrupt Controller 2
IRQ0-Timer Output (Out 0)	IRQ9-Software Redirected to INT 0AH (IRQ2)
IRQ1-KeyBoard (Output Buffer Full)	IRQ10-Reserved
IRQ2-Interrupt from INTR2	IRQ11-Reserved
IRQ3-Serial Port 2	IRQ12-PS/2 Mouse
IRQ4-Serial Port 1	IRQ13-Coprocessor
IRQ5-Parallel Port 2 or 3 *	IRQ14-Primary Fixed Disk Controller (1F0)
IRQ6-Diskette Controller	IRQ15-Secondary Fixed Disk Controller (170)
IRQ7-Parallel Port 1 or 2 *	
IRQ8-Realtime Clock INT	

\* The one on-board parallel port can be configured to either Parallel Port 1, 2 or 3. Parallel Port 1 uses I/O address 3BCh, Parallel Port 2 uses I/O address 378h, and Parallel Port 3 uses I/O address 278H.

### Note:

The 16 levels of system interrupts have the following priority: IRQ0> IRQ1> IRQ8> IRQ9> IRQ10> IRQ11> IRQ12> IRQ13> IRQ14> IRQ15> IRQ3> IRQ4> IRQ5> IRQ6> IRQ7.

## System Timers

Channel 0	Channel 1	Channel 2
System Timer (IRQ0)	Refresh Request Generator (15µs Rate Generator Period Signal)	Tone Generation for Speaker

## Real-Time Clock

Address	Function	Address	Function
00	Seconds	07	Date of Month
01	Second Alarm	08	Month
02	Minutes	09	Year
03	Minute Alarm	0A	Register A
04	Hours	0B	Register B
05	Hour Alarm	0C	Register C
06	Day of Week	0D	Register D

## Appendix F Connector Pin Assignments

---

### Connector J1 PS/2 Mouse Connector

Pin	Function
1	Mouse Data
2	Reserved
3	Ground
4	+5V
5	Mouse Clock
6	Reserved

### J2 (COM1) and J3 (COM2) COM 1 and COM 2 Serial Ports

Pin	Function
1	DCD (Data Carrier Detect)
2	RX (Receive Data)
3	TX (Transmit Data)
4	DTR (Data Terminal Ready)
5	Ground (Signal Ground)
6	DSR (Data Set Ready)
7	RTS (Request to Send)
8	CTS (Clear to Send)
9	RI (Ring Indicator)

### Connector J4 Floppy Disk Drive Connector

Pin	Function	Pin	Function
1	Ground	11	Ground
2	DENSEL	12	DR1
3	Ground	13	Ground
4	Reserved	14	DR0
5	Ground	15	Ground
6	Drate0	16	MTR1
7	Ground	17	Drate1
8	Index	18	Dir
9	Ground	19	Ground
10	MTR0	20	Step

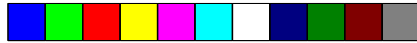

Pin	Function
21	Ground
22	Write Data
23	Ground
24	Write Gate
25	Ground
26	Track 0
27	MSEN

Pin	Function
28	Wr Protect
29	Ground
30	Read Data
31	Ground
32	Head Select
33	Ground
34	Disk Change

**Connector J5**  
Parallel Printer Port

Pin	Function
1	-Strobe
2	Data 0
3	Data 1
4	Data 2
5	Data 3
6	Data 4
7	Data 5
8	Data 6
9	Data 7
10	-Ack
11	Busy
12	Paper Empty
13	Select

Pin	Function
14	-Autofd
15	-Error
16	-Init
17	-Slctin
18	Ground
19	Ground
20	Ground
21	Ground
22	Ground
23	Ground
24	Ground
25	Ground

**Connectors J6 and J7**  
Primary and Secondary IDE Hard Disk Drive Connectors

Pin	Function
1	-Reset
2	Ground
3	D7
4	D8
5	D6
6	D9
7	D5
8	D10
9	D4
10	D11
11	D3
12	D12
13	D2
14	D13

Pin	Function
15	D1
16	D14
17	D0
18	D15
19	Ground
20	Reserved
21	Reserved
22	Ground
23	-IOW
24	Ground
25	-IOR
26	Ground
27	Reserved
28	BALE

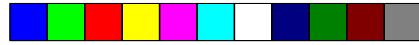

Pin	Function
29	Reserved
30	Ground
31	IRQ
32	IOCS16
33	SA1
34	Reserved
35	SA0
36	SA2
37	HCS0
38	HCS1
39	LED
40	Ground

**Connector J8**  
Fan Connector

Pin	Function
1	Ground
2	+12V
3	Ground

**Connector J10**  
Primary/Secondary IDE LED Connector

Pin	Function
1	Signal
2	VCC

**Connector J11**  
Green LED Connector

Pin	Function
1	Signal
2	VCC

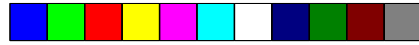

**Connector J13**  
Green Button Connector

Pin	Function
1	Ground
2	Signal

**Connector J14**  
Reset Switch Connector

Pin	Function
1	Ground
2	Reset

**Connector J15**  
Speaker Connector

Pin	Function
1	Signal
2	Reserved
3	Ground
4	VCC

**Connector J16**  
Power LED/Keylock Connector

Pin	Function
1	LED Signal
2	Reserved
3	Ground
4	Keylock Signal
5	Ground

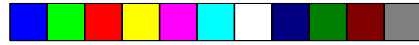

**Connector CN1**  
PS/2 Keyboard Connector

Pin	Function
1	Keyboard Data
2	Reserved
3	Ground
4	+5V
5	Keyboard Clock
6	Reserved

**Connector CN2**  
AT Keyboard Connector

Pin	Function
1	Keyboard Clock
2	Keyboard Data
3	Reserved
4	Ground
5	+5V

**Connector PL1**  
Power Connector

Pin	Function
1	Power Good
2	+5V
3	+12V
4	-12V
5	Ground
6	Ground
7	Ground
8	Ground
9	-5V
10	+5V
11	+5V
12	+5V

**Connector SSM1**  
Cache Module Slot

Pin	Function	Pin	Function
1	Ground	47	D48
2	TIO0	48	Ground
3	TIO2	49	D46
4	TIO6	50	D44
5	TIO4	51	D42
6	TIO8	52	VCC3
7	VCC3	53	D40
8	TWE#	54	D38
9	CADS#/CAA3	55	D36
10	Ground	56	Ground
11	HBE4#	57	D34
12	HBE6#	58	D32
13	HBE0#	59	D30
14	HBE2#	60	VCC3
15	VCC3	61	D28
16	CCS#/CAB4	62	D26
17	GVE#	63	D24
18	BWE#	64	Ground
19	Ground	65	D22
20	A3	66	D20
21	A7	67	D18
22	A5	68	VCC3
23	A11	69	D16
24	A16	70	D14
25	VCC3	71	D12
26	A18	72	Ground
27	Ground	73	D10
28	A12	74	D8
29	A13	75	D6
30	ADSP#	76	VCC3
31	ECS1#/(CS#)	77	D4
32	ECS2#	78	D2
33	PD1	79	D0
34	PD3	80	Ground
35	Ground	81	Ground
36	CLK1	82	TIO1
37	Ground	83	TIO7
38	D62	84	TIO5
39	VCC3	85	TIO3
40	D60	86	TIO9
41	D58	87	VCC5
42	D56	88	TIO10
43	Ground	89	CADV#/CAA4
44	D54	90	Ground
45	D52	91	COE#
46	D50	92	HBE5#



Pin	Function	Pin	Function
93	HBE7#	127	D49
94	HBE1#	128	Ground
95	VCC5	129	D47
96	HBE3#	130	D45
97	CAB3	131	D43
98	CALE	132	VCC5
99	Ground	133	D41
100	RSVD	134	D39
101	A4	135	D37
102	A6	136	Ground
103	A8	137	D35
104	A10	138	D33
105	VCC5	139	D31
106	A17	140	VCC5
107	Ground	141	D29
108	A9	142	D27
109	A14	143	D25
110	A15	144	Ground
111	RSVD	145	D23
112	PD0	146	D21
113	PD2	147	D19
114	PD4	148	VCC5
115	Ground	149	D17
116	CLK0	150	D15
117	Ground	151	D13
118	F63	152	Ground
119	VCC5	153	D11
120	D61	154	D9
121	D59	155	D7
122	D57	156	VCC5
123	Ground	157	D5
124	D55	158	D3
125	D53	159	D1
126	D51	160	Ground