

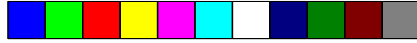

# **G586PC**

**Rev. D+**  
**System Board**  
**User's Manual**





## FCC Statement on Class B

This equipment has been tested and found to comply with the limits for a Class B digital device, pursuant to Part 15 of the FCC rules. These limits are designed to provide reasonable protection against harmful interference when the equipment is operated in a residential installation. This equipment generates, uses and can radiate radio frequency energy and, if not installed and used in accordance with the instruction manual, may cause harmful interference to radio communications. However, there is no guarantee that interference will not occur in a particular installation. If this equipment does cause harmful interference to radio or television reception, which can be determined by turning the equipment off and on, the user is encouraged to try to correct the interference by one or more of the following measures:

- Reorient or relocate the receiving antenna.
- Increase the separation between the equipment and the receiver.
- Connect the equipment into an outlet on a circuit different from that to which the receiver is connected.
- Consult the dealer or an experienced radio TV technician for help.

### Notice:

1. The changes or modifications not expressly approved by the party responsible for compliance could void the user's authority to operate the equipment.
2. Shielded interface cables must be used in order to comply with the emission limits.

The manufacturer makes no warranties with respect to this documentation and disclaims any implied warranties of merchantability, quality, or fitness for any particular purpose. The information in this document is subject to change without notice. The manufacturer reserves the right to make revisions to this publication and to make changes to any and/or all parts of its content, at any time, without obligation to notify any person or entity of such changes. Further, the manufacturer assumes no responsibility for any errors that may appear in this document.



## Table of Contents

<b>Chapter 1: Introduction .....</b>	<b>5</b>
Features and Specifications .....	6
Package Checklist .....	8
<b>Chapter 2: Hardware Installation .....</b>	<b>9</b>
Preparing the Area .....	9
Handling the System Board .....	9
Installing the System Board .....	10
Board Layout .....	12
System Memory .....	13
Installing a SIM Module .....	15
Cache Memory .....	15
Installing the Cache Module .....	16
CPU Installation .....	16
Jumper Settings for Intel CPUs .....	17
Jumper Settings for Cyrix CPUs .....	18
Jumper Settings for AMD-K5 CPUs .....	19
Installing Upgrade CPUs .....	20
Installing Fan/Heatsink for Cyrix CPUs .....	22
Jumper Settings for CMOS Clear .....	23
Jumper Settings for Display .....	23
Built-in Ports .....	24
Serial Ports .....	24
PS/2 Mouse Port .....	24
Parallel Port .....	25
Floppy Disk Drive Controller .....	25
IDE Hard Disk Interface .....	26
Universal Serial Bus Connectors .....	28
Installing Expansion Cards .....	29
<b>Chapter 3: Software Installation .....</b>	<b>30</b>
Award BIOS CMOS Setup Utility .....	30
Standard CMOS Setup .....	31
BIOS Features Setup .....	35
Chipset Features Setup .....	39
Power Management Setup .....	40
PNP/PCI Configuration Setup .....	42
Load BIOS Defaults .....	44

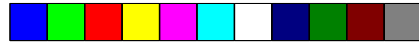

Load Setup Defaults .....	44
Integrated Peripherals .....	45
Supervisor Password .....	47
User Password .....	48
IDE HDD Auto Detection .....	48
HDD Low Level Format .....	51
Save & Exit Setup .....	52
Exit Without Saving .....	52
Desktop Management Interface (DMI) .....	52
System Error Report .....	56
Driver Installation .....	57

**Chapter 4: Troubleshooting Checklist ..... 58**

**Appendix A: Types of Modules ..... 62**

**Appendix B: Memory and I/O Maps ..... 63**

**Appendix C: Connectors ..... 65**



## Chapter 1 Introduction

---

The G586IPC, equipped with a 321-pin Zero Insertion Force (ZIF) CPU socket, is a Pentium processor-class system board supporting Intel Pentium® processor with MMX™ technology - 166/200MHz and Intel Pentium® processors running at 75MHz, 90MHz, 100MHz, 120MHz, 133MHz, 150MHz, 166MHz and 200MHz frequencies. The G586IPC also supports Cyrix® 6x86™ PR120+/PR133+/PR150+/PR166+ and AMD-K5™ PR75/PR90/PR100/PR120/PR133 processors.

The G586IPC supports 8MB to 256MB of system memory using EDO or fast page mode DRAM. It is equipped with 4 SIMM sockets allowing you to install x32 or x36 SIMMs. The x36 SIMM supports parity checking which informs the user of memory failure and prevents error accumulation. The system board also supports 256KB or 512KB pipeline burst SRAM and provides easy cache upgrades using a 256KB cache module.

The G586IPC design is based on the Peripheral Component Interconnect (PCI) local bus and Industry Standard Architecture (ISA) standards. It is equipped with 3 dedicated PCI slots, 3 dedicated 16-bit ISA slots and 1 shared PCI/ISA slot.

The G586IPC board has two bus master PCI IDE connectors. Bus mastering reduces CPU use during disk transfer. This system board is also equipped with two NS16C550A-compatible serial ports, an SPP/ECP/EPP parallel port, a floppy disk drive controller, one PS/2 mouse port, one PS/2 or AT keyboard connector, two connectors for external USB ports and one IrDA header for wireless connectivity between your computer and peripheral devices.

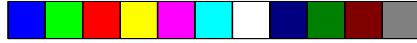

## Features and Specifications

### Processor

- Intel Pentium® processor with MMX™ technology - 166/200MHz
- Intel Pentium® 75/90/100/120/133/150/166/200MHz
- Future Pentium® OverDrive processor
- Cyrix® 6x86™ PR120+/PR133+/PR150+/PR166+
- AMD-K5™ PR75/PR90/PR100/PR120/PR133

### Chipset

- Intel® 82430HX PCIsset

### Cache Memory

- 256KB or 512KB pipeline burst, direct map write-back cache installed on the system board
  - Onboard 256KB: upgradeable with a 256KB cache module for a maximum of 512KB cache
  - Onboard 512KB: maximum cache memory (no cache module slot)

### System Memory

- 8MB to 256MB memory
- Four 72-pin SIMM sockets
- Uses EDO or fast page mode x32 or x36 DRAM, 60 or 70ns, 5V
- ECC and parity check supported (using x36 DRAM)

### BIOS

- Award BIOS, Windows® 95 Plug and Play compatible
- Flash EPROM for easy BIOS upgrades
- Supports DMI function

### Energy Efficient Design

- System power management supported
- CPU stopped clock control
- Hardware supports SMI green mode
- Microsoft®/Intel® APM 1.2 compliant
- External power management switch supported



### **PCI IDE Interface**

- PIO Mode 3 and Mode 4 Enhanced IDE (data transfer rate up to 16.6MB/sec.)
- DMA Mode 2 Bus Master IDE (data transfer rate up to 22.2MB/sec.)
- Bus mastering reduces CPU utilization during disk transfer
- ATAPI IDE CD-ROM supported

### **Integrated I/O**

- SMC super I/O controller
- Two NS16C550A-compatible high speed UARTs
- One SPP/ECP/EPP parallel port
- Supports 360KB, 720KB, 1.2MB, 1.44MB, and 2.88MB floppy drives

### **CPU Socket**

- 321-pin ZIF socket (Intel® Socket 7)

### **Connectors**

- 2 connectors for external USB (Universal Serial Bus) ports
- 1 connector for IrDA interface
- 2 serial ports
- 1 parallel port
- 2 IDE connectors
- 1 floppy connector
- 1 PS/2 mouse port
- 1 PS/2 or AT keyboard port

### **Expansion Slots**

- 3 dedicated PCI slots
- 3 dedicated 16-bit ISA slots
- 1 shared PCI/ISA slot

### **PCB**

- 4 layers, Baby AT form factor
- 25cm (9.84") x 22cm (8.66")



## Package Checklist

The G586IPC package contains the following items:

- The G586IPC system board
- The G586IPC user's manual
- Serial, mouse and printer port cables
  - Option 1:
    - One card-edge bracket with a 9-pin and 25-pin serial port cables
    - One card-edge bracket with a 25-pin printer port cable and a PS/2 mouse port cable
  - Option 2:
    - One card-edge bracket with two 9-pin serial port cables and a PS/2 mouse port cable
    - One 25-pin printer port cable for chassis mounting
- One 40-pin IDE hard disk cable
- One 34-pin floppy disk drive cable
- One IDE driver diskette
- Five spare jumpers
- One card-edge bracket with two USB port cables (optional)
- Cache module (optional)

If any of these items are missing or damaged, please contact your dealer or sales representative for assistance.





## Chapter 2 Hardware Installation

---

This chapter summarizes the steps to install the G586IPC system board into your system unit. It also includes a description of the area in which you must work and directions for memory installation. Before installing the system board, obtain the memory you plan to install. Refer to the System Memory section for the number and type of SIM modules needed for the amount of memory you require.

### Preparing the Area

Before unpacking the system board, make sure the location you have selected is relatively free of dust and static electricity. Excessive exposure to dust, static electricity, direct sunlight, excessive humidity, extreme cold, and water can damage the operational capabilities of your system board. Avoid placing the unit on surfaces such as carpeted floors. These areas attract static electricity which can damage circuits on your system board.

Make sure the power source has a properly grounded, three-pronged socket. It is essential that the power connection be properly grounded for correct functioning of your system board. For further protection, we recommend that you use a surge suppressor. This will protect the system board from damage that may result from a power surge on the electrical line.

Move items that generate magnetic fields away from your system board since magnetic fields can also damage your system board. Once you have selected the ideal location, unpack the G586IPC system board carefully.

### Handling the System Board

It is quite easy to inadvertently damage your system board even before installing it in your system unit. Static electrical discharge can damage computer components without causing any signs of physical damage. You must take extra care in handling the system board to ensure against electrostatic build-up.



## Static Electricity Precautions

1. To prevent electrostatic build-up, leave the board in its anti-static bag until you are ready to install it.
2. Wear an antistatic wrist strap.
3. Do all preparation work on a static-free surface with the system board components facing up.
4. Hold the system board only by its edges. Be careful not to touch any of the components, contacts or connections, especially gold contacts, on the board.
5. Avoid touching the pins or contacts on all modules and connectors. Hold modules and connectors by their ends.

### **Warning:**

*Electrostatic discharge (ESD) can damage your processor, disk drives, add-in boards, and other components. Perform the upgrade instruction procedures described at an ESD workstation only. If such a station is not available, you can provide some ESD protection by wearing an anti-static wrist strap and attaching it to a metal part of the system chassis. If a wrist strap is unavailable, establish and maintain contact with the system chassis throughout any procedures requiring ESD protection.*

## Installing the System Board

If you are installing the G586IPC system board, the following outlines the basic installation steps. Before installing the system board into your system unit, you should prepare the tools you will need.

You will need:

- One medium size, flat-bladed screwdriver
- One medium Phillips screwdriver
- One needle-nosed pliers
- One nutdriver

1. Unlock your system unit. Turn off the power and disconnect all power cords and cables.



2. Remove the system unit cover. Refer to the manufacturer's instructions if necessary.
3. Detach all connectors from the old system board and remove expansion cards seated in any of the expansion slots.
4. Loosen the screws holding the original system board and remove the board from the system. Save the screws.
5. Remove the G586IPC from its original packing box. Be careful to avoid touching all connectors and pins on the board. Please refer to the handling instructions on pages 9-10 for proper handling techniques.
6. Insert the SIMMs into the SIMM banks on the G586IPC. The quantity and location of the SIMMs depends on the memory configuration and type of modules you intend to use.
7. Insert the cache module, if any, into the cache module slot on the G586IPC. Refer to the Cache Memory section for upgrading your cache memory.
8. Install the CPU. Be sure pin 1 of the CPU is aligned with pin 1 of the socket.
9. Set the corresponding jumpers.
10. Install the prepared G586IPC system board into the case and replace the screws.
11. Reinstall all cards and connectors and replace the system unit cover. Reconnect all power cords and cables.



# Board Layout

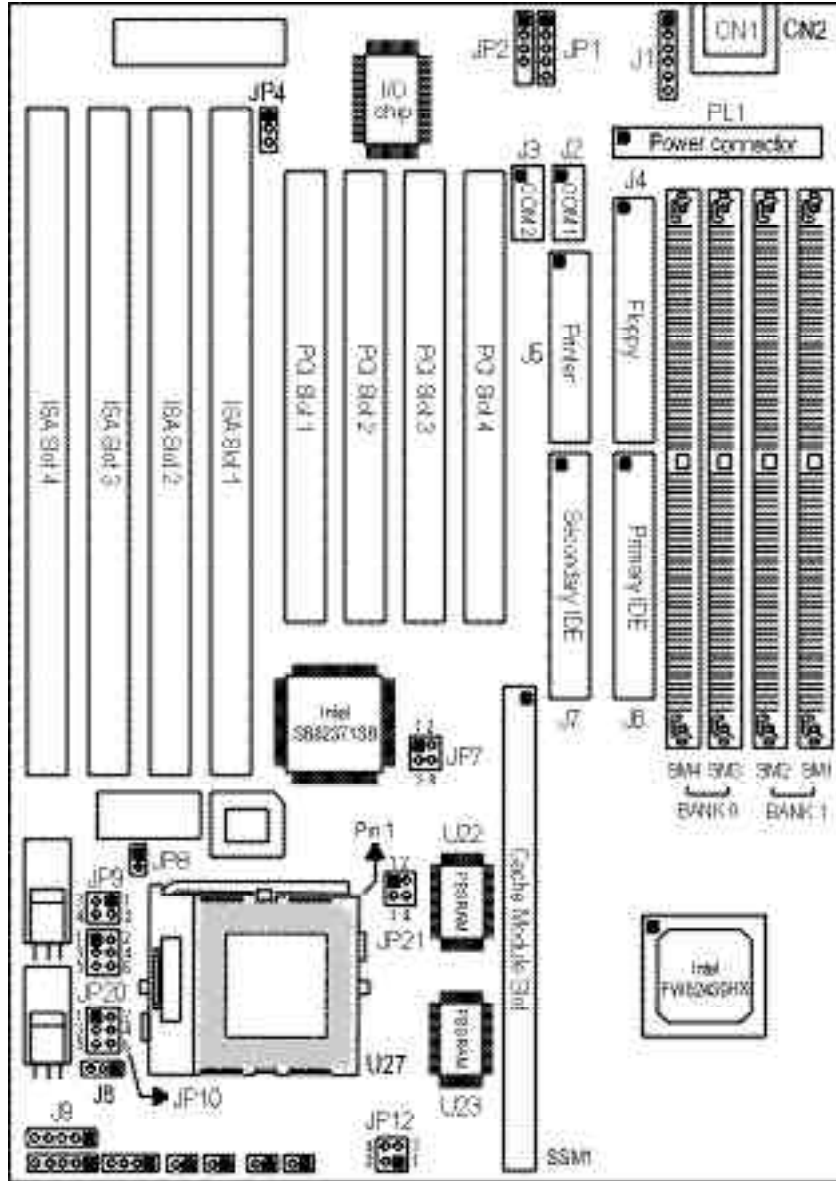

J16 J15 J14 J13 J11 J10

■ square denotes pin 1

## System Memory

The SIMM (Single In-line Memory Module) sockets are divided into two banks on the system board, Bank 0 and Bank 1. Each bank consists of 2 SIMM sockets. Refer to page 12 for the locations of the SIMM sockets.

You will need either 2 or 4 pieces of SIM modules, depending on the amount of memory you intend to install. Make sure you insert the same type of SIMMs in one bank. You can install SIMMs in either of the banks, Bank 0 or Bank 1, but you must populate one bank first before going to the next bank.

The G586IPC system board can support 8MB to 256MB of memory using 1MBx32/x36, 2MBx32/x36, 4MBx32/x36, 8MBx32/x36, or 16MBx32/x36 72-pin SIMMs. The table below shows the supported SIM modules and their corresponding memory sizes.

SIMMs	Memory Size
1MBx32/x36	4MB
2MBx32/x36	8MB
4MBx32/x36	16MB
8MBx32/x36	32MB
16MBx32/x36	64MB

The table below summarizes the bank locations and modules needed for the corresponding memory sizes.

Memory Size	Bank0		Bank1	
	SIMM3	SIMM4	SIMM1	SIMM2
8MB	1MBx32/x36	1MBx32/x36	—	—
8MB	—	—	1MBx32/x36	1MBx32/x36
16MB	2MBx32/x36	2MBx32/x36	—	—
16MB	—	—	2MBx32/x36	2MBx32/x36
16MB	1MBx32/x36	1MBx32/x36	1MBx32/x36	1MBx32/x36
24MB	1MBx32/x36	1MBx32/x36	2MBx32/x36	2MBx32/x36
24MB	2MBx32/x36	2MBx32/x36	1MBx32/x36	1MBx32/x36



Memory Size	Bank0		Bank1	
	SIMM3	SIMM4	SIMM1	SIMM2
32MB	4MBx32/x36	4MBx32/x36	—	—
32MB	—	—	4MBx32/x36	4MBx32/x36
32MB	2MBx32/x36	2MBx32/x36	2MBx32/x36	2MBx32/x36
40MB	1MBx32/x36	1MBx32/x36	4MBx32/x36	4MBx32/x36
40MB	4MBx32/x36	4MBx32/x36	1MBx32/x36	1MBx32/x36
48MB	2MBx32/x36	2MBx32/x36	4MBx32/x36	4MBx32/x36
48MB	4MBx32/x36	4MBx32/x36	2MBx32/x36	2MBx32/x36
64MB	8MBx32/x36	8MBx32/x36	—	—
64MB	—	—	8MBx32/x36	8MBx32/x36
64MB	4MBx32/x36	4MBx32/x36	4MBx32/x36	4MBx32/x36
72MB	1MBx32/x36	1MBx32/x36	8MBx32/x36	8MBx32/x36
72MB	8MBx32/x36	8MBx32/x36	1MBx32/x36	1MBx32/x36
80MB	2MBx32/x36	2MBx32/x36	8MBx32/x36	8MBx32/x36
80MB	8MBx32/x36	8MBx32/x36	2MBx32/x36	2MBx32/x36
96MB	4MBx32/x36	4MBx32/x36	8MBx32/x36	8MBx32/x36
96MB	8MBx32/x36	8MBx32/x36	4MBx32/x36	4MBx32/x36
128MB	16MBx32/x36	16MBx32/x36	—	—
128MB	—	—	16MBx32/x36	16MBx32/x36
128MB	8MBx32/x36	8MBx32/x36	8MBx32/x36	8MBx32/x36
136MB	1MBx32/x36	1MBx32/x36	16MBx32/x36	16MBx32/x36
136MB	16MBx32/x36	16MBx32/x36	1MBx32/x36	1MBx32/x36
144MB	2MBx32/x36	2MBx32/x36	16MBx32/x36	16MBx32/x36
144MB	16MBx32/x36	16MBx32/x36	2MBx32/x36	2MBx32/x36
160MB	4MBx32/x36	4MBx32/x36	16MBx32/x36	16MBx32/x36
160MB	16MBx32/x36	16MBx32/x36	4MBx32/x36	4MBx32/x36
192MB	8MBx32/x36	8MBx32/x36	16MBx32/x36	16MBx32/x36
192MB	16MBx32/x36	16MBx32/x36	8MBx32/x36	8MBx32/x36
256MB	16MBx32/x36	16MBx32/x36	16MBx32/x36	16MBx32/x36

## Installing a SIM Module

A SIM module simply snaps into a socket on the system board. Pin 1 of the SIM module must correspond with Pin 1 of the socket.

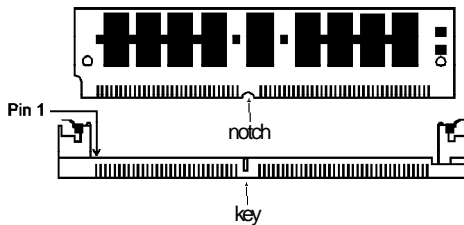

1. Position the SIMM above the socket with the “notch” in the module aligned with the “key” on the socket.
2. Seat the module at a 45° angle into the bank. Make sure it is completely seated. Tilt the module upright until it locks in place in the socket.

## Cache Memory

The G586IPC system board can support 256KB or 512KB pipeline burst, direct map write-back cache SRAM. Your system board may come with 256KB or 512KB cache mounted at locations U22 and U23 of the system board.

If your system board is mounted with 256KB cache, you may upgrade your cache memory to 512KB by installing a 256KB cache module in the 160-pin cache module slot (SSM1). Refer to page 12 for the locations of the SRAMs and cache module slot. If your system board is mounted with 512KB cache, which is the maximum cache memory supported by the system board, the cache module slot will not be installed on the system board.

### **Warning:**

*We highly recommend that you use the T2BSM132-256 or T3BSM1256 cache module. If you are using a cache module other than the ones recommended above, make sure your cache module meets the Intel COAST 2.x or 3.x specification. Severe damage might occur on the cache module or system board if you insert modules other than those specified above.*

## Installing the Cache Module

Locate the 160-pin cache module slot on the system board (SSM1). See page 12 for the location. Position the cache module above the slot. Make sure pin 1 of the cache module is aligned with pin 1 of the slot. Carefully slide the module into the slot. Press firmly on the top of it to seat it properly.

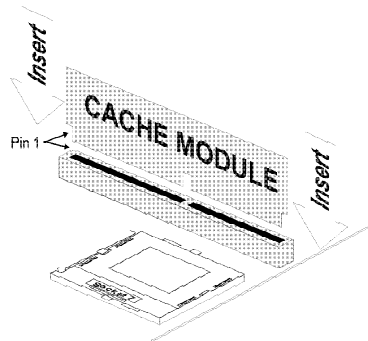

### Note:

*With the cache module installed in the cache module slot, the components on the solder side of the add-in card in PCI Slot 4 must not protrude more than 5mm.*

## CPU Installation

The G586IPC allows for easy installation of CPUs. Make sure all jumpers are set correctly before applying power or you may damage the CPU or system board. Please see the jumper settings on the following pages. Use the needle-nosed pliers to move the jumpers if necessary. The table below shows the External Bus Clock of the CPUs supported by the G586IPC system board and their corresponding PCI Clock and Bus Clock.

External Bus Clock	PCI CLK	Bus CLK
50MHz	25MHz	8.333MHz
55MHz	27.5MHz	9.1666MHz
60MHz	30MHz	7.5MHz
66MHz	33MHz	8.25MHz



## Jumper Settings for Intel Processors

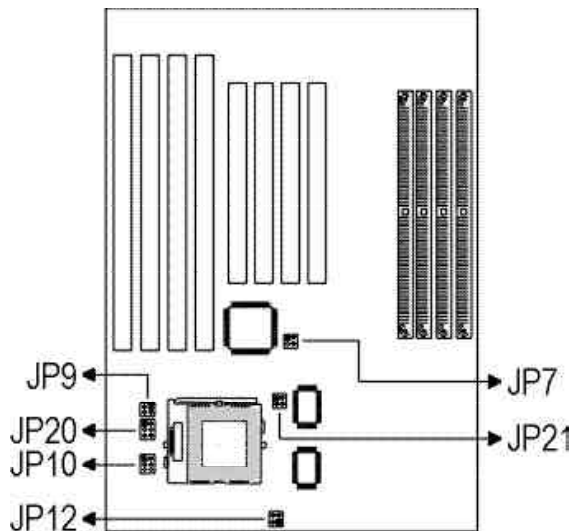

Intel Processors	Ext. Bus CLK	JP7
75MHz	50MHz	1-2 On, 3-4 On
90/120/150MHz	60MHz	1-2 On, 3-4 Off
100/133/166/200MHz MMX-166/200MHz	66MHz	1-2 Off, 3-4 On

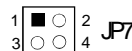

Intel Processors	Freq. Ratio	JP12
75/90/100MHz	1.5x	1-2 Off, 3-4 Off
120/133MHz	2x	1-2 On, 3-4 Off
150/166MHz/MMX-166MHz	2.5x	1-2 On, 3-4 On
200MHz/MMX-200MHz	3x	1-2 Off, 3-4 On



Voltages	JP9	JP10	JP20	JP21
2.5V	3-4 On	1-3, 2-4 On	1-2 On	1-2, 3-4 Off
2.8V (MMX)	3-4 On	1-3, 2-4 On	3-4 On	1-2, 3-4 Off
2.9V	3-4 On	1-3, 2-4 On	5-6 On	1-2, 3-4 Off
3.3V*	3-4 On	3-5, 4-6 On	3-4 On	1-2, 3-4 On
3.5V (VRVRE)	1-2 On	3-5, 4-6 On	3-4 On	1-2, 3-4 On

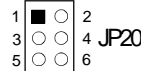
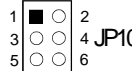
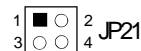
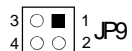

### Warning:

The default setting of JP9, JP10, JP20 and JP21 is 3.3V. If the voltage of your CPU is not 3.3V, make sure you set JP9, JP10, JP20 and JP21 according to the voltage of your CPU, otherwise, your system will hang.

## Jumper Settings for Cyrix Processors

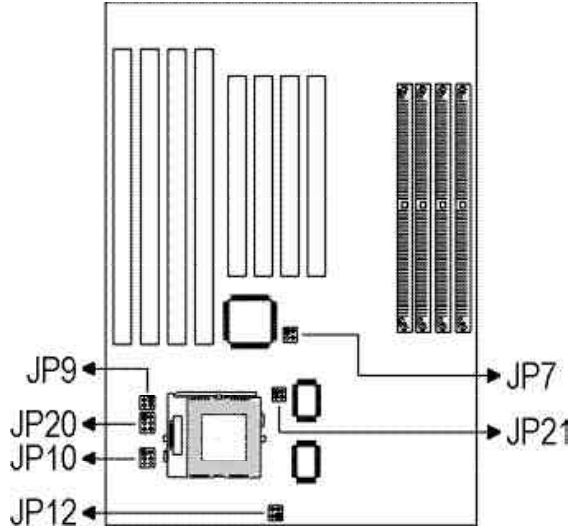

Cyrix Processors	Ext. Bus CLK	JP7
PR120+	50MHz	1-2 On, 3-4 On
PR133+	55MHz	1-2 Off, 3-4 Off
PR150+	60MHz	1-2 On, 3-4 Off
PR166+	66MHz	1-2 Off, 3-4 On



Cyrix Processors	Freq. Ratio	JP12
PR120+/PR133+/ PR150+/PR166+	2x	1-2 On, 3-4 Off



Voltages	JP9	JP10	JP20	JP21
2.5V	3-4 On	1-3, 2-4 On	1-2 On	1-2, 3-4 Off
2.8V (6x86L)	3-4 On	1-3, 2-4 On	3-4 On	1-2, 3-4 Off
2.9V	3-4 On	1-3, 2-4 On	5-6 On	1-2, 3-4 Off
3.3V*	3-4 On	3-5, 4-6 On	3-4 On	1-2, 3-4 On
3.5V	1-2 On	3-5, 4-6 On	3-4 On	1-2, 3-4 On

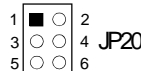
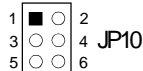
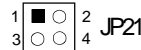
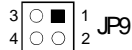

**Warning:**  
The default setting of JP9, JP10, JP20 and JP21 is 3.3V. If the voltage of your CPU is not 3.3V, make sure you set JP9, JP10, JP20 and JP21 according to the voltage of your CPU, otherwise, your system will hang.



## Jumper Settings for AMD-K5 Processors

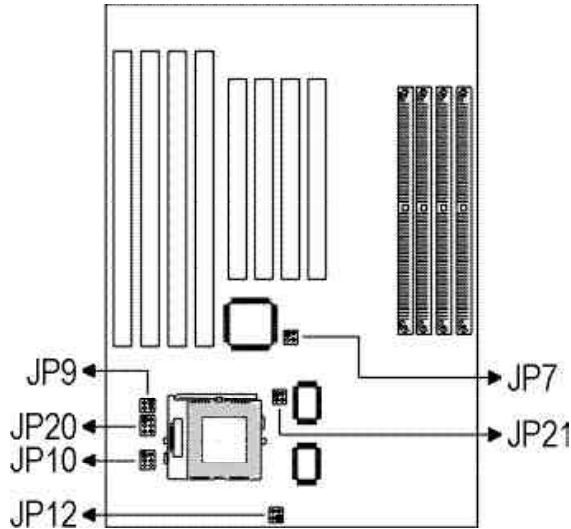

P-Rating/Core MHz	Ext. Bus CLK	JP7
PR75/75MHz	50MHz	1-2 On, 3-4 On
PR90/90MHz	60MHz	1-2 On, 3-4 Off
PR100/100MHz	66MHz	1-2 Off, 3-4 On
PR120/90MHz	60MHz	1-2 On, 3-4 Off
PR133/100MHz	66MHz	1-2 Off, 3-4 On

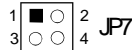

P-Rating/Core MHz	Freq. Ratio	JP12
PR75/75MHz PR90/90MHz PR100/100MHz PR120/90MHz PR133/100MHz	1.5x	1-2 Off, 3-4 Off



Voltages	JP9	JP10	JP20	JP21
25V	3-4 On	1-3, 2-4 On	1-2 On	1-2, 3-4 Off
28V	3-4 On	1-3, 2-4 On	3-4 On	1-2, 3-4 Off
29V	3-4 On	1-3, 2-4 On	5-6 On	1-2, 3-4 Off
3.3V*	3-4 On	3-5, 4-6 On	3-4 On	1-2, 3-4 On
3.5V	1-2 On	3-5, 4-6 On	3-4 On	1-2, 3-4 On

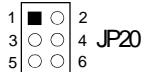
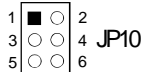
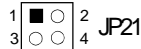
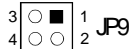

### Warning:

The default setting of JP9, JP10, JP20 and JP21 is 3.3V. If the voltage of your CPU is not 3.3V, make sure you set JP9, JP10, JP20 and JP21 according to the voltage of your CPU, otherwise, your system will hang.



## Installing Upgrade CPUs

The G586IPC is equipped with a 321-pin Zero Insertion Force (ZIF) socket at location U27 of the system board. Refer to page 12 for the location of the ZIF socket. This socket is designed for easy removal of an old CPU and easy insertion of an upgrade CPU. The ZIF socket allows you to carefully place the new CPU into its position. If you need to apply excessive force to insert the CPU, you are not installing the CPU correctly.

### **Warning:**

*Open the socket only if you are actually installing a CPU. The warranty on the original CPU will be voided if the S/N seal is broken. Before proceeding with the upgrade, take note of the following. The microprocessor and heatsink may be hot if the system has been running. To avoid the possibility of a burn, power the system off and let the processor and heatsink cool for 20 minutes.*

The 321-pin ZIF socket consists of five rows of pin holes on each side. To prevent improper CPU installation, the ZIF socket has a Plug/Keying mechanism. Several holes in the socket are plugged so that the CPU will go in only one way. If you cannot easily insert the CPU, verify that pin 1 of the CPU is aligned with pin 1 of the socket.

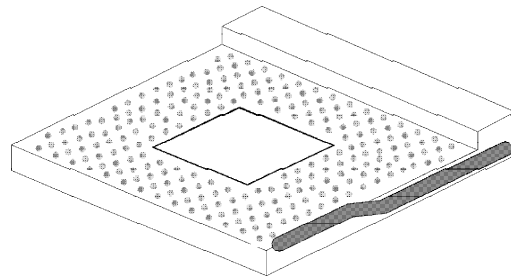

**Zero Insertion Force (ZIF) Socket**

To install an upgrade CPU, do the following:

1. Make sure the handle on the side of the ZIF socket is up. To raise the handle, push it down, slightly pull it out to the side, then raise it as far as it will go. It may be necessary to initially apply a small



amount of sideways force to free the handle from its retaining “tab”. Once clear of the “tab”, the handle will open relatively easily. The top plate will slide back. Do not use screwdrivers or other tools to open the socket, or you may damage the system or socket.

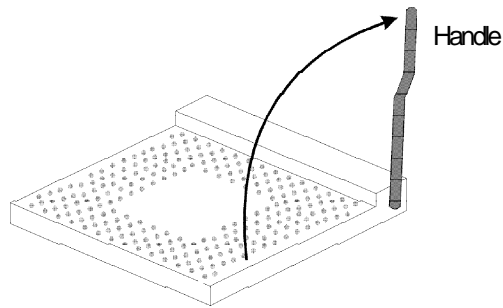

#### Lifting the Handle

2. Once the lever is completely up, remove the old CPU carefully by lifting it straight out of the socket. You are now ready to insert the new CPU.

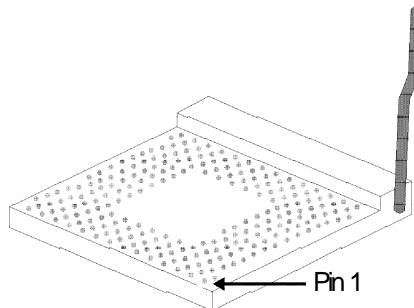

3. Position the CPU above the ZIF socket. Make sure pin 1 of the CPU is aligned with pin 1 of the socket. Lower the chip until the pins are inserted properly in their corresponding holes. Remember that very little force is needed to install the CPU. If the CPU is not easily inserted, verify whether or not pin 1 of the CPU is aligned with pin 1 of the socket. Applying too much pressure can damage the CPU or the socket.

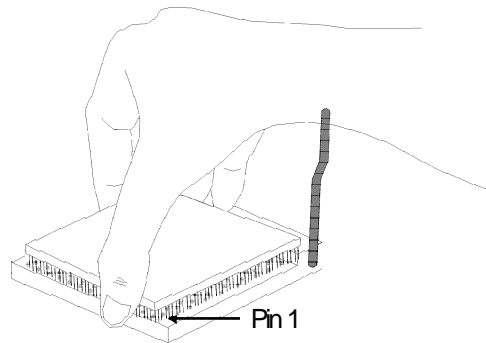

### Positioning the CPU Above the ZIF Socket

4. Push the handle down until the handle locks into place. The top plate will slide forward. You will feel some resistance as pressure starts to secure the CPU in the socket. This is normal and will not damage the CPU. However, if the handle is not completely closed, damage to the CPU and/or system board may result.

### Installing A Fan/Heatsink for Cyrix CPUs

If you are using a Cyrix CPU, you must choose a fan/heatsink which is made for Cyrix processors. Position the fan/heatsink on the CPU such that the air from the side of the fan/heatsink will flow across the heat regulators on the system board. See the figure below.

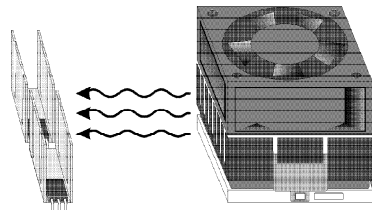

### Clearance Requirements

Your CPU comes with a heatsink mounted on top. To maintain proper airflow once the upgrade is installed on the system board, the CPU and heatsink require certain space clearances. The clearance above the CPU's fan/heatsink must be at least 0.4 inches. The clearance on at least 3 of 4 sides of the processor and heatsink must be at least 0.2



inches. All cables (for floppy drive, hard drive, CD-ROM, etc.) must be routed clear of the CPU and its airspace.

### Fan Exhaust

The CPU must be kept cool by using a fan with heatsink. The temperature of the air entering the fan/heatsink cannot exceed 45°C (113°F). The ambient or room temperature must be below 37°C (99°F).

## Jumper Settings for CMOS Clear

### Jumper JP8 CMOS Clear

If, for some reason, the CMOS becomes corrupted, the system can be reconfigured with the default values stored in the ROM BIOS. To load the default values, power off your system and set JP8 to On. Power on your system. After you have boot up an operating system, turn it off again. Set JP8 back to its default setting, Off.



Off: Normal (default)



On: CMOS Clear



## Jumper Settings for Display

### Jumper JP4 Display Type Select

Jumper JP4 sets the display adapter to color or mono. This jumper must match the type of display adapter installed. If you change your video adapter, make sure this jumper is changed accordingly.

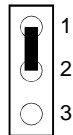

1-2 On: Color (default)

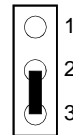

2-3 On: Mono





## Built-in Ports

The G586IPC system board is equipped with two serial ports, one parallel printer port, one shrouded floppy disk header, two shrouded IDE hard disk headers, one PS/2 mouse port and two connectors for external USB ports. Refer to page 12 for the locations of the built-in connectors and pin 1 of those connectors.

### Serial Ports

The built-in serial ports are RS-232C asynchronous communication ports with 16C550A-compatible UARTs that can be used with modems, serial printers, remote display terminals, and other serial devices. They use the following system I/O addresses:

Port Configuration	COM1	COM2	COM3	COM4
Serial Port 1	3F8h*	2F8h	3E8h	2E8h
Serial Port 2	3F8h	2F8h*	3E8h	2E8h

\* Default

### Connecting the Serial Ports

Two serial port cables mounted on a card-edge bracket are provided with the system board. Connect one serial port cable to connector J2 for COM 1 primary serial port and the other serial port cable to connector J3 for the COM 2 secondary serial port. Make sure the colored stripes on the ribbon cables are aligned with pins 1 of connectors J2 and J3. Mount the card-edge bracket to the system chassis.

### PS/2 Mouse Port

The PS/2 mouse port is a 6-pin connector on the system board. Attach the 6-pin mouse port cable, which is mounted on a card-edge bracket, to connector J1. Make sure the red wire on the PS/2 mouse connector is aligned with pin 1 of connector J1. Mount the card-edge bracket to the system chassis.





## Parallel Port

The G586IPC system board has a standard connector for interfacing your PC to a parallel printer. The parallel port on your system board can be set to any of the following system I/O addresses:

I/O Address	3BC-3BE Hex
	378-37A Hex (default)
	278-27A Hex

### Connecting the Parallel Printer Port

Attach the DB-25 printer port cable to connector J5 on the G586IPC system board. Make sure the colored stripe on the ribbon cable aligns with pin 1 of connector J5. Use a small nutdriver to mount the cable into a DB-25 cutout in the system chassis. If your printer port cable is attached to a card-edge bracket, connect the cable to connector J5 on the system board and mount the card-edge bracket to the system chassis.



### Floppy Disk Drive Controller



The G586IPC system board is equipped with a shrouded floppy disk header that supports two standard floppy disk drives. You can install any 360KB, 720KB, 1.2MB, 1.44MB, or 2.88MB floppy disk drives. To prevent improper floppy cable installation, the shrouded floppy disk header has a keying mechanism. The 34-pin connector on the floppy cable can be placed into the header only if pin 1 of the connector is aligned with pin 1 of the header.

### Connecting the Floppy Disk Cable

1. Install the 34-pin header connector into the shrouded floppy disk header (J4) on the system board. The colored edge of the ribbon should be aligned with pin 1 of connector J4.
2. Install the other 34-pin header connector(s) into the disk drive(s). Align the colored edge of the daisy chained ribbon cable with pin 1 of the drive edge connector(s). The end-most connector should be attached to the drive you want to designate as Drive A.

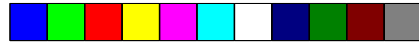

## IDE Hard Disk Interface

The G586IPC system board is equipped with two shrouded PCI IDE headers that will interface up to four Enhanced IDE (Integrated Drive Electronics) hard disk drives.

**Note:**

*Only Enhanced IDE hard drives or ATAPI CD-ROMs can be connected to the IDE interface.*

### Connecting the IDE Hard Disk Interface

To prevent improper IDE cable installation, each shrouded PCI IDE header has a keying mechanism. The 40-pin connector on the IDE cable can be placed into the header only if pin 1 of the connector is aligned with pin 1 of the header.

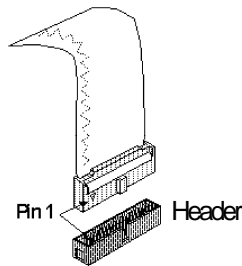

**Note:**

*An IDE cable with a standard 40-pin connector (without the keying mechanism) can be installed in the shrouded PCI IDE header. Be extremely careful to match the colored edge of the ribbon with pin 1 of the header.*

### Connecting the Hard Disk Cable

1. Connect the cable to the system board. If you are connecting two hard drives, install the 40-pin connector of the IDE cable into the primary shrouded IDE header (connector J6). If you are adding a third or fourth IDE device, install the 40-pin connector of the other IDE cable into the secondary shrouded IDE header (connector J7).



2. Connect the cable to the devices. Install the other 40-pin header connector(s) into the device making sure to match the colored edge of the ribbon cable aligned with pin 1 of the drive edge connector(s).

**Note:**

*Refer to your disk drive user's manual for information about selecting proper drive switch settings.*

### **Adding a Second IDE Hard Drive**

When using two IDE drives, one must be set as the master and the other as the slave. Follow the instructions provided by the drive manufacturer for setting the jumpers and/or switches on the drives.

We recommend that you use Enhanced IDE hard drives from the same manufacturer. In a few cases, drives from two different manufacturers will not function properly when used together. The problem lies in the hard drives, not the G586IPC system board.

### **Preparing an IDE Drive for Use**

IDE disk drives are already low-level formatted, with any bad-track errors entered, when shipped by the drive manufacturer. Do not attempt to do a low-level format or you may cause serious damage to the drive. To use an IDE drive, you need to enter the drive type (this information is provided by the drive manufacturer) into the system's CMOS setup table. Then run FDISK and FORMAT provided with DOS. You may also use the IDE HDD Auto Detection function which will allow the BIOS to auto detect your hard drive type. Refer to the IDE HDD Auto Detection section for details.

**Warning:**

*Do not run FDISK and FORMAT programs on a drive that has already been formatted or you will lose all programs and data stored on the drive.*



## Using G586IPC with CD-ROM Drives

If you encountered problems while using an ATAPI CD-ROM drive that is set in Master mode, please set the CD-ROM drive to Slave mode. Some ATAPI CD-ROMs may not be recognized and cannot be used if incorrectly set in Master mode.

## Universal Serial Bus Connectors

The G586IPC system board is equipped with two connectors, at locations JP1 and JP2 on the system board, for external USB ports. USB allows data exchange between your computer and a wide range of simultaneously accessible peripherals.

### Connecting the USB Ports

As an option, one card-edge bracket mounted with two USB port cables may be provided with the system board. The ends of the cables are attached to a connector. Mount the card-edge bracket to the system chassis.

Connect the cable to JP1 and JP2 on the system board. The USB port cables can be inserted only if pin 1 of the cable (red wire) is aligned with pin 1 of JP1 and JP2. Pin 5 of JP2 has been removed and the hole in the USB cable connector, which corresponds to pin 5, has been plugged to prevent incorrectly inserting the connector.

**Note:**

*Make sure "USB Controller" in the Integrated Peripherals setup of the Award BIOS is Enabled.*

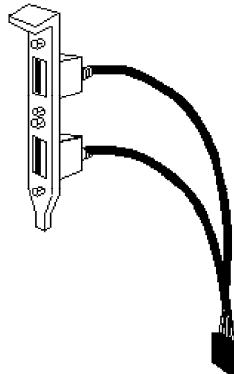
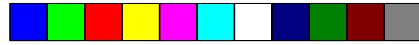

**USB port cables (optional)**

## Installing Expansion Cards

The G586IPC system board is equipped with 3 dedicated PCI slots, 3 dedicated 16-bit ISA slots and 1 shared PCI/ISA slot. All PCI slots are bus masters. You can only install one card in one or the other of the shared slots at a time; you cannot install devices in both slots. Refer to page 12 for the locations of the expansion slots.

Due to the size of the CPU with its accompanying heatsink/fan component, the length of the add-in cards in PCI slots 1 and 2 and ISA slots 1 and 2 is limited to 18cm (measured from the bracket of the card).

The length of the add-in card in PCI slot 4 is limited to 18cm only if the components on the solder side of the card protrude more than 5mm.



## Chapter 3 Software Installation

---

After you power up your system, the BIOS message appears on your screen and the memory count begins.

After the memory test, the following message will appear on the screen:

*Press DEL to enter setup*

If the message disappears before you respond, restart your system or press the “Reset” button located on the front panel of your computer. You may also restart the system by pressing the <Ctrl> <Alt> and <Del> keys simultaneously.

If you have set a password and selected “System” in the Security Option of the BIOS Features Setup menu, you will be prompted for the password every time the system is rebooted or any time you try to enter Setup. Type in the correct password and press <Enter>.

If you selected “Setup” in the Security Option, you will be prompted for the password only when you try to enter Setup. Refer to the “BIOS Features Setup” section for more information.

### Award CMOS Setup Utility

While booting up, press <Ctrl> <Alt> <Esc> simultaneously or <Del> to enter the Setup utility. A screen similar to the one on the next page will appear.



ROM PCI/ISA BIOS  
CMOS SETUP UTILITY  
AWARD SOFTWARE, INC.

STANDARD CMOS SETUP BIOS FEATURES SETUP CHIPSET FEATURES SETUP POWER MANAGEMENT SETUP PNP/PCI CONFIGURATION LOAD BIOS DEFAULTS LOAD SETUP DEFAULTS	INTEGRATED PERIPHERALS SUPERVISOR PASSWORD USER PASSWORD IDE HDD AUTO DETECTION HDD LOW LEVEL FORMAT SAVE & EXIT SETUP EXIT WITHOUT SAVING
ESC :Quit F10 :Sve & Exit Setup	↑↓←→ :Select Item (Shift) F2 :Change Color
Time, Date, Hard Disk Type...	

Use the arrow keys to highlight the option you want and press <Enter>. The following describes each of these options.

**Note:**

*The settings on the BIOS setup screens on the following pages are for reference only. Some of the settings will vary according to your system's configuration and should not be referred to as the standard default setting.*

**Standard CMOS Setup**

Use the arrow keys to highlight "Standard CMOS Setup" and press <Enter>. A screen similar to the one below will appear.

ROM PCI/ISA BIOS  
STANDARD CMOS SETUP  
AWARD SOFTWARE, INC.

Date (mm:dd:yy) : Sun, Sep 8 1996 Time (hh:mm:ss) : 9 : 18 : 58									
HARD DISKS	TYPE	SIZE	CYLS	HEAD	PRECOMP	LANDZ	SECTOR	MODE	
Primary Master	:Auto	0	0	0	0	0	0	Auto	
Primary Slave	:Auto	0	0	0	0	0	0	Auto	
Secondary Master	:Auto	0	0	0	0	0	0	Auto	
Secondary Slave	:Auto	0	0	0	0	0	0	Auto	
DriveA	:1.44M, 3.5in.								
DriveB	:None								
Video	:EGA/VGA								
Halt on	:All Errors								
								Base Memory :	640K
								Extended Memory :	31744K
								Other Memory :	384K
								Total Memory :	32768K
ESC	:Quit				↑↓←→	:Select Item	PU/PD/+/-		:Modify
F1	:Help				(Shift)F2	:Change			



## Date

The date format is <day>, <month>, <date>, <year>.

Day	Displays a day, from Sunday to Saturday
Month	Displays the month, from January to December
Date	Displays the date, from 1 to 31
Year	Displays the year, from 1900 to 2099

## Time

The time format is <hour>, <minute>, <second>. The time is based on the 24-hour military-time clock. For example, 1 p.m. is 13:00:00.

Hour	Displays hours from 00 to 23
Minute	Displays minutes from 00 to 59
Second	Displays seconds from 00 to 59

## Primary Master, Primary Slave, Secondary Master and Secondary Slave

These categories allow you to enter the appropriate specifications for the type of hard disk drive(s) installed in your system. There are 45 predefined types and 4 user definable types for IDE hard drives. Type 1 to Type 45 are predefined. Type User is user-definable.

Press <PgUp> or <PgDn> to select a numbered hard disk type or type the number and press <Enter>. The hard disk will not work properly if you enter improper information for this category. You can use Type "User" to define your own drive type manually.

If you select Type "User", you will need to know the information listed below. Enter the information and press <Enter>. This information should be included in the documentation from your hard disk vendor or the system manufacturer.





If the controller of the HDD interface is ESDI, you must select “Type 1”.

If the controller of the HDD interface is SCSI, you must select “None”.

If you select Type “Auto”, the BIOS will auto-detect the HDD & CD-ROM drive at the POST stage and show the IDE for the HDD & CD-ROM drive.

Type	Drive type
Cyls	Number of cylinders
Heads	Number of heads
Precomp	Write precomp
Landzone	Landing zone
Sectors	Number of sectors
Mode	Mode type

If a hard disk has not been installed, select “None” and press <Enter>.

### Drive A and Drive B

These categories identify the types of floppy disk drives installed. The following are the options for drives A and B.

None	No floppy drive is installed
360K, 5.25 in.	5-1/4 inch PC-type standard drive; 360 kilobyte capacity
1.2M, 5.25 in.	5-1/4 inch AT-type high-density drive; 1.2 megabyte capacity
720K, 3.5 in.	3-1/2 inch double-sided drive; 720 kilobyte capacity
1.44M, 3.5 in.	3-1/2 inch double-sided drive; 1.44 megabyte capacity
2.88M, 3.5 in.	3-1/2 inch double-sided drive; 2.88 megabyte capacity

**Note:**

*Choosing an incorrect type might cause your system to format the floppy disk improperly, and you will not be able to access your data.*



## Video

This category selects the type of video adapter used for the primary system monitor. Although secondary monitors are supported, you do not have to select the type in Setup. The default setting is EGA/VGA (BIOS default, Setup default).

EGAVGA	Enhanced Graphics Adapter/Video Graphics Array. For EGA, VGA, SEGA, SVGA and PGA monitor adapters.
CGA 40	Color Graphics Adapter. Power up in 40-column mode.
CGA 80	Color Graphics Adapter. Power up in 80-column mode.
Mono	Monochrome adapter. Includes high resolution monochrome adapters.

## Halt On

This category determines whether the system will stop if an error is detected during power up. The default setting is All Errors (BIOS default, Setup default).

No Errors	The system boot will not stop for any errors detected.
All Errors	The system boot will stop whenever the BIOS detects a non-fatal error.
All, But Keyboard	The system boot will not stop for a keyboard error; it will stop for all other errors.
All, But Diskette	The system boot will not stop for a disk error; it will stop for all other errors.
All, But Disk/Key	The system boot will not stop for a disk or keyboard error; it will stop for all other errors.

## Memory

The base memory size, extended memory size and the other memory size cannot be altered; your computer automatically detects and displays them.



Base Memory	This refers to the amount of base or conventional memory installed on the system board.
Extended Memory	This is the amount of memory located above 1MB in the memory address map of the CPU.
Other Memory	This memory size refers to the memory located in the address space between 640K and 1024K. DOS uses this area to load device drivers to keep base memory free for application programs. The most appropriate use of this area is for Shadow RAM.

## BIOS Features Setup

The BIOS Features Setup allows you to configure your system for basic operation. Some entries are defaults required by the system board, while others, if enabled, will improve the performance of your system or let you set some features according to your preference.

ROM PCI/ISA BIOS  
BIOS FEATURES SETUP  
AWARD SOFTWARE, INC.

Virus Warning	: Disabled	Video BIOS Shadow	: Enabled
CPU Internal Cache	: Enabled	C8000-CBFFF Shadow	: Disabled
External Cache	: Enabled	CC000-CFFFF Shadow	: Disabled
Quick Power On Self Test	: Enabled	D0000-D3FFF Shadow	: Disabled
Boot Sequence	: A, C	D4000-D7FFF Shadow	: Disabled
Swap Floppy Drive	: Disabled	D8000-DBFFF Shadow	: Disabled
Boot Up Floppy Seek	: Enabled	DC000-DFFFF Shadow	: Disabled
Boot Up NumLock Status	: On		
Gate A20 Option	: Fast		
Typematic Rate Setting	: Disabled		
Typematic Rate (Chars/Sec)	: 6	ESC :Quit	↑↓→← :Select Item
Typematic Delay (Msec)	: 250	F1 :Help	PU/PD/+/- :Modify
Security Option	: Setup	F5 :Old Values (Shift) F2	:Color
PCI/VGA Palette Snoop	: Disabled	F6 :Load BIOS Defaults	
OS Select For DRAM>64MB	: Non-OS2	F7 :Load Setup Defaults	

## Virus Warning

This category protects the boot sector and partition table of your hard disk drive. When this item is enabled, the Award BIOS will monitor the boot sector and partition table of the hard disk drive. If an attempt is made to write to the boot sector or partition table of the hard disk drive, the BIOS will halt the system and the following error message will appear.

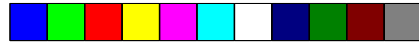

**! WARNING !**  
 Disk boot sector is to be modified  
 Type "Y" to accept write or "N" to abort write  
 Award Software, Inc.

After seeing this message, if necessary, you will be able to run an anti-virus program to locate and remove the problem before any damage is done.

Many disk diagnostic programs which attempt to access the boot sector table will cause the warning message to appear. If you are running such a program, we recommend that you first disable this category. Also, disable this category if you are installing or running certain operating systems like Windows 95 or the operating system may not install nor work.

Enabled	BIOS issues a warning when any program or virus sends a Disk Format command or attempts to write to the boot sector of the hard disk drive.
Disabled	No warning message will appear when the hard disk drive is accessed.

### CPU Internal Cache and External Cache

These categories speed up memory access. The default value is enabled. Enable the External Cache for better performance.

Enabled	Enables the internal/external cache.
Disabled	Disables the internal/external cache.

### Quick Power On Self Test

This category speeds up Power On Self Test (POST) after you power on your system. If it is set to Enabled, the BIOS will shorten or skip some check items during POST.

Enabled	Enables quick POST.
Disabled	Normal POST.



## Boot Sequence

This category determines which drive to search first for the disk operating system (i.e. DOS). The default is A, C.

A, C	The system will first search for a floppy drive and then a hard disk drive.
C, A	The system will first search for a hard disk drive and then a floppy drive.
CDROM, C, A	The system will first search for a CD-ROM drive, then a hard disk drive and then a floppy drive.
C, CDROM, A	The system will first search for a hard disk drive, then a CD-ROM drive, and then a floppy drive.

## Swap Floppy Drive

Enabled	When this option is enabled and the system is booting from the floppy drive, the system will boot from drive B instead of drive A.
Disabled	When this option is disabled and the system is booting from the floppy drive, the system will boot from drive A.

## Boot Up Floppy Seek

During POST, the BIOS will determine if the floppy disk drive installed is 40 or 80 tracks. 360K type is 40 tracks while 760K, 1.2M and 1.44M are all 80 tracks.

Enabled	The BIOS will check whether the floppy disk drive installed is 40 or 80 tracks. Note that the BIOS cannot distinguish between 720K, 1.2M or 1.44M drive types as they are all 80 tracks.
Disabled	The BIOS will not search for the type of floppy disk drive by track number. Note that there will not be any warning message if the drive installed is 360KB.



### Boot Up NumLock Status

This allows you to determine the default state of the numeric keypad. By default, the system boots up with NumLock on.

On	The function of the numeric keypad is the number keys.
Off	The function of the numeric keypad is the arrow keys.

### Security Option

This category allows you to limit access to your system and Setup or just to Setup.

System	The system will not boot and access to Setup will be denied if the correct password is not entered at the prompt.
Setup	The system will boot, but access to Setup will be denied if the correct password is not entered at the prompt.

### PCI/VGA Palette Snoop

This is used to select whether to allow MPEG ISA/VESA VGA cards to work with PCI/VGA or not.

Enabled	PCI/VGA working with MPEG ISA/VESA VGA cards.
Disabled	PCI/VGA not working with MPEG ISA/VESA VGA cards.

### OS Select for DRAM > 64MB

This item allows you to access the memory that is over 64MB in OS/2. The options are: Non-OS2 and OS2.

### Video BIOS Shadow

Determines whether video BIOS will be copied to RAM. Video Shadow will increase the video speed. Note that some graphics boards require that this option be disabled.



Enabled	Video shadow is enabled.
Disabled	Video shadow is disabled.

### C8000-CBFFF Shadow to DC000-DFFFF Shadow

These categories determine whether option ROMs will be copied to RAM

Enabled	Optional shadow is enabled.
Disabled	Optional shadow is disabled.

### Chipset Features Setup

This section gives you instructions on how to configure the system based on the specific features of the chipset. The chipset manages bus speeds and access to system memory resources such as DRAM and external cache. It also coordinates communications between the conventional ISA bus and the PCI bus. These items should not be altered unless necessary. Depending on your add-in boards, you may not or should not enable some of those features. The default settings have been chosen because they provide the best operating conditions for your system.

ROM PCI/ISA BIOS  
CHIPSET FEATURES SETUP  
AWARD SOFTWARE, INC.

DRAM Timing	: 60 ns	
System BIOS Cacheable	: Enabled	
Video BIOS Cacheable	: Enabled	
8 Bit I/O Recovery Time	: 1	
16 Bit I/O Recovery Time	: 1	
Memory Hole At 15M-16M	: Disabled	
Peer Concurrence	: Enabled	
Chipset Special Features	: Disabled	
DRAM ECC/PARITY Select	: Parity	
Memory Parity/ECC Check	: Auto	
Single Bit Error Report	: Enabled	
		ESC :Quit    ↑↓←→ :Select Item
		F1 :Help    PU/PD/+/- :Modify
		F5 :Old Values (Shift) F2 :Color
		F6 :Load BIOS Defaults
		F7 :Load Setup Defaults



## Power Management Setup

Power Management Setup allows you to configure your system to most effectively save energy.

ROM PCI/ISA BIOS  
POWER MANAGEMENT SETUP  
AWARD SOFTWARE, INC.

Power Management : Disabled	<b>** Power Down &amp; Resume Events **</b>	
PM Control by APM : Yes	IRQ3 (COM 2) : On	
Video Off Method : V/H SYNC+Blank	IRQ4 (COM 1) : On	
MODEM Use IRQ : 3	IRQ5 (LPT 2) : On	
	IRQ6 (Floppy Disk) : On	
Doze Mode : Disabled	IRQ7 (LPT 1) : On	
Standby Mode : Disabled	IRQ8 (RTC Alarm) : Off	
Suspend Mode : Disabled	IRQ9 (IRQ2 Redir) : On	
HDD Power Down : Disabled	IRQ10(Reserved) : On	
	IRQ11(Reserved) : On	
<b>** Wake Up Events In Doze &amp; Standby **</b>	IRQ12 (PS2 Mouse) : On	
IRQ3 (Wake-Up Event) : On	IRQ13 (Coprocesor) : On	
IRQ4 (Wake-Up Event) : On	IRQ14 (Hard Disk) : On	
IRQ8 (Wake-Up Event) : On	IRQ15 (Reserved) : Off	
IRQ12 (Wake-up Event) : On	ESC :Quit	↑↓←→ :Select Item
	F1 :Help	PU/PD/+/- :Modify
	F5 :Old Values	(Shift) F2 :Color
	F6 :Load BIOS Defaults	
	F7 :Load Setup Defaults	

## Power Management

This category allows you to select the type (or degree) of power saving by changing the length of idle time that elapses before each of the following modes are activated: Doze Mode, Standby Mode, and Suspend Mode.

Disable (default)	No power management. Disables the Doze, Standby and Suspend modes.
Min. Power Saving	Minimum power management. Doze Mode = 1 hr., Standby Mode = 1 hr., and Suspend Mode = 1 hr.
Max. Power Saving	Maximum power management. Doze Mode = 1 min., Standby Mode = 1 min., and Suspend Mode = 1 min.
User Defined	Allows you to set each mode individually. When enabled, each option ranges from 1 min. to 1 hr.

## PM Control by APM

Yes	An Advanced Power Management device will be activated to enhance the Max. Power Saving mode and stop the CPU's internal clock. (default)
Nb	The system BIOS will ignore APM when initiating the Power Management mode.





## Video Off Method

This determines the manner in which the monitor is blanked.

V/H SYNC + Blank	This selection will cause the system to turn off the vertical and horizontal synchronization ports and write blanks to the video buffer.
Blank Screen	This option only writes blanks to the video buffer.
DPMS	Initializes display power management signaling.

## MODEM Use IRQ

This category is used to set an IRQ channel (IRQ 3, 4, 5, 7, 9, 10 or 11) for the modem installed in your system.

## Doze Mode, Standby Mode, Suspend Mode and HDD Power Down

These Green PC power saving categories are user configurable only when the Power Management category is set to User Defined.

Doze Mode	When enabled and after the set time of system inactivity, the CPU clock will run at a slower speed (1/2 of full speed) while all other devices still operate at full speed.
Standby Mode	When enabled and after the set time of system inactivity, the CPU clock will run at a speed slower than the speed during Doze mode (1/3 of full speed) while all other devices still operate at full speed.
Suspend Mode	When enabled and after the set time of system inactivity, the CPU and onboard peripherals will be shut off.
HDD Power Down	This is used to define the continuous HDD idle time that elapses before the HDD enters the power saving mode (motor off). When enabled and after the set time of system inactivity, the hard disk drive will be powered down while all other devices remain active.

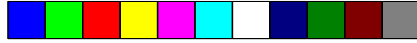

## IRQ3-IRQ15 (Wake Up Events in Doze & Standby, and Power Down & Resume Events)

These are I/O events whose occurrence can prevent the system from entering a power saving mode or can awaken the system from such a mode. In effect, the system remains alert for anything which occurs to a device which is configured as enabled, even when the system is in a power saving mode.

When an I/O device wants to gain the attention of the operating system, it signals this by causing an IRQ to occur. When the operating system is ready to respond to the request, it interrupts itself and performs the service. When set to Enabled, the activity will neither prevent the system from going into a power saving mode nor awaken it.

## PNP/PCI Configuration

This section describes configuring the PCI bus system. It covers some very technical items and it is strongly recommended that only experienced users make any changes to the default settings.

ROM PCI/ISA BIOS  
PNP/PCI CONFIGURATION SETUP  
AWARD SOFTWARE, INC.

Resources Controlled By	:Auto	PCI IRQ Activated By	: Level
Reset Configuration Data	:Disabled	PCI IDE IRQ Map To	: PCI-AUTO
		Primary IDE INT#	: A
		Secondary IDE INT#	: B
		ESC	:Quit
		F1	:Help
		F5	:Old Values (Shift) F2
		F6	:Load BIOS Defaults
		F7	:Load Setup Defaults
		↑↓←→	:Select Item
		PU/PD/+/-	:Modify
			:Color



## Resources Controlled By

The Award Plug and Play BIOS has the capacity to automatically configure all of the boot and Plug and Play compatible devices. However, this capability means absolutely nothing unless you are using a Plug and Play operating system such as Windows® 95.

Auto	The system will automatically detect the settings for you. The categories that follow will not be shown on the PNP/PCI Configuration screen.
Manual	This allows you to set the IRQ/DMA (you have assigned your add-in card) to Legacy ISA or PCI/ISA PnP. For non-PnP ISA cards, select Legacy ISA. For PnP ISA or PCI cards, select PCI/ISA PnP.

## Reset Configuration Data

Enabled	The BIOS will reset the configuration data once automatically.
Disabled	The BIOS will not reset the configuration data.

## PCI IRQ Activated By

This category is used to set the method by which the PCI bus recognizes that an IRQ service is being requested by a device. Under all circumstances, you should retain the default configuration unless a different setting is needed.

## PCI IDE IRQ Map To

This category is used to configure your system to the type of IDE disk controller in use.

ISA	Designates which ISA slot is installed with an IDE controller card; that is, if you are using an IDE controller card.
PCI-Auto	The system will scan and determine the PCI slot that is installed with an IDE controller card.



## Primary IDE INT# and Secondary IDE INT#

The Primary and Secondary IDE INT# categories are used to select the PCI interrupt (A, B, C, or D) that is associated with the connected hard drives.

### Load BIOS Defaults

The “Load BIOS Defaults” option loads the troubleshooting default values permanently stored in the ROM chips. These settings are not optimal and turn off all high performance features. You should use these values only if you have hardware problems. Highlight this option on the main menu and press <Enter>. The message below will appear.

*Load BIOS Defaults (Y/N)? N*

If you want to proceed, type <Y> and press <Enter>. The default settings will be loaded.

### Load Setup Defaults



The “Load Setup Defaults” option loads optimized settings from the BIOS ROM. Use the Setup default values as standard values for your system.

Highlight this option on the main menu and press <Enter>. The message below will appear.

*Load Setup Defaults (Y/N)? N*

Type <Y> and press <Enter> to load the Setup default values.



## Integrated Peripherals

ROM PCI/ISA BIOS  
INTEGRATED PERIPHERALS  
AWARD SOFTWARE, INC.

IDE HDD Block Mode : Enabled	USB Controller : Disabled
PCI Slot IDE 2nd Channel : Disabled	
On-Chip Primary PCI IDE : Enabled	
On-Chip Secondary PCI IDE : Enabled	
IDE Primary Master PIO : Auto	
IDE Primary Slave PIO : Auto	
IDE Secondary Master PIO : Auto	
IDE Secondary Slave PIO : Auto	
Onboard FDC Controller : Enabled	
Onboard UART 1 : Auto	
Onboard UART 2 : Auto	
Onboard UART 2 Mode : Standard	
Onboard Parallel Port : 378H/IRQ7	ESC :Quit ↑↔ :Select Item
Parallel Port Mode : Normal	F1 :Help PU/PD/+/- :Modify
	F5 :Old Values (Shift) F2 :Color
	F6 :Load BIOS Defaults
	F7 :Load Setup Defaults

### IDE HDD Block Mode

Enabled	The IDE HDD uses the block mode. The system BIOS will check the hard disk drive for the maximum block size the system can transfer. The block size will depend on the type of hard disk drive installed.
Disabled	The IDE HDD uses the standard mode.

### PCI Slot IDE 2nd Channel

This allows you to designate an IDE controller card inserted into one of the PCI slots as your secondary IDE controller.

Enabled	The IDE controller card is designated as the secondary IDE controller.
Disabled	No IDE controller card occupying any of the PCI slots.

### On-Chip Primary PCI IDE and On-Chip Secondary PCI IDE

These categories allow you to enable or disable the primary and secondary IDE controller. The default is Enabled. Select Disabled if you want to add a different hard drive controller.

## IDE Primary Master/Slave PIO and IDE Secondary Master/Slave PIO

Your system supports five modes, 0 (default) to 4, which primarily differ in timing. When Auto is selected, the BIOS will select the best available mode after checking your hard drive.

Auto	The BIOS will automatically set the system according to your hard disk drive's timing.
0-4	You can select a mode that matches your hard disk drive's timing. Caution: Do not use the wrong setting or you will have drive errors.

## Onboard FDD Controller

Enabled	Enables the onboard floppy disk controller.
Disabled	Disables the onboard floppy disk controller.

## Onboard UART 1 and Onboard UART 2

Auto	The system will automatically select an I/O address for the onboard serial port 1 and serial port 2.
COM1 to COM4	Allows you to manually select COM1, COM2, COM3, or COM4 for the onboard serial port 1 and serial port 2.
Disabled	Disables the onboard serial port 1 and/or serial port 2.

## Onboard UART 2 Mode

The G586IPC system board supports IrDA function for wireless connectivity between your computer and peripheral devices. To use the IrDA function, follow the steps below.

1. Connect your IrDA cable to connector J9 of the G586IPC system board. Refer to page 12 for the location of connector J9.
2. Set "Onboard UART 2 Mode" to the type of IrDA standard supported by your IrDA peripheral/device.



You may not use IrDA (J9) and the COM 2 serial port (J3) at the same time. If you are using the COM 2 serial port, set “Onboard UART 2 Mode” to Standard.

Standard	Uses the COM 2 serial port.
HPSIR	HP mode IrDA.
ASKIR	SHARP mode IrDA.

### Onboard Parallel Port

378-IRQ7 3BC-IRQ7 278-IRQ5	Selects the I/O address and IRQ for the onboard parallel port.
Disabled	Disables the onboard parallel port.

### Parallel Port Mode

Normal EPP ECP ECP+EPP	Selects the parallel port mode according to the type of printer device connected to your onboard parallel port.
---------------------------------	---

### Supervisor Password

If you want to protect your system and setup from unauthorized entry, set a supervisor’s password with the “System” option selected in the BIOS Features Setup.

If you want to protect access to setup only, but not your system, set a supervisor’s password with the “Setup” option selected in the BIOS Features Setup. You will not be prompted for a password when you cold boot the system.

Use the arrow keys to highlight the “Supervisor Password” option and press <Enter>. The message below will appear.

*Enter Password:*



Type in the password. You are limited to eight characters. When done, the message below will appear:

*Confirm Password:*

You are being asked to verify the password. Type in exactly the same password. If you type in a wrong password, you will be prompted to enter the correct password again.

To delete or disable the password function, highlight “Supervisor Password” and press <Enter>, instead of typing in a new password. Press the <Esc> key to return to the main menu.

### **User Password**

If you want another user to have access only to your system but not to setup, set a user’s password with the “System” option selected in the BIOS Features Setup.

If you want a user to enter a password when trying to access setup, set a user’s password with the “Setup” option selected in the BIOS Features Setup. Using a user’s password to enter Setup allows a user to access only the “User Password” option that appears on the main screen. Access to all other options is denied.

To set, confirm, verify, disable or delete a user’s password, follow the procedures described in the section “Supervisor Password”. If you forget your password, refer to the procedure described in the same section.

### **IDE HDD Auto Detection**

This option detects the hard disk parameters for the hard disk drives installed in your system. Highlight this option and press <Enter>. A screen similar to the one on the next page will appear.







ROM PCI/ISA BIOS  
CMOS SETUP UTILITY  
AWARD SOFTWARE, INC.

HARD DISKS	TYPE	SIZE	CYLS	HEAD	RECOMP	LANDZ	SECTOR	MODE
Primary Master:								
Select Primary Master Option (N=Skip): N								
OPTIONS	SIZE	CYLS	HEAD	RECOMP	LANDZ	SECTOR	MODE	
2 (Y)	853	827	32	0	1653	63	LBA	
1	853	1654	16	65535	1653	63	Normal	
3	853	827	32	65536	1653	63	Large	
Note: Some OS (like SCO-UNIX) must be "NORMAL" for installation								
ESC: Skip								

Enter your choice, and press <Enter> to accept the parameters or press <Esc> to abort. The parameters of the hard disk will be displayed in the Standard CMOS Setup.

### Hard Drive Mode

The system board supports three HDD modes: Normal, LBA and Large. If your hard disk drive does not support LBA mode, the "LBA" option will not be displayed. If your HDD has 1024 or fewer cylinders, the "Large" option will not be displayed. If your hard drive is larger than 2.1GB, be sure that your operating system supports it or you may need to create separate partitions.

### Normal Mode

Normal mode is the generic access mode in which neither the BIOS nor the IDE controller will make any transformations during hard-drive access.

The maximum number of cylinders, heads and sectors for Normal mode are 1024, 16 and 63, respectively.

	no. Cylinders	(1024)
x	no. Heads	( 16)
x	no. Sectors	( 63)
x	bytes per sector	( 512)

---

528 megabytes

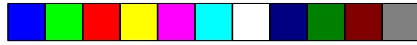

If you set your HDD to Normal mode, the maximum accessible HDD will be 528 megabytes even though the physical size of the HDD may be greater than that.

### LBA (Logical Block Addressing) Mode

LBA mode is a HDD accessing method to overcome the 528 megabyte limitation. The number of cylinders, heads and sectors shown on the screen may not be the actual number for the HDD.

During HDD accessing, the IDE controller will transform the logical address described by the sector, head and cylinder number into its own physical address inside the HDD.

The maximum HDD size supported by the LBA mode is 8.4 gigabytes. It is obtained by the following formula.

	no. Cylinders	(1024)
x	no. Heads	( 255)
x	no. Sectors	( 63)
x	bytes per sector	( 512)
	8.4 gigabytes	

### Large Mode

Large mode is the extended HDD access mode supported by the system board. Some IDE HDDs have more than 1024 cylinders without LBA support (in some cases, you may not want the LBA mode). This system board provides another alternative to support these kinds of HDDs.

The BIOS tells the operating system that the number of cylinders is half the actual number and that the number of heads is double the actual number. During disk access, the reverse conversion is done by the INT13h routine.



Maximum HDD size:

no. Cylinders	(1024)
x no. Heads	( 32)
x no. Sectors	( 63)
x bytes per sector	( 512)

---

1 gigabyte

**Note:**

*To support LBA or Large mode, address translation software is included in the Award BIOS HDD Service Routine (INT13h). If you are running an operating system that bypasses the BIOS Int13 Service Routine, LBA and Large Mode may fail.*

### HDD Low Level Format

The HDD Low Level Format utility is designed as a tool to save you time formatting your hard disk. It automatically looks for the necessary information of the drive you selected. This utility also searches for bad tracks and lists them for your reference. Highlight this option and press <Enter>. A screen similar to the one below will appear.

ROM PCI/ISA BIOS  
CMOS SETUP UTILITY  
AWARD SOFTWARE, INC.

Hard Disk Low Level Format Utility								No. CYLS HEAD
SELECT DRIVE BAD TRACK LIST PERFORMED								
Current select drive is : C								
DRIVE: C CYLINDER: 0 HEAD: 0								
	SIZE	CYLS	HEAD	RECOMP	LANDZ	SECTOR	MODE	
Primary Master:	853	1654	16	65536	1653	63	AUTO	
Primary Slave:	0	0	0	0	0	0	AUTO	
Secondary Master:	0	0	0	0	0	0	AUTO	
Secondary Slave:	0	0	0	0	0	0	AUTO	
Up/Down-Select item    ENTER-Accept    ESC-Exit/Abort								
Copyright (C) Award Software, Inc. 1992-94 All Rights Reserved								

**Warning:**

*Do not use this HDD Low Level Format feature for IDE hard drives. They already have been low-level formatted at the factory. Do a high-level format only for those drives.*



## Save & Exit Setup

When all the changes have been made, highlight “Save & Exit Setup” and press <Enter>. The message below will appear:

*Save to CMOS and Exit (Y/N)? N*

Type “Y” and press <Enter>. The modifications you have made will be written into the CMOS memory, and the system will reboot. You will once again see the initial diagnostics on the screen. If you wish to make additional changes to the setup, press <Ctrl> <Alt> <Esc> simultaneously or <Del> after memory testing is done.

## Exit Without Saving

When you do not want to save the changes you have made, highlight “Exit Without Saving” and press <Enter>. The message below will appear:

*Quit Without Saving (Y/N)? N*

Type “Y” and press <Enter>. The system will reboot and you will once again see the initial diagnostics on the screen. If you wish to make any changes to the setup, press <Ctrl> <Alt> <Esc> simultaneously or <Del> after memory testing is done.

## Desktop Management Interface (DMI)

The G586IPC system board comes with a DMI built into the BIOS. DMI, along with the appropriately networked software, is designed to make inventory, maintenance and troubleshooting of computer systems easier. With DMI, a network administrator or MIS engineer can remotely access some information about a particular computer system without physically going to it. Quite often a service call may be unnecessary as the problem can be solved remotely.

The DMI utility in the BIOS automatically records various information about your system configuration. Information about the type and speed of CPU, type and amount of memory for each memory slot, BIOS revision level, types of add-in PCI boards and components, certain revision numbers of hardware installed, etc. are automatically detected and

stored in the DMI pool, which is a part of the system board's Plug and Play BIOS. Additional information, such as ISA based peripherals, which may not be automatically detected, can be manually recorded in the DMI pool by using the Add DMI menu. The DMI pool data is then verified or updated whenever the system hardware or setup is altered.

## Running the DMI Utility

To run the DMI utility, type: DMICFG.EXE. You can download this utility from <http://www.dfi.com.tw> - BIOS & DRIVERS section or <ftp.dfiusa.com> - /pub/DMI directory.

The DMI utility must run in real mode with at least 180K of base memory. Memory managers like HIMEM.SYS (required by Windows) must not be installed. To do this, boot up from a system diskette without the AUTOEXEC.BAT and CONFIG.SYS files, "REM" HIMEM.SYS in the CONFIG.SYS or press <F5> during bootup to bypass your AUTOEXEC.BAT and CONFIG.SYS files.

## Using the DMI Utility

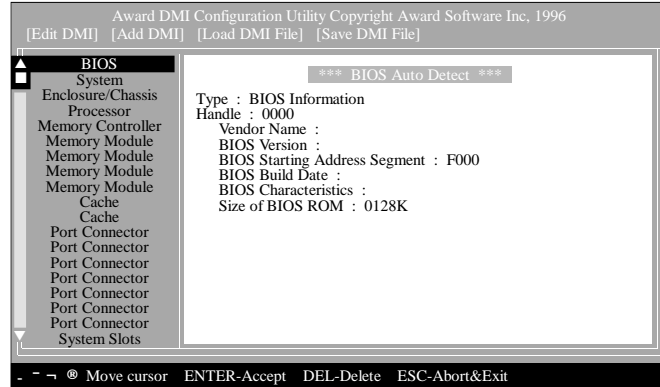

The four menus located on top of the DMI Configuration Utility screen are Edit DMI, Add DMI, Load DMI File and Save DMI File. Use the ← or → (left or right) arrow keys to select a menu from the Menu bar.

On the left side of the screen is a list of the system configuration items. Use the ↑ or ↓ (up or down) arrow keys to select an item.



The commands at the bottom of the screen will allow you to navigate through the various setup menus.

### **Edit DMI**

1. Use the ← or → arrow keys to select the Edit DMI menu.
2. Highlight the item on the left screen that you would like to edit by using the ↑ or ↓ arrow keys, then press <Enter>.
3. The cursor will move to the screen you select allowing you to edit information. The screen will also display the auto-detected information.
4. Press <F10> to update the edited information into the flash ROM.

### **Add DMI**

1. Use the ← or → arrow keys to select the Add DMI menu.
2. Highlight the item on the left screen that you would like to add by using the ↑ or ↓ arrow keys, then press <Enter>.
3. The cursor will move to the screen you select allowing you to enter information about the added item.
4. Press <F10> to save information into the flash ROM.

To view information about the added items, go to the Edit DMI menu.

### **Load DMI File**

1. Use the ← or → arrow keys to select the Load DMI File menu.
2. The following message will appear.

*Press [Enter] to select DMI file for load*

Press <Enter>.





3. The DMI files will appear on the screen. Select the file you would like to load and press <Enter>.

4. The following message will appear.

*Do you want to execute? (Y/N)*

Type <Y>. All previous DMI structures will be destroyed and the new file will be saved into the flash ROM.

### **Save DMI File**

1. Use the ← or → arrow keys to select the Save DMI File menu.

2. The following message will appear.

*Press [Enter] to select DMI file for save*

Press <Enter>.

3. Enter the directory and filename under which you would like the DMI file saved.



## System Error Report

When the BIOS encounters an error that requires the user to correct something, either a beep code will sound or a message will be displayed in a box in the middle of the screen and the message, PRESS F1 TO CONTINUE, CTRL-ALT-ESC or DEL TO ENTER SETUP, will be shown in the information box at the bottom. Enter Setup to correct the error.

### POST Beep

There are two kinds of beep codes in the BIOS. One code indicates that a video error has occurred and the BIOS cannot initialize the video screen to display any additional information. This beep code consists of a single long beep followed by three short beeps. The other code indicates that a DRAM error has occurred. This beep code consists of a single long beep.

### Error Messages

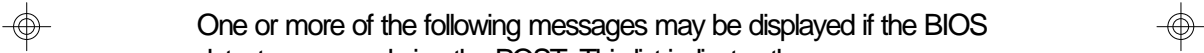

One or more of the following messages may be displayed if the BIOS detects an error during the POST. This list indicates the error messages for all Awards BIOSes:

#### CMOS CHECKSUM ERROR

Checksum of CMOS is incorrect. This can indicate that CMOS has become corrupt. This error may have been caused by a weak battery. Check the battery and replace if necessary.

#### DISPLAY SWITCH IS SET INCORRECTLY

The display switch on the motherboard can be set to either monochrome or color. This indicates the switch is set to a different setting than indicated in Setup. Determine which setting is correct, then either turn off the system and change the jumper or enter Setup and change the VIDEO selection.

#### FLOPPY DISK(S) fail (80)

Unable to reset floppy subsystem.





#### **FLOPPY DISK(S) fail (40)**

Floppy type mismatch.

#### **Hard Disk(s) fail (80)**

HDD reset failed.

#### **Hard Disk(s) fail (40)**

HDD controller diagnostics failed.

#### **Hard Disk(s) fail (20)**

HDD initialization error.

#### **Hard Disk(s) fail (10)**

Unable to recalibrate fixed disk.

#### **Hard Disk(s) fail (08)**

Sector Verify failed.

#### **Keyboard is locked out - Unlock the key**

The BIOS detects that the keyboard is locked. Keyboard controller is pulled low.

#### **Keyboard error or no keyboard present**

Cannot initialize the keyboard. Make sure the keyboard is attached correctly and no keys are being pressed during the boot.

#### **Manufacturing POST loop**

System will repeat POST procedure infinitely while the keyboard controller is pull low. This is also used for M/B burn in test at the factory.

#### **BIOS ROM checksum error - System halted**

The checksum of ROM address F0000H-FFFFFFH is bad.

#### **Memory test fail**

BIOS reports memory test fail if the memory has error(s).

## **Driver Installation**

To install the IDE drivers supported by the G586IPC system board, please refer to the "Readme" file contained in the provided diskettes.



## Chapter 4 Troubleshooting Checklist

---

This chapter of the manual is designed to help you with problems that you may encounter with your personal computer. To efficiently troubleshoot your system, treat each problem individually. This is to ensure an accurate diagnosis of the problem in case a problem has multiple causes.

Some of the most common things to check when you encounter problems while using your system are listed below.

1. The power switch of each peripheral device is turned on.
2. All cables and power cords are tightly connected.
3. The electrical outlet to which your peripheral devices are connected is working. Test the outlet by plugging in a lamp or other electrical device.
4. The monitor is turned on.
5. The display's brightness and contrast controls are adjusted properly.
6. All add-in boards in the expansion slots are seated securely.
7. Any add-in board you have installed is designed for your system and is set up correctly.

### Monitor/Display

If the display screen remains dark after the system is turned on:

1. Make sure that the monitor's power switch is on.
2. Check that one end of the monitor's power cord is properly attached to the monitor and the other end is plugged into a working AC outlet. If necessary, try another outlet.
3. Check that the video input cable is properly attached to the monitor and the system's display adapter.
4. Adjust the brightness of the display by turning the monitor's brightness control knob.



The picture seems to be constantly moving.

1. The monitor has lost its vertical sync. Adjust the monitor's vertical sync.
2. Move away any objects, such as another monitor or fan, that may be creating a magnetic field around the display.

The screen seems to be constantly wavering.

1. If the monitor is close to another monitor, the adjacent monitor may need to be turned off. Fluorescent lights adjacent to the monitor may also cause screen wavering.

### **Power Supply**

When the computer is turned on, nothing happens.

1. Check that one end of the AC power cord is plugged into a live outlet and the other end properly plugged into the back of the system.
2. Make sure that the voltage selection switch on the back panel is set for the correct type of voltage you are using.
3. The power cord may have a "short". Inspect the cord and install a new one if necessary.

### **Floppy Drive**

The computer cannot access the floppy drive.

1. The floppy diskette may not be formatted. Format the diskette and try again.
2. The diskette may be write-protected. Use a diskette that is not write-protected.
3. You may be writing to the wrong drive. Check the path statement to make sure you are writing to the targeted drive.
4. There is not enough space left on the diskette. Use another diskette with adequate storage space.



### **Hard Drive**

Hard disk failure.

1. Make sure the correct drive type for the hard disk drive has been entered in the BIOS.
2. If the system is configured with two hard drives, make sure the bootable (first) hard drive is configured as Master and the second hard drive is configured as Slave.

Excessively long formatting period.

1. If your hard drive takes an excessively long period of time to format, it is likely a cable connection problem.

### **Parallel Port**

The parallel printer doesn't respond when you try to print.

1. Make sure that your printer is turned on and that the printer is on-line.
2. Make sure your software is configured for the right type of printer attached.
3. Verify that the onboard LPT port's I/O address and IRQ settings are configured correctly.
4. Verify that the attached device works by attaching it to a parallel port that is working and configured correctly. If it works, the printer can be assumed to be in good condition. If the printer remains inoperative, replace the printer cable and try again.

### **Serial Port**

The serial device (modem, printer) doesn't output anything or is outputting garbled characters.

1. Make sure that the serial device's power is turned on and that the device is on-line.
2. Verify that the device is plugged into the correct serial port on the rear of the computer.



3. Verify that the attached serial device works by attaching it to a serial port that is working and configured correctly. If the serial device does not work, either the cable or the serial device has a problem. If the serial device works, the problem may be due to the onboard I/O or the address setting.
4. Make sure the COM settings and I/O address are configured correctly.

### **Keyboard**

Nothing happens when a key on the keyboard was pressed.

1. Make sure the keyboard is properly connected.
2. Make sure there are no objects resting on the keyboard and that no keys are pressed during the booting process.

### **System Board**

1. Make sure the add-in card is seated securely in the expansion slot. If the add-in card is loose, power off the system, re-install the card and power up the system.
2. Check the jumper settings to ensure that the jumpers are properly set.
3. Verify that all SIMMs are seated securely into the SIMM sockets.
4. Make sure the SIMMs are in the correct locations.
5. If the board fails to function, place the board on a flat surface and seat all socketed components. Gently press each component into the socket.
6. If you made changes to the BIOS settings, re-enter setup and load the BIOS defaults.



## Appendix A Types of Modules

---

The following modules have been tested with this board. Most untested brands will work but a few may fail to do so.

SMM	Brand	Chip Number
1MBx32/x36	Fujitsu	81C1000A-70
	OKI	M51440A-70
2MBx32/x36	OKI	M511000B-70
	NEC	424400-60
	Micron	40447-60
	TI	TMS4400DJ-70
	Micron	MT4C4007-70 (EDO)
	Micron	MT4C4007-60 (EDO)
	NEC	4218165-60 (EDO)
4MBx32/x36	Hitachi	7400AS-70
	Fujitsu	8117400-70
	Mitsubishi	422A06-70
	Hitachi	5117400AS-70
	NEC	4217400-60
	NEC	4217405-70 (EDO)
8MBx32/x36	NEC	4217405-60 (EDO)



## Appendix B Memory and I/O Maps

---

### Memory Address Map

Address	Name	Function
0000000 to 009FFFF	640KB System Board RAM	System Board Memory
00A0000 to 00BFFFF	128KB Video Display Memory	Reserved for Graphics Display Memory
00C0000 to 00E7FFF	160KB I/O Expansion ROM	Reserved for ROM on I/O Adapter Card
00E8000 to 00FFFFFF	96KB ROM on the System Board	System Board BIOS
0100000 to FFFFFFFF	Maximum Memory 256MB	System Board Memory

## I/O Address Map

I/O Address	Function
0000-001F	DMA Controller 1, 8237A-5
0020-003F	Interrupt Controller 1, 8259A, Master
0040-005F	Timer, 8254-2
0060-006F	8742 (Keyboard Controller)
0070-007F	Real-time Clock, NMI (Non-maskable Interrupt) Mask
0080-009F	DMA Page Memory, 74LS612
00A0-00BF	Interrupt Controller 2, 8259A
00C0-00DF	DMA Controller 2, 8237A-5
00E8	Shadow RAM and Cache Control Bit
00F0	Clear Numeric Processor Extension Busy
00F1	Reset Numeric Processor Extension
00F8-00FF	Numeric Processor Extension
01F0-01F8	Fixed Disk
0200-0207	Game I/O
0278-027F	Parallel Printer Port 2
02F8-02FF	Serial Port 2
0300-031F	Prototype Card
0360-036F	Reserved
0378-037F	Parallel Printer Port 1
0380-038F	SDLC, Bisynchronous 2
03A0-03AF	Bisynchronous 1
03B0-03BF	Monochrome Display and Printer Adapter
03C0-03CF	Reserved
03D0-03DF	Color/Graphics Monitor Adapter
03F0-03F7	Diskette Controller
03F8-03FF	Serial Port 1

**Note:**

The I/O address hex 0000 to 00FF are reserved for the system board I/O. Hex 0100 to 03FF are available on the I/O channels.





## Appendix C Connectors

---

### Connectors

J1	PS/2 mouse connector
J2	COM 1 serial port
J3	COM 2 serial port
J4	Floppy disk drive connector
J5	Parallel printer port
J6	Primary IDE hard disk drive connector
J7	Secondary IDE hard disk drive connector
J8	Fan connector
J9	Infrared connector
J10	Primary/Secondary IDE LED connector
J11	Green LED connector
J13	Green button connector
J14	Reset switch connector
J15	Speaker connector
J16	Power LED/Keylock connector
CN1	PS/2 keyboard connector
CN2	AT keyboard connector
PL1	Power connector
JP1	USB connector
JP2	USB connector



## Pin Assignment

**J10 - IDE LED connector**

Pin	Function
1	Signal
2	+5V

**J11 - Green LED connector**

Pin	Function
1	Signal
2	+5V

**J13 - Green button connector**

Pin	Function
1	Ground
2	Signal

**J14 - Reset switch connector**

Pin	Function
1	Ground
2	Reset

**J9 - Infrared connector**

Pin	Function
1	IrTX
2	Ground
3	IrRX
4	Reserved
5	+5V

**J16 - Power LED/Keylock**

Pin	Function
1	Power LED
2	Reserved
3	Ground
4	Keylock Signal
5	Ground

**J15 - Speaker connector**

Pin	Function
1	Signal
2	Reserved
3	Ground
4	+5V

**J8 - Fan connector**

Pin	Function
1	Ground
2	+12V
3	Ground

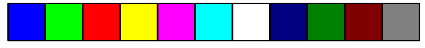

### J1 - PS/2 mouse connector

Pin	Function
1	Mouse Data
2	Reserved
3	Ground
4	+5V
5	Mouse Clock
6	Reserved

### JP1 - USB connector

Pin	Function
1	+5V
2	-Data
3	+Data
4	Ground
5	Ground

### JP2 - USB connector

Pin	Function
1	+5V
2	-Data
3	+Data
4	Ground
5	Key