



# **G486VPC**

**Rev. A+**  
**System Board**  
**User's Manual**



**- D30060524 -**





## FCC Statement on Class B

This equipment has been tested and found to comply with the limits for a Class B digital device, pursuant to Part 15 of the FCC rules. These limits are designed to provide reasonable protection against harmful interference when the equipment is operated in a residential installation. This equipment generates, uses and can radiate radio frequency energy and, if not installed and used in accordance with the instruction manual, may cause harmful interference to radio communications. However, there is no guarantee that interference will not occur in a particular installation. If this equipment does cause harmful interference to radio or television reception, which can be determined by turning the equipment off and on, the user is encouraged to try to correct the interference by one or more of the following measures:

- Reorient or relocate the receiving antenna.
- Increase the separation between the equipment and the receiver.
- Connect the equipment into an outlet on a circuit different from that to which the receiver is connected.
- Consult the dealer or an experienced radio TV technician for help.

### Notice:

1. The changes or modifications not expressly approved by the party responsible for compliance could void the user's authority to operate the equipment.
2. Shielded interface cables must be used in order to comply with the emission limits.

The manufacturer makes no warranties with respect to this documentation and disclaims any implied warranties of merchantability, quality, or fitness for any particular purpose. The information in this document is subject to change without notice. The manufacturer reserves the right to make revisions to this publication and to make changes to any and/or all parts of its content, at any time, without obligation to notify any person or entity of such changes. Further, the manufacturer assumes no responsibility for any errors that may appear in this document.

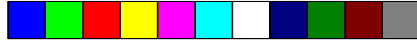

## Table of Contents

<b>Chapter 1: Introduction .....</b>	<b>5</b>
Features and Specifications .....	6
Package Checklist .....	8
<b>Chapter 2: Hardware Installation .....</b>	<b>9</b>
Preparing the Area .....	9
Handling the System Board .....	9
Static Electricity Precautions .....	10
Installing the System Board .....	10
Board Layout .....	12
System Memory .....	13
Installing a SIM Module .....	13
Memory Configuration .....	14
Cache Memory .....	16
Jumper Settings for Cache Memory .....	16
CPU Installation .....	16
Jumper Settings for CPU .....	17
Installing Upgrade CPUs .....	21
Jumper Settings for PCI Slots .....	24
Jumper Settings for CMOS Clean .....	25
Jumper Settings for EPROM Type .....	25
Factory Testing Jumpers .....	26
Built-in Ports .....	27
Serial Ports .....	27
PS/2 Mouse Port .....	28
Parallel Port .....	28
Floppy Disk Drive Controller .....	28
IDE Hard Disk Interface .....	29
Installing Expansion Cards .....	31
<b>Chapter 3: Software Installation .....</b>	<b>32</b>
Award BIOS CMOS Setup Utility .....	32
Standard CMOS Setup .....	33
BIOS Features Setup .....	35
Chipset Features Setup .....	36
Power Management Setup .....	37
PCI Configuration Setup .....	38
Load BIOS Defaults .....	38

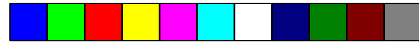

Load Setup Defaults .....	38
Supervisor Password .....	39
User Password .....	40
IDE HDD Auto Detection .....	40
Save & Exit Setup .....	43
Exit Without Saving .....	43
System Error Report .....	44
<b>Chapter 4: Troubleshooting Checklist .....</b>	<b>47</b>
<b>Appendix A: Types of Modules .....</b>	<b>48</b>
<b>Appendix B: Memory and I/O Maps .....</b>	<b>49</b>
<b>Appendix C: PCI I/O Pin Assignments .....</b>	<b>51</b>
<b>Appendix D: ISA I/O Pin Assignments .....</b>	<b>52</b>
<b>Appendix E: System Overview .....</b>	<b>53</b>
<b>Appendix F: Connector Pin Assignments .....</b>	<b>55</b>
<b>Appendix G: Award BIOS Hard Disk Table .....</b>	<b>60</b>





## Chapter 1 Introduction

---

The G486VPC system board is an Energy Star compliant system board that reduces energy consumption by automatically turning off peripherals when not in use.

The G486VPC system board is equipped with a 237-pin Zero Insertion Force (ZIF) CPU socket that allows users to easily upgrade their processor with Intel, AMD, Cyrix or SGS-Thomson CPUs.

The G486VPC system board uses Award BIOS (Windows 95 Plug and Play compatible) that supports Enhanced IDE HDDs larger than 528MB.

The G486VPC can support 1MB to 64MB of system memory using x32 or x36 DRAM. It also supports 128KB or 256KB Level 1 and Level 2 write-back/write-through cache.

Equipped with one built-in VL-bus IDE connector and one ISA IDE connector, the G486VPC system board can control four drives and supports fast Mode 3 and Mode 4 HDDs. This system board is also equipped with two NS16C550A-compatible serial ports, an ECP/EPP parallel port, a floppy disk drive controller, one PS/2 mouse port and one AT or optional PS/2 keyboard connector.

The G486VPC design is based on the Peripheral Component Interconnect (PCI) local bus and Industry Standard Architecture (ISA) standards. It is equipped with 6 dedicated ISA slots, and 1 shared PCI/8-bit ISA slot.



## Features and Specifications

### Processor

- 5V CPUs - Intel, Cyrix and SGS-Thomson
- 3.3V CPUs - Intel, AMD, Cyrix and SGS-Thomson

### Chipset

- VIA VT82C496 - system and cache controller
- VIA VT82C505 - PCI bridge
- VIA VT82C416 - peripheral chip

### Cache Memory

- 128KB or 256KB
- Supports Level 1 and Level 2 write-back/write-through cache

### System Memory

- 1MB to 64MB
- Three 72-pin SIMM sockets
- Supports memory parity-check function
- 256KBx36/x32, 1MBx36/x32, 4MBx36/x32, and 16MBx36/x32 (SM1-SM3)
- 512KBx36/x32, 2MBx36/x32, and 8MBx36/x32 (SM1 or SM3)

### BIOS

- Award BIOS, Windows 95 Plug and Play compatible (Flash EPROM or EPROM)
- Supports Enhanced IDE HDDs larger than 528MB
- System and EGA/VGA BIOS shadow

### Energy Efficient Design

- Supports SMM mode and CPU stopped clock
- Hardware supports flexible event-driven power management scheme and easy CPU state transition: Ready, Doze and Suspend
- Microsoft APM 1.1 compliant
- EPA Energy Star compliant design



### **Integrated I/O**

- Uses UMC super I/O controller
- Two NS16C550A-compatible enhanced serial ports
- One ECP/EPP parallel port
- Supports 360KB, 720KB, 1.2MB, 1.44MB, and 2.88MB floppy drives
- Two fast IDE connectors:
  - Primary IDE is a VL-Bus IDE to support Mode 3 and Mode 4 HDDs
  - Secondary IDE is an ISA IDE to support one tape drive and one ATAPI CD-ROM drive

### **ZIF Socket**

- 237-pin ZIF socket (Intel Socket 3)

### **Connectors**

- 2 serial ports
- 1 parallel port
- 2 IDE connectors
- 1 floppy connector
- 1 PS/2 mouse port
- 1 AT keyboard connector or optional mini-DIN-6 PS/2 keyboard port

### **Expansion Slots**

- 6 dedicated 16-bit ISA slots
- 1 shared PCI/8-bit ISA slot

### **PCB**

- Four layers, Baby AT form factor
- 25cm (9.84") x 22cm (8.66")



## Package Checklist

The G486VPC package contains the following items:

- The G486VPC system board
- The G486VPC user's manual
- One 40-pin IDE hard disk cable
- One 34-pin floppy disk drive cable
- One 25-pin printer port cable for chassis mounting
- Two 9-pin serial port cables for chassis mounting
- One PS/2 mouse port cable for chassis mounting

If any of these items are missing or damaged, please contact your dealer or sales representative for assistance.







## Chapter 2 Hardware Installation

---

This chapter summarizes the steps to install the G486VPC system board into your system unit. It also includes a description of the area in which you must work and directions for memory installation. Before installing the system board, obtain the memory you plan to install. Please refer to the memory chart on pages 14 and 15 for the number and type of SIM modules needed for the amount of memory you require.

### Preparing the Area

Before unpacking the system board, make sure the location you have selected is relatively free of dust and static electricity. Excessive exposure to dust, static electricity, direct sunlight, excessive humidity, extreme cold, and water can damage the operational capabilities of your system board. Avoid placing the unit on surfaces such as carpeted floors. These areas also attract static electricity which can damage some circuits on your system board.

Make sure the power source has a properly grounded, three-pronged socket. It is essential that the power connection be properly grounded for correct functioning of your system board. For further protection, we recommend that you use a surge suppressor. This will protect the system board from damage that may result from a power surge on the electrical line.

Move items that generate magnetic fields away from your system board since magnetic fields can also damage your system board. Once you have selected the ideal location, unpack the G486VPC system board carefully.

### Handling the System Board

It is quite easy to inadvertently damage your system board even before installing it in your system unit. Static electrical discharge can damage computer components without causing any signs of physical damage. You must take extra care in handling the system board to ensure against electrostatic build-up.



## Static Electricity Precautions

1. To prevent electrostatic build-up, leave the board in its anti-static bag until you are ready to install it.
2. Wear an antistatic wrist strap.
3. Do all preparation work on a static-free surface with system board components facing up.
4. Hold the system board only by its edges. Be careful not to touch any of the components, contacts or connections, especially gold contacts, on the board.
5. Avoid touching the pins or contacts on all modules and connectors. Hold modules and connectors by their ends.

### **Warning:**

*Electrostatic discharge (ESD) can damage your processor, disk drives, add-in boards, and other components. Perform the upgrade instruction procedures described at an ESD workstation only. If such a station is not available, you can provide some ESD protection by wearing an anti-static wrist strap and attaching it to a metal part of the system chassis. If a wrist strap is unavailable, establish and maintain contact with the system chassis throughout any procedures requiring ESD protection.*

## Installing the System Board

If you are installing the G486VPC system board, the following outlines the basic installation steps. Before installing the system board into your system unit, you should prepare the tools you will need.

You will need:

- One medium size, flat-bladed screwdriver
- One medium Phillips screwdriver
- One needle-nosed pliers

1. Unlock your system unit. Turn off the power and disconnect all power cords and cables.



2. Remove the system unit cover. Refer to the manufacturer's instructions if necessary.
3. Remove expansion cards seated in any of the expansion slots and detach all connectors from the old system board.
4. Loosen the screws holding the original system board and remove the board from the system. Save the screws.
5. Remove the G486VPC from its original packing box. Be careful to avoid touching all connectors and pins on the board. Please refer to the handling instructions on pages 9-10 for proper handling techniques.
6. Insert the SIMMs into the SIMM sockets on the G486VPC. The quantity and location of the SIMMs depends on the memory configuration and type of modules you intend to use.
7. Install the CPU. Be sure pin 1 of the CPU is aligned with pin 1 of the socket.
8. Set the corresponding jumpers.
9. Install the prepared G486VPC system board into the case and replace the screws.
10. Reinstall all cards and connectors and replace the system unit cover. Reconnect all power cords and cables.





# Board Layout

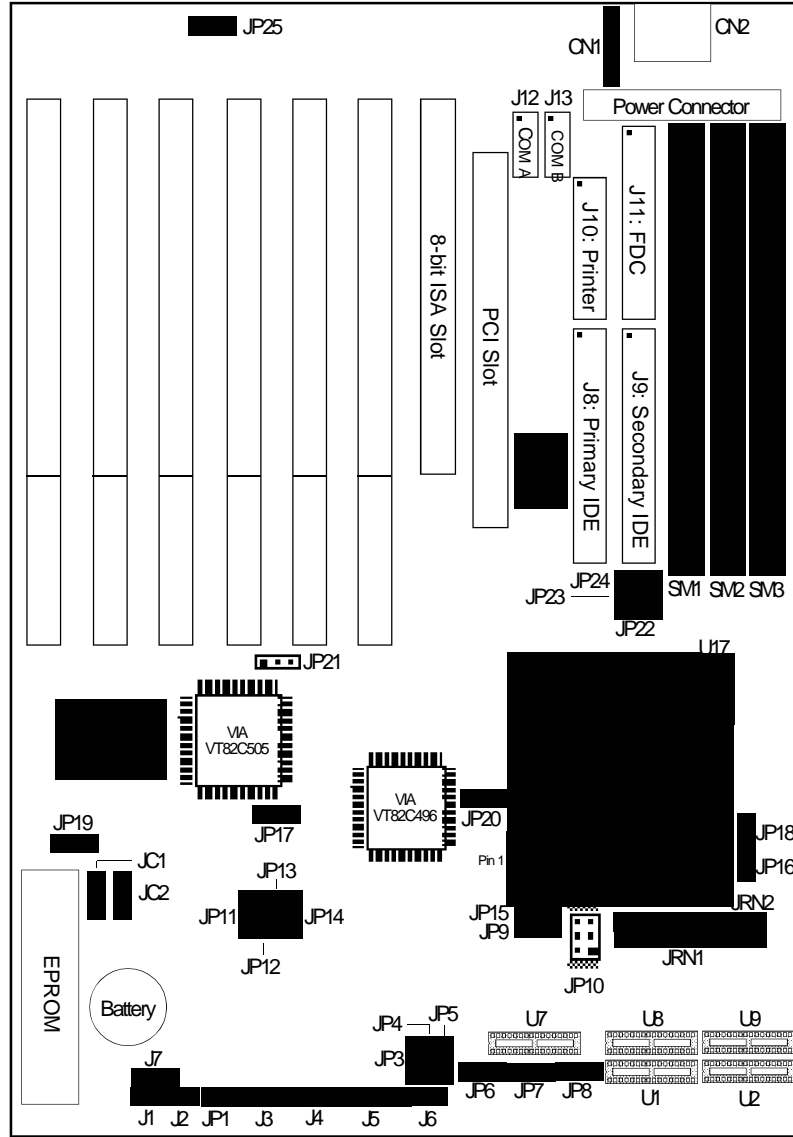

■ Pin 1

## System Memory

The G486VPC system board can support 1MB to 64MB of memory using 72-pin SIMMs (Single In-line Memory Module).

The G486VPC system board uses 256KBx36/x32, 1MBx36/x32, 4MBx36/x32, and 16MBx36/x32 HSIM modules installed in SM1-SM3 SIMM sockets or 512KBx36/x32, 2MBx36/x32, and 8MBx36/x32 installed in SM1 or SM3 SIMM sockets. You will need 1 to 3 pieces of SIM modules, depending on the amount of memory you intend to install. Refer to page 12 for the locations of the SIMM sockets.

**Note:**

*The G486VPC system board supports fast page mode DRAM only.*

### Installing a SIM Module

A SIM module simply snaps into a socket on the system board. Pin 1 of the SIM module must correspond with Pin 1 of the socket.

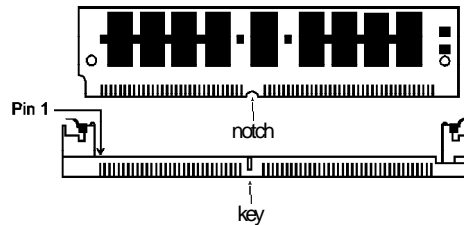

1. Position the SIMM above the socket with the “notch” in the module aligned with the “key” on the socket.
2. Seat the module at a 45° angle into the bank. Make sure it is completely seated. Tilt the module upright until it locks in place in the socket.



## Memory Configuration

The table below summarizes the bank locations and modules needed for the corresponding memory sizes.

Memory Size	SV1	SV2	SV3
1MB	1M	—	—
2MB	1M	1M	—
3MB	1M	1M	1M
4MB	4M	—	—
5MB	4M	1M	—
6MB	4M	1M	1M
8MB	4M	4M	—
9MB	4M	4M	1M
12MB	4M	4M	4M
16MB	16M	—	—
17MB	16M	1M	—
18MB	16M	1M	1M
20MB	16M	4M	—
21MB	16M	4M	1M
24MB	16M	4M	4M
32MB	16M	16M	—
33MB	16M	16M	1M
36MB	16M	16M	4M
48MB	16M	16M	16M
64MB	64M	—	—
2MB	2M(D)	—	—
3MB	2M(D)	—	1M
4MB	2M(D)	—	2M(D)
6MB	2M(D)	—	4M
18MB	2M(D)	—	16M
8MB	8M(D)	—	—
9MB	8M(D)	—	1M



Memory Size	SV1	SV2	SV3
12MB	8M(D)	—	4M
16MB	8M(D)	—	8M(D)
24MB	8M(D)	—	16M
32MB	16M(D)	—	16M(D)
32MB	32M(D)	—	—
33MB	32M(D)	—	1M
34MB	32M(D)	—	2M(D)
36MB	32M(D)	—	4M
40MB	32M(D)	—	8M(D)
48MB	32M(D)	—	16M
64MB	32M(D)	—	32M(D)

## Cache Memory

The G486VPC system board can be configured to two different cache sizes: 128KB and 256KB. Regardless of the amount of cache memory installed, one 32Kx8 is needed for tag RAM (U7) to store the cacheable addresses. Refer to page 12 for the locations of the SRAM sockets.

### Jumper Settings for Cache Memory

#### Jumpers JP6-JP8

Cache Memory Selection

Cache Size	Data SRAM (U1, U2, U8, & U9)	Tag SRAM (U7)	JP6	JP7	JP8
256KB	64Kx8x4	32Kx8	2-3 On	1-2 On	2-3 On
128KB	32Kx8x4	32Kx8	1-2 On	2-3 On	1-2 On

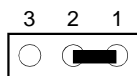

1-2 On

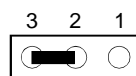

2-3 On

## CPU Installation

The G486VPC allows for easy installation of CPUs. Make sure all jumpers are set correctly before applying power or you may damage the CPU or system board. Please see the jumper settings on the following pages.



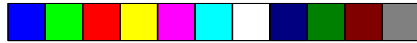

## Jumper Settings for CPU

### Jumpers JRN1, JRN2, JP16, JP18, JP20, JP22, and JP23

CPU Type

#### Jumpers JRN1 and JRN2

CPUs	Pin-out	JRN1	JRN2
Intel DX2, DX4, DX4 OverDrive, Pentium OverDrive AMD Standard, Enhanced, 5x86 Cyrix 5x86 SGS Thomson 5x86		1-2, 3-4, 5-6, 7-8, 9-10 On	1-2, 3-4, 5-6, 7-8, 9-10 Off
Cyrix DX2 SGS Thomson DX2		1-2, 3-4, 5-6, 7-8, 9-10 Off	1-2, 3-4, 5-6, 7-8, 9-10 On
Cyrix DX4 SGS Thomson DX4	Intel pin-out	1-2, 3-4, 5-6, 7-8, 9-10 On	1-2, 3-4, 5-6, 7-8, 9-10 Off
Cyrix DX4 SGS Thomson DX4	Cyrix pin-out	1-2, 3-4, 5-6, 7-8, 9-10 Off	1-2, 3-4, 5-6, 7-8, 9-10 On

**Note:**

*Please check your CPU dealer or sales representative whether your Cyrix DX4 or SGS Thomson DX4 CPU is designed in accordance to the Intel pin-out or Cyrix pin-out.*

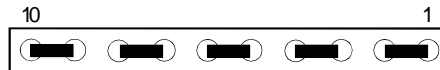

1-2, 3-4, 5-6, 7-8, 9-10 On

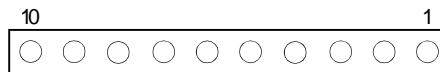

1-2, 3-4, 5-6, 7-8, 9-10 Off

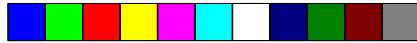

### Jumper JP16

CPU's	JP16
Intel DX2, DX4, DX4 OverDrive, Pentium OverDrive AMD Standard, DX4 SV8B, 5x86-150 Cyril DX2, DX4, 5x86 SGS Thomson DX2, DX4, 5x86	Off
AMD DX2 SV8B, 5x86-133/166	On



On



Off

### Jumper JP18

CPU's	JP18
Intel DX2, DX4, DX4 OverDrive, Pentium OverDrive AMD Enhanced, DX4 NV8T, 5x86 Cyril DX2, DX4, 5x86 SGS Thomson DX2, DX4, 5x86	Off
AMD DX2 NV8T	On



On



Off

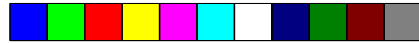

### Jumpers JP20 and JP23

CPU	JP20	JP23
Intel DX2	1-2 On	Off
Intel DX4, DX4 OverDrive, Pentium OverDrive AMD Standard, Enhanced, 5x86	1-2 On	2-3 On
Cyrix DX2, DX4, 5x86 SGS Thomson DX2, DX4, 5x86	1-2 On	1-2 On

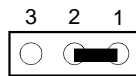

1-2 On

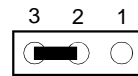

2-3 On

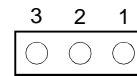

Off

### Jumper JP22

CPU	JP22
Intel DX2, DX4 AMD Standard, Enhanced, 5x86 Cyrix DX2, DX4, 5x86 SGS Thomson DX2, DX4, 5x86	1-2 On
Intel DX4 OverDrive, Pentium OverDrive	2-3 On

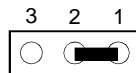

1-2 On

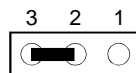

2-3 On

#### Note:

AMD Standard refers to 486DX2 NV8T and 486DX4 NV8T.  
 AMD Enhanced refers to 486DX2 SV8B and 486DX4 SV8B.

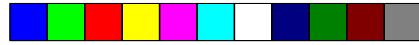

### Jumpers JP9, JP10 and JP15 CPU Voltage Selection

CPU Voltage	JP9	JP10	JP15
5V	1-2 On	1-2 On	1-2 On
3.45V	2-3 On	1-2 On	2-3 On
3.6V	2-3 On	3-4 On	2-3 On
4V	2-3 On	5-6 On	2-3 On

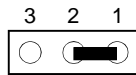

JP9, JP15  
1-2 On

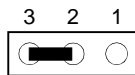

JP9, JP15  
2-3 On

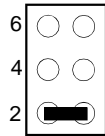

JP10  
1-2 On

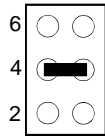

JP10  
3-4 On

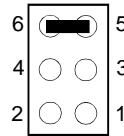

JP10  
5-6 On

### Jumpers JP3-JP5 CPU External Clock Selection

	JP3	JP4	JP5
25MHz	2-3 On	1-2 On	2-3 On
33MHz	1-2 On	2-3 On	2-3 On
40MHz	2-3 On	1-2 On	1-2 On

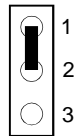

1-2 On

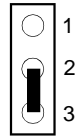

2-3 On

## Installing Upgrade CPUs

The G486VPC is equipped with a 237-pin Zero Insertion Force (ZIF) socket at location U17 of the system board. Refer to page 12 for the location of the ZIF socket. This socket is designed for easy removal of an old CPU and easy insertion of an upgrade CPU. The socket allows you to carefully place the new CPU into its position. If you need to apply excessive force to insert the CPU, you are not installing the CPU correctly.

### **Warning:**

*Open the socket only if you are actually installing a CPU. The warranty on the original CPU will be voided if the S/N seal is broken.*

*Before proceeding with the upgrade, take note of the following. The microprocessor and heat sink may be hot if the system has been running. To avoid the possibility of a burn, power the system off and let the processor and heat sink cool for 10 minutes.*

The 237-pin ZIF socket consists of four rows of pin holes on each side. To prevent improper installation, the ZIF socket has a Plug/Keying mechanism. Several holes in the socket are plugged so that the CPU will go in only one way. If you cannot easily insert the CPU, verify that pin 1 of the CPU is aligned with pin 1 of the socket.

### **Warning:**

*Be extremely careful to match pin 1 of the CPU with pin 1 of the socket. Usually pin 1 of the CPU is marked by a dot or a cut corner.*

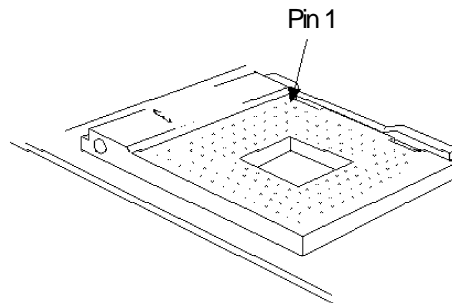

**Zero Insertion Force (ZIF) Socket**



To install an upgrade CPU, do the following.

1. Make sure the handle on the side of the ZIF socket is up. To raise the handle, push it down, slightly pull it out to the side, then raise it as far as it will go. It may be necessary to initially apply a small amount of sideways force to free the handle from its retaining "tab." Once clear of the "tab," the handle will open relatively easily. The top plate will slide back. Do not use screwdrivers or other tools to open the socket, or you may damage the system or socket.

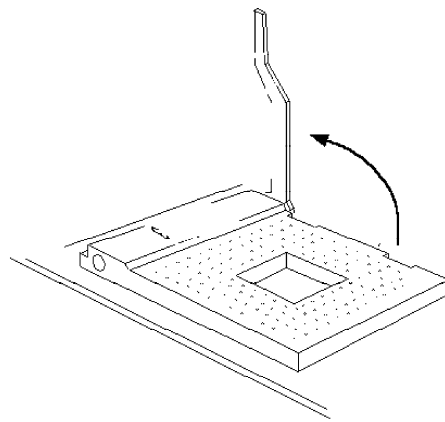

#### Lifting the Handle

2. Once the lever is completely up, remove the old CPU carefully by lifting it straight out of the socket. You are now ready to insert the new CPU.

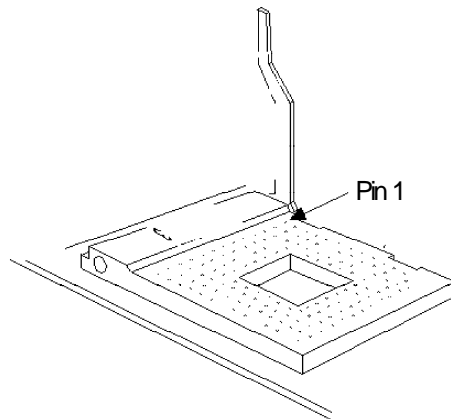



3. Position the CPU above the ZIF socket. Make sure pin 1 of the CPU is aligned with pin 1 of the socket. Lower the chip until the pins are inserted properly in their corresponding holes. Remember that very little force is needed to install the CPU. If the CPU is not easily inserted, verify whether or not pin 1 of the CPU is aligned with pin 1 of the socket. Applying too much pressure can damage the CPU or the socket.

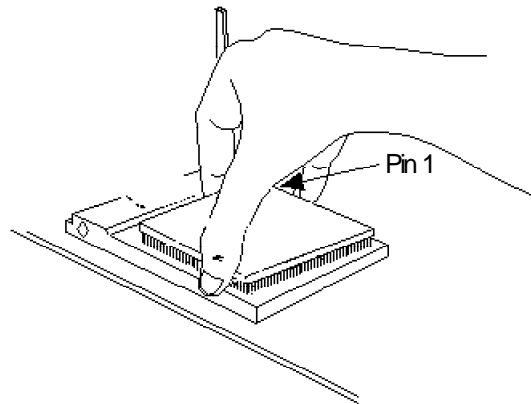

#### **Positioning the CPU Above the ZIF Socket**

4. Push the handle down until the handle locks into place. The top plate will slide forward. You will feel some resistance as the pressure starts to secure the CPU in the socket. This is normal and will not damage the CPU. However, if the handle is not completely closed, damage to the CPU and/or system board may result.

#### **Clearance Requirements**

Your CPU comes with a heat sink mounted on top. To maintain proper airflow once the CPU is installed on the system board, the CPU and heatsink require certain space clearances.

The clearance above the CPU's fan/heat sink must be at least 0.4 inches. The clearance on at least 3 of 4 sides of the CPU must be at least 0.2 inches. The cables (for floppy drive, hard drive, CD-ROM, etc.) must be routed clear of the CPU and its airspace.

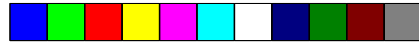

## Fan Exhaust

The CPU must be kept cool by using a fan with heatsink. The temperature of the air entering the fan/heatsink cannot exceed 45°C (113°F). The ambient or room temperature must be below 37°C (99°F).

In order to provide proper airflow to the CPU, all movable obstructions (power supply cables, cards, floppy disk cables) must be clear of the CPU fan/heatsink component in accordance with the space clearance discussed in the Clearance Requirements section of this manual.

## Jumper Settings for the PCI Slot

### Jumpers JP13 and JP21

CPU External Clock Speed for the PCI Slot

Set Jumpers JP13 and JP21 according to the type of CPU installed on the system board.

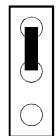

JP13: 1-2 On

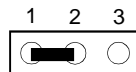

JP21: 1-2 On

CPU external clock speed  $\leq$  33MHz  
(Default)

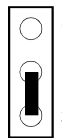

JP13: 2-3 On

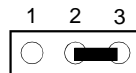

JP21: 2-3 On

CPU external clock speed = 40MHz



## Jumper Settings for CMOS Clean

### Jumper JC2 CMOS Clean Select

If, for some reason, the CMOS becomes corrupted, the system can be reconfigured with the default values stored in the ROM BIOS. To load the default values, switch off your computer and remove the cover. Touch the power supply box to discharge any static electric buildup in your body. Set JC2 pins 2 and 3 to On for approximately 5 seconds, then return to the default position (pins 1 and 2 to On). Put the cover back and power up your system.

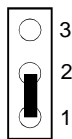

1-2 On: Normal  
(Default)

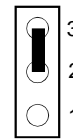

2-3 On: CMOS Clean

## Jumper Settings for EPROM Type

### Jumper JP19 EPROM Type Select

Jumper JP19 should be set to match the type of EPROM installed on the system board. Refer to page 12 for the location of the EPROM installed on your system board.

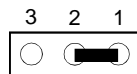

1-2 On: 12V Flash  
EPROM28F010

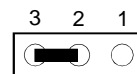

2-3 On: 5V Flash EPROM  
29F010, Flash EPROM 29EE010  
or EPROM 27C010

## Jumper Settings for Lithium Battery

### Jumper JC1 Lithium Battery

The G486VPC system board comes with a lithium battery. The default setting of JC1 is 1-2 On for battery conservation during shipment of the board. Before installing the system board onto your system unit, set JC1 to 2-3 On to use the lithium battery.

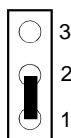

1-2 On: Default

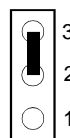

2-3 On: Lithium battery

## Factory Testing Jumpers

The following jumpers are for factory testing only and should always be set to their default configurations. Reconfiguring these jumpers will cause problems with your system board.

<b>JP1:</b> Off	<b>JP17:</b> 1-2 On
<b>JP11:</b> 1-2 On	<b>JP24:</b> Off
<b>JP12:</b> 1-2 On	<b>JP25:</b> 1-2 On
<b>JP14:</b> 1-2 On	

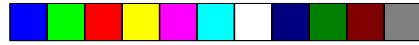

## Built-in Ports

The G486VPC system board is equipped with two serial ports, one parallel printer port, one FDD connector, two IDE hard disk shrouded headers and one PS/2 mouse connector. Refer to page 12 for the locations of the built-in connectors and pin 1 of those connectors.

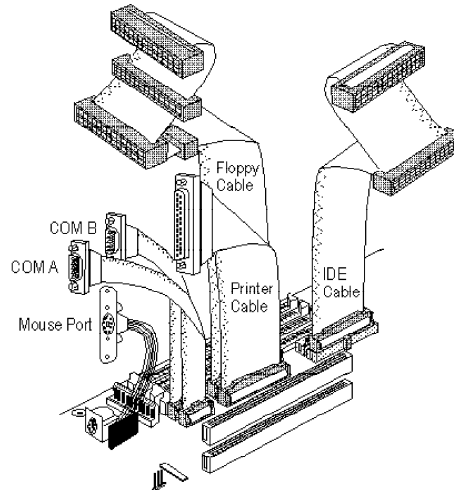

## Serial Ports

The built-in serial ports are RS-232C asynchronous communication ports with 16C550A-compatible UARTs that can be used with modems, serial printers, remote display terminals, and other serial devices. They use the following system I/O addresses:

Port Configuration	I/O Address
COM A	3F8h
COM B	2F8h

## Connecting the Serial Ports

Two DB-9P serial port cables are provided with the system board. Attach one serial port cable to connector J12 for the COM A primary serial port and the other serial port cable to connector J13 for the COM B secondary serial port. Make sure the colored stripes on the ribbon



cables are aligned with pin 1 of connectors J12 and J13. Use a small nutdriver to mount the cable into a DB-9 cutout in the system chassis.

### **PS/2 Mouse Port**

The PS/2 mouse port is a 6-pin connector on the system board. Attach the 6-pin mouse port cable, which came with the G486VPC, to connector CN1. Make sure the brown wire on the PS/2 mouse connector is aligned with pin 1 of connector CN1.

### **Parallel Port**

The G486VPC system board has a standard connector for interfacing your PC to a parallel printer. The parallel port on your system board can be set to any of the following system I/O addresses:

I/O Address: 3BC-3BE Hex  
378-37A Hex (default)  
278-27A Hex

### **Connecting the Parallel Printer Port**

Attach the DB-25S printer port cable, which came with the system board, to connector J10 on the G486VPC system board. Make sure the colored stripe on the ribbon cable aligns with pin 1 of connector J10. Use a small nutdriver to mount the cable into a DB-25 cutout in the system chassis.

### **Floppy Disk Drive Controller**

The G486VPC system board has a built-in floppy disk controller that supports two standard floppy disk drives. You can install any 360KB, 720KB, 1.2MB, 1.44MB, or 2.88MB floppy disk drives.

### **Connecting the Floppy Disk Cable**

1. Install the 34-pin header connector into the floppy disk connector (J11) on the system board. The colored edge of the ribbon should be aligned with pin 1 of connector J11.

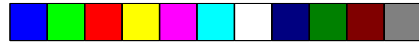

2. Install the other 34-pin header connector(s) into the disk drive(s). Align the colored edge of the daisy chained ribbon cable with pin 1 of the drive edge connector(s). The end-most connector should be attached to the drive you want to designate as Drive A.

## IDE Hard Disk Interface

The G486VPC system board is equipped with two VLB IDE shrouded headers that will interface four Enhanced IDE (Integrated Drive Electronics) hard disk drives.

### Note:

*Only IDE hard drives or ATAPI CD-ROMs can be connected to the IDE interface.*

## Connecting the IDE Hard Disk Interface

To prevent improper IDE cable installation, each PCI IDE shrouded header has a keying mechanism. The 40-pin connector on the IDE cable can be placed into the header only if pin 1 of the connector is aligned with pin 1 of the header.

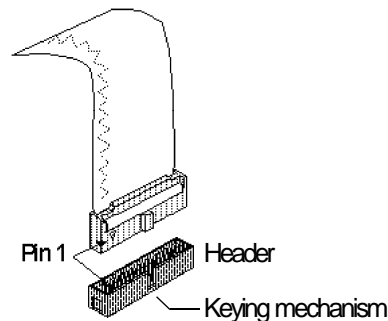

### Note:

*The IDE cable with a standard 40-pin connector (without the keying mechanism) can be installed in the PCI IDE shrouded header. Be extremely careful to match the colored edge of the ribbon with pin 1 of the header.*



## Connecting the Hard Disk Cable

1. If you are connecting two hard drives, install the 40-pin connector of the IDE cable into the primary IDE shrouded header (connector J8). If you are adding a third or fourth IDE device, install the 40-pin connector of the other IDE cable into the secondary IDE shrouded header (connector J9).
2. Install the other 40-pin header connector(s) into the device with the colored edge of the ribbon cable aligned with pin 1 of the drive edge connector(s).

### Note:

*Refer to your disk drive user's manual for information about selecting proper drive switch settings.*

## Adding a Second IDE Hard Drive

When using two IDE drives, one must be set as the master and the other as the slave. Follow the instructions provided by the drive manufacturer for setting the jumpers and/or switches on the drives. No changes are needed on the G486VPC system board when adding a second hard drive.

We recommend that the IDE hard drives be from the same manufacturer. In a few cases, drives from two different manufacturers will not function properly when used together. The problem lies in the hard drives, not the G486VPC system board.

## Preparing an IDE Drive for Use

IDE disk drives are already low-level formatted, with any bad-track errors entered, when shipped by the drive manufacturer. Do not attempt to do a low-level format or you may cause serious damage to the drive.

To use an IDE drive, you need to enter the drive type (this information is provided by the drive manufacturer) into the system's CMOS setup table. Then run FDISK and FORMAT provided with DOS.



**Warning:**

*Do not run FDISK and FORMAT programs on a drive that has already been formatted or you will lose all programs and data stored on the drive.*

## Installing Expansion Cards

The G486VPC system board is equipped with 6 dedicated 16-bit ISA slots and 1 shared PCI/8-bit ISA slot. You can only install one card in one or the other of the shared slots at a time; you cannot install devices in both slots at the same time. Refer to page 12 for the locations of the expansion slots.

**Note:**

*The BIOS needs to be configured for the PCI add-in card installed in the PCI slot. Refer to the "PCI Configuration Setup" presented in the "Software Installation" section of the manual.*





## Chapter 3 Software Installation

---

After you power up your system, the BIOS message appears on your screen and the memory count begins.

After the memory test, the following message will appear on the screen:

*Press DEL to enter setup*

If the message disappears before you respond, restart your system or press the “Reset” button on the front of your computer. You may also restart the system by pressing the <Ctrl> <Alt> and <Del> keys simultaneously. If you do not press these keys at the correct time and the system does not boot, the following error message will appear:

*Press Del to enter Setup*

If you have set a password and selected “System” in the Security Option of the BIOS Features Setup menu, you will be prompted for the password every time the system is rebooted or any time you try to enter Setup. Type in the correct password and press <Enter>.

If you selected “Setup” in the Security Option, you will be prompted for the password only when you try to enter Setup. Refer to the “BIOS Features Setup” section for more information.

### Award BIOS CMOS Setup Utility

Press <Ctrl> <Alt> <Esc> simultaneously or <Del> to enter the Setup utility. A screen similar to the one on the next page will appear.



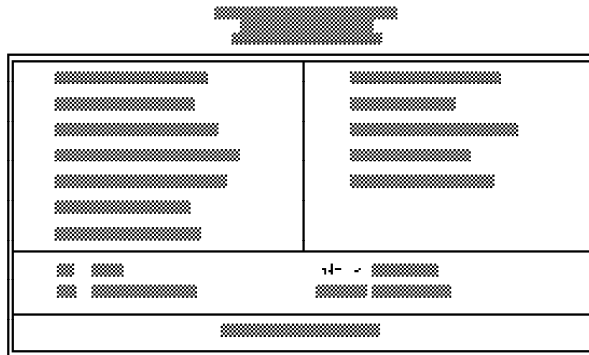
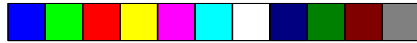

Use the arrow keys to highlight the option you want and press <Enter>. The following describes each of these options.

### Standard CMOS Setup

Use the arrow keys to highlight "Standard CMOS Setup" and press <Enter>. A screen similar to the one below will appear.

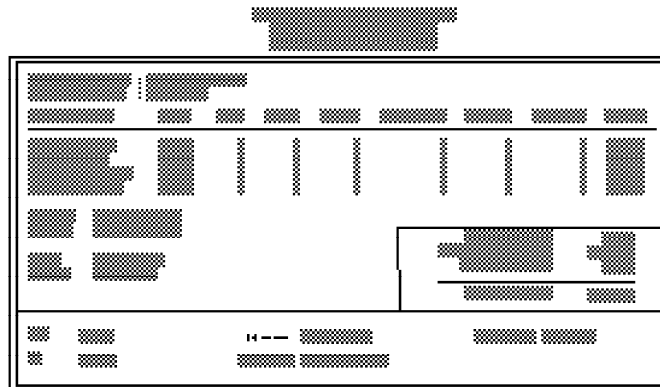

### Date and Time

This selection sets the time and date for the system. Press <F3> for the calendar.

### Hard Drive Type

This allows you to enter the appropriate specifications for the type of hard disk drive(s) installed in your system. Under the "Type" category,



you can select Auto, User, one of 46 predefined drive specifications or None.

**Auto:** This option indicates that the parameters for your hard disk drive(s) will be automatically detected and displayed when you boot your system. By default, the LBA mode is selected for a hard disk drive larger than 528 megabytes. If you decide not to accept the LBA mode, you can either specify your selection in the “IDE HDD Auto Detection” menu, or use the User option described below.

**User:** This type is user definable and allows you to enter the specifications yourself directly from the keyboard. Six categories of information are required: Size, Cylinders, Heads, Precomp, LandZone, Sectors and Mode. This information should be provided by your hard disk vendor or system manufacturer. However, we recommend you use the “IDE HDD Auto Detection” which provides a more efficient way to setup your hard drive.

**46 Predefined Drive Specifications:** The tables on pages 60 to 62 give complete listings of the available drive types. Any given hard drive must be set to one specific drive type number. Please refer to your hard disk documentation for the appropriate type number.

**None:** If a hard drive is not installed, select <None> and press <Enter>.

### **Drive A and Drive B**

These options are used to select the type of floppy disk drives installed in your system. If neither drive is present, select “None”. Make sure you choose the correct drive type; otherwise, your system might format the device improperly.

### **Video**

This is used to select the type of video adapter installed in your system.

### **Halt on**

This category controls whether the system will halt in case an error is detected during power up.



No Errors: The system boot will not stop for any detected errors.

All Errors: The system will stop whenever the BIOS detects a non-fatal error.

All, But Keyboard: The system will stop for any error except a keyboard error.

All, But Diskette: The system will stop for any error except a disk error.

All, But Disk/Key: The system will stop for any error except a keyboard or disk error.

### **Memory**

The lower right hand corner shows the base memory size, extended memory size, and the other memory size of your system. You cannot alter these items; your computer automatically detects and displays them.

The Other Memory size refers to the memory located in the 640K to 1024K address space. This is the memory used for different applications. DOS uses this area to load device drivers to free base memory for application programs.

When you are through making changes in the Standard CMOS Setup, press <Esc> to return to the main menu.

### **BIOS Features Setup**

Use the arrow keys to highlight "BIOS Features Setup" and press <Enter>, a screen similar to the one on the next page will appear.



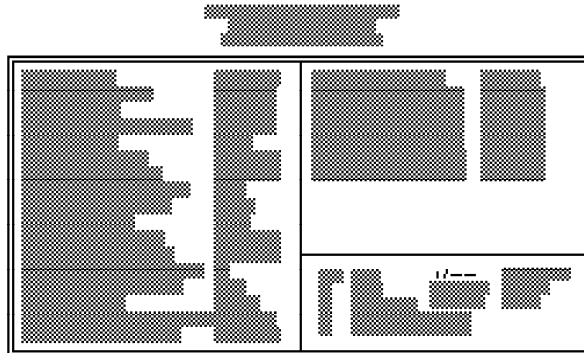

The Virus Warning option may be set to “Enabled” or “Disabled”. If enabled, the BIOS issues a warning when any program or virus sends a Disk Format command or attempts to write to the boot sector of the hard disk drive.

**Note:**

*If you are installing or running certain operating systems such as Windows 95, please disable the Virus Warning or the operating system may not install nor work.*

If you choose “System” in the Security Option, you will be prompted for a password every time you cold boot your system or access setup. If you choose “Setup”, you will be prompted for a password only when trying to access setup.

Use the arrow keys to move the highlight bar to the option you wish to change or modify. Use the <Page Up>, <Page Down>, <+> or <-> keys to make the corresponding changes. Press <Esc> after making the changes to return to the main menu.

### Chipset Features Setup

The G486VPC uses the VIA chipset. The Chipset Features Setup allows you to modify some functions to optimize system performance. If you press <Enter>, a screen similar to the one on the next page will appear.

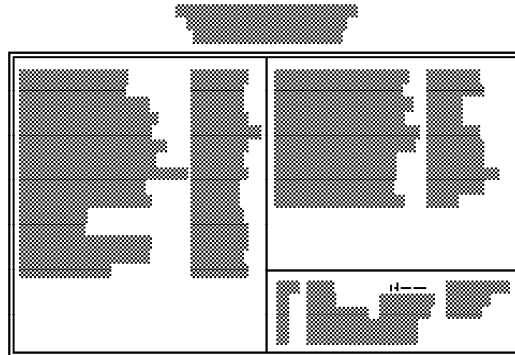

Use the arrow keys to move the highlight bar to the option you wish to change or modify. Use the <Page Up>, <Page Down>, <+> or <-> keys to make the corresponding changes.

If the changes you made are incorrect or you change your mind, press <F6> or <F7> to return to the default settings. Press <Esc> after making the changes to return to the main menu.

### Power Management Setup

Use the arrow keys to highlight “Power Management Setup” and press <Enter>. A screen similar to the one below will appear.



Choosing “Enabled” in the Power Management option will allow you to set Sleep Timer, Sleep Mode, HDD Power Management and VGA Activity Wakeup. Choose “Disabled” if you do not want your system to enter the power saving mode.

## PCI Configuration Setup

Use the arrow keys to highlight “PCI Configuration Setup” and press <Enter>; a screen similar to the one below will appear.

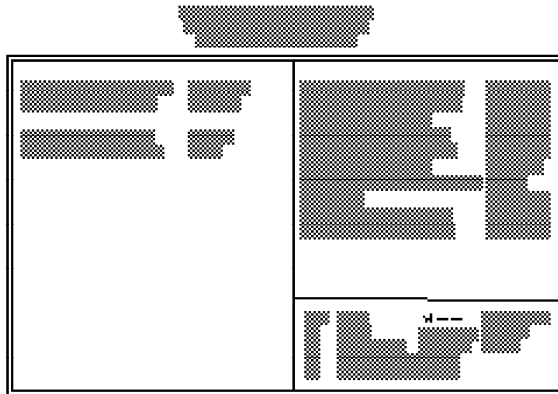

The G486VPC system board supports one PCI slot. This slot may be assigned an INT value if the card installed in the slot requires an interrupt. The INT may then be assigned an IRQ value.

## Load BIOS Defaults

The “Load BIOS Defaults” option loads the troubleshooting default values permanently stored in the ROM chips. These settings are not optimal and turn off all high performance features. You should use these values only if you have hardware problems. Highlight this option on the main menu and press <Enter>. The message below will appear.

*Load BIOS Defaults (Y/N)? N*

If you want to proceed, press <Y> and the default settings will be loaded.

## Load Setup Defaults

The “Load Setup Defaults” option loads optimized settings from the BIOS ROM. Use the Setup default values as standard values for your system.



Highlight this option on the main menu and press <Enter>. The message below will appear.

*Load Setup Defaults (Y/N)? N*

Type <Y> and press <Enter> to load the Setup default values.

## **Supervisor Password**

If you want to protect your system and setup from unauthorized entry, set a supervisor's password with the "System" option selected in the BIOS Features Setup.

If you want to protect access to setup only, but not your system, set a supervisor's password with the "Setup" option selected in the BIOS Features Setup. You will not be prompted for a password when you cold boot the system.

Use the arrow keys to highlight the "Supervisor Password" option and press <Enter>. The message below will appear.



*Enter Password:*



Type in the password. You are limited to eight characters. When done, the message below will appear:

*Confirm Password:*

You are asked to verify the password. Type in exactly the same password. If you type in a wrong password, you will be prompted to enter the correct password again.

To delete or disable the password function, highlight "Supervisor Password" and press <Enter>, instead of typing in a new password. Press the <Esc> key to return to the main menu.



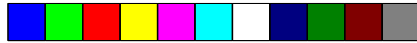

## User Password

If you want another user to have access only to your system but not to setup, set a user's password with the "System" option selected in the BIOS Features Setup.

If you want a user to enter a password when trying to access setup, set a user's password with the "Setup" option selected in the BIOS Features Setup. Using user's password to enter Setup allows a user to access only the "User Password" option that appears on the main screen. Access to all other options is denied.

To set, confirm, verify, disable or delete a user's password, follow the procedures described in the section "Supervisor Password". If you forget your password, refer to the procedure described in the same section.

## IDE HDD Auto Detection

This option detects the hard disk parameters for the hard disk drives installed in your system. Highlight this option and press <Enter>. A screen similar to the one below will appear.







Enter your choice, and press <Enter> to accept the parameters or press <Esc> to abort. The parameters of the hard disk will be displayed in the Standard CMOS Setup.

### Hard Drive Mode

The G486VPC supports three HDD modes: Normal, LBA and Large. If your hard disk drive does not support LBA mode, the "LBA" option will not be displayed. If your HDD has 1024 or fewer cylinders, the "Large" option will not be displayed.

#### Normal Mode

The Normal mode is the generic access mode in which neither the BIOS nor the IDE controller will make any transformations during hard-drive access.

The maximum number of cylinders, heads and sectors for Normal mode are 1024, 16 and 63, respectively.



	no. Cylinders	(1024)
x	no. Heads	( 16)
x	no. Sectors	( 63)
x	bytes per sector	( 512)



---

528 megabytes

If you set your HDD to Normal mode, the maximum accessible HDD space will be 528 megabytes even though the physical size of the HDD may be greater than that.

#### LBA (Logical Block Addressing) Mode

The LBA mode is a HDD accessing method to overcome the 528 megabytes limitation. The number of cylinders, heads and sectors shown on the screen may not be the actual number for the HDD.

During the HDD accessing, the IDE controller will transform the logical address described by the sector, head and cylinder number into its own physical address inside the HDD.



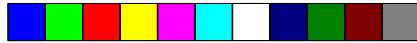

The maximum HDD size supported by the LBA mode is 8.4 gigabytes. It is obtained by the following formula.

$$\begin{array}{r}
 \text{no. Cylinders} \quad (1024) \\
 \times \text{ no. Heads} \quad (225) \\
 \times \text{ no. Sectors} \quad (63) \\
 \times \text{ bytes per sector} \quad (512) \\
 \hline
 8.4 \text{ gigabytes}
 \end{array}$$

### Large Mode

The Large mode is the extended HDD access mode supported by the G486VPC system board. Some IDE HDDs have more than 1024 cylinders without LBA support (in some cases, you may not want the LBA mode). This system board provides another alternative to support these kinds of HDDs.

The BIOS tells the operating system that the number of cylinders is half of the actual number and that the number of heads is double the actual number. During disk access, the reverse conversion is done by the INT13h routine.

Example of Large mode:

CYLS.	HEADS	SECTORS	MODE
1120	16	59	NORMAL
560	32	59	LARGE

Maximum HDD size:

$$\begin{array}{r}
 \text{no. Cylinders} \quad (1024) \\
 \times \text{ no. Heads} \quad (32) \\
 \times \text{ no. Sectors} \quad (63) \\
 \times \text{ bytes per sector} \quad (512) \\
 \hline
 1 \text{ gigabyte}
 \end{array}$$

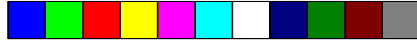

**Note:**

*To support LBA or Large mode, address translation software is included in the Award BIOS HDD Service Routine (INT13h). If you are running an operating system that bypasses the BIOS Int13 Service Routine, LBA and Large Mode may fail.*

### **Save & Exit Setup**

When all the changes have been made, highlight “Save & Exit Setup” and press <Enter>. The message below will appear:

*Save to CMOS and Exit (Y/N)? N*

Type “Y” and press <Enter>. The following message will appear:

*Reboot System (Y/N)? N*

Type “Y” and press <Enter>. The modifications you have made will be written into the CMOS memory, and the system will reboot. You will once again see the initial diagnostics on the screen. If you wish to make additional changes to the setup, press <Ctrl> <Alt> <Esc> simultaneously or <Del> after memory testing is done.

### **Exit Without Saving**

When you do not want to save the changes you have made, highlight the “Exit Without Saving” option and press <Enter>. The message below will appear:

*Quit Without Saving (Y/N)? N*

Type “Y” and press <Enter>. The system will reboot and you will once again see the initial diagnostics on the screen. If you wish to make any changes to the setup, press <Ctrl> <Alt> <Esc> simultaneously or <Del> after memory testing is done.



## System Error Report

When the BIOS encounters an error that requires the user to correct something, either a beep code will sound or a message will be displayed in a box in the middle of the screen and the message PRESS F1 TO CONTINUE, CTRL-ALT-ESC or DEL TO ENTER SETUP, will be shown in the information box at the bottom. Enter Setup to correct the error.

### POST Beep

There is one beep code in the BIOS. This code indicates that a video error has occurred and the BIOS cannot initialize the video screen to display any additional information. This beep code consists of a single long beep followed by two short beeps. If you get this error, contact your system vendor.

### Error Messages

One or more of the following messages may be displayed if the BIOS detects an error during the POST.

#### **DISK BOOT FAILURE, INSERT SYSTEM DISK AND PRESS ENTER**

No boot device was found. Insert a system disk into Drive A and press <Enter>. If the system normally boots from the hard drive, make sure the controller is inserted correctly and all cables are properly attached. Also be sure the disk is formatted as a boot device. Reboot the system.

#### **DISKETTE DRIVES OR TYPES MISMATCH ERROR - RUN SETUP**

The type of diskette drive installed in the system is different from the CMOS definition. Run setup to reconfigure the drive type correctly.

#### **DISPLAY SWITCH IS SET INCORRECTLY**

The display switch on the system board can be set to either monochrome or color. This error indicates the switch is set to a different setting than indicated in Setup. Determine which setting is correct and either turn off the system and change the jumper or enter Setup and change the VIDEO selection.



#### **DISPLAY TYPE HAS CHANGED SINCE LAST BOOT**

Since last powering off the system, the display adapter has been changed. You must configure the system for the new display type.

#### **ERROR ENCOUNTERED INITIALIZING HARD DRIVE**

The hard drive cannot be initialized. Be sure the adapter is installed correctly and all cables are correctly and firmly attached. Also, be sure the correct hard drive type is selected in Setup.

#### **ERROR INITIALIZING HARD DISK CONTROLLER**

The system cannot initialize the controller. Make sure the card is correctly and firmly installed in the bus. Be sure the correct hard drive type is selected in Setup. Also, check to see if any jumper needs to be set correctly on the hard drive.

#### **FLOPPY DISK CNTRLR ERROR OR NO CNTRLR PRESENT**

The system cannot find or initialize the floppy drive controller. Make sure the controller is installed correctly and firmly. If no floppy drive is installed, be sure the Diskette Drive selection in Setup is set to NONE.

#### **KEYBOARD ERROR OR NO KEYBOARD PRESENT**

Cannot initialize the keyboard. Make sure the keyboard is attached correctly and no keys are being pressed during the boot.

If you are purposely configuring the system without a keyboard, set the error halt condition in Setup to HALT ON ALL, BUT KEYBOARD. This will cause the BIOS to ignore the missing keyboard and continue the boot.

#### **MEMORY ADDRESS ERROR AT...**

Indicates a memory address error at a specific location. You can use this location along with the memory map for your system to find and replace the bad memory chips.

#### **MEMORY SIZE HAS CHANGED SINCE LAST BOOT**

Memory has been added or removed since the last boot. Enter Setup and enter the new memory size in the memory fields.

#### **MEMORY VERIFY ERROR AT...**

Indicates an error verifying a value already written to memory. Use the location along with your system's memory map to locate the bad chip.



#### **OFFENDING ADDRESS NOT FOUND**

This message is used in conjunction with the I/O CHANNEL CHECK and RAM PARITY ERROR messages when the segment that has caused the problem cannot be isolated.

#### **OFFENDING SEGMENT**

This message is used in conjunction with the I/O CHANNEL CHECK and RAM PARITY ERROR messages when the segment that has caused the problem has been isolated.

#### **PRESS A KEY TO REBOOT**

This will be displayed at the bottom screen when an error occurs that requires a reboot. Press any key and the system will reboot.

#### **PRESS F1 TO DISABLE NMI, F2 TO REBOOT**

When BIOS detects a Non-Maskable Interrupt condition during boot, this will allow NMI to be disabled and continue to boot. You can also reboot the system with the NMI enabled.

#### **SYSTEM HALTED, (CTRL-ALT-DEL) TO REBOOT...**

Indicates the present boot attempt has been aborted and the system must be rebooted. Press and hold down the CTRL, ALT and DEL keys simultaneously.



## Chapter 4 Troubleshooting Checklist

---

If you experience difficulty with the G486VPC system board, please refer to the checklist below. If you still cannot identify the problem, please contact your dealer.

1. Check the jumper settings to ensure that the jumpers are properly set. If in doubt, refer to the "Hardware Installation" section.
2. Verify that all SIMMs are seated securely into the SIMM sockets.
3. Make sure the SIMMs are in the correct locations.
4. Check that all populated memory banks are filled with correctly sized SIMMs.
5. If your board fails to function, place the board on a flat surface and seat all socketed components (gently press each component into the socket).
6. If you made changes to the BIOS settings, re-enter setup and load the BIOS defaults.



## Appendix A Types of Modules

---

The G486VPC system board supports 1MB to 64MB of memory using 72-pin SIMMs. The following modules have been tested with this board. Most untested brands will work but a few may fail to do so.

SIMM	Brand	Chip Number
256KBx36	OKI	M514256B-70J
512KBx36	OKI	M514256B-70J
1MBx36	Fujitsu Toshiba OKI	814400A-70 TC514400ASJL-70 M514400A-70
2MBx36	Mitsubishi	M5M44400BJ-7S
4MBx36	Fujitsu Mitsubishi OKI	814100A-70 M5M417400BJ-7 M514100B-70S





## Appendix B Memory and I/O Maps

---

### Memory Address Map

Address	Name	Function
0000000 to 009FFFF	640KB System Board RAM	System Board Memory
00A0000 to 00BFFFF	128KB Video Display Memory	Reserved for Graphics Display Memory
00C0000 to 00E7FFF	160KB I/O Expansion ROM	Reserved for ROM on I/O Adapter Card
00E8000 to 00FFFFFF	96KB ROM on the System Board	System Board BIOS
0100000 to 3FFFFFF	Maximum Memory 64MB	System Board Memory

---

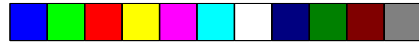

## I/O Address Map

I/O Address	Function
000-01F	DMA Controller 1, 8237A-5
020-03F	Interrupt Controller 1, 8259A, Master
040-05F	Timer, 8254-2
060-06F	8742 (Keyboard Controller)
070-07F	Real-time Clock, NMI (Non-maskable Interrupt) Mask
080-09F	DMA Page Memory, 74LS612
0A0-0BF	Interrupt Controller 2, 8259A
0C0-0DF	DMA Controller 2, 8237A-5
0E8	Shadow RAM and Cache Control Bit
0F0	Clear Numeric Processor Extension Busy
0F1	Reset Numeric Processor Extension
0F8-0FF	Numeric Processor Extension
1F0-1F8	Fixed Disk
200-207	Game I/O
278-27F	Parallel Printer Port 2
2F8-2FF	Serial Port 2
300-31F	Prototype Card
360-36F	Reserved
378-37F	Parallel Printer Port 1
380-38F	SDLC, Bisynchronous 2
3A0-3AF	Bisynchronous 1
3B0-3BF	Monochrome Display and Printer Adapter
3C0-3CF	Reserved
3D0-3DF	Color/Graphics Monitor Adapter
3F0-3F7	Diskette Controller
3F8-3FF	Serial Port 1

**Note:**

*The I/O address hex 000 to 0FF are reserved for the system board I/O.  
Hex 100 to 3FF are available on the I/O channels.*

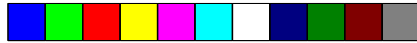

## Appendix C PCI I/O Pin Assignments

Component Side	B	A	Solder Side
-12V	-01 -	TRST#	
TCK	-02 -	+12V	
Ground	-03 -	TMS	
TDO	-04 -	TDI	
+5V	-05 -	+5V	
+5V	-06 -	INTA#	
INTB#	-07 -	INTC#	
INTD#	-08 -	+5V	
PRSNT1#	-09 -	Reserved	
Reserved	-10 -	+5V (I/O)	
PRSNT2#	-11 -	Reserved	
Ground	-12 -	Ground	
Ground	-13 -	Ground	
Reserved	-14 -	Reserved	
Ground	-15 -	RST#	
CLK	-16 -	+5V (I/O)	
Ground	-17 -	GNT#	
REQ#	-18 -	Ground	
+5V (I/O)	-19 -	Reserved	
AD[31]	-20 -	AD[30]	
AD[29]	-21 -	N. C.	
Ground	-22 -	AD[28]	
AD[27]	-23 -	AD[26]	
AD[25]	-24 -	Ground	
N. C.	-25 -	AD[24]	
C/BE[3]#	-26 -	IDSEL	
AD[23]	-27 -	N. C.	
Ground	-28 -	AD[22]	
AD[21]	-29 -	AD[20]	
AD[19]	-30 -	Ground	
N. C.	-31 -	AD[18]	
AD[17]	-32 -	AD[16]	
C/BE[2]#	-33 -	N. C.	
Ground	-34 -	FRAME#	
IRDY#	-35 -	Ground	
N. C.	-36 -	TRDY#	
DEVSEL#	-37 -	Ground	
Ground	-38 -	STOP#	
LOCK#	-39 -	N. C.	
PERR#	-40 -	SDONE	
N. C.	-41 -	SBO#	
SERR#	-42 -	Ground	
N. C.	-43 -	PAR	
C/BE[1]#	-44 -	AD[15]	
AD[14]	-45 -	N. C.	
Ground	-46 -	AD[13]	
AD[12]	-47 -	AD[11]	
AD[10]	-48 -	Ground	
Ground	-49 -	AD[09]	
AD[08]	-52 -	C/BE[0]#	
AD[07]	-53 -	N. C.	
N. C.	-54 -	AD[06]	
AD[05]	-55 -	AD[04]	
AD[03]	-56 -	Ground	
Ground	-57 -	AD[02]	
AD[01]	-58 -	AD[00]	
+5V (I/O)	-59 -	+5V (I/O)	
ACK64#	-60 -	REQ64#	
+5V	-61 -	+5V	
+5V	-62 -	+5V	



## Appendix D ISA I/O Pin Assignments

---

B		A
Gnd	- 01 -	-I/OChck
ResetDiv	- 02 -	SD7
+5VDC	- 03 -	SD6
IRQ9	- 04 -	SD6
-5VDC	- 05 -	SD4
DRQ2	- 06 -	SD8
-12VDC	- 07 -	SD2
O/S	- 08 -	SD1
+12VDC	- 09 -	SD0
Gnd	- 10 -	-I/OChrty
-SEMEMW	- 11 -	AEN
-SEMEMR	- 12 -	SA19
-IOW	- 13 -	SA18
-IOR	- 14 -	SA17
-Dack3	- 15 -	SA16
-DRQ3	- 16 -	SA15
-Dack1	- 17 -	SA14
DRQ1	- 18 -	SA13
-Refresh	- 19 -	SA12
CLK	- 20 -	SA11
IRQ7	- 21 -	SA10
IRQ6	- 22 -	SA9
IRQ5	- 23 -	SA8
IRQ4	- 24 -	SA7
IRQ3	- 25 -	SA6
-Dack2	- 26 -	SA5
T/C	- 27 -	SA4
Bale	- 28 -	SA3
+5VDC	- 29 -	SA2
CSC	- 30 -	SA1
Gnd	- 31 -	SA0

D		C
-MemCS16	- 01 -	SBHE
-I/OCS16	- 02 -	LA23
IRQ10	- 03 -	LA22
IRQ11	- 04 -	LA21
IRQ12	- 05 -	LA20
IRQ13	- 06 -	LA19
IRQ14	- 07 -	LA18
-Dack0	- 08 -	LA17
DRQ0	- 09 -	-Memr
-Dack5	- 10 -	-Memw
DRQ5	- 11 -	SD08
-Dack6	- 12 -	SD09
DRQ6	- 13 -	SD10
-Dack7	- 14 -	SD11
DRQ7	- 15 -	SD12
+5VDC	- 16 -	SD13
-Master	- 17 -	SD14
Gnd	- 18 -	SD15

## Appendix E System Overview

DMA Controller 1	DMA Controller 2
Ch0-Reserved for User	Ch4-Cascade for CTRL 1
Ch1-Reserved for User	Ch5-Reserved for User
Ch2-Diskette	Ch6-Reserved for User
Ch3-Reserved for User	Ch7-Reserved for User

**Note:**

*DMA controller 1 supports 8-bit data transfer.  
DMA controller 2 supports 16-bit data transfer.*

### Address Generation for DMA Channels 3 to 0

<b>Source Address</b>	<b>DMA Page Memory A23 ↔ A16</b>	<b>DMA Controller 1 A15 ↔ A0</b>
---------------------------	--------------------------------------	--------------------------------------

### Address Generation for DMA Channels 7 to 5

<b>Source Address</b>	<b>DMA Page Memory A23 ↔ A17</b>	<b>DMA Controller 2 A16 ↔ A1</b>
---------------------------	--------------------------------------	--------------------------------------

### Page Memory Address

IO Port Address	Page Memory
0081H	DMA Channel 2
0082H	DMA Channel 3
0083H	DMA Channel 1
0087H	DMA Channel 0
0089H	DMA Channel 6
008AH	DMA Channel 7
008BH	DMA Channel 5

## System Interrupts

Interrupt Controller 1	Interrupt Controller 2
IRQ0-Timer Output (Out 0)	IRQ9-Software Redirected to INT 0AH (IRQ2)
IRQ1-KeyBoard (Output Buffer Full)	IRQ10-Reserved
IRQ2-Interrupt from INTR2	IRQ11-Reserved
IRQ3-Serial Port 2	IRQ12-PS/2 Mouse
IRQ4-Serial Port 1	IRQ13-Coprocessor
IRQ5-Parallel Port 2 or 3 *	IRQ14-Primary Fixed Disk Controller (1F0)
IRQ6-Diskette Controller	IRQ15-Secondary Fixed Disk Controller (170)
IRQ7-Parallel Port 1 or 2 *	
IRQ8-Realtime Clock INT	

\* The one on-board parallel port can be configured to either Parallel Port 1, 2 or 3. Parallel Port 1 uses I/O address 3BCh, Parallel Port 2 uses I/O address 378h, and Parallel Port 3 uses I/O address 278H.

### Note:

The 16 levels of system interrupts have the following priority: IRQ0> IRQ1> IRQ8> IRQ9> IRQ10> IRQ11> IRQ12> IRQ13> IRQ14> IRQ15> IRQ3> IRQ4> IRQ5> IRQ6> IRQ7.

## System Timers

Channel 0	Channel 1	Channel 2
System Timer (IRQ0)	Refresh Request Generator (15 $\mu$ s Rate Generator Period Signal)	Tone Generation for Speaker

## Real-Time Clock

Address	Function	Address	Function
00	Seconds	07	Date of Month
01	Second Alarm	08	Month
02	Minutes	09	Year
03	Minute Alarm	0A	Register A
04	Hours	0B	Register B
05	Hour Alarm	0C	Register C
06	Day of Week	0D	Register D



## Appendix F Connector Pin Assignments

---

### Connector J1 Turbo LED Connector

Pin	Function
1	Signal
2	LED Power

---

### Connector J2 Green LED Connector

Pin	Function
1	Signal
2	LED Power

---

### Connector J3 Speaker Connector

Pin	Function
1	Signal
2	Reserved
3	Ground
4	+5V

---

### Connector J4 Reset Switch Connector

Pin	Function
1	Ground
2	Reset

---

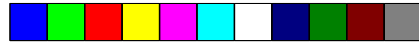

### Connector J5

Keylock Connector

Pin	Function
1	LED Signal
2	Reserved
3	Ground
4	Keylock Signal
5	Ground

### Connector J6

HD LED Connector

Pin	Function
1	Signal
2	LED Power

### Connector J7

Turbo Switch Connector

Pin	Function
1	Turbo
2	GND

### Connectors J8 and J9

Primary and Secondary IDE Hard Disk Drive Connectors

Pin	Function	Pin	Function
1	-Reset	13	D2
2	Ground	14	D13
3	D7	15	D1
4	D8	16	D14
5	D6	17	D0
6	D9	18	D15
7	D5	19	Ground
8	D10	20	Reserved
9	D4	21	Reserved
10	D11	22	Ground
11	D3	23	-IOW
12	D12	24	Ground



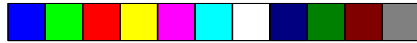

Pin	Function
25	-IOR
26	Ground
27	Reserved
28	BALE
29	Reserved
30	Ground
31	IRQ
32	IOCS16

Pin	Function
33	SA1
34	Reserved
35	SA0
36	SA2
37	HCS0
38	HCS1
39	LED
40	Ground

**Connector J10**  
Parallel Printer Port

Pin	Function
1	-Strobe
2	Data 0
3	Data 1
4	Data 2
5	Data 3
6	Data 4
7	Data 5
8	Data 6
9	Data 7
10	-Ack
11	Busy
12	Paper Empty
13	Select

Pin	Function
14	-Autofd
15	-Error
16	-Init
17	-Slctin
18	Ground
19	Ground
20	Ground
21	Ground
22	Ground
23	Ground
24	Ground
25	Ground

**Connector J11**  
Floppy Disk Drive Connector

Pin	Function
1	Ground
2	DENSEL
3	Ground
4	Reserved
5	Ground
6	Drate0
7	Ground
8	Index
9	Ground
10	MTR0

Pin	Function
11	Ground
12	DR1
13	Ground
14	DR0
15	Ground
16	MTR1
17	Drate1
18	Dir
19	Ground
20	Step

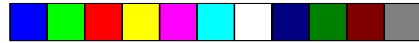

Pin	Function	Pin	Function
21	Ground	28	Wr Protect
22	Write Data	29	Ground
23	Ground	30	Read Data
24	Write Gate	31	Ground
25	Ground	32	Head Select
26	Track 0	33	Ground
27	MSEN	34	Disk Change

**Connector J12 and J13**  
COM A and COM B Serial Ports

Pin	Function
1	DCD (Data Carrier Detect)
2	RX (Receive Data)
3	TX (Transmit Data)
4	DTR (Data Terminal Ready)
5	Ground (Signal Ground)
6	DSR (Data Set Ready)
7	RTS (Request to Send)
8	CTS (Clear to Send)
9	RI (Ring Indicator)

**Connector CN1**  
PS/2 Mouse Connector

Pin	Function
1	Mouse Data
2	Reserved
3	Ground
4	+5V
5	Mouse Clock
6	Reserved

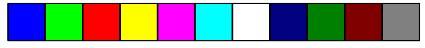

**Connector CN2**  
AT Keyboard Connector

Pin	Function
1	Keyboard Clock
2	Keyboard Data
3	Reserved
4	Ground
5	+5V

**Connector PL1**  
Power Connector

Pin	Function
1	Power Good
2	+5V
3	+12V
4	-12V
5	Ground
6	Ground
7	Ground
8	Ground
9	-5V
10	+5V
11	+5V
12	+5V

## Appendix G Award BIOS Hard Disk Table

Type	Size (MB)	Cylinders	Heads	Sectors	Write Precomp	Land Zone	Example Model
1	10	306	4	17	128	305	TEAC SD510, MMI 112, 5412
2	20	615	4	17	300	615	Seagate ST225, ST4026
3	30	615	6	17	300	615	
4	62	940	8	17	512	940	
5	46	940	6	17	512	940	
6	20	615	4	17	None	615	Seagate ST125, Tandon TM262
7	30	462	8	17	256	511	
8	30	733	5	17	None	733	Tandon TM 703
9	112	900	15	17	None	901	
10	20	820	3	17	None	820	
11	35	855	5	17	None	855	
12	49	855	7	17	None	855	
13	20	306	8	17	128	319	Discron 526, MMI M125
14	42	733	7	17	None	733	
15	(Reserved)						
16	20	612	4	17	0	663	Microscience HH725, Syquest 3250, 3425
17	40	977	5	17	300	977	
18	56	977	7	17	None	977	
19	59	1024	7	17	512	1023	
20	30	733	5	17	300	732	



Type	Size (MB)	Cylinders	Heads	Sectors	Write Precomp	Land Zone	Example Model
21	42	733	7	17	300	732	
22	30	306	5	17	300	733	Seagate ST4038
23	10	977	4	17	0	336	
24	40	1024	5	17	None	976	Seagate ST4051
25	76	1224	9	17	None	1023	Seagate ST4096
26	71	1224	7	17	None	1223	Maxtor 2085
27	111	1224	11	17	None	1223	Maxtor 2140, Priam S14
28	152	1024	15	17	None	1223	Maxtor 2190, Priam S19
29	68	1024	8	17	None	1023	Maxtor 1085, Micropolis 1325
30	93	918	11	17	None	1023	Maxtor 1105 1120, 4780
31	83	925	11	17	None	1023	Maxtor 1170
32	69	1024	9	17	None	926	CDC 9415
33	85	1024	10	17	None	1023	
34	102	1024	12	17	None	1023	
35	110	1024	13	17	None	1023	
36	119	1024	14	17	None	1023	
37	17	1024	2	17	None	1023	
38	136	1024	16	17	None	1023	
39	114	918	15	17	None	1023	Maxtor 1140, 4380
40	40	820	6	17	None	820	Seagate ST251
41	42	1024	5	17	None	1023	Seagate 4053 Miniscribe 3053/ 6053



Type	Size (MB)	Cylinders	Heads	Sectors	Write Precomp	Land Zone	Example Model
42	65	1024	5	26	None	1023	Miniscribe 3053/ 6053 RLL
43	40	809	6	17	None	852	Miniscribe 3650
44	61	809	6	26	None	852	Miniscribe 3675 RLL
45	100	776	8	33	None	775	Conner CP3104
46	203	684	16	38	None	685	Conner CP3204
47	(User Defined)						