



G486VPA

**Rev. A +
System Board
User's Manual**



- D26460327 -





❖ **Copyright 1996 by DFI, Inc.**

All rights reserved.

No part of this document may be copied, reproduced in any form or by any means or used to make any transformation/adaptation without the prior written consent of DFI, Inc.

DFI, Inc. makes no warranties with respect to this documentation and disclaims any implied warranties of merchantability, quality, or fitness for any particular purpose. The information in this document is subject to change without notice. DFI, Inc. reserves the right to make revisions to this publication and to make changes to any and/or all parts of its content, at any time, without obligation to notify any person or entity of such changes. Further, DFI, Inc. assumes no responsibility for any errors that may appear in this document.

DFI is a registered trademark, and G486VPA is a trademark of Diamond Flower, Inc. All other product names mentioned are trademarks or registered trademarks of their respective companies.



❖ **FCC Statement on Class B**

This equipment has been tested and found to comply with the limits for a Class B digital device, pursuant to Part 15 of the FCC rules. These limits are designed to provide reasonable protection against harmful interference when the equipment is operated in a residential installation. This equipment generates, uses and can radiate radio frequency energy and, if not installed and used in accordance with the instruction manual, may cause harmful interference to radio communications. However, there is no guarantee that interference will not occur in a particular installation. If this equipment does cause harmful interference to radio or television reception, which can be determined by turning the equipment off and on, the user is encouraged to try to correct the interference by one or more of the following measures:

- *Reorient or relocate the receiving antenna.*
- *Increase the separation between the equipment and the receiver.*
- *Connect the equipment into an outlet on a circuit different from that to which the receiver is connected.*
- *Consult the dealer or an experienced radio TV technician for help.*

Notice:

1. *The changes or modifications not expressly approved by the party responsible for compliance could void the user's authority to operate the equipment.*
2. *Shielded interface cables must be used in order to comply with the emission limits.*



❖ Table of Contents ❖

Introduction	1-1
Features and Specifications	1-2
Package Checklist	1-5
Installation Overview	2-1
Preparing the Area	2-1
Handling the System Board	2-2
Tips in Handling the System Board	2-2
Hardware Installation	2-3
Memory Installation	2-3
Installing the Modules	2-8
Board Configuration	2-9
Jumper Settings for Internal/External Battery, CMOS Clean, Flash EPROM, PS/2 Mouse and High Address Decode Setting	2-10
Jumper Settings for Super I/O Setting	2-14
Jumper Settings for VL-Bus Add-on Boards	2-16
Jumper Settings for PCI Slots	2-18
Cache Configuration	2-20
Jumper Settings for Cache Memory	2-22
CPU Installation	2-29
Jumper Settings for CPU	2-30
Installing Upgrade CPUs	2-53
Built-in Ports	2-58
Serial Ports	2-59
PS/2 Mouse Port	2-60
Parallel Port	2-61
Floppy Disk Drive Controller	2-63
IDE Hard Disk Connector	2-64
Installing Expansion Cards	2-67
Installing the System Board	2-69



Initial Setup Program	3-1
Award BIOS CMOS Setup Utilities	3-2
Standard CMOS Setup	3-2
BIOS Features Setup	3-5
Chipset Features Setup	3-7
Power Management Setup	3-8
PCI Configuration Setup	3-9
Load BIOS Defaults	3-10
Load Setup Defaults	3-10
Password Setting	3-11
Supervisor Password	3-11
User Password	3-12
IDE HDD Auto Detection	3-13
Save & Exit Setup	3-14
Exit Without Saving	3-14
IDE Device Drivers	4-1
Troubleshooting Checklist	5-1
Appendix A: Types of Modules	A-1
Appendix B: System Error Report	B-1
Appendix C: Memory & I/O Maps	C-1
Appendix D: PCI I/O Pin Assignments	D-1
Appendix E: ISA I/O Pin Assignments	E-1
Appendix F: Connector Pin Assignments	F-1
Appendix G: Award BIOS Hard Disk Table	G-1
Appendix H: System Overview	H-1

❖ Introduction

The G486VPA system board offers several advanced features integrated into the system board. Its design is based on the new Peripheral Component Interconnect (PCI) local bus and Industry Standard Architecture (ISA) standards.

The G486VPA is an Energy Star Compliant system board that supports the Environmental Protection Agency's Green PC requirements. It reduces energy consumption by automatically turning off peripherals or the entire system when not in use.

The G486VPA system board supports a 237-pin Zero Insertion Force (ZIF) CPU socket that allows users to easily upgrade their CPUs. It also supports a Flash EPROM for easy BIOS upgrades. Flash EPROM is a memory chip for the storage of BIOS which can be erased in bulk or modified using a software utility.

The G486VPA is equipped with three PCI slots, three ISA slots, one shared PCI/ISA slot and one VL-Bus slot.

Equipped with one built-in VL-Bus IDE connector and one ISA IDE connector, the G486VPA system board can control four drives and supports fast Mode 3 hard drives and hard drives larger than 528MB under DOS. The system board is also equipped with two serial ports, an ECP/EPP parallel port, a floppy disk drive controller, and an optional mini-DIN-6 connector for the PS/2 mouse.

The G486VPA can support 1MB to 128MB of memory using 256Kx36, 512Kx36, 1Mx36, 2Mx36, 4Mx36, 8Mx36 and 16Mx36 72-pin SIM modules.



G486VPA

Features and Specifications

Processor

- 5V CPUs
 - Intel 486SX/DX/DX2 (full series) and Pentium OverDrive Processor
 - AMD 486DX/DXL/DXL2 (full series)
 - Cyrix 486SX/DX/DX2 (full series)
- 3.3V CPUs
 - Intel 486DX4-75/100
 - AMD 486DX2-66/80NV8T,
486DX4-75/100NV8T,
486DX2-66/80 SV8B,
486DX4-75/100 SV8B
 - Cyrix 486DX2V-50/66/80

Chipset

- VIA - VT82C496G - system and cache controller
VT82C505 - VL-PCI bridge
VT82C406 - peripheral chip

Power Management

- Supports System Management Mode (SMM) and CPU stopped clock
- Hardware provides flexible event-driven power management scheme and easy CPU transition state: Ready, Doze and Suspend
- Microsoft APM compliant
- EPA Energy Star compliant design

BIOS

- Award system BIOS (Flash EPROM or EPROM)
- Supports IDE HDDs larger than 528MB under DOS (LBA mode only)
- System and EGA/VGA BIOS shadow

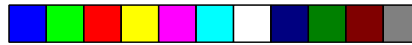

PCI/VL-Bus/ISA System Board

Super I/O Interface and Fast IDE

- Two NS16C550 compatible serial ports
- One parallel port with EPP and ECP support
- Supports 360K, 720K, 1.2M, 1.44M and 2.88MB floppy drives
- Two fast IDE connectors:
 - Primary IDE connector provides a VL-Bus IDE Interface to support up to two Mode 3 enhanced HDDs
 - Secondary IDE connector provides an ISA IDE Interface to support an ATAPI Compliant CD-ROM and a tape drive
- PS/2 mouse port (optional)

Cache Memory

- 128K, 256K, 512K or 1MB
- Supports Level 1 and Level 2 write-back/write-through cache

Memory Onboard

- 1MB to 128MB
- Four 72-pin SIMM sockets
- Supports memory parity check function
- 256Kx36, 1Mx36, 4Mx36, and 16Mx36 (four banks)
- 512Kx36, 2Mx36 and 8Mx36 (two banks)

Expansion Slots

- Three dedicated PCI slots
- One shared PCI/ISA slot
- Two dedicated 16-bit ISA slots
- One VL-Bus slot that also functions as a 16-bit ISA slot



G486VPA

Due to the size of the CPU with its accompanying heatsink/fan component, the following are the slot limitations:

PCI/ISA shared slot and **PCI** slot 2 will be limited to 2/3 length PCI cards.

ZIF Socket

- 237-pin ZIF socket (Intel Socket 3)

Board Dimensions

- 28cm (11.02") x 22cm (8.58")
Baby AT form factor

PCB

- 4 layers





PCWL-Bus/ISA System Board

Package Checklist

The G486VPA package contains the following items:

- The G486VPA system board
- The G486VPA user's manual
- One IDE driver diskette
- One 34-pin floppy disk drive cable
- Two 40-pin IDE hard disk cables
- One 25-pin printer port cable for chassis mounting
- One card-edge bracket and two serial port cables
- One mouse port cable (optional)

If any of these items are missing or damaged, please contact your dealer or sales representative for assistance.





❖ *Installation Overview*

This chapter summarizes the steps in installing the G486VPA system board into your system unit. It also includes a description of the area in which you must work and directions for memory installation. Before installing the system board, obtain the memory you plan to install. Please refer to the memory chart on pages 2-4, 2-5 and 2-6 for the number and type of SIM modules needed for the amount of memory you require.

Preparing the Area

Before unpacking the system board, make sure the location you have selected is relatively free of dust and static electricity. Excessive exposure to dust, static electricity, direct sunlight, excessive humidity, extreme cold, and water can damage the operational capabilities of your system board. Avoid placing the unit on soft surfaces such as beds and carpeted floors which can hinder air circulation. These areas also attract static electricity which can damage some circuits on your system board.

Make sure that the power source has a properly grounded, three-pronged socket. It is essential that the power connection be properly grounded for correct functioning of your system board. For further protection, we recommend that you use a surge suppressor. This will protect the system board from damage that may result from a power surge on the line.



PC/WL-Bus/ISA System Board

Move items that generate magnetic fields away from your system board, since magnetic fields can damage your system board. Once you have selected the ideal location, unpack the G486VPA system board carefully.

Handling the System Board

It is quite easy to inadvertently damage your system board even before installing it to your system unit. Static electrical discharge can damage computer components without causing any signs of physical damage. You must take extra care in handling the system board to ensure against electrostatic build-up.

Tips in Handling the System Board

- 1) To prevent electrostatic build-up, leave the board in its anti-static bag until you are ready to install it.
- 2) Wear an antistatic wriststrap.
- 3) Do all preparation work on a static-free surface with components facing up.
- 4) Hold the system board by its edges only. Be careful not to touch any of the components, contacts or connections, especially gold contacts on the board.
- 5) Avoid touching the pins or contacts on all modules and connectors. Hold modules and connectors by their edges.





G486VPA

Warning:

Electrostatic discharge (ESD) can damage your upgrade processor, disk drives, add-in boards, and other components. Perform the upgrade instruction procedures described at an ESD workstation only. If such a station is not available, you can provide some ESD protection by wearing an antistatic wrist strap and attaching it to a metal part of the system chassis. If a wrist strap is unavailable, establish and maintain contact with the system chassis throughout any procedures requiring ESD protection.

Hardware Installation

Memory Installation

The G486VPA system board can support 1MB to 128MB of memory using HSIM modules. HSIM is an acronym for High Density Single In-line Memory.

A SIM module consists of several RAM chips soldered onto a small circuit board. A SIM module connects to the system board via a 72-pin card-edge connector.

The SIM sockets are divided into four banks on the system board. The G486VPA uses 256Kx36, 1Mx36, 4Mx36, and 16Mx36 HSIM modules installed in four banks or 512Kx36, 2Mx36 and 8Mx36 HSIM modules installed in two banks.

You will need 1, 2, 3 or 4 pieces of SIM modules, depending on the amount of memory you intend to install. The following table summarizes the bank locations and modules needed for the corresponding memory sizes.



PC/WL-Bus/ISA System Board

MemorySize	Bank0	Bank1	Bank2	Bank3
1M	1M	-	-	-
2M	1M	1M	-	-
3M	1M	1M	1M	-
4M	1M	1M	1M	1M
4M	4M	-	-	-
5M	4M	1M	-	-
6M	4M	1M	1M	-
7M	4M	1M	1M	-
8M	4M	4M	-	-
9M	4M	4M	1M	-
10M	4M	4M	1M	1M
12M	4M	4M	4M	-
13M	4M	4M	4M	1M
16M	4M	4M	4M	4M
16M	16M	-	-	-
17M	16M	1M	-	-
18M	16M	1M	1M	-
19M	16M	1M	1M	1M
20M	16M	4M	-	-
21M	16M	4M	1M	-
22M	16M	4M	1M	1M
24M	16M	4M	4M	-
25M	16M	4M	4M	1M
28M	16M	4M	4M	4M
32M	16M	16M	-	-
33M	16M	16M	1M	-
34M	16M	16M	1M	1M
36M	16M	16M	4M	-
40M	16M	16M	4M	4M
48M	16M	16M	16M	-
49M	16M	16M	16M	1M
52M	16M	16M	16M	4M
64M	16M	16M	16M	16M
64M	64M	-	-	-

2-4 ◆ Installation Overview



G486VPA

MemorySize	Bank0	Bank1	Bank2	Bank3
65M	64M	1M	-	-
68M	64M	4M	-	-
69M	64M	4M	1M	-
72M	64M	4M	4M	-
80M	64M	16M	-	-
81M	64M	16M	1M	-
84M	64M	16M	4M	-
128M	64M	64M	-	-
128M	64M	-	64M	-
2M	2M(D)*	-	-	-
3M	2M(D)*	-	1M	-
4M	2M(D)*	-	1M	-
4M	2M(D)*	-	2M(D)*	-
6M	2M(D)*	-	4M	-
7M	2M(D)*	-	4M	1M
10M	2M(D)*	-	4M	4M
18M	2M(D)*	-	16M	-
19M	2M(D)*	-	16M	1M
22M	2M(D)*	-	16M	4M
8M	8M(D)*	-	-	-
9M 8M(D)*	-	-	1M	-
12M	8M(D)*	-	4M	-
13M	8M(D)*	-	4M	1M
16M	8M(D)*	-	4M	4M
16M	8M(D)*	-	8M(D)*	-
24M 8M(D)*	-	-	16M	-
25M	8M(D)*	-	16M	1M
28M	8M(D)*	-	16M	4M
72M	8M(D)*	-	64M	-
32M	16M(D)*	-	16M(D)*	-
32M	32M(D)*	-	-	-
33M	32M(D)*	-	1M	-
34M	32M(D)*	-	2M(D)*	-
36M	32M(D)*	-	4M	-

*(D)-Double Density

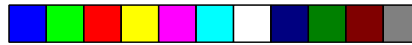

PC/WL-Bus/ISA System Board

MemorySize	Bank0	Bank1	Bank2	Bank3
37M	32M(D)*	-	4M	1M
40M	32M(D)*	-	4M	4M
40M	32M(D)*	-	8M(D)*	-
48M	32M(D)*	-	16M	-
49M	32M(D)*	-	16M	1M
52M	32M(D)*	-	16M	4M
64M	32M(D)*	-	32M(D)*	-
96M	32M(D)*	-	64M	-

*(D)-DoubleDensity

Note:

If a double row 36-bit SIMM (Double Density SIMM) is installed in Bank 2 or Bank 3, the other three banks cannot support 16MB modules.



G486VPA

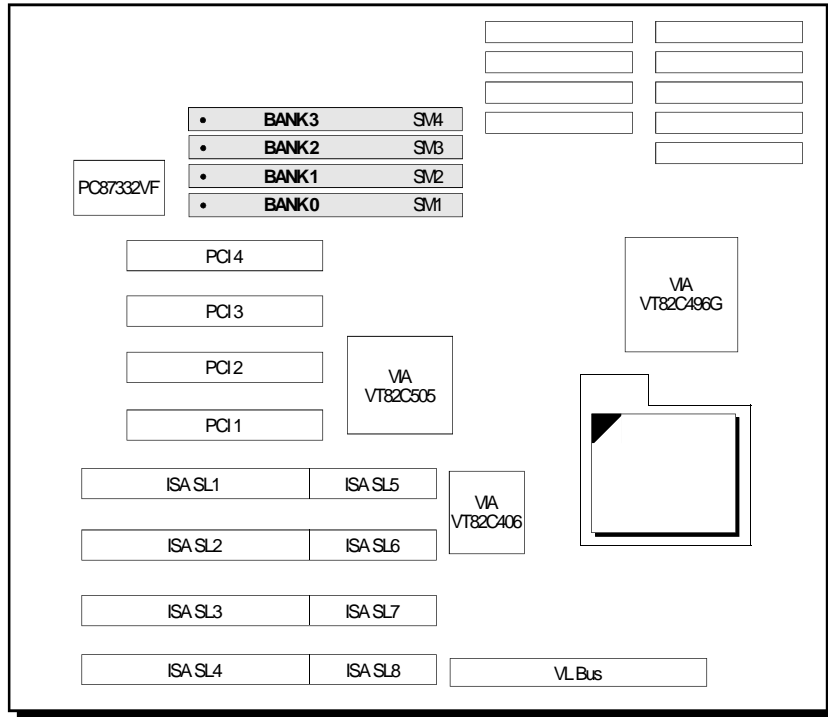

- Pin 1 of the SIMM socket

Locations of the SIM Sockets on the System Board

Note:

If you intend to install the amount of memory that can be supported by one piece of HSIM module, you can install it in any of the banks. The bank you choose is considered to be Bank 0. Each of the four banks can assume the function of the Bank 0 only if there is one HSIMM installed.

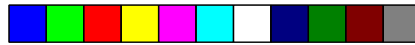

PCWL-Bus/ISA System Board

Installing the Modules

An HSIM module simply snaps into a socket on the system board. Pin 1 of the HSIM module must correspond with Pin 1 of the socket.

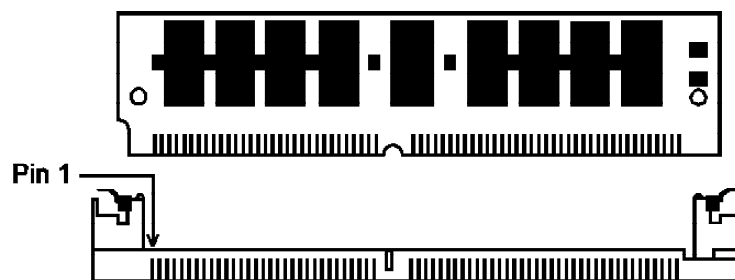

1. Position the HSIM module above the socket with the “notch” in the module aligned with the “key” on the socket.
2. Seat the module at a 45° angle into the bank. Make sure it is completely seated. Tilt the module upright until it locks in place in the socket.



G486VPA

Board Configuration

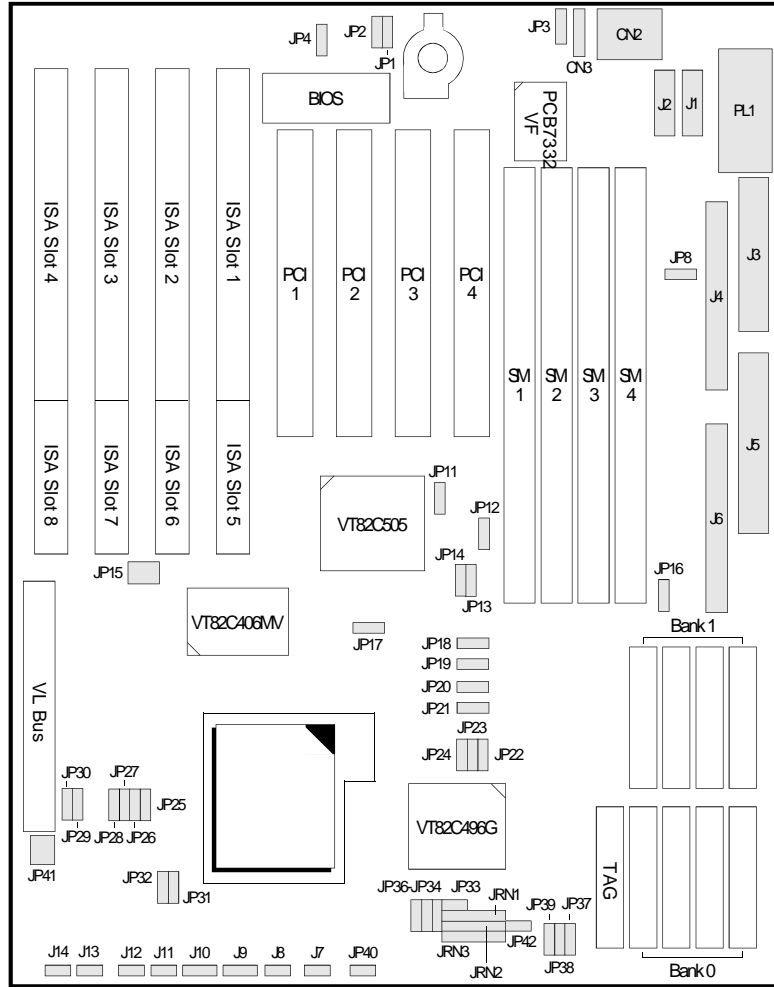

System Board Layout

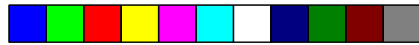

PC/VL-Bus/ISA System Board

Jumper Settings

Jumper Settings for Internal/External Battery, CMOS Clean, Flash EPROM, PS/2 Mouse and High Address Decode Setting

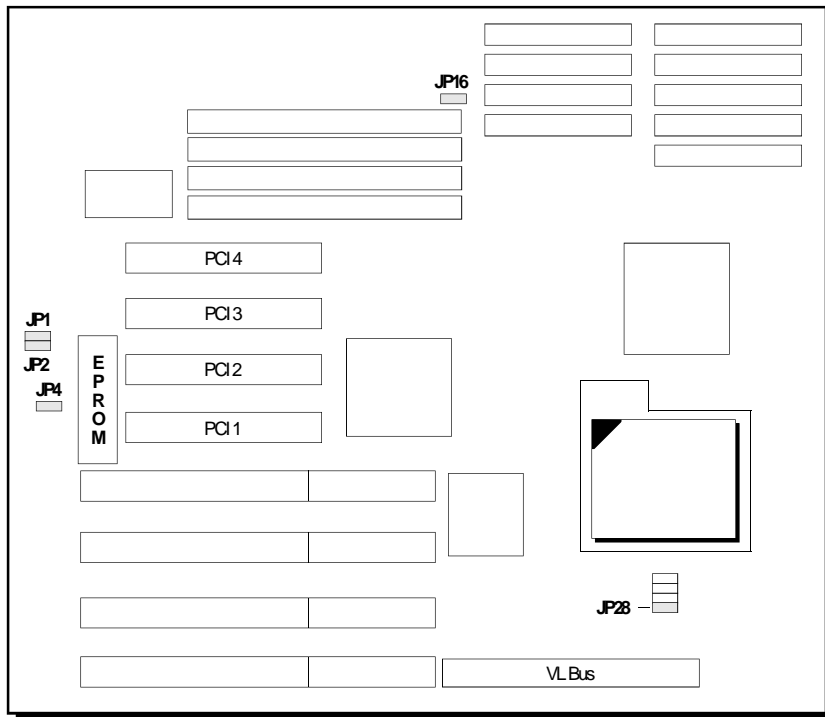

Locations of Jumpers JP1, JP2, JP4, JP16 and JP28 on the G486VPA System Board

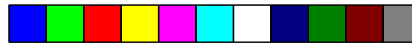

Jumper JP1 Internal Battery Select

The G486VPA comes with an internal Lithium battery. If you wish to install an external 3.6V Lithium battery, set JP1 pins 1 and 2 to On.

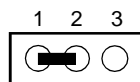

1-2 On: External
Battery Enabled
(Default)

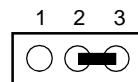

2-3 On: Internal
Battery Enabled

Note:

If you enable the external battery, you must connect the external battery to connector JP3 or your system will lose its CMOS settings when powered off.

Jumper JP2 CMOS Clean Select

If, for some reason, the CMOS becomes corrupted, the system can be reconfigured with the default values stored in the ROM BIOS. To load the default values, set JP2 pins 2 and 3 to On for approximately two minutes, then return to the default position.

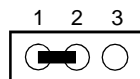

1-2 On: Normal
(Default)

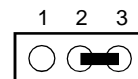

2-3 On: CMOS
Clean



PC/WL-Bus/ISA System Board

Jumper JP4 EPROM Type

Jumper JP4 should be set to match the type of the EPROM installed on the system board. Refer to page 2-9 for the location of the EPROM installed on your system board.

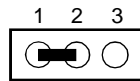

1-2 On: 12V Flash
EPROM 28F010
(Default)

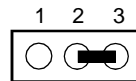

2-3 On: 5V Flash
EPROM 29F010 or
EPROM 27C010

Jumper JP16 PS/2 Mouse

The G486VPA package includes a card-edge bracket with serial and mouse port. The PS/2 mouse port uses IRQ12. If JP16 is set to pins 1 and 2 on, make sure you connect the PS/2 mouse port to Connector CN3.

JP16	
PS/2 Mouse Enabled *	1-2 On
PS/2 Mouse Disabled	2-3 On

* Default



————— G486VPA

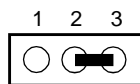

2-3 On: PS/2 Mouse
Disabled

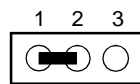

1-2 On: PS/2 Mouse
Enabled (Default)

Jumper JP28
High Address Decode Setting

If the G486VPA system board is installed with a Diamond Viper VESA VGA card, set Jumper 28 pins 2 and 3 to On. This VESA card uses addresses A27 to A31 that cannot be supported if Jumper JP28 is in its default position. The position 2-3 On supports only 64MB.

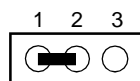

1-2 On: 128MB
(Default)

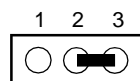

2-3 On: 64MB



PC/WL-Bus/ISA System Board

Jumper Settings for Super I/O Setting

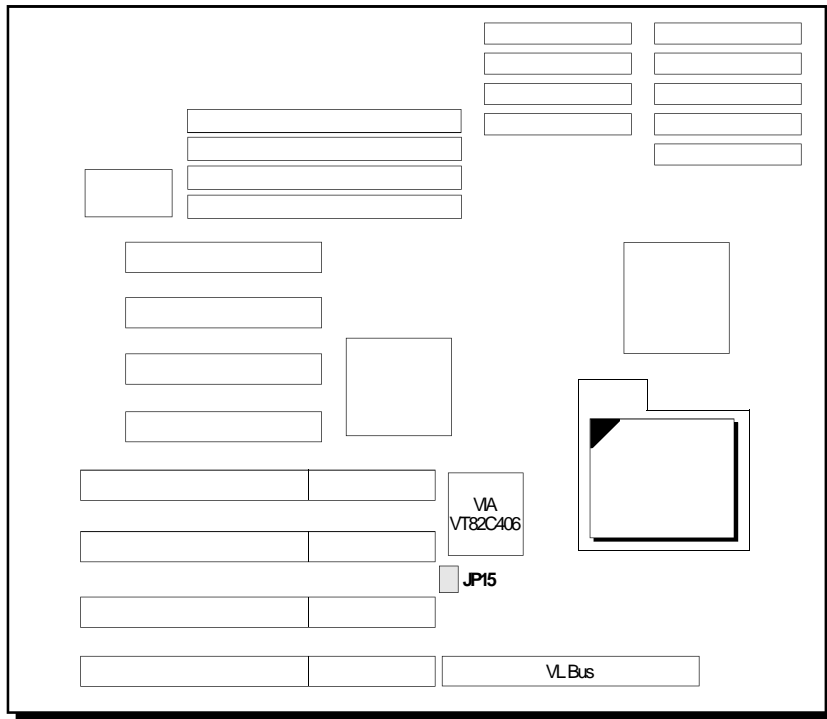

Location of Jumper JP15 on the System Board



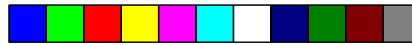

Jumper JP15 ECP DMA Channel Select

Jumper JP15 is used to select DMA channel. The DMA channel must be compatible with the I/O cards you are using. Normally, DMA3 channel supports sound cards. Set Jumper JP15 pins 1-3 and 2-4 to On unless this setting provides inadequate channel required by your system.

JP15	
No DMA	All pins Off
DMA 1 *	1-3, 2-4 On
DMA 3	3-5, 4-6 On

* Default setting

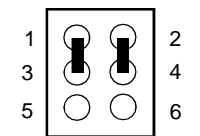

1-3, 2-4 On:
DMA 1 (Default)

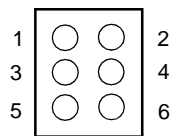

Off: No DMA

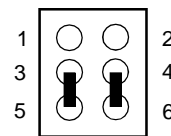

3-5, 4-6 On:
DMA 3



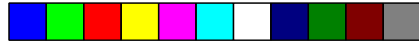

PC/VL-Bus/ISA System Board

Jumper Settings for VL-Bus Add-on Boards

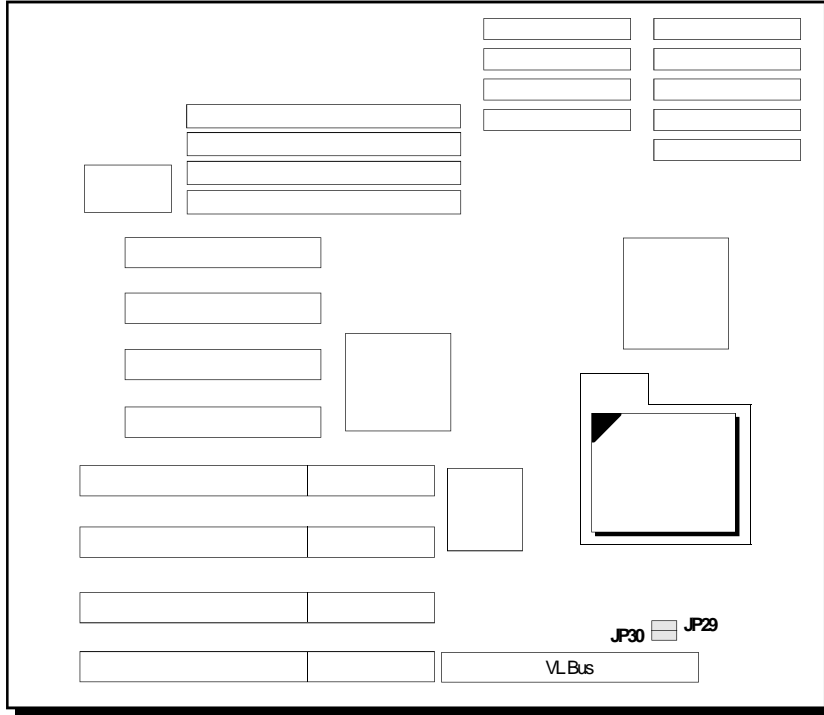

**Locations of Jumpers JP29 and JP30
on the G486VPA System Board**

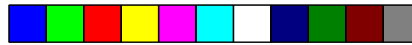

Jumper JP29

CPU External Clock Speed for VL-Bus Board

When a VL-Bus board is installed in the G486VPA system board, Jumper JP29 pins 2 and 3 must be set to On if the CPU external clock speed is greater than 33MHz. Set JP29 pins 1 and 2 to On if the CPU external clock speed is less than or equal to 33MHz.

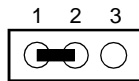

1-2 On: CPU External
Clock Speed \leq 33MHz
(Default)

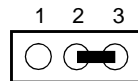

2-3 On: CPU External
Clock Speed $>$ 33MHz

Set Jumper JP29 pins 2-3 to On if your G486VPA system board uses one of the following CPUs: 486DX-50, 486DX2-80, 486DX-40 or 486SX-40. The CPU external clock speed supported by each of them is greater than 33MHz.

Jumper JP30

High Speed Mode for VL-Bus Board

Set Jumper JP30 pins 2 and 3 to On only if the VESA VL-Bus add-on board(s) installed in the VL-Bus slots support Zero Wait State. If you are not sure that your add-on board(s) support Zero Wait State, set JP30 pins 1 and 2 to On; otherwise, a system error may occur.

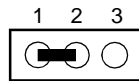

1-2 On: Write One Wait
State (Default)

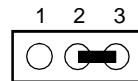

2-3 On: Write Zero Wait
State

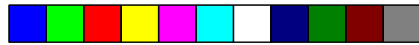

PC/WL-Bus/ISA System Board

Jumper Settings for PCI Slots

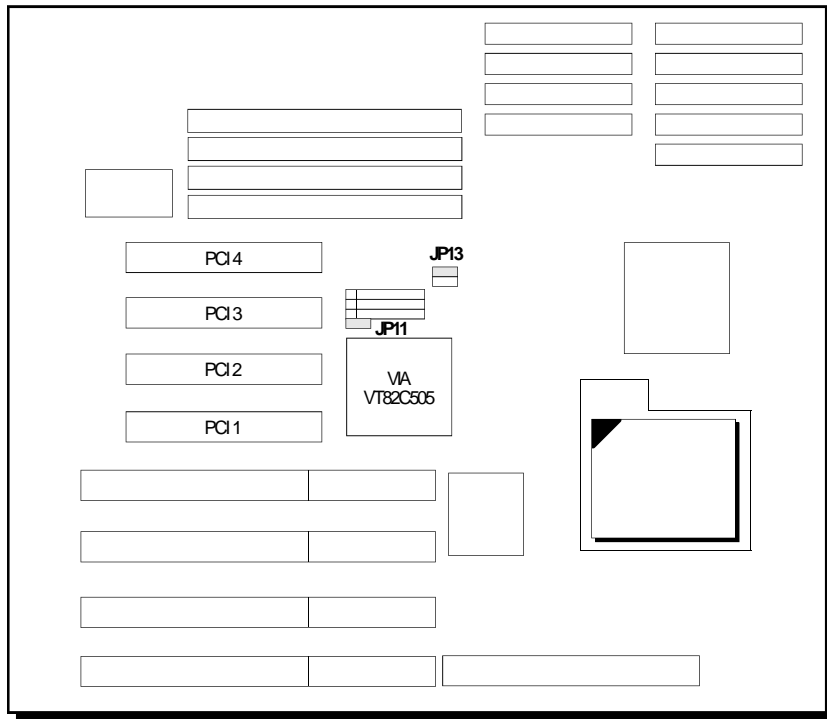

Locations of Jumpers JP11 and JP13
on the G486VPA System Board

Jumpers JP11 and JP13

CPU External Clock Speed for PCI Slots

These jumpers should be configured according to the type of CPU installed on the system board. Set Jumpers JP11 and JP13 pins 2 and 3 to On if the CPU external clock speed is greater than 33MHz. If the CPU external clock speed is less than or equal to 33MHz, set Jumpers JP11 and JP13 pins 1 and 2 to On.

	JP11	JP13
CPU External Clock Speed >33MHz	2-3 On	2-3 On
CPU External Clock Speed ≤ 33MHz *	1-2 On	1-2 On

* Default setting

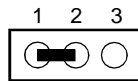

JP11, JP13 pins 1-2 On:
CPU External Clock Speed
≤ 33MHz (Default)

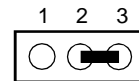

JP11, JP13 pins 2-3 On:
CPU External Clock
Speed > 33MHz

Set Jumpers JP11 and JP13 pins 2-3 to On if your G486VPA system board uses one of the following CPUs: 486DX-50, 486DX2-80, 486DX-40 or 486SX-40. The CPU external clock speed supported by each of them is greater than 33MHz.

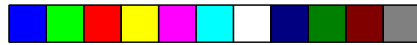

Cache Configuration

The G486VPA system board can be configured to four different cache sizes: 128KB, 256KB (Default size), 512KB and 1MB. The SRAM sockets are divided into two banks. Regardless of the amount of cache memory installed, one 8Kx8, 32Kx8, 64Kx8 or 128Kx8 is needed for tag RAM to store the cacheable addresses. The locations of the SRAM sockets on the system board are shown below.

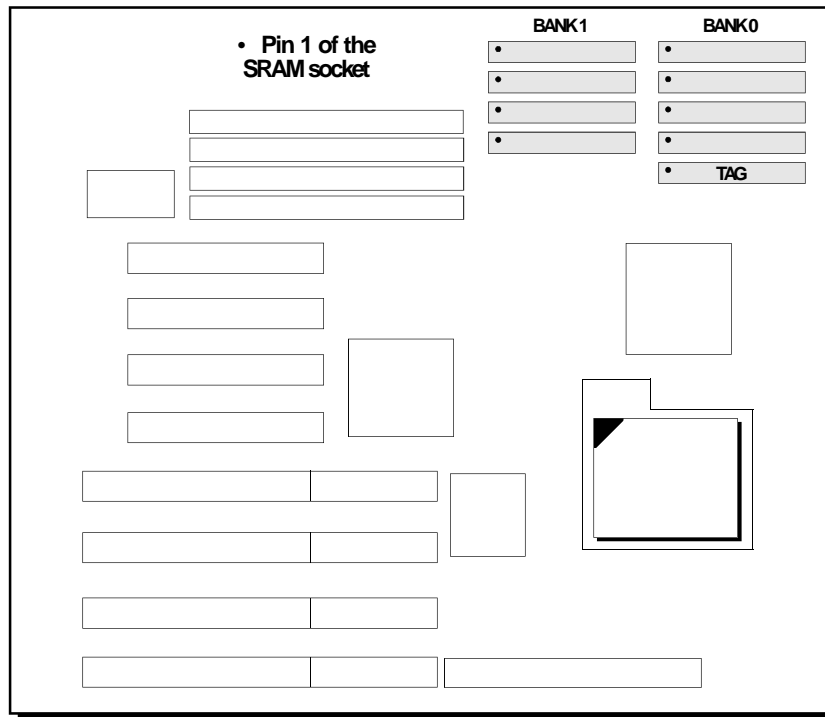

Locations of the SRAM Sockets on the G486VPA System Board



To upgrade from 256KB to 512KB of cache memory, use four pieces of 128Kx8 or eight pieces of 64Kx8 SRAM.

Cache Size	Data SRAM	Tag SRAM	Cacheable Range
1MB	128Kx8x8	128Kx8x1 or 64Kx8x1	128MB
512KB	128Kx8x4	32Kx8x1	128MB
512KB	64Kx8x8	32Kx8x1	128MB
256KB	64Kx8x4	32Kx8x1	64MB
256KB *	32Kx8x8	32Kx8x1	64MB
128KB	32Kx8x4	8Kx8x1	32MB

* Default setting

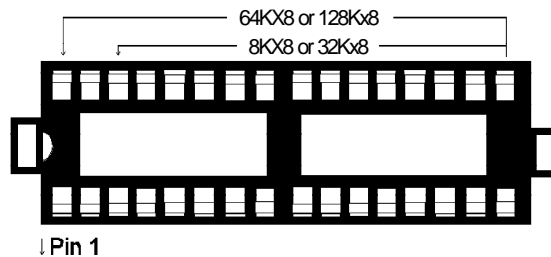

SRAM Socket

Note:

When installing the cache chips, populate Bank 0 first and then Bank 1. For example, to configure 128K of cache memory, install four 32Kx8 chips in Bank 0 and leave the SRAM sockets of Bank 1 empty.

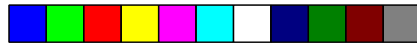

PC/WL-Bus/ISA System Board

Jumper Setting for Cache Memory

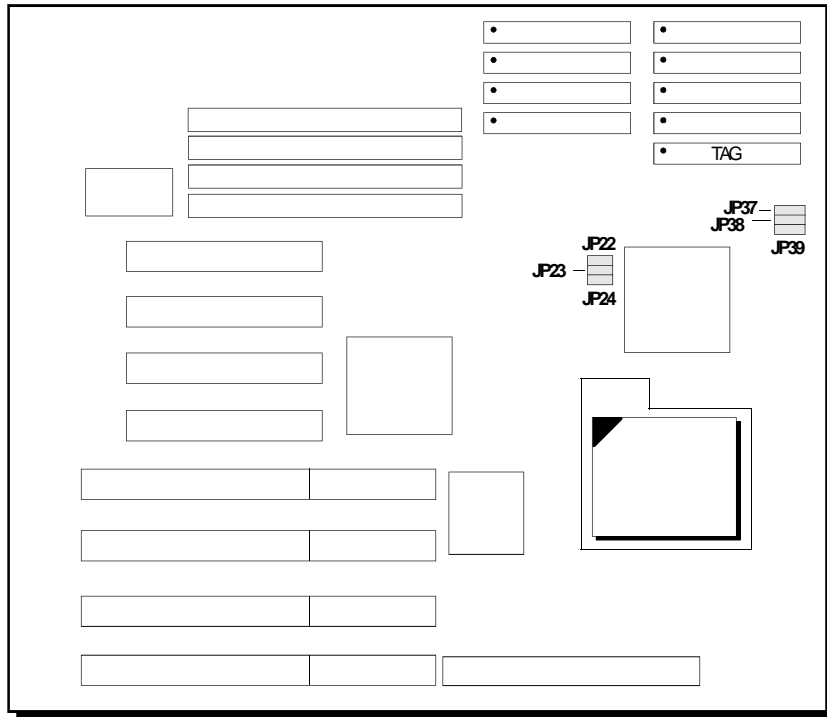

Locations of Jumpers JP22, JP23, JP24, JP37, JP38 and JP39 on the G486VPA System Board

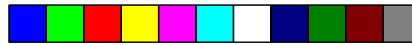

G486VPA

128KB Cache SRAM

Bank 1

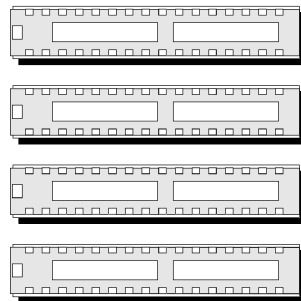

Bank 0

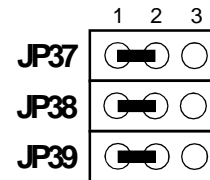
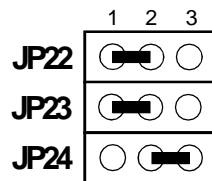
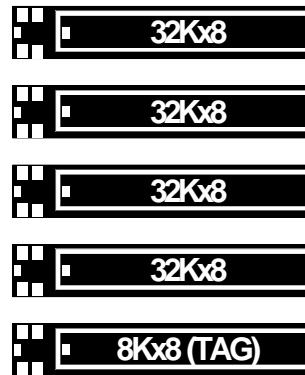

Note:

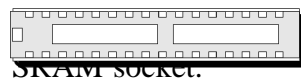

This refers to an empty



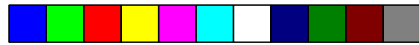

PCI/L-Bus/ISA System Board

256KB Cache SRAM

Bank 1

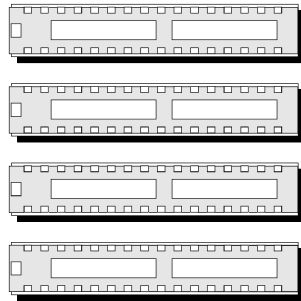

Bank 0

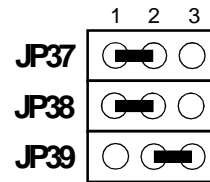
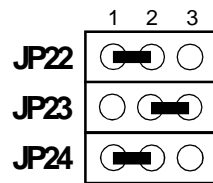

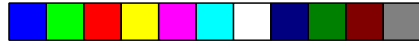

G486VPA

256KB Cache SRAM *

Bank 1

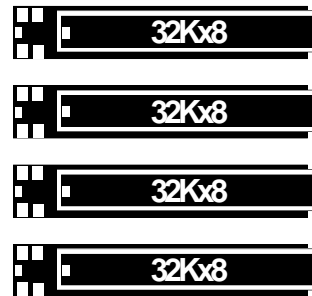

Bank 0

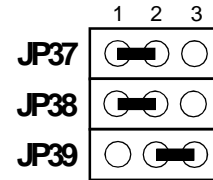
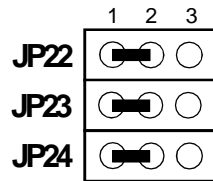
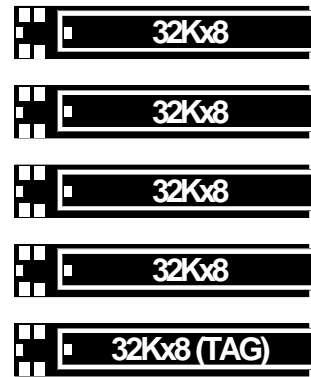

* Default setting



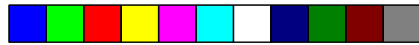

PC/WL-Bus/ISA System Board

512KB Cache SRAM

Bank 1

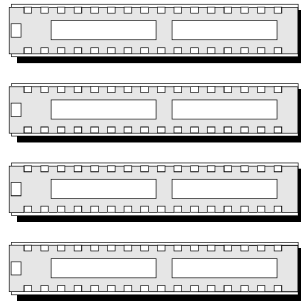

Bank 0

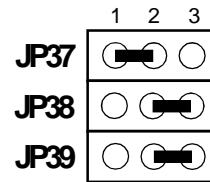
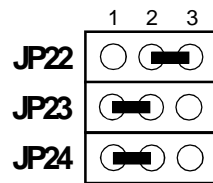
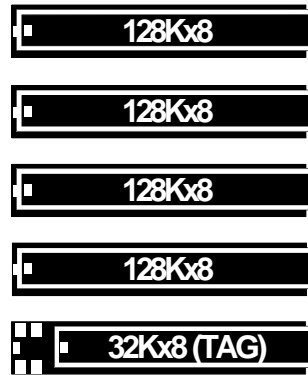

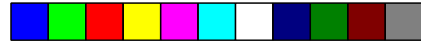

G486VPA

512KB Cache SRAM

Bank 1



Bank 0

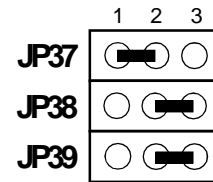
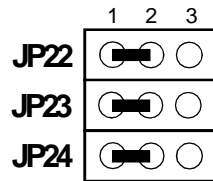
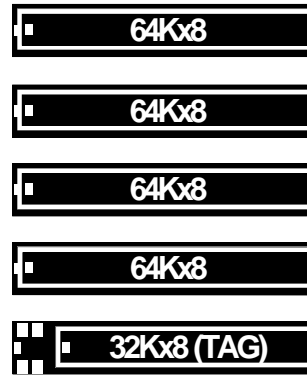

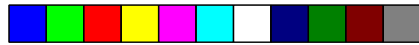

PC/WL-Bus/ISA System Board

1MB Cache SRAM

Bank 1

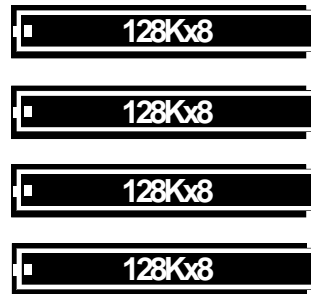

Bank 0

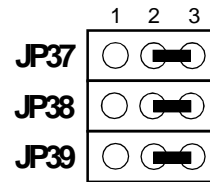
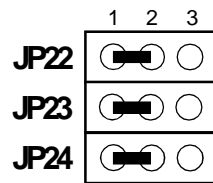
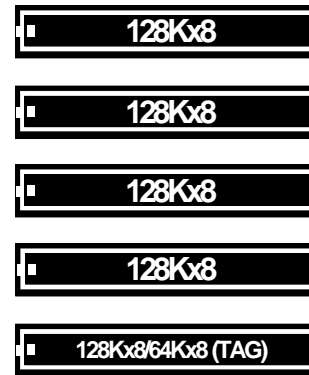



CPU Installation

The G486VPA is equipped with a 237-pin Zero Insertion Force (ZIF) socket at location U27 of the system board. This socket is designed for the easy removal of the old CPU and the easy insertion of the upgrade CPU. If you need to apply excessive force to insert the CPU, the installation is being done incorrectly. Make sure the jumpers are set correctly before applying power, or you may damage the CPU or system board.

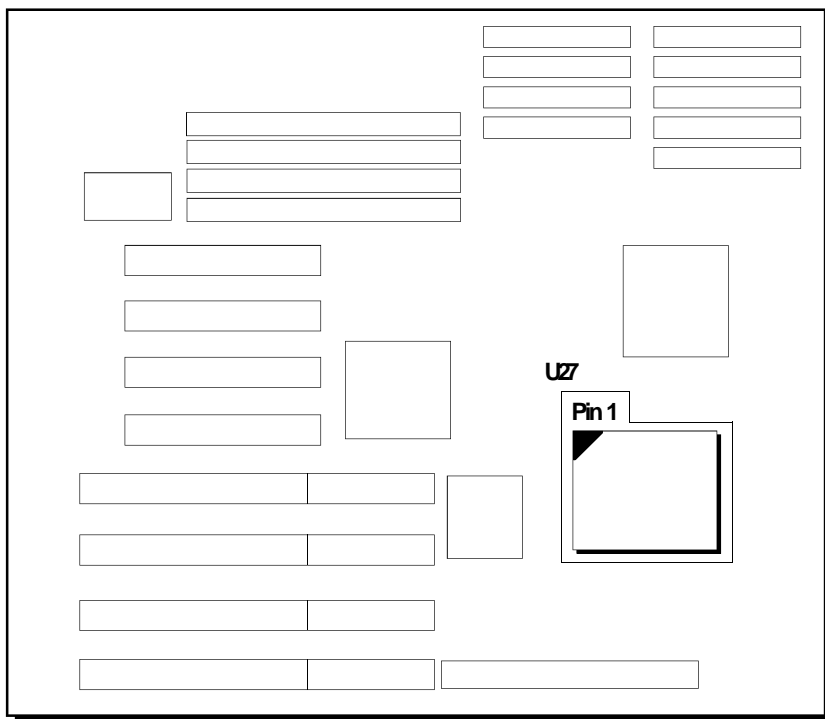

Location of the ZIF Socket on the G486VPA System Board

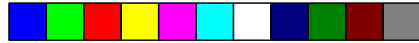

PC/WL-Bus/ISA System Board

Jumper Settings for CPU

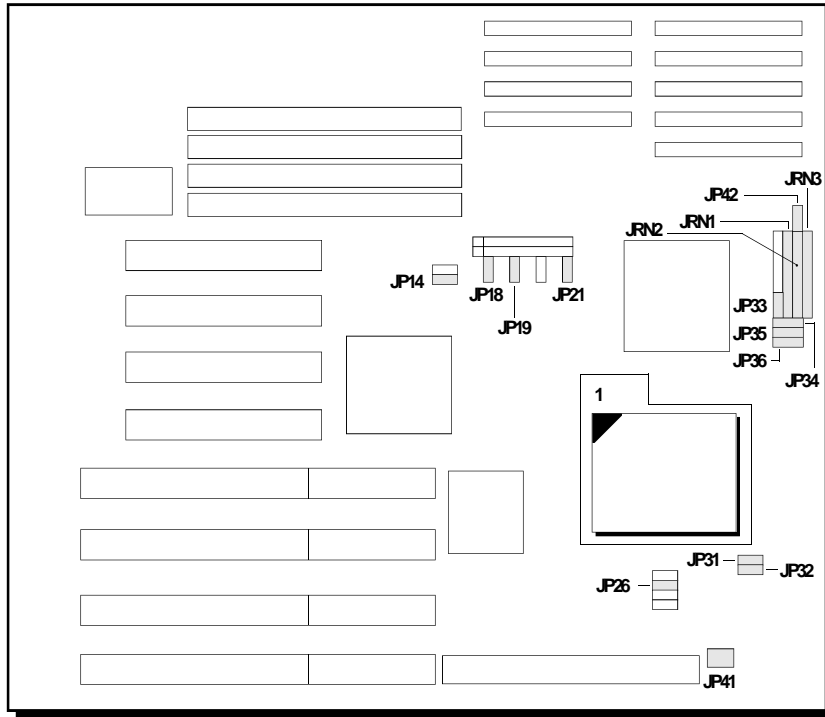

Locations of Jumpers JP14, JP18, JP19, JP21, JP26, JP31, JP32, JP33, JP34, JP35, JP36, JP41, JP42, JRN1, JRN2 and JRN3 on the G486VPA System Board



G486VPA

Intel 486SX

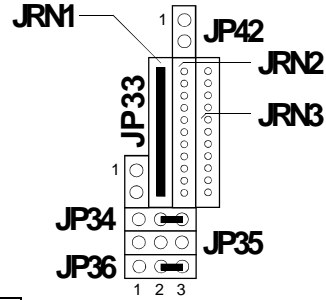
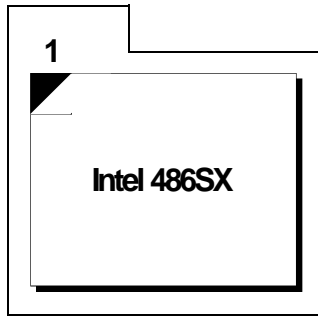

Note:

Make sure Jumpers JP18, JP19 and JP21 are set correctly. These jumpers are used to select the CPU external clock speed. The external CPU clock speed of the Intel 486SX CPU is equal to its internal clock speed. Please refer to page 2-44.

Jumpers JP31, JP32 and JP41 are used to select the CPU voltage. Make sure they are set correctly. Please refer to pages 2-44 and 2-45.

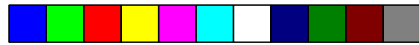

PC/WL-Bus/ISA System Board

Intel 486DX/DX2
(Default Setting)

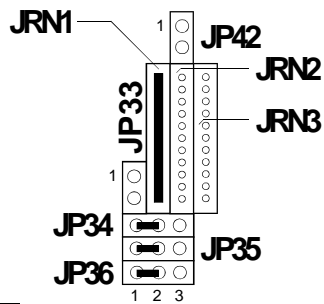
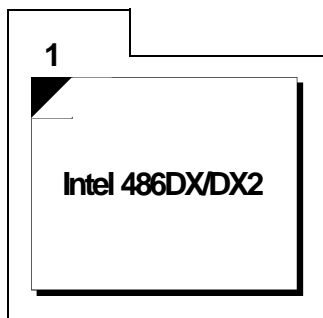

Note:

Make sure Jumpers JP18, JP19 and JP21 are set correctly. The external CPU clock speed of the Intel 486DX CPU is equal to its internal clock speed. To get the external CPU clock speed of the Intel 486DX2 CPU, divide its internal clock speed by 2. Please refer to page 2-44.

Jumpers JP31, JP32 and JP41 are used to select the CPU voltage. Make sure they are set correctly. Please refer to pages 2-44 and 2-45.



G486VPA

Intel 486DX4

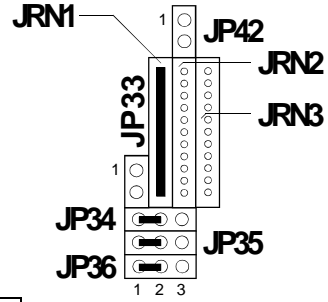
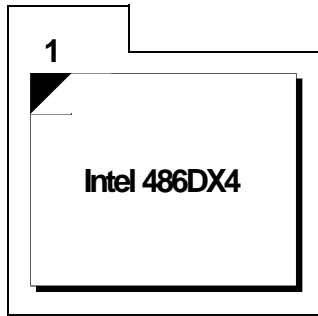

Note:

Make sure Jumpers JP18, JP19 and JP21 are set correctly. To get the external CPU clock speed of the Intel 486DX4, divide its internal clock speed by 3. Please refer to page 2-44.

Jumpers JP31, JP32 and JP41 are used to select the CPU voltage. Make sure they are set correctly. Please refer to pages 2-44 and 2-45.

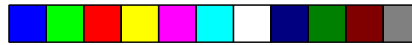

PC/WL-Bus/ISA System Board

Intel Write-back 486 CPU

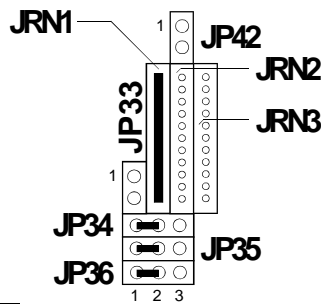
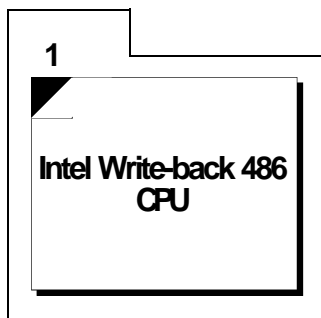

Note:

Set Jumper JP33 pins 1 and 2 to On to support the write through mode for the Intel Write-back 486 CPU.

Make sure Jumpers JP18, JP19 and JP21 are set correctly. To get the external CPU clock speed of the Intel Write-back 486 CPU, divide its internal clock speed by 2. Please refer to page 2-44.

Jumpers JP31, JP32 and JP41 are used to select the CPU voltage. Make sure they are set correctly. Please refer to pages 2-44 and 2-45.



G486VPA

Intel DX4 ODP

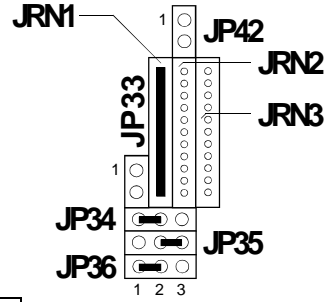
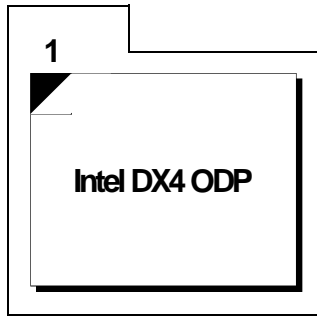

Note:

Make sure Jumpers JP18, JP19 and JP21 are set correctly. To get the external CPU clock speed of the Intel 486DX4 CPU, divide its internal CPU clock speed by 3. Please refer to page 2-44.

Jumpers JP31, JP32 and JP41 are used to select the CPU voltage. Make sure they are set correctly. Please refer to pages 2-44 and 2-45.

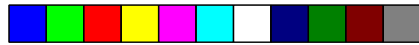

PC/WL-Bus/ISA System Board

Pentium OverDrive Processor

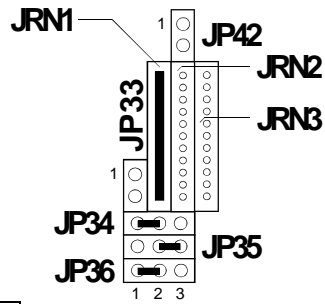
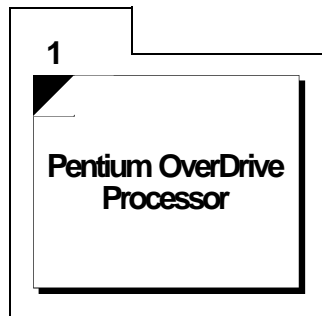

Note:

Make sure Jumpers JP18, JP19 and JP21 are set correctly. To get the external CPU clock speed of the Pentium OverDrive Processor, divide its internal CPU clock speed by 2.5. Please refer to page 2-44.

Jumpers JP31, JP32 and JP41 are used to select the CPU voltage. Make sure they are set correctly. Please refer to pages 2-44 and 2-45.



G486VPA

Cyrix Cx486DX/DX2

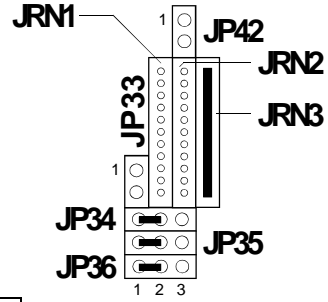
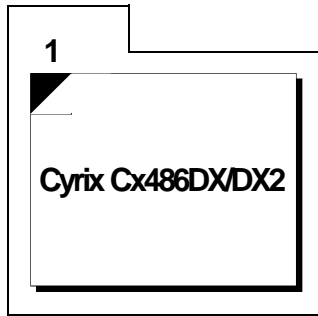

Note:

Make sure Jumpers JP18, JP19 and JP21 are set correctly. The external CPU clock speed of the Cyrix 486DX CPU is equal to its internal clock speed. To get the external CPU clock speed of the Cyrix 486DX2 CPU, divide its internal clock speed by 2. Please refer to page 2-44.

Jumpers JP31, JP32 and JP41 are used to select the CPU voltage. Make sure they are set correctly. Please refer to pages 2-44 and 2-45.

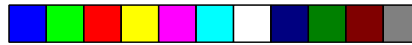

PC/WT-Bus/ISA System Board

SGS-Thomson ST486DX/DX2

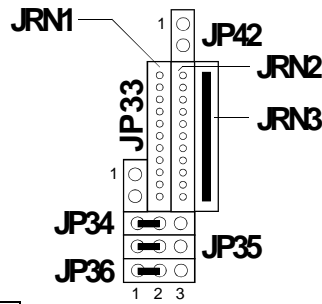
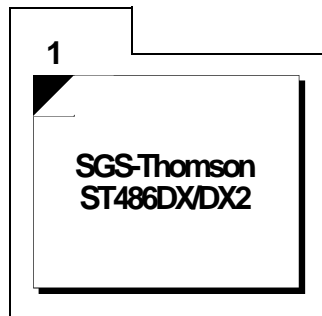

Note:

Make sure Jumpers JP18, JP19 and JP21 are set correctly. The external CPU clock speed of the ST486DX CPU is equal to its internal clock speed. To get the external CPU clock speed of the ST486DX2 CPU, divide its internal clock speed by 2. Please refer to page 2-44.

Jumpers JP31, JP32 and JP41 are used to select the CPU voltage. Make sure they are set correctly. Please refer to pages 2-44 and 2-45.



G486VPA

AMD Am486DX2 (NV8T)

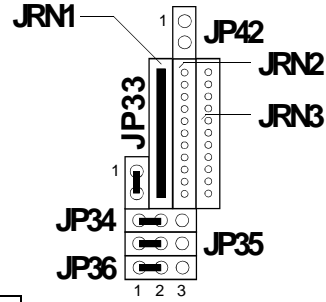
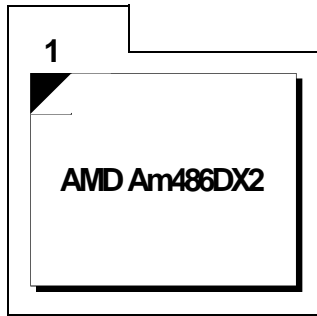

Note:

Make sure Jumpers JP18, JP19 and JP21 are set correctly. To get the external CPU clock speed of the AMD Am486DX2 (NV8T), divide its internal CPU clock speed by 2. Please refer to page 2-44.

Jumpers JP31, JP32 and JP41 are used to select the CPU voltage. Make sure they are set correctly. Please refer to pages 2-44 and 2-45.

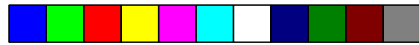

PC/WL-Bus/ISA System Board

Enhanced AMD Am486DX2 (SV8B)

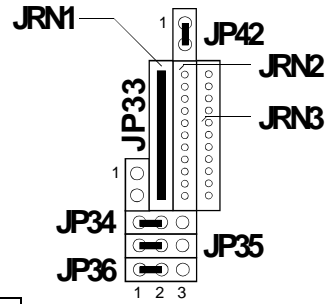
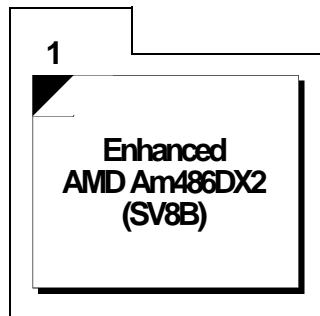

Note:

Jumper JP42 is used to support Enhanced Am486DX2 CPUs.

Make sure Jumpers JP18, JP19 and JP21 are set correctly. To get the external CPU clock speed of the Enhanced AMD Am486DX2 (SV8B), divide its internal CPU clock speed by 2. Please refer to page 2-44.

Jumpers JP31, JP32 and JP41 are used to select the CPU voltage. Make sure they are set correctly. Please refer to pages 2-44 and 2-45.

2-40 ♦ Installation Overview



G486VPA

AMD Am486DX4

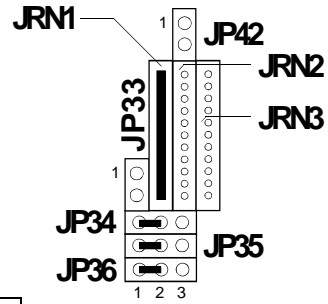
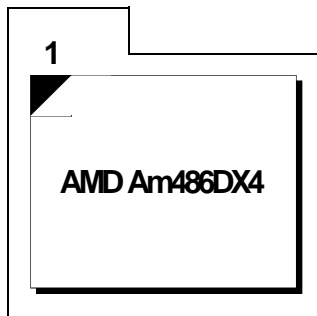

Note:

Make sure Jumpers JP18, JP19 and JP21 are set correctly. To get the external CPU clock speed of the AMD Am486DX4, divide its internal CPU clock speed by 3. Please refer to page 2-44.

Jumpers JP31, JP32 and JP41 are used to select the CPU voltage. Make sure they are set correctly. Please refer to pages 2-44 and 2-45.

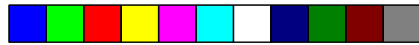

PC/WL-Bus/ISA System Board

UMC U5SD

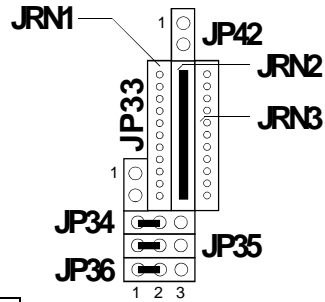
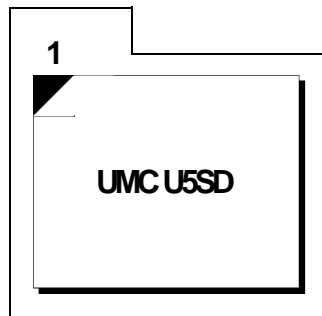

Note:

Make sure Jumpers JP18, JP19 and JP21 are set correctly. The external CPU clock speed of the UMC U5SD CPU is equal to its internal CPU clock speed. Please refer to page 2-44.

Jumpers JP31, JP32 and JP41 are used to select the CPU voltage. Make sure they are set correctly. Please refer to pages 2-44 and 2-45.



G486VPA

UMC U5S/U5SLV

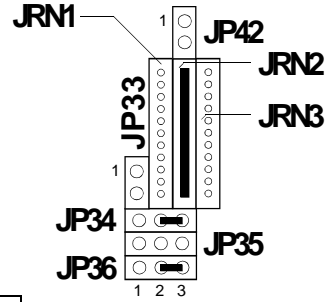
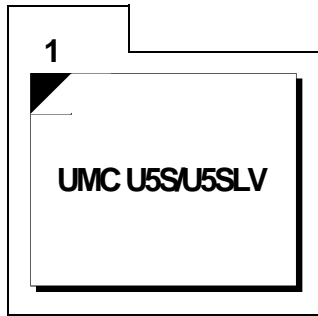

Note:

Make sure Jumpers JP18, JP19 and JP21 are set correctly. The external CPU clock speed of the UMC U5S or U5SLV CPU is equal to its internal CPU clock speed. Please refer to page 2-44.

Jumpers JP31, JP32 and JP41 are used to select the CPU voltage. Make sure they are set correctly. Please refer to pages 2-44 and 2-45.

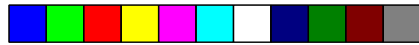

PC/WL-Bus/ISA System Board

AMD DX4 100MHz

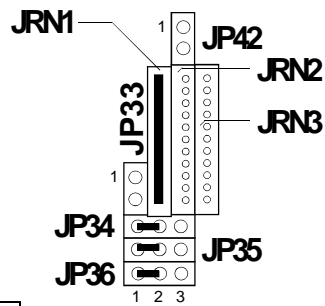
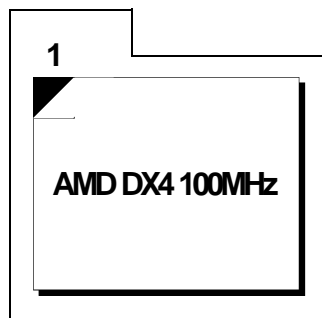

Note:

Make sure Jumpers JP18, JP19 and JP21 are set correctly. The external CPU clock speed of the AMD DX4 100 MHz is equal to its internal CPU clock speed. Please refer to page 2-50.

Jumpers JP31, JP32 and JP41 are used to select the CPU voltage. Make sure they are set correctly. Please refer to pages 2-50 and 2-51.



G486VPA

AMD DX4 120MHz

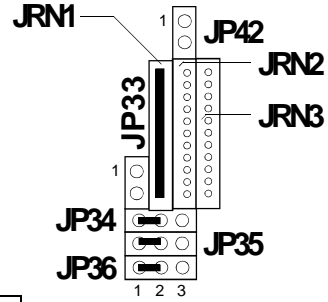
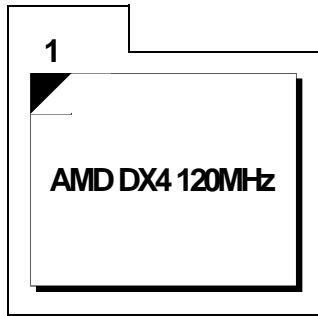

Note:

Make sure Jumpers JP18, JP19 and JP21 are set correctly. The external CPU clock speed of the AMD DX4 120 MHz is equal to its internal CPU clock speed. Please refer to page 2-50.

Jumpers JP31, JP32 and JP41 are used to select the CPU voltage. Make sure they are set correctly. Please refer to pages 2-50 and 2-51.

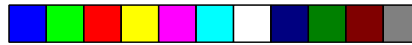

PC/WL-Bus/ISA System Board

Am5x86-P75 133MHz

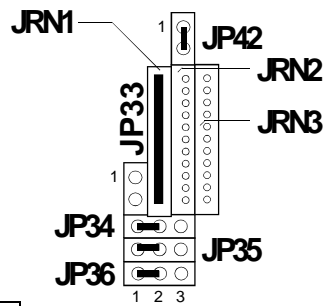
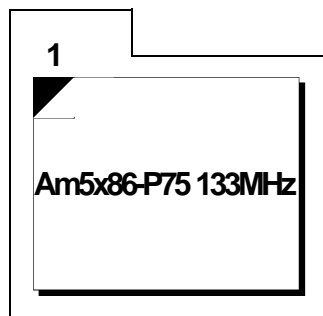

Note:

Make sure Jumpers JP18, JP19 and JP21 are set correctly. The external CPU clock speed of the AMD DX4 133 MHz is equal to its internal CPU clock speed. Please refer to page 2-50.

Jumpers JP31, JP32 and JP41 are used to select the CPU voltage. Make sure they are set correctly. Please refer to pages 2-50 and 2-51.



G486VPA

Cryix 5x86 100MHz

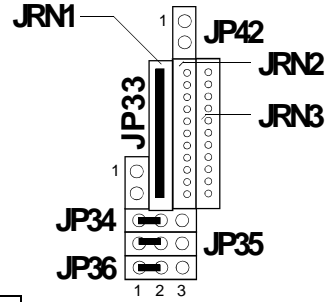
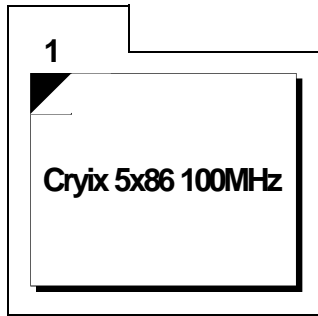

Note:

Make sure Jumpers JP18, JP19 and JP21 are set correctly. The external CPU clock speed of the Cryix 5x86 100 MHz is equal to its internal CPU clock speed. Please refer to page 2-50.

Jumpers JP31, JP32 and JP41 are used to select the CPU voltage. Make sure they are set correctly. Please refer to pages 2-50 and 2-51.

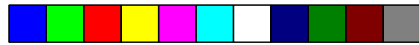

PC/WL-Bus/ISA System Board

Cryix 5x86 120MHz

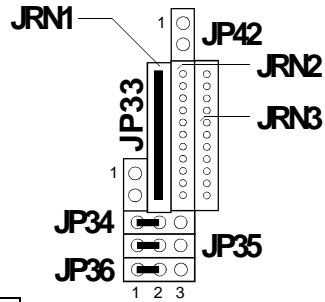
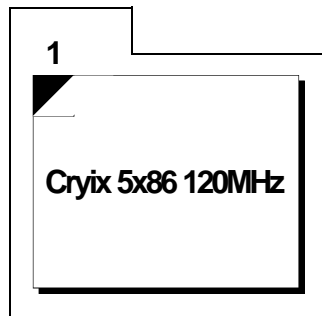

Note:

Make sure Jumpers JP18, JP19 and JP21 are set correctly. The external CPU clock speed of the Cryix 5x86 120 MHz is equal to its internal CPU clock speed. Please refer to page 2-50.

Jumpers JP31, JP32 and JP41 are used to select the CPU voltage. Make sure they are set correctly. Please refer to pages 2-50 and 2-51.



G486VPA

Cryix DX4 100MHz

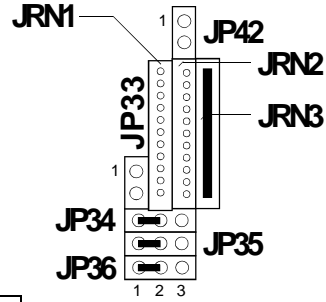
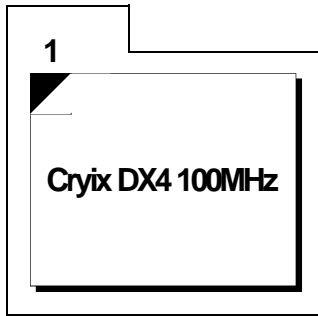

Note:

Make sure Jumpers JP18, JP19 and JP21 are set correctly. The external CPU clock speed of the Cryix DX4 100 MHz is equal to its internal CPU clock speed. Please refer to page 2-50.

Jumpers JP31, JP32 and JP41 are used to select the CPU voltage. Make sure they are set correctly. Please refer to pages 2-50 and 2-51.

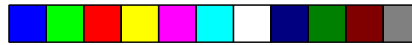

PC/WL-Bus/ISA System Board

Jumpers JP18, JP19 and JP21 CPU External Clock Speed

These jumpers should be set to match the CPU external clock speed.

External CPU Clock Speed	25 Mhz	33 Mhz *	40 Mhz	50 Mhz
Internal CPU Clock Speed	25/50 Mhz	33/66/ 100/133 Mhz	40/80/ 120Mhz	50 Mhz
Pentium ODP Internal Clock Speed	63 Mhz	83 Mhz *		
JP18				
JP19				
JP21				

* Default setting

Jumpers JP31, JP32 and JP41 CPU Voltage Select

5V CPUs:



(Default setting)



3.45V CPUs:

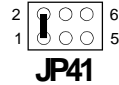
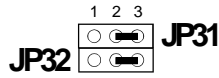

Intel 486 -

- A80486DX4-100
- A80486DX4-75

AMD-

- A80486DX4-100NV8T
- A80486DX2-80NV8T
- A80486DX2-66NV8T
- A80486DX4-100SV8B
- A80486DX4-75SV8B
- A80486DX2-80SV8B
- A80486DX2-66SV8B
- Am486DX2-66V8T
- Am486DX2-80V8T
- Am486DX4-100V8T
- A80486DX4-100SV8B
- A80486DX4-120SV8B
- Am5x86-P75 133MHz

UMC-

- U5SLV-SUPER25
- U5SLV-SUPER33

Cyrix -

- Cx486DX2-V50GP
- Cx486DX4-100
- Cx5x86-100
- Cx5x86-120

3.6V CPUs:

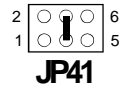
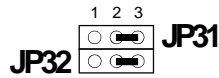

Cyrix -

- Cx486DX2-V66GP

4V CPUs:

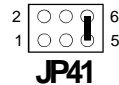
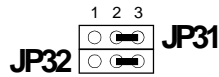

Cyrix -

- Cx486DX2-V80GP



PCWL-Bus/ISA System Board

Jumpers JP8, JP12, JP17, JP20, JP25 and JP27

The jumpers below are for factory testing only and should always be set to their default configurations. Reconfiguring these jumpers will cause problems with your system board.

JP8: Off
JP12, JP17: 1-2 On
JP20: 1-2 On
JP25: 1-2 On
JP27: Off



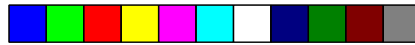

Installing Upgrade CPUs

The G486VPA is equipped with a 237-pin Zero Insertion Force (ZIF) socket at location U27 of the system board. This socket enables you to remove the old CPU and insert the upgrade CPU easily. If you need to apply excessive force to insert the CPU, the installation is being done incorrectly.

Warning:

Open the socket only if actually installing a CPU. The warranty on the original CPU will be voided if the S/N seal is broken. Installation of an OverDrive Processor will not affect the original system warranty.

The 237-pin ZIF socket consists of the four rows of pin holes on each side. To avoid improper installation, the ZIF socket is designed with a Plug/Keying mechanism. There are several holes in the socket that are plugged so the CPU will only go in one way. If you are unable to easily insert the CPU, please verify that pin 1 of the CPU is being plugged into pin 1 of the socket. Pin one is located as shown on the next page.

Caution:

You will need to change the CPU-type jumper settings. (Please see the previous pages of this manual.)

Before proceeding with the upgrade, take note of the following. The microprocessor and heat sink may be hot if the system has been running. To avoid the possibility of a burn, power the system off and let the processor and heat sink cool for 10 minutes.

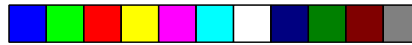

PCI/L-Bus/ISA System Board

Clearance Requirements

The Pentium OverDrive processor comes with a heat sink mounted on top. To maintain proper airflow once the upgrade is installed on the system board, the processor and heat sink require certain space clearances.

The clearance above the OverDrive processor's fan/heat-sink must be at least 0.4 in. The clearance on at least 3 of 4 sides of the processor must be at least 0.2 in. The cables (for floppy drive, hard drive CD-ROM, etc.) must be routed clear of the CPU and its airspace.

Temperature Rating

The ambient or room temperature must be below 37°C (99°F) for a system installed with the Pentium OverDrive processor.

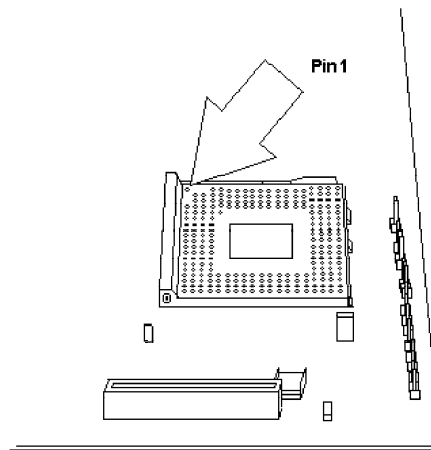

Zero Insertion Force (ZIF) Socket



G486VPA

To install an upgrade CPU in the G486VPA, follow the steps below.

1. Make sure the handle on the side of the ZIF socket is up. To raise the handle, pull it out to the side a little and raise it as far as it will go. The top plate will slide back. Do not use screw drivers or other tools to open the socket, or damage may occur to the system or socket. It may be necessary to initially apply a small amount of sideways force to free the handle from its retaining “tab.” Once clear of the “tab,” the lever will open easily.

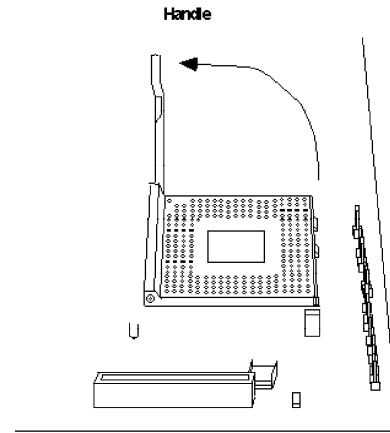

Lifting the Handle

2. Once the lever is completely up, remove the old CPU by carefully lifting it straight out of the socket. You are now ready to insert the new CPU.

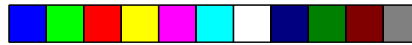

PC/VL-Bus/ISA System Board

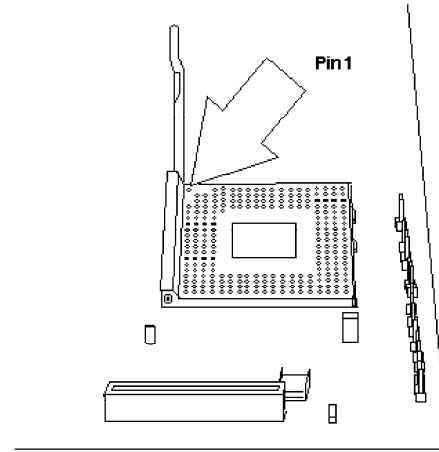

Pin 1 of the ZIF Socket

3. Position the CPU above the ZIF socket. Make sure pin 1 of the CPU is aligned with pin 1 of the socket. Lower the chip until the pins are inserted properly in their corresponding holes. Remember that no force is needed to install the CPU. If the CPU will not easily insert, please verify you have pin 1 of the CPU aligned with pin 1 of the socket. Applying too much pressure can damage the CPU or the socket.



G486VPA

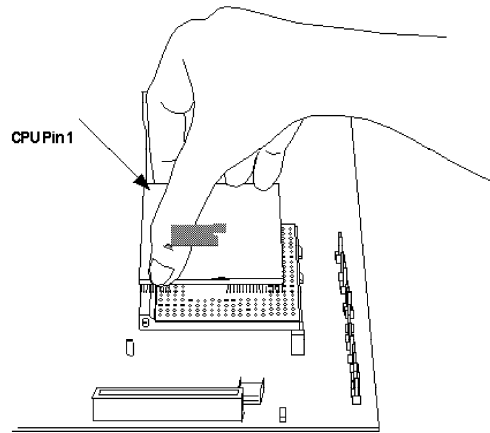

Positioning the CPU Above the ZIF Socket

4. Push the handle down until the handle locks into its place. Top plate will slide forward. You will feel some resistance as the pressure starts to secure the CPU in the socket. This is normal and will not damage the CPU. However, if the handle is not completely closed, damage to the CPU and/or system board may result.

Fan Exhaust

The CPU must be kept cool by using a fan exhaust configuration in connection with the heatsink. The temperature of the air entering the fan/heatsink cannot exceed 45°C.

In order to provide proper airflow to the CPU, all movable obstructions (power supply cables, cards, floppy disk cables) must be clear of the CPU heatsink/fan component in accordance with the space clearance discussed in the CPU installation section of this manual.

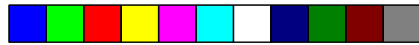

PC/WL-Bus/ISA System Board

Built-in Ports

The G486VPA system board is equipped with two serial ports, one ECP/EPP parallel printer port, one FDD connector, two IDE hard disk connectors and one PS/2 mouse port.

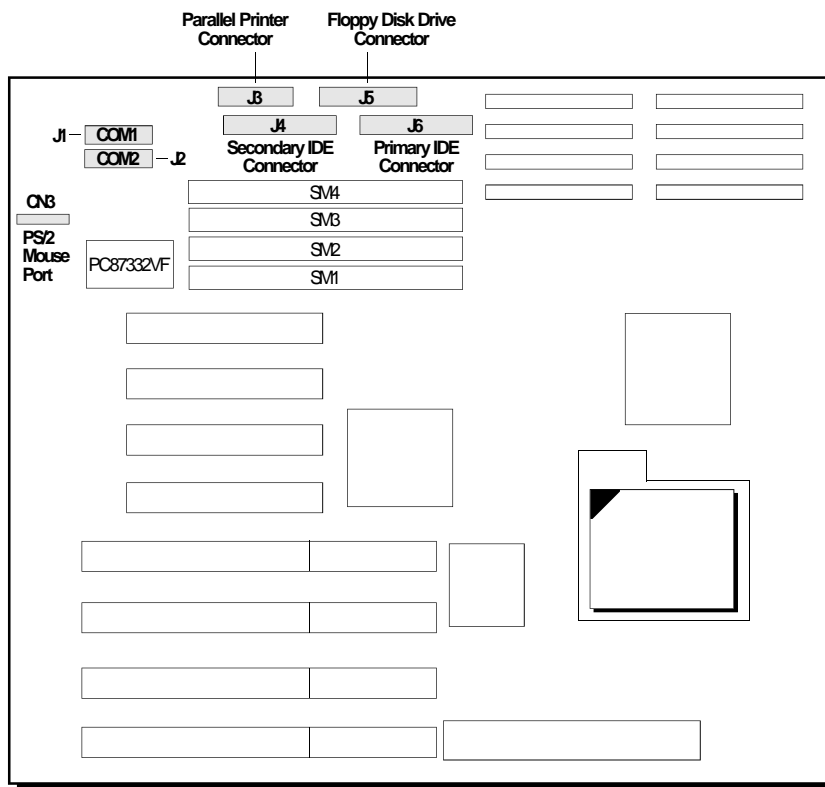

Locations of the Built-in Ports on the System Board



Serial Ports

The built-in serial ports are RS-232C asynchronous communication ports with 16C550-compatible UARTs that can be used with modems, serial printers, remote display terminals, and other serial devices. The G486VPA system board supports IRQ4 for the primary serial port and IRQ3 for the secondary serial port. These serial ports use the following system I/O addresses:

Port Configuration	I/O Address
COM1	3F8h
COM2	2F8h
COM3/COM4	3E8h/2E8h or Disable

Connecting the Serial Ports

Two DB-9P serial port cables are provided with the motherboard. They are mounted on a card-edge bracket along with the PS/2 mouse cable. The upper serial port cable should be used for the COM1 primary serial port; connect it to Connector J1 on the motherboard. The lower serial port cable should be used for the COM2 secondary serial port; connect it to Connector J2 on the motherboard. Make sure the colored stripes on the ribbon cables align with pin 1 of Connectors J1 and J2. Mount the card-edge bracket to the system chassis.



PC/WL-Bus/ISA System Board

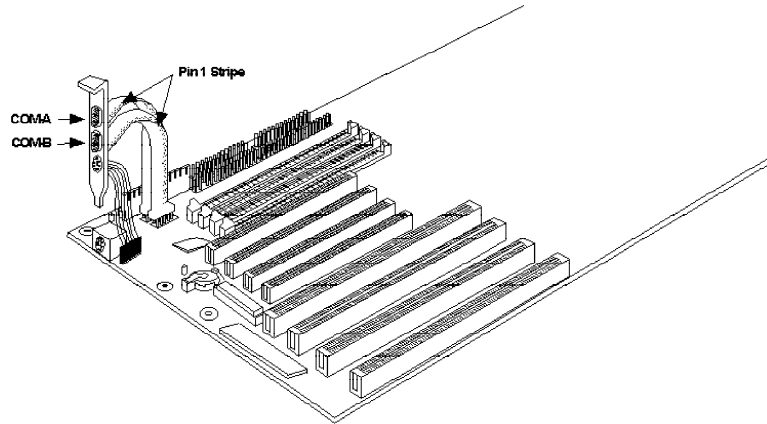

The Primary and Secondary Serial Ports on the G486VPA System Board

PS/2 Mouse Port

The PS/2 mouse port is a 6-pin connector on the system board. Attach the optional 6-pin mouse port cable to Connector CN3. Make sure the brown wire on the PS/2 mouse connector aligns with pin 1 of connector CN3. The other end of the wires are attached to the card-edge bracket that also holds the two serial port cables.



G486VPA

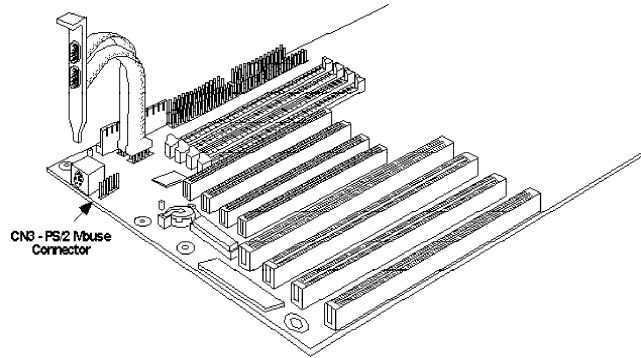

The PS/2 Mouse Connector on the System Board

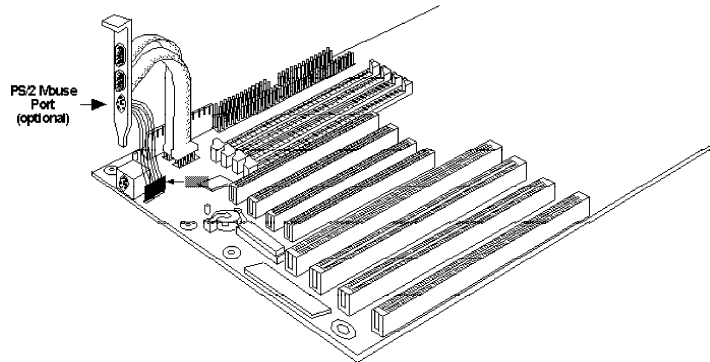

The PS/2 Mouse Port on the System Board

Parallel Port

The G486VPA system board has a standard connector for interfacing your PC to a parallel printer. This port is compatible with both IBM AT printer ports and the new, high speed, bi-directional Extended Capabilities Port standard. The parallel port on your system board can be set to any of the following system I/O addresses:

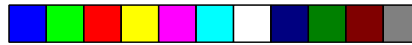

PC/WL-Bus/ISA System Board

Port Configuration	IO Address
LPT1	3BC-3BE Hex
LPT2*	378-37A Hex
LPT3	278-27A Hex

* Default setting

Connecting the Parallel Printer Port

Attach the DB-25S printer port cable, which came with the motherboard, to Connector J3 on the G486VPA system board. Make sure the colored stripe on the ribbon cable aligns with pin 1 of Connector J3. Use a small nutdriver to mount the cable into a DB-25 cutout in the system chassis.

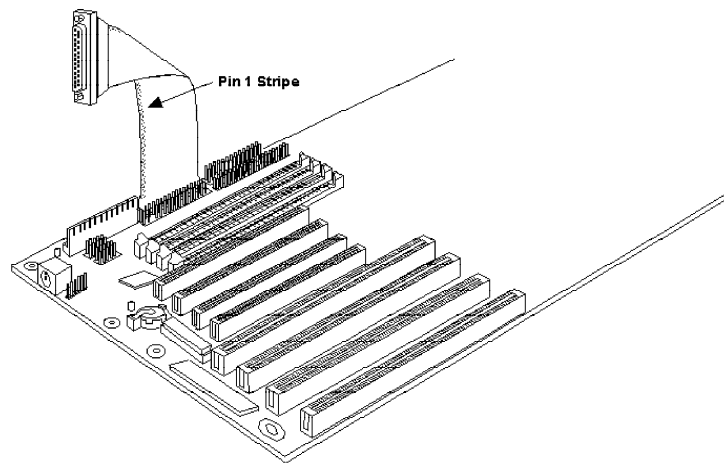

The Parallel Printer Port on the G486VPA System Board



G486VPA

Floppy Disk Drive Controller

The G486VPA system board has a built-in floppy disk controller that supports two standard floppy disk drives. You can install any 360KB/720KB/1.2MB/1.44MB/2.88MB floppy disk drives.

Connecting the Floppy Disk Cable

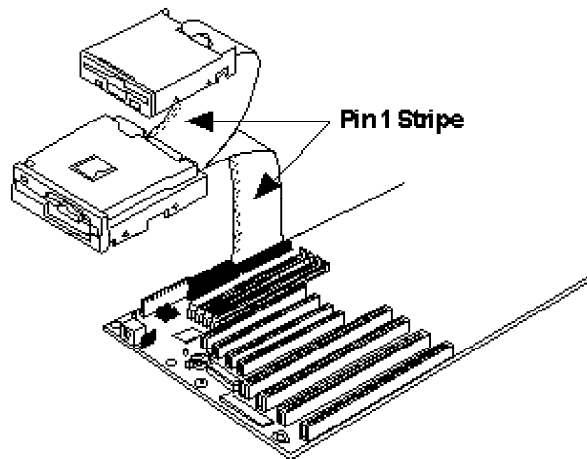

The Floppy Disk Connector on the G486VPA System Board

Step 1

Install the 34-pin header connector into the floppy disk connector (J5) on the system board. The colored edge of the ribbon should be aligned to pin 1 of the J5 connector.

Step 2

Install the other 34-pin header connector(s) into the disk

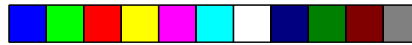

PC/VL-Bus/ISA System Board

drive(s) with the colored edge of the daisy chained ribbon cable aligned to pin 1 of the drive edge connector(s). The end-most connector should be attached to the drive you want to be Drive A.

IDE Hard Disk Interface

The G486VPA system board is equipped with one VL-Bus IDE connector and one ISA IDE connector that will interface four IDE (Integrated Drive Electronics) hard disk drives. An IDE drive is a hard drive with the controller electronics built into the disk assembly. The integration of the controller and the drive as a single unit increases both the reliability and performance by eliminating redundant circuitry.

Note:

Only IDE drives can be connected to the IDE interface.

Connecting the IDE Hard Disk Interface

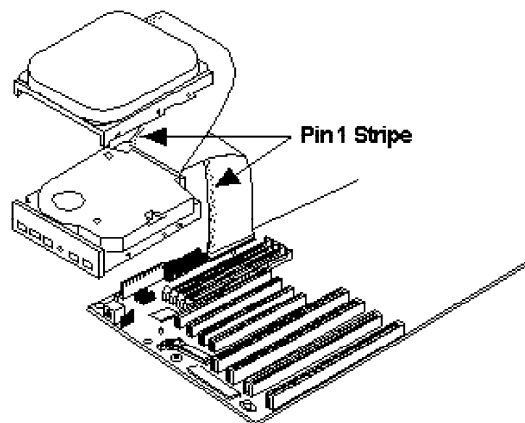

The IDE Hard Disk Connector on the System Board

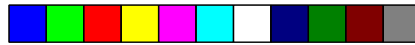

G486VPA

Step 1

If you are connecting two hard drives, install the 40-pin connector of the IDE cable into the primary disk connector (J6). If you are adding a third or fourth IDE device, install the 40-pin connector of the other IDE cable into the secondary connector (J4). Make sure the colored edge of the ribbon is aligned to pin 1.

Step 2

Install the other 40-pin header connector(s) into the device with the colored edge of the ribbon cable aligned to pin 1 of the drive edge connector(s).

Note:

Refer to your disk drive user's manual for information about selecting proper drive switch settings.

Adding a Second IDE Hard Drive

When using two IDE drives, one must be set as the master and the other as the slave. Follow the instructions provided by the drive manufacturer for setting the jumpers and/or switches on the drives. No changes are needed on the G486VPA system board when adding a second hard drive.

We recommend that the IDE hard drives be from the same manufacturer. In a few cases, drives from two manufacturers will not function properly when used together. The problem lies in the hard drives, not the G486VPA system board.



PC/WL-Bus/ISA System Board

Preparing an IDE Drive for Use

IDE disk drives are already low-level formatted, with any bad-track errors entered, when shipped by the drive manufacturer. Do not attempt to do a low-level format, or you may cause serious damage to the drive.

To use an IDE drive, you need to enter the drive type (this information is provided by the drive manufacturer) into the system's CMOS setup table. Then run FDISK and FORMAT provided with DOS.

Note:

Do not run FDISK and FORMAT programs on a drive that has already been formatted, or you will lose all programs and data stored on the drive.



Installing Expansion Cards

The G486VPA is equipped with three dedicated PCI and three dedicated ISA slots. One PCI slot and one ISA slot is shared. You can only install a card in one or the other of the shared slots at a time, you cannot install devices in both slots. Due to the size of the CPU and heatsink/fan component, card size is limited. Refer to the Features and Specifications section, page 1-4, for limitations. The location of the expansion slots are shown below.

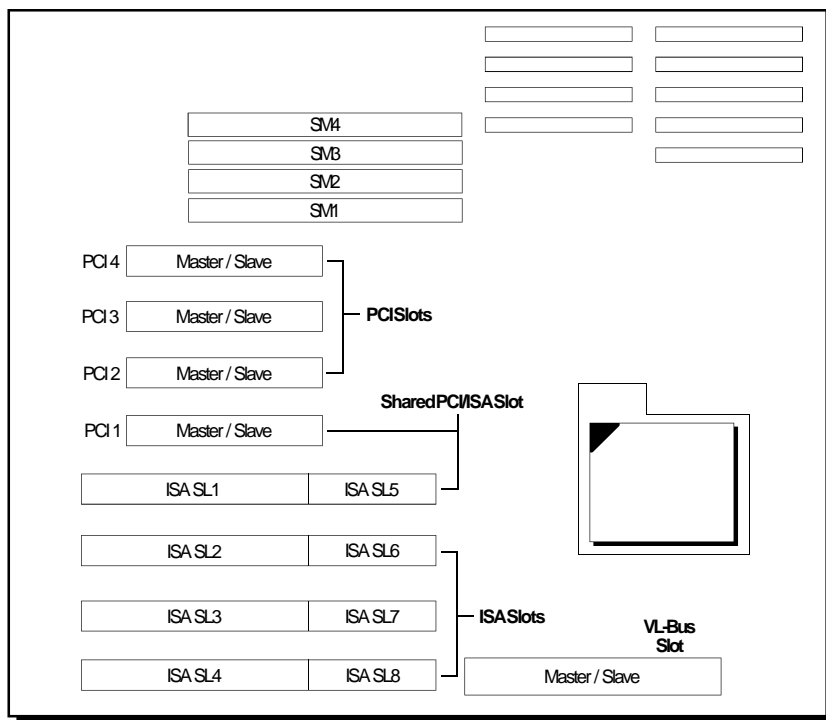



PCI/VL-Bus/ISA System Board

Note:

PCI3 and PCI4 are PCI Master slots and support Master Cards. PCI1, PCI2 and VL-Bus slots share the function of the third Master slot. If you insert a Master Card into one of these slots (PCI1, PCI2 or VL-Bus slot), then the other two slots can support Slave function only.

The BIOS needs to be configured for the PCI add-on cards installed in the PCI slots. Refer to the PCI Configuration Setup on page 3-9 for more information.



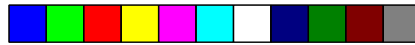

G486VPA

Installing the System Board

Before installing the system board into your system unit, you should prepare the tools you will need:

You will need:

- *one medium size, flat-bladed screwdriver*
- *one medium Phillips screwdriver*

Step 1

Unlock your system unit. Turn off the power and disconnect all power cords and cables.

Step 2

Remove the system unit cover. Refer to the manufacturer's instructions if necessary.

Step 3

Remove expansion cards seated in any of the expansion slots and detach all connectors from the old system board.

Step 4

Loosen the screws holding the original system board and remove the board from the system. Save the screws.

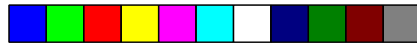

PCI/L-Bus/ISA System Board

Step 5

Remove the G486VPA from its original packing box. Be careful to avoid touching all connectors and pins on the board. Please refer to the handling instructions on pages 2-1 and 2-2 for proper handling techniques.

Step 6

Insert the HSIM modules into the SIMM banks on the G486VPA. The quantity and location of the SIM modules is dependent upon the memory configuration and type of modules you intend to use.

Step 7

Set the corresponding jumpers.

Step 8

Install the prepared G486VPA system board into the case and replace the screws.

Step 9

Reinstall all cards and connectors and replace the system unit cover. Reconnect all power cords and cables.



❖ *Initial Setup Program*

After you power up your system, the BIOS message appears on your screen and the memory count begins.

After the memory test, the following message will appear on the screen:

Press DEL to enter Setup

If the message disappears before you respond, restart your system or press the “Reset” button. You may also restart the system by pressing the <Ctrl> <Alt> keys. If you do not press these keys at the correct time and the system does not boot, the following error message will appear:

Press Del to enter Setup

If you have set a password and selected “System” in the Security Option of the BIOS Feature Setup menu, you will be prompted for the password everytime the system is rebooted or any time you try to enter Setup. Type in the correct password and press <Enter>.

If you selected “Setup” in the Security Option, you will be prompted for the password only when you try to enter Setup. Refer to the “BIOS Features Setup” section for more information.

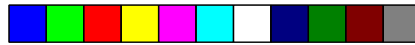

PCWL-Bus/ISA System Board

Award BIOS CMOS Setup Utility

Press <Ctrl> <Alt> <Esc> or simultaneously to enter the Setup utility. A screen similar to the one below will appear.

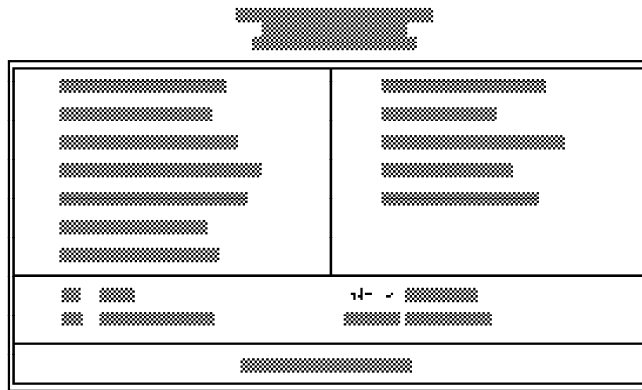

Use the arrow keys to highlight the option you want and press <Enter>.

Standard CMOS Setup

Use the arrow keys to highlight “Standard CMOS Setup” and press <Enter>, a screen similar to the one on the next page will appear.



G486VPA

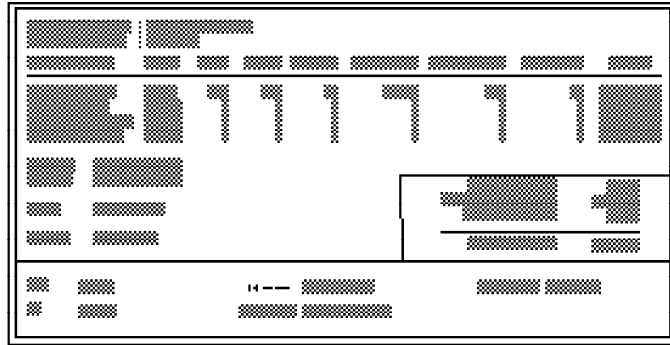

Date and Time

Sets the time and date for the system. Press <F3> for the calendar.

Primary Master, Primary Slave, Secondary Master and Secondary Slave

If you have added an IDE drive, you must select the appropriate type for the drive. You may use the "IDE HDD Auto Detection" from the main CMOS setup menu or you can set it manually. The G486VPA has 46 pre-set types and one user-definable type. Use the <Page Up> or <Page Down> keys to select the appropriate type for the drive.

The table in Appendix G gives a complete listing of the available drive types. Any given drive must be set to one specific drive-type number. Please refer to your IDE drive documentation to find the appropriate type number.



PC/AT-Bus/ISA System Board

If none of the pre-set types is appropriate for your drive, choose “User”, which is the user-definable type. To use this type, highlight either the drive you want to set: Primary Master, Primary Slave, Secondary Master or Secondary Slave. Use the arrow keys until type “User” is showing. Fill in all the parameters as specified by the drive manufacturer. If a drive is not installed, select “None” and press <Enter>.

Drive A and Drive B

These options are used to select the type of floppy disk drives installed in your system. If either of the drives is not present, select “None”. Make sure you choose the correct drive type; otherwise, your system might format the device improperly.

Video

This is used to select the type of video adapter installed in your system.

Halt on

The system will halt if an error is detected during power up.

No Errors: The system boot will not stop for any detected errors.

All Errors: The system will stop whenever the BIOS detects a non-fatal error.

All, But Keyboard: The system will stop for any errors except a keyboard error.

All, But Diskette: The system will stop for any errors except a disk error.

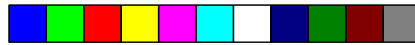

G486VPA

All, But Disk/Key: The system will stop for any errors except a keyboard or disk error.

Memory

The lower right hand corner shows the base memory size, extended memory size, and the other memory size of your system. You cannot alter these items; your computer automatically detects and displays them.

The Other Memory size refers to the memory located in the 640K to 1024K address space. This is the memory used for different applications. DOS uses this area to load device drivers to keep as much base memory free for application programs.

When you are through making changes in the Standard CMOS Setup, press <Esc> to return to the main menu.

BIOS Features Setup

Use the arrow keys to highlight “BIOS Features Setup” and press <Enter>, a screen similar to the one on the next page will appear.



PC/WL-Bus/ISA System Board



The Virus Warning option may be set to “enabled” or “disabled”. When enabled, the BIOS issues a warning when any program or virus sends a Disk Format command or attempts to write to the boot sector of the hard disk drive.

If you choose “System” in the Security Option, you will be prompted for a password every time you cold boot your system or access setup. If you choose “Setup”, you will be prompted for a password only when trying to access setup.

If the changes you made are incorrect or you change your mind, press <F6> or <F7> to return to the default settings. Press <Esc> after making the changes to return to the main menu.

3-6 ◆ Initial Setup Program



Chipset Features Setup

The G486VPA uses VIA chipset. The Chipset Features Setup allows you to modify some functions to optimize system performance. It also allows you to enable, disable or select the port address of the built-in serial ports, parallel port, floppy disk controller and hard disk controller.

If you press <Enter>, a screen similar to the one below will appear.

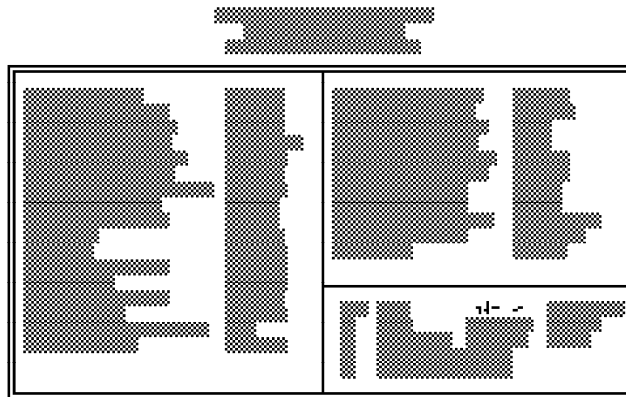

Use the arrow keys to move the highlight bar to the option you wish to change or modify. Use the <Page Up>, <Page Down>, <+> or <-> keys to make the corresponding changes.

If the changes you made are incorrect or you change your mind, press <F6> or <F7> to return to the default settings. Press <Esc> after making the changes to return to the main menu.

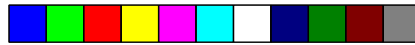

PCWL-Bus/ISA System Board

Power Management Setup

Use the arrow keys to highlight the “Power Management Setup” and press <Enter>. A screen similar to one below will appear

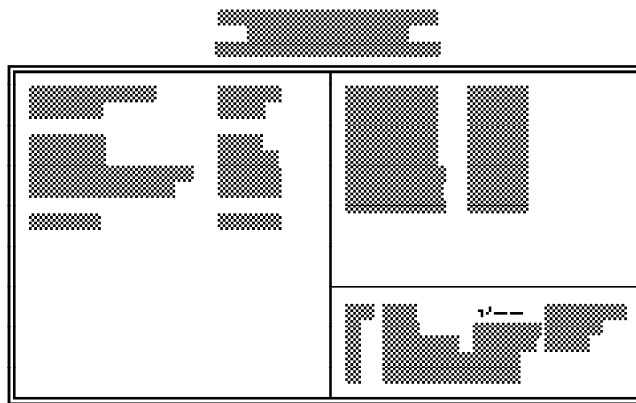

Choosing “Enabled” in the Power Management option will allow you to set Doze Timer, Sleep Timer and Sleep Mode. This will enable your system to reach one of the following power saving stages: Ready, Doze or Suspend. Choose “Disabled” if you do not want your system to enter the power saving mode.

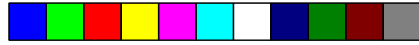

G486VPA

PCI Configuration Setup

Use the arrow keys to highlight “PCI Configuration Setup” and press <Enter>, a screen similar to the one below will appear.



The G486VPA system board supports four PCI slots. Each slot may be assigned INT value if the card installed in the slot requires an interrupt. Each INT may then be assigned an IRQ value.



PC/WL-Bus/ISA System Board

Load BIOS Defaults

If, for some reason, the CMOS becomes corrupted, the system can be reconfigured with the default values stored in the ROM chips. The BIOS default values provide the slowest performance for your system. You should use these values only if you are having hardware problems.

Highlight this option on the main menu and press <Enter>. The message below will appear.

Load BIOS Defaults (Y/N)? N

Type “Y” and press <Enter> to load the BIOS setup default values. After pressing <Enter>, you will be returned to the main menu.

Load Setup Defaults

The Setup default values are the very stable and should be selected as standard values for your system.

Highlight this option on the main menu and press <Enter>. The message below will appear.

Load Setup Defaults (Y/N)? N

Type “Y” and press <Enter> to load the Setup default values. After pressing <Enter>, you will be returned to the main menu.

To configure your system for optimum performance, you must reset the options under the Chipset Features setup. You are advised to do so only under the instruction of a technical engineer, otherwise, failure may occur.

3-10 ◆ Initial Setup Program



Password Setting

If you want to set a password, make sure that the Security Option under the BIOS Features Setup is set to “System” or “Setup” (see page 3-6).

The main screen of the Setup utility allows you to set two types of password, Supervisor Password and User Password.

Supervisor Password

Set a supervisor's password with “System” option selected if you want to protect your system and setup from unauthorized entry.

If you set a supervisor's password when “Setup” option is selected under the BIOS Features Setup, only access to setup will be denied when incorrect password is entered. You will not be prompted for a password when you cold boot the system.

Use the arrow keys to highlight the “Supervisor Password” option and press <Enter>. The message below will appear.

Enter Password:

Type in the password. You are limited to eight characters. Type in a password that is eight characters long or shorter. When done, the message below will appear:

Confirm Password:

You are asked to verify the password. Type in exactly the same password. If you type in a wrong password,

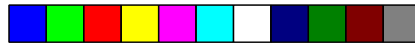

PC/AT-Bus/ISA System Board

you will be prompted to enter the correct password again. Otherwise, enter a new password.

To delete or disable the password function, simply press <Enter> instead of typing in a new password. Press the <Esc> key to return to the main menu.

If you forget your password, you should clear any previously set password by setting Jumper JP2 pins 2 and 3 to On for approximately two minutes. Please refer to page 2-11 for more information.

User Password

Set a user's password with "System" option selected if you want another user to have access only to your system but not to setup. Using user's password to enter Setup allows a user to access only "User Password" option that appears on the main screen. Access to all other options is denied.

If you want to set a user's password when "Setup" option is selected under the BIOS Features Setup, a user will be prompted to enter a password only when trying to access setup. If the correct password is entered, a user will be able to access only "User Password" option that appears on the main screen.

To set, confirm, verify, disable or delete a user's password, follow the procedure described in the section above, "Supervisor Password". If you forget your password, refer to the procedure described in the same section.



G486VPA

IDE HDD Auto Detection

This option detects the hard disk parameters for the hard disk drives installed in your system. Highlight this option and press <Enter>. A screen similar to the one below will appear.

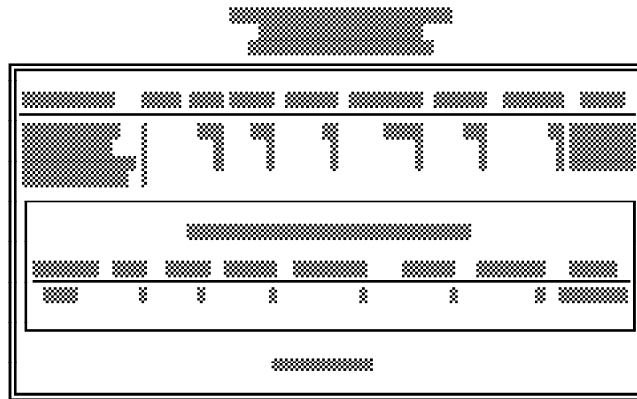

The screen displays the parameters detected and allows you to accept or reject the parameters. Type “Y” and press <Enter> to accept the parameters or press <Esc> to abort. If you select “Y”, the parameters of the hard disk will be displayed in the Standard CMOS Setup.

Save & Exit Setup

When all the changes have been made, highlight “Save & Exit Setup” and press <Enter>. The message below will appear:

Save to CMOS and Exit (Y/N)? N

Type “Y” and press <Enter>. The following message will appear:

Reboot System (Y/N)? N

Type “Y” and press <Enter>. The modifications you have made will be written into the CMOS memory, and the system will reboot. You will once again see the initial diagnostics on the screen. If you wish to make additional changes to the setup, press <Ctrl> <Alt> <Esc> or simultaneously after memory testing is done.

Exit Without Saving

When you do not want to save the changes you have made, highlight this option and press <Enter>. The message below will appear:

Quit Without Saving (Y/N)? N

Type “Y” and press <Enter>. The system will reboot and you will once again see the initial diagnostics on the screen. If you wish to make any changes to the setup, press <Ctrl> <Alt> <Esc> or simultaneously after memory testing is done.



G486VPA

❖ IDE Device Drivers

The G486VPA system board uses the VT82C496G and NS PC87332VL IDE chips that support two IDE channels: 1Fx channel (Primary IDE Channel) and 17x channel (Secondary IDE Channel). The IDE device drivers should be installed under the “INSTALL.EXE” Utility.

The G486VPA comes with one PCI IDE driver diskette. The “VT82C496G VLB Device Drivers” diskette includes drivers for Microsoft Windows 3.1 and 3.11, Windows NT 3.1 and 3.5, OS/2 2.x and 3.0, Novell NetWare 3.11 and 4.0x, SCO UNIX 3.2.4.

Note:

If you are using VT82C496G VLB IDE driver, Block Transfer Mode Option in the System BIOS must be turned off.

“INSTALL.EXE” Utility

“INSTALL.EXE” should be used after you have installed the VIAIDE card in your system.

To run the “INSTALL.EXE” Utility, under DOS prompt type:

A> INSTALL



PC/WL-Bus/ISA System Board

The Main Screen appears allowing you to choose one of the following options:

1. **<F1>: Help** - Press <F1> to get a help message
2. **<Enter>: Continue** - Pressing <Enter> lets you continue the setup utility.
3. **<Esc>: Quit** - Press <Esc> to exit the setup utility. Note that if you press <Enter> while the installation is in progress, you will exit the installation procedure and the IDE drivers will not be successfully installed.

Press <Enter> to proceed with the installation, then select one of the following options:

1. **<F1>: Help** - Press <F1> to get a help message
2. **<F2>: Full Installation** - When chosen, this option lets you install all of the VT82C496G VLB IDE device drivers. These are: Windows and NetWare drivers.
3. **<F3>: Customized Installation** - This option allows you to choose which one of the VT82C496G VLB IDE device drivers you want to install. Refer to the following chapters for more information.
4. **<Esc>: Quit** - Press <Esc> to exit the setup utility or to discontinue the installation process.

Press <F2> to proceed with the Full Installation. When it has been completed, press <Esc> to exit the Utility.



G486VPA

Customized Installation

When you press <F3>, these options appear on the screen:

1. <F1> - Install Windows Driver
2. <F2> - Install NetWare Driver
3. <Esc> - Quit

The following is the description of the first two options.

Installing the Windows 3.1, 3.11 Driver

To install:

Note that the VT82C496G VLB IDE DOS driver should be installed to support the extra DOS functions before you enter Windows System.

The customized installation screen gives you an option to install the Windows driver by pressing <F1>.

After pressing <F1>, the Utility prompts you to enter the name of directory for the driver you want to install. If you press <Enter>, the driver will be installed under the default directory.

You will be also prompted to type a file name that is going to replace the original SYSTEM.INI. If you choose not to enter the new file name, the default name, SYSTEM.VIA, will be used.



PC/WL-Bus/ISA System Board

If you have not turned on the 32bit disk access mode, the Utility will add new lines under CONFIG.SYS. The new lines are as follows:

~~device=c:\windows\system\viaide.386~~

32BitDiskAccess=ON

The Windows driver supports 32bit disk access mode which enables you to optimize your access speed. The Windows driver will be copied from the diskette to the destination directory.

The default IRQ for the second IDE channel is IRQ15. If you have an IDE card that uses IRQ11 and second IDE channel, you should adjust the IRQ value by typing the following line under SYSTEM.INI section (386Enh):

VIA_IRQ=11

The default IRQ15 is replaced by IRQ11.

To remove:

When you install the Windows driver, the original SYSTEM.INI under the Windows directory will be renamed to SYSTEM.VIA.

1. Delete SYSTEM.INI
2. Rename SYSTEM.VIA to SYSTEM.INI
3. Restart Windows.

4-4 ◆ IDE Device Drivers





G486VPA

Installing the NetWare 3.11, 4.0x Driver

To install:

Press <F2> to install the NetWare driver.

The Utility will prompt you to enter the name of directory for the NetWare driver you want to install. If you press <Enter>, the driver will be installed under the default directory.

The NetWare driver can only support the first IDE channel (VT82C496G). The second IDE channel can be supported by NetWare ISA disk. To load the ISA disk and change IRQ value, follow the installation procedures of the NetWare installation manual. The default IRQ for the second IDE channel is IRQ15.

After the installation, you can type “load” command to load the driver into NetWare.

Installing the OS/2 2.x, 3.0 Driver

To install:

To find the disk speed, run “VTSETUP.EXE” Utility under DOS.

After you have executed the speed test, boot the system from OS/2. Under OS/2 command prompt, type <DDINSTAL>. For example:

```
C>DDINSTAL
```



PC/WL-Bus/ISA System Board

Enter the source floppy drive from which OS/2 drive is to be copied. Enter the destination disk drive. VIAIDE.ADD will be copied to the destination drive.

The following line will be appended to CONF.SYS file:

BASEDEV=VIAIDE.ADD

Modify CONFIG.SYS file by moving the line:

BASEDEV=VIAIDE.ADD

in front of the name of the default OS/2 hard disk driver:

BASEDEV=IBM1S506.ADD

If you do not complete this modification, the device driver IBM1S506.ADD will be executed instead of VIAIDE.ADD driver.

After completing the above mentioned procedures, the OS/2 driver is installed.

The default IRQ value for the second IDE driver is IRQ15. If you want to change this value to IRQ11, type:

BASEDEV=VIAIDE.ADD /A:1 /IRQ:11



G486VPA

To remove:

1. Remove the driver setting by deleting BASEDEV=VIAIDE.ADD in your C:\CONFIG.SYS file.
2. Reboot the system.

Installing the SCO UNIX 3.2.4 Driver

To install:

You should prepare a blank diskette, 1.2MB (5.25") or 1.44MB (3.5"), to complete the installation. Follow these steps to convert the "VT82C496G VLB IDE Device Drivers" diskette, which is prepared with DOS format, into a SCO UNIX custom installable diskette.

1. Login to SCO UNIX by typing:

login : root

2. Insert the "VT82C496G VLB IDE Device Drivers" diskette into a floppy drive.
3. Under SCO UNIX prompt "#", type the following commands:

```
# doscp /dev/fd0135ds18:/unix/install /tmp <1.44MB 3.5" drive>  
# sh /tmp/install
```

or

```
# doscp /dev/fd096ds15:/unix/install /tmp <1.2MB 5 1/4" drive>  
# sh /tmp/install
```



PC/WL-Bus/ISA System Board

This procedure has provided you with an SCO UNIX custom installable diskette that you should use to install “VT82C496G VLB IDE Device Driver” to your SCO Unix using the custom command. Follow these steps:

1. Insert the SCO Unix custom installable diskette into a floppy drive.
2. Type: **# custom**
3. Follow the installation instructions and rebuild the kernel.

If you wish to install the IDE drivers for the secondary IDE channel (channel 17x), execute the following commands to extract the major number:

configure -j vth1

For example, if you get the major number “24”, you can make the nodes for the 17x drivers in the following way:

1. For the drive 0 of the channel 17x:

mknod /dev/mio0 b 24 40

2. For the drive 1 of the channel 17x:

mknod /dev/mio1 b 24 104

IRQ15 is the default IRQ value for the secondary IDE channel. Use this method to change the IRQ value:



1. Edit the file `/etc/conf/pack.d/vth1/space.c` to change the define IRQ number 15 to 11 in the following way:

```
#define WD1_0_VECT 11
```

2. Relink the kernel by typing:

```
# /etc/conf/cf.d/link_unix
```

3. Use the kernel as the boot kernel.

To remove:

Follow the instructions about removing “VIA VESA/IDE Device Driver” and rebuild the kernel.

Installing the Windows NT 3.1, 3.5 Driver

To install:

The Windows NT driver can be installed using two methods. The first method is to install the IDE Windows NT driver at the Windows NT setup time. The second one is to install the IDE Windows driver after the system setup. The first method is recommended because if you do not install the IDE Windows NT driver at the Windows NT setup time, Windows NT system will not boot properly. In that case, you should disable the onboard IDE and plug in a non-enhanced IDE to boot Windows NT. Install the VT82C496G Windows NT driver using the second installation method. Then shut down the system and enable the onboard IDE to boot Windows NT.

The First Installation Method

To install:

After booting your system from Windows NT setup floppy drive, the “Welcome to Setup” screen will be displayed. Press <Enter> to continue the setup procedure.

After pressing <Enter>, you are prompted to choose a setup method. The following two methods are given:

1. **Express Setup**
2. **Custom Setup**

Select the “Custom Setup” method by typing “C”.

The system will start scanning for SCSI adapters. All the SCSI adapters found will be displayed on the screen. If you want to configure additional SCSI adapters, type “S”. Navigate the light bar to select the option “Other (Requires disk provided by a hardware manufacturer)”. Insert the “VT82C496G VLB IDE Device Drivers” diskette into a floppy drive and press <Enter>.

Once the “VIA VT82C496G” device driver is recognized by Windows NT, press <Enter> to continue the setup.

After the “VIA VT82C496G” device driver setup, the device driver will be displayed on the previous SCSI adapters screen. Press <Enter> to continue Windows NT Setup. Follow the Windows NT procedure to install the rest of the Windows NT drivers.



G486VPA

To remove:

The first installation method cannot be removed.

The Second Installation Method

To install:

To install the IDE Windows NT driver, follow these steps:

1. Under the Main window select the Windows NT Setup icon.
2. Choose the “Options” menu.
3. Navigate the light bar to select the “Add/Remove SCSI Adapters” option. Click the “Add” button and the “Setup Message” box will appear. Click the “OK” button to continue the installation.
4. Pull down the “Adapter” menu and navigate the light bar to select the “Other (Requires a disk from a hardware manufacturer)” option.
5. Insert the “VT82C496G VLB IDE Device Drivers” diskette into a floppy drive.
6. Change the path to: **A:\nt**. Click the “OK” button and the “Select OEM Option” message box will appear. The “VIA VT82C496G” item will be displayed. Click the “OK” button again.





PC/WL-Bus/ISA System Board

7. At the “Select SCSI Adapter Option” message box, click the “Install” button and then the “Continue” button to complete the installation.
8. Reboot the system.

Note:

IRQ15 is the default IRQ value for the secondary IDE channel. It cannot be changed.

To remove:

1. Under the Main window select the Windows NT Setup icon.
2. Choose the “Options” menu.
3. To remove the Windows NT driver, navigate the light bar to select the “Add/Remove SCSI Adapters” option.
4. Navigate the light bar to select the SCSI Adapter “VIA VT82C496G”. Click the “Remove” button. The “Setup Message” message box will appear.
5. Click the “OK” button to continue the procedure.

To disable:

To disable the Windows NT driver installed after the system setup, follow this procedure:

1. Under the Main window select the Control Panel icon.





G486VPA

2. Choose the “Devices” menu.
3. Navigate the light bar to select the “vtdisk” Device and then click the “Startup” button.

Note:

At this stage you can apply another method that would allow you to disable the Windows NT driver. Instead of selecting “vtdisk” from the “Devices” menu, you can choose “OEMSCSI”. Click the “Startup” button and then proceed with step four.

4. Change “Startup Type” from “Boot” to “Disable”, then click the “OK” button to complete the procedure.



❖ *Troubleshooting Checklist*

If you experience difficulty with the G486VPA system board, please refer to the checklist below. If you still cannot isolate the problem, please contact your dealer.

- 1) Check the jumper settings to ensure that the jumpers are properly set. If in doubt, refer to the “Board Configuration” section.
- 2) Verify that all SIM modules are seated securely into the bank sockets.
- 3) Make sure that the SIM modules are in the correct locations.
- 4) Check that all populated memory banks are filled with valid size SIM modules.
- 5) If your board fails to function, place the board on a flat surface and seat all socketed components (gently press each component into the socket).
- 6) If you made changes to the BIOS settings, re-enter setup and load the BIOS defaults.
- 7) Check if the internal battery needs to be replaced. The internal battery is located beside the slot PCI3 and just above the Flash EPROM.

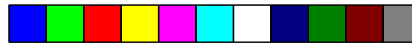

G486VPA

You should replace the old battery with the type of Lithium battery already used on your system board, 3V Lithium battery CR2032. One of the battery sockets presented below is supported by your G486VPA board.

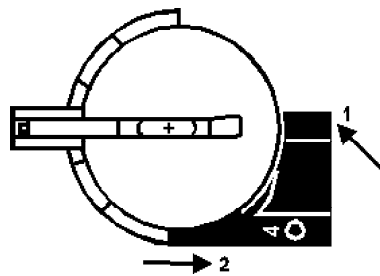

To remove the battery from the socket above, push the black button downward (1) and the battery to the right (2).

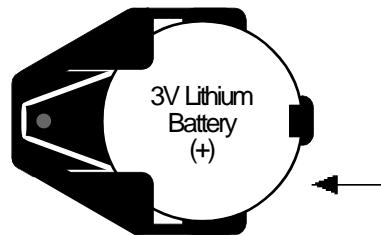

To remove the battery from the socket, simply push the battery to the left. It will slide out of the socket.

Caution:

Battery may explode if mistreated. Do not recharge, disassemble or dispose of in fire.

❖ *Appendix A: Types of Modules*

The G486VPA system board allows you to populate memory with 256Kx36, 512Kx36, 1Mx36, 2Mx36, 4Mx36, 8Mx36 and 16Mx36 SIM modules. The following modules have been tested with this board. Most untested brands will work but a few may fail to do so.

For SIM 256Kx36 Modules

Brand	Chip Number
OKI	M51C256A-70

For SIM 512Kx36 Modules

Brand	Chip Number
OKI	M514256B-70J

For SIM 1Mx36 Modules

Brand	Chip Number
Toshiba	TC511000AJL
OKI	GT-1M*36B
Fujitsu	81C1000A-70



G486VPA

For SIM 2Mx36 Modules

Brand	Chip Number
OKI	M511000B

For SIM 4Mx36 Modules

Brand	Chip Number
OKI	M514100A-70S

For SIM 8Mx36 Modules

Brand	Chip Number
OKI	M514100AL-70K



❖ **Appendix B: System Error Report**

When the BIOS encounters an error that requires the user to correct something, either a beep code will sound or a message will be displayed in a box in the middle of the screen and a message **PRESS F1 TO CONTINUE**, **CTRL-ALT-ESC** or **DEL TO ENTER SETUP** will be shown in the information box at the bottom.

POST Beep

Currently, there is only one beep code in BIOS. This code indicates that a video error has occurred and the BIOS cannot initialize the video screen to display any additional information. This beep code consists of a single long beep followed by two short beeps.

Error Messages

One or more of the following messages may be displayed if the BIOS detects an error during the POST.

CMOS BATTERY HAS FAILED

CMOS battery is no longer functional. It should be replaced. The replacement battery is a 3V Lithium CR2032. Replacing the battery will clear the CMOS. Refer to the Jumper JP2 section of this manual, page 2-11, to reset the CMOS. Location of the battery and replacement procedure are given on pages 5-1 and 5-2 of the manual.



CMOS CHECKSUM ERROR

Checksum of CMOS is incorrect. This can indicate that CMOS has become corrupt. This error may have been caused by a weak battery. Check the battery and replace if necessary.

DISK BOOT FAILURE, INSERT SYSTEM DISK AND PRESS ENTER

No boot device was found. Insert a system disk into Drive A and press <Enter>. Assuming the system is booted from the hard drive, make sure the controller is inserted correctly and all cables are properly attached. Also, be sure the disk is formatted as a boot device; then reboot the system.

DISKETTE DRIVES OR TYPES MISMATCH ERROR - RUN SETUP

Type of diskette drive installed in the system is different from the CMOS definition. Run setup to reconfigure the drive type correctly.

DISPLAY SWITCH IS SET INCORRECTLY

Display switch on the motherboard can be set to either monochrome or color. This indicates the switch is set to a different setting than indicated in Setup. Determine which setting is correct, and then either turn off the system and change the jumper, or enter Setup and change the VIDEO selection.

DISPLAY TYPE HAS CHANGED SINCE LAST BOOT

Since last powering off the system, the display adapter has been changed. You must configure the system for the new display type.

ERROR ENCOUNTERED INITIALIZING HARD DRIVE

Hard drive cannot be initialized. Be sure the adapter is installed correctly and all cables are correctly and firmly attached. Also, be sure the correct hard drive type is selected in Setup (refer to Appendix G).

ERROR INITIALIZING HARD DISK CONTROLLER

Cannot initialize controller. Make sure the card is correctly and firmly installed in the bus. Be sure the correct hard drive type is selected in Setup. Also, check to see if any jumper needs to be set correctly on the hard drive.

FLOPPY DISK CNTRLR ERROR OR NO CNTRLR PRESENT

Cannot find or initialize the floppy drive controller. Make sure the controller is installed correctly and firmly. If there are no floppy drives installed, be sure the Diskette Drive selection in Setup is set to NONE.

KEYBOARD ERROR OR NO KEYBOARD PRESENT

Cannot initialize the keyboard. Make sure the keyboard is attached correctly and no keys are being pressed during the boot.

If you are purposely configuring the system without a keyboard, set the error halt condition in Setup to HALT ON ALL, BUT KEYBOARD. This will cause the BIOS to ignore the missing keyboard and continue the boot.

MEMORY ADDRESS ERROR AT...

Indicates a memory address error at a specific location. You can use this location along with the memory map for your system to find and replace the bad memory chips.



MEMORY PARITY ERROR AT...

Indicates a memory parity error at a specific location. You can use this location along with the memory map for your system to find and replace the bad memory chips.

MEMORY SIZE HAS CHANGED SINCE LAST BOOT

Memory has been added or removed since the last boot. Enter Setup and enter the new memory size in the memory fields.

MEMORY VERIFY ERROR AT...

Indicates an error verifying a value already written to memory. Use the location along with your system's memory map to locate the bad chip.

OFFENDING ADDRESS NOT FOUND

This message is used in conjunction with the I/O CHANNEL CHECK and RAM PARITY ERROR messages when the segment that has caused the problem cannot be isolated.

OFFENDING SEGMENT

This message is used in conjunction with the I/O CHANNEL CHECK and RAM PARITY ERROR messages when the segment that has caused the problem has been isolated.

PRESS A KEY TO REBOOT

This will be displayed at the bottom screen when an error occurs that requires a reboot. Press any key and the system will reboot.





PC/WL-Bus/ISA System Board

PRESS F1 TO DISABLE NMI, F2 TO REBOOT

When BIOS detects a Non-Maskable Interrupt condition during boot, this will allow NMI to be disabled and continue to boot. You can also reboot the system with the NMI enabled.

RAM PARITY ERROR - CHECKING FOR SEGMENT

Indicates a parity error in Random Access Memory.

SYSTEM HALTED, (CTRL-ALT-DEL) TO REBOOT...

Indicates the present boot attempt has been aborted and the system must be rebooted. Press and hold down the CTRL and ALT keys and press DEL simultaneously.





G486VPA

❖ *Appendix C: Memory & I/O Maps*

Memory Address Map

Address	Name	Function
0000000 to 009FFFF	640K System Board RAM	System Board Memory
00A0000 to 00BFFFF	128K Video Display Memory	Reserved for Graphics Display Memory
00C0000 to 00E7FFF	160K I/O Expansion ROM	Reserved for ROM on I/O Adapter Card
00E8000 to 00FFFFFF	96K ROM on the System Board	System Board BIOS
0100000 to 3FFFFFF	Maximum Memory 128M	System Board Memory

I/O Address Map

I/O Address	Function
000-01F	DMA Controller 1, 8237A-5
020-03F	Interrupt Controller 1, 8259A, Master
040-05F	Timer, 8254-2
060-06F	8742 (Keyboard Controller)
070-07F	Real-time Clock, NMI (Non-maskable Interrupt) Mask
080-09F	DMA Page Memory, 74LS612
0A0-0BF	Interrupt Controller 2, 8259A
0C0-0DF	DMA Controller 2, 8237A-5
0E8	Shadow RAM and Cache Control Bit
0F0	Clear Numeric Processor Extension Busy
0F1	Reset Numeric Processor Extension
0F8-0FF	Numeric Processor Extension
170-178	Secondary Fixed Disk
1F0-1F8	Primary Fixed Disk
200-207	Game I/O
278-27F	Parallel Printer Port 2
2F8-2FF	Serial Port 2
300-31F	Prototype Card
360-36F	Reserved
378-37F	Parallel Printer Port 1
380-38F	SDLC, Bisynchronous 2
3A0-3AF	Bisynchronous 1
3B0-3BF	Monochrome Display and Printer Adapter
3C0-3CF	Reserved
3D0-3DF	Color/Graphics Monitor Adapter
3F0-3F7	Diskette Controller
3F8-3FF	Serial Port 1

Note:

The I/O address hex 000 to 0FF are reserved for the system board I/O. Hex 100 to 3FF are available on the I/O channels.

❖ Appendix D: PCI I/O Pin Assignments

Component Side	B	A	Solder Side
	-12V	-01 -	TRST#
	TCK	-02 -	+12V
	Ground	-03 -	TMS
	TDO	-04 -	TDI
	+5V	-05 -	+5V
	+5V	-06 -	INTA#
	INTB#	-07 -	INTC#
	INTD#	-08 -	+5V
	PRSNT1#	-09 -	Reserved
	Reserved	-10 -	+5V (I/O)
	PRSNT2#	-11 -	Reserved
	Ground	-12 -	Ground
	Ground	-13 -	Ground
	Reserved	-14 -	Reserved
	Ground	-15 -	RST#
	CLK	-16 -	+5V (I/O)
	Ground	-17 -	GNT#
	REQ#	-18 -	Ground
	+5V (I/O)	-19 -	Reserved
	AD[31]	-20 -	AD[30]
	AD[29]	-21 -	+3.3V
	Ground	-22 -	AD[28]
	AD[27]	-23 -	AD[26]
	AD[25]	-24 -	Ground
	+3.3V	-25 -	AD[24]
	C/BE[3]#	-26 -	IDSEL
	AD[23]	-27 -	+3.3V
	Ground	-28 -	AD[22]
	AD[21]	-29 -	AD[20]
	AD[19]	-30 -	Ground
	+3.3V	-31 -	AD[18]
	AD[17]	-32 -	AD[16]
	C/BE[2]#	-33 -	+3.3V
	Ground	-34 -	FRAME#
	IRDY#	-35 -	Ground
	+3.3V	-36 -	TRDY#
	DEVSEL#	-37 -	Ground
	Ground	-38 -	STOP#
	LOCK#	-39 -	+3.3V
	PERR#	-40 -	SDONE
	+3.3V	-41 -	SBO#
	SERR#	-42 -	Ground
	+3.3V	-43 -	PAR
	C/BE[1]#	-44 -	AD[15]
	AD[14]	-45 -	+3.3V
	Ground	-46 -	AD[13]
	AD[12]	-47 -	AD[11]
	AD[10]	-48 -	Ground
	Ground	-49 -	AD[09]
	AD[08]	-52 -	C/BE[0]#
	AD[07]	-53 -	+3.3V
	+3.3V	-54 -	AD[06]
	AD[05]	-55 -	AD[04]
	AD[03]	-56 -	Ground
	Ground	-57 -	AD[02]
	AD[01]	-58 -	AD[00]
	+5V (I/O)	-59 -	+5V (I/O)
	ACK64#	-60 -	REQ64#
	+5V	-61 -	+5V
	+5V	-62 -	+5V



❖ Appendix E: ISA I/O Pin Assignments

B		A
Gnd	- 01 -	-I/OChck
Reset.Drv	- 02 -	SD7
+5VDC	- 03 -	SD6
IRQ9	- 04 -	SD5
-5VDC	- 05 -	SD4
DRQ2	- 06 -	SD3
-12VDC	- 07 -	SD2
OAS	- 08 -	SD1
+12VDC	- 09 -	SD0
Gnd	- 10 -	-I/OChrdy
-SEMEMM	- 11 -	AEN
-SEMEMR	- 12 -	SA19
-IOW	- 13 -	SA18
-IOR	- 14 -	SA17
-Dack3	- 15 -	SA16
DRQ3	- 16 -	SA15
-Dack1	- 17 -	SA14
DRQ1	- 18 -	SA13
-Refresh	- 19 -	SA12
CLK	- 20 -	SA11
IRQ7	- 21 -	SA10
IRQ6	- 22 -	SA9
IRQ5	- 23 -	SA8
IRQ4	- 24 -	SA7
IRQ3	- 25 -	SA6
-Dack2	- 26 -	SA5
TC	- 27 -	SA4
Bale	- 28 -	SA3
+5VDC	- 29 -	SA2
OSC	- 30 -	SA1
Gnd	- 31 -	SA0

D		C
-MemCS16	- 01 -	SBHE
-I/OCS16	- 02 -	LA23
IRQ10	- 03 -	LA22
IRQ11	- 04 -	LA21
IRQ12	- 05 -	LA20
IRQ13	- 06 -	LA19
IRQ14	- 07 -	LA18
-Dack0	- 08 -	LA17
DRQ0	- 09 -	-Memr
-Dack5	- 10 -	-Memw
DRQ5	- 11 -	SD08
-Dack6	- 12 -	SD09
DRQ6	- 13 -	SD10
-Dack7	- 14 -	SD11
DRQ7	- 15 -	SD12
+5VDC	- 16 -	SD13
-Master	- 17 -	SD14
Gnd	- 18 -	SD15



G486VPA

❖ Appendix F: Connector Pin Assignments

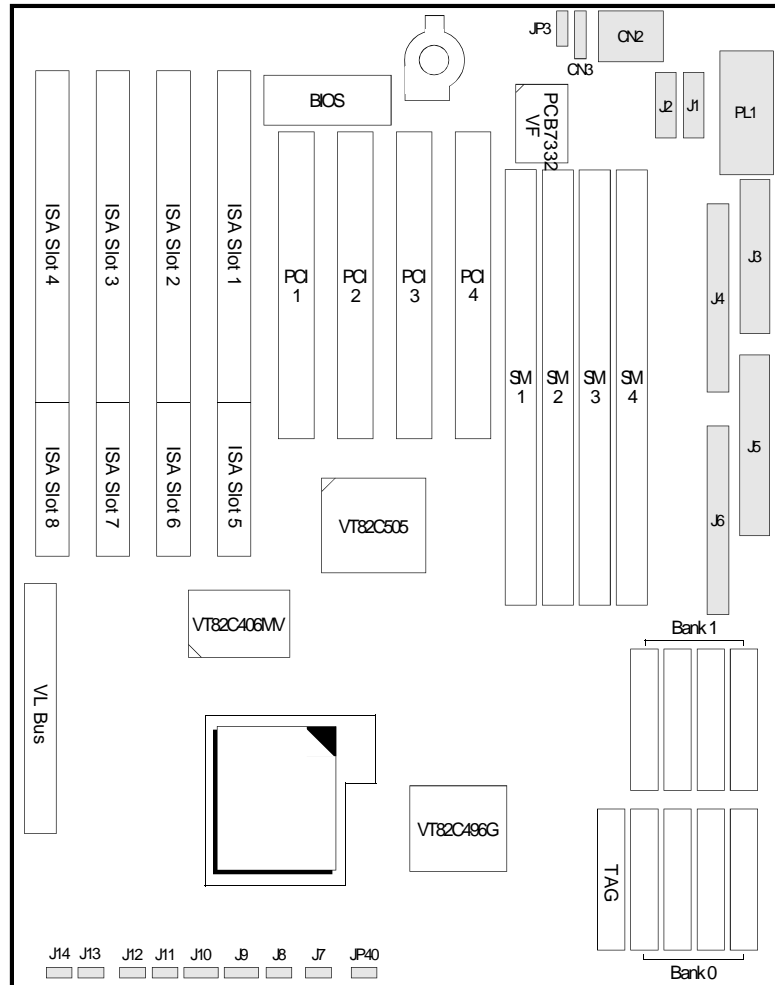

Locations of Connectors on the System Board

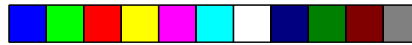

PC/WL-Bus/ISA System Board

Connectors J1 and J2

Primary (COM1) and Secondary (COM2) Serial Ports

Pin	Function
1	DCD (Data Carrier Detect)
2	RX (Receive Data)
3	TX (Transmit Data)
4	DTR (Data Terminal Ready)
5	Ground (Signal Ground)
6	DSR (Data Set Ready)
7	RTS (Request to Send)
8	CTS (Clear to Send)
9	RI (Ring Indicator)

Connector J3

Parallel Printer Port

Pin	Function
1	-Strobe
2	Data 0
3	Data 1
4	Data 2
5	Data 3
6	Data 4
7	Data 5
8	Data 6
9	Data 7

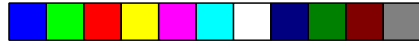

G486VPA

Pin	Function
10	-Ack
11	Busy
12	Paper Empty
13	Select
14	-Autofd
15	-Error
16	-Init
17	-Slctin
18	Ground
19	Ground
20	Ground
21	Ground
22	Ground
23	Ground
24	PNF
25	Ground

Connector J5
Floppy Disk Drive Connector

Pin	Function
1	Ground
2	DENSEL
3	Ground
4	Reserved
5	Ground
6	Drate0
7	Ground
8	Index

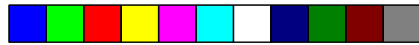

PC/WL-Bus/ISA System Board

Pin	Function
9	Ground
10	MTR0
11	Ground
12	DR1
13	Ground
14	DR0
15	Ground
16	MTR1
17	Drate1
18	Dir
19	Ground
20	Step
21	Ground
22	Write Data
23	Ground
24	Write Gate
25	Ground
26	Track 0
27	MSEN
28	Wr Protect
29	Ground
30	Read Data
31	Ground
32	Head Select
33	Ground
34	Disk Change

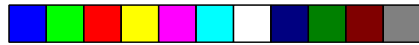

G486VPA

Connectors JP4 and JP6
Primary and Secondary IDE Hard Disk Drive Connectors

Pin	Function
1	-Reset
2	Ground
3	D7
4	D8
5	D6
6	D9
7	D5
8	D10
9	D4
10	D11
11	D3
12	D12
13	D2
14	D13
15	D1
16	D14
17	D0
18	D15
19	Ground
20	Reserved
21	Reserved
22	Ground
23	-OW
24	Ground
25	-IOR

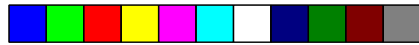

PC/WL-Bus/ISA System Board

Pin	Function
26	Ground
27	IO Channel Ready *
28	BALE
29	Reserved
30	Ground
31	IRQ14
32	IOCS16
33	SA1
34	Reserved
35	SA0
36	SA2
37	HCS0
38	HCS1
39	LED
40	Ground

* Pin 27 is Reserved for Secondary IDE Channel

Connectors J7 and J8 IDE1/IDE2 LED

Pin	Function
1	Signal
2	LED Power

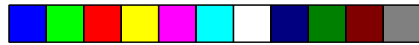

G486VPA

Connector J9
Keylock Connector

Pin	Function
1	LED Signal
2	Reserved
3	Ground
4	Keylock Signal
5	Ground

Connector J10
Speaker Connector

Pin	Function
1	Signal
2	Reserved
3	Ground
4	+5V

Connector JP11
Reset Switch Connector

Pin	Function
1	Ground
2	Reset

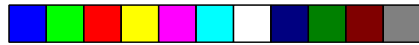

PC/WL-Bus/ISA System Board

Connector J12 Turbo/Green Button Connector

Pin	Function
1	GND
2	Signal

Connector J13 Turbo LED Connector

Pin	Function
1	Signal
2	LED Power

Connector J14 Green LED Connector

Pin	Function
1	Signal
2	LED Power

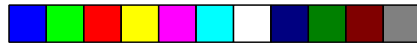

G486VPA

Connector JP3
External Battery Connector

Pin	Function
1	3.6 Lithium Battery
2	Key
3	GND
4	GND

Connector JP40
Green 12V Fan Connector

Pin	Function
1	GND
2	Green +12V

Connector CN2
AT Keyboard Connector

Pin	Function
1	Keyboard Clock
2	Keyboard Data
3	Not Connected
4	Ground
5	+5V

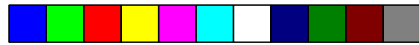

PCI/L-Bus/ISA System Board

PS/2 Keyboard Connector

Pin	Function
1	Mouse Data
2	Reserved
3	Ground
4	+5V
5	Mouse Clock
6	Reserved

Connector CN3

PS/2 Mouse Connector

Pin	Function
1	Mouse Data
2	Reserved
3	Ground
4	+5V
5	Mouse Clock
6	Reserved



G486VPA

Connector PL1
Power Connector

Pin	Function
1	Power Good
2	+5V
3	+12V
4	-12V
5	Ground
6	Ground
7	Ground
8	Ground
9	-5V
10	+5V
11	+5V
12	+5V

❖ Appendix G: Award BIOS Hard Disk Table

Type	Size (MB)	Cylinders	Heads	Sectors	Write Precomp	Land Zone	Example Model
1	10	306	4	17	128	305	TEAC SD510, MMI 112, 5412
2	20	615	4	17	300	615	Seagate ST225, ST4026
3	30	615	6	17	300	615	
4	62	940	8	17	512	940	
5	46	940	6	17	512	940	
6	20	615	4	17	None	615	Seagate ST125, Tandon TM262
7	30	462	8	17	256	511	
8	30	733	5	17	None	733	Tandon TM 703
9	112	900	15	17	None	901	
10	20	820	3	17	None	820	
11	35	855	5	17	None	855	
12	49	855	7	17	None	855	
13	20	306	8	17	128	319	Disctron 526, MMI M125
14	42	733	7	17	None	733	
15				(Reserved)			
16	20	612	4	17	0	663	Microscience HH725, Syquest 3250, 3425
17	40	977	5	17	300	977	
18	56	977	7	17	None	977	
19	59	1024	7	17	512	1023	
20	30	733	5	17	300	732	
21	42	733	7	17	300	732	
22	30	306	5	17	300	733	Seagate ST4038
23	10	977	4	17	0	336	
24	40	1024	5	17	None	976	Seagate ST4051
25	76	1224	9	17	None	1023	Seagate ST4096
26	71	1224	7	17	None	1223	Maxtor 2085
27	111	1224	11	17	None	1223	Maxtor 2140, Priam S14
28	152	1024	15	17	None	1223	Maxtor 2190, Priam S19



G486VPA

Type	Size (MB)	Cylinders	Heads	Sectors	Write Precomp	Land Zone	Example Model
29	68	1024	8	17	None	1023	Maxtor 1085, Micropolis 1325
30	93	918	11	17	None	1023	Maxtor 1105 1120, 4780
31	83	925	11	17	None	1023	Maxtor 1170
32	69	1024	9	17	None	926	CDC 9415
33	85	1024	10	17	None	1023	
34	102	1024	12	17	None	1023	
35	110	1024	13	17	None	1023	
36	119	1024	14	17	None	1023	
37	17	1024	2	17	None	1023	
38	136	1024	16	17	None	1023	
39	114	918	15	17	None	1023	Maxtor 1140, 4380
40	40	820	6	17	None	820	Seagate ST251
41	42	1024	5	17	None	1023	Seagate 4053
42	65	1024	5	26	None	1023	Miniscribe 3053/6053 RLL
43	40	809	6	17	None	852	Miniscribe 3650
44	61	809	6	26	None	852	Miniscribe 3675 RLL
45	100	776	8	33	None	775	Conner CP3104
46	203	684	16	38	None	685	Conner CP3204
User Defined							

Appendix H: System Overview

DMA Channels

DMA Controller 1	DMA Controller 2
Ch0-Reserved for User	Ch4-Cascade for CTRL 1
Ch1-ECP*	Ch5-Reserved for User
Ch2-Diskette	Ch6-Reserved for User
Ch3-Reserved for User	Ch7-Reserved for User

* ECP DMA channel can be changed to Ch3 by using Jumper JP15 (see page 2-15 of the manual).

Note:

*DMA controller 1 supports 8-bit data transfer.
DMA controller 2 supports 16-bit data transfer.*

Address Generation for DMA Channels 3 to 0

Source	DMA Page Memory	DMA Controller 1
Address	A23 < ————— > A16	A15 < ————— > A0

Address Generation for DMA Channels 7 to 5

Source	DMA Page Memory	DMA Controller 2
Address	A23 < ————— > A17	A16 < ————— > A1

Page Memory Address

IO Port Address	Page Memory
0081H	DMA Channel 2
0082H	DMA Channel 3
0083H	DMA Channel 1
0087H	DMA Channel 0
0089H	DMA Channel 6
008AH	DMA Channel 7
008BH	DMA Channel 5

System Interrupts

Interrupt Controller 1	Interrupt Controller 2
IRQ0-Timer Output (Out 0)	IRQ8-Realtime Clock INT
IRQ1-KeyBoard (Output Buffer Full)	IRQ9-Software Redirected to INT 0AH (IRQ2)
IRQ2-Interrupt from INTR2	IRQ10-Reserved
IRQ3-Serial Port 2	IRQ11-Reserved
IRQ4-Serial Port 1	IRQ12-PS/2 Mouse
IRQ5-Parallel Port 2 or 3 (378h/278h) *	IRQ13-Coprocessor
IRQ6-Diskette Controller	IRQ14-Primary Fixed Disk Controller (1F0)
IRQ7-Parallel Port 1 or 2 (3BCh/378h) *	IRQ15-Secondary Fixed Disk Controller (170) / Green IRQ **

* The one on-board parallel port can be configured to either Parallel Port 1, 2 or 3. The Parallel Port 1 uses I/O address 3BCh, Parallel Port 2 I/O address 378h, while Parallel Port 3 uses I/O address 278h.

** If you enable the Green function in the CMOS Setup while using a non-green CPU, it will occupy IRQ15.

Note:

The 16 levels of system interrupts have the following priority: *IRQ0>IRQ1>IRQ8>IRQ9>IRQ10>IRQ11>IRQ12>IRQ13>IRQ14>IRQ15>IRQ3>IRQ4>IRQ5>IRQ6>IRQ7.*

System Timers

Channel 0	System Timer (IRQ0)
Channel 1	Refresh Request Generator (15us Rate Generator Period Signal)
Channel 2	Tone Generation for Speaker

Real-Time Clock

Address	Function	Address	Function	Address	Function
00	Seconds	05	Hour Alarm	0A	Register A
01	Second Alarm	06	Day of Week	0B	Register B
02	Minutes	07	Date of Month	0C	Register C
03	Minute Alarm	08	Month	0D	Register D
04	Hours	09	Year		



PCWL-Bus/ISA System Board —————





————— G486VPA





G486VPA

**Rev. A+
System Board
User's Manual**



- 26460327 -





G486VPA

**Rev. A +
System Board
User's Manual**





G486VPA

**Rev. A +
System Board
User's Manual**

