

1

Introduction

Overveiw

CB656M-WE motherboard integrated Graphics chipset designed for Intel Celeron processor into an Micro-ATX form factor (240x190mm) that combines performance, flexibility, and easy of use into high integrated capable of meeting a variety of price/performance levels.

CB656M-WE motherboard supports not only FSB(Front Side Bus) 66Mhz bus but also FSB 100/133Mhz. Celeron PPGA370 333Mhz~500+Mhz with FSB 66Mhz can be supported for the higher performance level .

Two standard 168-pin unbuffered DIMM Sockets with memory size up to 512MB(using 128Mb DRAM Technology) support Synchronous DRAM modules.

CB656M-WE have GMCH(Graphic Memory Controller Hub). GMCH integrates a 66/100/133Mhz bus controller,integrated 2D/3D graphics accelelator,100Mhz SDRAM controller and a high-speed hub interface for communication with ICH. The ICH integrates an Ultra-ATA/66(ICH) controller,USB host controller,LPC interface controller,PCI interface controller,AC'97 digital controller and a hub interface for communication with the GMCH.

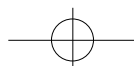

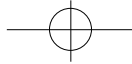
**Caution :**

There is the danger of an explosion if the battery is incorrectly replaced. Replace the battery with the same or equivalent type recommended by the manufacturer. Discard used batteries according to the battery manufacturer's instructions.

Main Features

1. Processor :

- ZIF Socket PPGA370
- Support for INTEL CELERON 333/366/400/433/466/500MHz processor with FSB 66MHz
- Supports future Intel PENTIUM- Processors with FSB 100/133MHz

2. Main Chipsets :

2-1. Graphics Memory Controller Hub (GMCH)

- Support for Intel Celeron/PENTIUM- processors with a 66MHz/100MHz or 133MHz system bus.
- 100MHz SDRAM interface supporting 64MB/256MB with 64Mb/128Mb SDRAM technology
- Support 4MB Display cache
- Hub interface for access to the ICH.

2-2. I/O Controller Hub(ICH)

- PCI 2.2 interface
- Bus master interface
- USB controller
- SMBus controller

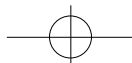

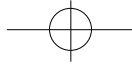

- FWH interface
- LPC interface
- AC'97 2.1 interface
- IRQ Controller

3. system BIOS

- Phoenix bios
- 4MB FWH
- Support PnP, APM, ACPI, DMI2.0 & CD-ROM BOOTING

4. DIMM Memory Socket :

- Provides two 168-pin unbuffered DIMM socket.
- Support to 16/32/64/128/256 MB PC-100 unbuffered Synchronous DRAM (SDRAM) Module.

5. Low Pin Count(LPC) Interface

- The ITE8712 super I/O migrated to the Low Pin Count(LPC) interface
- **Standard I/O Functions**
 - One floppy disk drive connector
 - One SPP/EPP/ECP Compatible Parallel Port
 - Two 16C550 Compatible Serial Port
 - Game port
 - MPU-401 interface

6. Expansion Slots :

- Three 32-bit PCI slots all support PCI master.
 - PCI specification version 2.2 compliant.
- One AMR connector

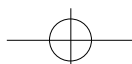

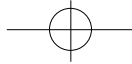

- AC'97 Link for audio and modem CODECs.
- AC'97 2.1 Compliant

7. Input/Output Ports

- **PS/2 Keyboard and PS/2 Mouse Set :**

Provide Double Height PS/2 keyboard & PS/2 mouse connector
Integrated into ITE8712 LPC I/O

- **Serial / Parallel Ports:**

One multi-mode parallel port with chip-protect circuitry supports
standard, enhanced (EPP), high speed (ECP) mode (25-pin D-Sub).

Two high speed 16C550 UART compatible buffer fast serial port (9-pin D-Sub).

- **USB ports**

Fully supports Universal Host Controller Interface (UHCI) and uses UHCI-compatible software drivers.

8. IDE Support:

- Provide two independent bus-mastering PCI IDE interfaces (Primary and Secondary IDE).
- Support PIO Mode 4 transfer (up to 14MB/s) and Ultra DMA/33 (33MB/s) and support up to Ultra DMA/66.
- The BIOS automatically detects the IDE device transfer rate and translation mode.

9. FDD Support:

- Provides 34-pin box header.
- Supports 360K/720K/1.2M/1.44M or 3 mode floppy drives.

10. AUDIO Connector

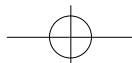



Provide Line-out,Line-in ,Mic-in Jacks

11. Integrated Graphics Controller

Integrated 2D and 3D graphic engine

Integrated Graphics Memory Controller(D.V.M technology)

Integrated hardware motion compensate engine

4MB Display Cache.

12. Power on function

Power button on

Keyboard password power on

Hotkey power on

PC98keyboard Power on

13. Hardware monitoring

- Integrated ITE8712 hardware monitor
- Supports two FAN speed monitoring and voltage monitoring

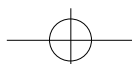

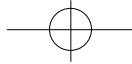

2

Installation

Installation

This chapter provides information on how to install and configure CB656M-WE motherboard.

Check List

The standard packing of CB656M-WE should include:

- CB656M-WE motherboard
- 1 IDE cable (80wire for ATA66)
- 1 Floppy cable
- CB656M-WE User's Manual
- Device driver CD
- 1 Serial cable (option)

Installation Steps

Installing of the CB656M-WE motherboard depends on the type of case you use. The CB656M-WE motherboard is designed for the ATX form factor and must be installed in an ATX chassis.

Before using your computer, you must complete the following steps :

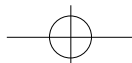



Warning!

Computer motherboards and Add-on cards contain very delicate IC chips. To protect them against damage from static electricity, you should follow some precaution whenever you work on your computer.

1. Unplug your computer when working on the inside.
2. Use a grounded wrist strap before handling computer components. If you do not have one, touch both of your hands to a safely grounded object or to a metal object, such as the power supply case.
3. Hold components by the edges and try not to touch such the IC chips, leads or connectors, or other components.
4. Place components on a grounded anti-static pad or on the bag that came with the component whenever the components are separated from the system.

1. Clear CMOS RAM

The CMOS RAM is powered by the onboard coin-cell battery or power supply. To clear the CMOS Data: (1) Turn off your computer and unplug your AC POWER, (2) Remove the coin cell battery, (3) Close JP2,JP4 pins 2-3, wait five seconds and place the jumper back on pins 1-2. (The jumper must be placed back on pins 1-2 for the system to function properly), (4) Turn on your computer.

2. CLEAR CMOS

JUMPER	JP2	JP4
NORMAL	1-2	1-2
CLEAR	2-3	2-3

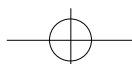

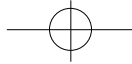

MEMORY VOLTAGE SELECT

Memory voltage is fixed to 3.3V

MEMORY VOLTAGE	JP6
NORMAL	1-2, 3-4 5-6

KEYBOARD VOLTAGE SELECT

Password function is available from setting this jumper.
See detailed information on BIOS setup "Security" menu.

KEYBOARD VOLTAGE	JP34
NORMAL	1-2
PASSWORD FUNCTION	2-3

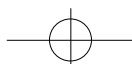

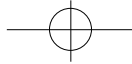

On Board Audio Codec Enable/Disable

On Board Audio Codec	JP5
Enable	2-3
Disable	1-2

Install the System Memory

The CB656M-WE motherboard has two 3.3V unbuffered 64bit, 168-pin DIMM sockets for up to 512MB(using 128Mb DRAM Technology) of SDRAM memory module.

1. Adding Memory

The following is a list of rules to follow when installing DIMMs. If you follow these rules, your upgrade should be trouble-free.

Caution : Use Only PC-100 SDRAM Module
Unplug the power cord from the wall when installing memory

2. Memory Configuration

The following table lists a number of possible memory configurations.

DIMM		TOTAL
DIMM1	DIMM2	
8MB	8MB	DIMM1+DIMM2 The combination of memory size is from 8 MB to maximum 256MB.
16MB	16MB	
32MB	32MB	
64MB	64MB	
128MB	128MB	

Table 2-2. CB656M-WE Memory Configurations

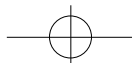

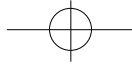

3. Install and Remove DIMMs

To install the DIMMs, locate the memory banks on the motherboard and perform the following steps:

1. Hold the DIMM so that notched edge is aligned with the notch on the DIMM socket (Figure 2-1).
2. Insert the DIMM at a 90 degree angle.
3. Gently push the DIMM straight down until it locks into place (past the release tabs).



Figure 2-1 Installing a 168-pin DIMM

To remove DIMMs, follow the steps below:

1. With both thumbs (or fingers), press the release tabs away from the socket.
2. With the DIMM free from the release tabs, lift the memory module up and place in the anti-static bag or package.

Installing the CPU

The CB656M-WE is designed to support Intel Celeron CPU.

1. Installing a CPU

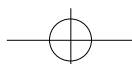

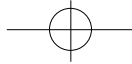

To install processor, check the direction of CPU and ZIF socket, lift the lever up to the top, put the CPU onto the socket, and lay down the lever of socket and then lock the lever of socket.

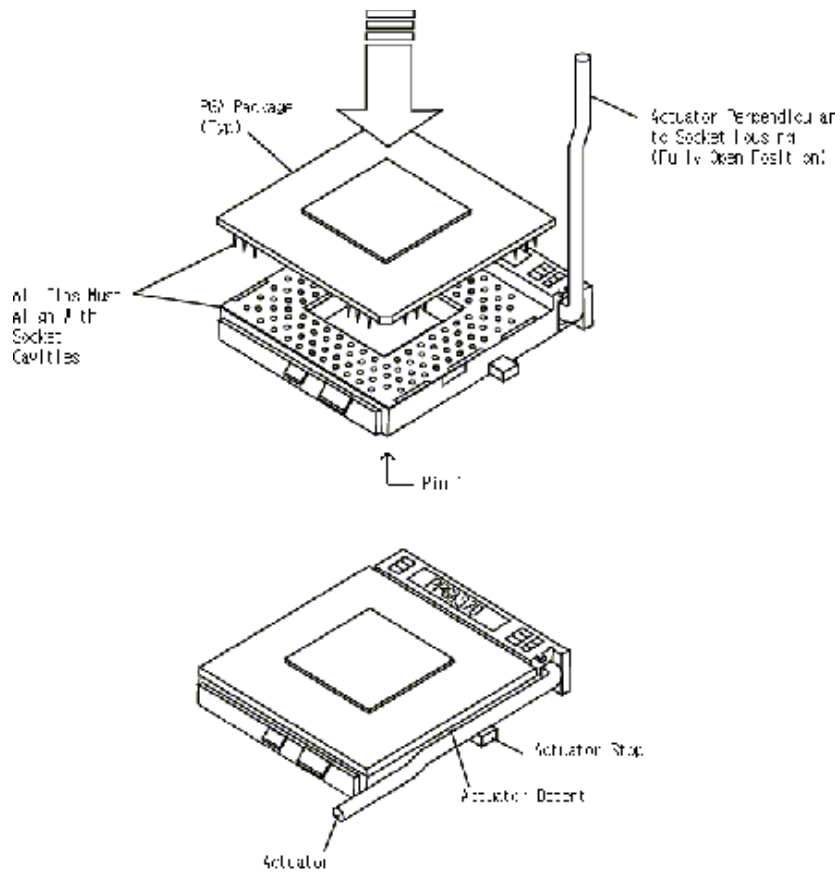

Install the CPU

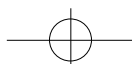



Connect Cables

1. CPU Fan connector (J31)

This connector supply the power for the CPU cooling fan cable (3-pin).

PIN	Signal Name
1	Control
2	+12V
3	Sense

2. Primary / Secondary IDE connectors (J6/J7)

The Primary connectors support the provided 80 pin ribbon cable for ATA-66 device, and Secondary connector also supports ATA-66 device. After connecting the single end to the motherboard, connect the two plugs at the other end to your hard disk drive(s).

3. FDD connector (J13)

This connector supports the provided 34-pin ribbon cable. After connecting the single end to the motherboard, connect the two plugs on the other end to the floppy drives.

4. IR connectors (J33)

CB656M-WE provide connectors which can support Standard IrDA (InfraRed Data Association) receiver module. It gives users IR wireless data exchange directly from mobile computers, printers and PDAs, ...etc.

5. Wake On LAN Connector (J2)

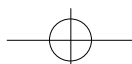

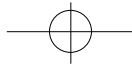

This connector supports Wake On LAN function. If you use Wake On LAN function ,connect 3-pin cable between this connector and your LAN Card.

PIN	Signal Name
1	+5V Standby
2	Ground
3	WOL

6. Front Panel Switch connector (J27)

This connector supports the signals of the Power LED, HDD LED, Reset Switch, Internal Speaker and Key Lock.

12

22

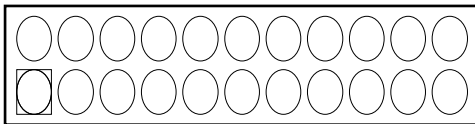

1

11

Pin number	Description	Pin number	Description
Pin 1	Power	Pin 12	Power
Pin 2	GND	Pin 13	N.C
Pin 3	Green LED	Pin 14	GND
Pin 4	Power Button	Pin 15	Keylock
Pin 5	GND	Pin 16	GND
Pin 6	GREEN LED	Pin 17	N.C
Pin 7	GND	Pin 18	N.C
Pin 8	POWER	Pin 19	VCC
Pin 9	HDD LED	Pin 20	GND
Pin 10	GND	Pin 21	GND
Pin 11	H/W RESET	Pin 22	SPEAKER

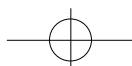

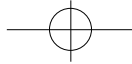

7. Power Switch connector (J29)

This connector is used to provide a way of the user to turn the system on. Connect it to the power on push button on the front panel.

<Note>

In order to prevent the system from shut down by mistake, the CB656M-WE motherboard provides one optional item of the BIOS setup (refer to “Power Setup”).

This item is called “Power Button over ride”. The function is as follows:

Enabled:

1. Pushing the button one time will change the system from Normal operation mode to Suspend mode. Pushing the button again will wake up the system.
2. Pushing the power button more than 4 seconds will shut down the system.

Disabled:

Pushing the power button one time will turn the system on, pushing again will turn the system off.

8. ATX Power Supply Connector (J25)

This connector connects to an ATX power supply. The plug from the power supply will only insert in one orientation because of the different hole-size. Find the proper orientation and push down firmly but gently making sure that the pins aligned.

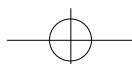

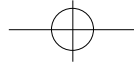

External Connectors

1. PS/2 Keyboard & Mouse Connector (J12)

The CB656M-WE provides one PS/2 keyboard and one PS/2 mouse connector. Refer to the Figure 2-2 for the direction of keyboard (mouse) cable to install on keyboard (mouse) connector.

2. Serial Port COM1 and COM2 (J10 & J11)

The CB656M-WE provides two sets of high speed serial port. Each serial port is 16550 UART compatible. One is 9 pin D-sub connector and the other is 10 pin header for optional serial port cable.

3. Parallel Port Printer Connector (J9)

The CB656M-WE provides one set of high speed parallel port. The parallel port can support bi-direction / EPP / ECP mode.

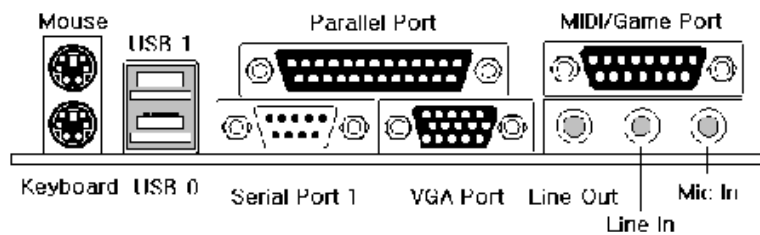
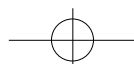
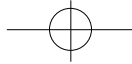

Figure 2-2 External connectors





4.VGA PORT

The CB656M-WE Provides VGA port which can support a DDC monitor .

5.Universal Serial Bus(USB) Connector

The CB656M-WE provides stacked USB Ports.

6. Audio Jacks

The CB656M-WE supports AC97 2.1 Audio.

It provides Line-out,Line-in,Mic jacks and MIDI/Game port.

Driver Installation

The INF Files for Intel(r) 810 Chipsets contain Windows® device installation (*.INF) files that outline to the operating system how the chipset components shall be configured for proper functionality of the following features:

- Core PCI and ISAPNP Services
- AGP Support
- IDE/ATA33/ATA66 Storage Support
- USB Support
- Identification of Intel Chipset Components in Device Manager

Files for Windows 98 operating system and files for Windows 95 operating system are included in this software package.

The system integrator can than install these files prior to Windows 95 or Windows 98 OS Installation.

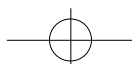

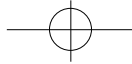

The files for Windows 95 are designed to work solely with Windows 95 (all versions). The files for Windows 98 are designed to work solely with Windows 98.

1.INSTALLING THE INF FILES From Driver CD

1. Check the System Requirements. Windows 95 or Windows 98 must be fully installed and running on the system prior to running this software.
2. Close any running applications. You may experience some difficulties if you don't do this.
3. Insert the CD-ROM into the drive and enter the "inf" directory.
4. Run the InstallShield installation program, SETUP.EXE.
5. You will be prompted to agree to the license agreement. If you do not agree, the Installer will exit prior to extracting any files.
6. The INF files will be copied to the target directory C:\Program Files\Intel\IntelINF by default. If desired, change the target directory by selecting 'Browse.' This directory will henceforth be referred to as <INF Installation Directory>
7. The INF files are now contained within two subdirectories under the <INF Installation Directory>: \Win98 and \Win95.

2.INSTALLING THE INF UPDATE Utility

1. Check the System Requirements. Windows 95 or Windows 98 must be fully installed and running on the system prior to running this software.

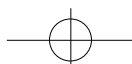

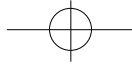

2. Close any running applications. You may experience some difficulties if other applications are still running.
3. Enter the directory “Infinst” and Run Setup.EXE.
4. You will be prompted to agree to the license agreement. If you do not agree, the Installer will exit prior to extracting any files.
5. The README.TXT file will be copied to the directory C:\Program Files\Intel\Infinst by default. If desired, change the target directory by selecting ‘Browse.’ This directory will henceforth be referred to as <INF Installation Directory>
6. Follow the screen instructions and use default settings to complete the setup once the operating system has rebooted.
7. At this point, the installation of the INF Update Utility for Intel(r) Chipsets is complete.

3.INSTALLING THE VGA DRIVER FROM CD-ROM

1. Select “My Computer” icon, “Control Panel” icon, and then the “Display” icon.
2. You should now be in the “Display Properties” window. Select the “Settings” tab, and click on the “Advanced Properties” button.
3. In the “Advanced Display Properties” window, select the “Adapter” tab, and click the “Change...” button.
4. The “Update Device Driver Wizard” window appears. Click on the “Next” button to continue.

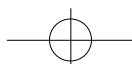

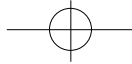

5. A new window appears, prompting either for Windows® to search for a device driver or to select one manually. Click the option for “Display a list of all the driver in a specific location, so you can select the driver you want.” After this, click on the “Next” button.
6. From the new window, click on the “Have Disk” button and then the “browse” button.
7. Enter the directory “VGA” and then enter the “Graphics” subdirectory. Next enter the “Win9X” subdirectory. If you wish to install the English version of the driver simply click “OK” (you should see the I81xw9x.inf file highlighted). If you wish to install a localized driver file, next enter the “Inf” subdirectory (from the “Graphics” subdirectory) and then enter the directory for the language you wish to install (see language abbreviation section 2) At this point you should see the i81xw9x.inf file highlighted, click “OK”.
8. Click “OK”. The select Device screen should open, and may have intel(R) 810e Chipset Graphics Driver(DC133 FSB133). Click “OK”.
9. Click “Next”. Driver should install. Click “Finish” when done.
10. Close all open windows and click “Yes” to reboot. The driver should now be loaded. To determine if the driver have been loaded correctly, Refer to the “Verifying Installation” section, below.

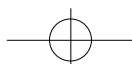



4.AC97 Audio WDM Driver Installation

1. Click on Start
2. Select settings
3. Select Control Panel
4. Double click on System icon
5. Click on device manager tab
6. Click on View devices by Type button
7. Click on "PCI Multimedia device."
8. Click on Remove
9. Click on Refresh
10. Windows98 will launch the Add New Hardware Wizard. This wizard searches for new drivers for PCI Multimedia Device. Select next.
11. Ensure that the following choice is selected:Search for the matching driver for your device.(recommended)
12. Select next
13. Windows98 will list locations from where the updated driver file can be found. Ensure that the following choice is selected:Specify a location
14. In the specify a location dialog box, specify the path "Audio"

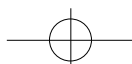

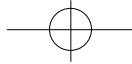

15. Select Next

16. Windows 98 should display that the following driver has been found:
82801AA/AB AC'97 Audio Controller

17. Select Next

18. Select Finish

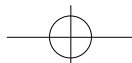

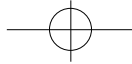

3 Setup

The SETUP program is a built-in program that allows configuration of functions and devices of the system.

This chapter provides information on how the setup program allows you to configure the function and device of your computer and how to configure each item on the setup menus.

■ Changing/Saving SETUP

1. SETUP can be invoked when the power is turned on or software reset is initiated. During the initial boot sequence, Press <F2> will display the setup main screen.

2. From the initial SETUP menu, use arrow key(Right or Left) to display the next or previous menu.

There are six SETUP menus and they are :

- Main
- Advanced
- Security
- Power
- Boot
- Exit

3. To select an option entry, press arrow key (Up or Down). As the cursor moves through the menu, the current option is highlighted.

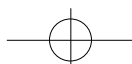



4. <+>, <-> and the space bar will scroll the current field's value.
5. To change a value of configuration, repeat the procedure 2 through 4.
6. If you press <ESC>, the Exit menu will be displayed.
Save your changes to CMOS and exit system Setup.

■ **Reconfiguring SETUP with Default Values**

1. During boot-up sequence, press <F2> to display the SETUP menu.
2. Press <ESC> to go to the 'Exit' menu.
3. On the "Load Setup Defaults" option, press <Enter> and select <Yes>.
4. Select the "Exit Saving Changes" to save the default values and exit SETUP.

■ **Next sections provide explanation of the SETUP configurations.**

1. MAIN Setup Menu

To start Phoenix BIOS Setup utility :

1. Turn on or reboot your system. Phoenix BIOS displays this message :

Press <F2> to enter SETUP.

2. Pressing <F2> displays the Main Menu, which looks like this :

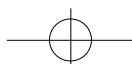

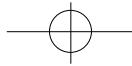

Phoenix BIOS Setup Utility					
Main	Advanced	Security	Power	Boot	Exit
System Time : [12:00:13] System Date : [01/01/1998] Legacy Diskette A : [1.44/1.25 MB 3½"] Legacy Diskette B : [Disabled] ▶ Primary Master [1755MB] ▶ Primary Slave [3229MB] ▶ Secondary Master [CD-ROM] ▶ Secondary Slave [None] ▶ Keyboard Features System Memory : 640KB Extended Memory : 30720 KB					Item Specific Help <Tab>, <Shift-Tab>, or <Enter> selects field.
F1	Help	↑↓	Select Item	-/+	Change Values
F9	Setup Defaults				
Esc	Exit	←→	Select Menu	Enter	Select ▶ Sub-Menu
F10	Save and Exit				

<Figure1> Main Screen

Use this menu for basic system configuration.

You can make the following selections on the Main Menu itself.

-System Time

This option displays the current system time.

Use <+> and <-> keys to change the values.

Press <Enter> to move from the Hour to the Minute to the second field.

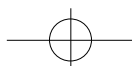

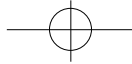

-System Date

This option displays the current system date.

Use <+> and <-> keys to change the values.

Press <Enter> to move from the Month to the Date to the Year field.

-Legacy Diskette A : / Legacy Diskette B :

These options define whether to use the 'A' drive/'B' drive and set the type of floppy disk drive installed in each drive.

-Primary Master/Slave, Secondary Master/Slave

The Master and Slave settings on the Main Menu control the types of devices:

- Hard-disk drives
- Removable- disk drives
- CD-ROM drives

The setting is defined to 'Auto' to automatically select the hard disk parameters and the protocol at the time of boot-up. The user can define its own parameter by selecting the 'User' value.

If you press <Enter>, the screen displaying data for each device will appear.

-Keyboard Features

Specify Keyboard Features as Following :

- Num Lock : On or Off turns NumLock on or off at bootup. Auto turns NumLock on if it finds a numeric key pad.
- Key Click : Turns audible key click on.
- Keyboard auto-repeat rate : Sets the number of times a second to repeat a keystroke when you hold the key down.
- Keyboard auto-repeat delay : Set the delay time after the key is held down before it begins to repeat the keystroke.
- Legacy USB Support:Enable/Disable for Legacy Universal Serial Bus.

-System Memory

Displays the amount of conventional system memory detected during bootup.

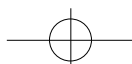

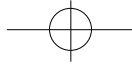

-Extended Memory

Displays the amount of extended system memory detected during bootup.

2. Advanced Setup Menu

Use this menu to set the Advanced Features available on your system's chipset.

Selecting "Advanced" from the Menu Bar displays the Advanced Menu, which looks like this :

PhoenixBIOS Setup Utility					
Main	Advanced	Security	Power	Boot	Exit
<p style="text-align: center;">Setup Warning</p> <p>Setting items on this menu to incorrect values may cause your system to malfunction.</p> <p>Processor Serial Number : [Enabled]</p> <p>Installed O/S : [Win 98 / Win 2000]</p> <p>Reset Configuration Data : [No]</p> <p>PS/2 Mouse [Auto Detect]</p> <p>Secured Setup Configurations [No]</p> <p>Large Disk Access Mode : [DOS]</p> <p>Local Bus IDE adapter : [Both]</p> <p>Spread Spectrum [Enabled]</p> <p>▶ I/O Device Configuration</p> <p>▶ Advanced Chipset Control</p>				<p style="text-align: center;">Item Specific Help</p> <p>Select the operating system installed on your system which you will use most commonly.</p> <p>Note : An incorrect setting can cause some operating systems to display unexpected behavior.</p>	
F1	Help	↑↓	Select Item	-/+	Change Values
Esc	Exit	←→	Select Menu	Enter	Select ▶Sub-Menu
			F9	Setup Defaults	
			F10	Save and Exit	

<Figure 2> Advanced Screen

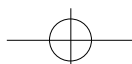

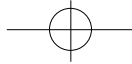
**-Processor Serial Number**

Controls detection of processor Serial Number.

(Note : This option would show only if there is pentium processor in your system.)

-Installed O/S

Select the operating system installed on your system which you will use most commonly.

(Note : An incorrecting setting can cause some operating systems to display unexpected behavior.)

-Reset Configuration Data

To reset PnP data, set the value to 'Yes'. 'Yes' erase all configuration data in ESCD, which stores the configuration settings for non-PnP plug-in devices. Select 'Yes' when required to restore the manufacture's defaults.

-PS/2 Mouse

This is to 'Enable' or to 'Disable' PS/2 Mouse functions.

'Auto Detect' will enable the PS/2 mouse only if present.

-Secured Setup Configurations

'Yes' prevents the Operating System from overriding selections you have made in setup.

-Large Disk Access Mode

Select 'DOS' if you have DOS.

Select 'Other' if you have another operating system such as UNIX.

A large disk is one that has more than 1024 cylinders, more than 16 heads, or more than 63 tracks per sector.

-Local Bus IDE adapter

Enable the integrated local bus IDE adapter.

Specifies an option from below.

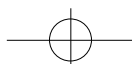



- Disabled : Disable the Local Bus IDE adapter.
- Primary : Use only the primary Local Bus IDE.
- Secondary : Use only the Secondary Local Bus IDE.
- Both : Use both Local Bus IDE adapters.

-Spread Spectrum

When this item is Enabled, the EMI noise can be extremely minimized.

-I/O Device Configuration.

This item allows you to configure I/O device as following.

- Serial port A/ Serial port B : Assign a port address to each serial port.
- Parallel Port : Assign a port address to the parallel port.
- Floppy disk Controller : Enable/Disable the Floppy disk controller.
- MIDI port : Configure MIDI port.
- Game port : Configure Game port.

-Advanced Chipset Control

• Video boot type : This item is to select whether the onboard video controller as the boot display device or not.

If you want to disable onboard video controller, Select "Disable Onboard Video".

Then no system memory will be allocated for video.

• Enable memory Hole : If enabled, turn system RAM off to free address space for use with an option card.

Either a 16KB conventional CD hole, starting at 880KB(DC000h), or a 1MB extended memory gap, starting at 15MB, will be created in system RAM.

- Frequently Ratio : Select the internal frequency multiplier of the CPU.

3. Security Setup Menu

Use this menu to set User and Supervisor Password and Backup and Virus check reminder.

Selecting "Security" from the Menu Bar displays the Security menu, which looks like this :

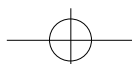

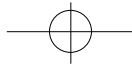

PhoenixBIOS Setup Utility																	
Main	Advanced	Security	Power	Boot	Exit												
Supervisor Password Is : Clear User Password Is : Clear Set Supervisor Password [Enter] Set User Password [Enter] Password on boot : [Disabled] Diskette access : [Supervisor] Fixed disk boot sector : [Normal] Virus check reminder : [Disabled] System backup reminder : [Disabled] ► Power Supply Control					Item Specific Help Supervisor Password controls access to the setup utility.												
					<table style="width: 100%; border: none;"> <tr> <td style="width: 15%;">F1</td> <td style="width: 15%;">Help</td> <td style="width: 15%;">↑↓ Select Item</td> <td style="width: 15%;">-/+ Change Values</td> <td style="width: 15%;">F9 Setup Defaults</td> <td style="width: 15%;"></td> </tr> <tr> <td>Esc</td> <td>Exit</td> <td>←→ Select Menu</td> <td>Enter Select ►Sub-Menu</td> <td>F10 Save and Exit</td> <td></td> </tr> </table>						F1	Help	↑↓ Select Item	-/+ Change Values	F9 Setup Defaults		Esc
F1	Help	↑↓ Select Item	-/+ Change Values	F9 Setup Defaults													
Esc	Exit	←→ Select Menu	Enter Select ►Sub-Menu	F10 Save and Exit													

<Figure 3> Security Screen

-Supervisor Password Is : /User Password Is :
 These items show the states of the Supervisor and User Password.

-Set Supervisor Password
 Set a Supervisor Password.
 To clear the current password, just hit <Enter> on New Password and confirm Password.

-Set User Password
 Can set a User Password only when a supervisor password is set up.

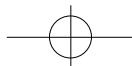

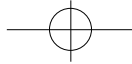

To clear the current password, just hit <Enter> on New Password and confirm Password. (Maximum five characters can be used for a password.)

-Password on boot

If 'Enabled', entry of the password is required to boot up system.

-Diskette access

This item allow you to control access to diskette drives.

If supervisor password is 'Enabled', access to the FDD is limited to the supervisor.

-Fixed disk boot sector

If 'Write protect' is set for this option, the boot sector of the hard disk is write-protected to against viruses.

(This must be set to 'Normal' to transmit system files of the hard disk or to format the hard disk.)

-Virus check reminder

If 'Daily', 'Weekely', or 'Monthly' is selected, the system prompts the user with reminder for virus check at respective intervals.

-System backup reminder

If 'Daily', 'Weekely', or 'Monthly' is selected, the system prompts the user with reminder for system backup at boot-up.

-Power Supply Control

This item allows you to select a method to power on by keyboard.

(Note : USB keyboards can not be used to power on.)

Disable : Disable the keyboard power on.

PC 98-KBD : It allows you to power on the system by the PC98 keyboard's Power Button.

Hot-Key:It allows you to power on the system by the Hot-key.

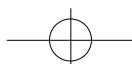



(Ctrl + F1/Ctrl + F2/Ctrl + F3/Ctrl + F4)

Password : It allows you to power on the system by the password that you entered.

4.Power Setup Menu

Use this menu to configure Power-Management features.

Selecting "Power" from the Menu Bar displays the Power menu which looks like this :

PhoenixBIOS Setup Utility								
Main	Advanced	Security	Power	Boot	Exit			
					Item Specific Help			
PowerButton Override :		[Enabled]		<Enabled> : Use PowerButton as the Suspend/Resume Button and support 4sec Power Override. <Disabled> :Use PowerButton as the Soft Off Button.				
Power Savings :		[Disabled]						
Standby Timeout :		[Off]						
Auto Suspend Timeout:		[Off]						
Resume On Time :		[Off]						
Resume Time :		[00 : 00 : 00]						
Resume On Modem Ring :		[Off]						
F1	Help	↑↓	Select Item	-/+	Change Values	F9	Setup Defaults	
Esc	Exit	←→	Select Menu	Enter	Select▶	Sub-Menu	F10	Save and Exit

<Figure 4> Power Screen

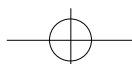

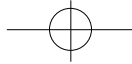
**-PowerButton Override**

Specify power button option as Following :

Enabled : Use Power Button as the Suspend/Resume Button and Support 4sec Power override.

Disabled : Use Power Button as Softoff Button.

-Power Savings

Specify Power Savings option as following:

- **Maximum Power Saving : Conserves the greatest amount of system power. (Standby Timeout : 1 Minute, Auto Suspend Timeout : 5Minutes)**
- **Maximum Performance : Conserves power but allows greatest system performance.**

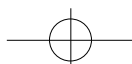

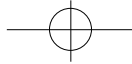

(Standby Timeout : 16 Minutes, Auto Suspend Timeout : 60Minutes)

- Disabled : Turn off Power Management.
- Customized : Can define the 'Standby Timeout' and 'Auto Suspend Timeout'.

-Standby Timeout

Define the 'Standby Timeout'.

-Auto Suspend Timeout

Define the 'Auto Suspend Timeout'.

-Resume On Time

According to the pre-set, the system recovers from the Suspend mode.
Enabled wakes the system up at a specific time.

-Resume Time

Define the 'Resume Time' when 'Resume On Time' is set to 'On'.

-Resume On Modem Ring

Enabled wakes the system up when an incoming call is detected on your modem.

5. Boot Setup Menu

Use this menu to specify any drive as a boot drive.

Selecting "Boot" from the Menu Bar displays the Boot menu, which looks like this :

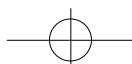

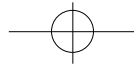

PhoenixBIOS Setup Utility					
Main	Advanced	Security	Power	Boot	Exit
<ol style="list-style-type: none"> 1. [Removable Devices] 2. [Hard Drive] 3. [ATAPI CD-ROM Drive] 4. [Network Boot] <p>▶ Hard Drive</p> <p>▶ Removable Devices</p> <p>QuickBoot Mode: [Enabled]</p> <p>Summary screen: [Enabled]</p>				<p>Item specific Help</p> <p>Use <↑> or <↓> to select a device, then press <+> to move it up the list, or <-> to move it down the list. Press <Esc> to exit this menu.</p>	
				<p>F1 Help ↑↓ Select Item -/+ Change Values F9 Setup Defaults</p> <p>Esc Exit ←→ Select Menu Enter Select▶Sub-Menu F10 Save and Exit</p>	

<Figure 5> Boot Screen

-1/2/3/4

You can arrange the Boot Order List at the top of this menu to specify the order of the devices from which the BIOS will attempt to boot the Operating System. To move a device, first select it with up-or-down arrow keys, and move it up or down using the <+> and <-> keys.

Note : If you have more than one hard drive, or more than one removable devices, use the sub menus to specify which one to use on the boot order list, as described in the following.

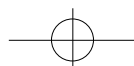

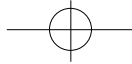

-Hard Drive

If you have more than one hard drive, selecting “Hard Drive” from the Boot Menu. Select the hard to use for booting by using the up-and-down arrows. Then move it to the top of this list using the<+> key.

-Removable Devices

If you have more than one removable device, selecting “Removable Devices” from the Boot Menu. Select the removable device to use for booting by using the up-and-down arrows.

Then move it to the top of this list using the<+> key.

-QuickBoot Mode

By skipping a few tests for booting, Quick Boot mode reduces system booting time.

-Summary screen

Display system configuration on boot.

6. Exit Setup Menu

Exits the current menu.

Selecting “Exit” from the Menu Bar displays the Exit menu, which looks like this :

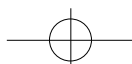



PhoenixBIOS Setup Utility					
Main	Advanced	Security	Power	Boot	Exit
Exit Saving Changes Exit Discarding Changes Load Setup Defaults Discard Changes Save Changes					Item specific Help Exit System Setup and save your changes to CMOS.
F1	Help	↑↓	Select Item	-/+	Change Values
F9	Setup Defaults				
Esc	Exit	←→	Select Menu	Enter	Execute Command
F10	Save and Exit				

<Figure 6> Exit Screen

- Exit Saving Changes
Save current values and exit the SETUP program.
- Exit Discarding Changes
Ignore the changes and exit SETUP program.
- Load Setup Defaults
Assign default values to configuration fields.
- Discard Changes
Ignore the change.
- Save Changes
Save current values to CMOS.

