

# M7VIB

---

## Federal Communications Commission (F.C.C) Statement

This device complies with Part 15 of the FCC Rules. Operation of this device is subject to the following two conditions: (1) this device may not cause harmful interference, and (2) this device must accept any interference received, including interference that may cause undesired operation.

Accessories: This device has been tested and found to comply with the limits of a Class B digital device, the accessories associated with this equipment are as follows:

1. Shielded serial cable. (Can be obtained from multiple retail outlets)
2. Shielded printer cable. (Can be obtained from multiple retail outlets)
3. Shielded video cable. (Can be obtained from multiple retail outlets)
4. Shielded power cord. (Provided by manufacturer)

These accessories are required to ensure compliance with FCC Rules. It is the responsibility of the user to provide and use these accessories properly.

This equipment has been tested and found to comply with the limits of a Class B digital device, pursuant to Part 15 of the FCC Rules. These limits are designed to provide reasonable protection against harmful interference in a residential installation. This equipment generates, uses and can radiate radio frequency energy and, if not installed and used in accordance with the instructions, may cause harmful interference to radio communications. There is no guarantee that interference will not occur in a particular installation. If this equipment does cause harmful interference to radio or television reception, which can be determined by turning the equipment off and on, you are encouraged to try to correct the interference by one or more of the following measures:

1. Reorient / relocate the receiving antenna.
2. Increase the separation between the equipment and receiver.
3. Connect the equipment into an outlet on a circuit different from that to which the receiver is connected.
4. Consult the dealer or an experienced radio/TV technician for help.

Caution: Changes or modifications not expressly approved by the manufacturer could void the user's authority to operate the equipment.

## Disclaimer

The vendor makes no representations or warranties with respect to the contents here of and specially disclaims any implied warranties of merchantability or fitness for any purpose. Further the vendor reserves the right to revise this publication

---

---

and to make changes to the contents here of without obligation to notify any party beforehand.

Duplication of this publication, in part or in whole, is not allowed without first obtaining the vendor's approval in writing.

## **Trademarks and Remarks**

MS-DOS, Windows, Windows NT, Windows 9X, Windows ME and Windows 2000 are products of Microsoft Corp, with its ownership of trademark, and are distributed by the vendor under a license agreement.

All trademarks used in this manual are the property of their respective owners.

Copyright© 2001

All Rights Reserved

## **Canadian D.O.C. Statement**

This digital apparatus does not exceed the Class B limits for radio noise emissions from digital apparatus as set out in the radio interference regulations of the Canadian Department of Communications.

Cet appareil numérique n'émet pas de bruits radioélectriques dépassant les limites appliquées aux appareils numériques de Class B prescrits dans le règlement du brouillage radioélectrique edict par le minister Des Communications du Canada.

---

## **Contents**

---

<b>Introduction .....</b>	<b>1-1</b>
<b>1. Motherboard Description .....</b>	<b>1-2</b>
1.1 Features .....	1-2
1.1.1 Hardware.....	1-2
1.1.2 BIOS .....	1-5
1.1.3 Software.....	1-5
1.1.4 Accessories .....	1-5
1.2 Motherboard Installation.....	1-6
1.2.1 System Block Diagram.....	1-6
1.2.2 Layout of Motherboard.....	1-7
1.2.3 Quick Reference.....	1-8
1.3 CPU Installation.....	1-9
1.3.1 CPU Installation Procedure: Socket A .....	1-9
1.3.2 Frequency Selection: JCLK1 .....	1-10
1.3.3 CPU Fan Header: JCFAN1 .....	1-10
1.3.4 System Fan Header: JSFAN1 .....	1-11
1.3.5 North Bridge Chipset Fan Header: JNFAN1 .....	1-11
1.4 RAM Module Installation .....	1-12
1.4.1 DIMM.....	1-12
1.4.2 How to install a DIMM Module .....	1-13
1.5 Slots .....	1-14
1.5.1 ACR (Advanced Communication Riser) Slot .....	1-15
1.5.2 AGP (Accelerated Graphics Port) Slot.....	1-15

## Contents

---

1.5.3 CNR (Communication Network Riser) Slot.....	1-15
1.5.4 PCI (Peripheral Component Interconnect) Slots.....	1-15
1.6 Connectors, Headers & Jumpers .....	1-16
1.6.1 Front Panel Connector: JPANEL1 .....	1-17
1.6.2 ATX 20-pin Power Connector: JATXPWR1.....	1-19
1.6.3 Hard Disk Connectors: IDE1/IDE2.....	1-19
1.6.4 Floppy Disk Connector: FDD1.....	1-20
1.6.5 Wake On LAN Header: JWOL1 .....	1-20
1.6.6 Clear CMOS Jumper: JCMOS1 .....	1-20
1.6.7 Front USB Headers: JUSB2/JUSB3 .....	1-21
1.6.8 CNR Code Primary/Secondary Selection: J2 .....	1-21
1.6.9 DDR DIMM Voltage: J9.....	1-22
1.7 Peripheral Port.....	1-23
1.7.1 PS/2 Mouse / Keyboard Connector: JKBMS1 .....	1-23
1.7.2 USB Connector: JUSB1 .....	1-24
1.7.3 Serial and Parallel Interface Ports.....	1-25
1.7.3.1 The Serial Interface: JCOM1/ JCOM2 .....	1-25
1.7.3.2 Parallel Interface Port: JPRNT1 .....	1-27
1.7.4 Game (Joystick/MIDI) Port Connector: J8 .....	1-28
1.7.5 Audio Port Connectors: JSPKR1/JLIN1/JMIC1.....	1-28
1.7.6 Audio Subsystem .....	1-29
1.7.6.1 CD-ROM Audio-In Header: JCDIN1.....	1-30
1.7.6.2 CD-ROM Audio-In Header: JCDIN2.....	1-30
1.7.6.3 Front Panel Audio Header: JAUDIO1.....	1-30

## **Contents**

---

1.7.6.4 Telephony Audio Header: JTAD1.....	1-30
<b>2. BIOS Setup.....</b>	<b>2-1</b>
2.1 Main Menu.....	2-3
2.2 Standard CMOS Features.....	2-6
2.3 Advanced BIOS Features.....	2-9
2.4 Advanced Chipset Features.....	2-13
2.5 Integrated Peripherals .....	2-17
2.6 Power Management Setup.....	2-22
2.7 PnP/PCI Configurations.....	2-27
2.8 PC Health Status .....	2-30
2.9 Frequency/Voltage Control.....	2-31
<b>3. Trouble Shooting.....</b>	<b>3-1</b>

## **Introduction**

### **System Overview**

Congratulations on the purchase of your new system! This motherboard is designed to take advantage of the latest industry technology to provide you with the ultimate solution in data processing. In the tradition of its predecessors, this motherboard continues a commitment to reliability and performance and strives for full compliance and compatibility with industry software and hardware standards.

### **M7VIB Highlights:**

- ▶ □ Contains on board I/O facilities which include two serial ports, a parallel port, a PS/2 mouse port, a PS/2 keyboard port, audio ports, USB ports and a game port.
- ▶ □ Contains on board IDE facilities for IDE devices such as hard disks and CD-ROM Drives.
- ▶ □ Supports the AMD-Athlon™ processor, a leading edge processor which brings to you the latest technology in microarchitecture design, graphics performance, system bus design, cache architecture and much more.
- ▶ □ Complies with PC ATX form factor specifications.
- ▶ □ Supports popular operating systems such as Windows 95/98, Windows NT, Windows 2000, Windows ME, Novell, UNIX, LINUX and SCO UNIX.

# 1. Motherboard Description

## 1.1 Features

### 1.1.1 Hardware

#### CPU

- Single Socket-A for an AMD Athlon Family processor.
- Running at 100 or 133 MHz Front Side Bus frequency.
- The AMD Athlon system bus supports the 200/266 MHz high-speed, split-transaction AMD Athlon system bus interface.

#### Speed

- Supports from 500MHz to 1.4GHz CPU core speeds.
- The 33MHz 32 bit PCI 2.2 compliant.
- The 66MHz AGP 2.0 compliant interface supports 1x, 2x and 4x data transfer mode.
- High-speed memory --The VT8366 system controller is designed to support 200/266 MHz DDR SDRAM DIMMs.

#### Chipset

- Chipset – VIA VT8366/ VT8233.
- Chipset – Winbond W83697HF.

#### DRAM Memory

- Supports 64MB/128MB/256MB/512MB/1GB DIMM modules (4).
- Supports DDR (Double Data Rate) Synchronous DRAM (2.5 V).
- Supports 8 banks up to 4Gb DRAMs for registered DDR SDRAM module.
- Supports 6 banks up to 3Gb DRAMs DIMMs for unbuffered DDR SDRAM module.
- 200/266 MHz Bus Frequency.

#### Shadow RAM

- Motherboard is equipped with a memory controller providing shadow RAM and support for 8 bit ROM BIOS.

**Green Functionality**

- Supports Award BIOS™ power management functionality.
- Has a power down timer from 1 to 15 minutes.
- Wakes from power saving sleep mode with any keyboard or mouse activity.

**BUS Slots**

- (1) AGP slot.
- (1) CNR slot (Support Type B CNR only).
- (1) ACR slot
- (5) 32-bit PCI bus slots

**Flash Memory**

- Supports flash memory functionality.
- Supports ESCD functionality.

**Built in IDE Facilities**

- Supports four IDE hard disk drives.
- Supports PIO Mode 4, Master Mode, and high performance hard disk drives.
- Supports disk transfer rates up to 100 MB/second.
- Supports Ultra DMA 33, Ultra DMA 66, Ultra DMA 100 Bus Master Modes.
- Supports IDE interface with CD-ROM.
- Supports high capacity hard disk drives.
- Supports LBA mode.

**SoundBlaster Pro Hardware and Direct Sound Ready AC97 Digital Audio Controller**

- Dual full-duplex Direct Sound channels between system memory and AC97 link.
- PCI master interface with scatter / gather and bursting capability.
- 32 byte FIFO of each direct sound channel.
- Host based sample rate converter and mixer.
- Standard v1.0 or v2.0 AC97 Codec interface for single or cascaded AC97 Codec's from multiple vendors.



- Loopback capability for re-directing mixed audio streams into USB and 1394 speakers.
- Hardware SoundBlaster Pro for Windows DOS box and real-mode DOS legacy compatibility.
- Plug and play with 4 IRQ, 4 DMA, and 4 I/O space options for SoundBlaster Pro and MIDI hardware.
- Hardware assisted FM synthesis for legacy compatibility.
- Direct two game ports and one MIDI port interface.
- Complete software driver support for Windows 95, Windows 98, Windows 2000 and Windows NT.

**I/O facilities**

- One multi-mode Parallel Port capable of supporting the following specifications:
  - Standard & Bidirection Parallel Port.
  - Enhanced Parallel Port (EPP).
  - Extended Capabilities Port (ECP).
  - Normal
- Supports two serial ports, 16550 UART.
- Supports Infrared Data Transmission using IrDA.
- Supports PS/2 mouse and PS/2 keyboard.
- Supports 360KB, 720KB, 1.2MB, 1.44MB, and 2.88MB floppy disk drives.

**Universal Serial Bus**

- Supports two back panel Universal Serial Bus Ports and four front panel Universal Serial Bus Ports (optional).
- Supports 48 MHz USB.

**Hardware Monitor Function**

- Monitors CPU Fan Speed.
- Monitors System Voltage.

**Dimensions (ATX form-factor)**

- 24.4cm x 30.5cm (WxL)

### **1.1.2 BIOS**

- AWARD legal BIOS.
- Supports APM1.2.
- Supports USB Function.
- Supports ACPI.

### **1.1.3 Software**

#### **Operating System**

- Offers the highest performance for MS-DOS, Windows NT, Windows 2000, Windows 95/98, Windows ME, Novell, LINUX, UNIX, SCO UNIX etc.

### **1.1.4 Accessories**

- HDD Cable.
- FDD Cable.
- Flash Memory Writer for BIOS Update.
- USB2/USB3 Cable (Optional).
- Rear I/O Panel for ATX Case (Optional).
- Fully Setup Driver CD.

## 1.2 Motherboard Installation

### 1.2.1 System Block Diagram

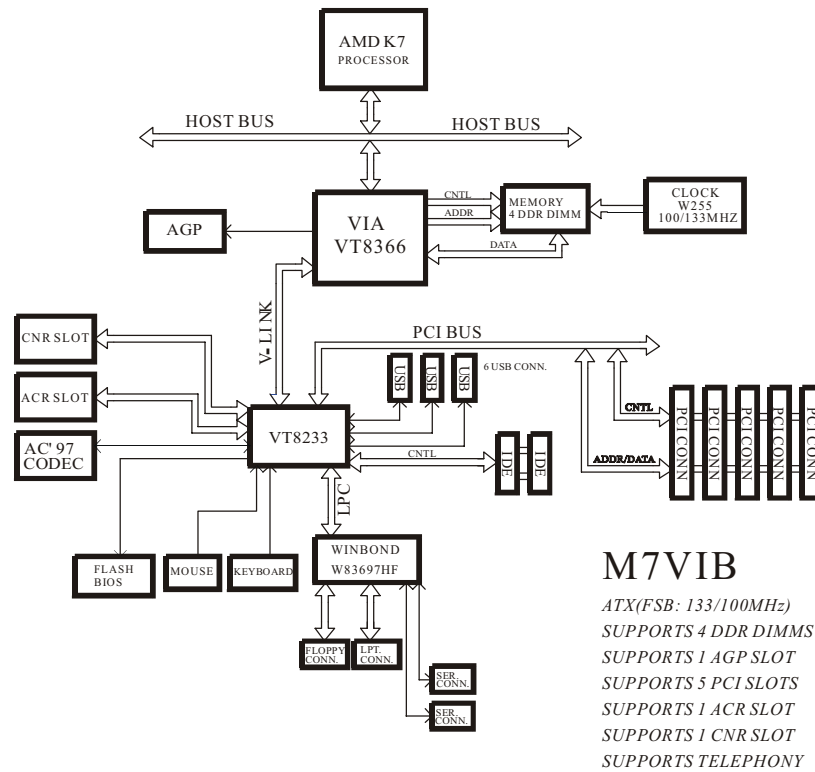



## 1.2.3 Quick Reference

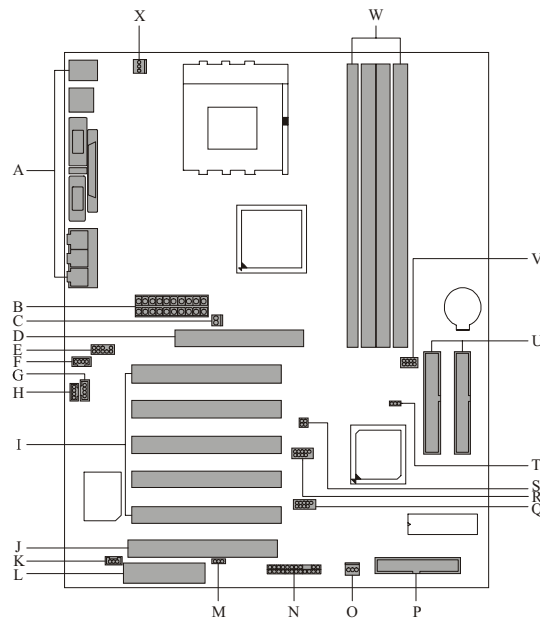

- |   |   |
|---|---|
| <b>A. Back Panel I/O Connectors</b>                     | <b>M. Codec Selection (J2)</b>            |
| <b>B. ATX Power Connector (JATXPWR1)</b>                | <b>N. Front Panel Connector (JPANEL1)</b> |
| <b>C. North Bridge Chipset (U2) FAN Header (JNFAN1)</b> | <b>O. System FAN Header (JSFAN1)</b>      |
| <b>D. AGP Slot (AGP1)</b>                               | <b>P. Floppy Disk Connector (FDD1)</b>    |
| <b>E. Front Audio Header (JAUDIO1)</b>                  | <b>Q. Front USB Header (JUSB3)</b>        |
| <b>F. Telephony Header (JTAD1)</b>                      | <b>R. Front USB Header (JUSB2)</b>        |
| <b>G. CD Audio-In Header (JCDIN1)</b>                   | <b>S. CPU Clock Selection (JCLK1)</b>     |
| <b>H. CD Audio-In Header (JCDIN2)</b>                   | <b>T. Clear CMOS (JCMOS1)</b>             |
| <b>I. PCI BUS Slots (PCI1-5)</b>                        | <b>U. IDE Connectors (IDE1-2)</b>         |
| <b>J. ACR Slot (ACR1)</b>                               | <b>V. DDR DIMM Voltage (J9)</b>           |
| <b>K. Wake-On-LAN Header (JWOL1)</b>                    | <b>W. DIMMs (DIMM1-4)</b>                 |
| <b>L. CNR Slot (CNR1)</b>                               | <b>X. CPU FAN Header (JCFAN1)</b>         |

## 1.3 CPU Installation

### 1.3.1 CPU Installation Procedure: Socket A

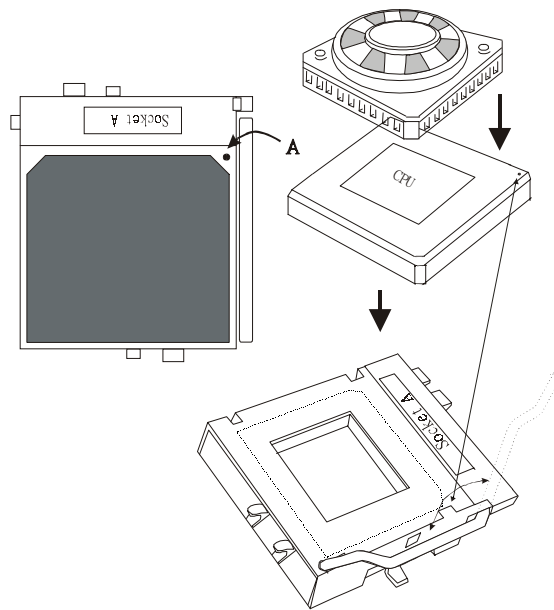

1. Pull the lever sideways away from the socket then raise the lever up to a 90-degree angle.
2. Locate Pin A in the socket and look for the white dot or cut edge in the CPU. Match Pin A with the white dot/cut edge then insert the CPU.
3. Press the lever down .
4. Put the fan on the CPU and buckle it and put the fan's powerport into the JCFAN1, then to complete the installation

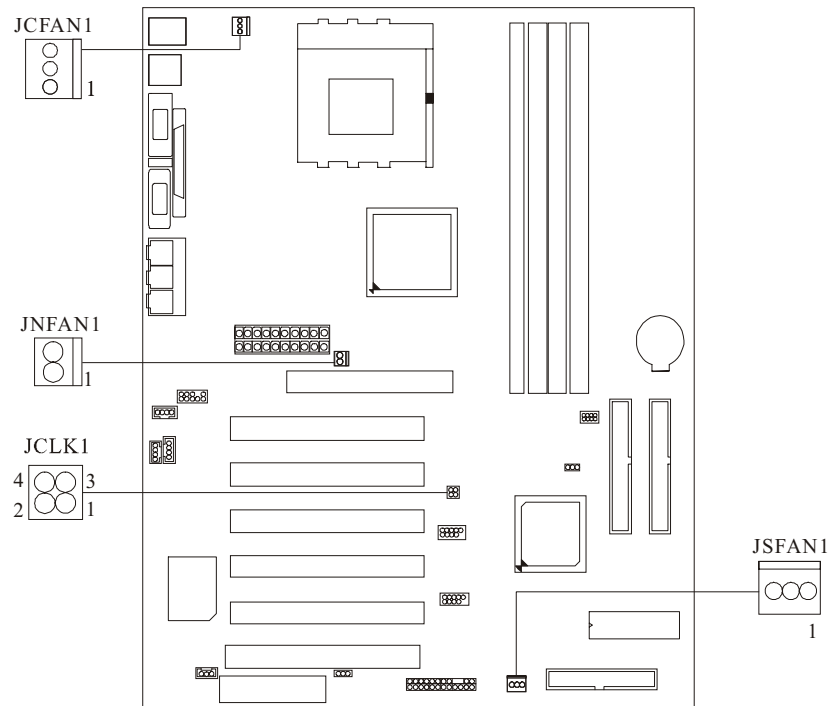

**1.3.2 Frequency Selection: JCLK1**

CPU Clock	PIN 1-2	PIN 3-4
100.0MHz	OFF	OFF
133.3MHz	ON	ON

**1.3.3 CPU Fan Header: JCFAN1**

Pin No.	Assignment
1	Ground
2	+12V
3	Sense

**1.3.4 System Fan Header: JSFAN1**

Pin No.	Assignment
1	Ground
2	+12V
3	Sense

**1.3.5 North Bridge Chipset Fan Header: JNFAN1**

Pin No.	Assignment
1	Ground
2	+12V



## 1.4 RAM Module Installation

### 1.4.1 DIMM

DRAM Access Time: 2.5V Unbuffered/ Registered DDR SDRAM PC1600/  
PC2100 Type required.

DRAM Type : 64MB/ 128MB/ 256MB/ 512MB/ 1GB DIMM Module (184 pin)

#### Total Memory Size

Devices used on DIMM	DIMM 1 (2 Rows) x64	For Unbuffered DIMMs		
		DIMM 2 (2 Rows) x64	DIMM 3 (2 Rows) x64	DIMM 4 (2 Rows) x64
64M (4Mx4x4banks)	256 M	256 M	256 M	256 M
64M (2Mx8x4banks)	128 M	128 M	128 M	128 M
64M (1Mx16x4banks)	64 M	64 M	64 M	64 M
128M (8Mx4x4banks)	512 M	512 M	512 M	512 M
128M (4Mx8x4banks)	256 M	256 M	256 M	256 M
128M (2Mx16x4banks)	128 M	128 M	128 M	128 M
256M (16Mx4x4banks)	1 G	1 G	1 G	1 G
256M (8Mx8x4banks)	512 M	512 M	512 M	512 M
256M (4Mx16x4banks)	256 M	256 M	256 M	256 M
512M (16Mx8x4banks)	1 G	1 G	1 G	1 G
512M (8Mx16x4banks)	512 M	512 M	512 M	512 M
<b>For Registered DIMMs</b>				

\* This M7VIB motherboard does not support with parity DIMM.

\*The list shown above for DRAM configuration is only for reference.

**Note: Don't stuff or remove the DIMM memory, If the LED1 is lighting.**

## 1.4.2 How to install a DIMM Module

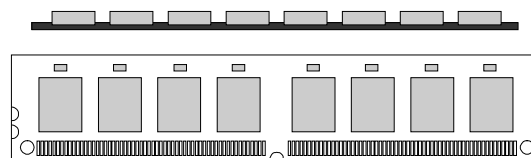

Single Sided DIMM

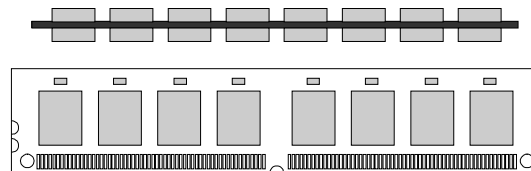

Double Sided DIMM

1. The DIMM socket has a “Plastic Safety Tab” and the DIMM memory module has an asymmetrical notch”, so the DIMM memory module can only fit into the slot in one direction.

2. Push the tabs out. Insert the DIMM memory modules into the socket at a 90-degree angle then push down vertically so that it will fit into place.

3. The Mounting Holes and plastic tabs should fit over the edge and hold the DIMM memory modules in place.

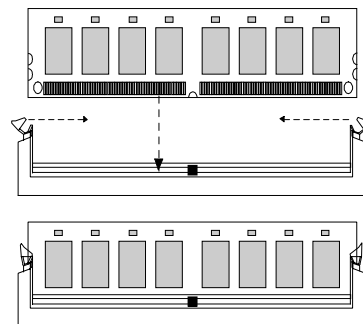

### 1.5 Slots

The slots in this motherboard are designed to hold expansion cards and connect them to the system bus. Expansion slots are a means of adding or enhancing the motherboard's features and capabilities. With these efficient facilities, you can increase the motherboard's capabilities by adding hardware that performs tasks that are not part of the basic system.

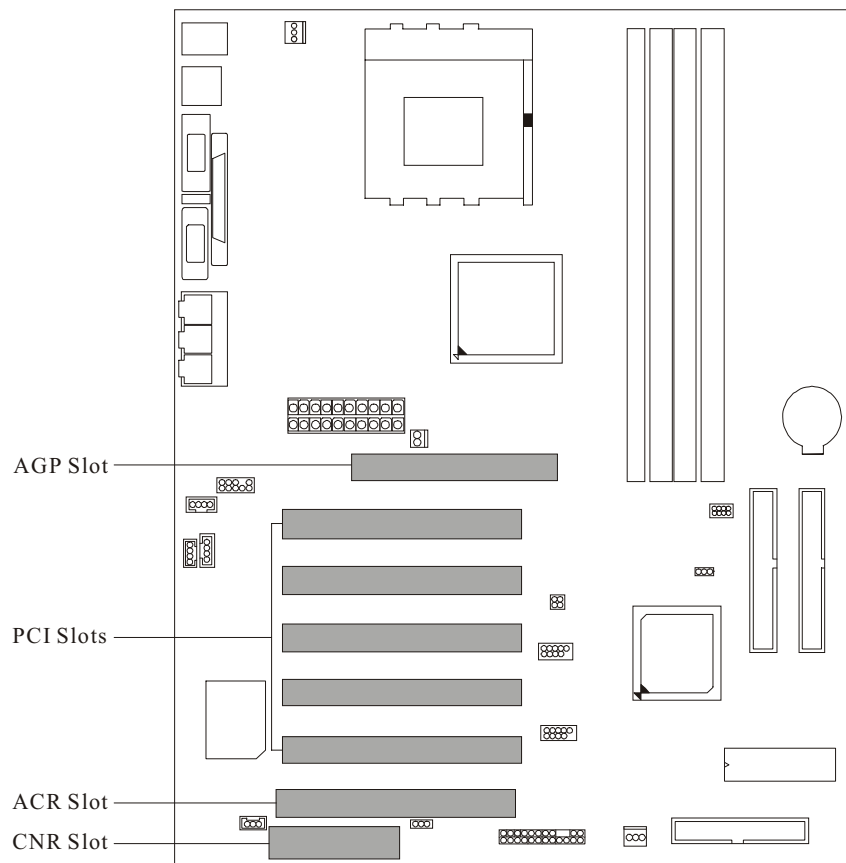

### **1.5.1 ACR (Advanced Communication Riser) Slot**

The ACR specification is an open Industry Standard Architecture and that defines a hardware scalable riser card interface, which supports audio, network and modem only.

### **1.5.2 AGP (Accelerated Graphics Port) Slot**

Unlike the mouse ports, keyboard ports and printer ports this motherboard does not have built in video facilities and therefore requires a video card for one of the expansion slots. Your monitor will attach directly to that video card. This motherboard supports video cards for PCI and ISA slots but is also equipped with an Accelerated Graphics Port (AGP). An AGP card will take advantage of AGP technology for improved video efficiency and performance, especially with 3D graphics.

### **1.5.3 CNR (Communication Network Riser) Slot**

The CNR specification is an open Industry Standard Architecture and that defines a hardware scalable riser card interface, which supports audio, network and modem only.

### **1.5.4 PCI (Peripheral Component Interconnect) Slots**

This motherboard is equipped with 5 standard PCI slots. PCI stands for Peripheral Component Interconnect and is a bus standard for expansion cards, which has, for the most part, supplanted the older ISA bus standard. This PCI slot is designated as 32 bit.

## 1.6 Connectors, Headers & Jumpers

The connectors, headers and jumpers introduced below provide you lots of capabilities such as power supply, front panel signal revelation, IDE hard disk connection, floppy disk connection, Wake On LAN function and USB connection. Noticeably, a jumper has two or more pins that can be covered by a plastic jumper cap, allowing you to select different system options.

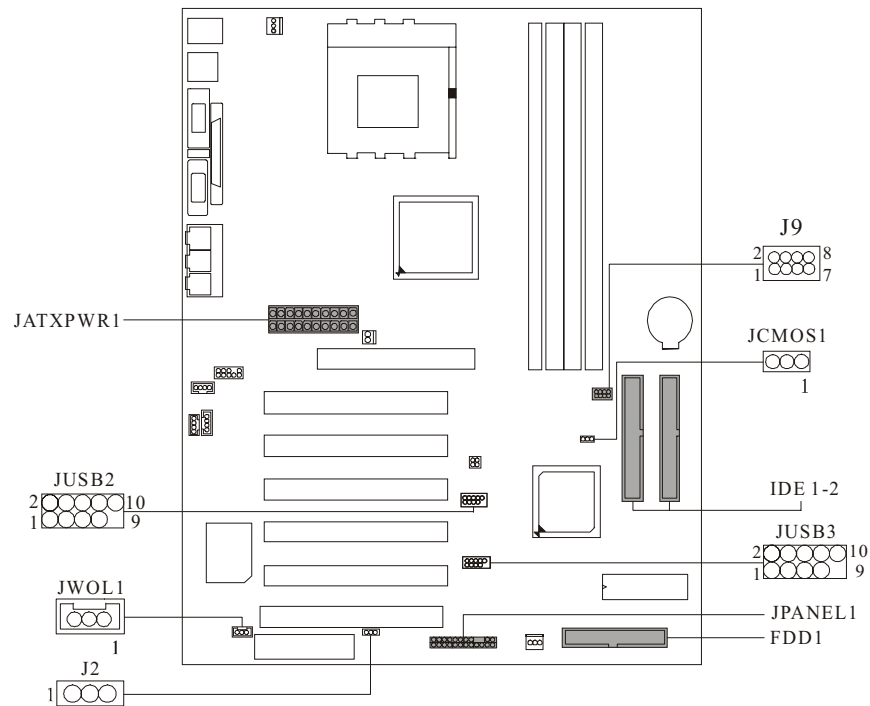

### 1.6.1 Front Panel Connector: JPANEL1

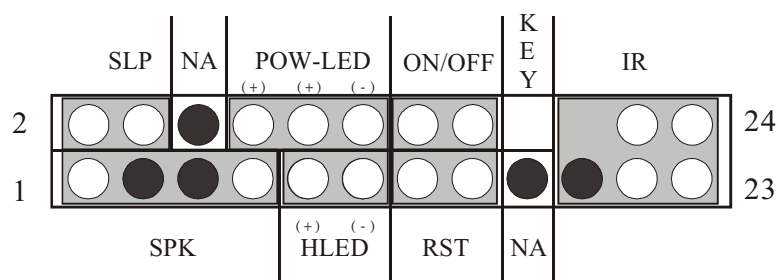

Pin No.	Assignment	Function	Pin No.	Assignment	Function
1	+5V	Speaker Connector	2	Sleep Control	Sleep Button
3	NA		4	Ground	Button
5	NA		6	NA	NA
7	Speaker		8	Power LED (+)	POWER LED
9	HDD LED (+)	10	Power LED (+)		
11	HDD LED (-)	12	Power LED (-)		
13	Ground	Reset Button	14	Power Button	Power-on Button
15	Reset Control	Button	16	Ground	Button
17	NA		18	KEY	
19	NA	IrDA Connector	20	KEY	IrDA
21	VCC5	Connector	22	Ground	Connector
23	IRTX		24	IRRX	

#### SPK (Speaker Connector)

An offboard speaker can be installed on the motherboard as a manufacturing option. An offboard speaker can be connected to the motherboard at the front panel connector. The speaker (onboard or offboard) provides error beep code information during the Power On Self-Test when the computer cannot use the video interface. The speaker is not connected to the audio subsystem and does not receive output from the audio subsystem.

**RST (Reset Button)**

This connector can be attached to a momentary SPST switch. This switch is usually open and when closed will cause the motherboard to reset and run the POST (Power On Self Test).

**POW-LED (Power LED Connector)**

This connector can be attached to an LED on the front panel of a computer case. The LED will illuminate while the computer is powered on.

**HLED (Hard Drive LED Connector)**

This connector can be attached to an LED on the front panel of a computer case. The LED will flicker during disk activity. This disk activity only applies to those IDE drives directly attached to the system board.

**IR (Infrared Connector)**

This connector is used to attach to an infrared sensing device. After the IrDA interface is configured, connectionless data transfer to and from portable devices such as laptops, PDAs is possible.

**SLP (Sleep/Green Button)**

This connector is used to conserve energy by powering down the monitor and the hard disk when not in use. To configure this option, you need to connect a button from the front panel to this connector. Depressing the button will power down the monitor and hard drives until the system is invoked by any keyboard activity, mouse activity, modem activity or when the sleep button is depressed again. APM (Advanced Power Management) must be enabled in the system BIOS and the APM driver must be loaded.

**ON/OFF (Power Button)**

This connector can be attached to a front panel power switch. The switch must pull the Power Button pin to ground for at least 50 ms to signal the power supply to switch on or off. (The time required is due to internal debounce circuitry on the system board). At least two seconds must pass before the power supply will recognize another on/off signal.

### 1.6.2 ATX 20-pin Power Connector: JATXPWR1

This connector supports the power button on-board. Using the ATX power supply, function such as Soft Power Off is supported on this motherboard. This power connector supports instant power-on functionality, which means that the system will boot up instantly when the power connector is inserted on the board.

PIN	Assignment	PIN	Assignment
1	3.3V	11	3.3V
2	3.3V	12	-12V
3	Ground	13	Ground
4	5V	14	PS_ON
5	Ground	15	Ground
6	5V	16	Ground
7	Ground	17	Ground
8	PW_OK	18	-5V
9	5V_SB	19	5V
10	12V	20	5V

### 1.6.3 Hard Disk Connectors: IDE1/IDE2

The motherboard has a 32-bit Enhanced PCI IDE Controller that provides PIO Mode 0~4, Bus Master, and Ultra DMA / 33, Ultra DMA / 66, Ultra DMA / 100 functionality. It has two HDD connectors IDE1 (primary) and IDE2 (secondary). You can connect up to four hard disk drives, a CD-ROM, a 120MB Floppy (reserved for future BIOS) and other devices to IDE1 and IDE2. These connectors support the IDE hard disk cable provided.

- **IDE1 (Primary IDE Connector)**

The first hard drive should always be connected to IDE1. IDE1 can connect a Master and a Slave drive. You must configure the second hard drive on IDE1 to Slave mode by setting the jumper accordingly.

- **IDE2 (Secondary IDE Connector)**

The IDE2 controller can also support a Master and a Slave drive. The configuration is similar to IDE1. The second drive on this controller must be set to slave mode.



### 1.6.4 Floppy Disk Connector: FDD1

The motherboard provides a standard floppy disk connector (FDC) that supports 360K, 720K, 1.2M, 1.44M and 2.88M floppy disk types. This connector supports the provided floppy drive ribbon cables.

### 1.6.5 Wake On LAN Header: JWOL1

Pin No.	Assignment
1	5V SB
2	Ground
3	Wake up

### 1.6.6 Clear CMOS Jumper: JCMOS1

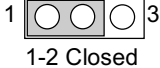
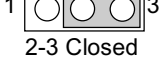
JCMOS1	Assignment
 1-2 Closed	Normal Operation (default)
 2-3 Closed	Clear CMOS Data



The following procedures are for resetting the BIOS password. It is important to follow these instructions closely.

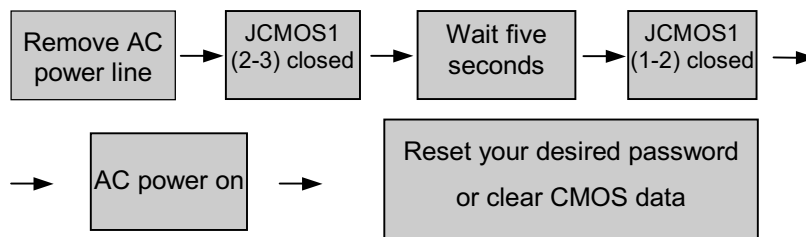

### 1.6.7 Front USB Headers: JUSB2/JUSB3



Note: Before you install these two headers, make sure the pin assignments are corresponded to the table below, otherwise, it may cause great damage to your USB device.

(JUSB2)

Pin	Assignment	Pin	Assignment
1	+5V(fused)	2	+5V(fused)
3	USBP2-	4	USBP3-
5	USBP2+	6	USBP3+
7	Ground	8	Ground
9	KEY	10	NC

(JUSB3)

Pin	Assignment	Pin	Assignment
1	+5V(fused)	2	+5V(fused)
3	USBP4-	4	USBP5-
5	USBP4+	6	USBP5+
7	Ground	8	Ground
9	KEY	10	NC

### 1.6.8 CNR Code Primary/Secondary Selection: J2

Pin No.	Assignment
1-2	On-board Primary Codec
2-3	CNR Primary Codec

### 1.6.9 DDR DIMM Voltage: J9

Pin	DDR DIMM Voltage
1-2	2.55V
3-4	2.65V (Default)
5-6	2.75V
7-8	2.85V

\* It's strongly recommended to set DDR DIMM voltage in default setting, the 2.75V/2.85V setting may cause DDR DIMM damage.

## 1.7 Peripheral Port

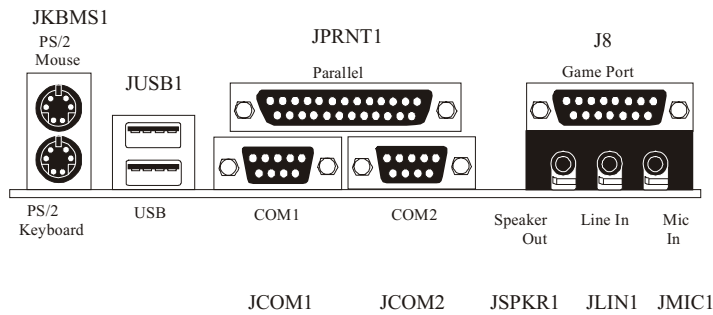

### 1.7.1 PS/2 Mouse / Keyboard Connector: JKBMS1

The motherboard provides a standard PS/2 mouse / Keyboard mini DIN connector for attaching a PS/2 mouse. You can plug a PS/2 mouse / Keyboard directly into this connector. The connector location and pin definition are shown below:

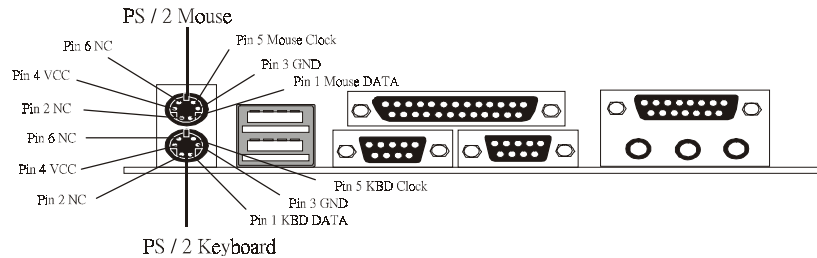

**PS/2 Mouse / Keyboard Connectors**

Pin	Assignment
1	Data
2	No connect
3	Ground
4	+5 V (fused)
5	Clock
6	No connect

**1.7.2 USB Connector: JUSB1**

The motherboard provides a **OHCI (Open Host Controller Interface) Universal Serial Bus Roots** for attaching USB devices such as: keyboard, mouse and other USB devices. You can plug the USB devices directly into this connector.

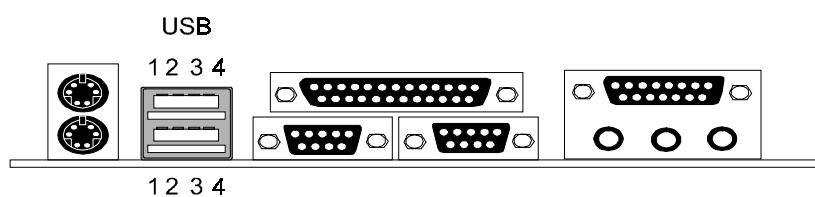
**Stacked USB Connectors**

Pin	Assignment
1	+5 V (fused)
2	USBP0- [USBP1-]
3	USBP0+ [USBP1+]
4	Ground

Signal names in brackets ([ ]) are for USB Port 1.

### **1.7.3 Serial and Parallel Interface Ports**

This system comes equipped with two serial ports and one parallel port. Both types of interface ports will be explained in this chapter.

#### **1.7.3.1 The Serial Interface: JCOM1/ JCOM2**

The serial interface port is sometimes referred to as an RS-232 port or an asynchronous communication port. Mice, printers, modems and other peripheral devices can be connected to a serial port. The serial port can also be used to connect your computer with another computer system. If you wish to transfer the contents of your hard disk to another system it can be accomplished by using each machine's serial port.

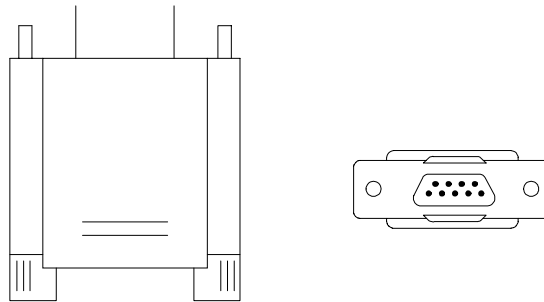

The serial ports on this system have two 9-pin connectors. Some older computer systems and peripherals used to be equipped with only one 25-pin connector. Should you need to connect your 9-pin serial port to an older 25-pin serial port, you can purchase a 9-to-25 pin adapter.

**Connectivity**

The serial ports can be used in many ways, and it may be necessary to become familiar with the pinout diagram. The following chart gives you the function of each pin on the 9-pin connector and some of the 25-pin connector. This information can be used when configuring certain software programs to work with the serial ports.

<b>Signal</b>	<b>Name</b>	<b>DB9 PIN</b>	<b>DB25 PIN</b>
DCD	Data Carrier Detect	1	8
RX	Receive Data	2	3
TX	Transmit Data	3	2
DTR	Data Terminal Ready	4	20
GND	Signal Ground	5	7
DSR	Data Set Ready	6	6
RTS	Request to Send	7	4
CTS	Clear to Send	8	5
RI	Ring Indicator	9	22

### 1.7.3.2 Parallel Interface Port: JPRNT1

Unlike the serial ports, parallel interface port has been standardized and should not present any difficulty interfacing peripherals to your system. Sometimes called centronics port, the parallel port is almost exclusively used with printers. The parallel port on your system has a 25-pin, DB25 connector (see picture below). The pinout for the parallel port are shown in the table below.

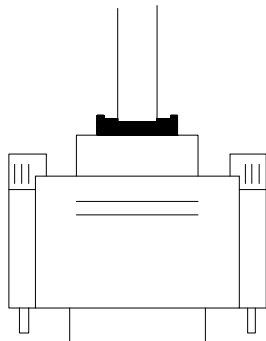
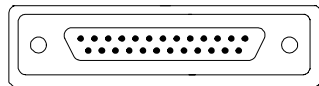

Signal	Pin
-Strobe	1
Data 0	2
Data 1	3
Data 2	4
Data 3	5
Data 4	6
Data 5	7
Data 6	8
Data 7	9
-Ack	10
Busy	11
Paper Empty	12
+Select	13
-Auto FDXT	14
-Error	15
-Init	16
-SLCTN	17
Ground	18
Ground	19
Ground	20
Ground	21
Ground	22
Ground	23
Ground	24
Ground	25



### 1.7.4 Game (Joystick/MIDI) Port Connector: J8

This connector allows you to connect a joystick or game pad for playing computer games. Also, you may play or edit professional music by connecting MIDI devices.

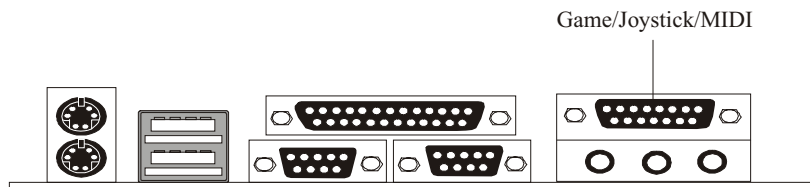

### 1.7.5 Audio Port Connectors: JSPKR1/JLIN1/JMIC1

**Speaker Out** is used to connect speakers or headphones for audio output.

**Line In** can be connected to the external CD player, Tape player or other audio devices for audio input.

**Mic In** is used to connect a microphone which allows you to input sounds and voices.

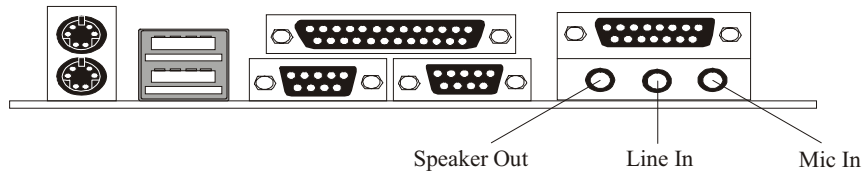

### 1.7.6 Audio Subsystem

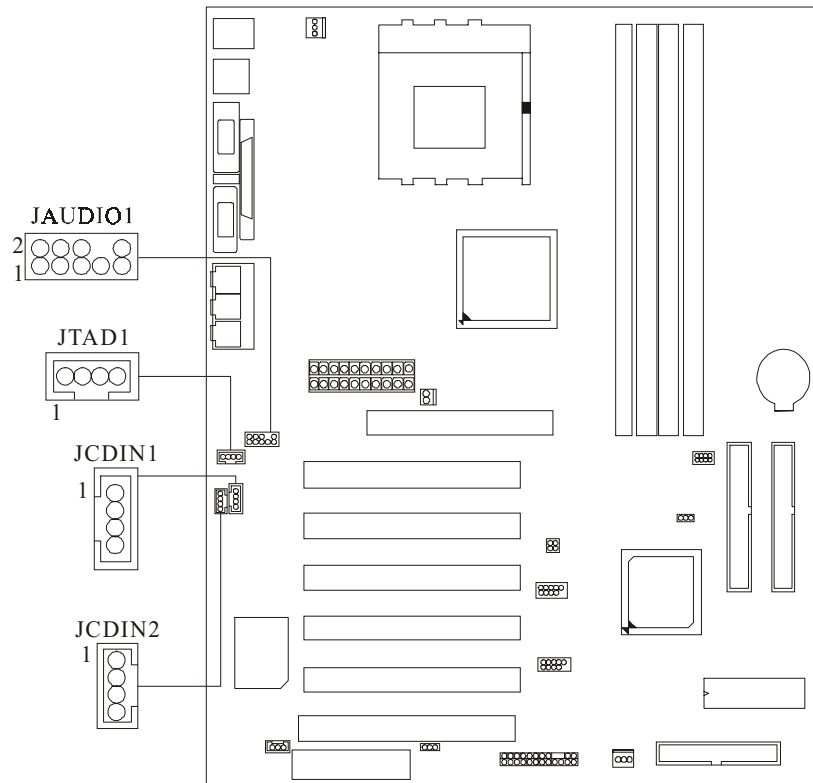

**1.7.6.1 CD-ROM Audio-In Header: JCDIN1**

Pin No.	Assignment
1	Left Channel Input
2	Ground
3	Ground
4	Right Channel Input

**1.7.6.2 CD-ROM Audio-In Header: JCDIN2**

Pin No.	Assignment
1	Left Channel Input
2	Ground
3	Right Channel Input
4	Ground

**1.7.6.3 Front Panel Audio Header: JAUDIO1**

Pin No.	Assignment	Pin No.	Assignment
1	Mic In	2	Ground
3	Mic Power	4	Audio Power
5	RT Line Out	6	RT Line Out
7	Reserved	8	
9	LFT Line Out	10	LFT Line Out

**1.7.6.4 Telephony Audio Header: JTAD1**

Pin No.	Assignment
1	MONO_IN
2	Ground
3	Ground
4	MONO_OUT

## **2. BIOS Setup**

### **Introduction**

This manual discussed Award™ Setup program built into the ROM BIOS. The Setup program allows users to modify the basic system configuration. This special information is then stored in battery-backed RAM so that it retains the Setup information when the power is turned off.

The Award BIOS™ installed in your computer system's ROM (Read Only Memory) is a custom version of an industry standard BIOS. This means that it supports AMD-Athlon™ / Duron™ processors input/output system. The BIOS provides critical low-level support for standard devices such as disk drives and serial and parallel ports.

Adding important has customized the Award BIOS™, but nonstandard, features such as virus and password protection as well as special support for detailed fine-tuning of the chipset controlling the entire system.

The rest of this manual is intended to guide you through the process of configuring your system using Setup.

### **Plug and Play Support**

These AWARD BIOS supports the Plug and Play Version 1.0A specification. ESCD (Extended System Configuration Data) write is supported.

### **EPA Green PC Support**

This AWARD BIOS supports Version 1.03 of the EPA Green PC specification.

### **APM Support**

These AWARD BIOS supports Version 1.1&1.2 of the Advanced Power Management (APM) specification. Power management features are implemented via the System Management Interrupt (SMI). Sleep and Suspend power management modes are supported. Power to the hard disk drives and video monitors can be managed by this AWARD BIOS.

**PCI Bus Support**

This AWARD BIOS also supports Version 2.1 of the Intel PCI (Peripheral Component Interconnect) local bus specification.

**DRAM Support**

DDR SDRAM (Double Data Rate Synchronous DRAM) are supported.

**Supported CPUs**

This AWARD BIOS supports the AMD Athlon™ / Duron™ CPU.

**Using Setup**

In general, you use the arrow keys to highlight items, press <Enter> to select, use the <PgUp> and <PgDn> keys to change entries, press <F1> for help and press <Esc> to quit. The following table provides more detail about how to navigate in the Setup program by using the keyboard.

<b>Keystroke</b>	<b>Function</b>
Up arrow	Move to previous item
Down arrow	Move to next item
Left arrow	Move to the item on the left (menu bar)
Right arrow	Move to the item on the right (menu bar)
Esc	Main Menu: Quit without saving changes Submenus: Exit Current page to the next higher level menu
Move Enter	Move to the item you desired
PgUp key	Increase the numeric value or make changes
PgDn key	Decrease the numeric value or make changes
+ Key	Increase the numeric value or make changes
- Key	Decrease the numeric value or make changes
Esc key	Main Menu – Quit and not save changes into CMOS Status Page Setup Menu and Option Page Setup Menu – Exit Current page and return to Main Menu
F1 key	General help on Setup navigation keys
F5 key	Load previous values from CMOS
F6 key	Load the fail-safe defaults from BIOS default table
F7 key	Load the optimized defaults
F10 key	Save all the CMOS changes and exit

## 2.1 Main Menu

Once you enter Award BIOS™ CMOS Setup Utility, the Main Menu will appear on the screen. The Main Menu allows you to select from several setup functions. Use the arrow keys to select among the items and press <Enter> to accept and enter the sub-menu.

**!! WARNING !!**

The information about BIOS defaults on manual (**Figure 1,2,3,4,5,6,7,8**) is just for reference, please refer to the BIOS installed on board, for update information.

■ Figure 1. Main Menu



### Standard CMOS Features

This submenu contains industry standard configurable options.

### Advanced BIOS Features

This submenu allows you to configure enhanced features of the BIOS.

**Advanced Chipset Features**

This submenu allows you to configure special chipset features.

**Integrated Peripherals**

This submenu allows you to configure certain IDE hard drive options and Programmed Input/ Output features.

**Power Management Setup**

This submenu allows you to configure the power management features.

**PnP/PCI Configurations**

This submenu allows you to configure certain “Plug and Play” and PCI options.

**PC Health Status**

This submenu allows you to monitor the hardware of your system.

**Frequency/Voltage Control**

This submenu allows you to change CPU Vcore Voltage and CPU/PCI clock. **(However, this function is strongly recommended not to use. Not properly change the voltage and clock may cause CPU or M/B damage!)**

**Load Optimized Defaults**

This selection allows you to reload the BIOS when the system is having problems particularly with the boot sequence. These configurations are factory settings optimized for this system. A confirmation message will be displayed before defaults are set.

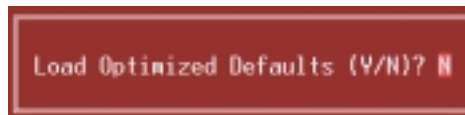

**Set Supervisor Password**

Setting the supervisor password will prohibit everyone except the supervisor from making changes using the CMOS Setup Utility. You will be prompted with to enter a password.

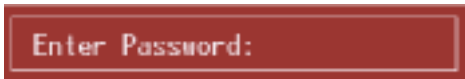

**Set User Password**

If the Supervisor Password is not set, then the User Password will function in the same way as the Supervisor Password. If the Supervisor Password is set and the User Password is set, the “User” will only be able to view configurations but will not be able to change them.

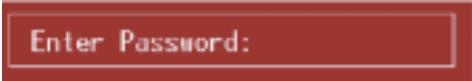

**Save & Exit Setup**

Save all configuration changes to CMOS(memory) and exit setup. confirmation message will be displayed before proceeding.

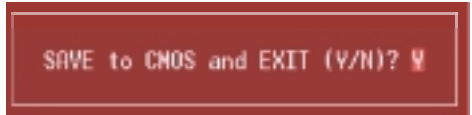

**Exit Without Saving**

Abandon all changes made during the current session and exit setup. confirmation message will be displayed before proceeding.

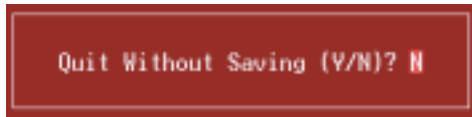



## 2.2 Standard CMOS Features

The items in Standard CMOS Setup Menu are divided into 10 categories. Each category includes no, one or more than one setup items. Use the arrow keys to highlight the item and then use the <PgUp> or <PgDn> keys to select the value you want in each item.

■ **Figure 2. Standard CMOS Setup**

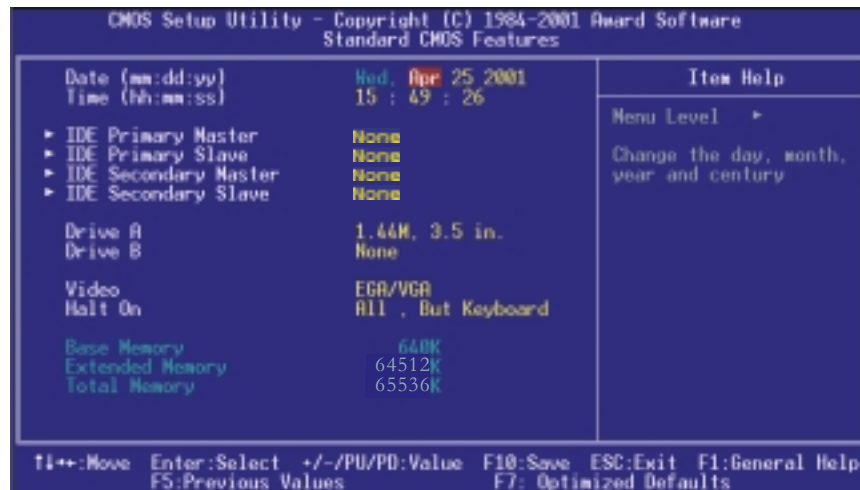

**Main Menu Selections**

This table shows the selections that you can make on the Main Menu.

<b>Item</b>	<b>Options</b>	<b>Description</b>
Date	MM DD YYYY	Set the system date. Note that the 'Day' automatically changes when you set the date.
IDE Primary Master	Options are in its sub menu.	Press <Enter> to enter the sub menu of detailed options
IDE Primary Slave	Options are in its sub menu.	Press <Enter> to enter the sub menu of detailed options.
IDE Secondary Master	Options are in its sub menu.	Press <Enter> to enter the sub menu of detailed options.
IDE Secondary Slave	Options are in its sub menu.	Press <Enter> to enter the sub menu of detailed options.
Drive A  Drive B	360K, 5.25 in 1.2M, 5.25 in 720K, 3.5 in 1.44M, 3.5 in 2.88M, 3.5 in None	Select the type of floppy disk drive installed in your system.
Video	EGA/VGA CGA 40 CGA 80 MONO	Select the default video device.

<b>Item</b>	<b>Options</b>	<b>Description</b>
Halt On	All Errors No Errors All, but Keyboard All, but Diskette All, but Disk/ Key	Select the situation in which you want the BIOS to stop the POST process and notify you.
Base Memory	N/A	Displays the amount of conventional memory detected during boot up.
Extended Memory	N/A	Displays the amount of extended memory detected during boot up.
Total Memory	N/A	Displays the total memory available in the system.

## 2.3 Advanced BIOS Features

■ Figure 3. Advanced BIOS Setup

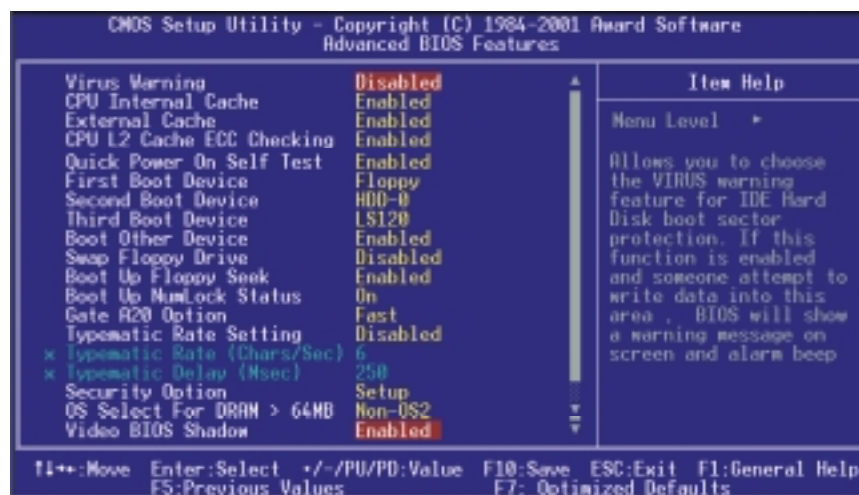

### Virus Warning

This option allows you to choose the VIRUS Warning feature that is used to protect the IDE Hard Disk boot sector. If this function is enabled and an attempt is made to write to the boot sector, BIOS will display a warning message on the screen and sound an alarm beep.

<b>Disabled</b> (default)	Virus protection is disabled.
Enabled	Virus protection is activated.

### CPU Internal Cache

Depending on the CPU/chipset in use, you may be able to increase memory access time with this option.

<b>Enabled</b> (default)	Enable cache.
Disabled	Disable cache.

**External Cache**

This option you to enable or disable “Level 2” secondary cache on the CPU which may improve performance.

<b>Enabled</b> (default)	Enable cache.
Disabled	Disable cache.

**CPU L2 Cache ECC Checking**

This item allows you to enable/disable CPU L2 Cache ECC Checking.

**The Choices:** **Enabled** (default), Disabled.

**Quick Power On Self Test**

Enabling this option will cause an abridged version of the Power On Self-Test (POST) to execute after you power up the computer.

<b>Enabled</b> (default)	Enable quick POST.
Disabled	Normal POST.

**First /Second/Third/ Boot Other Device**

These BIOS attempts to load the operating system from the devices in the sequence selected in these items.

**The Choices:** Floppy, LS120, HDD-0, SCSI, CDROM, HDD-1, HDD-2, HDD-3, ZIP100, LAN, HPT370, Disabled.

**Swap Floppy Drive**

For systems with two floppy drives, this option allows you to swap logical drive assignments.

**The Choices:** Enabled, **Disabled** (default).

**Boot Up Floppy Seek**

Enabling this option will test the floppy drives to determine if they have 40 or 80 tracks. Disabling this option reduces the time it takes to boot-up.

**The Choices:** **Enabled** (default), Disabled.

**Boot Up NumLock Status**

Selects the NumLock. State after power on.

- |                     |                        |
|---------------------|------------------------|
| <b>On</b> (default) | Numpad is number keys. |
| Off                 | Numpad is arrow keys.  |

**Gate A20 Option**

Select if chipset or keyboard controller should control Gate A20.

- |                       |   |
|-----------------------|---|
| Normal                | A pin in the keyboard controller controls Gate A20. |
| <b>Fast</b> (default) | Lets chipset control Gate A20.                      |

**Typematic Rate Setting**

When a key is held down, the keystroke will repeat at a rate determined by the keyboard controller. When enabled, the typematic rate and typematic delay can be configured.

- |                           |
|---------------------------|
| <b>Disabled</b> (default) |
| Enabled                   |

**Typematic Rate (Chars/Sec)**

Sets the rate at which a keystroke is repeated when you hold the key down.

**The Choices:** 6 (default), 8,10,12,15,20,24,30.

**Typematic Delay (Msec)**

Sets the delay time after the key is held down before it begins to repeat the keystroke.

**The Choices:** 250 (default), 500,750,1000.

**Security Option**

This option will enable only individuals with passwords to bring the system online and/or to use the CMOS Setup Utility.

- |                        |   |
|------------------------|---|
| System                 | A password is required for the system to boot and is also required to access the Setup Utility. |
| <b>Setup</b> (default) | A password is required to access the Setup Utility only.  |

This will only apply if passwords are set from the Setup main menu.

**OS Select For DRAM > 64MB**

A choice other than Non-OS2 is only used for OS2 systems with memory exceeding 64MB.

**The Choices:** Non-OS2 (default), OS2.

**Video BIOS Shadow**

Determines whether video BIOS will be copied to RAM for faster execution.

**Enabled** (default)

Optional ROM is enabled.

Disabled

Optional ROM is disabled.

## 2.4 Advanced Chipset Features

This submenu allows you to configure the specific features of the chipset installed on your system. This chipset manages bus speeds and access to system memory resources, such as DRAM and external cache. It also coordinates communications with the PCI bus. The default settings that came with your system have been optimized and therefore should not be changed unless you are suspicious that the settings have been changed incorrectly.

### ■ Figure 4. Advanced Chipset Setup

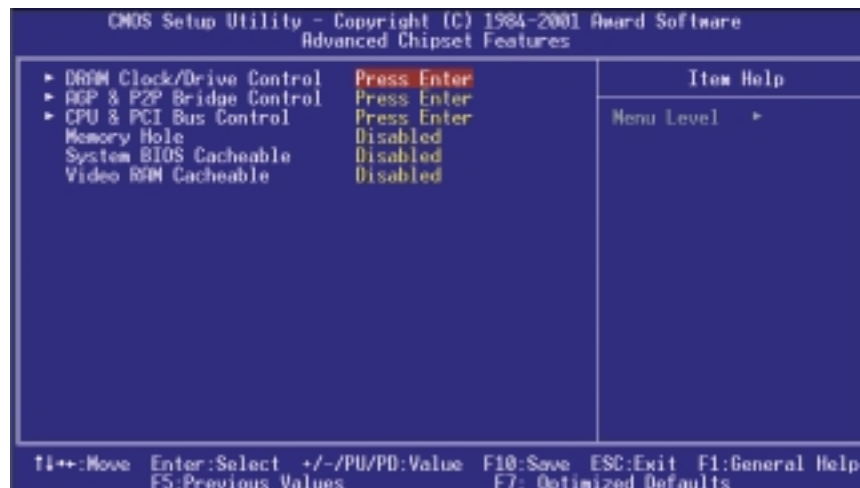

### DRAM Clock/Drive Control

To control the Clock/Drive. If you highlight the literal “Press Enter” next to the “DRAM Clock/Drive Control” label and then press the enter key, it will take you a submenu with the following options:

#### **DRAM Clock**

This item determines DRAM clock following 100MHz, 133MHz or By SPD.

**The Choices:** 100MHz, 133MHz, **By SPD** (default).



**DRAM Timing**

This item determines DRAM clock/ timing follow SPD or not.

**The Choices:** By SPD(default), Manual.

**SDRAM Cycle Length**

When synchronous DRAM is installed, the number of clock cycles of CAS latency depends on the DRAM timing. Do not reset this field from the default value specified by the system designer.

**The Choices:** 2.5 (default).

**Bank Interleave**

This item allows you to enable or disable the bank interleave feature.

**The Choices:** Disabled (default).

**DRAM Command Rate**

This item controls clock cycle that must occur between the last valid write operation and the next command.

**The Choices:** 1T Command, 2T Command (default).

**AGP & P2P Bridge Control**

If you highlight the literal “Press Enter” next to the “AGP & P2P Bridge Control” label and then press the enter key, it will take you a submenu with the following options:

**AGP Aperture Size**

Select the size of the Accelerated Graphics Port (AGP) aperture. The aperture is a portion of the PCI memory address range dedicated for graphics memory address space. Host cycles that hit the aperture range are forwarded to the AGP without any translation.

**The Choices:** 64M (default), 256M, 128M, 32M, 16M, 8M, 4M.

**AGP Mode**

This item allows you to select the AGP Mode.

**The Choices:** 4X (default), 2X, 1X.

**AGP Driving Control**

By choosing “Auto” the system BIOS will the AGP output Buffer Drive strength P Ctrl by AGP Card. By choosing “Manual”, it allows user to set AGP output Buffer Drive strength P Ctrl by manual.

**The Choices:** Auto (default), Manual.

**AGP Driving Value**

While AGP driving control item set to “Manual”, it allows user to set AGP driving.

**The Choices:** DA (default).

**AGP Fast Write**

**The Choices:** Enabled, Disabled (default).

**AGP Master 1 WS Write**

When Enabled, writes to the AGP (Accelerated Graphics Port) are executed with one wait states.

**The Choices:** Disabled (default), Enabled.

**AGP Master 1 WS Read**

When Enabled, read to the AGP (Accelerated Graphics Port) are executed with one wait states.

**The Choices:** Disabled (default), Enabled.

**CPU & PCI Bus Control**

If you highlight the literal “Press Enter” next to the “CPU & PCI Bus Control” label and then press the enter key, it will take you a submenu with the following options:

**PCI1 Master 0 WS Write**

When Enabled, writes to the PCI bus are executed with zero-wait states.

**The Choices:** Enabled (default), Disabled.

**PCI2 Master 0 WS Write**

When Enabled, writes to the AGP bus are executed with zero-wait states.

**The Choices:** Enabled (default), Disabled.

**PCI1 Post Write**

When Enabled, CPU writes are allowed to be posted on the PCI bus.

**The Choices:** Enabled (default), Disabled.

**PCI2 Post Write**

When Enabled, CPU writes are allowed to be posted on the AGP bus.

**The Choices:** Enabled (default), Disabled.

**PCI Delay Transaction**

The chipset has an embedded 32-bit posted write buffer to support delay transactions cycles. Select Enabled to support compliance with PCI specification.

**The Choices:** Enabled (default), Disabled.

**Memory Hole**

When enabled, you can reserve an area of system memory for ISA adapter ROM. When this area is reserved, it cannot be cached. Refer to the user documentation of the peripheral you are installing for more information.

**The Choices:** Disabled (default), Enabled.

**System BIOS Cacheable**

Selecting the “Enabled” option allows caching of the system BIOS ROM at F0000h-FFFFFh which can improve system performance. However, any programs writing to this area of memory will cause conflicts and result in system errors.

**The Choices:** Enabled, Disabled (default).

**Video RAM Cacheable**

Enabling this option allows caching of the video RAM, resulting in better system performance. However, if any program writes to this memory area, a system error may result.

**The Choices:** Enabled, Disabled (default).

## 2.5 Integrated Peripherals

### ■ Figure 5. Integrated Peripherals

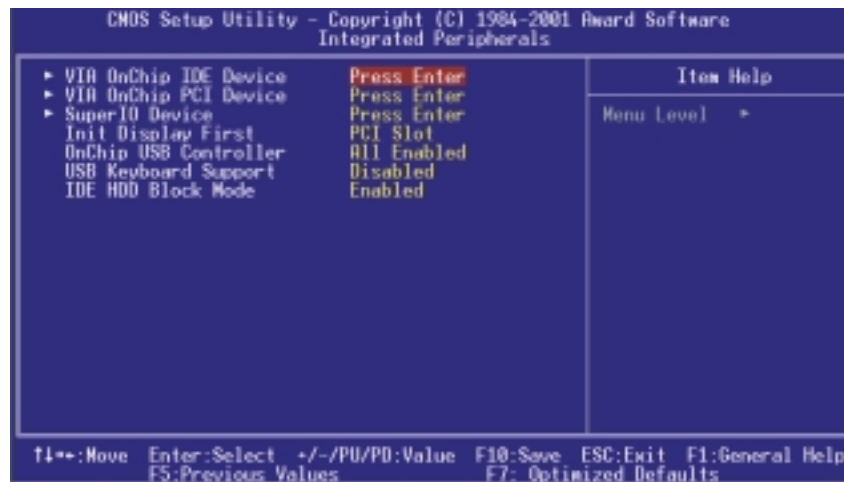

#### VIA OnChip IDE Device

If you highlight the literal “Press Enter” next to the “VIA OnChip IDE Device” label and then press the enter key, it will take you a submenu with the following options:

##### **OnChip IDE Channel 0/1**

The motherboard chipset contains a PCI IDE interface with support for two IDE channels. Select “Enabled” to activate the first and/or second IDE interface. Select “Disabled” to deactivate an interface if you are going to install a primary and/or secondary add-in IDE interface.

**The Choices:** Enabled (default), Disabled.

##### **IDE Prefetch Mode**

The “onboard” IDE drive interfaces supports IDE prefetching for faster drive access. If the interface does not support prefetching. If you install a primary and/or secondary add-in IDE interface, set this option to “Disabled”.

**The Choices:** Enabled (default), Disabled.

**Primary / Secondary /Master / Slave PIO**

The IDE PIO (Programmed Input / Output) fields let you set a PIO mode (0-4) for each of the IDE devices that the onboard IDE interface supports. Modes 0 to 4 will increased performance progressively. In Auto mode, the system automatically determines the best mode for each device.

**The Choices:** Auto (default), Mode0, Mode1, Mode2, Mode3, Mode4.

**Primary / Secondary /Master / Slave UDMA**

Ultra DMA/100 functionality can be implemented if it is supported by the IDE hard drives in your system. As well, your operating environment requires a DMA driver (Windows 95 OSR2 or a third party IDE bus master driver). If your hard drive and your system software both support Ultra DMA/100, select Auto to enable BIOS support.

**The Choices:** Auto (default), Disabled.

**VIA OnChip PCI Device**

If you highlight the literal “Press Enter” next to the “VIA OnChip PCI Device” label and then press the enter key, it will take you a submenu with the following options:

**VIA-3058 AC97 Audio**

This option allows you to control the onboard AC97 audio.

**The Choices:** Auto (default), Disabled.

**VIA-3068 MC97 Modem**

This option allows you to control the onboard MC97 modem.

**The Choices:** Auto (default), Disabled.

**VIA-3043 OnChip LAN**

This option allows you to control the onboard LAN.

**The Choices:** Enabled, Disabled (default).

**Super IO Device**

If you highlight the literal “Press Enter” next to the “Super IO Device” label and then press the enter key, it will take you a submenu with the following options:

**Onboard FDC Controller**

Select Enabled if your system has a floppy disk controller (FDC) installed on the system board and you wish to use it. If install and FDC or the system has no floppy drive, select Disabled in this field.

**The Choices:** Enabled (default), Disabled.

**Onboard Serial Port 1**

Select an address and corresponding interrupt for the first and second serial ports.

**The Choices:** Disabled, **3F8/IRQ4** (default), 2F8/IRQ3, 3E8/IRQ4, 2E8/IRQ3, Auto.

**Onboard Serial Port 2**

Select an address and corresponding interrupt for the first and second serial ports.

**The Choices:** Disabled, **2F8/IRQ3** (default), 3F8/IRQ4, 3E8/IRQ4, 2E8/IRQ3, Auto.

**UART Mode Select**

This item allows you to determine which Infra Red (IR) function of onboard I/O chip.

**The Choices:** Normal, AS KIR, IrDA.

**RxD, TxD Active**

This item allows you to determine which Infrared (IR) function of onboard I/O chip.

**The Choices:** Hi / Lo (default), Hi / Hi, Lo / Hi, Lo / Lo.

**IR Transmission Delay**

This item allows you to enable/disable IR transmission delay.

**The Choices:** Enabled (default), Disabled.

**UR2 Duplex Mode**

Select the value required by the IR device connected to the IR port. Full-duplex mode permits simultaneous two-direction transmission. Half-duplex mode permits transmission in one direction only at a time.

**The Choices:** Half (default), Full.

**Use IR Pins**

Consult your IR peripheral documentation to select the correct setting of the TxD and RxD signals.

**The Choices:** IR-Rx2Tx2 (default), RxD2, TxD2.

**Onboard Parallel Port**

This item allows you to determine access onboard parallel port controller with which I/O Address.

**The Choices:** 378/IRQ7 (default), 278/IRQ5, 3BC/IRQ7, Disabled.

**Parallel Port Mode**

The default value is SPP.

**The Choices:**

SPP(default)	Using Parallel port as Standard Printer Port.
EPP	Using Parallel Port as Enhanced Parallel Port.
ECP	Using Parallel port as Extended Capabilities Port.
ECP+EPP	Using Parallel port as ECP & EPP mode.

**EPP Mode Select**

Select EPP port type 1.7 or 1.9.

**The Choices:** EPP 1.7(default), EPP1.9.

**ECP Mode Use DMA**

Select a DMA Channel for the port.

**The Choices:** 3 (default), 1.

**Game Port Address**

Game Port I/O Address.

**The Choices:** 201 (default), 209, Disabled.

**Midi Port Address**

Midi Port Base I/O Address.

**The Choices:** 330 (default), 300, 290, Disabled.

**Midi Port IRQ**

This determines the IRQ in which the Midi Port can use.

**The Choices:** 5, 10 (default).

**Init Display First**

With systems that have multiple video cards, this option determines whether the primary display uses a PCI Slot or an AGP Slot.

**The Choices:** PCI Slot (default), AGP.

**OnChip USB Controller**

This option should be enabled if your system has a USB installed on the system board. You will need to disable this feature if you add a higher performance controller.

**The Choices:** All Enabled (default), All Disabled, 1& 2 USB Port, 2 & 3 USB Port, 1& 3 USB Port, 1 USB Port, 2 USB Port, 3 USB Port.

**USB Keyboard Support**

Enables support for USB attached keyboards.

**The Choices:** Disabled (default), Enabled.

**IDE HDD Block Mode**

Block mode is otherwise known as block transfer, multiple commands, or multiple sector read/write. Select the "Enabled" option if your IDE hard drive supports block mode (most new drives do). The system will automatically determine the optimal number of blocks to read and write per sector.

**The Choices:** Enabled (default), Disabled.



## 2.6 Power Management Setup

The Power Management Setup Menu allows you to configure your system to utilize energy conservation and power up/power down features.

### ■ Figure 6. Power Management Setup

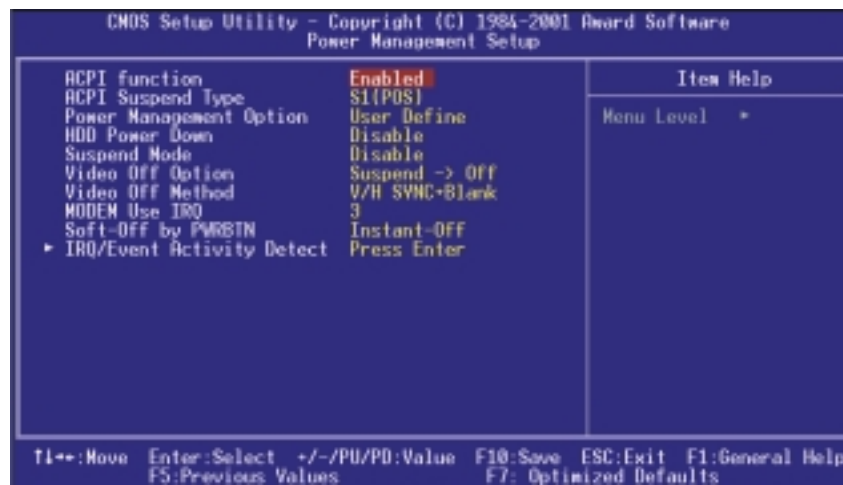

#### ACPI function

This item displays the status of the Advanced Configuration and Power Management (ACPI).

**The Choices:** Enabled (default), Disabled.

#### ACPI Suspend Type

The item allows you to select the suspend type under the ACPI operating system.

**The Choices:** S1 (POS) (default) Power on Suspend  
S3 (STR) Suspend to RAM

**Power Management Option**

This category allows you to select the type (or degree) of power saving and is directly related to the following modes:

1. HDD Power Down.
2. Suspend Mode.

There are four options of Power Management, three of which have fixed mode settings

Min. Power Saving

Minimum power management.  
Suspend Mode = 1 hr.  
HDD Power Down = 15 min

Max. Power Saving

Maximum power management only available for sl CPU's.  
Suspend Mode = 1 min.  
HDD Power Down = 1 min.

**User Defined** (default)

Allows you to set each mode individually.  
When not disabled, each of the ranges are from 1 min. to 1 hr. except for HDD Power Down which ranges from 1 min. to 15 min. and disable.

**HDD Power Down**

When enabled, the hard disk drive will power down and after a set time of system inactivity. All other devices remain active.

**The Choices:** Disabled (default), 1 Min, 2 Min, 3 Min, 4 Min, 5 Min, 6 Min, 7 Min, 8 Min, 9 Min, 10 Min, 11 Min, 12 Min, 13 Min, 14 Min, 15Min.

**Suspend Mode**

The item allows you to select the suspend type under ACPI operating system.

**The Choices:** Disabled (default), 1 Min, 2 Min, 4 Min, 6 Min, 8 Min, 10 Min, 20 Min, 30 Min, 40 Min, 1 Hour.

**Video Off Option**

This field determines when to activate the video off feature for monitor power management.

**The Choices:** Suspend→Off (default), Always on.

**Video Off Method**

This option determines the manner in which the monitor is goes blank.

**V/H SYNC+Blank** (default)

This selection will cause the system to turn off the vertical and horizontal synchronization ports and write blanks to the video buffer.

**Blank Screen**

This option only writes blanks to the video buffer.

**DPMS Support**

Initial display power management signaling.

**Modem Use IRQ**

This determines the IRQ, which can be applied in MODEM use.

**3** (default)

4 / 5 / 7 / 9 / 10 / 11 / NA

**Soft-Off by PWRBTN**

Pressing the power button for more than 4 seconds forces the system to enter the Soft-Off state when the system has “hung.”

**The Choices:** Delay 4 Sec, Instant-Off (default).

**IRQ/Event Activity Detect**

If you highlight the literal "Press Enter" next to the "IRQ/Event Activity Detect" label and then press the enter key, it will take you a submenu with the following options:

**VGA**

When set to **On**, any event occurring at a VGA Port will awaken a system which has been powered down.

**The Choices:** Off (default), On.

**LPT & COM**

When this option is set to **On**, any event occurring at a COM(serial)/LPT (printer) port will awaken a system which has been powered down.

**The Choices:** LPT/COM (default), COM, LPT, NONE.

**HDD & FDD**

When this option is set to **On**, any event occurring on a hard drive or a floppy drive will awaken a system which has been powered down.

**The Choices:** On (default), Off.

**PCI Master**

When set to **On**, you need a LAN add-on card which supports the power function. It should also support the wake-up on LAN jump.

**The Choices:** Off (default), On.

**PowerOn by PCI Card**

When you select Enabled, a PME signal from PCI card returns the system to Full ON state.

**The Choices:** Disabled (default), Enabled.

**Wake Up On LAN/Ring**

To use this function, you need a LAN add-on card which support power on function. It should also support the wake-up on LAN jump.

**Disabled** (default)      Wake up on LAN/Ring not supported.

Enabled                      Wake up on LAN/Ring supported.

**RTC Alarm Resume**

When "Enabled", you can set the date and time at which the RTC (real-time clock) alarm awakens the system from Suspend mode.

**The Choices:** Enabled, **Disabled** (default).

**Date (of Month)**

You can choose which month the system will boot up. This field is only configurable when “RTC Resume” is set to “Enabled”.

**Resume Time (hh:mm:ss)**

You can choose the hour, minute and second the system will boot up. This field is only configurable when “RTC Resume” is set to “Enabled”.

**IRQs Activity Monitoring**

**Press Enter** to access another sub menu used to configure the different wake up events (i.e. wake on LPT & COMM activity).

Primary INTR	On
IRQ3 (COM2)	Enabled
IRQ4 (COM1)	Enabled
IRQ5 (LPT2)	Enabled
IRQ6 (Floppy Disk)	Enabled
IRQ7 (LPT1)	Enabled
IRQ8 (RTC Alarm)	Disabled
IRQ9 (IRQ2 Redir)	Disabled
IRQ10 (Reserved)	Disabled
IRQ11 (Reserved)	Disabled
IRQ12 (PS/2 Mouse)	Enabled
IRQ13 (Coprocessor)	Enabled
IRQ14 (Hard Disk)	Enabled
IRQ15 (Reserved)	Disabled

## 2.7 PnP/PCI Configurations

This section describes configuring the PCI bus system. PCI, or Personal Computer Interconnect, is a system which allows I/O devices to operate at speeds nearing the speed of the CPU itself uses when communicating with its own special components. This section covers some very technical items and it is strongly recommended that only experienced users should make any changes to the default settings.

### ■ Figure 7. PnP/PCI Configurations

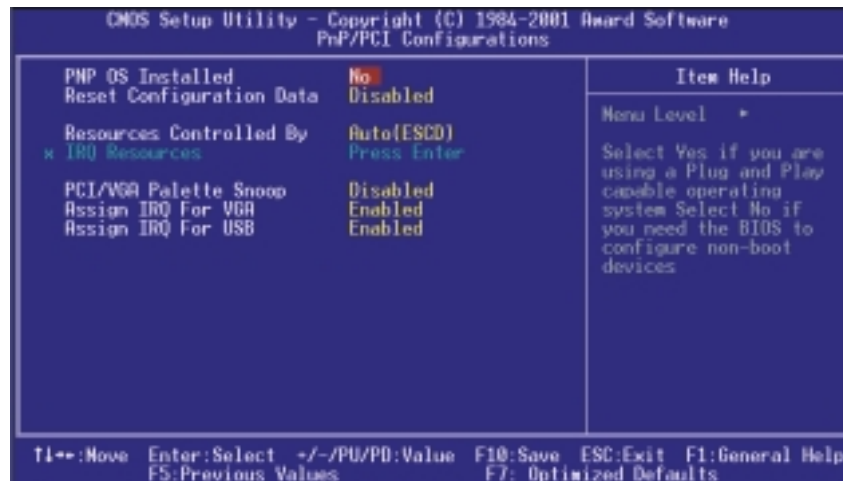

### PNP OS Installed

When set to YES, BIOS will only initialize the PnP cards used for the boot sequence (VGA, IDE, SCSI). The rest of the cards will be initialized by the PnP operating system like Window™ 95. When set to NO, BIOS will initialize all the PnP cards. For non-PnP operating systems (DOS, Netware™), this option must set to NO.

**The Choices:** No (default), Yes.

**Reset Configuration Data**

The system BIOS supports the PnP feature which requires the system to record which resources are assigned and protects resources from conflict. Every peripheral device has a node, which is called ESCD. This node records which resources are assigned to it. The system needs to record and update ESCD to the memory locations. These locations (4K) are reserved in the system BIOS. If the Disabled (default) option is chosen, the system's ESCD will update only when the new configuration varies from the last one. If the Enabled option is chosen, the system is forced to update ESCDs and then is automatically set to the "Disabled" mode.

IRQ-3	assigned to: PCI / ISA PnP
IRQ-4	assigned to: PCI / ISA PnP
IRQ-5	assigned to: PCI / ISA PnP
IRQ-7	assigned to: PCI / ISA PnP
IRQ-9	assigned to: PCI / ISA PnP
IRQ-10	assigned to: PCI / ISA PnP
IRQ-11	assigned to: PCI / ISA PnP
IRQ-12	assigned to: PCI / ISA PnP
IRQ-14	assigned to: PCI / ISA PnP
IRQ-15	assigned to: PCI / ISA PnP
DMA-0	assigned to: PCI / ISA PnP
DMA-1	assigned to: PCI / ISA PnP
DMA-3	assigned to: PCI / ISA PnP
DMA-5	assigned to: PCI / ISA PnP
DMA-6	assigned to: PCI / ISA PnP
DMA-7	assigned to: PCI / ISA PnP

The above settings will be shown on the screen only if "Manual" is chosen for the resources controlled by function.

Legacy is the term, which signifies that a resource is assigned to the ISA Bus and provides non-PnP ISA add-on cards. PCI / ISA PnP signifies that a resource is assigned to the PCI Bus or provides for ISA PnP add-on cards and peripherals.

**The Choices:** Disabled (default), Enabled.

**Resources Controlled By**

By Choosing "Auto" (default), the system BIOS will detect the system resources and automatically assign the relative IRQ and DMA channel for each peripheral.

By Choosing "Manual", the user will need to assign IRQ & DMA for add-on cards. Be sure that there are no IRQ/DMA and I/O port conflicts.

**IRQ Resources**

This submenu will allow you to assign each system interrupt a type, depending on the type of device using the interrupt. When you press the “Press Enter” tag, you will be directed to a submenu that will allow you to configure the system interrupts. This is only configurable when “Resources Controlled By” is set to “Manual”.

**PCI/ VGA Palette Snoop**

Choose Disabled or Enabled. Some graphic controllers which are not VGA compatible take the output from a VGA controller and map it to their display as a way to provide boot information and VGA compatibility.

However, the color information coming from the VGA controller is drawn from the palette table inside the VGA controller to generate the proper colors, and the graphic controller needs to know what is in the palette of the VGA controller. To do this, the non-VGA graphic controller watches for the Write access to the VGA palette and registers the snoop data. In PCI based systems, where the VGA controller is on the PCI bus and a non-VGA graphic controller is on an ISA bus, the Write Access to the palette will not show up on the ISA bus if the PCI VGA controller responds to the Write.

In this case, the PCI VGA controller should not respond to the Write, it should only snoop the data and permit the access to be forwarded to the ISA bus. The non-VGA ISA graphic controller can then snoop the data on the ISA bus. Unless you have the above situation, you should disable this option.

**The Choices:** **Disabled** (default) Disables the function.  
Enabled Enables the function.

**Assign IRQ For VGA**

This item allows the users to choose which IRQ to assign for the VGA.

**The Choices:** **Enabled** (default), Disabled.

**Assign IRQ For USB**

This item allows the users to choose which IRQ to assign for the USB.

**The Choices:** **Enabled** (default), Disabled.



## 2.8 PC Health Status

### ■ Figure 8. PC Health Status

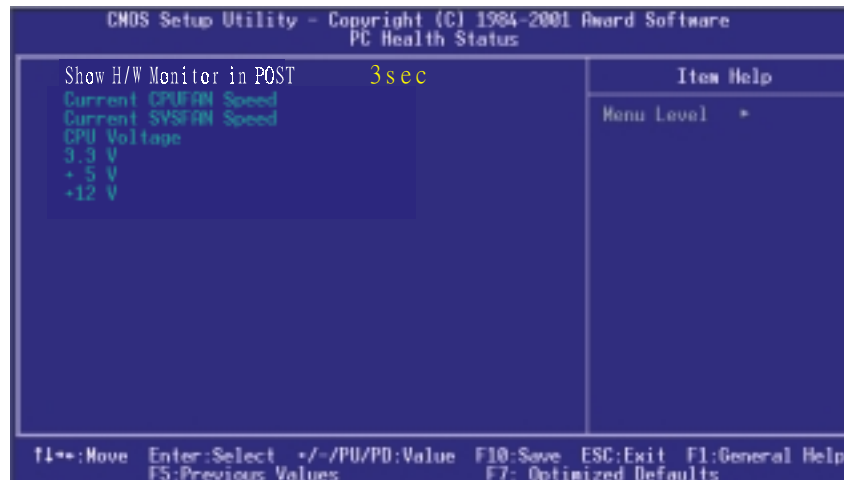

#### Show H/W Monitor in POST

If your computer contains a monitoring system, it will show PC health status during POST stage. The item offers several delay time for you to choose.

**The Choices:** None, 1sec, 2sec, **3 sec** (default).

#### Current CPUFAN Speed

This field displays the current speed of CPU fan.

#### Current SYSFAN Speed

This field displays the current speed SYSTEM fan.

#### CPU Voltage 3.3V, 5V, 12V

Detect the system's voltage status automatically.

## 2.9 Frequency/Voltage Control

### ■ Frequency/Voltage Control

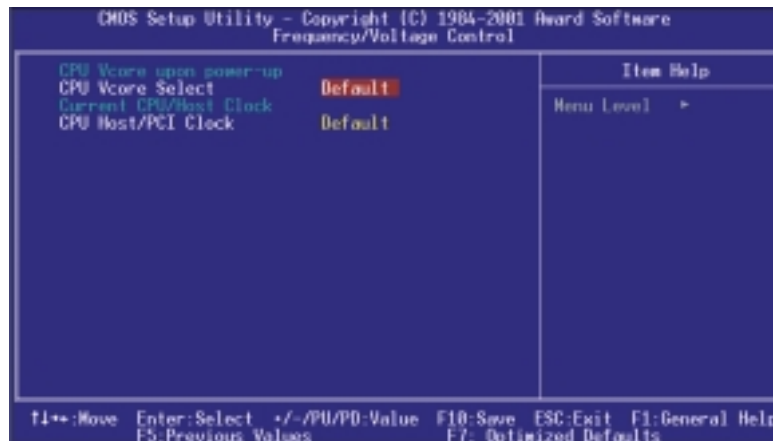

#### CPU Vcore Select

This item allows you to select CPU Vcore.

**The Choices:** Default, +0.025v, +0.050v, +0.075v, +0.100v, +0.125v, +0.150v, +0.175v, +0.200v, +0.225v, +0.250v, +0.275v, -0.025v, -0.050v, -0.075v, -0.100v.

#### CPU Host / PCI Clock

This item allows you to select CPU Host Clock (CPU / PCI).



If unfortunately, the system's frequency that you are selected is not functioning, there are two methods of booting-up the system.

Method 1: Clear the COMS data by setting the JCOMS1 ((2-3) closed)) as "ON" status. All the CMOS data will be loaded as defaults setting.

Method 2: Press the <Insert> key and Power button simultaneously, after that keep-on pressing the <Insert> key until the power-on screen showed. This action will boot-up the system according to FSB of the processor.

※ **It's strongly recommended to set CPU Vcore and clock in default setting. If the CPU Vcore and clock are not in default setting, it may cause CPU or M/B damage.**

### 3. Trouble Shooting

#### **PROBLEM**

No power to the system at all. Power light does not illuminate, fan inside power supply does not turn on. Indicator light on keyboard does not turn on.

<b>PROBABLE CAUSE</b>	<b>DIAGNOSIS</b>	<b>SOLUTION</b>
Power cable is unplugged.	Visually inspect power cable.	Make sure power cable is securely plugged in.
Defective power cable.	Visually inspect the cable; try another cable.	Replace cable.
Power supply failure.	Power cable and wall socket are OK, but system is still dead.	Contact technical support.
Faulty wall outlet; circuit breaker or fuse blown.	Plug in device known to work in socket and test	Use different socket, repair outlet, reset circuit breaker or replace fuse.

#### **PROBLEM**

System inoperative. Keyboard lights are on, power indicator lights are lit, hard drive is spinning.

<b>PROBABLE CAUSE</b>	<b>DIAGNOSIS</b>	<b>SOLUTION</b>
Memory DIMM is partially dislodged from the slot on the motherboard.	Turn off computer. Take cover off system unit. Check the DIMM to ensure it is securely seated in the slot.	Using even pressure on both ends of the DIMM, press down firmly until the module snaps into place.

**PROBLEM**

System does not boot from hard disk drive, can be booted from CD-ROM drive.

<b>PROBABLE CAUSE</b>	<b>DIAGNOSIS</b>	<b>SOLUTION</b>
Connector between hard drive and system board unplugged.	When attempting to run the FDISK utility you get a message, INVALID DRIVE SPECIFICATION.	Check cable running from disk to disk controller board. Make sure both ends are securely plugged in; check the drive type in the standard CMOS setup.
Damaged hard disk or disk controller.	Format hard disk; if unable to do so the hard disk may be defective.	Contact technical support.
Hard disk directory or FAT is scrambled.	Run the FDISK program, format the hard drive. Copy data that was backed up onto hard drive.	Backing up the hard drive is extremely important. All hard disks are capable of breaking down at any time.

**PROBLEM**

System only boots from CD-ROM. Hard disk can be read and applications can be used but booting from hard disk is impossible.

<b>PROBABLE CAUSE</b>	<b>DIAGNOSIS</b>	<b>SOLUTION</b>
Hard Disk boot program has been destroyed.	A number of causes could be behind this.	Back up data and applications files. Reformat the hard drive. Re-install applications and data using backup disks.

**PROBLEM**

Error message reading “SECTOR NOT FOUND” or other error messages not allowing certain data to be retrieved.

<b>PROBABLE CAUSE</b>	<b>DIAGNOSIS</b>	<b>SOLUTION</b>
A number of causes could be behind this.	Use a file by file backup instead of an image backup to backup the hard disk.	Back up any salvageable data. Then low level format, partition, and high level format the hard drive. Re-install all saved data when completed.

**PROBLEM**

Screen message says “Invalid Configuration” or “CMOS Failure.”

<b>PROBABLE CAUSE</b>	<b>DIAGNOSIS</b>	<b>SOLUTION</b>
Incorrect information entered into the configuration (setup) program.	Check the configuration program. Replace any incorrect information.	Review system’s equipment . Make sure correct information is in setup.

**PROBLEM**

Screen is blank.

<b>PROBABLE CAUSE</b>	<b>DIAGNOSIS</b>	<b>SOLUTION</b>
No power to monitor.		Check the power connectors to monitor and to system. Make sure monitor is connected to display card.
Monitor not connected to computer.		See instructions above.

**PROBLEM**

No screen.

<b>PROBABLE CAUSE</b>	<b>DIAGNOSIS</b>	<b>SOLUTION</b>
Memory problem.		Reboot computer. Reinstall memory, make sure that all memory modules are installed in correct sockets.
Computer virus.		Use anti-virus programs to detect and clean viruses.

**PROBLEM**

Screen goes blank periodically.

<b>PROBABLE CAUSE</b>	<b>DIAGNOSIS</b>	<b>SOLUTION</b>
Screen saver is enabled.		Disable screen saver.

**PROBLEM**

Keyboard failure.

<b>PROBABLE CAUSE</b>	<b>DIAGNOSIS</b>	<b>SOLUTION</b>
Keyboard is disconnected.		Reconnect keyboard. Check keys again, if no improvement replace keyboard.

**PROBLEM**

No color on screen.

<b>PROBABLE CAUSE</b>	<b>DIAGNOSIS</b>	<b>SOLUTION</b>
Faulty Monitor.		If possible, connect monitor to another system. If no color replace monitor.
CMOS incorrectly set up.		Call technical support.

**PROBLEM**

C: drive failure.

<b>PROBABLE CAUSE</b>	<b>DIAGNOSIS</b>	<b>SOLUTION</b>
Hard drive cable not connected properly.		Check hard drive cable.

**PROBLEM**

Cannot boot system after installing second hard drive.

<b>PROBABLE CAUSE</b>	<b>DIAGNOSIS</b>	<b>SOLUTION</b>
Master/slave jumpers not set correctly.		Set master/slave jumpers correctly.
Hard drives not compatible / different manufacturers.		Run SETUP program and select correct drive types. Call drive manufacturers for compatibility with other drives.

**PROBLEM**

Missing operating system on hard drive.

<b>PROBABLE CAUSE</b>	<b>DIAGNOSIS</b>	<b>SOLUTION</b>
CMOS setup has been changed.		Run setup and select correct drive type.

**PROBLEM**

Certain keys do not function.

<b>PROBABLE CAUSE</b>	<b>DIAGNOSIS</b>	<b>SOLUTION</b>
Keys jammed or defective.		Replace keyboard.



06/11/2001  
MADE IN TAIWAN  
R.O.C.