

---

## **Federal Communications Commission (F.C.C) Statement**

This device complies with Part 15 of the FCC Rules. Operation of this device is subject to the following two conditions: (1) this device may not cause harmful interference, and (2) this device must accept any interference received, including interference that may cause undesired operation.

Accessories: This device has been tested and found to comply with the limits of a Class B digital device, the accessories associated with this equipment are as follows:

1. Shielded serial cable. (Can be obtained from multiple retail outlets)
2. Shielded printer cable. (Can be obtained from multiple retail outlets)
3. Shielded video cable. (Can be obtained from multiple retail outlets)
4. Shielded power cord. (Provided by manufacturer)

These accessories are required to ensure compliance with FCC Rules. It is the responsibility of the user to provide and use these accessories properly.

This equipment has been tested and found to comply with the limits of a Class B digital device, pursuant to Part 15 of the FCC Rules. These limits are designed to provide reasonable protection against harmful interference in a residential installation. This equipment generates, uses and can radiate radio frequency energy and, if not installed and used in accordance with the instructions, may cause harmful interference to radio communications. There is no guarantee that interference will not occur in a particular installation. If this equipment does cause harmful interference to radio or television reception, which can be determined by turning the equipment off and on, you are encouraged to try to correct the interference by one or more of the following measures:

1. Reorient / relocate the receiving antenna.
2. Increase the separation between the equipment and receiver.
3. Connect the equipment into an outlet on a circuit different from that to which the receiver is connected.
4. Consult the dealer or an experienced radio/TV technician for help.

Caution: Changes or modifications not expressly approved by the

---

---

manufacturer could void the user's authority to operate the equipment.

## **Disclaimer**

The vendor makes no representations or warranties with respect to the contents here of and specially disclaims any implied warranties of merchantability or fitness for any purpose. Further the vendor reserves the right to revise this publication and to make changes to the contents here of without obligation to notify any party beforehand.

Duplication of this publication, in part or in whole, is not allowed without first obtaining the vendor's approval in writing.

## **Trademarks and Remarks**

MS-DOS, Windows NT, Windows 9X, Windows 2000 and Windows ME are products of Microsoft Corp, with its ownership of trademark, and are distributed by the vendor under a license agreement.

All trademarks used in this manual are the property of their respective owners.

Copyright© 2001

All Rights Reserved

## **Canadian D.O.C. Statement**

This digital apparatus does not exceed the Class B limits for radio noise emissions from digital apparatus as set out in the radio interference regulations of the Canadian Department of Communications.

Cet appareil numérique n'émet pas de bruits radioélectriques dépassant les limites appliquées aux appareils numériques de Class B prescrits dans le règlement du brouillage radioélectrique edict par le minister Des Communications du Canada.

---

## **Contents**

---

<b>Introduction .....</b>	<b>1-1</b>
<b>1. Motherboard Description .....</b>	<b>1-2</b>
1.1 Features .....	1-2
1.1.1 Hardware .....	1-2
1.1.2 Software .....	1-6
1.1.3 Attachments .....	1-6
1.2 Motherboard Installation .....	1-7
1.2.1 Layout of Motherboard .....	1-7
1.3 Motherboard Quick Reference .....	1-8
1.3.1 Front Panel Connectors (JPANEL1) .....	1-9
1.3.2 Floppy Disk Connector (FDD1) .....	1-11
1.3.3 Hard Disk Connectors (IDE1/IDE2) .....	1-11
1.3.4 Micro ATX 20-pin Power Conn. (JATXPWR1) .....	1-12
1.4 Back Panel Connectors .....	1-13
1.4.1 PS/2 Mouse / Keyboard CONN.: JKBMS1 .....	1-13
1.4.2 USB Connector: JUSB1 .....	1-14
1.4.3 Monitor Connector: JVGA1 .....	1-15
1.5 Serial and Parallel Interface Ports .....	1-17
1.6 CPU Installation .....	1-22
1.7 Jumper Settings .....	1-23
1.7.1 CPU Fan Connector: JCFAN1 .....	1-24
1.7.2 System Fan Connector: JSFAN1 (Optional) .....	1-24

## **Contents**

---

1.7.3 Wake-On MODEM Header: JWOM1 (Optional) .....	1-24
1.7.4 Wake-On-LAN Header: JWOL1 .....	1-24
1.7.5 CMOS Function Selection: JCMOS1 .....	1-25
1.8 DRAM Installation.....	1-26
1.8.1 DIMM .....	1-26
1.8.2 How to install a DIMM Module.....	1-27
1.9 Audio Subsystem.....	1-28
1.9.1 CD Audio-In Connectors: JCDIN1/JCDIN2 .....	1-29
1.9.2 Telephony Connector: JTAD1 .....	1-29
1.9.3 Front Audio Connector: JAUDIO1 .....	1-30
<b>2. BIOS Setup.....</b>	<b>2-1</b>
2.1 Main Menu.....	2-3
2.2 Standard CMOS Features.....	2-6
2.3 Advanced BIOS Features .....	2-9
2.4 Advanced Chipset Features.....	2-14
2.5 Integrated Peripherals .....	2-17
2.6 Power Management Setup.....	2-22
2.7 PnP/PCI Configurations .....	2-26
2.8 PC Health Status .....	2-30
<b>3. Software Setup .....</b>	<b>3-1</b>
3.1 Software List .....	3-1
3.2 Software Installation .....	3-2

**Contents**

---

3.3 Using Software.....3-4

**4. Trouble Shooting .....4-1**

## Introduction

### System Overview

Thanks for buying this product! This manual was written to help you start using this product as quickly and smoothly as possible. Inside you will find adequate explanations to solve most problems. In order for this reference material to be of greatest use, refer to the “expanded table of contents” to find relevant topics.

This board incorporates the system board, I/O, and PCI IDE into one board that provides a total PC solution. The mainboard, a processor based PC Micro ATX system, supports single processors with PCI Local Bus to support upgrades to your system performance. It is ideal for multi-tasking and fully supports MS-DOS, Windows NT, Windows 2000, Novell, OS/2, Windows95/98, Windows ME, UNIX, SCO UNIX etc. This manual also explains how to install the mainboard for operation, and how to setup your CMOS configuration with the BIOS setup program.

# 1. Motherboard Description

## 1.1 Features

### 1.1.1 Hardware

#### CPU

- Supports the Celeron™ processor (PPGA) and the Pentium® !!! Micro-Processor for high-end workstations and servers.
- CPU Socket 370.
- Runs at 66/100/133 Mhz Front Side Bus frequency.

#### DRAM Memory

- Supports two 8/16/32/64/128/256 MB DIMM module sockets.
- Supports Synchronous DRAM (3.3V).
- Supports a maximum memory size of 512 MB with SDRAM.
- 133Mhz Bus frequency.

#### Internal Accelerated Graphics Port (AGP) Controller

- AGP v1.0 compliant.
- Pipelined split-transaction long-burst transfers up to 533 MB/sec.
- Eight level read request queue.
- Four level posted-write request queue.
- Thirty-two level (quadwords) read data FIFO (128 bytes).
- Sixteen level (quadwords) write data FIFO( 64 bytes).
- Intelligent request reordering for maximum AGP bus utilization.
- Supports Flush /Fence commands.
- Graphics Address Relocation Table (GART).
- One level TLB structure.
- Sixteen entry fully associative page table.
- LRU replacement scheme.
- Independent GART lookup control for host /AGP /PCI master accesses.
- Windows 95 OSR-2 VXD and integrated Windows 98 / NT5 miniport driver support.

**Sophisticated Power Management Features**

- Independent clock stop controls for CPU / SDRAM, Internal AGP and PCI bus.
- PCI and AGP bus clock run and clock generator control.
- Low-leakage I/O pads.

**General Graphic Capabilities**

- 64-bit Single Cycle 2D/3D Graphics Engine.
- Supports 2 to 8 Mbytes of Frame Buffer located in System Memory.
- Real Time DVD MPEG-2 and AC-3 Playback.
- Video Processor.
- I<sup>2</sup>C Serial Interface.
- Integrated 24-bit 230MHz True Color DAC.
- Extended Screen Resolutions up to 1600x1200.
- Extended Text Modes 80 or 132 columns by 25/30/43/60 rows.
- DirectX 6 and OpenGL ICD API.

**High Performance rCADE3D™ Accelerator**

- 32 entry command queue, 32 entry data queue.
- 4Kbyte texture cache with over 90% hit rates.
- Pipelined Single Cycle Setup / Texturing / Rendering Engines.
- DirectDraw™ acceleration.
- Multiple buffering and page flipping.

**Setup Engine**

- 32-bit IEEE floating point input data.
- Slope and vertex calculations.
- Back facing triangle culling.
- 1/16 sub-pixel positioning.

**Rendering Engine**

- High performance single pass execution.
- Diffused and specular lighting.
- Gouraud and flat shading.
- Anti-aliasing including edge, scene, and super-sampling.
- OpenGL compliant blending for fog and depth-cueing.
- 16-bit Z-buffer.



- 8/16/32 bit per pixel color formats.

**Texturing Engine**

- 1/2/4/8-bits per pixel quality non-palletized textures.
- 16/32-bits per pixel quality non-palletized textures.
- Pallet formats in ARGB 565,1555,or 444.
- Tri-linear,bi-linear,and point-sampled filtering.
- Mip-mapping with multiple Level-Of-Detail (LOD) calculations and prespective correction.
- Color keying for translucency.

**2D GUI Engine**

- 8/15/16/24/32-bits per pixel color formats.
- 256 Raster Operations (ROPs).
- Accelerated drawing: BitBLTs,lines,polygons,fills,patterns,clipping,bit masking.
- Panning,scrolling,clipping,color expansion,sprites.
- 32x32 and 64x64 Hardware Cursor.
- DOS graphics and text modes.

**DVD**

- Hardware-Assisted MPEG-2 Architecture for DVD with AC-3.
- Simultaneous motion compensation and front-end processing (parsing,decryption and decode).
- Supports full DVD 1.0,VCD 2.0 and CD-Karaoke.
- Microsoft DirectShow 2.x native support,backward compatible to MCI.
- No additional frame buffer requirements.
- Dynamic frame and field de-interlace filtering for high quality playback on VGA monitors(Bob and Weave).
- Tamper-proof software CSS implementation.
- Freeze,Fast-Forward, Slow Motion, Reverse.
- Pan-and-Scan support for 16:9 Sequence.

**Super I/O Built-in onboard**

- Support one multi-mode Parallel Port.
  - (1) Standard & Bidirection Parallel Port (SPP).
  - (2) Enhanced Parallel Port (EPP).
  - (3) Extended Capabilities Port (ECP).

- Supports one serial port, 16550 UART with 16 byte FIFO.
- UART data rates up to 1.5 Mbaud.
- Supports one Infrared transmission (IR) port.
- Supports PS/2 Mouse.
- Supports 360KB, 720KB, 1.2MB, 1.44MB and 2.88MB floppy disk drives.

**Direct Sound Ready AC97 Digital Audio Controller**

- Dual full-duplex Direct Sound channels between system memory and AC97 link.
- PCI master interface with scatter / gather and bursting capability.
- 32 byte FIFO of each direct sound channel.
- Host based sample rate converter and mixer.
- Standard v1.0 or v2.0 AC97 Codec interface for single or cascaded AC97 Codec's from multiple vendors.
- Loopback capability for re-directing mixed audio streams into USB and 1394 speakers.
- Hardware SoundBlaster Pro for Windows DOS box and real-mode Dos legacy compatibility.
- Plug and play with 4 IRQ, 4 DMA, and 4 I/O space options for SoundBlaster Pro and MIDI hardware.
- Hardware assisted FM synthesis for legacy compatibility.
- Direct two game ports and one MIDI port interface.
- Complete software driver support for Windows 95, Windows 98, Windows NT, Windows 2000 and Windows ME.

**Dimensions (Micro ATX form-factor)**

- 24.38cm x 20cm (WxL)

**Power Management**

- Supports both ACPI (Advanced and Configuration and Power Interface) and legacy (APM) power management.
- ACPI v1.0 Compliant.
- APM v1.2 Compliant.
- CPU clock throttling and clock stop control for complete ACPI C0 to C3 state support.

## **1.1.2 Software**

### **BIOS**

- AWARD legal & user-friendly BIOS.
- Supports PnP functions.

### **Operating Systems**

- Offers the highest performance for MS-DOS, OS/2, Windows NT, Windows 2000, Windows 31 / 95 / 98, Windows ME, Novell, UNIX, SCO UNIT, and others.

## **1.1.3 Attachments**

- HDD Cable.
- FDD Cable.
- USB2 Cable (Optional).
- Rear I/O Panel for Micro ATX Case (Optional).
- CD for sound, VGA, IDE drivers utilities.

## 1.2 Motherboard Installation

### 1.2.1 Layout of Motherboard

#### Model No.M6VLB

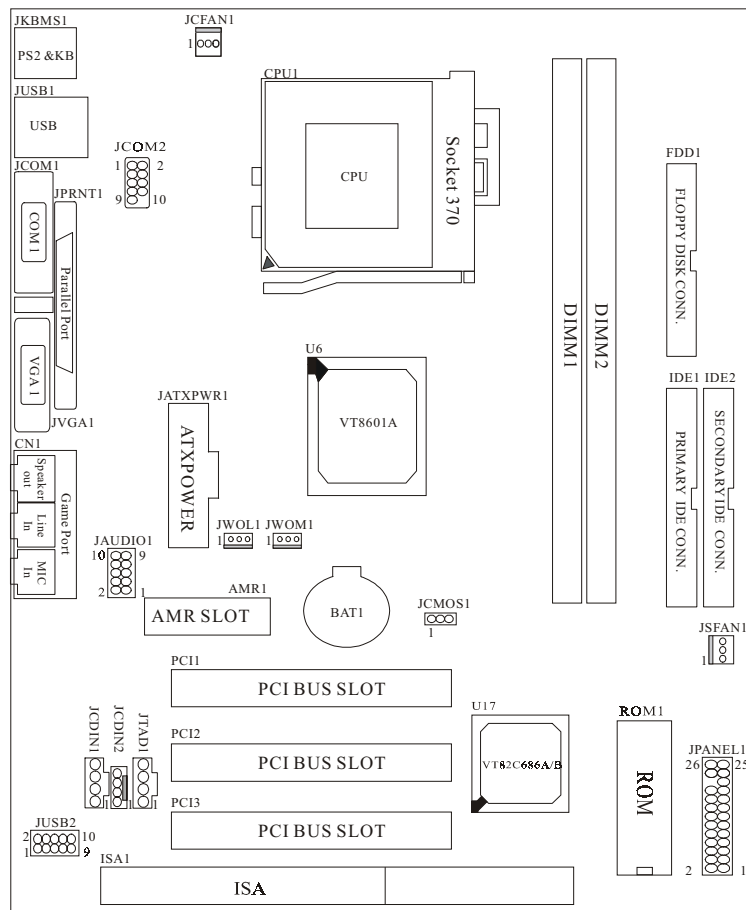

## 1.3 Motherboard Quick Reference

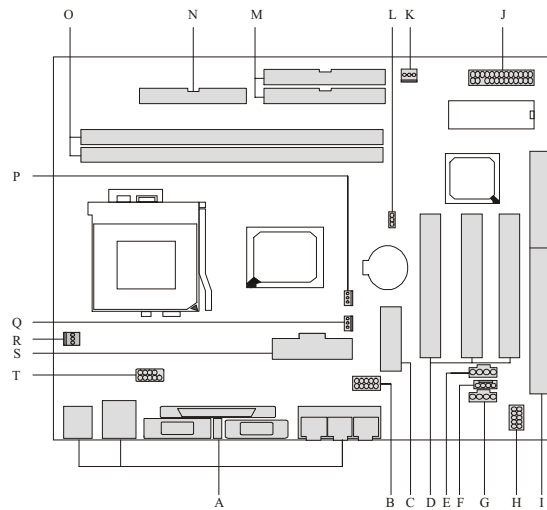

- |   |  |
|---|--|
| <b>A. Back Panel I/O Connectors</b>       | <b>K. System Fan Connector (*JSFAN1)</b>   |
| <b>B. Front Audio Connector (JAUDIO1)</b> | <b>L. CMOS Function Selection (JCMOS1)</b> |
| <b>C. AMR Connecetor (AMR1)</b>           | <b>M. IDE Connectors (IDE1-2)</b>          |
| <b>D. PCI BUS Slots (PCI1-3)</b>          | <b>N. FDD Connector (FDD1)</b>             |
| <b>E. Telephony Connector (JTAD1)</b>     | <b>O. DIMMs (DIMM1-2)</b>                  |
| <b>F. CD Audio-In Connector (JCDIN2)</b>  | <b>P. Wake-On MODEM Header (*JWOM1)</b>    |
| <b>G. CD Audio-In Connector (JCDIN1)</b>  | <b>Q. Wake-On-LAN Header (JWOL1)</b>       |
| <b>H. Front USB Connector (JUSB2)</b>     | <b>R. CPU Fan Connector (JCFAN1)</b>       |
| <b>I. ISA Bus Slot (ISA1)</b>             | <b>S. Micro ATX Power Conn. (JATXPWR1)</b> |
| <b>J. Front Panel Connector (JPANEL1)</b> | <b>T. 2x5 Header (*JCOM2)</b>              |

NOTE: The “\*” mark represent the function is optional.

### 1.3.1 Front Panel Connectors (JPANEL1)

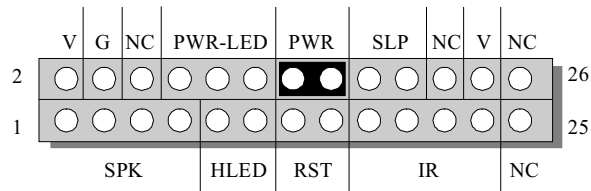

Pin No.	Assignment	Function	Pin No.	Assignment	Function
1	Speaker	Speaker Connector	2	+5V	VCC
3	NC		4	Ground	Ground
5	Ground		6	NC	NC
7	+5V		8	Power LED(+)	Power LED
9	HDD LED(+)	10	Power LED(+)		
11	HDD LED(-)	12	Power LED(-)		
13	Ground	Reset Button	14	Power Button	Micro ATX Power Button
15	Reset Switch		16	Ground	
17	VCC	IrDA Connector	18	Sleep Switch	SLP
19	IRRX		20	Ground	
21	Ground		22	NC	NC
23	IRTX		24	+5V	VCC
25	NC	NC	26	NC	NC

**Speaker Connector**

An offboard speaker can be installed on the motherboard as a manufacturing option. An offboard speaker can be connected to the motherboard at the front panel connector. The speaker (onboard or offboard) provides error beep code information during the Power On Self-Test when the computer cannot use the video interface. The speaker is not connected to the audio subsystem and does not receive output from the audio subsystem.

**Reset Button**

This connector can be connected to a momentary SPST type switch that is normally open. When the switch is closed, the motherboard resets and runs the POST.

**Power LED Connector**

This connector can be connected to an LED that will light when the computer is powered on.

**Hard Drive LED Connector**

This connector can be connected to an LED to provide a visual indicator that data is being read from or written to a hard drive. For the LED to function properly, an IDE drive must be connected to the onboard hard drive controller.

**Infrared Connector**

After the IrDA interface is configured, files can be transferred from or to portable devices such as laptops, PDAs, and printers using application software.

**Sleep Button**

When APM is enabled in the system BIOS, and the operating system's APM driver is loaded, the system can enter sleep (standby) mode in one of the following ways:

- **Optional front panel SMI button**
- **Prolonged system inactivity using the BIOS inactivity timer feature**

The 2-pin header located on the front panel I/O connector supports a front panel SMI switch, which must be a momentary SPST type that is normally open.

Closing the SMI switch sends a System Management Interrupt (SMI) to the processor, which immediately goes into System Management Mode (SMM). While the computer is in sleep mode it is fully capable of responding to and servicing external interrupts (such as an incoming fax) even though the monitor turns on only if a keyboard or mouse interrupt occurs. To reactivate or resume the system, the SMI switch must be pressed again, or the keyboard or mouse must be used.

**Power On Button**

This connector can be connected to a front panel power switch. The switch must pull the Power Button pin to ground for at least 50 ms to signal the power supply to switch on or off. (The time requirement is due to internal debounce circuitry on the motherboard). At least two seconds must pass before the power supply will recognize another on/off signal.

**1.3.2 Floppy Disk Connector (FDD1)**

The motherboard provides a standard floppy disk connector (FDC) that supports 360K, 720K, 1.2M, 1.44M and 2.88M floppy disk types. This connector supports the provided floppy drive ribbon cables.

**1.3.3 Hard Disk Connectors (IDE1/IDE2)**

The motherboard has a 32-bit Enhanced PCI IDE Controller that provides PIO Mode 0~4, Bus Master, and Ultra DMA / 33, Ultra DMA / 66, Ultra DMA / 100 (optional) functionality. It has two HDD connectors IDE1 (primary) and IDE2 (secondary). You can connect up to four hard disk drives, a CD-ROM, a 120MB Floppy (reserved for future BIOS) and other devices to IDE1 and IDE2. These connectors support the IDE hard disk cable provided.

- **IDE1 (Primary IDE Connector)**

The first hard drive should always be connected to IDE1. IDE1 can connect a Master and a Slave drive. You must configure the second hard drive on IDE1 to Slave mode by setting the jumper accordingly.

- **IDE2 (Secondary IDE Connector)**

The IDE2 controller can also support a Master and a Slave drive. The configuration is similar to IDE1. The second drive on this controller must be set to slave mode.



### 1.3.4 Micro ATX 20-pin Power Conn. (JATXPWR1)

This connector supports the power button on-board. Using the Micro ATX power supply, functions such as Modem Ring Wake-Up and Soft Power Off are supported on this motherboard. This power connector supports instant power-on functionality, which means that the system will boot up instantly when the power connector is inserted on the board.

Pin No.	Assignment	Pin No.	Assignment
1	+3.3V	11	+3.3V
2	+3.3V	12	-12V
3	Ground	13	Ground
4	+5V	14	PS_ON
5	Ground	15	Ground
6	+5V	16	Ground
7	Ground	17	Ground
8	PW_OK	18	-5V
9	5V_SB	19	+5V
10	+12V	20	+5V

*Warning: Since the motherboard has the instant power on function, make sure that all components are installed properly before inserting the power connector to ensure that no damage will be done.*

## 1.4 Back Panel Connectors

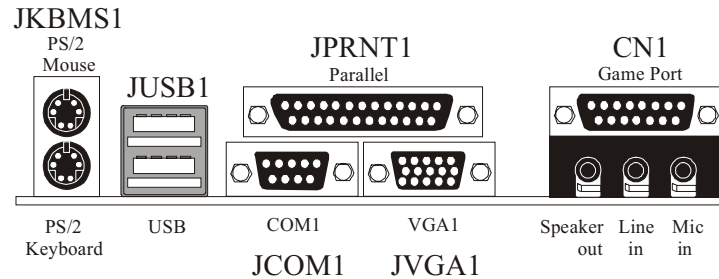

### 1.4.1 PS/2 Mouse / Keyboard CONN.: JKBMS1

The motherboard provides a standard PS/2 mouse / Keyboard mini DIN connector for attaching a PS/2 mouse. You can plug a PS/2 mouse / Keyboard directly into this connector. The connector location and pin definition are shown below:

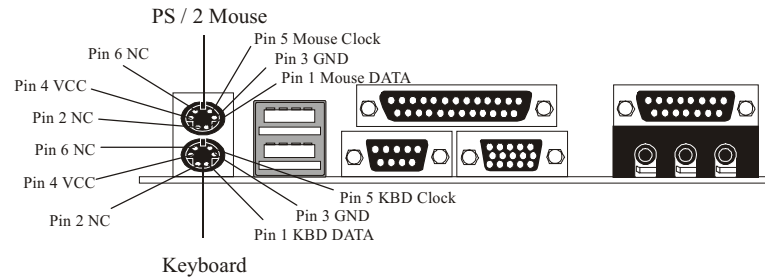

**PS/2 Mouse / Keyboard Connector**

Pin No.	Signal Name
1	Data
2	No connection
3	Ground
4	+5 V (fused)
5	Clock
6	No connection

**1.4.2 USB Connector: JUSB1**

The motherboard provides a **OHCI (Open Host Controller Interface) Universal Serial Bus Roots** for attaching USB devices such as: keyboard, mouse and other USB device.

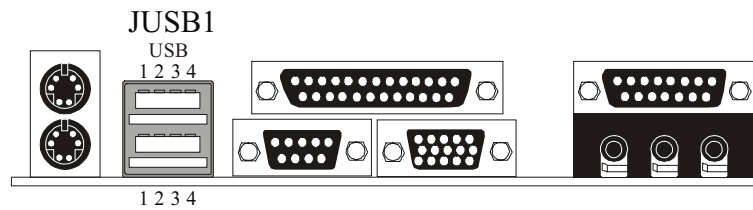
**Stacked USB Connector**

Pin No.	Assignment
1	+5 V (fused)
2	USBP0- [USBP1-]
3	USBP0+ [USBP1+]
4	Ground

Signal names in brackets ([ ]) are for USB Port 1.

### 1.4.3 Monitor Connector: JVGA1

This motherboard has built in video facilities. Your monitor will attach directly to JVGA1 connector on the motherboard.

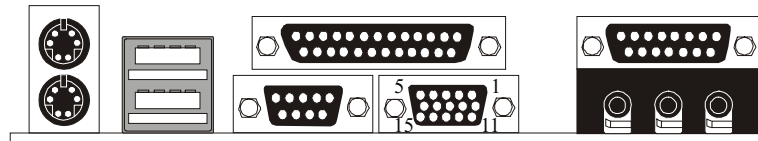

JVGA1

Pin No.	Assignment	Pin No.	Assignment
1	Red	2	Green
3	Blue	4	+5V
5	Ground	6	Ground
7	Ground	8	Ground
9	+5V	10	Ground
11	+5V	12	DDC/Data
13	HSYNC	14	VSYNC
15	DDC/CLK		

### 1.4.4 Front USB Connector: JUSB2

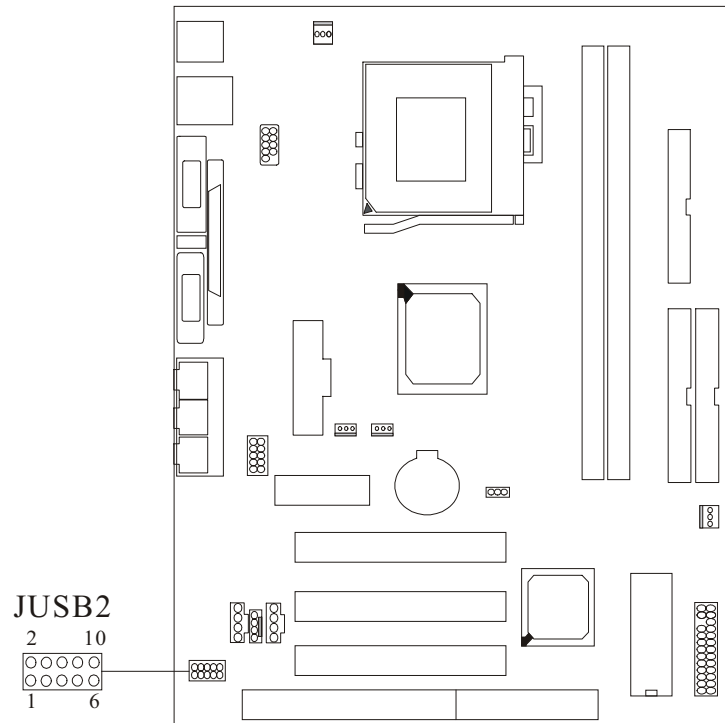

Pin No.	Signal Name	Pin No.	Signal Name
1	+5V	2	Ground
3	USBP2-	4	Ground
5	USBP2+	6	USBP3+
7	Ground	8	USBP3-
9	Ground	10	+5V

## 1.5 Serial and Parallel Interface Ports

This system comes equipped with two serial ports and one parallel port. Both types of interface ports will be explained in this chapter.

### The Serial Interface: JCOM1

The serial interface port is sometimes referred to as an RS-232 port or an asynchronous communication port. Mice, printers, modems and other peripheral devices can be connected to a serial port. The serial port can also be used to connect your computer with another computer system. If you wish to transfer the contents of your hard disk to another system it can be accomplished by using each machine's serial port.

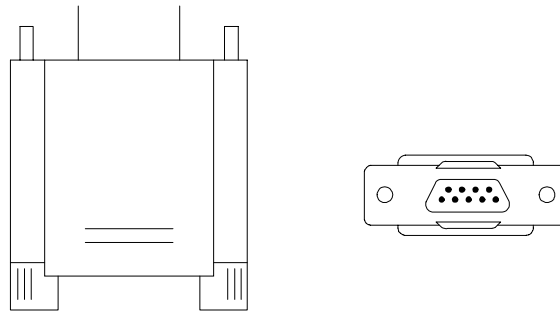

The serial port on this system has one 9-pin connector. Some older computer systems and peripherals used to be equipped with only one 25-pin connector. Should you need to connect your 9-pin serial port to an older 25-pin serial port, you can purchase a 9-to-25 pin adapter.

**Connectivity**

The serial port can be used in many ways, and it may be necessary to become familiar with the pinout diagram. The following chart gives you the function of each pin on the 9-pin connector and some of the 25-pin connector. This information can be used when configuring certain software programs to work with the serial port.

<b>Signal</b>	<b>Name</b>	<b>DB9 PIN</b>	<b>DB25 PIN</b>
DCD	Data Carrier Detect	1	8
RX	Receive Data	2	3
TX	Transmit Data	3	2
DTR	Data Terminal Ready	4	20
GND	Signal Ground	5	7
DSR	Data Set Ready	6	6
RTS	Request to Send	7	4
CTS	Clear to Send	8	5
RI	Ring Indicator	9	22

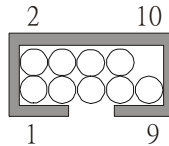
**The Serial Interface Port-II : JCOM2 (Optional)**

Signal	Name	IDC PIN
DCD	Data Carrier Detect	1
RX	Receive Data	2
TX	Transmit Data	3
DTR	Data Terminal Ready	4
GND	Signal Ground	5
DSR	Data Set Ready	6
RTS	Request to Send	7
CTS	Clear to Send	8
RI	Ring Indicator	9

**Special Applications**

There are two types of serial devices that can be connected to a serial port. One of the devices is called "DTE" (Data Terminal Equipment) and the other device is called "DCE" (Data Communications Equipment). If a modem is connected to a computer, for example, the modem is called the DCE and the computer is called the DTE. In situations such as this, the pins on the serial ports can be connected straight through.

In instances when there are two DTE devices connected together, such as a computer and a printer, a special adapter called a "Null Modem" is needed to make communication between the two devices possible.

When using the serial port to communicate between devices, one problem in particular may arise. Some manufacturers use one set of signals to begin communication with another device and other manufacturers do not use these



signals to initiate communication. If you encounter a communication problem that cannot be resolved using a null modem, it can generally be assumed that one device is using the initialization signals and the other device is not. This can usually be resolved by wiring the RTS, CTS, and DCD pins together.

### Serial Ports/COM Ports

The two serial ports on the computer are called JCOM1 and JCOM2, respectively. If you wish, two more serial ports can be added onto the computer using optional hardware. Should you choose to add the extra Serial ports (COM ports) they would be called COM3 and COM4.

When using serial ports to communicate with a peripheral device, be sure to assign only one COM port number to each device. For example, if a printer and a scanner are both connected to your computer through serial ports, the printer must be assigned one COM port (i.e. COM1) and the scanner must be assigned the other COM port (i.e. COM2). No two devices can be assigned to one COM port. Each peripheral must have its own COM port.

**NOTE: Two serial ports may be installed on the computer. However, no more than two ports can be used simultaneously.**

\*If you have installed an internal modem, be careful not to assign a COM port number that has already been assigned to another device. This error is common.

When installing a device that is going to require the use of a serial port, use a diagnostic program to find out which ports are available. It may be necessary to remove expansion cards that have serial ports in order to check their jumper settings. The jumper settings will indicate which COM port the card has been assigned. Checking the expansion card will eliminate mistakes in overlapping COM ports. Once you have completed the installation of peripheral devices using the serial ports, be sure that the communication parameters such as baud rate, parity bit, etc. are matching. If your computer is set for a baud rate of 9600 and your modem is set for a baud rate of 2400 you will not be able to send messages. The manuals that accompany the peripheral devices will inform you on the procedure for setting their parameters. Software manuals also have instructions on setting parameters.

### Parallel Interface Port : JPRNT1

Unlike the serial port, parallel interface port has been standardized and should not present any difficulty interfacing peripherals to your system. Sometimes called Centronics port, the parallel port is almost exclusively used with printers. The parallel port on your system has a 25-pin, DB25 connector (see picture below). The pinouts for the parallel port are shown in the table below.

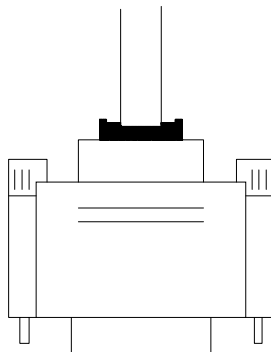
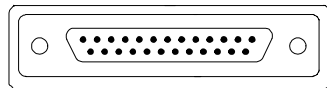

Signal	Pin
-Strobe	1
Data 0	2
Data 1	3
Data 2	4
Data 3	5
Data 4	6
Data 5	7
Data 6	8
Data 7	9
-Ack	10
Busy	11
Paper Empty	12
+Select	13
-Auto FDXT	14
-Error	15
-Init	16
-SLCTN	17
Ground	18
Ground	19
Ground	20
Ground	21
Ground	22
Ground	23
Ground	24
Ground	25

## 1.6 CPU Installation

### CPU Installation Procedure: Socket 370

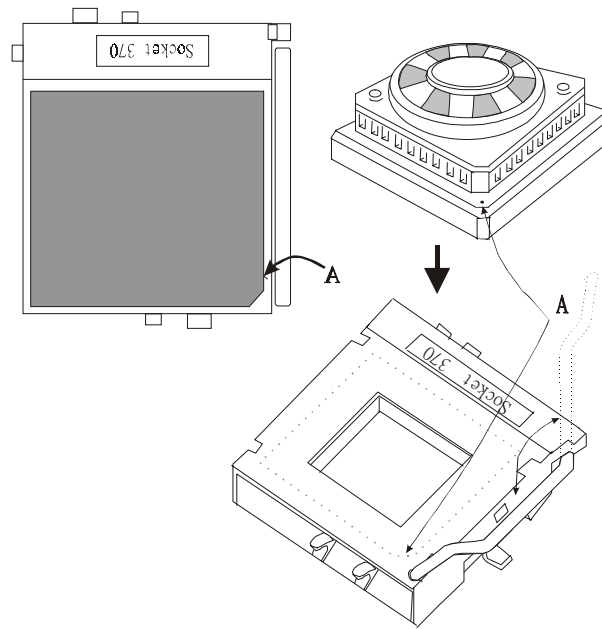

1. Pull the lever sideways away from the socket then raise the lever up to a 90-degree angle.
2. Locate Pin A in the socket and look for the white dot or cut edge in the CPU. Match Pin A with the white dot/cut edge then insert the CPU.
3. Press the lever down to complete the installation.

## 1.7 Jumper Settings

A jumper has two or more pins that can be covered by a plastic jumper cap, allowing you to select different system options.

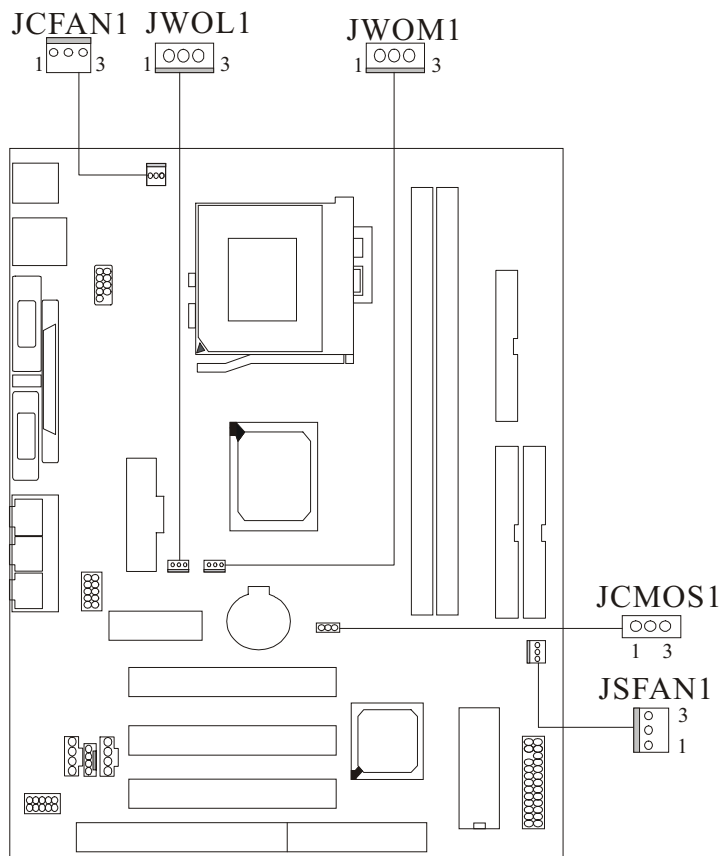

**1.7.1 CPU Fan Connector: JCFAN1**

Pin No.	Assignment
1	Sensor
2	+12V
3	Ground

**1.7.2 System Fan Connector: JSFAN1 (Optional)**

Pin No.	Assignment
1	Sensor
2	+12V
3	Ground

**1.7.3 Wake-On MODEM Header: JWOM1 (Optional)**



Pin No.	Assignment
1	5V_SB
2	Ground
3	Wake-Up

**1.7.4 Wake-On-LAN Header: JWOL1**

Pin No.	Assignment
1	5V_SB
2	Ground
3	Wake-up

### 1.7.5 CMOS Function Selection: JCMOS1

This jumper is set during the process of clearing BIOS configurations which may be necessary in certain circumstances (i.e. forgotten BIOS passwords)

JCMOS1	Assignment
 1-2 Closed	Normal Operation (default)
 2-3 Closed	Clear CMOS Data



The following procedures are for resetting the BIOS password. It is important to follow these instructions closely.

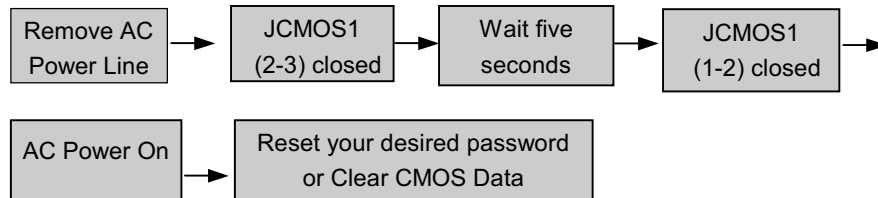

## 1.8 DRAM Installation

### 1.8.1 DIMM

DRAM Access Time : 3.3V Unbuffered SDRAM PC66/ PC100 and PC133 Type required.

DRAM Type : 8MB/ 16MB/ 32MB/ 64MB/ 128MB/ 256MB DIMM Module (168pin)

<b>Total Memory Size (MB)</b>	<b>Bank 0 DIMM1</b>	<b>Bank 1 DIMM2</b>
<b>16 M</b>	<b>8M x 1 pc</b>	<b>8M x 1 pc</b>
<b>32 M</b>	<b>16M x 1 pc</b>	<b>16M x 1 pc</b>
<b>64 M</b>	<b>32M x 1 pc</b>	<b>32M x 1 pc</b>
<b>128 M</b>	<b>64M x 1 pc</b>	<b>64M x 1 pc</b>
<b>256 M</b>	<b>128M x 1 pc</b>	<b>128M x 1 pc</b>
<b>512 M</b>	<b>256M x 1 pc</b>	<b>256M x 1 pc</b>

\*The list shown above for DRAM configuration is only for reference.

## 1.8.2 How to install a DIMM Module

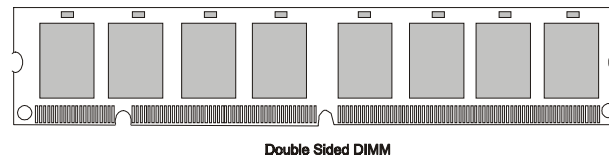
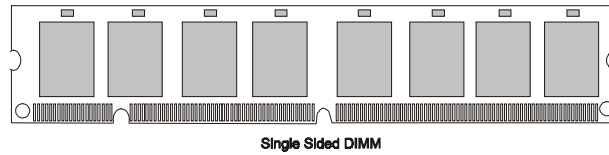

1. The DIMM socket has a “ Plastic Safety Tab” and the DIMM memory module has an asymmetrical notch”, so the DIMM memory module can only fit into the slot in one direction.

2. Push the tabs out. Insert the DIMM memory modules into the socket at a 90-degree angle then push down vertically so that it will fit into place.

3. The Mounting Holes and plastic tabs should fit over the edge and hold the DIMM memory modules in place.

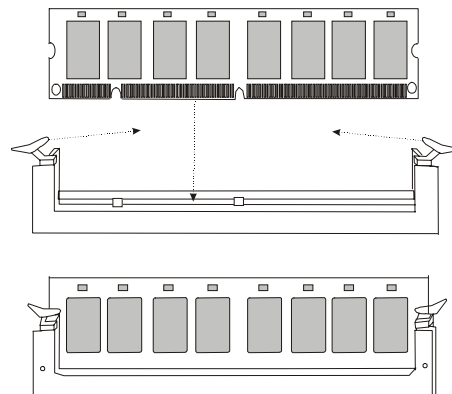



# 1.9 Audio Subsystem

Model No.M6VLB

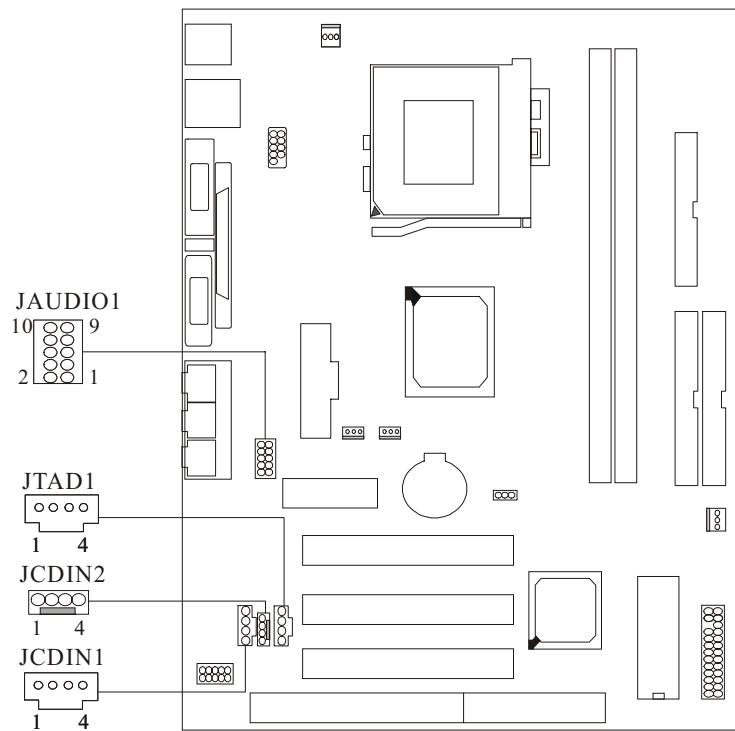

**1.9.1 CD Audio-In Connectors: JCDIN1/JCDIN2**

Pin No. of JCDIN1	Assignment
1	Right Channel Input
2	Ground
3	Ground
4	Left Channel Input

Pin No. of JCDIN2	Assignment
1	Right Channel Input
2	Ground
3	Left Channel Input
4	Ground

**1.9.2 Telephony Connector: JTAD1**

Pin No.	TAD
1	MONO_IN
2	Ground
3	Ground
4	MONO_OUT

**1.9.3 Front Audio Connector: JAUDIO1**

<b>Pin No.</b>	<b>Signal Name</b>
1	AUD_MIC
2	AUD_GND
3	AUD_MIC_BIAS
4	AUD_VCC
5	AUD_FPOUT_R
6	AUD_RET_R
7	HP_ON
8	KEY
9	AUD_FPOUT_L
10	AUD_RET_L

## 2. BIOS Setup

### Introduction

This manual discussed Award™ Setup program built into the ROM BIOS. The Setup program allows users to modify the basic system configuration. This special information is then stored in battery-backed RAM so that it retains the Setup information when the power is turned off.

The Award BIOS™ installed in your computer system's ROM (Read Only Memory) is a custom version of an industry standard BIOS. This means that it supports Intel processors in a standard input/output system. The BIOS provides critical low-level support for standard devices such as disk drives and serial and parallel ports.

Adding important has customized the Award BIOS™, but nonstandard, features such as virus and password protection as well as special support for detailed fine-tuning of the chipset controlling the entire system.

The rest of this manual is intended to guide you through the process of configuring your system using Setup.

### Plug and Play Support

These AWARD BIOS supports the Plug and Play Version 1.0A specification. ESCD (Extended System Configuration Data) write is supported.

### EPA Green PC Support

This AWARD BIOS supports Version 1.03 of the EPA Green PC specification.

### APM Support

These AWARD BIOS supports Version 1.1&1.2 of the Advanced Power Management (APM) specification. Power management features are implemented via the System Management Interrupt (SMI). Sleep and Suspend power management modes are supported. Power to the hard disk drives and video monitors can be managed by this AWARD BIOS.

### PCI Bus Support

This AWARD BIOS also supports Version 2.1 of the Intel PCI (Peripheral Component Interconnect) local bus specification.

### DRAM Support

SDRAM (Synchronous DRAM) are supported.

### Supported CPUs

This AWARD BIOS supports a single Intel Pentium<sup>®</sup> !!! & Celeron<sup>™</sup> CPU.

### Using Setup

In general, you use the arrow keys to highlight items, press <Enter> to select, use the <PgUp> and <PgDn> keys to change entries, press <F1> for help and press <Esc> to quit. The following table provides more detail about how to navigate in the Setup program by using the keyboard.

Keystroke	Function
Up arrow	Move to previous item
Down arrow	Move to next item
Left arrow	Move to the item on the left (menu bar)
Right arrow	Move to the item on the right (menu bar)
Esc	Main Menu: Quit without saving changes Submenus: Exit Current page to the next higher level menu
Move Enter	Move to the item you desired
PgUp key	Increase the numeric value or make changes
PgDn key	Decrease the numeric value or make changes
+ Key	Increase the numeric value or make changes
- Key	Decrease the numeric value or make changes
Esc key	Main Menu – Quit and not save changes into CMOS Status Page Setup Menu and Option Page Setup Menu – Exit Current page and return to Main Menu
F1 key	General help on Setup navigation keys
F5 key	Load previous values from CMOS
F6 key	Load the fail-safe defaults from BIOS default table
F7 key	Load the optimized defaults
F10 key	Save all the CMOS changes and exit

## 2.1 Main Menu

Once you enter AWARD BIOS CMOS Setup Utility, the Main Menu (**Figure 1**) will appear on the screen. The Main Menu allows you to select an item and press <Enter> to accept or enter its sub-menu.

**!! WARNING !!**

The information about BIOS defaults on manual (**Figure 1,2,3,4,5,6,7,8**) is just for reference, please refer to the BIOS installed on board for update information

**Figure 1. Main Menu**

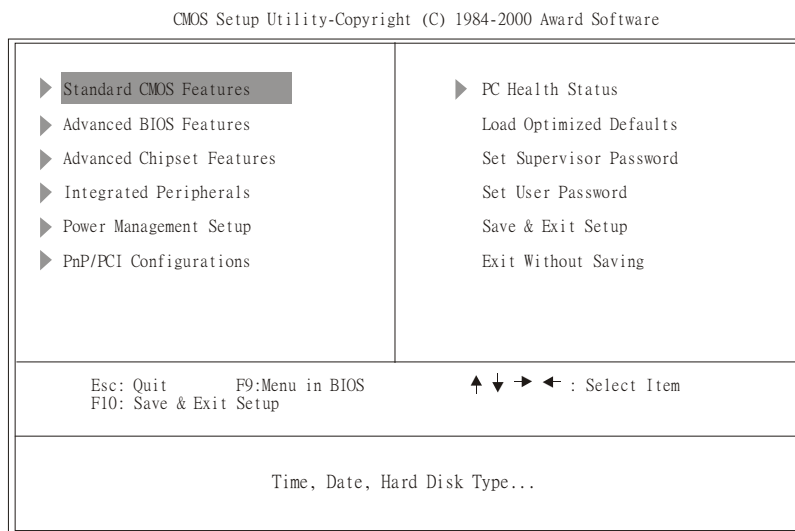

### Standard CMOS Features

This setup page includes all the items in a standard compatible BIOS.

### Advanced BIOS Features

This setup page includes all the items for the BIOS special enhanced features.

**Advanced Chipset Features**

This setup page includes all the items of chipset special features.

**Integrated Peripherals**

This section page includes all the items of IDE hard drive and Programmed Input/Output features.

**Power Management Setup**

This setup page includes all the items for power management features.

**PnP / PCI Configuration**

This category specifies the value (in units of PCI bus clocks) of the latency timer for this PCI bus master and the IRQ level for PCI device.

**PC Health Status**

This setup page is the System auto detect Temperature, voltage, fan speed.

**Load Optimized Defaults**

These settings are more likely to configure a workable computer when something is wrong. If you cannot boot the computer successfully, select the BIOS Setup options and try to diagnose the problem after the computer boots. These settings do not provide optimal performance.

Load Optimized Defaults (Y/N)?N

**Set Supervisor Password**

Change, set, or disable password. It allows you to limit access to the system and Setup, or just to Setup.

Enter Password:

**Set User Password**

You can specify both a User and Supervisor password. When you select either password option, you are prompted for a 1-8 character password. Enter the password and then retype the password when prompted.

```
Enter Password:
```

**Save & Exit Setup**

Save CMOS value changes to CMOS and exit setup.

```
SAVE to CMOS and EXIT (Y/N)? Y
```

**Exit Without Saving**

Abandon all CMOS value changes and exit setup.

```
Quit without Saving (Y/N)? N
```





**Main Menu Selections**

This table shows the selections that you can make on the Main Menu.

<b>Item</b>	<b>Options</b>	<b>Description</b>
Date	MM DD YYYY	Set the system date. Note That the 'Day' automatically changes when you set the date.
IDE Primary Master	Options are in its sub menu.	Press <Enter> to enter the sub menu of detailed options
IDE Primary Slave	Options are in its sub menu.	Press <Enter> to enter the sub menu of detailed options.
IDE Secondary Master	Options are in its sub menu.	Press <Enter> to enter the sub menu of detailed options.
IDE Secondary Slave	Options are in its sub menu.	Press <Enter> to enter the sub menu of detailed options.
Drive A Drive B	None 360K, 5.25 in 1.2M, 5.25 in 720K, 3.5 in 1.44M, 3.5 in 2.88M, 3.5 in	Select the type of floppy disk drive installed in your system.
Video	EGA/VGA CGA 40 CGA 80 MONO	Select the default video device.

---

<b>Item</b>	<b>Options</b>	<b>Description</b>
Halt On	All Errors No Errors All, but Keyboard All, but Diskette All, but Disk/Key	Select the situation in which you want the BIOS to stop the POST process and notify you.
Base Memory	N/A	Displays the amount of conventional memory detected during boot up.
Extended Memory	N/A	Displays the amount of extended memory detected during boot up.
Total Memory	N/A	Display the total memory available in the system.

## 2.3 Advanced BIOS Features

Figure 3. Advanced BIOS Features

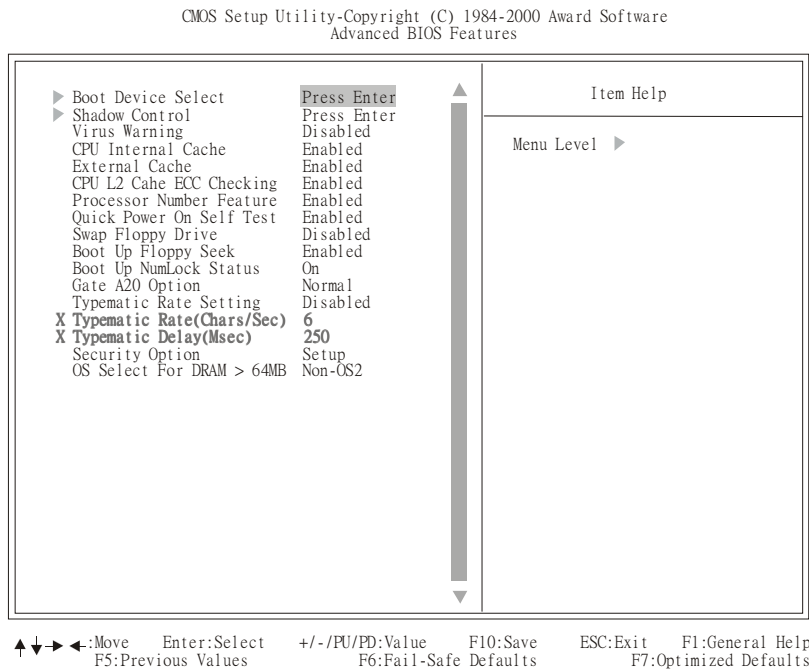

### Boot Device Select

These BIOS attempts to load the operating system from the devices in the sequence selected in these items.

#### **First/Second/Third Boot Device**

**The Choices:** Floppy, LS120, HDD-0, SCSI, CDROM, HDD-1, HDD-2, HDD-3, ZIP100, LAN, Disabled

#### **Boot Other Device**

**The Choices:** Enabled (default), Disabled.

**Shadow Control**

If you highlight the literal “Press Enter” next to the “Shadow Control” label and then press the enter key, it will take you a submenu with the following options:

**Video BIOS Shadow**

Determines whether video BIOS will be copied to RAM for faster execution.

**Enabled** (default)      Optional ROM is shadowed.  
Disabled                    Optional ROM is not shadowed.

**C8000 - CFFFF Shadow / D0000 - DFFFF Shadow**

Determines whether the optional ROM will be copied to RAM for faster execution.

Enabled                    Optional ROM is shadowed.  
**Disabled** (default)      Optional ROM is not shadowed.

**Note :** For C8000 - DFFFF option - ROM on PCI BIOS, BIOS will automatically enable the shadow RAM. User does not have to select the item.

**Virus Warning**

This category flashes on the screen. During and after the system boot up, any attempt to write to the boot sector or partition table of the hard disk drive will halt the system and an error message will appear. In the mean time, you can run an anti-virus program to locate the problem.

**Disabled** (default)      No warning message will appear when any attempts are made to access the boot sector or hard disk partition table.  
  
Enabled                    Activates automatically when the system boots up causing a warning message to appear when anything attempts to access the boot sector of hard disk partition table.

**CPU Internal Cache**

These fields allow you to Enabled or Disable the CPU Internal Cache. Caching allow better performance.

**Enabled** (default)      Enable cache  
Disabled                    Disable cache

**External Cache**

These fields allow you to Enable or Disable the CPU's "Level 2" secondary cache. Caching allows better performance.

<b>Enabled</b> (default)	Enable cache
Disabled	Disable cache

**CPU L2 Cache ECC Checking**

This item allows you to enable/disable CPU L2 Cache ECC checking.

**The Choices:** **Enabled** (default), Disabled.

**Processor Number Feature**

The Intel processor serial number control option.

**The Choices:** **Enabled** (default), Disabled.

**Quick Power On Self Test**

Select Enabled to reduce the amount of time required to run the power-on self-test (POST). A quick POST skips certain steps. We recommend that you normally disable quick POST. Better to find a problem during POST than lose data during your work.

<b>Enabled</b> (default)	Enable quick POST
Disabled	Normal POST

**Swap Floppy Drive**

Switches the floppy disk drive between being designated as A and B. Default is **Disabled**.

**Boot Up Floppy Seek**

During POST, BIOS will determine if the floppy disk drive installed is 40 or 80 tracks. 360K type is 40 tracks while 720K, 1.2M, and 1.44M are all 80 tracks.

<b>Enabled</b> (default)	BIOS searches for the floppy disk drive to determine if it is 40 or 80 tracks. Note that BIOS cannot tell from 720K, 1.2M or 1.44M drive type as they are all 80 tracks.
Disabled	BIOS will not search for the type of floppy disk drive by track number. Note that there will not be any warning message if the drive installed is 360K.

**Boot Up NumLock Status**

<b>On</b> (default)	Numpad is number keys.
Off	Numpad is arrow keys.

**Gate A20 Option**

Gate A20 refers to the way the system address memory above 1 MB (extended memory). When set Fast, the system chipset controls Gate A20. When set to Normal, a pin in the Keyboard controller controls Gate A20. Setting Gate A20 to Fast improves system speed, particularly with OS/2 and Windows.

**Normal** (default)

**Typematic Rate Setting**

This determines the typematic rate.

Enabled	Enable typematic rate and typematic delay programming.
---------	--

<b>Disabled</b> (default)	Disable typematic rate and typematic delay programming. The system BIOS will use default value and the keyboard controls the function.
---------------------------	--

**Typematic Rate (Chars/Sec)**

<b>6</b> (default)	6 characters per second
8	8 characters per second
10	10 characters per second
12	12 characters per second
15	15 characters per second
20	20 characters per second
24	24 characters per second
30	30 characters per second

**Typematic Delay (Msec)**

Choose the length of delay from the time you press a key and the character repeating. (units are mil-sec)

**The Choices: 250** (default), 500, 750, 1000.

**Security Option**

This category allows you to limit access to the system and Setup, or just to Setup.

System

The system will not boot and access to Setup will be denied if the correct password is not entered at the prompt.

**Setup (default)**

The system will boot, but access to Setup will be denied if the correct password is not entered at the prompt.

**OS Select for DRAM > 64MB**

Allows OS/2 to be used with > 64MB of DRAM. Settings are Non-OS/2 and OS/2. Set to OS/2 if using more than 64MB and running OS/2.

**Default is Non-OS2.**



## 2.4 Advanced Chipset Features

This section allows you to configure the system based on the specific features of the installed chipset. This chipset manages bus speeds and access to system memory resources, such as DRAM and the external cache. It also coordinates communications between the conventional PCI bus. It must be stated that these items should never need to be altered. The default settings have been chosen because they provide the best operating conditions for your system. The only time you might consider making any changes would be if you discovered that data was being lost which using your system.

**Figure 4. Advanced Chipset Feature**

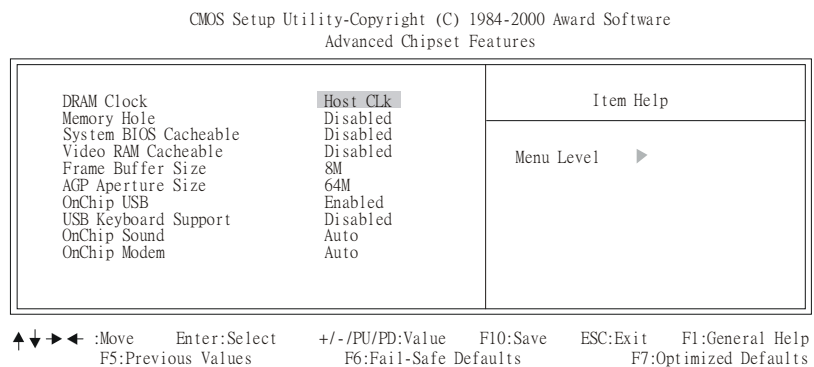

### DRAM Clock

When synchronous DRAM is installed, the number of clock cycles of CAS latency depends on the DRAM timing.

**The Choices:** Host CLK (default), HCLK-33M, By SPD.

### Memory Hole

When enabled, you can reserve an area of system memory for ISA adapter ROM. When this area is reserved, it cannot be cached. Refer to the user documentation of the peripheral you are installing for more information.

**The Choices:** Disabled (default), 15M-16M.

**System BIOS Cacheable**

Selecting the “Enabled” option allows caching of the system BIOS ROM at F0000h-FFFFFh which can improve system performance. However, any programs writing to this area of memory may cause conflicts and result in system errors.

**The Choices:** Disabled (default), Enabled

**Video RAM Cacheable**

Enabling this option allows caching of the video RAM, resulting in better system performance. However, if any program writes to this memory area, a system error may result.

**The Choices:** Disabled (default), Enabled.

**Frame Buffer Size**

This item allows you to control the VGA frame buffer size.

**The Choices:** 8M (default), 4M, 2M.

**AGP Aperture Size**

Select the size of the Accelerated Graphics Port (AGP) aperture. The aperture is a portion of the PCI memory address range dedicated for graphics memory address space. Host cycles that hit the aperture range are forwarded to the AGP without any translation.

**The Choices:** 64M (default), 32M, 16M, 8M, 4M, 128M.

**OnChip USB**

This should be enabled if your system has a USB installed on the system board and you wish to use it. Even when so equipped, if you add a higher performance controller, you will need to disable this feature.

**The Choices:** Enabled (default), Disabled.

**USB Keyboard Support**

Select Enabled if your system contains a Universal Serial Bus (USB) controller and you have an USB keyboard.

**The Choices:** Enabled, Disabled (default).

**OnChip Sound**

The default setting of this item utilizes an onboard sound chip for audio output. There is no need to buy and insert a sound card. If sound card is installed, disable this item.

**The Choices:** Auto (default), Disabled.

**OnChip Modem**

This item allows you to control the onboard MC97 Modem controller.

**The Choices:** Auto (default), Disabled.

## 2.5 Integrated Peripherals

Figure 5. Integrated Peripherals

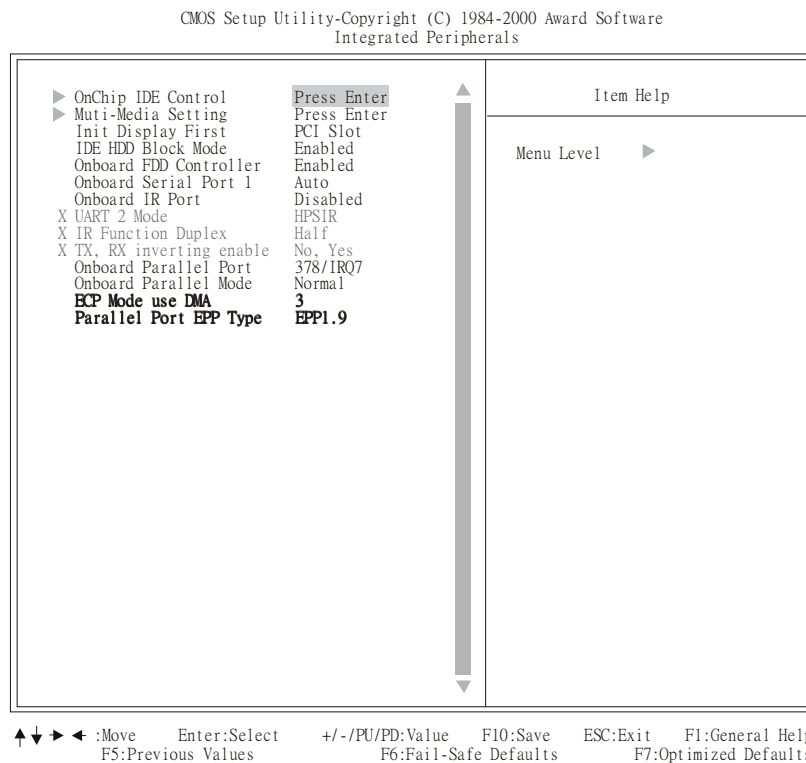

### OnChip IDE Control

The chipset contains a PCI IDE interface with support for two IDE channels. Select “Enabled” to activate the first and/or second IDE interface. Select “Disabled” to deactivate an interface, if you install a primary and/or secondary add-in IDE interface. If you highlight the literal “Press Enter” next to the “Onchip IDE Control” label and then press the enter key, it will take you a submenu with the following options:

**OnChip IDE Channel 0**

The chipset contains a PCI IDE interface with support for two IDE channels. Select Enabled to activate the primary IDE interface. Select Disabled to deactivate this interface.

**The Choices:** Enabled (default), Disabled.

**OnChip IDE Channel 1**

The chipset contains a PCI IDE interface with support for two IDE channels. Select Enabled to activate the secondary IDE interface. Select Disabled to deactivate this interface.

**The Choices:** Enabled (default), Disabled.

**IDE Prefetch Mode**

The onboard IDE drive interfaces supports IDE prefetching, for faster drive access. If you install a primary and/or secondary add-in IDE interface, set this field to Disabled if the interface does not support prefetching.

**The Choices:** Enabled (default), Disabled.

**Primary/Secondary Master/Slave PIO**

The four IDE PIO (Programmed Input/Output) fields lets you set a PIO mode(0-4) for each of the IDE devices that the onboard IDE interface supports. Modes 0 through 4 provide successively increased performance. In Auto mode, the system automatically determines the best mode for each device.

**The Choices:** Auto (default), Mode0, Mode1, Mode2, Mode3, Mode4.

**Primary/Secondary Master/Slave UDMA**

Ultra DMA/66 implementation is possible only if your IDE hard drive supports it and the operating environment includes a DMA driver (Windows 98 OSR2 or a third-party IDE bus master driver). If your hard drive and your system software both support Ultra DMA/66, select Auto to enable BIOS support.

**The Choices:** Auto (default), Disabled.

**IDE HDD Block Mode**

Block mode is also called block transfer, multiple commands, or multiple sector read/write. If your IDE hard drive supports block mode (most new drives do), select Enabled for automatic detection of the optimal number of block read/writes per sector the drive can

support.

**The Choices:** Enabled (default), Disabled.

### **Muti-Media setting**

The multimedia setting submenu is used to configure various multimedia peripherals such as audio and game equipment. If you highlight the literal “Press Enter” next to the “Muti-Media setting” label and then press the enter key, it will take you a submenu with the following options:

#### **Onboard Legacy Audio**

The field controls the onboard legacy audio.

**The Choices:** Enabled (default), Disabled.

#### **Sound Blaster**

Hardware SoundBlaster Pro for Windows DOS box and real-mode DOS legacy compatibility.

**The Choices:** Enabled, Disabled (default).

#### **SB I/O Base Address**

Change the SoundBlaster Pro Base I/O Address settings.

**The Choices:** 220H(default), 240H, 260H, 280H.

#### **SB IRQ Select**

Change the SoundBlaster Pro interrupt signal.

**The Choices:** IRQ5(default), IRQ7, IRQ9, IRQ10.

#### **SB DMA Select**

Change the SoundBlaster Pro direct memory access setting.

**The Choices:** DMA0, DMA1 (default), DMA2, DMA3.

#### **MPU-401**

Enable or Disable MPU-401 function.

**The Choices:** Enabled (default), Disabled.

#### **MPU-401 I/O Address**

Change the SoundBlaster Pro MPU-401 I/O address.

**The Choices:** 300-303H, 310-313H, 320-323H, 330-333H (default).

#### **Game Port (200-207H)**

Change the joystick connect port address.

**The Choices:** Enabled (default), Disabled.

**Init Display First**

This item allows you decide to active whether PCI Slot or on-chip VGA first.

**The Choices:** **PCI Slot** (default), AGP.

**IDE HDD Block Mode**

Block mode is also called block transfer, multiple commands, or multiple sector read/write. If your IDE hard drive supports block mode (most new drives do), select Enabled for automatic detection of the optimal number of block mode (most new drives do), select Enabled for automatic detection of the optimal number of block read/writes per sector the drive can support.

**The Choices:** **Enabled** (default), Disabled

**Onboard FDD Controller**

Select Enabled if your system has a floppy disk controller (FDD) installed on the system board and you wish to use it. If install and FDD or the system has no floppy drive, select Disabled in this field.

**The Choices:** **Enabled** (default), Disabled.

**Onboard Serial Port 1**

Select an address and corresponding interrupt for the first serial port.

**The Choices:** **Auto** (default), 3F8/IRQ4, 2F8/IRQ3, 3E8/IRQ4, 2E8/IRQ3, Disabled.

**Onboard IR Port**

Select IR Address.

**The Choices:** Auto, 3F8/IRQ4, 2F8/IRQ3, 3E8/IRQ4, 2E8/IRQ3, **Disabled** (default).

**UART 2 Mode**

This item allows you to determine which Infrared (IR) function onboard I/O chip.

**The Choices:** **HPSIR** (default), ASKIR.

**IR Function Duplex**

This item allows you to decide to active IR transmission delay.

**The Choices:** **Half** (default), Full.

**Tx, Rx inverting enable**

This item allows you to determine the active of Rx,Tx.

**The Choices:** **No/Yes** (default), No/No, Yes/No, Yes/Yes.

**Onboard Parallel Port**

This item allows you to determine access onboard parallel controller with which I/O Address.

**The Choices:** 378/IRQ7 (default), 278/IRQ5, Disabled, 3BC/IRQ7.

**Onboard Parallel Mode**

Select an operating mode for the onboard parallel (printer) port. Normal EPP (Enhanced Parallel Port) ECP (Extend Capabilities Port) ECP+EPP PC AT parallel port Bidirectional Port Fast, buffered port Fast, buffered, Bidirectional Port. Select Normal unless you are certain your hardware and software both support EPP or ECP mode.

**The Choices:** Normal (default), EPP, ECP, ECP/EPP.

**ECP Mode Use DMA**

Select a DMA Channel for the port.

**The Choices:** 3 (default), 1.

**Parallel Port EPP Type**

This option allows you to select a DMA Channel for the parallel port.

**The Choices:** EPP1.9 (default), EPP1.7.





**Power Management**

<b>User Define</b> (default)	Users can configure their own power management.
Min Saving	Pre-defined timer values are used such that all timers are at their MAX value.
Max Saving	Pre-defined timer values are used such that all timers are at their MIN value.

**PM Control by APM**

No	System BIOS will ignore APM when Power Management is on.
<b>Yes</b> (default)	System BIOS will wait for ROM's prompt before it enters any PM mode.

**Video Off Option**

This determines the manner in which the monitor is blanked.

<b>Suspend</b> -> <b>Off</b> (default)	During Suspend mode, the monitor will be Turned off.
All Mode -> Off	During All modes, the monitor will be turn off.
Always On	During Always mode, the monitor will be Turn on.

**Video Off Method**

<b>V/H SYNC+Blank</b> (default)	In addition to the above, BIOS will also turn off the V-SYNC & H-SYNC signals from VGA card to monitor.
DPMS supported	This function is enabled only for a VGA card supporting DPMS.
Blank Screen	The system BIOS will only blank the screen when disabling video.

**MODEM Use IRQ**

This determines the IRQ, which the MODEM can use.

**3** (default)  
4 / 5 / 7 / 9 / 10 / 11 / NA

**Soft-Off by PWRBTN**

Pressing the power button for more than 4 seconds forces the system to enter the Soft-Off states when the system has "hung".

**The Choices:**, **Instant-Off** (default), Delay 4 Sec.

**Wake Up Events**

If you highlight the literal “ Press Enter” next to the “Wake Up Events” label and then press the enter key, it will take you a submenu with the following options:

<b>VGA</b>	When set to on, any event occurring at a VGA port will awaken a system which has been powered down. <b>The Choices:</b> <b>Off</b> (default), On.
<b>LPT&amp;COM</b>	When set to <b>On</b> , any event occurring at a LPT/COM Port will awaken a system which has been powered down. <b>The Choices:</b> <b>LPT/COM (default)</b> , COM, , LPT, NONE.
<b>HDD&amp;FDD</b>	When set to On(default), any event occurring at a hard or floppy drive will awaken a system which has been powered down. <b>The Choices:</b> <b>On</b> (default), Off.
<b>PCI MASTER</b>	When set to On, any event occurring at PCI will awaken a system which has been powered down. <b>The Choices:</b> <b>Off</b> (default), On.
<b>Wake Up On LAN/Ring</b>	To use this function, you need a LAN add-on card which support power on function. It should also support the wake-up on LAN jump. <b>The Choices:</b> <b>Disabled</b> (default),Enabled.
<b>RTC Alarm Resume</b>	When “Enabled”, you can set the date and time at which the RTC (real-time clock) alarm awakens the system from Suspend mode. <b>The Choices:</b> <b>Disabled</b> (default),Enabled.
<b>Date (of Month)</b>	You can choose which month the system will boot up.

**Resume Time (hh: mm: ss)**

You can choose the hour, minute and second the system will boot up.

**IRQs Activity Monitoring**

When set to ON (default), any event occurring at Primary INTR will awaken a system which has been powered down.

The following is a list of IRQ, Inter ReQuest, which can be exempted such as the COM ports and LPT ports above can. When an I/P device wants to gain the attention of the operating system, it signals this by causing an IRQ to occur. When the operating system is ready to respond to the request, it interrupts itself and performs the services.

As above, the choices are On and Off. Off is the default.

When set On, activity will neither prevent the system from going into a power management mode nor awaken it.

**Primary INTR**

<b>IRQ3</b>	<b>(COM2)</b>
<b>IRQ4</b>	<b>(COM1)</b>
<b>IRQ5</b>	<b>(LPT2)</b>
<b>IRQ6</b>	<b>(Floppy Disk)</b>
<b>IRQ7</b>	<b>(LPT1)</b>
<b>IRQ8</b>	<b>(RTC Alarm)</b>
<b>IRQ9</b>	<b>(IRQ2 Redir)</b>
<b>IRQ10</b>	<b>(Reserved)</b>
<b>IRQ11</b>	<b>(Reserved)</b>
<b>IRQ12</b>	<b>(PS2/Mouse)</b>
<b>IRQ13</b>	<b>(Coprocessor)</b>
<b>IRQ14</b>	<b>(Hard Disk)</b>
<b>IRQ15</b>	<b>(Reserved)</b>



**Reset Configuration Data**

The system BIOS supports the PnP feature so the system needs to record which resource is assigned and protect resources from conflicts. Every peripheral device has a node which is called ESCD. This node records which resources are assigned to it. The system needs to record and update ESCD to the memory locations. These locations (4K) are reserved at the system BIOS.

If Disabled (default) is chosen, the system's ESCD will update only when the new configuration varies from the last one.

If Enabled is chosen, the system is forced to update ESCDs and then is automatically set to the "Disabled" mode.

IRQ-3	assigned to : PCI / ISA PnP
IRQ-4	assigned to : PCI / ISA PnP
IRQ-5	assigned to : PCI / ISA PnP
IRQ-7	assigned to : PCI / ISA PnP
IRQ-9	assigned to : PCI / ISA PnP
IRQ-10	assigned to : PCI / ISA PnP
IRQ-11	assigned to : PCI / ISA PnP
IRQ-12	assigned to : PCI / ISA PnP
IRQ-14	assigned to : PCI / ISA PnP
IRQ-15	assigned to : PCI / ISA PnP
DMA-0	assigned to : PCI / ISA PnP
DMA-1	assigned to : PCI / ISA PnP
DMA-3	assigned to : PCI / ISA PnP
DMA-5	assigned to : PCI / ISA PnP
DMA-6	assigned to : PCI / ISA PnP
DMA-7	assigned to : PCI / ISA PnP

The above settings will be shown on the screen only if "Manual" is chosen for the Resources Controlled By function.

Legacy is the term which signifies that a resource is assigned to the ISA Bus and provides for non PnP ISA add-on cards. PCI / ISA PnP signifies that a resource is assigned to the PCI Bus or provides for ISA PnP add-on cards and peripherals.

**The Choices:** Disabled (default), Enabled

**Resources Controlled By**

By Choosing “Auto (ESCD)” the system BIOS will detect the system resources and automatically assign the relative IRQ and DMA channel for each peripheral.

By Choosing “Manual”, the user will need to assign IRQ & DMA for add-on cards. Be sure that there are no IRQ/DMA and I/O port conflicts.

**The Choices: Auto(ESCD)** (default), Manual.

**IRQ Resources**

When resources are controlled manually, assign each system interrupt a type, depending on the type of device using the interrupt.

**DMA Resources**

When you press the “Press Enter” tag, you will be directed to a submenu that will allow you to make configuration changes the system DMA channels. This is only configurable when “Resources Controlled By” is set to “Manual”.

When resources are controlled manually, assign each system DMA channel a type, depending on the type on device using the DMA channel.

**PCI/VGA Palette Snoop**

Some graphic controllers which are not VGA compatible take the output from a VGA controller and map it to their display as a way to provide boot information and VGA compatibility.

However, the color information coming from the VGA controller is drawn from the palette table inside the VGA controller to generate the proper colors and the graphic controller needs to know what is in the palette of the VGA controller. To do this, the non-VGA graphic controller watches for Write access to the VGA palette and registers the snoop data. In PCI based systems, where the VGA controller is on the PCI bus and a non-VGA graphic controller is on an ISA bus, the Write Access to the palette will not show up on the ISA bus if the PCI VGA controller responds to the Write.

In this case, the PCI VGA controller should not respond to the Write. It should only snoop the data and permit the access to be forwarded to the ISA bus. The non-VGA ISA graphic controller can then snoop the data on the ISA bus. Unless you have the above situation, you should disable this option.

<b>Disabled</b> (default)	Disables the function.
Enabled	Enables the function.

**Assign IRQ For USB**

Lets the user choose which IRQ to assign for USB.

**Assign IRQ For VGA**

Lets the user choose which IRQ to assign for the VGA.





## 3. Software Setup

**NOTE: The mark \* means it can be installed directly from CD by using CD Installation Utility ( i.e. SETUP.EXE).**

### 3.1 Software List

Category	Description	Platform	Location in CD
VIA Service Pack (4 In 1) *	VIA 4 In 1 driver includes (VIA Registry (ACPI) Driver /VIA AGP VxD driver /VIA ATAPI Vendor Support Driver /VIA PCI IRQ Miniport Driver) four system drivers to improve the performance and maintain the stability of system using VIA chipset.	Windows 95/98/NT4/ME/2000	\Driver\Chipset\ Via\Service
VIA Hardware Monitor *	VIA Hardware Monitor is a self-diagnostic system for PC.	Windows 95/98/NT4/ME/2000	\Driver\Chipset\ Via\Sysdiag
Award Flash Utility	Used for updating BIOS. (Please refer to chapter - Application Software.)	Need to be run under DOS environment.	\Software\Firmware
VIA AC97 Audio * (Option)	Install the driver to enable the VIA AC97 Audio Device	Windows 95/98/NT4/ME/2000	\Driver\Audio\ Via686
Creative SB Audio * (Option)	Install the driver to enable the Creative PCI128 Audio Device	Windows 95/98/NT4/ME/2000	\Driver\Audio\ Creative
VIA (VT8601) Display drivers	Install the driver to enable the Trident video On-chip Device.	Windows 95/98/NT4/ME/2000	\Driver\Chipset\ Via\VGA\8601
Microsoft DCOM *	Install the MicroSoft Distributed Component Object Model (Dcom) server for Windows O.S.	Windows 95/98	\Software\DCOM
Microsoft DirectX 8.0 *	Microsoft DirectX runtime library	Windows 95/98/ME/2000	\Software\DirectX

## 3.2 Software Installation

We provide an installation wizard, Driver CD Installation Utility (SETUP.EXE), located in the root of Driver CD to let users install some common used drivers conveniently.

The Wizard can automatically detect OS and switch to the proper page, so you don't need to worry about installing the wrong drivers.

You can simply put Driver CD into CD-ROM drive and the Installation Utility will autorun or you can launch the Driver CD Installation Utility manually.



**There are two kinds of Installation Procedure:****➤ Automatically Install drivers from CD by using CD Installation Utility:**

Use the mouse cursor to click the proper option on the page. Utility will invoke other applications to complete the rest of installation.

**➤ When the drivers CAN NOT be installed directly from CD by using CD Installation Utility, please do the following procedure :**

Please read the README.TXT located in the root directory on Driver CD to get the driver's location and then refer to the INSTALL.TXT or README.TXT files located in each driver's directory on the Driver CD to install drivers

### 3.3 Using Software

- In general, you can get more detailed information in the on-line help or readme for the softwares.
- **Using VIA Hardware Monitor**  
After the utility is installed, you can follow the sequence, **Start**→ **Programs** → **VIA HM** → **VIA Hardware Monitor** , to launch the monitor application.

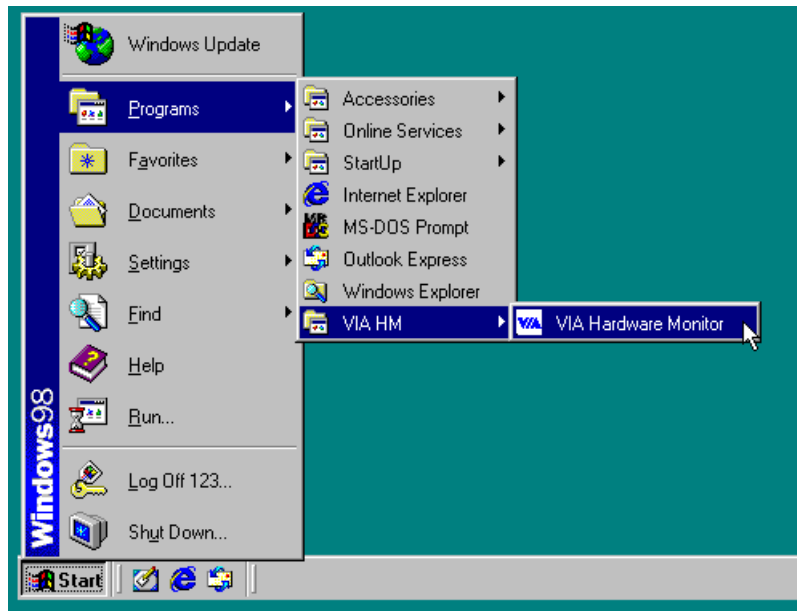

The following figure is the main panel of VIA Hardware Monitor. In the panel, you can get some real-time and important information -- Voltage, Fan speed, and temperature, for example. If there is an abnormal situation, you can resolve it immediately.

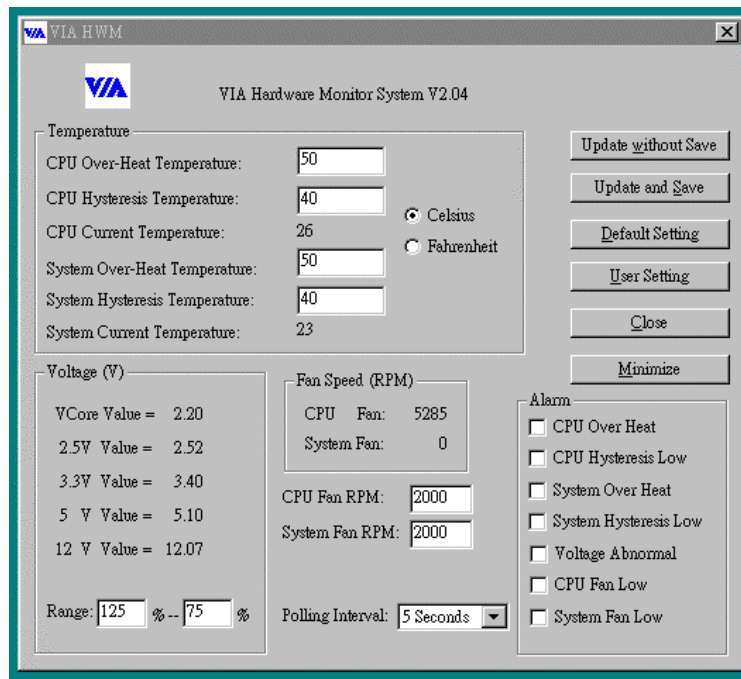

## 4. Trouble Shooting

### **PROBLEM**

No power to the system at all. Power light does not illuminate, fan inside power supply does not turn on. Indicator light on keyboard does not turn on.

<b>PROBABLE CAUSE</b>	<b>DIAGNOSIS</b>	<b>SOLUTION</b>
Power cable is unplugged.	Visually inspect power cable.	Make sure power cable is securely plugged in.
Defective power cable.	Visually inspect the cable; try another cable.	Replace cable.
Power supply failure.	Power cable and wall socket are OK, but system is still dead.	Contact technical support.
Faulty wall outlet; circuit breaker or fuse blown.	Plug in device known to work in socket and test	Use different socket, repair outlet, reset circuit breaker or replace fuse.

### **PROBLEM**

System inoperative. Keyboard lights are on, power indicator lights are lit, hard drive is spinning.

<b>PROBABLE CAUSE</b>	<b>DIAGNOSIS</b>	<b>SOLUTION</b>
Memory DIMM is partially dislodged from the slot on the motherboard.	Turn off computer. Take cover off system unit. Check the DIMM to ensure it is securely seated in the slot.	Using even pressure on both ends of the DIMM, press down firmly until the module snaps into place.

**PROBLEM**

System does not boot from hard disk drive, can be booted from CD-ROM drive.

<b>PROBABLE CAUSE</b>	<b>DIAGNOSIS</b>	<b>SOLUTION</b>
Connector between hard drive and system board unplugged.	When attempting to run the FDISK utility you get a message, INVALID DRIVE SPECIFICATION.	Check cable running from disk to disk controller board. Make sure both ends are securely plugged in; check the drive type in the standard CMOS setup.
Damaged hard disk or disk controller.	Format hard disk; if unable to do so the hard disk may be defective.	Contact technical support.
Hard disk directory or FAT is scrambled.	Run the FDISK program, format the hard drive. Copy data that was backed up onto hard drive.	Backing up the hard drive is extremely important. All hard disks are capable of breaking down at any time.

**PROBLEM**

System only boots from CD-ROM. Hard disk can be read and applications can be used but booting from hard disk is impossible.

<b>PROBABLE CAUSE</b>	<b>DIAGNOSIS</b>	<b>SOLUTION</b>
Hard Disk boot program has been destroyed.	A number of causes could be behind this.	Back up data and applications files. Reformat the hard drive. Re-install applications and data using backup disks.



**PROBLEM**

Error message reading “SECTOR NOT FOUND” or other error messages not allowing certain data to be retrieved.

<b>PROBABLE CAUSE</b>	<b>DIAGNOSIS</b>	<b>SOLUTION</b>
A number of causes could be behind this.	Use a file by file backup instead of an image backup to backup the hard disk.	Back up any salvageable data. Then low level format, partition, and high level format the hard drive. Re-install all saved data when completed.

**PROBLEM**

Screen message says “Invalid Configuration” or “CMOS Failure.”

<b>PROBABLE CAUSE</b>	<b>DIAGNOSIS</b>	<b>SOLUTION</b>
Incorrect information entered into the configuration (setup) program.	Check the configuration program. Replace any incorrect information.	Review system's equipment . Make sure correct information is in setup.

**PROBLEM**

Screen is blank.

<b>PROBABLE CAUSE</b>	<b>DIAGNOSIS</b>	<b>SOLUTION</b>
No power to monitor.		Check the power connectors to monitor and to system. Make sure monitor is connected to display card.
Monitor not connected to computer.		See instructions above.

**PROBLEM**

<b>PROBABLE CAUSE</b>	<b>DIAGNOSIS</b>	<b>SOLUTION</b>
Memory problem.		Reboot computer. Reinstall memory, make sure that all memory modules are installed in correct sockets.
Computer virus.		Use anti-virus programs to detect and clean viruses.

**PROBLEM**

Screen goes blank periodically.

<b>PROBABLE CAUSE</b>	<b>DIAGNOSIS</b>	<b>SOLUTION</b>
Screen saver is enabled.		Disable screen saver.

**PROBLEM**

Keyboard failure.

<b>PROBABLE CAUSE</b>	<b>DIAGNOSIS</b>	<b>SOLUTION</b>
Keyboard is disconnected.		Reconnect keyboard. Check keys again, if no improvement replace keyboard.

**PROBLEM**

No color on screen.

<b>PROBABLE CAUSE</b>	<b>DIAGNOSIS</b>	<b>SOLUTION</b>
Faulty Monitor.		If possible, connect monitor to another system. If no color replace monitor.
CMOS incorrectly set up.		Call technical support.

**PROBLEM**

C: drive failure.

<b>PROBABLE CAUSE</b>	<b>DIAGNOSIS</b>	<b>SOLUTION</b>
Hard drive cable not connected properly.		Check hard drive cable.

**PROBLEM**

Cannot boot system after installing second hard drive.

<b>PROBABLE CAUSE</b>	<b>DIAGNOSIS</b>	<b>SOLUTION</b>
Master/slave jumpers not set correctly.		Set master/slave jumpers correctly.
Hard drives not compatible / different manufacturers.		Run SETUP program and select correct drive types. Call drive manufacturers for compatibility with other drives.

**PROBLEM**

Missing operating system on hard drive.

<b>PROBABLE CAUSE</b>	<b>DIAGNOSIS</b>	<b>SOLUTION</b>
CMOS setup has been changed.		Run setup and select correct drive type.

**PROBLEM**

Certain keys do not function.

<b>PROBABLE CAUSE</b>	<b>DIAGNOSIS</b>	<b>SOLUTION</b>
Keys jammed or defective.		Replace keyboard.

**PROBLEM**

Keyboard is locked, and no keys function.

<b>PROBABLE CAUSE</b>	<b>DIAGNOSIS</b>	<b>SOLUTION</b>
Keyboard is locked.		Unlock keyboard.

01/16/2001  
MADE IN TAIWAN  
R.O.C.