Federal Communications Commission (F.C.C) Statement

This device complies with Part 15 of the FCC Rules. Operation of this device is subject to the following two conditions: (1) this device may not cause harmful interference, and (2) this device must accept any interference received, including interference that may cause undesired operation.

Accessories: This device has been tested and found to comply with the limits of a Class B digital device, the accessories associated with this equipment are as follows:

1. Shielded serial cable. (Can be obtained from multiple retail outlets)
2. Shielded printer cable. (Can be obtained from multiple retail outlets)
3. Shielded video cable. (Can be obtained from multiple retail outlets)
4. Shielded power cord. (Provided by manufacturer)

These accessories are required to be used in order to ensure compliance with FCC Rules. It is the responsibility of the user to provide and use these accessories properly.

This equipment has been tested and found to comply with the limits of a Class B digital device, pursuant to Part 15 of the FCC Rules. These limits are designed to provide reasonable protection against harmful interference in a residential installation. This equipment generates, uses and can radiate radio frequency energy and, if not installed and used in accordance with the instructions, may cause harmful interference to radio communications. However, there is no guarantee that interference will not occur in a particular installation. If this equipment does cause harmful interference to radio or television reception, which can be determined by turning the equipment off and on, the user is encouraged to try to correct the interference by one or more of the following measures:

1. Reorient / Relocate the receiving antenna.
 2. Increase the separation between the equipment and receiver.
 3. Connect the equipment into an outlet on a circuit different from that to which the receiver is connected.
-

4. Consult the dealer or an experienced radio/TV technician for help.

Caution: Changes or modifications not expressly approved by the manufacturer could void the user's authority to operate the equipment.

Disclaimer

The Vendor makes no representations or warranties with respect to the contents here of and specially disclaims any implied warranties of merchantability or fitness for any purpose. Further the Vendor reserves the right to revise this publication and to make changes from time to time in the contents here of without obligation to notify any party beforehand. Duplication of this publication, in part or in whole, is not allowed without first obtaining the Vendor's approval in writing.

Trademarks and Remarks

MS-DOS, Windows, Windows NT, and Windows 9x are products of Microsoft Corp, with its ownership of trademark, and are distributed by the Vendor under a license agreement.

All trademarks used in this manual are the property of their respective owners.

Copyright(C) 1992
All Rights Reserved

Canadian D.O.C. Statement

This digital apparatus does not exceed the Class B limits for radio noise emissions from digital apparatus as set out in the radio interference regulations of the Canadian Department of Communications.

Cet appareil numérique n'émet pas de bruits radioélectriques dépassant les limites appliqués aux appareils numériques de Class B prescrits dans le règlement du brouillage radioélectrique édicté par le ministère Des Communications du Canada.

Introduction	1-1
1 Motherboard Description	1-2
1.1 Features	1-2
1.1.1 Hardware	1-2
1.1.2 Software	1-6
1.1.3 Attachments	1-6
1.2 Motherboard Installation	1-7
1.2.1 Layout of Motherboard	1-7
1.3 Motherboard Connectors	1-8
1.3.1 Front Panel Connectors : PANEL1	1-9
1.3.2 ATX 20-pin Power Connector : POWER1	1-11
1.3.3 Hard Disk Connectors : IDE1 / IDE2	1-12
1.3.4 Floppy Disk Connector : FDD1	1-12
1.4 Back Panel Connectors	1-13
1.4.1 PS/2 Mouse / Keyboard Connector : CN1	1-13
1.4.2 USB Connectors : USB1	1-14
1.5 Serial and Parallel Interface Ports	1-15
1.6 CPU Installation	1-19
1.6.1 CPU Installation Procedure : Socket 370	1-19
1.6.2 CPU Installation Procedure : Slot 1	1-20
1.6.3 CPU Frequency Selection : JP1	1-24
1.6.4 Socket 370 & Slot 1 Selection : J2	1-25

1.6.5 CPU Fan connector : J6.....	1-25
1.6.6 CPU Ratio Selection : JFREQ1	1-25
1.7 Jumper Settings	1-26
1.7.1 Wake on keyboard selection : J3(Optional)	1-27
1.7.2 System Fan Connector : J6	1-27
1.7.3 Wake-On-LAN Connector : JWOL1	1-27
1.7.4 Wake-On-Modem Connector : JWOM1(Optional).....	1-27
1.7.5 CMOS Function Selection : JBAT1	1-28
1.8 DRAM Installation.....	1-29
1.8.1 DIMM	1-29
1.8.2 How to install a DIMM Module.....	1-32
1.9 Audio Subsystem.....	1-33
1.9.1 CD Audio-In Connectors : J7/J8	1-34
1.9.2 Telephony Connector : J9.....	1-34
1.9.3 AUX Audio in Connector : J10(Optional)	1-34
2. BIOS Setup.....	2-1
2.1 Main Menu.....	2-3
2.2 Standard CMOS Setup	2-5
2.3 BIOS Features Setup	2-9
2.4 Chipset Features Setup.....	2-15
2.5 Power Management Setup.....	2-18
2.6 PNP / PCI Configuration Setup.....	2-23
2.7 Load SETUP Defaults.....	2-26

2.8 CPU Speed Setting.....	2-27
2.9 Integrated Peripherals Setup	2-29
2.10 Supervisor / User Password Setting	2-33
2.11 IDE HDD Auto Detection.....	2-35
2.12 Save & Exit Setup	2-36
2.13 Exit Without Saving.....	2-37
2.14 Application Software	2-38
3. Software Setup.....	3-1
3.1 Software List.....	3-1
3.2 Software Installation	3-2
3.3 Using Software.....	3-3
4. Trouble Shooting	4-1

Introduction

System Overview

Thanks for buying this product! This manual was written to help you start using this product as quickly and smoothly as possible. Inside you will find adequate explanations to solve most problems. In order for this reference material to be of greatest use, refer to the “expanded table of contents” to find relevant topics.

This board incorporates the all new VIA693A/686A serial chipset, ISA, VGA and PCI IDE into one board that provides a total PC solution. The motherboard, a Celeron™ / Pentium®II & Pentium®!!!, processor based PC/Micro ATX system, supports 128KB or 256KB or 512KB cache on CPU, PCI Local Bus to support upgrades to your system performance. On-Board Sound Subsystem to support soma quality the AMR Slot to support the solution of high performance, low cost modem. It is ideal for multi-tasking and fully supports MS-DOS, Windows 3x, Windows NT, Windows 2000, Novell, OS/2, Windows9x, UNIX, SCO UNIX etc. This manual also explains how to install the motherboard for operation, and how to setup your CMOS configuration with the BIOS setup program.

1 Motherboard Description

1.1 Features

1.1.1 Hardware

CPU

- The Celeron™ processor (PPGA) and the Pentium® II & Pentium® III Micro-Processor provides the new generation power for high-end workstations and servers.
- Provides Socket 370 and Slot 1.
- Running at 66/100 or 133MHz Front Side Bus frequency.

Speed

- Supports from 233MHz to 600MHz CPU core speeds.
- Supports 33MHz PCI Bus speed.

DRAM Memory

- Supports three 8/16/32/64/128/256MB DIMM module sockets.
- Supports Synchronous DRAM (3.3V).
- Supports a maximum memory size of 768 MB with SDRAM.
- 133MHz Bus frequency.

Shadow RAM

- A memory controller that provides shadow RAM.

Green Function

- Supports power management operation via BIOS.
- Power down timer from 1 min to 1 hour.
- Wakes up by any key pressed or mouse activity.
- Wake On LAN connector.
- Wake On MODEM header.
- Wake On AMR supported.

BUS Slots

- Provides one AGP slot and one 16-bit ISA Bus slot (Optional).
- Two 32-bit PCI Bus master slots.
- PCI V2.2 compliant.

PCI Enhanced IDE Built-in onboard

- Supports 4 IDE hard disk drives.
- Supports Mode 4, Bus Master Mode, high performance hard disk drives.
- Supports Ultra DMA33/66, Bus Master Mode.
- Supports IDE interface with CD-ROM.
- Supports high capacity hard disk drives.
- Supports LBA Mode.
- Supports booting from LS-120 “SuperDisk” or Iomega ZIP disk.

PCI-based AC 97 Digital Audio Processor (Optional)

- AC'97 2.1 compliant codec.
- 18-bit stereo full duplex $\Sigma \Delta$ codec.
- VSR (Variable Sampling Rate).
- 3D stereo expansion for simulated surround.
- Multiple codec mode.
- External Audio Amplifier Control.
- Power management support.
- Exceeds Microsoft® PC'9x requirements.

ISA I/O Built-in onboard (Optional)

- Supports one multi-mode Parallel Port.
 - (1) Standard & Bidirection Parallel Port (SPP).
 - (2) Enhanced Parallel Port (EPP).
 - (3) Extended Capabilities Port (ECP).
- Supports two serial ports, 16550 UART with 16 byte FIFO.
- UART data rates up to 1.5 Mbaud.
- Supports one Infrared transmission (IR) port.
- Supports PS/2 Mouse.
- Supports 360KB, 720KB, 1.2MB, 1.44MB and 2.88MB floppy disk drives.

Direct Sound Ready AC97 Digital Audio Controller

- Dual full-duplex Direct Sound channels between system memory and AC97 link.
- PCI master interface with scatter / gather and bursting capability.
- 32 byte FIFO of each direct sound channel.
- Host based sample rate converter and mixer.
- Standard v1.0 or v2.0 AC97 Codec interface for single or cascaded AC97 Codec's from multiple vendors.
- Loopback capability for re-directing mixed audio streams into USB and 1394 speakers.
- Hardware SoundBlaster Pro for Windows DOS box and real-mode Dos legacy compatibility.
- Plug and play with 4 IRQ, 4 DMA, and 4 I/O space options for SoundBlaster Pro and MIDI hardware.
- Hardware assisted FM synthesis for legacy compatibility.
- Direct two game ports and one MIDI port interface.
- Complete software driver support for Windows 95, Windows 98, Windows NT and Windows 2000.

Power Management

- Supports both ACPI (Advanced and Configuration and Power Interface) and legacy (APM) power management.
- ACPI v1.0 Compliant.
- APM v1.2 Compliant.
- CPU clock throttling and clock stop control for complete ACPI C0 to C3 state support.
- PCI bus clock run, Power Management Enable (PME) control, and PCI/CPU clock generator stop control.
- Supports multiple system suspend types: power-on suspends with flexible CPU/PCI bus reset options, and suspend to disk (soft-off), all with hardware automatic wake-up.
- Multiple suspend power plane controls and suspend status indicators.
- One idle timer, one peripheral timer and one general purpose timer, plus 24/32-bit ACPI compliant timer.
- Normal, doze, sleep, suspend, and conserve modes.
- Global and local device power control.
- System event monitoring with two event classes.

- Primary and secondary interrupt differentiation for individual channels.
- Dedicated input pins for power and sleep buttons, external modem ring indicator, and notebook lid open/close for system wake-up.
- Multiple internal and external SMI sources for flexible power management models.
- One programmable chip select and one microcontroller chip select.
- Enhanced integrated real time clock (RTC) with date alarm, month alarm, and century field.
- Thermal alarm on either external or any combination of two internal temperature sensing circuits.
- Hot docking support.
- I/O pad leakage control.

Universal Serial Bus

- USB v.1.1 and Intel Universal HCI v.1.1 compatible.
- Eighteen level (doublewords) data FIFO with full scatter and gather capability.
- Root hub and four function ports.
- Integrated physical layer transceivers with optional over-current detection status on USB inputs.
- Keyboard and mouse support.

Platform

- Micro ATX Form Factor.

Dimension

- 21.3 cm X 24.5 cm (W x L).

1.1.2 Software

BIOS

- AWARD legal & user-friendly BIOS.
- Supports PnP functions.

Operating Systems

- Offers the highest performance for MS-DOS OS/2, Windows NT, Windows 2000, Windows 31 / 95 / 98, Novell, UNIX, SCO UNIT, and others.

1.1.3 Attachments

- HDD Cable.
- FDD Cable.
- CD for IDE / VGA Chip Driver, BIOS flash writer utility, Sound Codec Driver.

1.2 Motherboard Installation

1.2.1 Layout of Motherboard

Model No.M6VCA

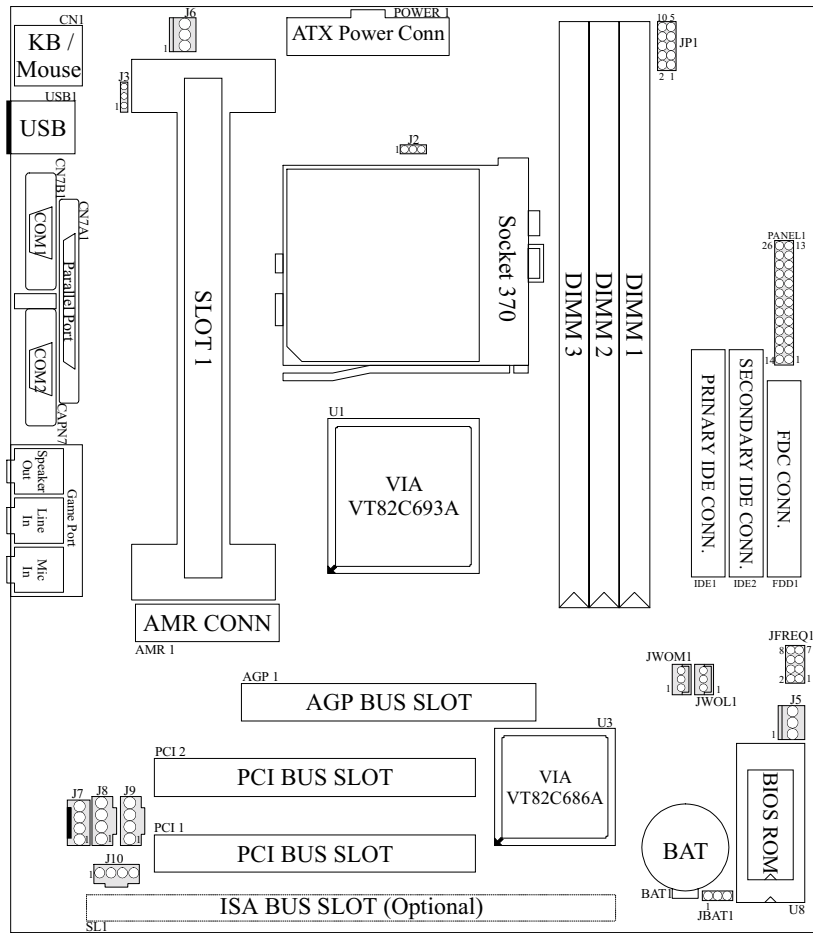

1.3 Motherboard Connectors

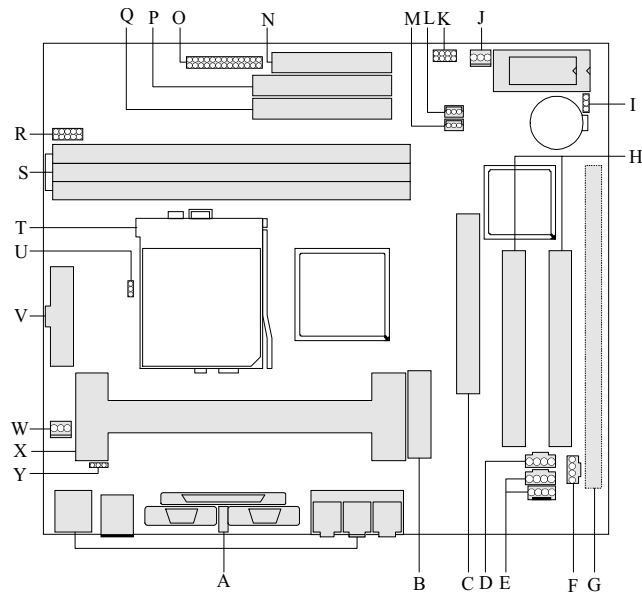

- | | |
|---|---|
| A. Back panel I/O connectors | N. FDC connector (FDD1) |
| B. AMR Slot (AMR1) | O. Front Panel CONN (PANEL1) |
| C. AGP BUS Slot (AGP1) | P. SECONDARY IDE CONN (IDE2) |
| D. Telephony connector (J9) | Q. PRIMARY IDE CONN (IDE1) |
| E. CD Audio-In connector (J7/J8) | R. CPU Frequency Selection (JP1) |
| F. AUX Audio in Connector (J10) (Optional) | S. DIMM (DIMM1-3) |
| G. ISA BUS Slot (SL1) (Optional) | T. Socket 370 (U2) |
| H. PCI BUS Slots (PCI1-2) | U. CPU Voltage Selection (J2) |
| I. CMOS Function Selection (JBAT1) | V. ATX Power connector (POWER1) |
| J. System Fan connector (J5) | W. CPU Fan Connector (J6) |
| K. CPU Ratio Selection (JFREQ1) | X. SLOT1 (SLOT1) |
| L. Wake On LAN (JWOL1) | Y. Wake on Keyboard Selection |
| M. Wake On Modem (JWOM1) (Optional) | (J3) (Optional) |

1.3.1 Front Panel Connectors :PANEL1

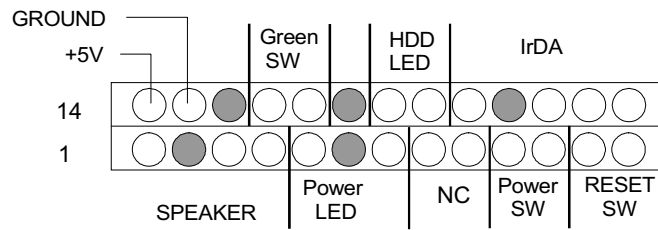

Pin No.	Assignment	Function	Pin No.	Assignment	Function
1	Speaker	Speaker Connector	14	+5V	VCC
2	NC		15	Ground	Ground
3	Ground		16	NC	NC
4	+5V		17	Green Switch	Green Button
5	Power LED(+)	Power LED	18	Ground	Button
6	NC		19	NC	NC
7	Ground		20	HDD LED(-)	HDD LED
8	NC	No Function	21	HDD LED(+)	LED
9	NC		22	+5V	IrDA Connector
10	Power Switch	ATX Power Button	23	NC	
11	Ground	Reset Button	24	IRRX	
12	Reset Switch	Reset Button	25	Ground	
13	Ground	Reset Button	26	IRTX	

Speaker Connector

An offboard speaker can be installed on the motherboard as a manufacturing option. An offboard speaker can be connected to the motherboard at the front panel connector. The speaker (onboard or offboard) provides error beep code information during the Power On Self-Test when the computer cannot use the video interface. The speaker is not connected to the audio subsystem and does not receive output from the audio subsystem.

Reset Button

This connector can be connected to a momentary SPST type switch that is normally open. When the switch is closed, the motherboard resets and runs the POST.

Power LED Connector

This connector can be connected to an LED that will light when the computer is powered on.

Hard Drive LED Connector

This connector can be connected to an LED to provide a visual indicator that data is being read from or written to a hard drive. For the LED to function properly, an IDE drive must be connected to the onboard hard drive controller.

Infrared Connector

After the IrDA interface is configured, files can be transferred from or to portable devices such as laptops, PDAs, and printers using application software.

Sleep Button

When APM is enabled in the system BIOS, and the operating system's APM driver is loaded, the system can enter sleep (standby) mode in one of the following ways:

Power On Button

This connector can be connected to a front panel power switch. The switch must pull the Power Button pin to ground for at least 50 ms to signal the power supply to switch on or off. (The time requirement is due to internal denounce circuitry on the motherboard.) At least two seconds must pass before the power supply will recognize another on/off signal.

1.3.2 ATX 20-pin Power Connector : POWER1

This connector supports the power button on-board. Using the ATX power supply, functions such as Modem Ring Wake-Up and Soft Power Off are supported on this motherboard. This power connector supports instant power-on functionality, which means that the system will boot up instantly when the power connector is inserted on the board.

PIN	VOLTAGE	PIN	VOLTAGE
1	3.3 V	11	3.3 V
2	3.3 V	12	-12 V
3	GND	13	GND
4	5 V	14	PS_ON
5	GND	15	GND
6	5 V	16	GND
7	GND	17	GND
8	PW_OK	18	-5 V (Optional)
9	5V_SB	19	5 V
10	12 V	20	5 V

Warning: Since the motherboard has the instant power on function, make sure that all components are installed properly before inserting the power connector to ensure that no damage will be done.

1.3.3 Hard Disk Connectors : IDE1 / IDE2

The motherboard has a 32-bit Enhanced PCI IDE Controller that provides PIO Mode 0-4, Bus Master, and Ultra DMA 33 / 66 functionality. It has two HDD connectors IDE1 (primary) and IDE2 (secondary). You can connect up to four hard disk drives, a CD-ROM, a 120MB Floppy (reserved for future BIOS) and other devices to IDE1 and IDE2. These connectors support the IDE hard disk cable provided.

- **IDE1 (Primary IDE Connector)**

The first hard drive should always be connected to IDE1. IDE1 can connect a Master and a Slave drive. You must configure the second hard drive on IDE1 to Slave mode by setting the jumper accordingly.

- **IDE2 (Secondary IDE Connector)**

The IDE2 controller can also support a Master and a Slave drive. The configuration is similar to IDE1. The second drive on this controller must be set to slave mode.

1.3.4 Floppy Disk Connector : FDD1

The motherboard provides a standard floppy disk connector (FDC) that supports 360K, 720K, 1.2M, 1.44M and 2.88M floppy disk types. This connector supports the provided floppy drive ribbon cables.

1.4 Back Panel Connectors

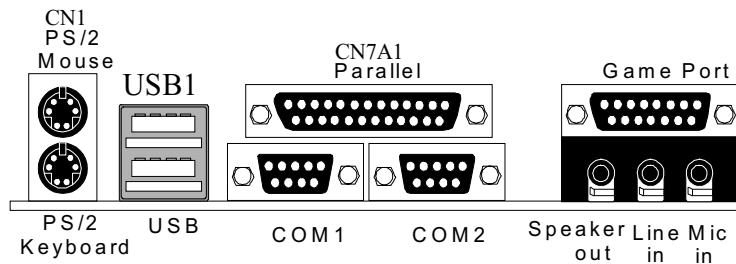

1.4.1 PS/2 Mouse / Keyboard Connector : CN1

The motherboard provides a standard PS/2 mouse / Keyboard mini DIN connector for attaching a PS/2 mouse. You can plug a PS/2 mouse / Keyboard directly into this connector. The connector location and pin definition are shown below:

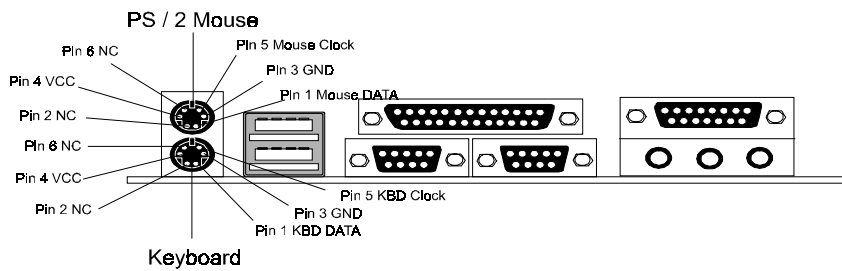

PS/2 Mouse / Keyboard Connectors

Pin	Signal Name
1	Data
2	No connect
3	Ground
4	+5 V (fused)
5	Clock
6	No connect

1.4.2 USB Connectors : USB1

The motherboard provides a **UHCI (Universal Host Controller Interface) Universal Serial Bus roots** for attaching USB devices such as: keyboard, mouse and other USB devices. You can plug the USB Devices directly into this connector.

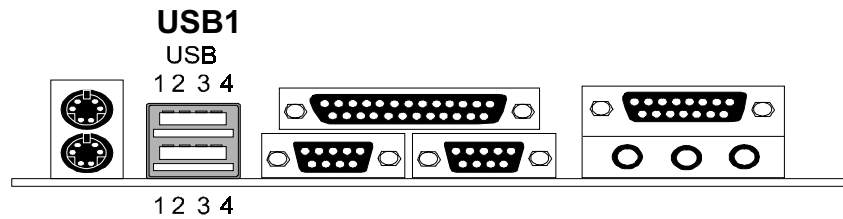
**Stacked USB Connectors**

Pin	Signal Name
1	+5 V (fused)
2	USBP0- [USBP1-]
3	USBP0+ [USBP1+]
4	Ground

Note: (1) Signal names in brackets ([]) are for USB port 1.

1.5 Serial and Parallel Interface Ports

This system comes equipped with two serial ports and one parallel port. Both types of interface ports will be explained in this chapter.

The Serial Interface Port : COM1 / COM2

The serial interface port is sometimes referred to as an RS-232 port or an asynchronous communications port. Mice, printers, modems and other peripheral devices can be connected to a serial port. The serial port can also be used to connect your computer with another computer system. If you wish to transfer the contents of your hard disk to another system it can be accomplished by using each machine's serial port.

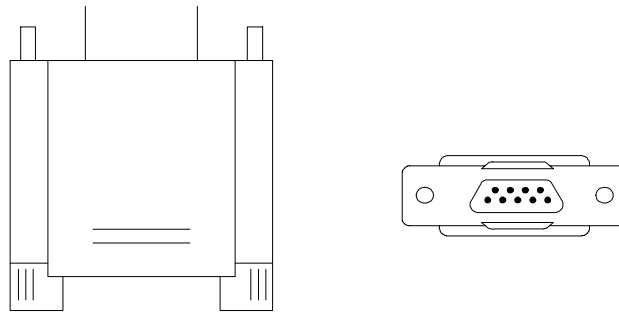

The serial ports on this system have two 9-pin connector. Some older computer systems and peripherals used to be equipped with only one 25-pin connector. Should you need to connect your 9-pin serial port to an older 25-pin serial port, you can purchase a 9-to-25 pin adapter.

Connectivity

The serial port can be used many ways, and it may be necessary to become familiar with the pin-out diagram. The following chart gives you the function of each pin on the 9-pin connector and some of the 25-pin connector. This information can be used when configuring certain software programs to work with the serial port.

Signal	Name	DB9 PIN	DB25 PIN
DCD	Data Carrier Detect	1	8
RX	Receive Data	2	3
TX	Transmit Data	3	2
DTR	Data Terminal Ready	4	20
GND	Signal Ground	5	7
DSR	Data Set Ready	6	6
RTS	Request to Send	7	4
CTS	Clear to Send	8	5
RI	Ring Indicator	9	22

Special Applications

There are two types of serial devices that can be connected to a serial port. One of the devices is called "DTE" (Data Terminal Equipment) and the other device is called "DCE" (Data Communications Equipment). If a modem is connected to a computer, for example, the modem is called the DCE and the computer is called the DTE. In situations such as this, the pins on the serial ports can be connected straight through.

In instances when there are two DTE devices connected together, such as a computer and a printer, a special adapter called a "Null Modem" is needed to make communication between the two devices possible.

When using the serial port to communicate between devices, one problem in particular may arise. Some manufacturers use one set of signals to begin communication with another device and other manufacturers do not use these

signals to initiate communication. If you encounter a communication problem that cannot be resolved using a null modem, it can generally be assumed that one device is using the initialization signals and the other device is not. This can usually be resolved by wiring the RTS, CTS, and DCD pins together.

Serial Ports/COM Ports

The two serial ports on the computer are called COM1 and COM2, respectively. If you wish, two more serial ports can be added onto the computer using optional hardware. Should you choose to add the extra Serial ports (COM ports) they would be called COM3 and COM4.

When using serial ports to communicate with a peripheral device, be sure to assign only one COM port number to each device. For example, if a printer and a scanner are both connected to your computer through serial ports, the printer must be assigned one COM port (i.e. COM1) and the scanner must be assigned the other COM port (i.e. COM2). No two devices can be assigned to one COM port. Each peripheral must have its own COM port.

NOTE: Four serial ports may be installed on the computer. However, no more than two ports can be used simultaneously.

*If you have installed an internal modem, be careful not to assign a COM port number that has already been assigned to another device. This error is common.

When installing a device that is going to require the use of a serial port, use a diagnostic program to find out which ports are available. It may be necessary to remove expansion cards that have serial ports in order to check their jumper settings. The jumper settings will indicate which COM port the card has been assigned. Checking the expansion card will eliminate mistakes in overlapping COM ports. Once you have completed the installation of peripheral devices using the serial ports, be sure that the communication parameters such as baud rate, parity bit, etc. are matching. If your computer is set for a baud rate of 9600 and your modem is set for a baud rate of 2400 you will not be able to send messages. The manuals that accompany the peripheral devices will inform you on the procedure for setting their parameters. Software manuals also have instructions on setting parameters.

Parallel Interface Port : CN7A1

Unlike the serial port, parallel interface ports have been standardized and should not present any difficulty interfacing peripherals to your system. Sometimes called a Centronics port, the parallel port is almost exclusively used with printers. The parallel port on your system has a 25-pin, DB5 connector (see picture below). The pin-out for the parallel port are shown in the table below.

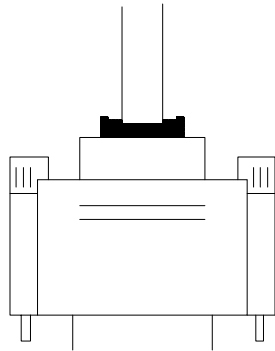
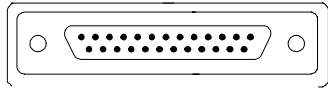

Signal	Pin
-Strobe	1
Data 0	2
Data 1	3
Data 2	4
Data 3	5
Data 4	6
Data 5	7
Data 6	8
Data 7	9
-Ack	10
Busy	11
Paper Empty	12
+Select	13
-Auto FDXT	14
-Error	15
-Init	16
-SLCTN	17
Ground	18
Ground	19
Ground	20
Ground	21
Ground	22
Ground	23
Ground	24
Ground	25

1.6 CPU Installation

1.6.1 CPU Installation Procedure : Socket 370

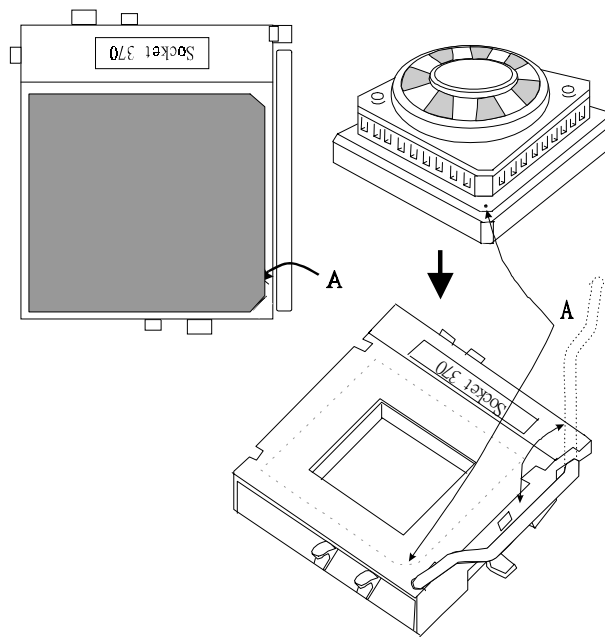

1. Pull the lever sideways away from the socket then raise the lever up to a 90-degree angle.
2. Locate Pin A in the socket and look for the white dot or cut edge in the CPU. Match Pin A with the white dot/cut edge then insert the CPU.
3. Press the lever down to complete the installation.

1.6.2 CPU Installation Procedure : Slot 1

Motherboard

The M6VCA motherboard provides one Single Edge Contact (SEC) slot. This slot allows you to install a Pentium®II & Pentium®!!! CPU.

Before you use:

Please look on your motherboard and locate the CPU fan and CPU fan power supply. Please verify that this fan is directly used to cool the CPU and its heat sink, as well as to cool the motherboard and circulate the air.

WARNING : If air circulation is insufficient, the CPU will overheat, which may damage the CPU, CPU slot, and the motherboard.

Please inspect your motherboard to see if it has the Pentium®II & Pentium®!!! CPU retention kit components. (ATTENTION: The CPU installation component color and shape may vary slightly based on kits coming from different suppliers.)

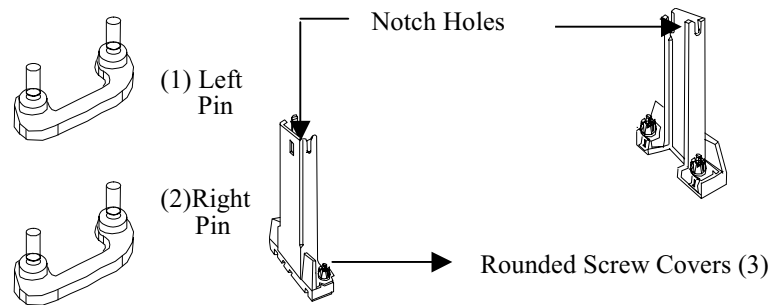

Pentium®II & !!! / Heat Sink Pins Pentium®II & !!! / Heat Sink

M6VCA CPU Special Installation and Setup :**Install Pentium® II & Pentium® !!! / Celeron™ :****1 · Installing the Heat Sink Support Frame :**

The Heat Sink Support Base can only be inserted one-way. Please match the leg sizes on the Heat Sink Support Base to the holes on the motherboard. Please insert the screws from the bottom of the motherboard and tighten into the rounded screw covers.

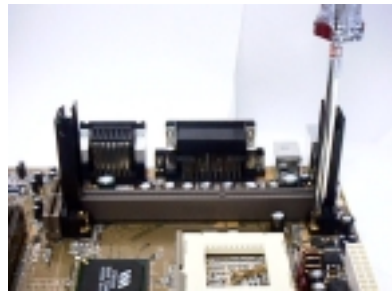

———— Rounded screw covers

Installing the CPU Heat sink :

Take the smooth side of the Heat Sink and bind it closely together with the CPU. Next, at the ends of the Heat Sink, clip the CPU together with the Heat Sink. Please verify that there is no space between the Heat Sink and CPU unit. **WARNING:** If there is any space between the CPU and Heat Sink, the CPU will

over-heat severely and may be damaged.

Attach the metal clips at ends of the CPU unit

Push the clips on the Heat Sink and CPU unit to tightly bind them together. The arrows mark the location.

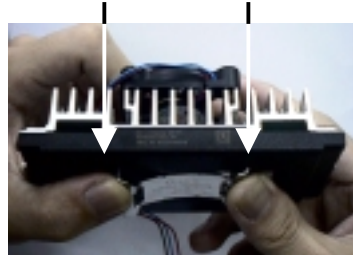
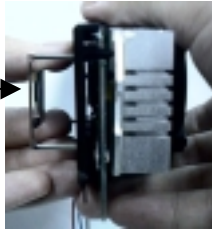

2 · Insert the CPU into the SEC Solt :

- (1) First, press the CPU unit into the Frame until it fits snugly into the notch holes. Then, clip the Heat Sink and CPU together with the Heat Sink Support Frame.

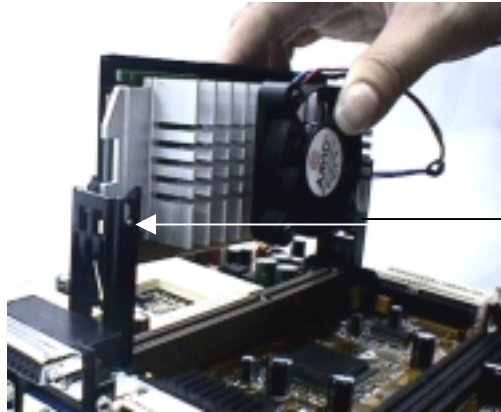

The correct direction to insert the Heat Sink and CPU into the Heat Sink Support Frame should allow you to easily insert them.

- (2) Pushing the CPU unit into the frame, wait until the CPU unit is firmly in position before securing. The notches are pushed out. They will fit tightly into the H at Sink Frame Notch holes.

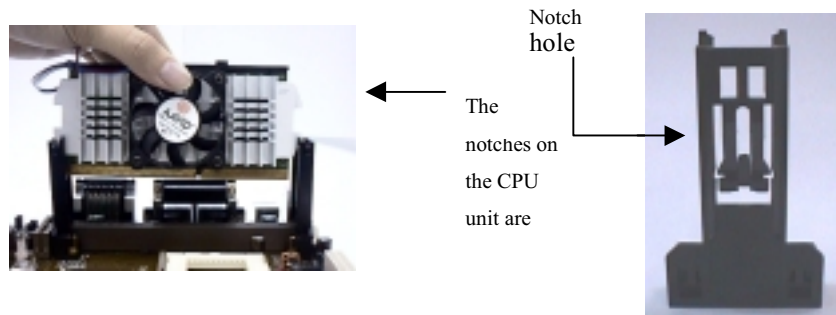

- (3) Firmly secure the Heat Sink by attaching the Heat Sink Frame TOP-Bar. Please verify that the Heat Sink and CPU are tightly pressed together. Please check that the entire Frame, Heat Sink, and CPU unit are tightly installed and that there is no possible movement or looseness in the assembly.

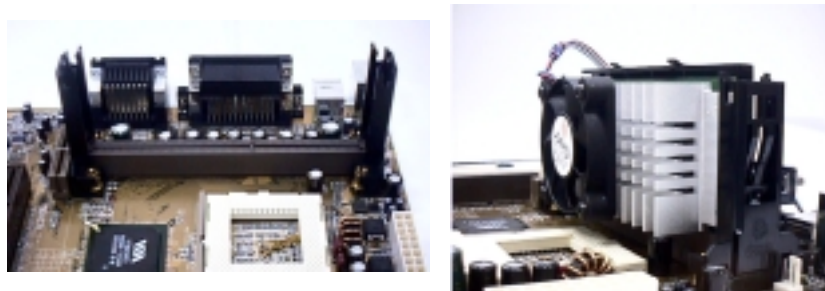

1.6.3 CPU Frequency Selection : JP1

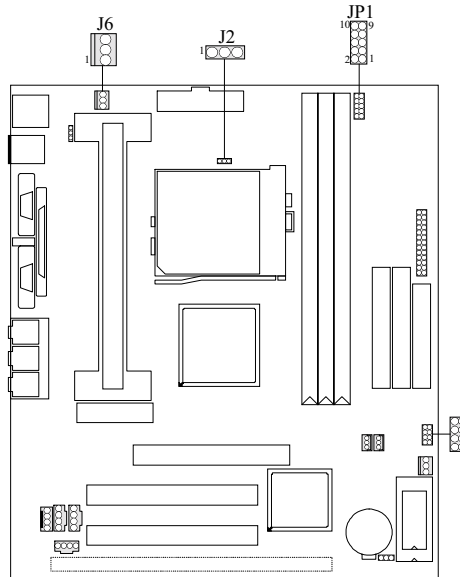

JP1 FREQ.	1	2	3	4	5
66MHz	OPEN	OPEN	CLOSE	CLOSE	CLOSE
100MHz	OPEN	OPEN	CLOSE	OPEN	CLOSE
103MHz	CLOSE	CLOSE	CLOSE	OPEN	CLOSE
112MHz	CLOSE	OPEN	CLOSE	OPEN	CLOSE
124MHz	CLOSE	OPEN	OPEN	CLOSE	OPEN
133MHz	OPEN	OPEN	OPEN	OPEN	OPEN

1.6.4 Socket 370 & Slot 1 Selection : J2

Pin No.	Assignment
1-2	Slot 1 CPU
2-3	Socket 370 CPU

1.6.5 CPU Fan connector : J6

Pin No.	Assignment
1	Sense
2	+12 V
3	Control Signal

1.6.6 CPU Ratio Selection : JFREQ1

JFREQ1 RATIO	1	2	3	4
x 2.0	CLOSE	CLOSE	CLOSE	CLOSE
X 2.5	CLOSE	CLOSE	OPEN	CLOSE
X 3.0	CLOSE	OPEN	CLOSE	CLOSE
x 3.5	CLOSE	OPEN	OPEN	CLOSE
X 4.0	OPEN	CLOSE	CLOSE	CLOSE
x 4.5	OPEN	CLOSE	OPEN	CLOSE
x 5.0	OPEN	OPEN	CLOSE	CLOSE
x 5.5	OPEN	OPEN	OPEN	CLOSE
x 6.0	CLOSE	CLOSE	CLOSE	OPEN
x 6.5	CLOSE	CLOSE	OPEN	OPEN
x 7.0	CLOSE	OPEN	CLOSE	OPEN
x 7.5	CLOSE	OPEN	OPEN	OPEN
x 8.0	OPEN	CLOSE	CLOSE	OPEN

1.7 Jumper Settings

The jumper a two or more pins which may be covered by a plastic jumper cap, allowing you to select different system options.

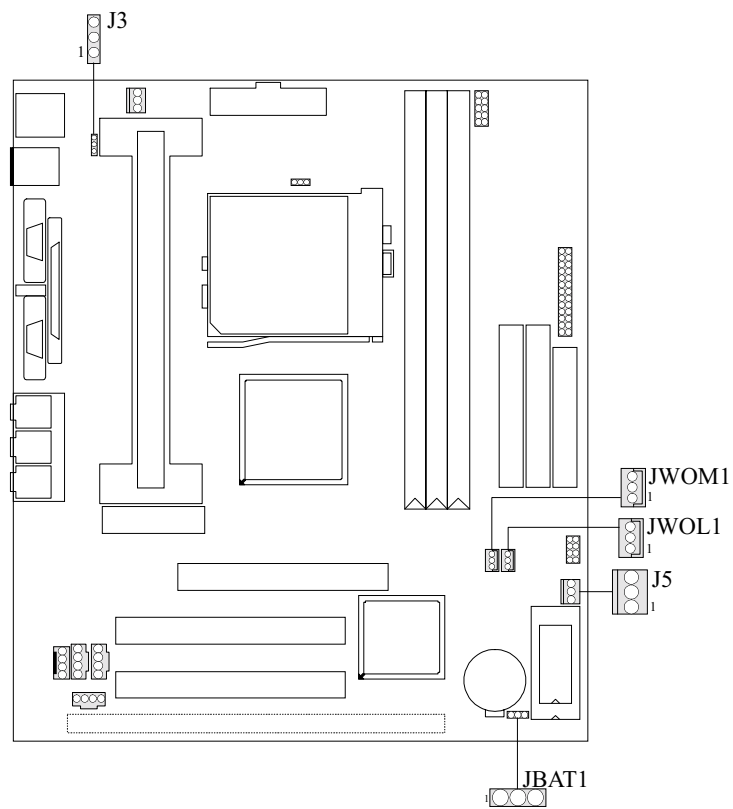

1.7.1 Wake on keyboard selection : J3(Optional)

Pin No.	Assignment
1-2	Normal
2-3	Wake on keyboard

1.7.2 System Fan Connector : J6

Pin No.	Assignment
1	Sense
2	+12 V
3	Control Signal

1.7.3 Wake-On-LAN Connector : JWOL1

Pin No.	Assignment
1	5V_SB
2	Ground
3	Wake-up

1.7.4 Wake-On-Modem Connector : JWOM1(Optional)

Pin No.	Assignment
1	5V_SB
2	GND
3	Ring

1.7.5 CMOS Function Selection : JBAT1

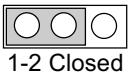
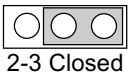
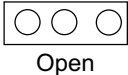
JBAT1	Assignment
 1-2 Closed	Normal Operation (default)
 2-3 Closed	Clear CMOS Data (*Note)
 Open	Onboard Battery Disabled

Note : Please follow the procedure as below to clear CMOS Data.

Note : Please follow the procedure as below to clear BIOS Password if your password is lost or forgotten.

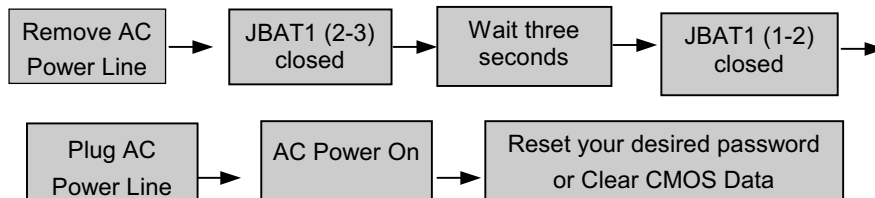

1.8 DRAM Installation

1.8.1 DIMM

DRAM Access Time : 3.3V Unbuffered SDRAM PC66, PC100 & PC133 Type required.

DRAM Type : 8MB/16MB/32MB/64MB/128MB/256MB DIMM Module (168pin)

Total Memory Size (MB)	Bank 0 DIMM1	Bank 1 DIMM2	Bank 2 DIMM3
8 M	8M x 1 pc	----	----
16 M	16M x 1 pc	----	----
32 M	32M x 1 pc	----	----
64 M	64M x 1 pc	----	----
128 M	128M x 1 pc	----	----
256 M	256M x 1 pc	----	----
16 M	8M x 1 pc	8M x 1 pc	----
32 M	16M x 1 pc	16M x 1 pc	----
64 M	32M x 1 pc	32M x 1 pc	----
128 M	64M x 1 pc	64M x 1 pc	----
256 M	128M x 1 pc	128M x 1 pc	----
512 M	256M x 1 pc	256M x 1 pc	----
24 M	8M x 1 pc	8M x 1 pc	8M x 1 pc
40 M	16M x 1 pc	16M x 1 pc	8M x 1 pc
72 M	32M x 1 pc	32M x 1 pc	8M x 1 pc
136 M	64M x 1 pc	64M x 1 pc	8M x 1 pc
264 M	128M x 1 pc	128M x 1 pc	8M x 1 pc
520 M	256M x 1 pc	256M x 1 pc	8M x 1 pc
32 M	8M x 1 pc	8M x 1 pc	16M x 1 pc
48 M	16M x 1 pc	16M x 1 pc	16M x 1 pc
80 M	32M x 1 pc	32M x 1 pc	16M x 1 pc
144 M	64M x 1 pc	64M x 1 pc	16M x 1 pc
272 M	128M x 1 pc	128M x 1 pc	16M x 1 pc
528 M	256M x 1 pc	256M x 1 pc	16M x 1 pc
48 M	8M x 1 pc	8M x 1 pc	32M x 1 pc
64 M	16M x 1 pc	16M x 1 pc	32M x 1 pc
96 M	32M x 1 pc	32M x 1 pc	32M x 1 pc
160 M	64M x 1 pc	64M x 1 pc	32M x 1 pc
288 M	128M x 1 pc	128M x 1 pc	32M x 1 pc
544 M	256M x 1 pc	256M x 1 pc	32M x 1 pc
80 M	8M x 1 pc	8M x 1 pc	64M x 1 pc
96 M	16M x 1 pc	16M x 1 pc	64M x 1 pc
128 M	32M x 1 pc	32M x 1 pc	64M x 1 pc
192 M	64M x 1 pc	64M x 1 pc	64M x 1 pc
320 M	128M x 1 pc	128M x 1 pc	64M x 1 pc
576 M	256M x 1 pc	256M x 1 pc	64M x 1 pc

Total	Bank 0	Bank 1	Bank 2
Memory Size (MB)	DIMM1	DIMM2	DIMM3
144 M	8M x 1 pc	8M x 1 pc	128M x 1 pc
160 M	16M x 1 pc	16M x 1 pc	128M x 1 pc
192 M	32M x 1 pc	32M x 1 pc	128M x 1 pc
256 M	64M x 1 pc	64M x 1 pc	128M x 1 pc
384 M	128M x 1 pc	128M x 1 pc	128M x 1 pc
640 M	256M x 1 pc	256M x 1 pc	128M x 1 pc
272 M	8M x 1 pc	8M x 1 pc	256M x 1 pc
288 M	16M x 1 pc	16M x 1 pc	256M x 1 pc
320 M	32M x 1 pc	32M x 1 pc	256M x 1 pc
384 M	64M x 1 pc	64M x 1 pc	256M x 1 pc
512 M	128M x 1 pc	128M x 1 pc	256M x 1 pc
768 M	256M x 1 pc	256M x 1 pc	256M x 1 pc

*The list shown above for DRAM configuration is only for reference.

1.8.2 How to install a DIMM Module

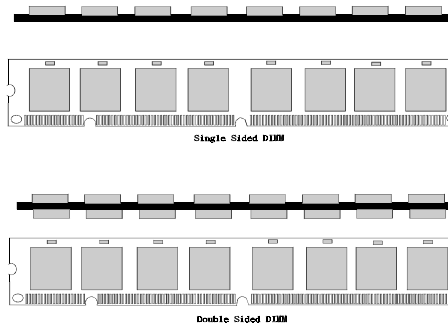

1. The DIMM socket has a "Plastic Safety Tab" and the DIMM memory module has an "asymmetrical notch", so the DIMM memory module can only fit in one direction.

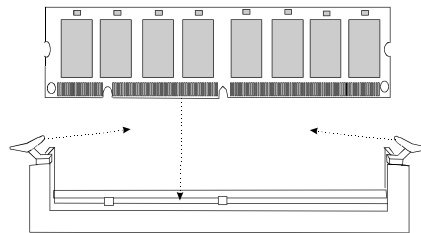

2. Push the tabs out. Insert the DIMM memory modules into the socket at 90-degree angle, then push down vertically so that it will fit into place.

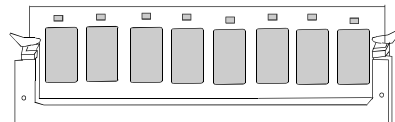

3. The Mounting Holes and plastic tabs should fit over the edge and hold the DIMM memory modules in place.

1.9 Audio Subsystem

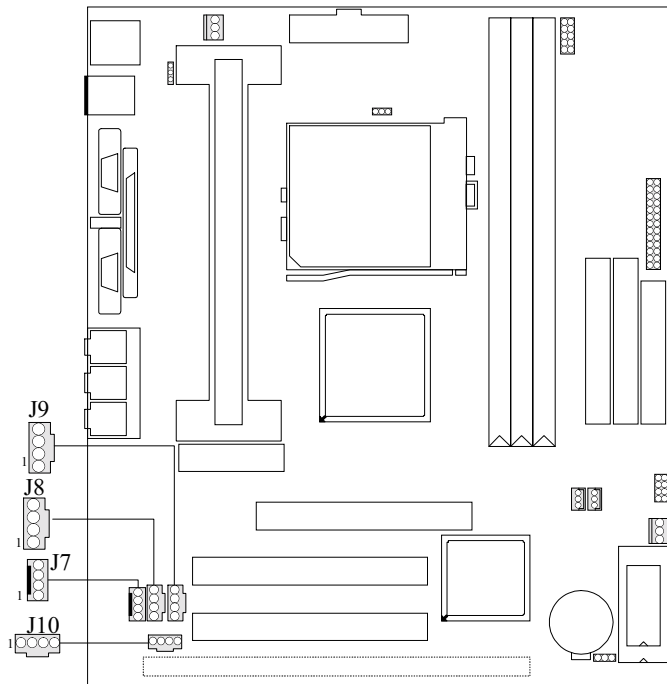

1.9.1 CD Audio-In Connectors : J7/J8

Pin No. of J7	Assignment
1	Left Channel Input
2	CD_GND
3	Right Channel Input
4	CD_GND

Pin No. of J8	Assignment
1	Left Channel Input
2	GND
3	GND
4	Right Channel Input

1.9.2 Telephony Connector : J9

Pin No. of J9	Assignment
1	MONO_Out
2	GND
3	GND
4	PHONE

1.9.3 AUX Audio in Connector : J10(Optional)

Pin No. of J9	Assignment
1	Left channel AUX_IN
2	GND
3	GND
4	Right channel AUX_IN

2. BIOS Setup

Introduction

This manual discussed Award™ Setup program built into the ROM BIOS. The Setup program allows users to modify the basic system configuration. This special information is then store in battery-backed RAM so that it retains the Setup information when the power is turned off.

The Award BIOS™ installed in your computer system's ROM (Read Only Memory) is a custom version of an industry standard BIOS. This means that it supports Intel processors in a standard IBM-AT compatible input/output system. The BIOS provides critical low-level support for standard devices such as disk drives and serial and parallel ports.

Adding important has customized the Award BIOS™, but nonstandard, features such as virus and password protection as well as special support for detailed fine-tuning of the chipset controlling the entire system.

The rest of this manual is intended to guide you through the process of configuring your system using Setup.

Plug and Play Support

These AWARD BIOS supports the Plug and Play Version 1.0A specification. ESCD (Extended System Configuration Data) write is supported.

EPA Green PC Support

This AWARD BIOS supports Version 1.03 of the EPA Green PC specification.

APM Support

These AWARD BIOS supports Version 1.1&1.2 of the Advanced Power Management (APM) specification. Power management features are implemented via the System Management Interrupt (SMI). Sleep and Suspend power management modes are supported. Power to the hard disk drives and video monitors can be managed by this AWARD BIOS.

PCI Bus Support

This AWARD BIOS also supports Version 2.1 of the Intel PCI (Peripheral Component Interconnect) local bus specification. Please see the Intel technical documentation for additional information.

DRAM Support

SDRAM (Synchronous DRAM) are supported.

Supported CPUs

This AWARDBIOS supports a single Intel Celeron™ CPU. Dual CPUs are not supported.

Using Setup

In general, you use the arrow keys to highlight items, press <Enter> to select, use the PageUp and PageDown keys to change entries, press <F1> for help and press <Esc> to quit. The following table provides more detail about how to navigate in the Setup program using the keyboard.

Keystroke	Function
Up arrow	Move to previous item
Down arrow	Move to next item
Left arrow	Move to the item on the left (menu bar)
Right arrow	Move to the item on the right (menu bar)
Esc	Main Menu: Quit without saving changes Submenus: Exit Current page to the next higher level menu
Move Enter	Move to the item you desired
PgUp key	Increase the numeric value or make changes
PgDn key	Decrease the numeric value or make changes
+ Key	Increase the numeric value or make changes
- Key	Decrease the numeric value or make changes
Esc key	Main Menu – Quit and not save changes into CMOS Status Page Setup Menu and Option Page Setup Menu – Exit Current page and return to Main Menu
F1 key	General help on Setup navigation kdys
F5 key	Load previous values from CMOS
F6 key	Load the fail-safe defaults from BIOS default table
F7 key	Load the optimized defaults
F10 key	Save all the CMOS changes and exit

2.1 Main Menu

Once you enter AWARD BIOS CMOS Setup Utility, the Main Menu(**Figure 1**) will appear on the screen. The Main Menu allows you to select an item and press <Enter> to accept or enter its sub-menu.

■ Figure 1. Main Menu

ROM PCI/ISA BIOS (xxxxxxxx)
CMOS SETUP UTILITY
AWARD SOFTWARE, INC.

STANDARD CMOS SETUP	CPU SPEED SETTING
BIOS FEATURES SETUP	INTEGRATED PERIPHERALS
CHIPSET FEATURES SETUP	SUPERVISOR PASSWORD
POWER MANAGEMENT SETUP	USER PASSWORD
PNP / PCI CONFIGURATION	IDE HDD AUTO DETECTION
LOAD SETUP DEFAULTS	SAVE & EXIT SETUP
	EXIT WITHOUT SAVING
Esc : Quit F5 : Menu in BIOS	↑ ↓ → ← : Select Item
F10 : Save & Exit Setup	(Shift) F2 : Change Color
Time, Date, Hard Disk Type...	

Standard CMOS Setup

This setup page includes all the items in a standard compatible BIOS.

BIOS Features Setup

This setup page includes all the items for the BIOS special enhanced features.

Chipset Features Setup

This setup page includes all the items of chipset special features.

Power Management Setup

This setup page includes all the items for power management features.

PNP / PCI Configuration

This category specifies the value (in units of PCI bus clocks) of the latency timer for this PCI bus master and the IRQ level for PCI device.

Load Setup Defaults

Chipset defaults indicates the values required by the system for maximum performance.

CPU Speed Setting

This setup page includes Hardware monitor & Jumper-less features setup.

Integrated Peripherals

This setup page includes all the items for Integrated Peripherals features.

Suspervisor Password / User Password

Change, set, or disable password. It allows you to limit access to the system and Setup, or just to Setup.

IDE HDD Auto Detection

Automatically close figure hard disk parameters.

Save & Exit Setup

Save CMOS value changes to CMOS and exit setup.

Exit Without Saving

Abandon all CMOS value changes and exit setup.

2.2 Standard CMOS Setup

The items in the Standard CMOS Setup Menu are divided into categories. Each category includes setup item(s). Use the arrow keys to highlight the item and then use the <PgUp> or <PgDn> keys to select the value you want for each item.

■ Figure 2. Standard CMOS Setup Menu

ROM PCI/ISA BIOS (xxxxxxx)
STANDARD CMOS SETUP
AWARD SOFTWARE, INC.

Date (mm:dd:yy) :Wed Sep 7 1999									
Time (hh:mm:ss) : 9 : 6 : 43									
HARD DISKS									
	TYPE	SIZE	CYLS	HEAD	PRECOMP	LAND	SECTOR	MODE	
Primary Master	: Auto	0	0	0	0	0	0	Auto	
Primary Slave	: Auto	0	0	0	0	0	0	Auto	
Secondary Master	: Auto	0	0	0	0	0	0	Auto	
Secondary Slave	: Auto	0	0	0	0	0	0	Auto	
Drive A	:None								
Drive B	:None								
Video	:EGA/VGA								
Halt On	:All, Errors								
					Base Memory :				
					Extended Memory :				
					Other Memory :				
					Total Memory :				
Esc : Quit			↑ ↓ → ← : Select Item			PU/PD/+/-:Modify			
F1 : Help			(Shift) F2 : Change Color						

Date

The Date format is <day><month><date><year>.

Day	The day, from Sun to Sat, is stored by the BIOS and is display-only
Date	The date, from 1 to 31 (or the maximum allowed in the month)
month	The month, Jan through Dec
year	The year, from 1994 through 2079

Time

The time format is <hour><minute><second>. The time is calculated based on the 24-hour military-time clock. For example, 2 p.m. is 14:00:00.

Hard Disk Type

This category identifies the type(s) of hard disk(s) that have been installed in the computer. There are 46 predefined types and a user definable type. Type 1 to Type 45 are predefined. Type "User" is user-definable. Type "Auto" is automatically defined by BIOS.

Press <PgUp> or <PgDn> to select a numbered hard disk type or type the number and press <Enter>. Note that the specifications of your drive must match with the drive table. The hard disk will not work properly if you enter improper information for this category. If your hard disk drive type is not listed, you can use Type "User" to define your own drive type manually.

If you select type "User", information is to be entered for the items in the following chart. Enter the information directly from the keyboard and press <Enter>. This information should be provided in the documentation from your hard disk vendor or the system manufacturer.

Hint: Most new drives give the parameters on the label on top of the drive.

CYLN	number of cylinders
HEAD	number of heads
WPCOM	write precompensation
SEC	number of sectors
LBA MODE	type of LBA mode
BLK MODE	type of Block mode
PIO MODE	type of PIO
32BIT MODE	type of 32-Bit transfer mode

If a hard disk has not been installed select "NOT Installed" and press <Enter>.

Drive A Type/Drive B Type

The category identifies the types of floppy disk, drive A or drive B, which has been installed in the computer.

None	No floppy drive installed
360K, 5 1/4	5-1/4 inch PC-type standard drive; 360 kilobyte capacity
1.2M, 5 1/4	5-1/4 inch AT-type high-density drive; 1.2 megabyte capacity
720K, 3 1/2	3-1/2 inch double-sided drive; 720 kilobyte capacity
1.44M, 3 1/2	3-1/2 inch double-sided drive; 1.44 megabyte capacity
2.88M, 3 1/2	3-1/2 inch double-sided drive; 2.88 megabyte capacity

Video

The category selects the type of adapter used for the primary system monitor, and must match your video display card and monitor. Although secondary monitors are supported, you do not have to select the type in Setup.

EGA/VGA	Enhanced Graphics Adapter/Video Graphics Array. For EGA, VGA, SEGA, or PGA monitor adapters.
CGA 40	Color Graphics Adapter, power up in 40 column mode
CGA 80	Color Graphics Adapter, power up in 80 column mode
MONO	Monochrome adapter, includes high resolution monochrome adapters

Halt On

The category determines whether the computer will stop if an error is detected during power up.

No errors	Whenever the BIOS detects a non-fatal error the system will be stopped and you will be prompted.
All errors	The system boot will not stop for any error that may be detected.
All, But Keyboard	The system boot will not stop for a keyboard error, it will stop for all other errors.
All, But Diskette	The system boot will not stop for a disk error, it will stop for all other errors.
All, But Disk/Key	The system boot will not stop for a keyboard or disk error, it will stop for all other errors.

Memory

This category is display-only which is determined by the POST (Power On Self Test) of the BIOS.

Base Memory

The POST of the BIOS will determine the amount of base (or conventional) memory installed in the system. The value of the base memory is typically 512K for system with 512K memory installed on the motherboard, or 640K for system with 640K or more memory installed on the motherboard.

Extended Memory

The BIOS determines how much extended memory is present during the POST. This is the amount of memory located above 1MB in the CPU's memory address map.

Other Memory

This refers to the memory located in the 640K address space. This is the memory that can be used for different applications. DOS uses this area to load device drivers to keep as much base memory free application programs. The most common use for this area is Shadow RAM.

2.3 BIOS Features Setup

■ Figure 3. BIOS Features Setup Menu

ROM PCI/ISA BIOS (xxxxxxxx)
 BIOS FEATURES SETUP
 AWARD SOFTWARE, INC.

Virus Warning	: Disabled	Report No FDD For WIN 95	: Yes
CPU Internal Cache	: Enabled	Video BIOS Shadow	: Enabled
External Cache	: Enabled	C8000-CBFFF Shadow	: Disabled
Quick Power On Self Test	: Enabled	CC000-CFFFF Shadow	: Disabled
Boot From LAN First	: Disabled	D0000-D3FFF Shadow	: Disabled
Boot Sequence	: A,C,SCSI	D4000-D7FFF Shadow	: Disabled
Swap Floppy Drive	: Disabled	D8000-DBFFF Shadow	: Disabled
Boot Up Floppy Seek	: Enabled	DC000-DFFFF Shadow	: Disabled
Boot Up NumLock Status	: On		
IDE HDD Block Mode	: Enabled		
Gate A20 Option	: Fast		
Memory Parity / ECC Check	: Disabled		
Typematic Rate Setting	: Disabled		
Typematic Rate(Chars/Sec)	: 6		
Typematic Delay (Msec)	: 250		
Security Option	: Setup		
PCI / VGA Palette Snoop	: Disabled		
OS Select For DRAM > 64MB	: Non-OS2		
		ESC : Quit ↑ ↓ → ← : Select Item	
		F1 : Help PU/PD/+/- : Modify	
		F5 : Old Values <Shift> F2 : Color	
		F7 : Load Setup Defaults	

Virus Warning

This category flashes on the screen. During and after the system boot up, any attempt to write to the boot sector or partition table of the hard disk drive will halt the system and an error message will appear. In the mean time, you can run an anti-virus program to locate the problem.

Disabled (default)	No warning message will appear when any attempts are made to access the boot sector or hard disk partition table.
Enabled	Activates automatically when the system boots up causing a warning message to appear when anything attempts to access the boot sector of hard disk partition table.

CPU Internal Cache

These fields allow you to Enabled or Disable the CPU Internal Cache. Caching allow better performance.

Enabled (default)	Enable cache
Disabled	Disable cache

External Cache

These fields allow you to Enable or Disable the CPU's "Level 2" secondary cache. Caching allows better performance.

Enabled (default)	Enable cache
Disabled	Disable cache

Quick Power On Self Test

Select Enabled to reduce the amount of time required to run the power-on self-test (POST). A quick POST skips certain steps. We recommend that you normally disable quick POST. Better to find a problem during POST than lose data during your work.

Enabled (default)	Enable quick POST
Disabled	Normal POST

Boot From LAN First

During Enabled, If there's a LAN card onboard the priority from booting will be from the LAN.

Boot Sequence

This option determines the drive sequence the computer searches for the OS for at boot-up. The settings are “A, C, SCSI”, “C, A, SCSI”, “C, CDROM, A”, “CDROM, C, A”, “D, A, SCSI”, “E, A, SCSI”, “F, A, SCSI”, “SCSI, A, C”, “SCSI, C, A” or “C only”, “LS/ZIP, C”, etc. **The default is “A, C, SCSI”.**

Swap Floppy Drive

Switches the floppy disk drive between being designated as A and B.
Default is Disabled.

Boot Up Floppy Seek

During POST, BIOS will determine if the floppy disk drive installed is 40 or 80 tracks. 360K type is 40 tracks while 720K, 1.2M, and 1.44M are all 80 tracks.

Enabled (default)

BIOS searches for the floppy disk drive to determine if it is 40 or 80 tracks. Note that BIOS cannot tell from 720K, 1.2M or 1.44M drive type as they are all 80 tracks.

Disabled

BIOS will not search for the type of floppy disk drive by track number. Note that there will not be any warning message if the drive installed is 360K.

Boot Up NumLock Status

On (default)

Numpad is number keys.

Off

Numpad is arrow keys.

IDE HDD Block Mode

The chipset contains a PCI IDE interface with support for two IDE channels. Select Enabled to activate the primary and/or secondary IDE interface. Select Disabled to deactivate this interface, if you install a primary and/or secondary add-in IDE interface IDE interface. This set KB/Mouse wake up the system from power down.

Enabled (default)

Secondary HDD controller used.

Disabled

Secondary HDD controller not used.

Gate A20 Option

Gate A20 refers to the way the system address memory above 1 MB (extended memory). When set Fast, the system chipset controls Gate A20. When set to Normal, a pin in the Keyboard controller controls Gate A20. Setting Gate A20 to Fast improves system speed, particularly with OS/2 and Windows.

Fast (default)

Memory Parity/ECC Check

Select Enabled if the DRAM chips in your system support parity.

Enabled

Disabled (default)

Typematic Rate Setting

This determines the typematic rate.

Enabled

Enable typematic rate and typematic delay programming.

Disabled (default)

Disable typematic rate and typematic delay programming. The system BIOS will use default value and the keyboard controls the function.

Typematic Rate (Chars/Sec)

6 (default)	6 characters per second
8	8 characters per second
10	10 characters per second
12	12 characters per second
15	15 characters per second
20	20 characters per second
24	24 characters per second
30	30 characters per second

Typematic Delay (Msec)

Choose the length of delay from the time you press a key and the character repeating. (units are mil-sec)

Security Option

This category allows you to limit access to the system and Setup, or just to Setup.

System

The system will not boot and access to Setup will be denied if the correct password is not entered at the prompt.

Setup (default)

The system will boot, but access to Setup will be denied if the correct password is not entered at the prompt.

PCI/VGA Palette Snoop

Choose Disabled or Enabled. Some graphic controllers which are not VGA compatible take the output from a VGA controller and map it to their display as a way to provide boot information and VGA compatibility.

However, the color information coming from the VGA controller is drawn from the palette table inside the VGA controller to generate the proper colors, and the graphic controller needs to know what is in the palette of the VGA controller. To do this, the non-VGA graphic controller watches for the Write access to the VGA palette and registers the snoop data. In PCI based system, where the VGA controller is on the PCI bus and a non-VGA graphic controller is on an ISA bus, the Write Access to the palette will not show up on the ISA bus if the PCI VGA controller responds to the Write.

In this case, the PCI VGA controller should not respond to the Write, it should only snoop the data and permit the access to be forwarded to the ISA bus. The non-VGA ISA graphic controller can then snoop the data on the ISA bus. Unless you have the above situation, you should disable this option.

Enabled

Enables the function.

Disabled (default)

Disable the function.

OS Select for DRAM > 64MB

Allows OS/2 to be used with > 64MB of DRAM. Settings are Non-OS/2 and OS/2. Set to OS/2 if using more than 64MB and running OS/2.

DEFAULT is Non-OS2.

Report No FDD For WIN 95

This function is only use when you are testing SCT for Windows 95 Logo.

Video BIOS Shadow

Determines whether video BIOS will be copied to RAM for faster execution.

Enabled (default) Optional ROM is enabled.
Disabled Optional ROM is disabled.

C8000 - CFFFF Shadow / D0000 - DFFFF Shadow

Determines whether the optional ROM will be copied to RAM for faster execution.

Enabled Optional ROM is shadowed.
Disabled (default) Optional ROM is not shadowed.

Note : For C8000 - DFFFF option - ROM on PCI BIOS, BIOS will automatically enable the shadow RAM. User does not have to select the item.

2.4 Chipset Features Setup

The Chipset Features Setup option is used to change the values of the chipset registers. These registers control most of the system options in the computer.

■ Figure 4. Chipset Feature Setup Menu

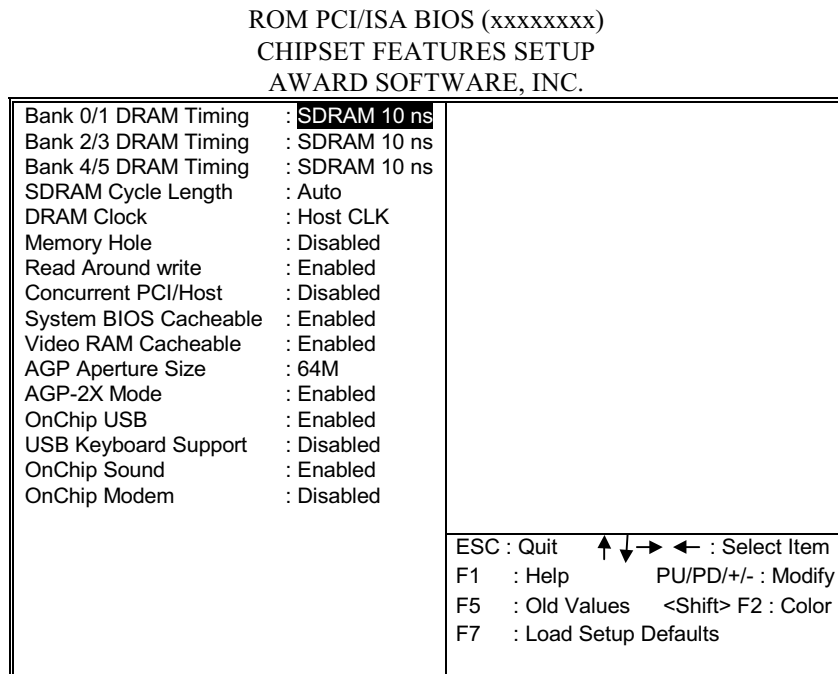

Bank 0/1, 2/3, 4/5, DRAM Timing

The DRAM timing of Bank 0/1, 2/3, 4/5 in this field is set by the system board manufacturer.

The Choices: Normal, Medium, Fast Turbo, 8ns, 10ns.

SDRAM Cycle Length

This field sets the CAS length timing.

The Choices: Auto, 2, 3.Disabled

DRAM Clock

This item determines DRAM Clock following the CPU host clock, or 66MHz..

Memory Hole

You can reserve this area of system memory for ISA adapter ROM. When this area is reserved, it cannot be cached. The user information of peripherals that need to use this area of system memory usually discusses their memory requirements.

The choice: Disabled (default).

Read Around write

DRAM optimization feature: If a memory read is addressed to a location whose latest write is being held in a buffer before being written to memory, the read is satisfied through the buffer contents, and the read is not sent to the DRAM.

The choice: Disabled, Enabled(default).

Concurrent PCI/Host

When disabled, CPU bus will be occupied during the entire PCI operation period.

The choice: Disabled(default), **Enabled**.

System BIOS Cacheable

When enabled, accesses to system BIOS ROM addressed at F0000H-FFFFFFH are cached, provided that the cache controller is enabled.

Video RAM Cacheable

Same as system BIOS Cacheable.

AGP Aperture Size

Select the size of the Accelerated Graphics Port (AGP) aperture. The aperture is a portion of the PCI memory address range dedicated for graphics memory address space. Host cycles that hit the aperture range are forwarded to the AGP without any translation.

The choice: 64M

AGP-2X Mode

This default is Enabled.

OnChip USB

This should be enabled if your system has a USB installed on the system board and you wish to use it. Even when so equipped, if you add a higher performance controller, you will need to disable this feature.

The choices: Enabled, Disabled.

USB Keyboard Support

Select Enabled if your system contains a Universal Serial Bus (USB) controller and you have a USB keyboard.

The choices: Enabled, Disabled.

OnChip Sound

The default setting of this item utilizes an onboard sound chip for audio output. There is no need to buy and insert a sound card. If sound card is installed, disable this item.

OnChip Modem

The default setting of this item utilizes an onboard modem chip for audio output. There is no need to buy and insert a modem card. If modem card is installed, disable this item.

2.5 Power Management Setup

■ Figure 5. Power Management Setup Menu

ROM PCI/ISA BIOS (xxxxxxx)
POWER MANAGEMENT SETUP
AWARD SOFTWARE, INC.

Power Management	: User Define	Primary INTR	: ON
PM Control by APM	: Yes	IRQ 3 (COM2)	: Primary
Video Off After	: Suspend	IRQ 4 (COM1)	: Primary
Video Off Method	: DPMS Supported	IRQ 5 (LPT2)	: Primary
MODEM Use IRQ	: 3	IRQ 6 (FDD)	: Primary
Soft-off by PWRBTN	: Instant-off	IRQ 7 (LPT1)	: Primary
PWRON After PW-Fail	: Former-Sts	IRQ 8 (Alarm)	: Disabled
HDD Power Down	: Disabled	IRQ 9 (Rsv)	: Secondary
Doze Mode	: Disabled	IRQ10 (Rsv)	: Secondary
Suspend Mode	: Disabled	IRQ11 (Rsv)	: Secondary
** PM Events **		IRQ12 (PS/2)	: Primary
VGA	: OFF	IRQ13 (CoPro)	: Primary
LPT & COM	: LPT / COM	IRQ14 (HDD)	: Primary
HDD & FDD	: ON	IRQ15 (Rsv)	: Disabled
PCI Master	: OFF		
Wake Up On LAN/Ring	: Disabled		
RTC Alarm Resume	: Disabled		
ESC : Quit ↑ ↓ → ← : Select Item F1 : Help PU/PD/+/- : Modify F5 : Old Values <Shift> F2 : Color F7 : Load Setup Defaults			

Power Management

User Define (default) (Max. Saving)	Users can configure their own power management.
Min Saving	Pre-defined timer values are used such that all timers are at their MAX value.
Max Saving	Pre-defined timer values are used such that all timers are at their MIN value.

PM Control by APM

No	System BIOS will ignore APM when Power Management is on.
Yes (default)	System BIOS will wait for ROM's prompt before it enters any PM mode.

Video Off After

The setting are M/A, Standby, Doze, or Suspend. This option is for choosing the setting in which the monitor will turn off.

N/A	Always turn on.
Doze	During Doze mode, the monitor will be turned off.
Standby	During Standby mode, the monitor will be turned off.
Suspend (default)	During Suspend mode, the monitor will be turned off.

Video Off Method

Blank Screen	The system BIOS will only blank the screen when disabling video.
V/H SYNC+Blank	In addition to the above, BIOS will also turn off the V-SYNC & H-SYNC signals from VGA card to monitor.
DPMS supported (default)	This function is enabled only for a VGA card supporting DPMS.

MODEM Use IRQ

This determines the IRQ, which the MODEM can use.

3 is (default)
4 / 5 / 7 / 9 / 10 / 11 / NA

Soft-off by PWRBTN

This item allows you to set the off power button function by software control.

Instant-off (default)

PWRON After PW-Fail

AC Power Supply provides power for whole system. ATX Power Supply "ON" and "OFF" can be controlled by motherboard. It is saved in south bridge chipset CMOS area are 3 sources provide current save this area; Mother board battery (3V), Power Supply (5VSB), Power Supply (3.3V). Before AC power cables not plug in, CMOS use motherboard (3V). After AC power connects in and Power Supply not open, CMOS use 5VSB in this mean time. Later, when we power ON Power Supply, CMOS use 3.3V.

Whit above controlled function CMOS, there CMOS 3 options which we can select from BIOS setup: "Formor-Sts", "On", "Off". "Formor-Sts" means follow last status of CMOS setting when AC power lost; failed "On", "Off". "Formor-Sts" means follow last status of CMOS setting when AC power lost; failed. "On" means always set CMOS in "On" status when AC power lost; failed. "Off" means always set CMOS in "Off" status when AC power lost; failed. For example: BIOS setup to "Formor-Sts". If AC power lost when system in power on "status, then after AC power retrieved, system will automatic power on. If AC power lost when system in "power off" status, then after AC power retrieved, system will still in power off status.

HDD Power Down

By default, this is Disabled, meaning that no matter the mode the rest of the system, the hard drive will remain ready. Otherwise, you have a range of choices from 1 to 15 minutes or Suspend. This means that you can elect to have your hard disk drive be turned off after a selected number of minutes or when the rest of the system goes into a suspend mode.

Disabled (default)

Doze Mode / Suspend Mode

The **Doze Mode**, and **Suspend Mode** fields set the Period of time after which each of these modes activate. At *Max Saving*, these modes activate sequentially (in the given order) after one minute; at *Min Saving* after one hour.

VGA

When set to On, any event occurring at a VGA port will awaken a system which has been powered down.

LPT & COM

When set to On, any event occurring at a COM(serial)/LPT (printer) port will awaken a system which has been powered down.

HDD & FDD

When set to On (default), any event occurring at a hard or floppy drive will awaken a system which has been powered down.

PCI Master

When set to On, any event occurring at PCI will awaken a system which has been powered down.

Wake Up On LAN/Ring

To use this function, you need a LAN add-on card which support power on function. It should also support the wake-up on LAN jump.

Disabled (default) Wake up on LAN/Ring not supported.

RTC Alarm Resume

When Enabled, you can set the date and time at which the RTC (real-time clock) alarm awakens the system from Suspend mode.

Primary INTR

When set to ON (default), any event occurring at Primary INTR will awaken a system which has been powered down.

The following is a list of IRQ, Interrupt ReQuests, which can be exempted much as the COM ports and LPT ports above can. When an I/O device wants to gain the attention of the operating system, it signals this by causing an IRQ to occur. When the operating system is ready to respond to the request, it interrupts itself and performs the service.

As above, the choices are On and OFF. Off is the default.

When set On, activity will neither prevent the system from going into a power management mode nor awaken it.

IRQ3	(COM2)
IRQ4	(COM1)
IRQ5	(LPT2)
IRQ6	(FDD)
IRQ7	(LPT1)
IRQ8	(Alarm)
IRQ9	(Rsv)
IRQ10	(Rsv)
IRQ11	(Rsv)
IRQ12	(PS/2)
IRQ13	(CoPro)

IRQ14	(HDD)
IRQ15	(Rsv)

2.6 PNP / PCI Configuration Setup

■ Figure 6. PNP / PCI Configuration Setup Menu

ROM PCI/ISA BIOS (xxxxxxx)
 PNP / PCI FUNCTION SETUP
 AWARD SOFTWARE, INC.

PNP OS Installed	: Yes	CPU to PCI Write Buffer	: Enabled
Resources Controlled By	: Manual	PCI Dynamic Bursting	: Enabled
Reset Configuration Data	: Disabled	PCI Master 0 WS Write	: Enabled
IRQ-3 Assigned to	: PCI/ISA PnP	PCI Delay Transaction	: Enabled
IRQ-4 Assigned to	: PCI/ISA PnP	PCI#2 Access #1 Retry	: Disabled
IRQ-5 Assigned to	: PCI/ISA PnP	AGP Master 1 WS Write	: Enabled
IRQ-7 Assigned to	: PCI/ISA PnP	AGP Master 1 WS Read	: Disabled
IRQ-9 Assigned to	: PCI/ISA PnP	Assign IRQ For USB	: Enabled
IRQ-10 Assigned to	: PCI/ISA PnP	Assign IRQ For VGA	: Enabled
IRQ-11 Assigned to	: PCI/ISA PnP		
IRQ-12 Assigned to	: PCI/ISA PnP		
IRQ-14 Assigned to	: PCI/ISA PnP		
IRQ-15 Assigned to	: PCI/ISA PnP		
DMA-0 Assigned to	: PCI/ISA PnP		
DMA-1 Assigned to	: PCI/ISA PnP	ESC : Quit	↑ ↓ → ← : Select Item
DMA-3 Assigned to	: PCI/ISA PnP	F1 : Help	PU/PD/+/- : Modify
DMA-5 Assigned to	: PCI/ISA PnP	F5 : Old Values	<Shift> F2 : Color
DMA-6 Assigned to	: PCI/ISA PnP	F7 : Load Setup Defaults	
DMA-7 Assigned to	: PCI/ISA PnP		

PNP OS Installed

When set to YES, BIOS will only initialize the PnP cards used for booting (VGA, IDE, SCSI). The rest of the cards will be initialized by the PnP operating systems, like Windows™95. When set to NO, BIOS will initialize all the PnP cards. Therefore for non-PnP operating system (DOS, Netware™), this option must set to "NO".

Resources Controlled By “Auto” or “Manual”

By Choosing “Auto” the system BIOS will detect the system resource and automatically assign the relative IRQ and DMA channel for each peripheral.

By Choosing “Manual”, the user will need to assign IRQ & DMA for add-on cards. Be sure that there are no IRQ/DMA and I/O port conflicts.

Reset Configuration Data

The system BIOS supports the PnP feature so the system needs to record which resource is assigned and protect resources from conflicts. Every peripheral device has a node which is called ESCD. This node records which resources are assigned to it. The system needs to record and update ESCD to the memory locations. These locations (4K) are reserved at the system BIOS.

If Disabled (default) is chosen, the system’s ESCD will update only when the new configuration varies from the last one.

If Enabled is chosen, the system is forced to update ESCDs and then is automatically set to the “Disabled” mode.

The above settings will be shown on the screen only if “Manual” is chosen for the Resources Controlled By function.

Legacy is the term which signifies that a resource is assigned to the ISA Bus and provides for non PnP ISA add-on cards. PCI / ISA PnP signifies that a resource is assigned to the PCI Bus or provides for ISA PnP add-on cards and peripherals.

CPU to PCI Write Buffer

When enabled, up to four Dwords of data. Can be written to the PCI bus without interrupting the CPU. When disabled, a write buffer is not used and the CPU read cycle will not be completed until the PCI bus signals that it is ready to receive the data.

PCI Dynamic Bursting

When Enabled, every write transaction goes to the write buffer. Burstable transactions the burst on the PCI bus and nonburstable transactions don't.

PCI Master 0 WS Write

When Enabled, writes to the PCI bus are executed with zero-wait stats.

PCI Delay Transaction

The chipset has an embedded 32-bit posted write buffer to support delay

transactions cycles. Select Enabled to support compliance with PCI specification.

PCI #2 Access #1 Retry

This item allows you to enable/disable the PCI #2 Access #1 Retry.

AGP Master 1 WS Write

This implements a single delay when writing to the AGP Bus. By default, two-wait states are used by the system, allowing for greater stability.

AGP Master 1 WS Read

This implements a single delay when writing to the AGP Bus. By default, two-wait states are used by the system, allowing for greater stability.

Assign IRQ For USB

Lets the user choose which IRQ to assign for USB.

Assign IRQ For VGA

Lets the user choose which IRQ to assign for the VGA.

2.7 Load SETUP Defaults

Chipset defaults indicate the values required by the system for maximum performance.

■ **Figure 7. Load SETUP Defaults Screen**

ROM PCI/ISA BIOS (xxxxxxxx)
CMOS SETUP UTILITY
AWARD SOFTWARE, INC.

STANDARD CMOS SETUP	CPU SPEED SETTING
BIOS FEATURES SETUP	INTEGRATED PERIPHERALS
CHIPSET FEATURES SETUP	SUPERVISOR PASSWORD
POWER MANAGEMENT SETUP	USER PASSWORD
PCI & PCI CO	DETECTION
LOAD SETUP	Load SETUP Defaults (Y/N) ? N
Esc : Quit F5 : Mean in BIOS ↑ ↓ → ← : Select Item F10 : Save & Exit Setup (Shift) F2 : Change Color	
Load Setup Defaults except Standard CMOS SETUP	

If you wish to load the SETUP Defaults, change the prompt to <Y> and press <ENTER>.

2.8 CPU Speed Setting

■ Figure 8.CPU Speed Setting Menu

ROM PCI/ISA BIOS (xxxxxxx)
CPU SPEED SETTING
AWARD SOFTWARE, INC.

Cpu Host Clock (CPU/PCI) : Hardware Show H/W Monitor in POST : 3 Sec Current CPUFAN1 Speed : Current CPUFAN2 Speed : Vcore : + 2.5V : + 3.3V : + 5.0V : + 12.0V :	ESC : Quit ↑ → ↓ ← : Select Item F1 : Help PU/PD/+/- : Modify F5 : Old Values <Shift> F2 : Color F7 : Load Setup Defaults
---	---

CPU Host Clock (CPU/PCI)

The item allows you select CPU Host / PCI clock.

Show H/W Monitor in POST

If you computer contain a monitoring system, it will show PC health status during POST stage. The item offers several delay time to select you want.

3 set (default)

Current CPU FAN1 Speed

Detects CPU Fan1 speed status automatically.

Current CPU FAN2 Speed

Detects CPU Fan2 speed status automatically.

Current Vcore, +2.5V, +3.3V, +5.0V, +12.0V

Detects System Voltage automatically.

2.9 Integrated Peripherals Setup

■ Figure 9. Integrated Peripherals Setup Menu

ROM PCI/ISA BIOS (xxxxxxx)
 INTEGRATED PERIPHERALS
 AWARD SOFTWARE, INC.

OnChip IDE Channel 0	: Enabled	Onboard Parallel Mode	: Normal
OnChip IDE Channel 1	: Enabled		
IDE Prefetch Mode	: Enabled		
Primary Master PIO	: Auto	Onboard Legacy Audio	: Enabled
Primary Slave PIO	: Auto	Sound Blaster	: Enabled
Secondary Master PIO	: Auto	SB I/O Base Address	: 220H
Secondary Slave PIO	: Auto	SB IRQ Select	: IRQ5
Primary Master UDMA	: Auto	SB DMA Select	: DMA 1
Primary Slave UDMA	: Auto	MPU-401	: Enabled
Secondary Master UDMA	: Auto	MPU-401 I/O Address	: 330-333H
Secondary Slave UDMA	: Auto	Game Port (200-207H)	: Enabled
Init Display First	: AGP		
Onboard FDD Controller	: Enabled		
Onboard Serial Port 1	: 2F8/IRQ4		
Onboard Serial Port 2	: 2F8/IRQ3		
UART 2 Mode	: Standard		
Onboard Parallel Port	: 378/IRQ7		
		ESC : Quit	↑ ↓ ← → : Select Item
		F1 : Help	PU/PD/+/-: Modify
		F5 : Old Values	<Shift> F2 : Color
		F7 : Load Setup Defaults	

OnChip IDE Channel 0

This chipset contains a PCI IDE interface with support for two IDE channels. Select Enabled to activate the first and/or second IDE interface. Select Disabled to deactivate an interface, if you install a primary and/or secondary add-in IDE interface.

OnChip IDE Channel 1

This chipset contains a PCI IDE interface with support for two IDE channels. Select Enabled to activate the first and/or second IDE interface. Select Disabled to deactivate an interface, if you install a primary and/or secondary add-in IDE interface.

IDE Prefetch Mode

The onboard IDE drive interfaces supports IDE prefetching, for faster drive accesses. If you install a primary and/or secondary add-in IDE interfaces, set this field to Disabled if the interface does not support prefetching.

The choices: Enabled(default) ,Disabled.

Primary / Secondary Master / Slave PIO

The IDE PIO (Programmed Input / Output) fields let you set a PIO mode (0-4) for each of the IDE devices that the onboard IDE interface supports. Modes 0 through 4 provide successively increased performance. In Auto mode, the system automatically determines the best mode for each device.

Auto (default)

Primary / Secondary Master / Slave UDMA

Ultra DMA /33 implementation is possible only if your IDE hard drive supports it and the operating environment includes a DMA drive (Windows 95 OSR2 or a third party IDE bus master driver). If your hard drive and your system software both support Ultra DMA/33, select Auto to enable BIOS support.

Init Display First

The item allows you to decide to active PCI Slot or AGP first.

The choice: PCI Slot, AGP (default)

Onboard FDD Controller

Enabled/Disabled The system has an on-board Super I/O chip with a FDD controller that supports 2 FDDs for 360K/720K/1.2M/1.44M/2.8M. Choose “Enabled” to use the on-board FDD controller for accessing the FDD. Otherwise choose “Disabled” to use the off-board FDD controllers.

Onboard Serial Port 1

Disabled / (3F8 / IRQ4) / (2F8 / IRQ3) / (3E8 / IRQ4) / (2E8 / IRQ3)

The system has an Onboard Super I/O chipset with 1 serial ports.

The Onboard serial ports can be selected as:

Disabled

3F8 / IRQ4 COM1 uses IRQ4

2F8 / IRQ3 COM2 uses IRQ3

3E8 / IRQ4 COM3 uses IRQ4

2E8 / IRQ3 COM4 uses IRQ3

Onboard Serial Port 2

Disabled / (3F8 / IRQ4) / (2F8 / IRQ3) / (3E8 / IRQ4) / (2E8 / IRQ3)

The system has an Onboard Super I/O chipset with 2 serial ports.

The Onboard serial ports can be selected as:

Disabled

3F8 / IRQ4 COM1 uses IRQ4

2F8 / IRQ3 COM2 uses IRQ3

3E8 / IRQ4 COM3 uses IRQ4

2E8 / IRQ3 COM4 uses IRQ3

UART2 Mode

This item allow you to determine which Infra Red(IR) function of onboard I/O chip.

Onboard Parallel Port

This item allows you to determine access onboard parallel port controller with which I/O address.

The choice : 378/IRQ7, 278/IRQ5, 3BC/IRQ7, Disabled.

Onboard Parallel Mode

Select EPP Port type EPP, ECP, ECP/EPP, Normal (default).

Onboard Legacy Audio

Select an operating mode for the second serial port:

The choices: Enabled (default) , Disabled.

Sound Blaster

Hardware SoundBlaster Pro for Windows DOS box and real-mode DOS legacy compatibility.

SB I/O Base Address

Change the SoundBlaster Pro Base I/O Address settings.

SB IRQ Select

Change the SoundBlaster Pro interrupt signal.

SB DMA Select

Change the SoundBlaster Pro direct memory access setting.

MPU-401

Change the SoundBlaster Pro direct memory access setting.

MPU-401 I/O Address

Enable or Disable MPU-401 option.

Game Port (200-207H)

Change the joystick connect port address.

2.10 Supervisor / User Password Setting

■ Figure 10. Supervisor Password Setting

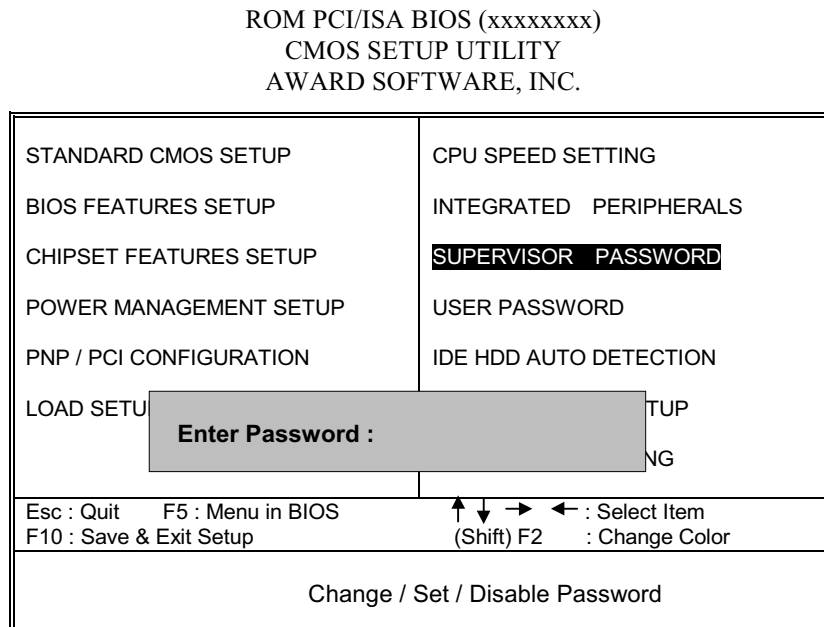

When you select this function, the following message will appear at the center of the screen to assist you in creating a password.

ENTER PASSWORD

Type the password, up to eight characters, and press <Enter>. The password you type now will clear any previously entered password from CMOS memory. You will be asked to confirm the password. Type the password again and press <Enter>. You may also press <ESC> to abort the selection and not enter a password. To disable password, just press <Enter> when you are prompted to

enter password. A message will confirm that you wish to disable the password. Once the password is disabled, the system will boot and you can enter setup freely.

PASSWORD DISABLED

If you select “System” at the Security Option of BIOS Features Setup Menu, you will be prompted for the password every time the system is rebooted or any time you try to enter Setup. If you select “Setup” at Security Option of BIOS Feature Setup Menu, you will be prompted only when you try to enter Setup.

2.11 IDE HDD Auto Detection

Automatically configures hard disk parameters. The parameters shown below are only examples.

■ **Figure 11. Auto Configuration with Optimal Settings Screen**

ROM PCI/ISA BIOS (xxxxxxx)
CMOS SETUP UTILITY
AWARD SOFTWARE, INC.

HARD DISKS	TYPE	SIZE	CYLS	HEAD	PRECOMP	LAND	SECTOR	MODE
Primary Master :								
Select Primary Slave Option (N=Skip) N								
OPTIONS	SIZE	CYLS	HEAD	PRECOMP	LANDZ	SECTOR	MODE	
1(Y)	0	0	0	0	0	0	NORMAL	
Note : Some Oses (SCO-UNIX Before v5.0) must use "NORMAL" for installation								
ESC : Skip								

When you enter this utility, the screen asks you to select a specific hard disk for Primary Master. If you accept a hard disk detected by the BIOS, you can enter "Y" to confirm and then press <Enter> to check next hard disk. This function allows you to check four hard disks and you may press the <Esc> after the <Enter> to exit this function and go back to the Main Menu.

2.12 Save & Exit Setup

Save CMOS value changes to CMOS and exit setup.

■ Figure 12. Save & Exit Setup Screen

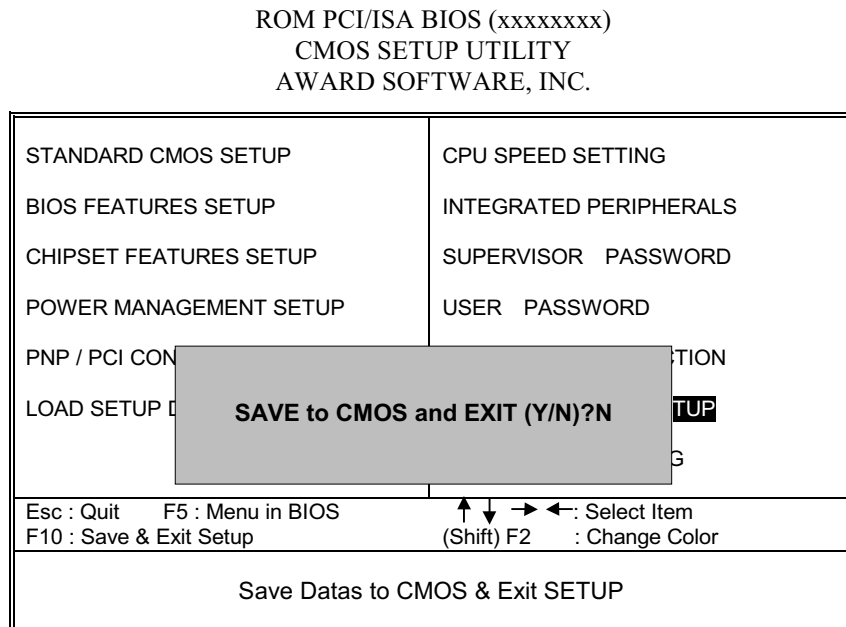

Pressing <N> and <ENTER> will return you to the Main Menu.

Pressing <Y> and <ENTER> will save the system parameters and continue with the booting process.

2.13 Exit Without Saving

Abandon all CMOS value changes and exit setup.

■ **Figure 13. The Save Settings and Exit Screen**

ROM PCI/ISA BIOS (xxxxxxx)
CMOS SETUP UTILITY
AWARD SOFTWARE, INC.

STANDARD CMOS SETUP	CPU SPEED SETTING
BIOS FEATURES SETUP	INTEGRATED PERIPHERALS
CHIPSET FEATURES SETUP	SUPERVISOR PASSWORD
POWER MANAGEMENT SETUP	USER PASSWORD
PNP / PCI CONFIGURATION	
LOAD SETUP	
Quit Without Saving (Y/N)?N	
Esc : Quit F5 : Menu in BIOS ↑ ↓ → ← : Select Item F10 : Save & Exit Setup (Shift) F2 : Change Color	
Abandon All Datas & Exit SETUP	

Pressing **<N>** and **<ENTER>** will return you to the Main Menu.

Pressing **<Y>** and **<ENTER>** will continue with booting process without saving any system parameters.

2.14 Application Software

- Please use the "BIOS Utility" diskette to setup Flash Memory.
- The diskette contains the intelligent utility **AWDFLASH.EXE**, displayed below.

■ **Figure 14. Flash Memory Writer**

FLASH MEMORY WRITER Vxx Copyright (C) 1992-1994 Award Software, Inc.,	
For xx-xxxxxxxxxxxxxxxxxxxx	DATE: xx/xx/xxxx
Flash Type -	
File Name to Program:	<input type="text"/>
Error Message :	Do You Want To Save Bios (Y/N)?

3. Software Setup

NOTE: The mark * means it can be installed directly from CD by using CD Installation Utility (i.e. START.EXE).

3.1 Software List

Category	Description	Platform	Location in CD
VIA IRQ Routing Miniport Patch *	Used for enable PCI bus IRQ Steering function.	Windows 95/98	\Mb_drv\Nirq
Chipset Functions' Registry Utility *	Used for patching Windows 95's Registry System to let Windows 95 recognizes new devices.	Windows 95	\Mb_drv\ Registry
VIA Hardware Monitor *	VIA Hardware Monitor is a self-diagnostic system for PC.	Windows 95/98	\Mb_drv\ Sysdiag
VIA AGP VxD Driver *	Install the drivers to support AGP interface VGA Card	Windows 95/98	\Mb_drv\Agp
HighPoint XStore Pro *	Install the drivers to support Ultra DMA mode Hard Drive.	Windows 95/98	\Mb_drv\XStore
VIA Bus Master IDE Drivers *	Install the drivers to support Ultra DMA mode Hard Drive.	Windows 95 / 98 / NT 4.0	\Mb_drv\Ide
VIA AC97 Audio*	Install the driver to enable the VIA AC97 Audio Device	DOS, Windows 95/98/NT4.0/ 2000	\Audio\Ac97
Award Flash Utility	Used for updating BIOS.		\Flash

3.2 Software Installation

We provide an installation wizard, Driver CD Installation Utility (START.EXE), located in the root of Driver CD to let users install some common used drivers conveniently.

➤ **The drivers can be installed from CD by using CD Installation Utility:**

You can simply put Driver CD into CD-ROM drive and the Installation Utility will autorun or you can run the Driver CD Installation Utility directly by using mouse cursor to click the proper option on the page. Utility will invoke other applications to complete the rest of installation.

➤ **The drivers CAN NOT be installed directly from CD by using CD Installation Utility:**

Please read the README.TXT located in the root directory on Multimedia CD to get drivers' location and then refer to the INSTALL.TXT or README.TXT files located in each driver directory on the Driver CD to install drivers.

3.3 Using Software

- In general, you can get more detailed information in the on-line help or readme for the softwares.

- **Using VIA Hardware Monitor**

After the utility is installed, you can follow the sequence, **Start -> Program -> VIA Hardware Monitor System**, to launch the monitor application.

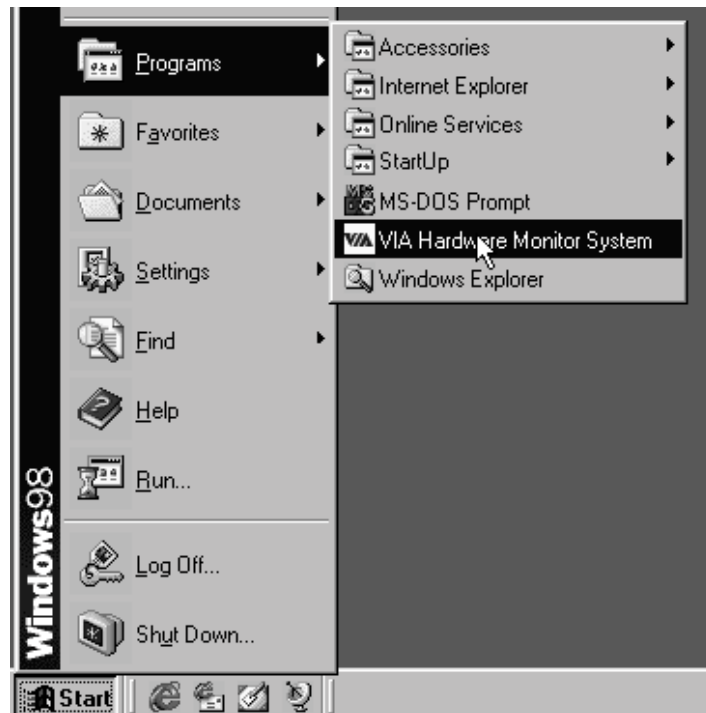

The following figure is the main panel of VIA Hardware Monitor. In the panel, you can get some real-time and important information -- Voltage, Fan speed, and temperature, for example. If there is an abnormal situation, you can resolve it immediately.

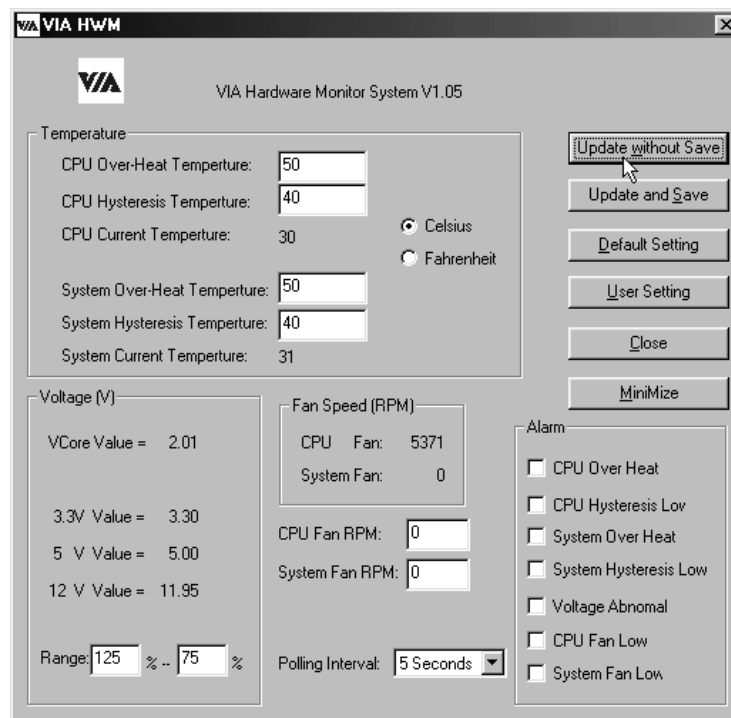

4. Trouble Shooting

PROBLEM

No power to the system at all. Power light does not illuminate, fan inside power supply does not turn on. Indicator light on keyboard does not turn on.

PROBABLE CAUSE	DIAGNOSIS	SOLUTION
Power cable is unplugged.	Visually inspect power cable.	Make sure power cable is securely plugged in.
Defective power cable.	Visual inspection, try another cable.	Replace cable.
Power supply failure.	Power cable and wall socket are OK, but system is still dead.	Contact technical support.
Faulty wall outlet; circuit Breaker or fuse blown.	Plug in device known to work in socket and test.	Use different socket, repair outlet, reset circuit breaker or replace fuse.

PROBLEM

System inoperative. Keyboard lights are on, power indicator lights are lit, hard drive is spinning.

PROBABLE CAUSE	DIAGNOSIS	SOLUTION
Expansion card is partially dislodged from expansion slot on the motherboard.	Turn off computer. Take cover off system unit. Check all expansion cards to ensure they are securely seated in slots.	Using even pressure on both ends of the expansion card, press down firmly on expansion card.
Defective floppy disk drive or tape drive.	Turn system off. Disconnect the cables from one of the floppy drives. Turn on the floppy drives. Turn on the system, check to see if the keyboard operates normally. Repeat until you have located defective unit.	Contact Technical Support.
Defective expansion card.	Turn computer off. Remove an expansion card.	Make sure expansion card is secure in expansion socket.

PROBLEM

System does not boot from hard disk drive, can be booted from floppy disk drive.

PROBABLE CAUSE	DIAGNOSIS	SOLUTION
Connector between hard drive and system board unplugged.	When attempting to run the FDISK utility described in the HARD DISK section of this manual you get a message, INVALID DRIVE SPECIFICATION.	Check cable running from disk to disk controller board. Make sure both ends are securely plugged in; check the drive type in the Standard CMOS Setup (see HARD DISK section of this manual).
Damaged Hard Disk or Disk Controller.	Format hard disk; if unable to do so the hard disk may be defective.	Contact Technical Support.
Hard Disk directory or FAT is scrambled.	Run the FDISK program, format the hard drive (see HARD DRIVE section of manual). Copy data that was backed up onto Hard Drive.	Backing up the hard drive is extremely important. All Hard Disk are capable of breaking down at any time.

PROBLEM

System only boots from floppy Disk. Hard disk can be read and applications can be used but booting from Hard Disk is impossible.

PROBABLE CAUSE	DIAGNOSIS	SOLUTION
Hard Disk boot program has been destroyed.	A number of causes could be behind this.	Back up data and applications files. Reformat the Hard Drive as described in the Hard Drive section of this manual. Re-install applications and data using backup disks.

PROBLEM

Error message reading "SECTOR NOT FOUND" or other error messages not allowing certain data to be retrieved.

PROBABLE CAUSE	DIAGNOSIS	SOLUTION
A number of causes could be behind this.	Use a file by file backup instead of an image backup in order to backup the Hard Disk.	Back up any salvageable data. Then low level format, partition, and high level format the hard drive (see Hard Disk section of this manual for instructions). Re-install all saved data when completed.

PROBLEM

Disk formatted on IBM PS/2 will not operate with this system.

PROBABLE CAUSE	DIAGNOSIS	SOLUTION
The IBM PS/2 uses a different format than other computers.	IBM PS/2 disk format will not work in an AT type computer.	Format disk in the AT type computer insert disk into the IBM PS/2 and copy the files you wish.

PROBLEM

After installing an expansion card (network card, tape drive card, etc.) the system no longer works properly.

PROBABLE CAUSE	DIAGNOSIS	SOLUTION
No power to monitor.	All or part of the system may be inoperable. The new card may work but a mouse or COM port may not work.	Change the interrupt or RAM address on the new expansion card. See the documentation that came with the new card in order to change pin settings. Many expansion devices come with proprietary software that will assist you in doing this.

PROBLEM

Screen message says "Invalid Configuration" or "CMOS Failure."

PROBABLE CAUSE	DIAGNOSIS	SOLUTION
Incorrect information entered into the configuration (setup) program.	Check the configuration program. Replace any incorrect information.	Review system's equipment . Make sure correct information is in setup.

PROBLEM

Screen is blank.

PROBABLE CAUSE	DIAGNOSIS	SOLUTION
No power to monitor.		Check the power connectors to monitor and to system. Make sure monitor is connected to display card, change I/O address on network card if applicable.
Monitor not connected to computer.		See instructions above.
Network card I/O address conflict.		See instructions above.

PROBLEM

PROBABLE CAUSE	DIAGNOSIS	SOLUTION
Memory problem, display card jumpers not set correctly.		Reboot computer. Reinstall memory, make sure that all memory modules are installed in correct sockets. Check jumper and switch settings on display card. See display card section for information on settings.
Computer virus.		Use anti-virus programs (McAfee, E-Prot, etc) to detect and clean viruses.

PROBLEM

Screen goes blank periodically.

PROBABLE CAUSE	DIAGNOSIS	SOLUTION
Screen saver is enabled.		Disable screen saver.

PROBLEM

Keyboard failure.

PROBABLE CAUSE	DIAGNOSIS	SOLUTION
Keyboard is disconnected.		Reconnect keyboard. Check keys again, if no improvement replace keyboard.

PROBLEM

No color on screen.

PROBABLE CAUSE	DIAGNOSIS	SOLUTION
Faulty Monitor.		If possible, connect monitor to another system. If no color replace monitor.
CMOS incorrectly set up.		Call technical support.

PROBLEM

Floppy drive light stays on.

PROBABLE CAUSE	DIAGNOSIS	SOLUTION
Floppy Drive cable not connected correctly.		Reconnect floppy cable making sure PIN1 on the Floppy Drive corresponds with PIN1 on Floppy cable connector.

PROBLEM

Error reading drive A:

PROBABLE CAUSE	DIAGNOSIS	SOLUTION
Bad floppy disk.		Try new floppy disk
Floppy disk not formatted.		Format floppy disk (type FORMAT A: type ENTER) >.

PROBLEM

C: drive failure.

PROBABLE CAUSE	DIAGNOSIS	SOLUTION
SETUP program does not have correct information.		Boot from drive A: using DOS system disk. Input correct information to SETUP program.
Hard Drive cable not connected properly.		Check Hard Drive cable.

PROBLEM

Cannot boot system after installing second hard drive.

PROBABLE CAUSE	DIAGNOSIS	SOLUTION
Master/Slave jumpers not set correctly.		Set Master/Slave jumpers correctly.
Hard Drives not compatible / different manufacturers.		Run SETUP program and select correct drive types. Call Drive manufacturers for compatibility with other drives.

PROBLEM

Missing operating system on hard drive.

PROBABLE CAUSE	DIAGNOSIS	SOLUTION
CMOS setup has been changed.		Run setup and select correct drive type.

PROBLEM

Certain keys do not function.

PROBABLE CAUSE	DIAGNOSIS	SOLUTION
Keys jammed or defective.		Replace keyboard.

PROBLEM

Keyboard is locked, no keys function.

PROBABLE CAUSE	DIAGNOSIS	SOLUTION
Keyboard is locked.		Unlock keyboard.

09/13/1999
MADE IN TAIWAN
R.O.C.