

Federal Communications Commission (F.C.C) Statement

This device complies with Part 15 of the FCC Rules. Operation of this device is subject to the following two conditions: (1) this device may not cause harmful interference, and (2) this device must accept any interference received, including interference that may cause undesired operation.

Accessories: This device has been tested and found to comply with the limits of a Class B digital device, the accessories associated with this equipment are as follows:

1. Shielded serial cable. (Can be obtained from multiple retail outlets)
2. Shielded printer cable. (Can be obtained from multiple retail outlets)
3. Shielded video cable. (Can be obtained from multiple retail outlets)
4. Shielded power cord. (Provided by manufacturer)

These accessories are required to be used in order to ensure compliance with FCC Rules. It is the responsibility of the user to provide and use these accessories properly.

This equipment has been tested and found to comply with the limits of a Class B digital device, pursuant to Part 15 of the FCC Rules. These limits are designed to provide reasonable protection against harmful interference in a residential installation. This equipment generates, uses and can radiate radio frequency energy and, if not installed and used in accordance with the instructions, may cause harmful interference to radio communications. However, there is no guarantee that interference will not occur in a particular installation. If this equipment does cause harmful interference to radio or television reception, which can be determined by turning the equipment off and on, the user is encouraged to try to correct the interference by one or more of the following measures:

1. Reorient / Relocate the receiving antenna.
 2. Increase the separation between the equipment and receiver.
 3. Connect the equipment into an outlet on a circuit different from that to which the receiver is connected.
 4. Consult the dealer or an experienced radio/TV technician for help.
-

Caution: Changes or modifications not expressly approved by the manufacturer could void the user's authority to operate the equipment.

Disclaimer

The Vendor makes no representations or warranties with respect to the contents hereof and specially disclaims any implied warranties of merchantability or fitness for any purpose. Further the Vendor reserves the right to revise this publication and to make changes from time to time in the contents hereof without obligation to notify any party beforehand. Duplication of this publication, in part or in whole, is not allowed without first obtaining the Vendor's approval in writing.

Trademarks and Remarks

MS-DOS, Windows, Windows NT, and Windows 95 are products of Microsoft Corp, with its ownership of trademark, and are distributed by the Vendor under a license agreement.

All trademarks used in this manual are the property of their respective owners.

Copyright(C) 1992 All Rights Reserved

Canadian D.O.C. Statement

This digital apparatus does not exceed the Class B limits for radio noise emissions from digital apparatus as set out in the radio interference regulations of the Canadian Department of Communications.

And Le present appareil numerique n'emet pas de bruits radioelectriques depassant les limites appliques aux appareils numeriques de Class B prescripts Dan le regalement usr le brouillage radioelectrique edict par le minister Des Communications du Canada.

Contents

Introduction	1-1
1 Motherboard Description	1-2
1.1 Features	1-2
1.1.1 Hardware	1-2
1.1.2 Software.....	1-5
1.1.3 Attachments.....	1-5
1.2.1 Layout of Motherboard	1-6
1.3 Motherboard Connectors.....	1-7
1.3.1 Front Panel Connectors (J14)	1-7
1.3.2 Back Panel Connectors.....	1-8
1.4 CPU Installation/Jumper Setting.....	1-9
1.4.1 CPU Installation Procedure.....	1-11
1.4.2 CPU Clock Selection (JP4)	1-14
1.5 Jumper Settings.....	1-15
1.5.1 CMOS Function Selection (JP3)	1-15
1.5.2 CPU Cooling Fan Power Connector (J6)	1-17
1.5.3 Wake-On-LAN Header (J9)	1-18
1.5.4 Wake-On-Internal Modem (J16)	1-19
1.5.5 Chassis Fan Connector (J13).....	1-20
1.5.6 SR1 CPU Temperature Sensor Resistor	1-21
1.6 DRAM Installation.....	1-22
1.6.1 DIMM	1-22

Contents

1.6.2 How to install a DIMM Module	1-24
1.7 Connectors	1-25
1.7.1 Motherboard Connector	1-25
1.7.2 Floppy Disk Connector (J10)	1-26
1.7.3 Hard Disk Connector (J11/J12).....	1-27
1.7.4 ATX 20-pin Power Connector (J7)	1-28
1.7.5 Mouse/Keyboard Connector.....	1-29
1.7.6 USB Connector (J2)	1-30
1.7.7 Serial(J3/J4) and Parallel Interface Ports (J5)	1-31
2. Motherboard Software.....	2-1
2.1 Software List	2-1
2.2 Software Installation	2-2
2.3 Using Software.....	2-3
3. AWARD BIOS Setup	3-1
3.1 Main Menu.....	3-3
3.2 Standard CMOS Setup Menu.....	3-6
3.3 BIOS Features Setup	3-11
3.4 Chipset Features Setup.....	3-17
3.5 Power Management Setup.....	3-20
3.6 PNP / PCI Configuration Setup.....	3-25
3.7 Load Setup Defaults	3-29
3.8 Integrated Peripherals Setup	3-30

Contents

3.9 CPU Features Setup	3-34
3.10 Supervisor / User Password Setting	3-36
3.11 IDE HDD Auto Detection.....	3-38
3.12 Save & Exit Setup	3-39
3.13 Exit Without Saving.....	3-40
3.14 Application Software	3-41
4.Trouble Shooting	4-1

Introduction

System Overview

Thanks for buying this product! This manual was written to help you start using this product as quickly and smoothly as possible. Inside you will find adequate explanations to solve most problems. In order for this reference material to be of greatest use, refer to the “expanded table of contents” to find relevant topics.

This board incorporates the system board, ISA I/O, and PCI IDE into one board that provides a total PC solution. The mainboard, a Pentium II™ micro-processor based PC/ATX system, supports single processors with ISA Bus, PCI Local Bus, and AGP Bus to support upgrades to your system performance. It is ideal for multi-tasking and fully supports MS-DOS, Windows, Windows NT, Novell, OS/2, Windows95/98, UNIX, SCO UNIX etc. This manual also explains how to install the mainboard for operation, and how to setup your CMOS configuration with the BIOS setup program.

1 Motherboard Description

1.1 Features

1.1.1 Hardware

CPU

- The Pentium II™ /Celeron™ micro-processor provides the processing power for the new generation of high-end workstations and servers.
- Slot 1 compliant.

Speed

- Supports from 233MHz to 550MHz CPU speed.
- Supports 33MHz PCI Bus speed.
- I/O clock 8MHz for ISA Bus.
- Supports 66MHz / 133MHz AGP Bus.

DRAM Memory

- Supports 8/16/32/64.....MB DIMM module socket.
- Supports Synchronous DRAM (3.3V).
- Supports a maximum memory size of 384MB with SDRAM.

Green Function

- Supports power management operation via BIOS.
- Wakes from power saving sleep mode at the press of any key or any mouse activity.

Shadow RAM

- A memory controller provides shadow RAM and supports 8-bit ROM BIOS.

BUS Slots

- Provides three 16-bit ISA Bus slots, four PCI Bus slots, and one AGP Bus slot.

Flash Memory

- Supports flash memory.
- Supports ESCD Function.

PCI Enhanced IDE Built-in On Board

- Supports four IDE hard disk drives.
- Supports PIO Mode 4, Master Mode, high performance hard disk drives.
- Supports Ultra DMA/33, Bus Master Mode.
- Supports IDE interface with CD-ROM.
- Supports high capacity hard disk drives.
- Supports LBA mode.

ISA I/O Built-in On Board

- Supports one multi-mode Parallel Port.
 - (1) Standard & Bidirection Parallel Port.
 - (2) Enhanced Parallel Port (EPP).
 - (3) Extended Capabilities Port (ECP).
- Supports two serial ports, 16550 UART.
- Supports one Infrared transmission (IR). (optional)
- Supports PS/2 Mouse.
- Supports 360KB, 720KB, 1.2MB, 1.44MB, and 2.88MB floppy disk drivers.

Universal Serial Bus

- Supports two Universal Serial Bus (U.S.B.) Ports.
- Supports 48 MHz USB.

Dimensions(ATX form-factor)

- 30.5 cm X 20 cm (W x L)

Hardware Monitor Function(Optional)

- CPU Fan Speed Monitor
- System and CPU Temperature Monitor
- System Voltage Monitor

1.1.2 Software

BIOS

- AWARD legal BIOS.
- Supports APM1.2.
- Supports USB Function.

Operating System

- Offers the highest performance for MS-DOS, OS/2, Windows, Windows NT, Windows 95/98, Novell, UNIX, SCO UNIX etc.

1.1.3 Attachments

Attachments

- HDD Cable
- FDD Cable
- Flash Memory Writer for BIOS Update
- Retention Kits for CPU
- IDE and Hardware Monitor Setup Driver CD
- Rear I/O panel for ATX Case (optional)

1.2 Motherboard Installation

1.2.1 Layout of Motherboard

Model No.M6VBA Ver:1.3 and afterwards

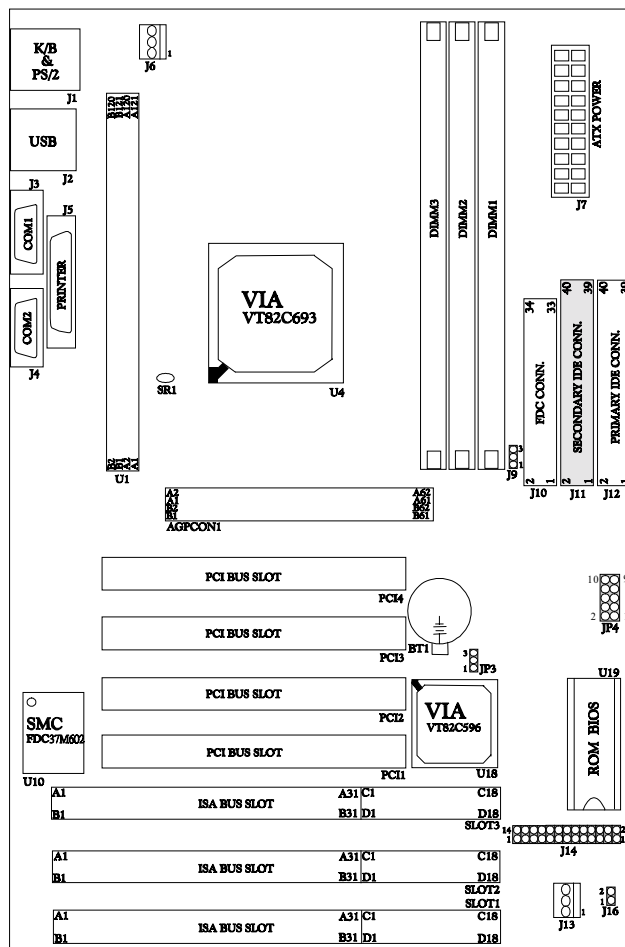

1.3 Motherboard Connectors

1.3.1 Front Panel Connectors (J14)

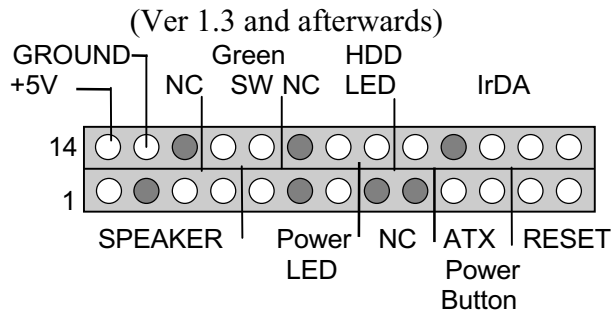

Pin No.	Assignment	Function	Pin No.	Assignment	Function
1	Speaker	Speaker Connector	14	+5V	VCC
2	NC		15	Ground	Ground
3	Ground		16	NC	
4	+5V		17	Green Control	Green
5	Power LED(+)	Power LED	18	Green Control	Switch
6	NC		19	NC	
7	Ground	NC	20	HDD LED(-)	HDD LED
8	NC		21	HDD LED(+)	
9	NC		22	+5V	IrDA Connector
10	Power Switch	23	NC		
11	Standby Voltage	24	IRRX		
12	Reset Control	25	Ground		
13	Ground	26	IRTX		

NOTE: Ver: 1.3 Power LED flash to indicate into Green Mode

1.3.2 Back Panel Connectors

The back panel I/O shield for the motherboard must meet specific dimension and material requirements. Systems based on this motherboard need the back panel I/O shield to pass certification testing. The figure below shows the critical dimensions of the chassis-independent I/O shield.

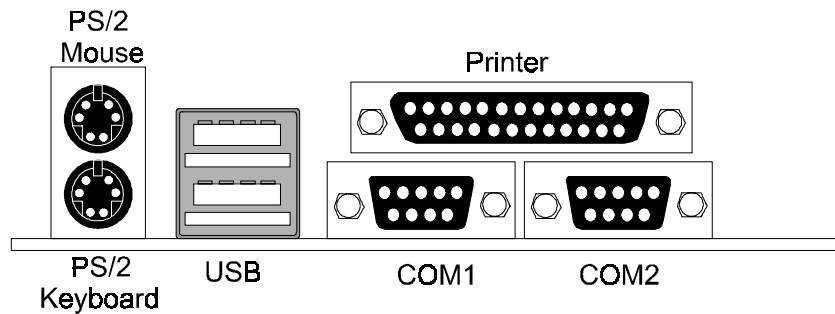

NOTE: A chassis-independent I/O shield designed to be compliant with the ATX chassis specification 2.01 is available from Intel.

The figure below shows the location of the back panel I/O connectors, which include:

- PS/2-keyboard and mouse connectors
- Two USB connectors (stacked)
- One parallel port
- Two serial ports

1.4 CPU Installation/Jumper Setting

1.4.1 CPU Installation Procedure

The M6VBA motherboard provides one Single Edge Contact (SEC) slot. This slot allows you to install a Pentium II CPU.

Before you use:

Please look on your motherboard and locate the CPU fan and CPU fan power supply. Please verify that this fan is directly used to cool the CPU and its heat sink, as well as to cool the motherboard and circulate the air.

WARNING : If air circulation is insufficient, the CPU will overheat, which may damage the CPU, CPU slot, and the motherboard..

Please inspect your motherboard to see if it has the Pentium II CPU retention kit components. (ATTENTION: The CPU installation components color and shape may vary slightly based on kits coming from different suppliers.)

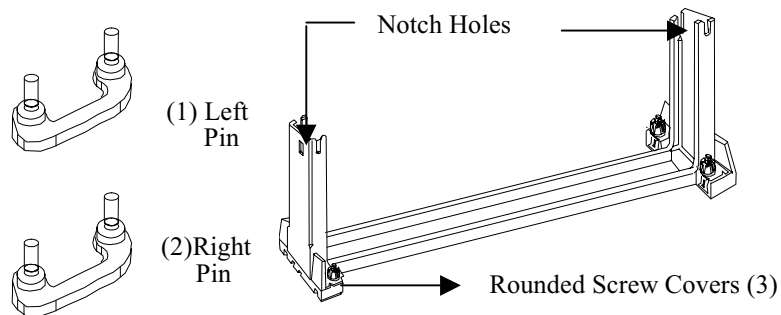

Pentium II Heat Sink Pins

Pentium II Heat Sink Bracket

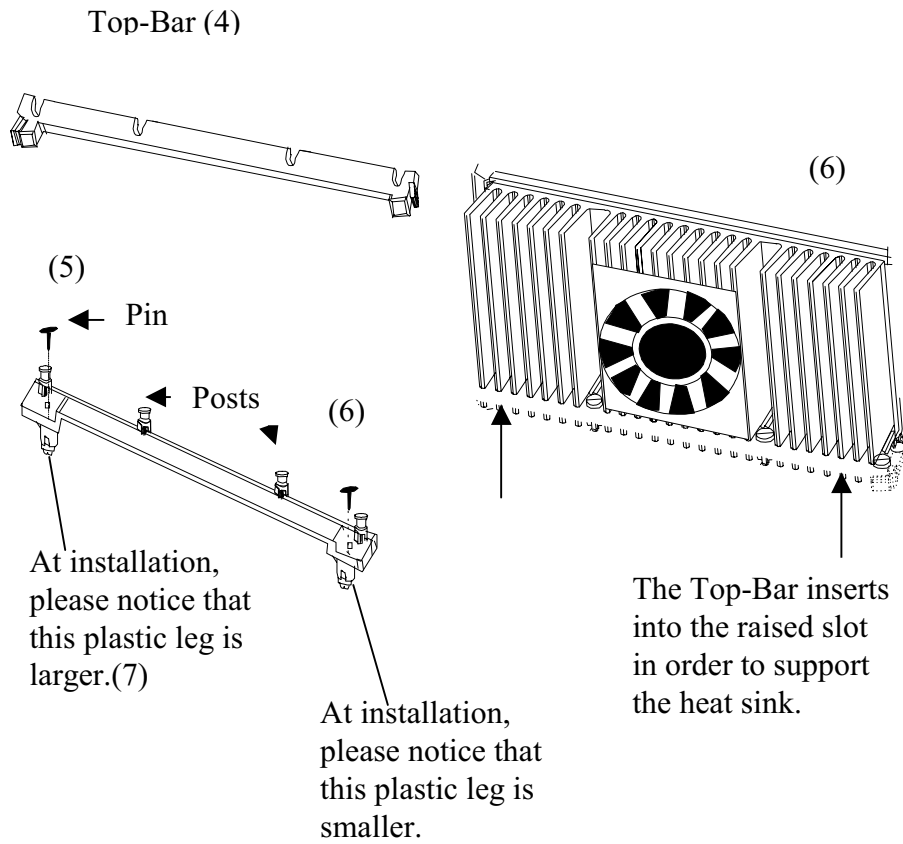

**Heat Sink Support Base
Frame**

**Heat Sink Support
Frame**

M6VBA Pentium II CPU Special Installation and Setup :

Around Pentium II CPU SEC slot

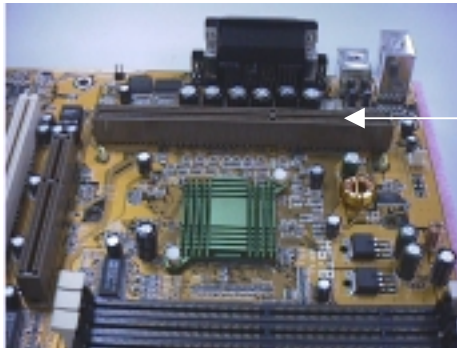
Install Pentium II:

Single Edge Contact
(SEC) slot.

1. Installing the Pentium II Heat Sink Support Frame :

The Heat Sink Support Base can only be inserted one-way. Please match the leg sizes on the Heat Sink Support Base to the holes on the motherboard. Please remember the notch holes align with the Intel Chip AGP Support Frame. After gently and snugly inserting the Intel Chip AGP Support Frame into the motherboard, please insert the H screws from the bottom of the motherboard and tighten into the rounded screw covers.

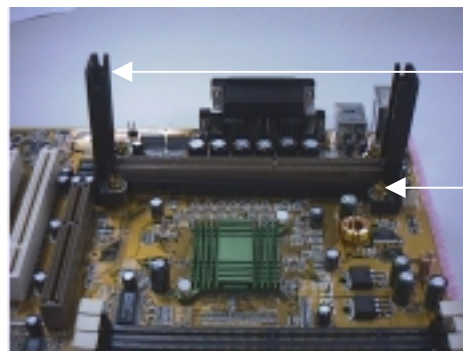

Notch holes

Rounded screw covers

2. Installing the CPU Heat sink :

Take the smooth side of the Heat Sink and bound it closely together with the Pentium II CPU. Next, at the ends of the Heat Sink, clip the CPU together with the Heat Sink. Please verify that there is zero space between the Heat Sink and CPU unit. **WARNING:** If there is any space between the CPU and Heat Sink, the CPU will over-heat severely and may damage the cpu.

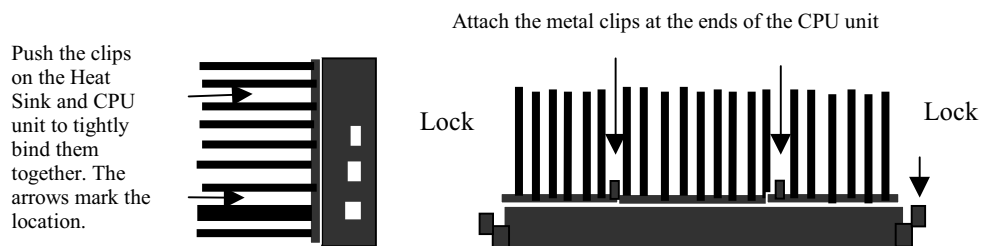

3. Insert the Pentium II into the SEC Slot:

First, press the CPU unit into the Frame until it fits snugly into the notch holes. Then, clip the Heat Sink and CPU together with the Heat Sink

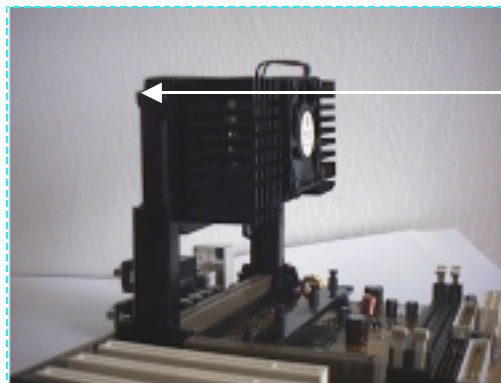

Support Frame.

The correct direction to insert the Heat Sink and CPU into the Heat Sink Support Frame should allow you to easily insert them.

4. Pushing the CPU unit into the frame, wait until the CPU unit is firmly in position before securing. The notches are pushed out. They will fit tightly into the Heat Sink Frame Notch holes.

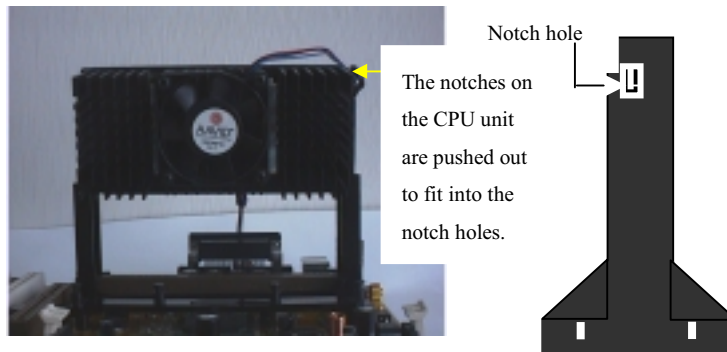

5. Firmly secure the Heat Sink by attaching the Heat Sink Frame TOP-Bar. Please verify that the Heat Sink and CPU are tightly pressed together. Please check that the entire Frame, Heat Sink, and CPU unit are tightly installed and that there is no possible movement or looseness in the assembly.

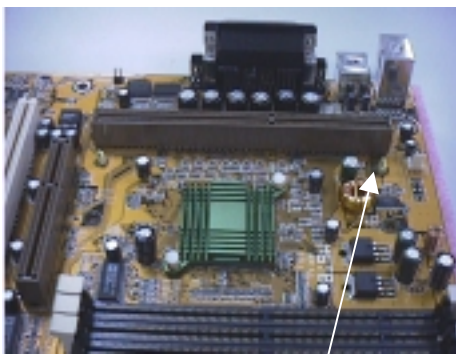

Heat Sink Support Frame

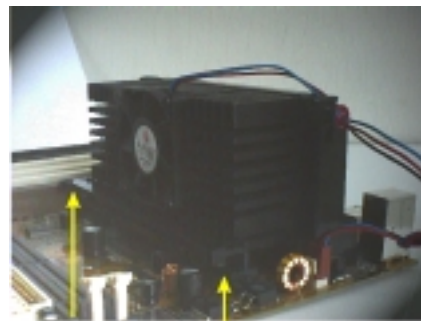

Place the Top-Bar over the Support Frame

The Top-Bar should conveniently lock out the plastic notches at the end of the Support Frame.

1.4.2 CPU Clock Selection (JP4)

Ver: 1.3

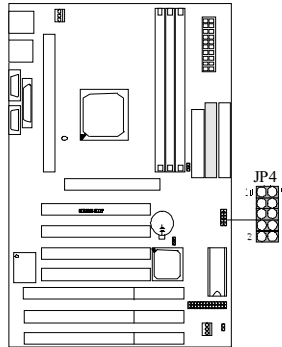

CPU Speed	CLK RATIO	JP4 (1-2)	JP4 (3-4)	JP4 (5-6)	JP4 (7-8)	JP4(9-10)
233MHz	66 X 3.5	closed	open	open	closed	closed
266MHz	66 X 4	closed	closed	closed	open	closed
300MHz	66 X 4.5	closed	open	closed	open	closed
333MHz	66 X 5	closed	closed	open	open	closed
366MHz	66 X5.5	closed	open	open	open	closed
400MHz	66 X6	closed	closed	closed	closed	open
433MHz	66 X6.5	closed	open	closed	closed	open
350MHz	100 X 3.5	open	open	open	closed	closed
400MHz	100 X 4	open	closed	closed	open	closed
450MHz	100 X 4.5	open	open	closed	open	closed
500MHz	100 X5	open	closed	open	open	closed
550MHz	100 X5.5	open	open	open	open	closed

1.5 Jumper Settings

A jumper is a two or more pin that may be covered by a plastic jumper cap, allowing you to select different system options.

1.5.1 JP3 CMOS Function Select

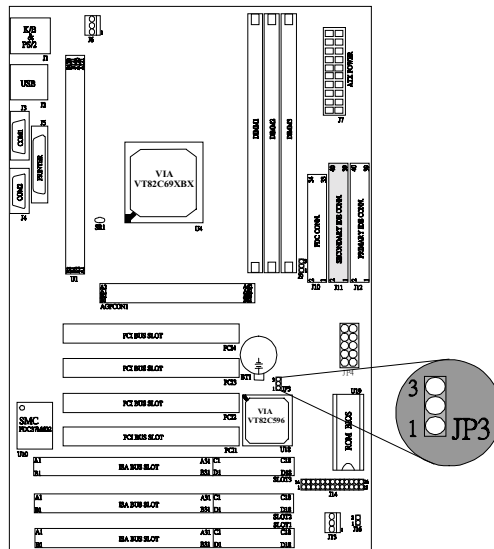

JP3	Assignment
<p>1-2 Closed</p>	Normal Operation (default)
<p>2-3 Closed</p>	Clear CMOS Data (*Note)
<p>Open</p>	Onboard Battery Disabled

Note: Please follows the procedure below to clear CMOS Data.

Note: Please follows the procedure below to clear BIOS Password if your password is lost or forgotten.

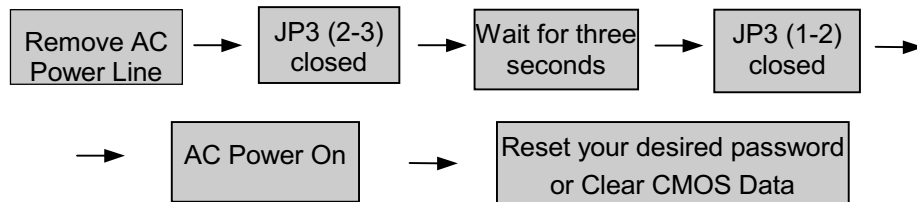

1.5.2 CPU Cooling Fan Power Connector (J6)

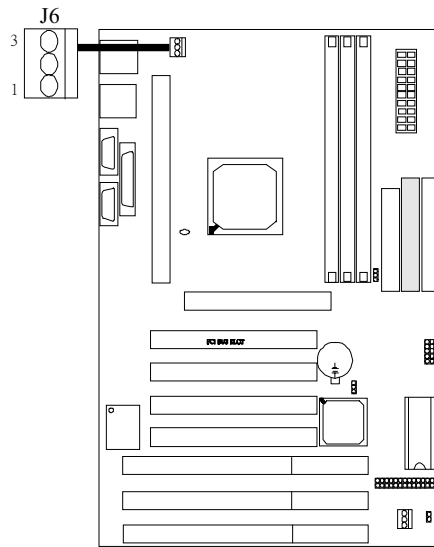

Pin No.	Assignment
1	Ground
2	+12V
3	Sensor

1.5.3 Wake-On-LAN Header (J9)

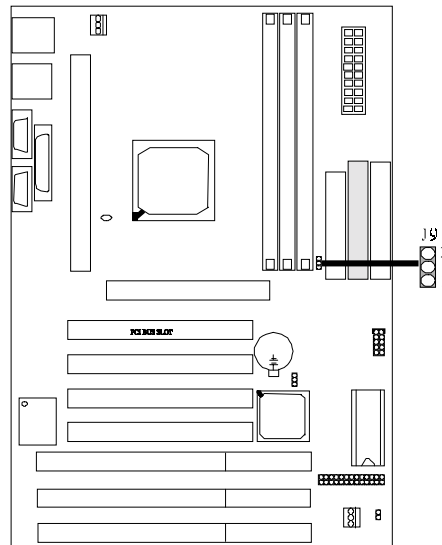

Pin No.	Assignment
1	+5 VSB
2	Ground
3	MP-Wakeup

1.5.4 Wake-On-Internal Modem (J16)

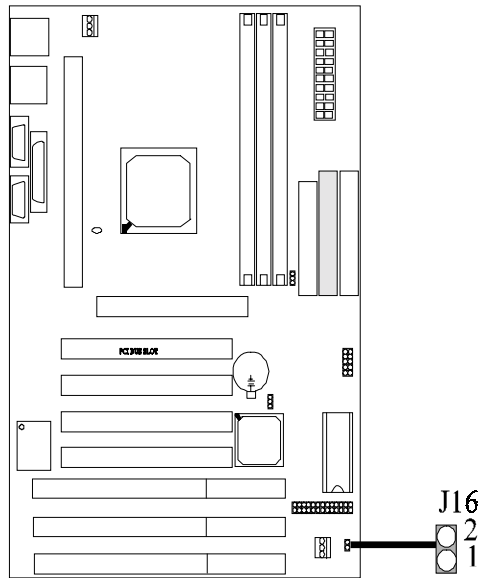

Pin No.	Assignment
1	Ring
2	GND

1.5.5 Chassis Fan Connector (J13) (For Ver: 1.3 & Afterward)

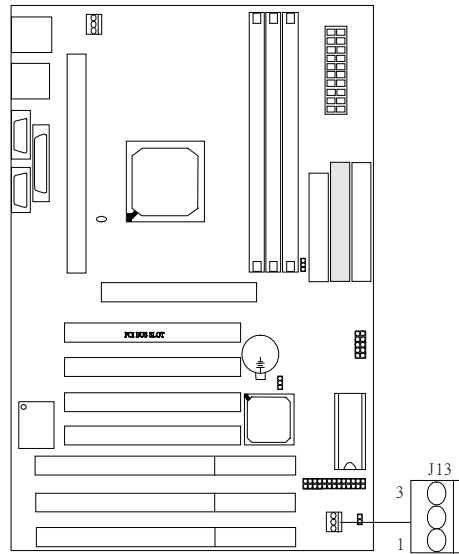

Pin No.	Assignment
1	Ground
2	+12V
3	Sensor

1.5.6 SR1 CPU Temperature Sensor Resistor (Ver: 1.3 & Afterward)

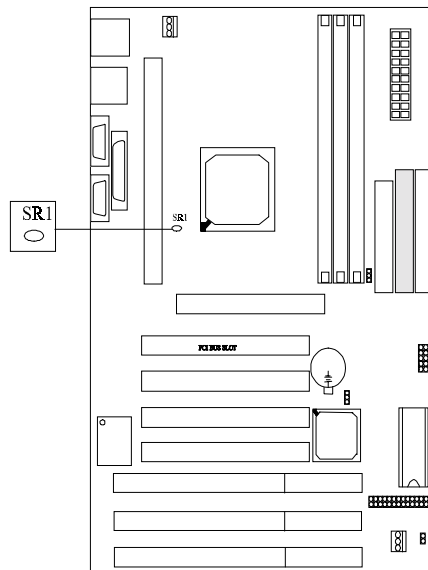

1.6 DRAM Installation

1.6.1 DIMM

DRAM Access Time: 3.3V Unbuffered SDRAM 10ns required.

DRAM Type: 8MB/16MB/32MB/64/128MB DIMM Module (168pin)

Total	Bank 0	Bank 1	Bank 2
Memory Size (MB)	DIMM1	DIMM2	DIMM3
8M	8M x 1 pc	----	----
16M	16M x 1 pc	----	----
32M	32M x 1 pc	----	----
64M	64M x 1 pc	----	----
128M	128M x 1 pc	----	----
16M	8M x 1 pc	8M x 1 pc	----
32M	16M x 1 pc	16M x 1 pc	----
64M	32M x 1 pc	32M x 1 pc	----
128M	64M x 1 pc	64M x 1 pc	----
24M	8M x 1 pc	8M x 1 pc	8M x 1 pc
40M	16M x 1 pc	16M x 1 pc	8M x 1 pc
72M	32M x 1 pc	32M x 1 pc	8M x 1 pc
136M	64M x 1 pc	64M x 1 pc	8M x 1 pc
32M	8M x 1 pc	8M x 1 pc	16M x 1 pc
48M	16M x 1 pc	16M x 1 pc	16M x 1 pc
80M	32M x 1 pc	32M x 1 pc	16M x 1 pc
144M	64M x 1 pc	64M x 1 pc	16M x 1 pc
48M	8M x 1 pc	8M x 1 pc	32M x 1 pc
64M	16M x 1 pc	16M x 1 pc	32M x 1 pc
96M	32M x 1 pc	32M x 1 pc	32M x 1 pc
160M	64M x 1 pc	64M x 1 pc	32M x 1 pc

Total	Bank 0	Bank 1	Bank 2
Memory Size (MB)	DIMM1	DIMM2	DIMM3
80M	8M x 1 pc	8M x 1 pc	64M x 1 pc
96M	16M x 1 pc	16M x 1 pc	64M x 1 pc
128M	32M x 1 pc	32M x 1 pc	64M x 1 pc
192M	64M x 1 pc	64M x 1 pc	64M x 1 pc
384M	128M x 1 pc	128M x 1 pc	128M x 1 pc

1.6.2 How to install a DIMM Module

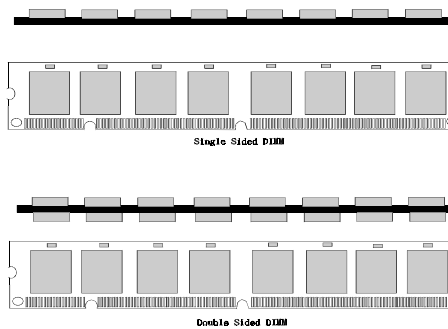

- A. The DIMM slot has a “*Plastic Safety Tab*” and the DIMM memory module has an “asymmetrical notch”, so the DIMM memory module can only fit in one direction.

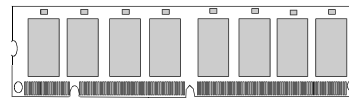

- B. Push the tabs out. Insert the DIMM memory modules into the socket at 90-degree angle, then push down vertically so that it will fit into place.

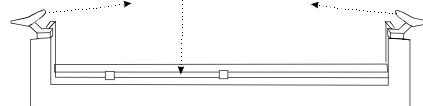

- C. The Mounting Holes and plastic tabs should fit over the edge and hold the DIMM memory modules in place.

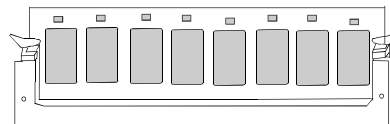

1.7 Connectors

1.7.1 Motherboard connector

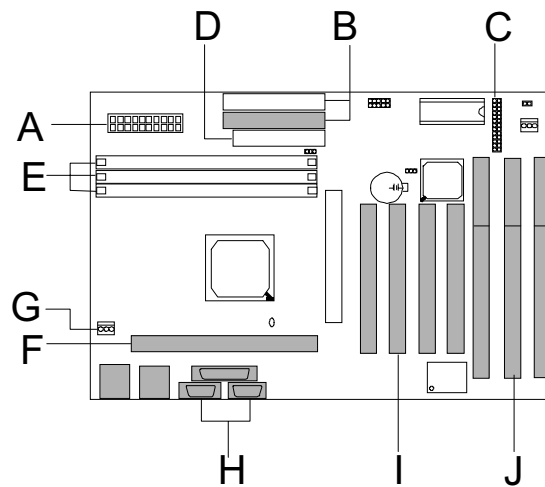

A. ATX Power Connector (J7)

B. IDE Connectors

C. Front Panel Connectors (J14)

D. Floppy Disk Connector (J10)

E. DIMMs

F. Slot 1

G. CPU FAN Connector (J6)

H.COM Port(J3/J4)

I.PCI Slots

j.ISA Slots

1.7.2 Floppy Disk Connector: J10

The motherboard also provides a standard Floppy Disk Connector (FDC) that supports 360K, 720K, 1.2M, 1.44M, and 2.88M floppy disk types. This connector supports floppy drive ribbon cables.

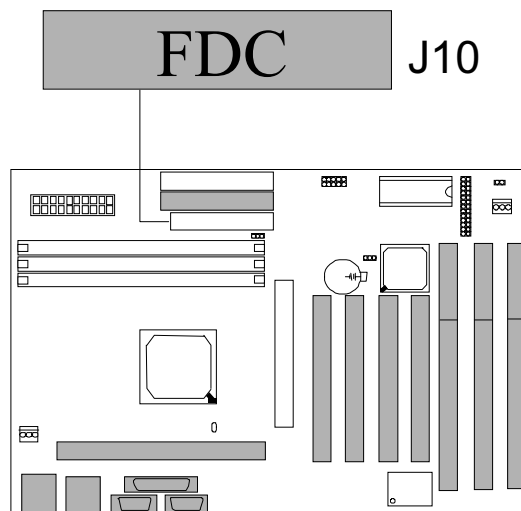

1.7.3 Hard Disk Connector: J11 / J12

The motherboard has a 32-bit Enhanced PCI IDE Controller that provides PIO Mode 0~4, Bus Master, and Ultra DMA / 33 functionality. It has two HDD connectors IDE1 (primary) and IDE2 (secondary). You can connect up to four hard disk drives, a CD-ROM, a 120MB Floppy (reserved for future BIOS) and other devices to IDE1 and IDE2. These connectors support the IDE hard disk cable provided.

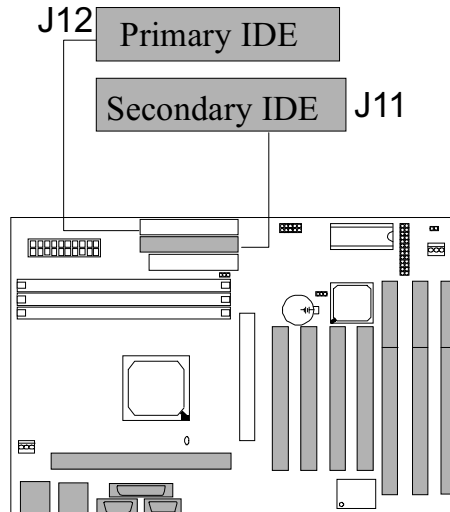

IDE1 (Primary IDE Connector)

The first hard drive should always be connected to IDE1. IDE1 can connect a Master and a Slave drive. You must configure the second hard drive on IDE1 to Slave mode by setting the jumper accordingly.

IDE2 (Secondary IDE Connector)

The IDE2 controller can also support a Master and a Slave drive. The configuration is similar to IDE1. The second drive on this controller must be set to slave mode.

1.7.4 ATX 20-pin Power Connector: (J7)

This connector supports the onboard power button. Using the ATX power supply, functions such as Modem Ring Wake-Up and Soft Power-Off are supported by this motherboard. This power connector supports Instant Power-On functionality, which means that the system will boot up instantly when the power connector is inserted on the board.

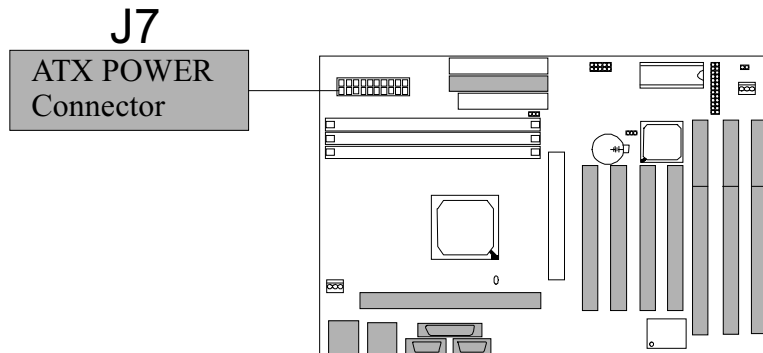

PIN	SIGNAL	PIN	SIGNAL
1	3.3 V	11	3.3 V
2	3.3 V	12	-12 V
3	GND	13	GND
4	5 V	14	PS_ON
5	GND	15	GND
6	5 V	16	GND
7	GND	17	GND
8	PW_OK	18	-5 V
9	5V_SB	19	5 V
10	12 V	20	5 V

Warning:

Since the motherboard has the Instant Power-On function, make sure that all components are installed properly before inserting the power connector to ensure that no damage will be done.

1.7.5 Mouse / Keyboard Connector:

The motherboard provides standard PS/2 mouse and Keyboard mini-DIN connectors. You can plug a PS/2 mouse and keyboard directly into these connectors. The connector location and pin definitions are shown below:

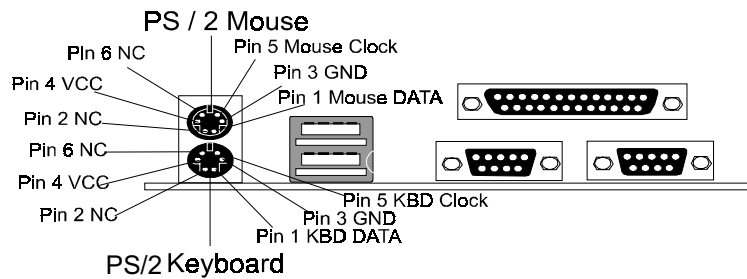

PS/2 Mouse / Keyboard Connectors

Pin	Signal Name
1	Data
2	No connect
3	Ground
4	+5 V (fused)
5	Clock
6	No connect

1.7.6 USB Connector: J2

The motherboard provides an UHCI (Universal Host Controller Interface) Universal Serial Bus ports for attaching USB devices like: keyboard, mouse and other USB devices. You can plug USB devices directly into this connector.

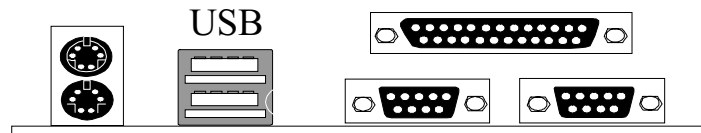

Stacked USB Connectors

Pin	Signal Name
1	+5 V (fused)
2	USBP0- [USBP1-]
3	USBP0+ [USBP1+]
4	Ground

1.7.7 Serial (J3/4) and Parallel Interface Ports (J5)

This system comes equipped with two serial ports and one parallel port. Both types of interface ports are explained in this chapter.

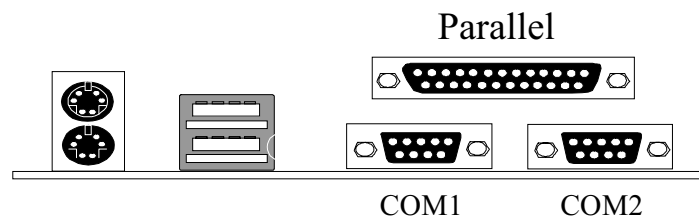

The Serial Interface Port

The serial interface port is sometimes referred to as a RS-232 port or an asynchronous communications port. Mice, printers, modems, and other peripheral devices can be connected to a serial port. The serial port can also be used to connect your computer with another computer system. If you wish to transfer the contents of your hard disk to another system it can be accomplished by using each machine's serial port.

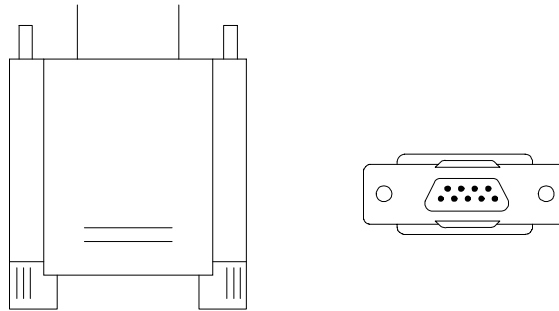

The serial ports on this system have two types of connectors, (one) 9-pin and (one) 25-pin. Some older computer systems and peripherals have only

one 25-pin connector. Should you need to connect your 9-pin serial port to an older 25-pin serial port, you can purchase a 9-to-25 pin adapter.

Connectivity

Because a serial port can be used many ways, you may need to be familiar with the pinout diagram. The following chart gives you the function of each pin on the 9-pin connector. This information can be used when configuring certain software programs to work with the serial port.

Signal	Name	DB9 PIN	DB25 PIN
DCD	Data Carrier Detect	1	8
RX	Receive Data	2	3
TX	Transmit Data	3	2
DTR	Data Terminal Ready	4	20
GND	Signal Ground	5	7
DSR	Data Set Ready	6	6
RTS	Request to Send	7	4
CTS	Clear to Send	8	5
RI	Ring Indicator	9	22

Special Applications

There are two types of serial devices that can be connected to a serial port. One of the devices is called “DTE” (Data Terminal Equipment) and another device is called “DCE” (Data Communications Equipment). If a modem is connected to a computer, for example, the modem is called the DCE and the computer is called the DTE. In situations such as this, the pins on the serial ports can be connected straight through.

In instances when there are two DTE devices connected together, such as a computer and a printer, a special adapter called a “Null Modem” is

needed to make communication between the two devices possible.

When using the serial port to communicate between devices one problem in particular may arise. Some manufacturers use one set of signals to begin communication with another device while other manufacturers do not use these signals to begin communication. If you encounter a communication problem that cannot be resolved using a null modem it can generally be assumed that one device is using the initialization signals and the other device is not. This can usually be resolved by wiring the RTS, CTS, and DCD pins together.

Serial Ports/COM Ports

The two serial ports on the computer are called COM1 and COM2, respectively. If you wish, two additional serial ports can be added onto the computer using optional hardware. Should you choose to add the extra Serial ports (COM ports) they would be called COM3 and COM4.

When using serial ports to communicate with a peripheral device be sure to assign only one COM port number to each device. For example, if a printer and a scanner are both connected to your computer through serial ports the printer must be assigned one COM port (i.e. COM1) and the scanner must be assigned the other COM port (i.e. COM2). No two devices can be assigned to the same COM port. Each peripheral must have its own COM port.

NOTE: Four serial ports may be installed on the computer. However, no more than two ports can be used simultaneously.

*If you have installed an internal modem be careful not to assign a COM port number that has already been assigned to another device. This is a common error.

When installing a device that is going to require the use of a serial port please uses a diagnostic program to find out which ports are available. It may be necessary to remove expansion cards that have serial ports in order to check their jumper settings. The jumper settings will indicate which COM port the card has been assigned. Checking the expansion card will eliminate mistakes in overlapping COM ports. Once you have completed the installation of peripheral devices using the serial ports, be sure that the communication parameters such as baud rate, parity bit, etc. are matching. If your computer is set for a baud rate of 9600 and your modem is set for a baud rate of 2400 you will not be able to send messages. The manuals that accompany the peripheral devices will inform you on the procedure for setting their parameters. Software manuals will also have instructions on setting parameters.

Parallel Interface Ports

Unlike the serial port, parallel interface ports have been standardized and should not present any difficulty interfacing peripherals to your system. Sometimes called a Centronics port, the parallel port is almost exclusively used with printers. The parallel port on your system has a 25-pin, DB5 connector (see picture below). The pinouts for the parallel port are shown in the table below.

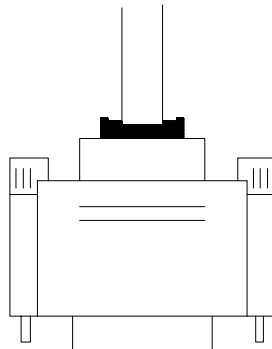
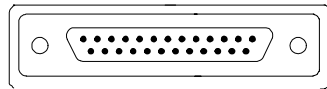

Signal	Pin
-Strobe	1
Data 0	2
Data 1	3
Data 2	4
Data 3	5
Data 4	6
Data 5	7
Data 6	8
Data 7	9
-Ack	10
Busy	11
Paper Empty	12
+Select	13
-Auto FDXT	14
-Error	15
-Init	16
-SLCTN	17
Ground	18
Ground	19
Ground	20
Ground	21
Ground	22
Ground	23
Ground	24

Ground	25
--------	----

2. Motherboard Software

2.1 Software List

Category	Description	Platform	Location in CD
VIA IRQ Routing Miniport Patch *	Used for enable PCI bus IRQ Steering function.	Windows 95/98	\Mb_drv\Nirq
Chipset Functions' Registry Utility *	Used for patching Windows 95's Registry System to let Windows 95 recognizes new devices.	Windows 95	\Mb_drv\Registry
VIA AGP VxD Driver *	Install the drivers to support AGP interface VGA Card	Windows 95/98	\Mb_drv\Agp
HighPoint XStore Pro *	Install the drivers to support Ultra DMA mode Hard Drive.	Windows 95/98	\Mb_drv\XStore
VIA Bus Master IDE Drivers *	Install the drivers to support Ultra DMA mode Hard Drive.	Windows NT 4.0	\Mb_drv\Ide
Winbond Hardware Doctor *	Hardware Doctor is a self-diagnostic system for PC and must be used with Winbond W8378xD IC series products.	Windows 95/98	\Mb_drv\Hwdoctor
Award Flash Utility	Used for updating BIOS. (Please refer to chapter - Application Software.)		\Flash

2.2 Software Installation

There is an installation wizard, **Driver CD Installation Utility** (START.EXE), located in the root of Driver CD to let users install some common used drivers conveniently.

The drivers can be installed from CD by using CD Installation Utility:

You can simply put Driver CD into CD-ROM drive and the Installation Utility will autorun or you can run the Driver CD Installation Utility directly by using mouse cursor to click the proper option on the page. Utility will invoke other applications to complete the rest of installation.

The drivers CAN NOT be installed directly from CD by using CD Installation Utility:

Please read the README.TXT located in the root directory on Multimedia CD to get drivers' location and then refer to the INSTALL.TXT or README.TXT files located in each driver directory on the Driver CD to install drivers.

2.3 Using Software

- In general, you can get more detailed information in the on-line help or readme for the softwares.

Using Hardware doctor

After the utility is installed, you can choose the “Hardware Doctor” option in the Start Menu to invoke the utility. After the utility invoked once, a tiny icon will be placed a little icon in the right side of the Task Bar and you can double click the icon to invoke the utility again.



The following figure is the main panel of Hardware Doctor. In the panel, you can get some real-time and important information -- Voltage, Fan speed, and temperature, for example. If there is an abnormal situation, you can resolve it immediately.

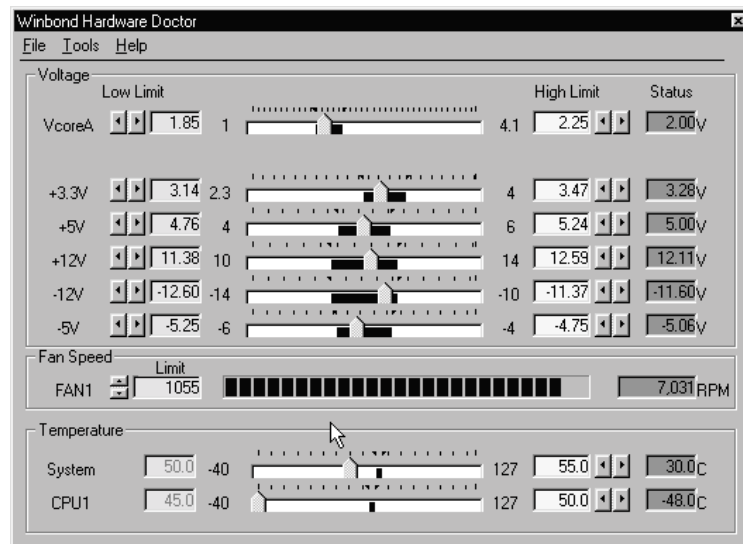

If you want to get more detailed information about Hardware Doctor, on-line help comes with the utility. You can refer to on-line help to make use of the utility.

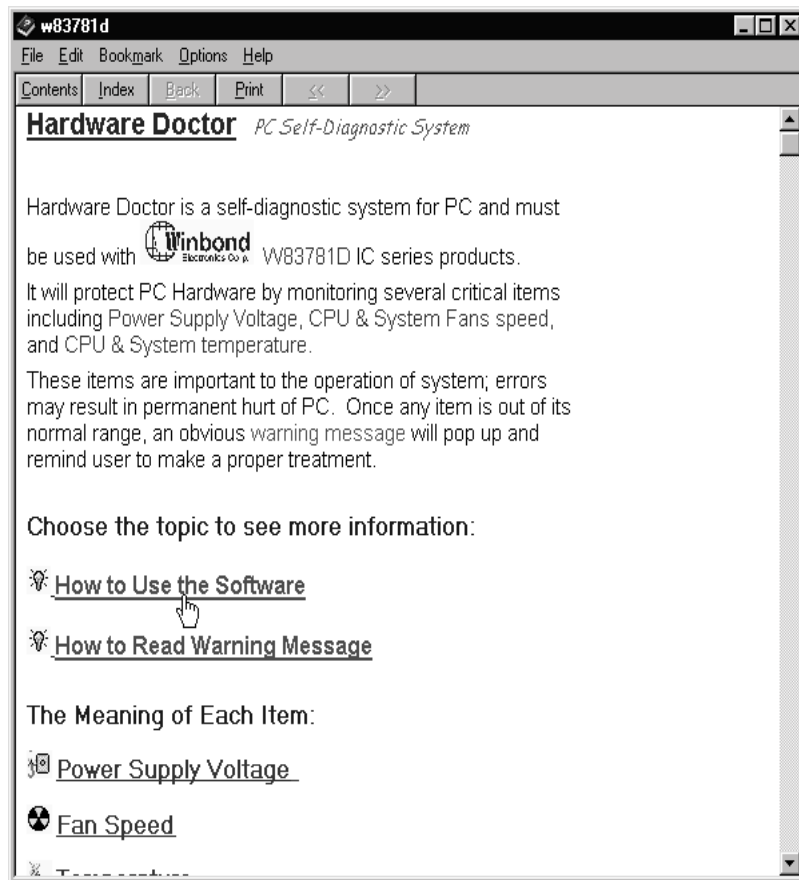

3. AWARD BIOS Setup

Entering Setup

Power on the computer and press immediately allowing you to enter Setup. The other way to enter Setup is to power on the Computer, and when the message below appears briefly at the bottom of the screen during the POST (Power On Self Test), press the key or simultaneously press the <CTRL>, <Alt>, and <Esc> keys.

TO ENTER SETUP BEFORE BOOT PRESS CTRL-ALT-ESC OR DEL KEY

If the message disappears before you respond and you still wish to enter Setup, restart the system again by turning it OFF then ON or pressing the "RESET" button on the system case. You may also restart by simultaneously pressing the < CTRL>, <Alt>, and <Delete> keys. If you do not press the keys at the correct time and the system does not boot, an error message will be displayed, and you will again be asked to:

PRESS F1 TO CONTINUE, CTRL-ALT-ESC OR DEL TO ENTER SETUP

Main Menu

The on line description of the highlighted setup function is displayed at the bottom of the screen.

Status Page Setup Menu/Option Page Setup Menu

Press <F1> to pop up a small help window that describes the appropriate keys to use and the possible selections for the highlighted item. To exit the Help Window Press <Esc>.

Control Keys

Up arrow	Move to previous item
Down arrow	Move to next item
Left arrow	Move to the item at left
Right arrow	Move to the item at right
Esc key	Main Menu:make a space Quit and do not save changes into CMOS Status Page Setup Menu and Option Page Setup Menu: Exit current page and return to Main Menu
PgUp key	Increase the numeric value or make changes
PgDn key	Decrease the numeric value or make changes
+ key	Increase the numeric value or make changes
- key	Decrease the numeric value or make changes
F1 key	General help, only for Status Page Setup Menu and Option Page Setup Menu
(Shift) F2 key	Change color to one of 16 colors. F2 to select color forward, (Shift) F2 to select color backward
F3 key	Reserved
F4 key	Reserved
F5 key	Restore the previous CMOS value, only for Option Page Setup Menu
F6 key	Load the default CMOS value from BIOS default table, only for Option Page Setup Menu
F7 key	Load the default
F8 key	Reserved
F9 key	Reserved
F10 key	Save all the CMOS changes, only for Main Menu

3.1 Main Menu

Once you enter AWARD BIOS CMOS Setup Utility, the Main Menu (Figure 1) will appear on the screen. The Main Menu allows you to select an item and press <Enter> to accept or enter its sub-menu.

■ **Figure 1. Main Menu**

ROM PCI/ISA BIOS (xxxxxxx)
 CMOS SETUP UTILITY
 AWARD SOFTWARE, INC.

STANDARD CMOS SETUP	CPU SPEED SETTING
BIOS FEATURES SETUP	INTEGRATED PERIPHERALS
CHIPSET FEATURES SETUP	SUPERVISOR PASSWORD
POWER MANAGEMENT SETUP	USER PASSWORD
PNP / PCI CONFIGURATION	IDE HDD AUTO DETECTION
LOAD SETUP DEFAULTS	SAVE & EXIT SETUP
	EXIT WITHOUT SAVING
Esc : Quit	↑ ↓ → ← : Select Item
F10 : Save & Exit Setup	(Shift) F2 : Change Color
Time, Date, Hard Disk Type...	

Standard CMOS Setup

This setup page includes all the items in a standard compatible BIOS.

BIOS Features Setup

This setup page includes all the items for the BIOS special enhanced features.

Chipset Features Setup

This setup page includes all the items for chipset special features.

Power Management Setup

This setup page includes all the items for power management features.

PnP / PCI Configuration

This category specifies the value (in units of PCI bus clocks) of the latency timer for this PCI bus master and the IRQ level for PCI device.

Load Setup Defaults

Chipset defaults indicates the values required by the system for maximum performance. The OEM manufacturer may change to defaults through MODBIN before the binary image burn into the ROM.

CPU SPEED SETTING

This setup page includes Hardware monitor & Jumperless features setup.

Integrated Peripherals

This setup page includes all the items for Integrated Peripherals features.

Supervisor Password / User Password Setting

Change, set, or disable password. It allows you to limit access to the system and Setup, or just to Setup.

IDE HDD Auto Detection

Automatically configure hard disk parameters.

Save & Exit Setup

Save CMOS value changes to CMOS and exit setup.

Exit Without Saving

Abandon all CMOS value changes and exit setup.

3.2 Standard CMOS Setup Menu

The items in the Standard CMOS Setup Menu are divided into categories. Each category includes no, one, or more than one setup item. Use the arrow keys to highlight the item and then use the <PgUp> or <PgDn> keys to select the value you want in each item.

■ **Figure 2. Standard CMOS Setup Menu**

ROM PCI/ISA BIOS (xxxxxxx)
STANDARD CMOS SETUP
AWARD SOFTWARE, INC.

Date (mm:dd:yy) : Mon, Aug 3 1998									
Time (hh:mm:ss) : 11 : 37 : 30									
HARD DISKS	TYPE	SIZE	CYLS	HEAD	PRECOMP	LANDS	SECTOR	MODE	
Primary Master	: Auto	0	0	0	0	0	0	Auto	
Primary Slave	: Auto	0	0	0	0	0	0	Auto	
Secondary Master	: Auto	0	0	0	0	0	0	Auto	
Secondary Slave	: Auto	0	0	0	0	0	0	Auto	
Drive A	:1.44MB, 3.5 in.								
Drive B	:None								
Video	:EGA/VGA			Base Memory : 0K					
Halt On	:All, But Keyboard			Extended Memory : 0K					
				Other Memory : 512K					
				Total Memory : 512K					
Esc	: Quit			↑ ↓ → ← : Select Item			PU/PD/+/-: Modify		
F1	: Help			(Shift) F2 : Change Color					

Date

The Date format is <day><month><date><year>.

Day	The day, from Sun to Sat, is determined by the BIOS and is display-only
Date	The date, from 1 to 31 (or the maximum allowed in the month)
month	The month, Jan through Dec
year	The year, from 1994 through 2079

Time

The time format is <hour><minute><second>. The time is calculated based on the 24-hour military-time clock. For example, 2 p.m. is 14:00:00.

Hard Disk Type

This categories identifies the types of hard disk(s) that have been installed in the computer. There are 46 predefined types and a user definable type. Type 1 to Type 45 are predefined. Type "User" is user-definable. Type "Auto" is automatically defined by BIOS.

Press <PgUp> or <PgDn> to select a numbered hard disk type or type the number and press <Enter>. Note that the specifications of your drive must match with the drive table. The hard disk will not work properly if you enter improper information for this category. If your hard disk drive type is not listed, you can use Type "User" to define your own drive type manually.

If you select type "User", related information is asked to be entered for several items. Enter the information directly from the keyboard and press <Enter>. This information should be provided in the documentation from your hard disk vendor or the system manufacturer. Most new drives will also have the parameters given on the label on top of the drive.

CYLN	number of cylinders
HEAD	number of heads
WPCOM	write precompensation
SEC	number of sectors
LBA MODE	type of LBA mode
BLK MODE	type of Block mode
PIO MODE	type of PIO
32BIT MODE	type of 32-Bit transfer mode

If a hard disk has not been installed select "NOT Installed" and press <Enter>.

Drive A Type/Drive B Type

The category identifies the types of floppy disk drive A / drive B that have been installed in the computer.

None	No floppy drive installed
360K, 5 1/4	5-1/4 inch PC-type standard drive; 360 kilobyte capacity
1.2M, 5 1/4	5-1/4 inch AT-type high-density drive; 1.2 megabyte capacity
720K, 3 1/2	3-1/2 inch double-sided drive; 720 kilobyte capacity
1.44M, 3 1/2	3-1/2 inch double-sided drive; 1.44 megabyte capacity
2.88M, 3 1/2	3-1/2 inch double-sided drive; 2.88 megabyte capacity

Video

This category selects the type of adapter used for the primary system monitor, and must match your video display card and monitor. Although secondary monitors are supported, you do not have to select the type in Setup.

EGA/VGA	Enhanced Graphics Adapter/Video Graphics Array. For EGA, VGA, SEGA, or PGA monitor adapters.
CGA 40	Color Graphics Adapter, power up in 40 column mode
CGA 80	Color Graphics Adapter, power up in 80 column mode
MONO	Monochrome adapter, includes high resolution

	monochrome adapters
--	---------------------

Halt On

The category determines whether the computer will stop if an error is detected during power up.

No errors	Whenever the BIOS detects a non-fatal error the system will be stopped and you will be prompted.
All errors	The system boot will not stop for any error that may be detected.
All, But Keyboard	The system boot will not stop for a keyboard error, it will stop for all other errors.
All, But Diskette	The system boot will not stop for a disk error, it will stop for all other errors.
All, But Disk/Key	The system boot will not stop for a keyboard or disk error, it will stop for all other errors.

Memory

This category is display-only which is determined by POST (Power On Self Test) of the BIOS.

Base Memory

The POST of the BIOS will determine the amount of base (or conventional) memory installed in the system. The value of the base memory is typically 512K for system with 512K memory installed on the motherboard, or 640K for system with 640K or more memory installed on the motherboard.

Extended Memory

The BIOS determines how much extended memory is present during the POST. This is the amount of memory located above 1MB in the CPU's memory address map.

Other Memory

This refers to the memory located in the 640K address space. This is the memory that can be used for different applications. DOS uses this area to load device drivers to keep as much base memory free application programs. The most common use for this area is Shadow RAM.

3.3 BIOS Features Setup

!! WARNING !! The information about BIOS defaults in the manual (**Figure 3.4.5.6.8**) is just for reference, please refer to the BIOS installed on board, for update information.

■ **Figure 3. BIOS Features Setup Menu**

ROM PCI/ISA BIOS (xxxxxxx)
 BIOS FEATURES SETUP
 AWARD SOFTWARE, INC.

Virus Warning	: Disabled	Video	BIOS Shadow	: Enabled
CPU Internal Cache	: Enabled			
External Cache	: Enabled			
CPU L2 Cache ECC Checking	: Disabled			
Quick Power On Self Test	: Enabled			
Boot From LAN First	: Disabled			
Boot Sequence	: A,C,SCSI			
Swap Floppy Drive	: Disabled			
Boot Up Floppy Seek	: Enabled			
Boot Up NumLock Status	: On			
IDE HDD Block Mode	: Enabled			
Gate A20 Option	: Fast			
Memory Parity/ECC Check	: Disabled			
Typematic Rate Setting	: Disabled			
Typematic Rate (Chars/Sec)	: 6			
Typematic Delay (Msec)	: 250			
Security Option	: Setup	ESC : Qui	↑ ↓ → ←	: Select Item
PCI/VGA Palette Snoop	: Disabled	F1 : Help	PU/PD/+/-	: Modify
OS Select For DRAM > 64MB	: Non-OS2	F5 : Old Values	<Shift> F2	: Color
Report No FDD For WIN 95	: No	F7 : Load Setup Defaults		

Virus Warning

This category flashes on the screen. During and after the system boot up, any attempt to write to the boot sector or partition table of the hard disk drive will halt the system and an error message will appear. In the mean time, you can run an anti-virus program to locate the problem.

The choice: Disabled

No warning message to appear when anything attempts to access the boot sector or hard disk partition table.

The choice: Enabled

Activates automatically when the system boots up causing a warning message to appear when anything attempts to access the boot sector of hard disk partition table.

CPU Internal Cache

The choice: Enabled Enable cache

The choice: Disabled Disable cache

External Cache

Cache memory is additional memory that is much faster than conventional DRAM (system memory). Most, but not all, modern PCs have additional (external) cache memory. When the CPU requests data, the system transfers the requested data from the main DRAM into cache memory, for even faster access by the CPU.

The choice: Enabled Enable cache

The choice: Disabled Disable cache

Cpu L2 Cache ECC Checking

The default value is Disabled.

The choice: Enabled Enabled CPU L2 Cache ECC Checking.

The choice: Disabled Disable CPU L2 Cache ECC Checking.

Quick Power On Self Test

This option enables the level 2 external cache memory.

The choice: Enabled Enable quick POST

The choice: Disabled Normal POST

Boot From Lan First

The default value is Enabled.

Enabled	Enabled Boot From LAN First Function
Disabled	Disable Boot From LA First Function

Boot Sequence

This option determines which drive the computer searches the OS at boot-up. The settings are “A, C, SCSI”, “C, A, SCSI”, “C, CDROM, A”, “CDROM, C, A”, “D, A, SCSI”, “E, A, SCSI”, “F, A, SCSI”, “SCSI, A, C”, “SCSI, C, A” or “C only”,etc. **The default is “A, C, SCSI”.**

Swap Floppy Drive

Switches the floppy disk drive between being designated as A and B.

The choice: Disabled.

Boot Up Floppy Seek

During POST, BIOS will determine if the floppy disk drive installed is 40 or 80 tracks. 360K type is 40 tracks while 720K, 1.2M, and 1.44M are all 80 tracks.

The choice: Enabled BIOS searches for the floppy disk drive to determine if it is 40 or 80 tracks. Note that BIOS cannot tell from 720K, 1.2M or 1.44M drive type as they are all 80 tracks.

The choice: Disabled BIOS will not search for the type of floppy disk drive by track number. Note that there will not be any warning message if the drive installed is 360K.

Boot Up NumLock Status

The choice: On Numpad is number keys.
The choice: Off Numpad is arrow keys.

IDE HDD Block Mode

This item allows your hard disk controller to use the fast block mode to transfer data to and from your hard disk drive (HDD). Select Enabled only if your hard drivers support block mode.

Gate A20 Option

Gate A20 refers to the way the system addresses memory above 1MB (extended memory). When set to Fast, the system chipset controls Gate A20. When set to Normal, a pin in the keyboard controller controls Gate A20. Setting Gate A20 to Fast improves system speed, particularly with OS/2 and Windows.

Fast (default)

Memory Parity/ECC Check

This item allows you to select between three methods of memory error checking, Auto Enabled and Disabled.

Typematic Rate Setting

This determines the typematic rate.

The choice: Enabled Enable typematic rate and typematic delay programming.

The choice: Disabled Disable typematic rate and typematic delay programming. The system BIOS will use default value of these 2

items and the default is controlled by keyboard.

Typematic Rate (Chars/Sec)

6	6 characters per second
8	8 characters per second
10	10 characters per second
12	12 characters per second
15	15 characters per second
20	20 characters per second
24	24 characters per second
30	30 characters per second

Typematic Delay (Msec)

Choose the length of delay from the time you press a key and the character repeating. (units are mil-sec)

Security Option

This category allows you to limit access to the system and Setup, or just to Setup.

The choice: System	The system will not boot and access to Setup will be denied if the correct password is not entered at the prompt.
The choice: Setup	The system will boot, but access to Setup will be denied if the correct password is not entered at the prompt.

PCI / VGA Palette Snoop

Choose Disabled or Enabled. Some graphic controllers which are not VGA compatible take the output from a VGA controller and map it to their display as a way to provide boot information and VGA compatibility.

However, the color information coming from the VGA controller is drawn from the palette table inside the VGA controller to generate the proper colors, and the graphic controller needs to know what is in the palette of the VGA controller. To do this, the non-VGA graphic controller watches for the Write access to the VGA palette and registers the snoop data. In PCI based systems, where the VGA controller is on the PCI bus and a non-VGA graphic controller is on an ISA bus, the Write Access to the palette will not show up on the ISA bus if the PCI VGA controller responds to the Write.

In this case, the PCI VGA controller should not respond to the Write, it should only snoop the data and permit the access to be forwarded to the ISA bus. The non-VGA ISA graphic controller can then snoop the data on the ISA bus. Unless you have the above situation, you should disable this option.

The choice: Disabled Disables the function.
The choice: Enabled Enables the function.

OS Selection for DRAM > 64MB

Allows OS/2 to be used with > 64MB of DRAM. Settings are Non-OS/2 (default) and OS/2. Set to OS/2 if using more than 64MB and running OS/2.

DEFAULT is Non-OS2.

Report NO FDD Win95

The default value is NO.

The choice: No

The choice: Yes

Assign IRQ6 For FDD.

FDD Detect IRQ6 Automatically.

Video BIOS Shadow

Determines whether video BIOS will be copied to RAM for faster execution.

The choice: Enabled Optional ROM is enabled.
 The choice: Disabled Optional ROM is disabled.

3.4 Chipset Features Setup

The Chipset Features Setup option is used to change the values of the chipset registers. These registers control most of the system options in the computer.

■ **Figure 4. Chipset Feature Setup Menu**

ROM PCI/ISA BIOS (xxxxxxx)
 CHIPSET FEATURES SETUP
 AWARD SOFTWARE, INC.

Bank 0/1 DRAM Timinng	: SDRAM 10NS	
Bank 2/3 DRAM Timinng	: SDRAM 10NS	
Bank 4/5 DRAM Timinng	: SDRAM 10NS	
SDRAM Cycle Length	: Auto	
DRAM CLOCK	: Host CLK	
Memory Hole	: Disabled	
Concurrent PCI/Host	: Disabled	
Video RAM Cacheable	: Disabled	
AGP Aperture Size	: 64M	
AGP-2X Mode	: Enabled	
Onchip USB	: Enabled	
USB Keyboard Support	: Disabled	
		ESC : Quit ↑↓→← : Select Item
		F1 : Help PU/PD/+/- : Modify
		F5 : Old Values <Shift> F2 : Color
		F7 : Load Setup Defaults

Bank 0/1, 2/3, 4/5, DRAM Timing

The DRAM timing of Bank 0/1, 2/3, 4/5 in this field is set by the system

board manufacturer,
The Choice: Normal, Medium, Fast, Turbo,8NS,10NS.

SDRAM Cycle Length

This field sets the CAS length timing.
The Choice: Auto

Dram Clock

This item determines Dram Clock followig the CPU host clock ,or 66MHZ.

Memory Hole

You can reserve this area of system memory for ISA adapter ROM. When this area is reserved, it cannot be cached. The user information of peripherals that need to use this area of system memory usually discusses their memory requirements.

The choice: Disabled

Concurrent PCI/Host

When disable, CPU bus will be occupied during the entire PCI operation period.
The choice: Enabled, Disabled.

Video RAM Cacheable

Select Enabled allows caching of video RAM, resulting in better system performance. However, if any program writes to this memory area, a system error may result.

AGP Aperture Size (MB)

Select the size of the Accelerated Graphics Port (AGP) aperture. The

aperture is a portion of the PCI memory address range dedicated for graphics memory address space. Host cycles that hit the aperture range are forwarded to the AGP without any translation.

The choice: 64

Video RAM Cacheable

Select Enabled allows caching of the video RAM , resulting in better system performance. However, if any program writes to this memory area, a system error may result.

Enabled	Video RAM access cached
Disabled	Video RAM access not cached

AGP Aperture Size (MB)

Select the size of the Accelerated Graphics Port (AGP) aperture. The aperture is a portion of the PCI memory address range dedicated for graphics memory address space. Host cycles that hit the aperture range are forwarded to the AGP without any translation.

The choice: 4, 8, 16, 32, 64, 128, 256

OnChip USB

This should be enabled if your system has a USB installed on the system board and you wish to use it. Even when so equipped, if you add a higher performance controller, you will need to disable this feature.

The choice: Enabled, Disabled.

USB Keyboard Support

Select *Enabled* if your system contains a Universal Serial Bus (USB) controller and you have a USB keyboard.

The choice: Enabled, Disabled.

3.5 Power Management Setup

■ Figure 5. Power Management Setup Menu

ROM PCI/ISA BIOS (xxxxxxxx)
POWER MANAGEMENT SETUP
AWARD SOFTWARE, INC.

Power Management	: User Define	** Reload Global Timer Events **
PM Control by APM	: Yes	Primary INTR
Video off option	: Suspend→off	: ON
Video off Method	: Standby	IRQ3 (COM 2)
MODEM Use IRQ	: 3	: Primary
Soft-off by PWRBTN	: Instant-off	IRQ4 (COM 1)
HDD Power Down	: Disabled	: Primary
Doze Mode	: Disabled	IRQ5 (LPT 2)
Suspend Mode	: Disabled	: Primary
	PM Events	IRQ6 (Floppy Disk)
VGA	: OFF	: Primary
LPT&COM	: LPT/COM	IRQ7 (LPT 1)
HDD&FDD	: ON	: Primary
DMA/master	: OFF	IRQ8 (RTC Alarm)
Wake Up On LAN	: Disabled	: Disabled
Modem Ringg Resume	: Disabled	IRQ9 (IRQ2 Redir)
RTC Alarm Resume	: Disabled	: Secondary
		IRQ10 (Reserved)
		: Secondary
		IRQ11 (Reserved)
		: Secondary
		IRQ12 (PS/2 Mouse)
		: Primary
		IRQ13 (Coprocessor)
		: Primary
		IRQ14 (Hard Disk)
		: Primary
		IRQ15 (Reserved)
		: Disabled
		ESC : Quit
		↑ ↓ → ← : Select Item
		F1 : Help
		PU/PD/+/- : Modify
		F5 : Old Values
		<Shift> F2 : Color
		F7 : Load Setup Defaults

Power Management

- The choice: Disable (Min. Saving) Global Power Management will be disabled.
- The choice: User Define Users can configure their own power (Max. Saving) management.
- Min Saving Pre-defined timer values are used such that all timers are at their MAX value.
- Max Saving Pre-defined timer values are used such that all timers are at their MIN value.

PM Control by APM

- The choice: No System BIOS will ignore APM when Power Management is on.
- The choice: Yes System BIOS will wait for APM's prompt before it enters any PM mode.

Video off Option

When enabled, this feature allows the VGA adapter to operate in a power saving mode.

Always On	Monitor will remain on during power saving modes.
Suspend →Off	Monitor blanked when the systems enters the Suspend mode.
Susp,Stby→Off	Monitor blanked when the system enters either Suspend or Standby modes.
All Modes→Off	Monitor blanked when the system enters any power saving mode.

Video Off Method

- The choice: Blank Screen The system BIOS will only blank the screen when disabling video.
- The choice: V/HSYNC+Blank In addition to the above, BIOS will also turn off the V-SYNC & H-SYNC signals from VGA card to monitor.

The choice: DPMS

This function is enabled only for a
VGA card supporting DPMS.

MODEM Use IRQ

Set the interrupt request (IRQ) line assigned to the modem (if any) on your system. Activity of the selected IRQ always awakens the system.

The choice: 3

Soft-Off by PWR-BTTN

This item allows you to set the off function of power button by software control.

The choice: Instant-Off

HDD Power Down

After the selected period of drive inactivity, the hard disk drive powers down while all other devices remain active.

The choice: Disabled

Doze Mode

This option specifies how long the CPU is continuously idle before entering the doze mode. When the system is in Doze mode, the screen will be blank.

Suspend Mode

This options allows the user to indicate how long the system will be idle before entering the suspend mode, which turns off the CPU and saves the energy of the system

VGA Active Monitor

When enabled, any video activity restarts the global timer for Standby

mode.

The choice: Disabled

LPT & COM

When set to On (default), any event occurring at a hard or floppy drive port will awaken a system which has been powered down.

.HDD & FDD

When set to On (default), any event occurring at a hard or floppy drive port will awaken a system which has been powered down.

DMA/Master

When set to On (default), any event occurring at will awaken a system which has been powered down.

Wake Up On LAN

When set to Enabled, you can wake up your system from LAN in mode suspend .

Modem Ring Resume

When set to Enabled, any event occurring to the Modem Ring will awaken a system which has been powered down.

RTC Alarm Resume

When Enabled, you can set the date and time at which the RTC (real-time clock)alarm awakens the system from Suspend mode.

Primary INTR

When set to On (default), any event occurring at will awaken a system which has been powered down..

The following is a list of IRQ, Interrupt Requests, which can be exempted much as the COM ports and LPT ports above can. When an I/O device wants to gain the attention of the operating system, it signals this by causing an IRQ to occur. When the operating system is ready to respond to the request, it interrupts itself and performs the service .

As above, the choices are On and Off. Off is the default.

When set On, activeity will neither prevent the system from going into a power management mode nnor awaken it.

IRQ3(COM2)

IRQ4(COM1)

IRQ5(LPT2)

IRQ6(Floppy Disk)

IRQ7(LPT1)

IRQ8(RTC Alarm)

IRQ9(IRQ2 Redir)

IRQ10(Reserved)

IRQ11(Reserved)

IRQ12(PS/2 Moused)

IRQ13(Coprocessor)

IRQ14(Reserved)

IRQ15(Reserved)

3.6 PNP / PCI Configuration Setup

■ Figure 6. PNP / PCI Configuration Setup Menu

ROM PCI/ISA BIOS (xxxxxxx)
 PNP / PCI FUNCTION SETUP
 AWARD SOFTWARE, INC.

PNP OS Istalled	:	NO	CPU to PCI Write Buffer	:	Enabled
Resources Controlled BY	:	Manual	PCI Dynamic Bursting	:	Enabled
Reset Configuration Data	:	Disabled	PCI Master 0 WS Write	:	Enabled
IRQ-3 assigned to	:	PCI / ISA PnP	PCI Delay Transaction	:	Enabled
IRQ-4 assigned to	:	PCI / ISA PnP	PCI #2 Access #1 Retry	:	Disabled
IRQ-5 assigned to	:	PCI / ISA PnP	AGP Master 1 WS Write	:	Enabled
IRQ-7 assigned to	:	PCI / ISA PnP	AGP Master 1 WS Read	:	Disabled
IRQ-9 assigned to	:	PCI / ISA PnP	PCI IRQ Actived By	:	Level
IRQ-10 assigned to	:	PCI / ISA PnP	Assign IRQ For USB	:	Disabled
IRQ-11 assigned to	:	PCI / ISA PnP	Assign IRQ For VGA	:	Disabled
IRQ-12 assigned to	:	PCI / ISA PnP			
IRQ-14 assigned to	:	PCI / ISA PnP			
IRQ-15 assigned to	:	PCI / ISA PnP			
DMA-0 assigned to	:	PCI / ISA PnP			
DMA-1 assigned to	:	PCI / ISA PnP	ESC : Quit	↑ ↓ → ← :	Select Item
DMA-3 assigned to	:	PCI / ISA PnP	F1 : Help	PU/PD/+/- :	Modify
DMA-5 assigned to	:	PCI / ISA PnP	F5 : Old Values	<Shift> F2 :	Color
DMA-6 assigned to	:	PCI / ISA PnP	F7 : Load Setup Defaults		
DMA-7 assigned to	:	PCI / ISA PnP			

PnP OS Installed

When set to YES, BIOS will only initialize the PnP cards used for booting (VGA, IDE, SCSI). The rest of the cards will be initialized by the PnP operating system like WindowsTM95. When set to NO, BIOS will initialize all the PnP cards. Therefore for non-PnP operating system (DOS, NetwareTM), this option must set to “NO”.

Resources Controlled By “Auto” or “Manual”

By Choosing “Auto” the system BIOS will detect the system resource and automatically assign the relative IRQ and DMA channel for each peripheral.

By Choosing “Manual”(default), the user will need to assign IRQ & DMA for add-on cards. Be sure that there are no IRQ/DMA and I/O ports conflict.

Reset Configuration Data

The system BIOS supports the PnP feature so the system needs to record which resource is assigned and protect resources from conflict. Every peripheral device has a node which is called ESCD. This node records which resources are assigned to it. The system needs to record and update ESCD to the memory locations. These locations (4K) are reserved at the system BIOS.

If Disabled (default) is chosen, the system’s ESCD will update only when the new configuration varies from the last one.

If Enabled is chosen, the system is forced to update ESCDs and then is automatically set to the “Disabled” mode.

IRQ-3	assigned to : PCI / ISA PnP
IRQ-4	assigned to : PCI / ISA PnP
IRQ-5	assigned to : PCI / ISA PnP
IRQ-7	assigned to : PCI / ISA PnP
IRQ-9	assigned to : PCI / ISA PnP

IRQ-10	assigned to : PCI / ISA PnP
IRQ-11	assigned to : PCI / ISA PnP
IRQ-12	assigned to : PCI / ISA PnP
IRQ-14	assigned to : PCI / ISA PnP
IRQ-15	assigned to : PCI / ISA PnP
DMA-0	assigned to : PCI / ISA PnP
DMA-1	assigned to : PCI / ISA PnP
DMA-3	assigned to : PCI / ISA PnP
DMA-5	assigned to : PCI / ISA PnP
DMA-6	assigned to : PCI / ISA PnP
DMA-7	assigned to : PCI / ISA PnP

The above settings will be shown on the screen only if “Manual” is chosen for the Resources Controlled By function.

Legacy is the term which signifies that a resource is assigned to the ISA Bus and provides for non PnP ISA add-on cards. PCI / ISA PnP signifies that a resource is assigned to the PCI Bus or provides for ISA PnP add-on cards and peripherals.

CPU to PCI Write Buffer

When enabled, up to four Dwords of data can be written to the PCI bus without interrupting the CPU. When disabled, a write buffer is not used and the CPU read cycle will not be completed until the PCI bus signals that it is ready to receive the data..

Choices are *Enabled, Disabled*.

PCI Dynamic Burstin

When *Enabled*, every write transaction goes to the write buffer. Burstable transactions then burst on the PCI bus and nonburstable transactions don't.

Choices are *Enabled, Disabled*.

PCI Master 0 WS Write

When *Enabled*, writes to the PCI bus are executed with zero wait states.
Choices are *Enabled, Disabled*.

PCI Delay Transaction

The chipset has an embedded 32-bit posted write buffer to support delay transactions cycles. Select *Enabled* to support compliance with PCI specification version 2.1.
The choice: *Enabled, Disabled*.

PCI#2 Access #1 Retry

This item allows you enable/disable the PCI #2 Access #1 Retry.
The choice: *Enabled, Disabled*.

AGP Master 1 WS Write

This implements a single delay when writing to the AGP Bus. By default, two-wait states are used by the system, allowing for greater stability.
The choice: *Enabled, Disabled*.

AGP Master 1 WS Read

This implements a single delay when reading to the AGP Bus. By default, two-wait states are used by the system, allowing for greater stability.
The choice: *Enabled, Disabled*.

PCI IRQ Activated By

This sets the method by which the PCI bus recognizes that an IRQ service is being requested by a device. Under all circumstances, you should retain the default configuration unless advised otherwise by your system's manufacturer.
Choices are *Level* (default) and *Edge*.

Assign IRQ For USB

Name the interrupt request (IRQ) line assigned to the USB/VGA/ACPI (if any) on your system. Activity of the selected IRQ always awakens the system.

3.7 Load Setup Defaults

Chipset defaults indicate the values required by the system for maximum performance.

■ Figure 7. Load Setup Defaults Screen

ROM PCI/ISA BIOS (xxxxxxx)
CMOS SETUP UTILITY
AWARD SOFTWARE, INC.

STANDARD CMOS SETUP	INTEGRATED PERIPHERALS
BIOS FEATURES SETUP	SUPERVISOR PASSWORD
CHIPSET FEATURES SETUP	USER PASSWORD
POWER MANAGEMENT SETUP	IDE HDD AUTO DETECTION
PCI & PCI CONFIGUR	LOAD SETUP Defaults (Y/N) ? N SETUP
LOAD SETUP DEFAULTS	SAVING
Esc : Quit	↑ ↓ → ← : Select Item

F10 : Save & Exit Setup	(Shift) F2 : Change Color
Load SETUP Defaults except Standard CMOS SETUP	

If you wish to load the SETUP Defaults, change the prompt to <Y> and press <ENTER>.

3.8 Integrated Peripherals Setup

■ Figure 8. Integrated Peripherals Setup Menu

ROM PCI/ISA BIOS (xxxxxxx)
 INTEGRATED PERIPHERALS
 AWARD SOFTWARE, INC.

Onchip IDE Channel0	: Enabled	Parallel Port Mode	: SPP
Onchip IDE Channel1	: Enabled		
IDE Prefetch Mode	: Enabled		
IDE Primary Master PIO	: Auto		
IDE Primary Slave PIO	: Auto		
IDE Secondary Master PIO	: Auto		
IDE Secondary Slave PIO	: Auto		
IDE Primary Master UDMA	: Auto		
IDE Primary Slave UDMA	: Auto		
IDE Secondary Master UDMA	: Auto		
IDE Secondary Slave UDAM	: Auto		
Init Display First	: AGP		
Onboard FDC Controller	: Enabled		
Onboard Serial Port 1	: 3F8/IRQ4		
Onboard Serial Port 2	: 2F8/IRQ3		
UART2 Mode	: Standard		
Onboard Parallel Port	: 378/IRQ7		
		ESC : Quit ↑↓→← : Select Item	
		F1 : Help PU/PD/+/- : Modify	
		F5 : Old Values <Shift> F2 : Color	
		F7 : Load Setup Defaults	

OnChip IDE Channel0

This chipset contains a PCI IDE interface with support for two IDE channels. Select Enabled to activate the first and/or second IDE interface. Select Disabled to deactivate this interface, if you install a first and/or second add-in IDE interface.

OnChip IDE Channel1

This chipset contains a PCI IDE interface with support for two IDE channels. Select Enabled to activate the first and/or second IDE interface. Select Disabled to deactivate this interface, if you install a first and/or second add-in IDE interface.

Enabled	Second HDD controller used.
Disabled	Second HDD controller not used.

IDE Prefetch Mode

The onboard IDE drive interfaces supports IDE prefetching, for faster drive accesses. If you install a primary and/or secondary add-in IDE interfaces, set this field to Disabled if the interface does not support prefetching.

The choice: Enabled, Disabled.

IDE Primary / Secondary Master / Slave PIO

The IDE PIO (Programmed Input / Output) fields let you set a PIO mode (0-4) for each of the IDE devices that the onboard IDE interface supports. Modes 0 through 4 provide successively increased performance. In Auto mode, the system automatically determines the best mode for each device.

The choice: Auto

IDE Primary / Secondary Master / Slave UDMA

Ultra DMA /33 implementation is possible only if your IDE hard drive supports it and the operating environment includes a DMA drive (Windows 95 OSR2 or a third party IDE bus master driver). If your hard drive and your system software both support Ultra DMA/33, select Auto to enable BIOS support.

The choice: Auto

Init Display First

This item allows you to decide to active PCI Slot or AGP first .The choice: PCI Slot, AGP

On-Chip Primary IDE / Secondary PCI IDE

The integrated peripheral controller contains an IDE interface with support for two IDE channels. Select Enabled to activate each channel separately.

The choice: Enabled

Onboard FDC Controller

The choice: Enabled / Disabled The system has an onboard Super I/O chip with a FDD controller that supports 2 FDDs for 360K / 720K / 1.2M / 1.44M / 2.8M. Choose “Enabled” to use the onboard FDD controller for accessing the FDD. Otherwise choose “Disabled” to use the off-board FDD controller.

Onboard Serial Port 1

The choice: Disabled / (3F8 / IRQ4) / (2F8 / IRQ3) / (3E8 / IRQ4) / (2E8 / IRQ3)

Onboard Serial Port 2

Disabled / (3F8 / IRQ4) / (2F8 / IRQ3) / (3E8 / IRQ4) / (2E8 / IRQ3)

The system has an Onboard Super I/O chipset with 2 serial ports.

The Onboard serial ports can be selected as:

The choice:Disabled

3F8 / IRQ4	COM1 uses IRQ4
2F8 / IRQ3	COM2 uses IRQ3
3F8 / IRQ4	COM3 uses IRQ4
2F8 / IRQ3	COM4 uses IRQ3

UART2 Mode

This item allow you to determine which Infra Red(IR) function of onboard I/O chip.

Onboard Parallel Port

The choice: Disabled there is a built-in parallel port on the on-board Super I/O

The choice: (3BCH/IRQ7) Chipset that provides Standard, ESP, and EPP features.

The choice: (278H/IRQ5) It has the following options:
 The choice:Disable
 3BCH/IRQ7 Line Printer port 0
 278H/IRQ5 Line Printer port 2
 378H/IRQ5 Line Printer port 1

Parallel Port Mode

SPP : Standard Parallel Port
 EPP : Enhanced Parallel Port
 ECP : Extended Capability Port

To operate the onboard parallel port as Standard Parallel Port only, choose "SPP." To operate the onboard parallel port in the ECP and SPP modes simultaneously, choose "ECP/SPP." By choosing "ECP" the onboard parallel port will operate in ECP mode only. Choosing "ECP/EPP" will allow the onboard parallel port to support both the ECP and EPP modes simultaneously. The ECP mode has to use a DMA channel so choose the onboard parallel port with the ECP feature. After selecting it the following message will appear: "ECP Mode Use DMA". At this time the user can choose between DMA channels 3 or 1. The onboard parallel port is EPP Spec. Compliant so after the user chooses the onboard parallel port with the EPP function, the following message will be displayed on the screen: "Parallel port EPP Type." At this time either EPP 1.7 spec. Or EPP 1.9 spec. Can

Be chosen.

3.9 CPU FEATURES SETUP

■ Figure9. CPU Features Setup

ROM PCI/ISA BIOS (xxxxxxxx)
CPU FEATURES SETUP
AWARD SOFTWARE, INC.

CPU Host / PCI Clock	: Hardware	
CPU Warning Temperature	: 60° C/140° F	
Current System Temp	:	
Current CPU1 Temperature	:	
Current CPUFAN1 Speed	:	
Vcore	:	
+5V	:	
-12V	:	
Shutdown Temperature	: 60° C/140° F	
		ESC : Quit ↑ ↓ → ← :Select Item
		F1 : Help PU/PD/+/- : Modify
		F5 : Old Values <Shift> F2 : Color
		F7 : Load Setup Defaults

CPU Host/PCI Clock

This function allows you to select the CPU host frequency (By pass the hardware setting).The over speed setting are not guaranted by manufacture.

CPU Warning Temperature

CPU Warning Temperature Select.

Monitor CPU Temp. at 50°C/122°F,if Temp.> 50°C/122°F will cause

system alarming.

Current System Temp

Detect System Temperature automatically.

Current CPU1 Temperature

Detect CPU Temperature automatically.

Current CPU FAN1 Speed

Detect CPU Fan speed status automatically.

Vcore +3.3V,+5V,+12V,-12V,-5V

Detect System Voltage automatically.

Shutdown Temperature

If the temperature over setup value ,system will shutdown automatically.

3.10 Supervisor / User Password Setting

■ Figure 10. Supervisor Password Setting

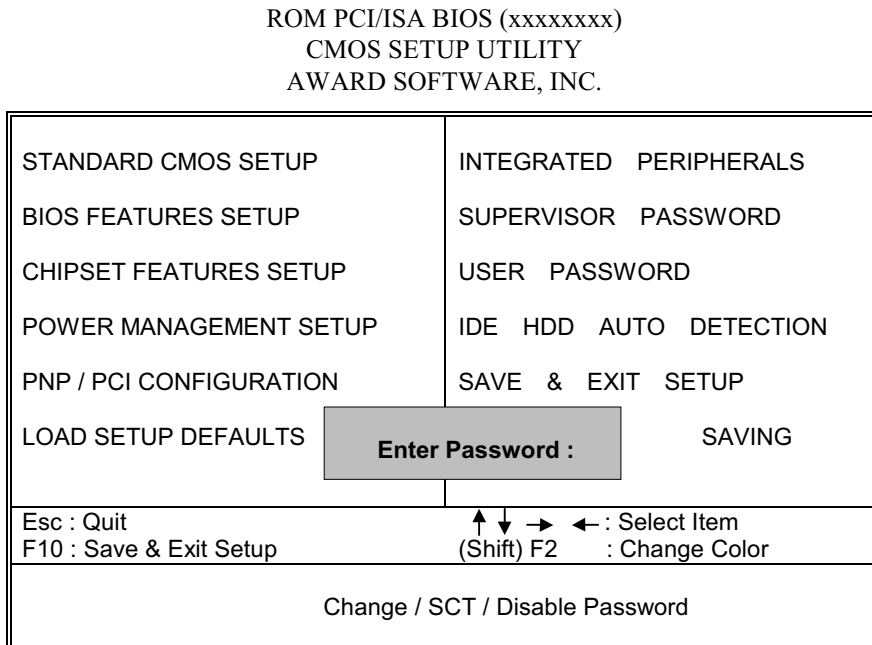

When you select this function, the following message will appear at the center of the screen to assist you in creating a password.

ENTER PASSWORD

Type the password, up to eight characters, and press <Enter>. The password you type now will clear any previously entered password from

CMOS memory. You will be asked to confirm the password. Type the password again and press <Enter>. You may also press <ESC> to abort the selection and not enter a password. To disable password, just press

<Enter> when you are prompted to enter password. A message will confirm that you wish to disable the password. Once the password is disabled, the system will boot and you can enter setup freely.

PASSWORD DISABLED

If you select “System” at the Security Option of BIOS Features Setup Menu, you will be prompted for the password every time the system is rebooted or any time you try to enter Setup. If you select “Setup” at Security Option of BIOS Feature Setup Menu, you will be prompted only when you try to enter Setup.

3.11 IDE HDD Auto Detection

Automatically configure hard disk parameters. The parameters shown below are only examples.

■ **Figure 11. Auto Configuration with Optimal Settings Screen**

ROM PCI/ISA BIOS (xxxxxxx)
CMOS SETUP UTILITY
AWARD SOFTWARE, INC.

HARD DISKS	TYPE	SIZE	CYLS	HEAD	PRECOMP	LAND	SECTOR	MODE
Primary Master	:User	343	665	16	65535	664	63	NORMAL

Select Primary Slave Option (N=Skip) N							
OPTIONS	SIZE	CYLS	HEAD	PRECOMP	LANDZ	SECTOR	MODE
1(Y)	0	0	0	0	0	0	NORMAL

Note : Some Oses (like SCO-UNIX) must use "NORMAL" for installation

ESC : Skip

When you enter this utility, the screen asks you to select a specific hard disk for Primary Master. If you accept a hard disk detected by the BIOS, you can enter "Y" to confirm and then press <Enter> to check next hard disk. This function allows you to check four hard disks and you may press the <Esc> after the <Enter> to exit this function and go back to the Main Menu.

3.12 Save & Exit Setup

Save CMOS value changes to CMOS and exit setup.

■ **Figure 12. Save & Exit Setup Screen**

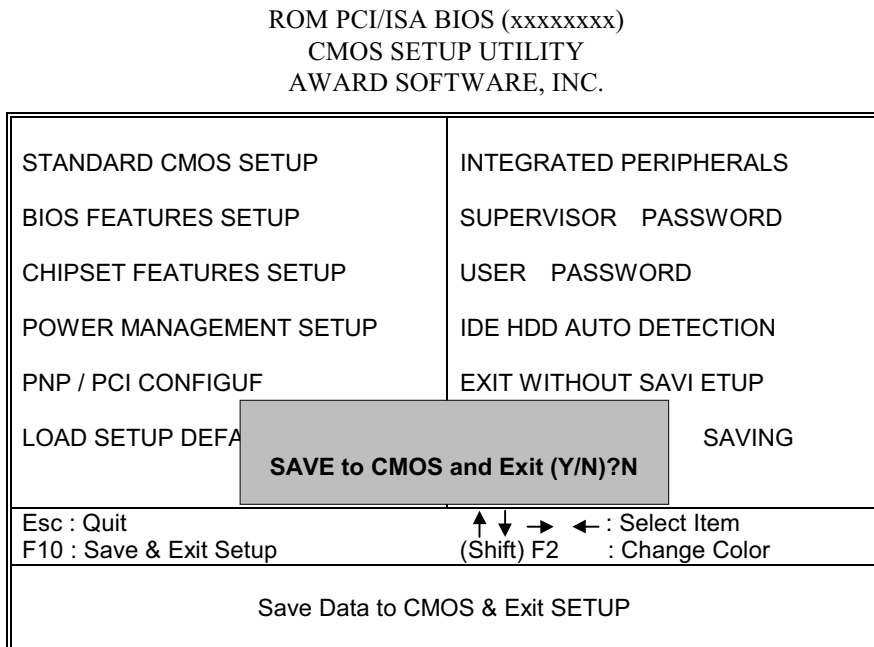

Pressing <N> and <ENTER> will return you to the Main Menu.

Pressing <Y> and <ENTER> will save the system parameters and continue with the booting process.

3.13 Exit Without Saving

Abandon all CMOS value changes and exit setup.

■ **Figure 13. The Save Settings and Exit Screen**

ROM PCI/ISA BIOS (xxxxxxx)
CMOS SETUP UTILITY
AWARD SOFTWARE, INC.

STANDARD CMOS SETUP	INTEGRATED PERIPHERALS
BIOS FEATURES SETUP	SUPERVISOR PASSWORD
CHIPSET FEATURES SETUP	USER PASSWORD
POWER MANAGEMENT SETUP	IDE HDD AUTO DETECTION
PNP / PCI CONFIGURATION	TUP
LOAD SETUP DEFAULTS	AVING
Quit Without Saving (Y/N)?N	
Esc : Quit	↑ ↓ → ← : Select Item
F10 : Save & Exit Setup	(Shift) F2 : Change Color
Abandon All Data & Exit SETUP	

Pressing <N> and <ENTER> will return you to the Main Menu.

Pressing <Y> and <ENTER> will continue with booting process without saving any system parameters.

3.14 Application Software

- Please use the “BIOS Utility” diskette to setup Flash Memory.
- The diskette contains the intelligent installation utility **AWDFLASH.EXE**, displayed below.

■ **Figure 14. Flash Memory Writer**

FLASH MEMORY WRITER Vxx	
Copyright (C) 1992-1994 Award Software, Inc.,	
For xx-xxxxxxxxxxxxxxxxxxx	DATE: xx/xx/xxxx
Flash Type -	
File Name to Program:	<input type="text"/>
Error Message :	Do You Want To Save Bios (Y/N)?

4. Trouble Shooting

PROBLEM

No power to the system at all. Power light does not illuminate, fan inside power supply does not turn on. Indicator light on keyboard does not turn on.

PROBABLE CAUSE	DIAGNOSIS	SOLUTION
Power cable is unplugged.	Visually inspect power cable	Make sure power cable is securely plugged in
Defective power cable.	Visual inspection, try another cable.	Replace cable.
Power supply failure.	Power cable and wall socket are OK, but system is still dead.	Contact technical support.
Faulty wall outlet; circuit breaker or fuse blown.	Plug in device known to work in socket and test	Use different socket, repair outlet, reset circuit breaker or replace fuse.

PROBLEM

System inoperative. Keyboard lights are on, power indicator lights are lit, hard drive is spinning.

PROBABLE CAUSE	DIAGNOSIS	SOLUTION
Expansion card is partially dislodged from expansion slot on the motherboard.	Turn off computer. Take cover off system unit. Check all expansion cards to ensure they are securely seated in slots.	Using even pressure on both ends of the expansion card, press down firmly on expansion card.
Defective floppy disk drive or tape drive.	Turn system off. Disconnect the cables from one of the floppy drives. Turn on the floppy drives. Turn on the system, check to see if the keyboard operates normally. Repeat until you have located defective unit.	Contact Technical Support.
Defective expansion card.	Turn computer off. Remove an expansion card	Make sure expansion card is secure in expansion socket.

PROBLEM

System does not boot from hard disk drive, can be booted from floppy disk drive.

PROBABLE CAUSE	DIAGNOSIS	SOLUTION
Connector between hard drive and system board unplugged.	When attempting to run the FDISK utility described in the HARD DISK section of this manual you get a message, INVALID DRIVE SPECIFICATION.	Check cable running from disk to disk controller board. Make sure both ends are securely plugged in; check the drive type in the Standard CMOS Setup (see HARD DISK section of this manual).
Damaged Hard Disk or Disk Controller.	Format hard disk; if unable to do so the hard disk may be defective.	Contact Technical Support.
Hard Disk directory or FAT is scrambled.	Run the FDISK program, format the hard drive (see HARD DRIVE section of manual). Copy data that was backed up onto Hard Drive.	Backing up the hard drive is extremely important. All Hard Disk are capable of breaking down at any time.

PROBLEM

System only boots from floppy Disk. Hard disk can be read and applications can be used but booting from Hard Disk is impossible.

PROBABLE CAUSE	DIAGNOSIS	SOLUTION
Hard Disk boot program has been destroyed.	A number of causes could be behind this.	Back up data and applications files. Reformat the Hard Drive as described in the Hard Drive section of this manual. Re-install applications and data using backup disks.

PROBLEM

Error message reading "SECTOR NOT FOUND" or other error messages not allowing certain data to be retrieved.

PROBABLE CAUSE	DIAGNOSIS	SOLUTION
A number of causes could be behind this.	Use a file by file backup instead of an image backup in order to backup the Hard Disk.	Back up any salvageable data. Then low level format, partition, and high level format the hard drive (see Hard Disk section of this manual for instructions). Re-install all saved data when completed.

PROBLEM

Disk formatted on IBM PS/2 will not operate with this system.

PROBABLE CAUSE	DIAGNOSIS	SOLUTION
The IBM PS/2 uses a different format than other computers.	IBM PS/2 disk format will not work in an AT type computer.	Format disk in the AT type computer insert disk into the IBM PS/2 and copy the files you wish.

PROBLEM

After installing an expansion card (network card, tape drive card, etc.) the system no longer works properly.

PROBABLE CAUSE	DIAGNOSIS	SOLUTION
No power to monitor.	All or part of the system may be inoperable. The new card may work but a mouse or COM port may not work	Change the interrupt or RAM address on the new expansion card. See the documentation that came with the new card in order to change pin settings. Many expansion devices come with proprietary software that will assist you in doing this.

PROBLEM

Screen message says “Invalid Configuration” or “CMOS Failure.”

PROBABLE CAUSE	DIAGNOSIS	SOLUTION
Incorrect information entered into the configuration (setup) program.	Check the configuration program. Replace any incorrect information.	Review system's equipment . Make sure correct information is in setup.

PROBLEM

Screen is blank.

PROBABLE CAUSE	DIAGNOSIS	SOLUTION
No power to monitor.		Check the power connectors to monitor and to system. Make sure monitor is connected to display card, change I/O address on network card if applicable
Monitor not connected to computer.		See instructions above.
Network card I/O address conflict.		See instructions above.

PROBLEM

PROBABLE CAUSE	DIAGNOSIS	SOLUTION
Memory problem, display card jumpers not set correctly.		Reboot computer. Reinstall memory, make sure that all memory modules are installed in correct sockets. Check jumper and switch settings on display card. See display card section for information on settings.
Computer virus.		Use anti-virus programs (McAfee, E-Prot, etc) to detect and clean viruses.

PROBLEM

Screen goes blank periodically.

PROBABLE CAUSE	DIAGNOSIS	SOLUTION
Screen saver is enabled.		Disable screen saver.

PROBLEM

Keyboard failure.

PROBABLE CAUSE	DIAGNOSIS	SOLUTION
Keyboard is disconnected.		Reconnect keyboard. Check keys again, if no improvement replace keyboard.

PROBLEM

No color on screen.

PROBABLE CAUSE	DIAGNOSIS	SOLUTION
Faulty Monitor.		If possible, connect monitor to another system. If no color replace monitor.
CMOS incorrectly set up.		Call technical support.

PROBLEM

Floppy drive light stays on.

PROBABLE CAUSE	DIAGNOSIS	SOLUTION
Floppy Drive cable not connected correctly.		Reconnect floppy cable making sure PIN1 on the Floppy Drive corresponds with PIN1 on Floppy cable connector.

PROBLEM

Error reading drive A:

PROBABLE CAUSE	DIAGNOSIS	SOLUTION
Bad floppy disk.		Try new floppy disk
Floppy disk not formatted		Format floppy disk (type FORMAT A:type ENTER)>

PROBLEM

C: drive failure.

PROBABLE CAUSE	DIAGNOSIS	SOLUTION
SETUP program does not have correct information.		Boot from drive A: using DOS system disk. Input correct information to SETUP program.
Hard Drive cable not connected properly.		Check Hard Drive cable.

PROBLEM

Cannot boot system after installing second hard drive.

PROBABLE CAUSE	DIAGNOSIS	SOLUTION
Master/Slave jumpers not set correctly.		Set Master/Slave jumpers correctly.
Hard Drives not compatible / different manufacturers.		Run SETUP program and select correct drive types. Call Drive manufacturers for compatibility with other drives.

PROBLEM

Missing operating system on hard drive.

PROBABLE CAUSE	DIAGNOSIS	SOLUTION
CMOS setup has been changed.		Run setup and select correct drive type.

PROBLEM

Certain keys do not function.

PROBABLE CAUSE	DIAGNOSIS	SOLUTION
Keys jammed or defective.		Replace keyboard.

PROBLEM

Keyboard is locked, no keys function.

PROBABLE CAUSE	DIAGNOSIS	SOLUTION
Keyboard is locked.		Unlock keyboard

01/05/1999
MADE IN TAIWAN
R.O.C