

---

# M5VNB

## Federal Communications Commission (F.C.C) Statement

This device complies with Part 15 of the FCC Rules. Operation of this device is subject to the following two conditions: (1) this device may not cause harmful interference, and (2) this device must accept any interference received, including interference that may cause undesired operation.

Accessories: This device has been tested and found to comply with the limits of a Class B digital device, the accessories associated with this equipment are as follows:

1. Shielded serial cable. (Can be obtained from multiple retail outlets)
2. Shielded printer cable. (Can be obtained from multiple retail outlets)
3. Shielded video cable. (Can be obtained from multiple retail outlets)
4. Shielded power cord. (Provided by manufacturer)

These accessories are required to be used in order to ensure compliance with FCC Rules. It is the responsibility of the user to provide and use these accessories properly.

This equipment has been tested and found to comply with the limits of a Class B digital device, pursuant to Part 15 of the FCC Rules. These limits are designed to provide reasonable protection against harmful interference in a residential installation. This equipment generates, uses and can radiate radio frequency energy and, if not installed and used in accordance with the instructions, may cause harmful interference to radio communications. However, there is no guarantee that interference will not occur in a particular installation. If this equipment does cause harmful interference to radio or television reception, which can be determined by turning the equipment off and on, the user is encouraged to try to correct the interference by one or more of the following measures:

1. Reorient / Relocate the receiving antenna.
  2. Increase the separation between the equipment and receiver.
  3. Connect the equipment into an outlet on a circuit different from that to which the receiver is connected.
-

---

4. Consult the dealer or an experienced radio/TV technician for help.

Caution: Changes or modifications not expressly approved by the manufacturer could void the user's authority to operate the equipment.

## **Disclaimer**

The Vendor makes no representations or warranties with respect to the contents here of and specially disclaims any implied warranties of merchantability or fitness for any purpose. Further the Vendor reserves the right to revise this publication and to make changes from time to time in the contents here of without obligation to notify any party beforehand. Duplication of this publication, in part or in whole, is not allowed without first obtaining the Vendor's approval in writing.

## **Trademarks and Remarks**

MS-DOS, Windows, Windows NT, and Windows 9x are products of Microsoft Corp, with its ownership of trademark, and are distributed by the Vendor under a license agreement.

All trademarks used in this manual are the property of their respective owners.

Copyright(C) 1992  
All Rights Reserved

## **Canadian D.O.C. Statement**

This digital apparatus does not exceed the Class B limits for radio noise emissions from digital apparatus as set out in the radio interference regulations of the Canadian Department of Communications.

Cet appareil numérique n'émet pas de bruits radioélectriques dépassant les limites appliqués aux appareils numériques de Class B prescrits dans le règlement du brouillage radioélectrique édicté par le ministère Des Communications du Canada.

---

## **Contents**

---

|   |            |
|---|------------|
| <b>Introduction .....</b>                           | <b>1-1</b> |
| <b>1. Motherboard Description .....</b>             | <b>1-2</b> |
| 1.1 Features .....                                  | 1-2        |
| 1.1.1 Hardware .....                                | 1-2        |
| 1.1.2 Software .....                                | 1-7        |
| 1.1.3 Attachments.....                              | 1-7        |
| 1.2 Motherboard Installation.....                   | 1-8        |
| 1.2.1 Layout of Motherboard .....                   | 1-8        |
| 1.3 Motherboard Connectors.....                     | 1-9        |
| 1.3.1 Front Panel Connectors (JPANEL1 / 2).....     | 1-10       |
| 1.3.2 Hard Disk Connectors (IDE1/ IDE2) .....       | 1-12       |
| 1.3.3 Floppy Disk Connector (FDD1).....             | 1-12       |
| 1.3.4 ATX Power Connector (JATXPWR1).....           | 1-13       |
| 1.3.5 AT Power Connector (JATPWR1).....             | 1-13       |
| 1.4 Serial and Parallel Interface Ports .....       | 1-14       |
| 1.5 CPU Installation/Jumper Setting.....            | 1-20       |
| 1.5.1 CPU Installation Procedure.....               | 1-20       |
| 1.5.2 CPU Voltage & Ratio Frequency Selection ..... | 1-21       |
| 1.6 Jumper Settings .....                           | 1-23       |
| 1.6.1 CMOS Function Selection (JCMOS1).....         | 1-24       |
| 1.6.2 Wake-On-LAN Header (JWOL1) (Optional).....    | 1-24       |
| 1.6.3 CPU Fan Power Connector: (JCFAN1) .....       | 1-25       |

## **Contents**

---

|  |            |
|--|------------|
| 1.6.4 System Fan Power Connector: (JSFAN1) (Optional) .....    | 1-25       |
| 1.7 DRAM Installation.....                                     | 1-26       |
| 1.7.1 DIMM .....   | 1-26       |
| 1.7.2 How to install a DIMM Module.....                        | 1-28       |
| 1.8 Audio Subsystem .....                                      | 1-29       |
| 1.8.1 CD Audio-In Connector (JCDIN1) / (JCDIN2:Optional) ..... | 1-29       |
| <b>2. BIOS Setup.....</b>                                      | <b>2-1</b> |
| 2.1 Main Menu.....   | 2-3        |
| 2.2 Standard CMOS Setup.....                                   | 2-5        |
| 2.3 BIOS Features Setup.....                                   | 2-9        |
| 2.4 Chipset Features Setup.....                                | 2-14       |
| 2.5 Power Management Setup .....                               | 2-17       |
| 2.6 PNP / PCI Configuration Setup.....                         | 2-22       |
| 2.7 Load BIOS Defaults.....                                    | 2-24       |
| 2.8 Load SETUP Defaults.....                                   | 2-25       |
| 2.9 CPU Speed Setting.....                                     | 2-26       |
| 2.10 Integrated Peripherals Setup .....                        | 2-27       |
| 2.11 Supervisor / User Password Setting .....                  | 2-30       |
| 2.12 IDE HDD Auto Detection.....                               | 2-32       |
| 2.13 Save & Exit Setup .....                                   | 2-33       |
| 2.14 Exit Without Saving.....                                  | 2-34       |
| <b>3. Software Setup .....</b>                                 | <b>3-1</b> |

## **Contents**

---

|                                  |            |
|----------------------------------|------------|
| 3.1 Software List.....           | 3-1        |
| 3.2 Software Installation .....  | 3-2        |
| 3.3 Using Software.....          | 3-3        |
| <b>4. Trouble Shooting .....</b> | <b>4-1</b> |

## Introduction

### System Overview

Thanks for buying this product! This manual was written to help you start using this product as quickly and smoothly as possible. Inside you will find adequate explanations to solve most problems. In order for this reference material to be of greatest use, refer to the “expanded table of contents” to find relevant topics.

This board incorporates the system board, ISA I/O, and PCI IDE and AGP VGA into one board that provides a total PC solution. The motherboard, a processor based PC/Baby AT system, supports a 512KB/1024KB cache with ISA Bus, and PCI Local Bus to support upgrades to your system performance. It is ideal for multi-tasking and fully supports MS-DOS, Windows, Windows NT, Windows 2000, Novell, OS/2, Windows9x, UNIX, SCO UNIX etc. This manual also explains how to install the motherboard for operation, and how to setup your CMOS configuration with the BIOS setup program.

# 1. Motherboard Description

## 1.1 Features

### 1.1.1 Hardware

#### Socket 7 Host Interface

- Supports all Socket-7 / Super-7 processors including 64-bit Intel Pentium<sup>TM</sup> / Pentium<sup>TM</sup> with MMX<sup>TM</sup>, AMD 6K86<sup>TM</sup> (K6<sup>TM</sup> and K6-2<sup>TM</sup>), Cyrix / IBM 6x86<sup>TM</sup> / 6x86MX<sup>TM</sup>, IDT / Centaur C6, and Rise MP6 CPUs.
- 66 / 100 MHz CPU "Front Side Bus".
- Supports 3.3V and sub-3.3V interface to CPU.
- Built-in de-skew PLL (Phase Lock Loop) circuitry for optimal skew control within and between clocking regions.
- Cyrix / IBM 6x86<sup>TM</sup> linear burst support.
- AMD K6<sup>TM</sup> and K6-2<sup>TM</sup> write combining.
- System management interrupt, memory remap and clock mechanisms.

#### Internal Accelerated Graphics Port (AGP) Controller

- AGP v2.0 compliant for 1x and 2x transfer modes..
- Pipelined split-transaction long-burst transfers up to 533 MB/sec.
- Eight level read request queue.
- Four level posted-write request queue.
- Thirty-two level (quadwords) read data FIFO (128 bytes).
- Sixteen level (quadwords) write data FIFO (64 bytes).
- Intelligent request reordering for maximum AGP bus utilization.
- Supports Flush /Fence commands.
- Graphics Address Relocation Table (GART).
- One level TLB structure.
- Sixteen entry fully associative page table.
- LRU replacement scheme.
- Independent GART lookup control for host /AGP /PCI master accesses.

- Windows 95 OSR-2 VXD and integrated Windows 98 / NT5 miniport driver support.

**Sophisticated Power Management Features**

- Independent clock stop controls for CPU / SDRAM, Internal AGP and PCI bus.
- PCI and AGP bus clock run and clock generator control.
- Suspend power plane preserves memory data.
- Suspend-to-DRAM and Self-Refresh operation.
- Dynamic clock gating for internal functional blocks for power reduction during normal operation.
- Low-leakage I/O pads.

**General Graphic Capabilities**

- 64-bit Single Cycle 2D/3D Graphics Engine.
- Supports 2 to 8 Mbytes of Frame Buffer located in System Memory.
- Real Time DVD MPEG-2 and AC-3 Playback.
- Video Processor.
- I<sup>2</sup>C Serial Interface.
- Integrated 24-bit 230MHz True Color DAC.
- Extended Screen Resolutions up to 1024x768.
- Extended Text Modes 80 or 132 columns by 25/30/43/60 rows.
- DirectX 6 and OpenGL ICD API.

**High Performance CADE3D™ Accelerator**

- 32 entry command queue, 32 entry data queue.
- 4Kbyte texture cache with over 90% hit rates.
- Pipelined Setup / Texturing / Rendering Engines.
- DirectDraw™ acceleration.
- Multiple buffering and page flipping.

**Setup Engine**

- 32-bit IEEE floating point input data.
- Slope and vertex calculations.
- Back facing triangle culling.
- 1/16 sub-pixel positioning.

**Rendering Engine**

- High performance single pass execution.



- Diffused and specular lighting.
- Gouraud and flat shading.
- Anti-aliasing including edge, scene, and super-sampling.
- OpenGL compliant blending for fog and depth-cueing.
- 16-bit Z-buffer.
- 8/16/32 bit per pixel color formats.

**Texturing Engine**

- D3D compressed texture formats DXT1 and DXT2.
- Anisotropic texture filtering.
- 1/2/4/8-bits per pixel quality non-palletized textures.
- 16/2-bits per pixel quality non-palletized textures.
- Pallet formats in ARGB 565, 1555, or 444.
- Tri-linear, bi-linear, and point-sampled filtering.
- Mip-mapping with multiple Level-Of-Detail (LOD) calculations and perspective correction.
- Color keying for translucency.

**2D GUI Engine**

- 8/15/16/24/32-bits per pixel color formats.
- 256 Raster Operations (ROPs).
- Accelerated drawing: BitBLTs, lines, polygons, fills, patterns, clipping, bit masking.
- Panning, scrolling, clipping, color expansion, sprites.
- 32x32 and 64x64 Hardware Cursor.
- DOS graphics and text modes.

**DVD**

- Hardware-Assisted MPEG-2 Architecture for DVD with AC-3.
- Simultaneous motion compensation and front-end processing (pareing, decryption and decode).
- Supports full DVD 1.0, VCD 2.0 and CD-Karaoke.
- Microsoft DirectShow 2.x native support, backward compatible to MCI.
- No additional frame buffer requirements.
- Dynamic frame and field de-interlace filtering for high quality playback on VGA monitors (Bob and Weave).
- Tamper-proof software CSS implementation.

- Freeze, Fast-Forward, Slow Motion, Reverse.
- Pan-and-Scan support for 16:9 Sequence.

**Super I/O Built-in onboard**

- Support one multi-mode Parallel Port.
  - (1) Standard & Bidirection Parallel Port (SPP).
  - (2) Enhanced Parallel Port (EPP).
  - (3) Extended Capabilities Port (ECP).
- Supports two serial ports, 16550 UART with 16 byte FIFO.
- UART data rates up to 1.5 Mbaud.
- Supports one Infrared transmission (IR) port.
- Supports PS/2 Mouse.
- Supports 360KB, 720KB, 1.2MB, 1.44MB and 2.88MB floppy disk drives.

**Direct Sound Ready AC97 Digital Audio Controller**

- Dual full-duplex Direct Sound channels between system memory and AC97 link.
- PCI master interface with scatter / gather and bursting capability.
- 32 byte FIFO of each direct sound channel.
- Host based sample rate converter and mixer.
- Standard v1.0 or v2.0 AC97 Codec interface for single or cascaded AC97 Codec's from multiple vendors.
- Loopback capability for re-directing mixed audio streams into USB and 1394 speakers.
- Hardware SoundBlaster Pro for Windows DOS box and real-mode Dos legacy compatibility.
- Plug and play with 4 IRQ, 4 DMA, and 4 I/O space options for SoundBlaster Pro and MIDI hardware.
- Hardware assisted FM synthesis for legacy compatibility.
- Direct two game ports and one MIDI port interface.
- Complete software driver support for Windows 95, Windows 98, Windows NT and Windows 2000.

**Power Management**

- Supports both ACPI (Advanced Configuration and Power Interface) and legacy (APM) power management.
- ACPI v1.0 Compliant.
- APM v1.2 Compliant.
- CPU clock throttling and clock stop control for complete ACPI C0 to C3 state support.

## **1.1.2 Software**

### **BIOS**

- AWARD legal & user-friendly BIOS.
- Supports PnP functions.

### **Operating Systems**

- Offers the highest performance for MS-DOS OS/2, Windows NT, Windows 2000, Windows 31 / 95 / 98, Novell, UNIX, SCO UNIT, and others.

## **1.1.3 Attachments**

- HDD Cable.
- FDD Cable.
- COM1 Cable.
- COM2 / Printer Cable.
- VGA Cable.
- AudioGame Port Cable.

## 1.2 Motherboard Installation

### 1.2.1 Layout of Motherboard

#### Model No.M5VNB

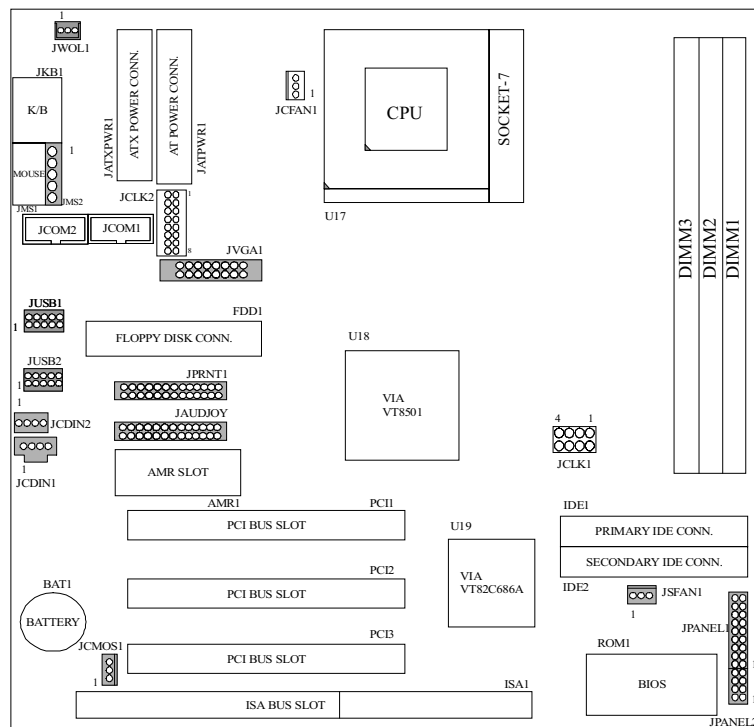

## 1.3 Motherboard Connectors

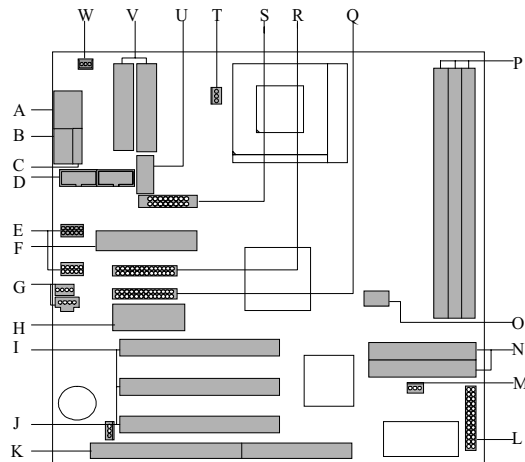

- |   |  |
|---|--|
| <b>A. Keyboard Connector (JKB1)</b>                             | <b>M. System Fan (*JSFAN1)</b>                     |
| <b>B. PS/2 Mouse Connector (JMS1)</b>                           | <b>N. IDE Connector (IDE1-2)</b>                   |
| <b>C. Mouse Connector (JMS2)</b>                                | <b>O. CPU Frequency Selection (JCLK1)</b>          |
| <b>D. Com Ports (JCOM1/JCOM2)</b>                               | <b>P. DIMMs (DIMM1-3)</b>                          |
| <b>E. USB Connector(JUSB1) (*JUSB2)</b>                         | <b>Q. Game Port (JAUDJOY)</b>                      |
| <b>F. Floppy Disk Connector (FDD1)</b>                          | <b>R. Print Port (JPRNT1)</b>                      |
| <b>G. CD Audio-In Conn. (JCDIN1) (*JCDIN2)</b>                  | <b>S. VGA Connector (JVGA1)</b>                    |
| <b>H. AMR Connector (AMR1)</b>                                  | <b>T. CPU FAN Connector (JFAN1)</b>                |
| <b>I. PCI Bus Slots (PCI1-PCI3)</b>                             | <b>U. CPU Voltage &amp; Ratio Slection (JCLK2)</b> |
| <b>J. COMS Function Selection (JCMOS1) (JATPWR1 / JATXPWR1)</b> | <b>V. ATX &amp; AT Power Connectors</b>            |
| <b>K. ISA Bus Slot (ISA1)</b>                                   | <b>W. Wake on LAN (*JWOL1)</b>                     |
| <b>L. Front Panel Connectors (JPANEL1/2)</b>                    |  |

NOTE: The “ \* ” mark represent the function is optional.

### 1.3.1 Front Panel Connectors (JPANEL1 / 2)

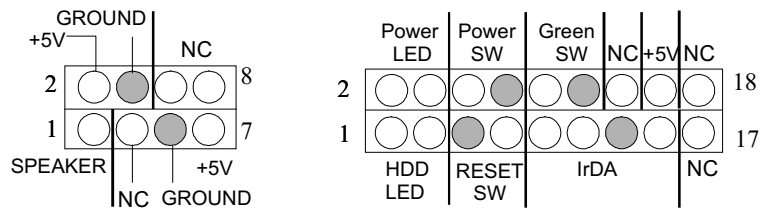

| Pin No. | Assignment | Function          | Pin No. | Assignment    | Function         |
|---------|------------|-------------------|---------|---------------|------------------|
| 1       | Speaker    | Speaker Connector | 2       | +5V           | VCC              |
| 3       | NC         |                   | 4       | Ground        | Ground           |
| 5       | Ground     |                   | 6       | NC            | NC               |
| 7       | +5V        |                   | 8       | NC            | NC               |
| 1       | HDD LED(+) | HDD               | 2       | Power LED(+)  | Power            |
| 3       | HDD LED(-) | LED               | 4       | Power LED (-) | LED              |
| 5       | Ground     | Reset             | 6       | PW-ON         | ATX Power Button |
| 7       | Reset      | Button            | 8       | Ground        |                  |
| 9       | +5V        | IrDA Connector    | 10      | Green Switch  | Green Button     |
| 11      | IRRX       |                   | 12      | Ground        |                  |
| 13      | Ground     |                   | 14      | NC            | NC               |
| 15      | IRTX       |                   | 16      | +5V           | VCC              |
| 17      | NC         | NC                | 18      | NC            | NC               |

**Speaker Connector**

An off-board speaker can be installed on the motherboard as a manufacturing option. An off-board speaker can be connected to the motherboard at the front panel connector. The speaker (onboard or off-board) provides error beep code information during the Power On Self-Test when the computer cannot use the video interface. The speaker is not connected to the audio subsystem and does not receive output from the audio subsystem.

**Reset Button**

This connector can be connected to a momentary SPST type switch that is normally open. When the switch is closed, the motherboard resets and runs the POST.

**Power LED Connector**

This connector can be connected to an LED that will flash when the computer is sleeping.

**Hard Drive LED Connector**

This connector can be connected to an LED to provide a visual indicator that data is being read from or written to a hard drive. For the LED to function properly, an IDE drive must be connected to the onboard hard drive controller.

**Infrared Connector**

After the IrDA interface is configured, files can be transferred from or to portable devices such as laptops, PDAs, and printers using application software.

**Green (Sleep/Resume) Switch**

When APM is enabled in the system BIOS, and the operating system's APM driver is loaded, the system can enter sleep (standby) mode in one of the following ways:

- Optional front panel SMI button
- Prolonged system inactivity using the BIOS inactivity timer feature

The 2-pin header located on the front panel I/O connector supports a front panel SMI switch, which must be a momentary SPST type that is normally open.

Closing the SMI switch sends a System Management Interrupt (SMI) to



the processor, which immediately goes into System Management Mode (SMM). While the computer is in sleep mode it is fully capable of responding to and servicing external interrupts (such as an incoming fax) even though the monitor turns on only if a keyboard or mouse interrupt occurs. To reactivate or resume the system, the SMI switch must be pressed again, or the keyboard or mouse must be used.

#### **Power On Button (Use ATX Power)**

This connector can be connected to a front panel power switch. The switch must pull the Power Button pin to ground for at least 50 ms to signal the power supply to switch on or off. (The time requirement is due to internal debounce circuitry on the motherboard.) At least two seconds must pass before the power supply will recognize another on/off signal.

### **1.3.2 Hard Disk Connectors (IDE1/ IDE2)**

The motherboard has a 32-bit Enhanced PCI IDE Controller that provides PIO Mode 0~4, Bus Master, and Ultra DMA 33 / 66 functionality. It has two HDD connectors IDE1 (primary) and IDE2 (secondary). You can connect up to four hard disk drives, a CD-ROM, a 120MB Floppy (reserved for future BIOS) and other devices to IDE1 and IDE2. These connectors support the IDE hard disk cable provided.

- IDE1 (Primary IDE Connector)

The first hard drive should always be connected to IDE1. IDE1 can connect a Master and a Slave drive. You must configure the second hard drive on IDE1 to Slave mode by setting the jumper accordingly.

- IDE2 (Secondary IDE Connector)

The IDE2 controller can also support a Master and a Slave drive. The configuration is similar to IDE1. The second drive on this controller must be set to slave mode.

### **1.3.3 Floppy Disk Connector (FDD1)**

The motherboard provides a standard floppy disk connector (FDC) that supports 360K, 720K, 1.2M, 1.44M and 2.88M floppy disk types. This connector supports the provided floppy drive ribbon cables.

### 1.3.4 ATX Power Connector (JATXPWR1)

This connector supports the power button on-board. Using the ATX power supply, functions such as Modem Ring Wake-Up and Soft Power Off are supported on this motherboard. This power connector supports instant power-on functionality, which means that the system will boot up instantly when the power connector is inserted on the board.

| PIN | VOLTAGE | PIN | VOLTAGE |
|-----|---------|-----|---------|
| 1   | 3.3 V   | 11  | 3.3 V   |
| 2   | 3.3 V   | 12  | -12 V   |
| 3   | GND     | 13  | GND     |
| 4   | 5 V     | 14  | PS_ON   |
| 5   | GND     | 15  | GND     |
| 6   | 5 V     | 16  | GND     |
| 7   | GND     | 17  | GND     |
| 8   | PW_OK   | 18  | -5 V    |
| 9   | 5V_SB   | 19  | 5 V     |
| 10  | 12 V    | 20  | 5 V     |

*Warning: Since the motherboard has the instant power on function, make sure that all components are installed properly before inserting the power connector to ensure that no damage will be done.*

### 1.3.5 AT Power Connector (JATPWR1)

| PIN | VOLTAGE | PIN | VOLTAGE |
|-----|---------|-----|---------|
| 1   | PW_OK   | 7   | GND     |
| 2   | 5V      | 8   | GND     |
| 3   | 12V     | 9   | -5V     |
| 4   | -12V    | 10  | 5V      |
| 5   | GND     | 11  | 5V      |
| 6   | GND     | 12  | 5V      |

## 1.4 Serial and Parallel Interface Ports

This system is equipped with two serial ports and one parallel port. Both types of interface ports will be explained in this chapter.

### The Serial Interface Port

The serial interface port is sometimes referred to as a RS-232 port or an asynchronous communications port. Mice, printers, modems and other peripheral devices can be connected to a serial port. The serial port can also be used to connect your computer with another computer system. If you wish to transfer the contents of your hard disk to another system it can be accomplished by using each machine's serial port.

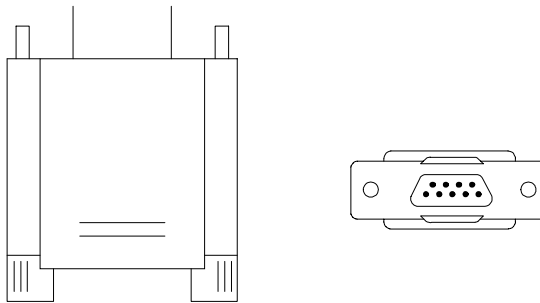

The serial ports on this system have two types of connectors, one 9-pin and one 25-pin. Some older computer systems and peripherals may only have a 25-pin connector. Should you need to connect your 9-pin serial port to a 25-pin serial port, you can purchase a 9-to-25 pin adapter.

**Connectivity**

The many ways that a serial port can be used make it necessary to be familiar with the pinout diagram. The following chart gives you the function of each pin on the 9-pin connector. This information can be used when configuring certain software programs to work with the serial port.

| <b>Signal</b> | <b>Name</b>         | <b>DB9 PIN</b> | <b>DB25 PIN</b> |
|---------------|---------------------|----------------|-----------------|
| DCD           | Data Carrier Detect | 1              | 8               |
| RX            | Receive Data        | 2              | 3               |
| TX            | Transmit Data       | 3              | 2               |
| DTR           | Data Terminal Ready | 4              | 20              |
| GND           | Signal Ground       | 5              | 7               |
| DSR           | Data Set Ready      | 6              | 6               |
| RTS           | Request to Send     | 7              | 4               |
| CTS           | Clear to Send       | 8              | 5               |
| RI            | Ring Indicator      | 9              | 22              |

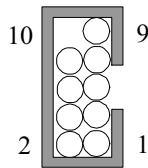
**The Serial Interface Port-II : JCOM2**

| Signal | Name                | IDC PIN |
|--------|---------------------|---------|
| DCD    | Data Carrier Detect | 1       |
| RX     | Receive Data        | 2       |
| TX     | Transmit Data       | 3       |
| DTR    | Data Terminal Ready | 4       |
| GND    | Signal Ground       | 5       |
| DSR    | Data Set Ready      | 6       |
| RTS    | Request to Send     | 7       |
| CTS    | Clear to Send       | 8       |
| RI     | Ring Indicator      | 9       |

**Special Applications**

There are two types of serial devices that can be connected to a serial port. One of the devices is called "DTE" (Data Terminal Equipment) and the other device is called "DCE" (Data Communications Equipment). If a modem is connected to a computer, for example, the modem is called the DCE and the computer is called the DTE. In situations such as this, the pins on the serial ports can be connected straight through.

In instances when there are two DTE devices connected together, such as a computer and a printer, a special adapter called a "Null Modem" is needed to make communication between the two devices possible.

When using the serial port to communicate between devices, one problem in particular may arise. Some manufacturers use one set of signals to begin communication with another device and other manufacturers do not use these

signals to initiate communication. If you encounter a communication problem that cannot be resolved using a null modem, it can generally be assumed that one device is using the initialization signals and the other device is not. This can usually be resolved by wiring the RTS, CTS, and DCD pins together.

### **Serial Ports/COM Ports**

The two serial ports on the computer are called COM1 and COM2, respectively. If you wish, two more serial ports can be added onto the computer using optional hardware. Should you choose to add the extra Serial ports (COM ports), they would be called COM3 and COM4.

When using serial ports to communicate with a peripheral devices, be sure to assign only one COM port number to each device. For example, if a printer and a scanner are both connected to your computer through serial ports the printer must be assigned one COM port (i.e. COM1) and the scanner must be assigned the other COM port (i.e. COM2). No two devices can be assigned to one COM port. Each peripheral must have its own COM port.

**NOTE: Four serial ports may be installed on the computer. However, no more than two ports can be used simultaneously.**

\*If you have installed an internal modem, be careful not to assign a COM port number that has already been assigned to another device. This error is common.

When installing a device that is going to require the use of a serial port, use a diagnostic program to find out which ports are available. It may be necessary to remove expansion cards that have serial ports in order to check their jumper settings. The jumper settings will indicate which COM port the card has been assigned. Checking the expansion card will eliminate mistakes in overlapping COM ports. Once you have completed the installation of peripheral devices using the serial ports, be sure that the communication parameters such as baud rate, parity bit, etc. are matching. If your computer is set for a baud rate of 9600 and your modem is set for a baud rate of 2400, you will not be able to send messages. The manuals that accompany the peripheral devices will inform you on the procedure for setting their parameters. Software manuals will also have instructions on setting parameters.

### Parallel Interface Port

Unlike the serial port, parallel interface ports have been standardized and should not present any difficulty interfacing peripherals to your system. Sometimes called a Centronics port, the parallel port is almost exclusively used with printers. The parallel port on your system has a 25-pin Header (see picture below). The pinouts for the parallel port are shown in the table below.

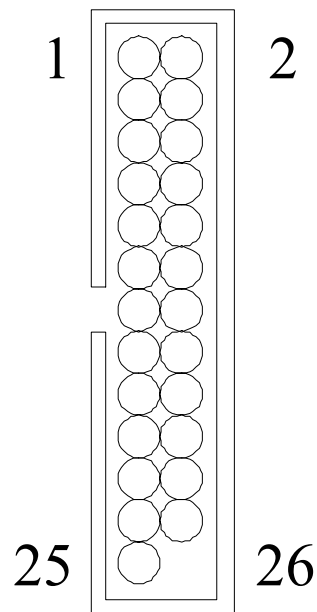

| Signal      | Pin |
|-------------|-----|
| -Strobe     | 1   |
| Data 0      | 3   |
| Data 1      | 5   |
| Data 2      | 7   |
| Data 3      | 9   |
| Data 4      | 11  |
| Data 5      | 13  |
| Data 6      | 15  |
| Data 7      | 17  |
| -Ack        | 19  |
| Busy        | 21  |
| Paper Empty | 23  |
| +Select     | 25  |
| -Auto FDXT  | 2   |
| -Error      | 4   |
| -Init       | 6   |
| -SLCTN      | 8   |
| Ground      | 10  |
| Ground      | 12  |
| Ground      | 14  |
| Ground      | 16  |
| Ground      | 18  |
| Ground      | 20  |
| Ground      | 22  |
| Ground      | 24  |
| NC          | 26  |

**PS/2 Mouse Connector: (JMS2)**

| Pin | Signal Name  |
|-----|--------------|
| 1   | Data         |
| 2   | No connect   |
| 3   | Ground       |
| 4   | +5 V (fused) |
| 5   | Clock        |

**Game Port & Audio Connector: (JAUDJOY)**

| Pin | Signal Name    | Pin | Signal Name      |
|-----|----------------|-----|------------------|
| 1   | +5V            | 2   | +5V              |
| 3   | GP6            | 4   | GP4              |
| 5   | GP2            | 6   | GP0              |
| 7   | MIDI-OUTR      | 8   | Ground           |
| 9   | GP3            | 10  | Ground           |
| 11  | GP7            | 12  | GP1              |
| 13  | MIDI-INR       | 14  | GP5              |
| 15  | NC             | 16  | +5V              |
| 17  | Audio Left In  | 18  | Audio Right In   |
| 19  | Ground         | 20  | Ground           |
| 21  | Mono In        | 22  | MIC bias voltage |
| 23  | Ground         | 24  | Ground           |
| 25  | Audio Left Out | 26  | Audio Right Out  |



## 1.5 CPU Installation/Jumper Setting

### 1.5.1 CPU Installation Procedure

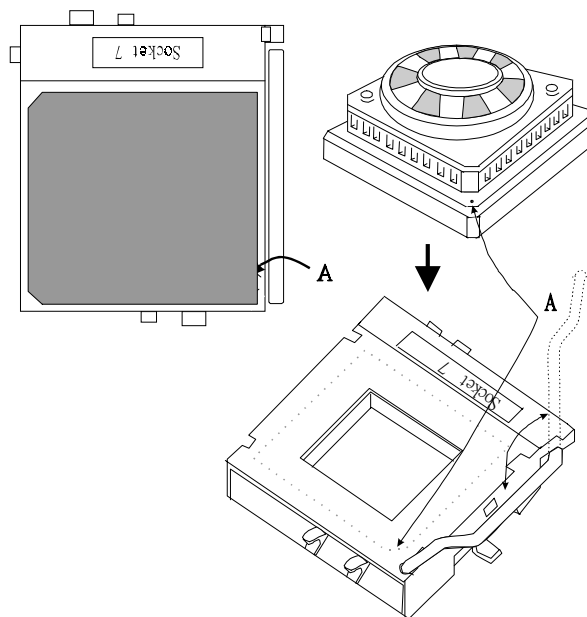

1. Pull the lever sideways away from the socket then raise the lever up to a 90-degree angle.
2. Locate Pin A in the socket and look for the white dot or cut edge in the CPU. Match Pin A with the white dot/cut edge then insert the CPU.
3. Press the lever down to complete the installation.

### 1.5.2 CPU Voltage & Ratio Frequency Selection

#### CPU Voltage & Ratio Selection: (JCLK2)

| JCLK2<br>VCC2 | 1     | 2     | 3     | 4     |
|---------------|-------|-------|-------|-------|
| 0             | OPEN  | OPEN  | OPEN  | OPEN  |
| 2.1           | CLOSE | OPEN  | OPEN  | OPEN  |
| 2.2           | OPEN  | CLOSE | OPEN  | OPEN  |
| 2.3           | CLOSE | CLOSE | OPEN  | OPEN  |
| 2.4           | OPEN  | OPEN  | CLOSE | OPEN  |
| 2.5           | CLOSE | OPEN  | CLOSE | OPEN  |
| 2.6           | OPEN  | CLOSE | CLOSE | OPEN  |
| 2.7           | CLOSE | CLOSE | CLOSE | OPEN  |
| 2.8           | OPEN  | OPEN  | OPEN  | CLOSE |
| 2.9           | CLOSE | OPEN  | OPEN  | CLOSE |
| 3.0           | OPEN  | CLOSE | OPEN  | CLOSE |
| 3.1           | CLOSE | CLOSE | OPEN  | CLOSE |
| 3.2           | OPEN  | OPEN  | CLOSE | CLOSE |
| 3.3           | CLOSE | OPEN  | CLOSE | CLOSE |
| 3.4           | OPEN  | CLOSE | CLOSE | CLOSE |
| 3.5           | CLOSE | CLOSE | CLOSE | CLOSE |

| JCLK2<br>CPU/HOST RATIO | 5     | 6     | 7     |
|-------------------------|-------|-------|-------|
| 2.5                     | CLOSE | CLOSE | OPEN  |
| 3.0                     | OPEN  | CLOSE | OPEN  |
| 2.0                     | CLOSE | OPEN  | OPEN  |
| 1.5/3.5                 | OPEN  | OPEN  | OPEN  |
| 4.5                     | CLOSE | CLOSE | CLOSE |
| 5.0                     | OPEN  | CLOSE | CLOSE |
| 4.0                     | CLOSE | OPEN  | CLOSE |
| 5.5                     | OPEN  | OPEN  | CLOSE |

**CPU & PCI Frequency: (JCLK1)**



| <b>CPU</b>      | <b>PCI</b>   | <b>1</b> | <b>2</b> | <b>3</b> | <b>4</b> |
|-----------------|--------------|----------|----------|----------|----------|
| <b>60</b>       | <b>30</b>    | OPEN     | OPEN     | OPEN     | OPEN     |
| <b>66.8</b>     | <b>33.4</b>  | CLOSE    | OPEN     | OPEN     | OPEN     |
| <b>70</b>       | <b>35</b>    | OPEN     | CLOSE    | OPEN     | OPEN     |
| <b>97</b>       | <b>31.75</b> | OPEN     | OPEN     | CLOSE    | OPEN     |
| <b>95.25</b>    | <b>32.3</b>  | OPEN     | CLOSE    | CLOSE    | OPEN     |
| <b>100</b>      | <b>33.33</b> | CLOSE    | CLOSE    | CLOSE    | OPEN     |
| <b>105(103)</b> | <b>35</b>    | CLOSE    | CLOSE    | OPEN     | CLOSE    |

## 1.6 Jumper Settings

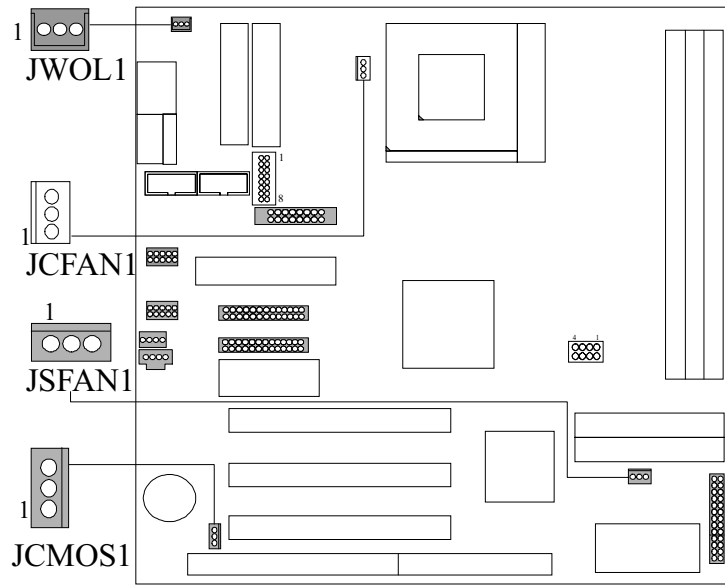
A jumper has two or more pins that can be covered by a plastic jumper cap, allowing you to select different system options.



### 1.6.1 CMOS Function Selection (JCMOS1)

| JCMOS1  | Assignment                 |
|---|----------------------------|
| <br>1-2 Closed | Normal Operation (default) |
| <br>2-3 Closed | Clear CMOS Data (*Note)    |
| <br>Open       | Onboard Battery Disabled   |

Note: Please follow the procedure as below to clear CMOS Data.

Note: Please follow the procedure as below to clear BIOS Password if your password is lost or forgotten.

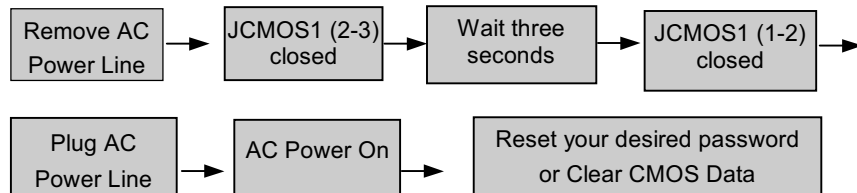

### 1.6.2 Wake-On-LAN Header (JWOL1) (Optional)

| Pin No. | Assignment |
|---------|------------|
| 1       | 5V_SB      |
| 2       | Ground     |
| 3       | Wake-up    |

**1.6.3 CPU Fan Power Connector: (JCFAN1)**

| Pin No. | Assignment     |
|---------|----------------|
| 1       | Sense          |
| 2       | +12 V          |
| 3       | Control Signal |

**1.6.4 System Fan Power Connector: (JSFAN1)  
(Optional)**

| Pin No. | Assignment     |
|---------|----------------|
| 1       | Sense          |
| 2       | +12 V          |
| 3       | Control Signal |

## 1.7 DRAM Installation

### 1.7.1 DIMM

DRAM Access Time : 3.3V Unbuffered SDRAM PC100 Type required.

DRAM Type : 8MB/16MB/32MB/64MB/128MB/256MB DIMM Module (168pin)

| Total<br>Memory Size (MB) | Bank 0<br>DIMM1 | Bank 1<br>DIMM2 | Bank 2<br>DIMM3 |
|---------------------------|-----------------|-----------------|-----------------|
| 8 M                       | 8M x 1 pc       | ----            | ----            |
| 16 M                      | 16M x 1 pc      | ----            | ----            |
| 32 M                      | 32M x 1 pc      | ----            | ----            |
| 64 M                      | 64M x 1 pc      | ----            | ----            |
| 128 M                     | 128M x 1 pc     | ----            | ----            |
| 256 M                     | 256M x 1 pc     | ----            | ----            |
| 16 M                      | 8M x 1 pc       | 8M x 1 pc       | ----            |
| 32 M                      | 16M x 1 pc      | 16M x 1 pc      | ----            |
| 64 M                      | 32M x 1 pc      | 32M x 1 pc      | ----            |
| 128 M                     | 64M x 1 pc      | 64M x 1 pc      | ----            |
| 256 M                     | 128M x 1 pc     | 128M x 1 pc     | ----            |
| 512 M                     | 256M x 1 pc     | 256M x 1 pc     | ----            |
| 24 M                      | 8M x 1 pc       | 8M x 1 pc       | 8M x 1 pc       |
| 40 M                      | 16M x 1 pc      | 16M x 1 pc      | 8M x 1 pc       |
| 72 M                      | 32M x 1 pc      | 32M x 1 pc      | 8M x 1 pc       |
| 136 M                     | 64M x 1 pc      | 64M x 1 pc      | 8M x 1 pc       |
| 264 M                     | 128M x 1 pc     | 128M x 1 pc     | 8M x 1 pc       |
| 520 M                     | 256M x 1 pc     | 256M x 1 pc     | 8M x 1 pc       |
| 32 M                      | 8M x 1 pc       | 8M x 1 pc       | 16M x 1 pc      |
| 48 M                      | 16M x 1 pc      | 16M x 1 pc      | 16M x 1 pc      |
| 80 M                      | 32M x 1 pc      | 32M x 1 pc      | 16M x 1 pc      |
| 144 M                     | 64M x 1 pc      | 64M x 1 pc      | 16M x 1 pc      |
| 272 M                     | 128M x 1 pc     | 128M x 1 pc     | 16M x 1 pc      |
| 528 M                     | 256M x 1 pc     | 256M x 1 pc     | 16M x 1 pc      |
| 48 M                      | 8M x 1 pc       | 8M x 1 pc       | 32M x 1 pc      |
| 64 M                      | 16M x 1 pc      | 16M x 1 pc      | 32M x 1 pc      |
| 96 M                      | 32M x 1 pc      | 32M x 1 pc      | 32M x 1 pc      |
| 160 M                     | 64M x 1 pc      | 64M x 1 pc      | 32M x 1 pc      |
| 288 M                     | 128M x 1 pc     | 128M x 1 pc     | 32M x 1 pc      |
| 544 M                     | 256M x 1 pc     | 256M x 1 pc     | 32M x 1 pc      |
| 80 M                      | 8M x 1 pc       | 8M x 1 pc       | 64M x 1 pc      |
| 96 M                      | 16M x 1 pc      | 16M x 1 pc      | 64M x 1 pc      |
| 128 M                     | 32M x 1 pc      | 32M x 1 pc      | 64M x 1 pc      |
| 192 M                     | 64M x 1 pc      | 64M x 1 pc      | 64M x 1 pc      |
| 320 M                     | 128M x 1 pc     | 128M x 1 pc     | 64M x 1 pc      |
| 576 M                     | 256M x 1 pc     | 256M x 1 pc     | 64M x 1 pc      |

| Total            | Bank 0      | Bank 1      | Bank 2      |
|------------------|-------------|-------------|-------------|
| Memory Size (MB) | DIMM1       | DIMM2       | DIMM3       |
| 144 M            | 8M x 1 pc   | 8M x 1 pc   | 128M x 1 pc |
| 160 M            | 16M x 1 pc  | 16M x 1 pc  | 128M x 1 pc |
| 192 M            | 32M x 1 pc  | 32M x 1 pc  | 128M x 1 pc |
| 256 M            | 64M x 1 pc  | 64M x 1 pc  | 128M x 1 pc |
| 384 M            | 128M x 1 pc | 128M x 1 pc | 128M x 1 pc |
| 640 M            | 256M x 1 pc | 256M x 1 pc | 128M x 1 pc |
| 272 M            | 8M x 1 pc   | 8M x 1 pc   | 256M x 1 pc |
| 288 M            | 16M x 1 pc  | 16M x 1 pc  | 256M x 1 pc |
| 320 M            | 32M x 1 pc  | 32M x 1 pc  | 256M x 1 pc |
| 384 M            | 64M x 1 pc  | 64M x 1 pc  | 256M x 1 pc |
| 512 M            | 128M x 1 pc | 128M x 1 pc | 256M x 1 pc |
| 768 M            | 256M x 1 pc | 256M x 1 pc | 256M x 1 pc |

\*The list shown above for DRAM configuration is only for reference.



## 1.7.2 How to install a DIMM Module

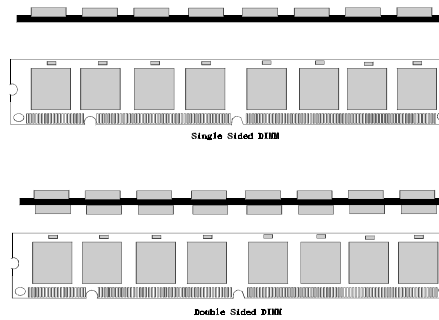

1. The DIMM socket has a "Plastic Safety Tab" and the DIMM memory module has an "asymmetrical notch", so the DIMM memory module can only fit in one direction.

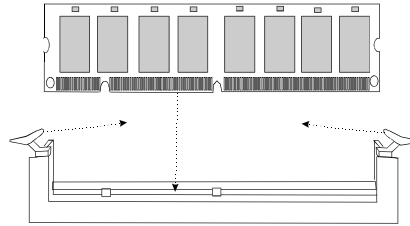

2. Push the tabs out. Insert the DIMM memory modules into the socket at 90-degree angle, then push down vertically so that it will fit into place.

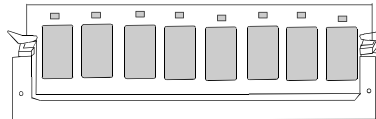

3. The Mounting Holes and plastic tabs should fit over the edge and hold the DIMM memory modules in place.

## 1.8 Audio Subsystem

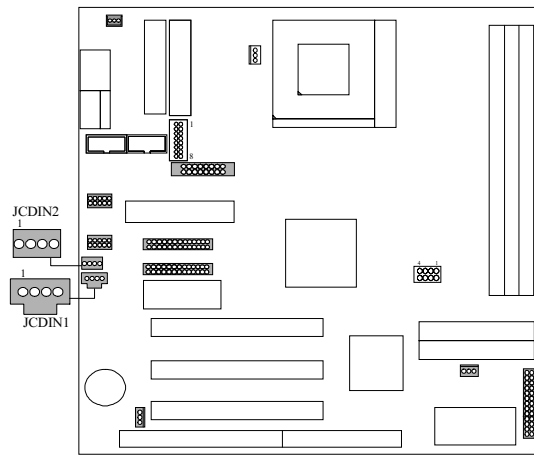

### 1.8.1 CD Audio-In Connector (JCDIN1) / (JCDIN2:Optional)

| Pin No. of JCDIN1 | Assignment          |
|-------------------|---------------------|
| 1                 | Left Channel Input  |
| 2                 | GND                 |
| 3                 | GND                 |
| 4                 | Right Channel Input |

| Pin No. of JCDIN2 | Assignment          |
|-------------------|---------------------|
| 1                 | Left Channel Input  |
| 2                 | CD_GND              |
| 3                 | Right Channel Input |
| 4                 | CD_GND              |

## 2. BIOS Setup

### Introduction

This manual discussed Award™ Setup program built into the ROM BIOS. The Setup program allows users to modify the basic system configuration. This special information is then store in battery-backed RAM so that it retains the Setup information when the power is turned off.

The Award BIOS™ installed in your computer system's ROM (Read Only Memory) is a custom version of an industry standard BIOS. This means that it supports Intel processors in a standard IBM-AT compatible input/output system. The BIOS provides critical low-level support for standard devices such as disk drives and serial and parallel ports.

Adding important has customized the Award BIOS™, but nonstandard, features such as virus and password protection as well as special support for detailed fine-tuning of the chipset controlling the entire system.

The rest of this manual is intended to guide you through the process of configuring your system using Setup.

### Plug and Play Support

These AWARD BIOS supports the Plug and Play Version 1.0A specification. ESCD (Extended System Configuration Data) write is supported.

### EPA Green PC Support

This AWARD BIOS supports Version 1.03 of the EPA Green PC specification.

### APM Support

These AWARD BIOS supports Version 1.1&1.2 of the Advanced Power Management (APM) specification. Power management features are implemented via the System Management Interrupt (SMI). Sleep and Suspend power management modes are supported. Power to the hard disk drives and video monitors can be managed by this AWARD BIOS.

### PCI Bus Support

This AWARD BIOS also supports Version 2.1 of the Intel PCI (Peripheral Component Interconnect) local bus specification. Please see the Intel technical documentation for additional information.

### DRAM Support

SDRAM (Synchronous DRAM) are supported.

### Supported CPUs

This AWARD BIOS supports a single Intel Pentium®!!! & Celeron™ CPU. Dual CPUs are not supported.

### Using Setup

In general, you use the arrow keys to highlight items, press <Enter> to select, use the PageUp and PageDown keys to change entries, press <F1> for help and press <Esc> to quit. The following table provides more detail about how to navigate in the Setup program using the keyboard.

| Keystroke   | Function   |
|-------------|--|
| Up arrow    | Move to previous item  |
| Down arrow  | Move to next item  |
| Left arrow  | Move to the item on the left (menu bar)  |
| Right arrow | Move to the item on the right (menu bar)   |
| Esc         | Main Menu: Quit without saving changes<br>Submenus: Exit Current page to the next higher level menu  |
| Move Enter  | Move to the item you desired   |
| PgUp key    | Increase the numeric value or make changes   |
| PgDn key    | Decrease the numeric value or make changes   |
| + Key       | Increase the numeric value or make changes   |
| - Key       | Decrease the numeric value or make changes   |
| Esc key     | Main Menu – Quit and not save changes into CMOS<br>Status Page Setup Menu and Option Page Setup Menu – Exit Current page and return to Main Menu |
| F1 key      | General help on Setup navigation keys  |
| F5 key      | Load previous values from CMOS   |
| F6 key      | Load the fail-safe defaults from BIOS default table  |
| F7 key      | Load the optimized defaults  |
| F10 key     | Save all the CMOS changes and exit   |

## 2.1 Main Menu

Once you enter AWARD BIOS CMOS Setup Utility, the Main Menu (**Figure 1**) will appear on the screen. The Main Menu allows you to select an item and press <Enter> to accept or enter its sub-menu.

**!! WARNING !!**

The information about BIOS defaults on manual (**Figure 1,2,3,4,5,6,7,8**) is just for reference, please refer to the BIOS installed on board, for update information.

**Figure 1. Main Menu**

ROM PCI/ISA BIOS (xxxxxxx)  
CMOS SETUP UTILITY  
AWARD SOFTWARE, INC.

|                                 |                           |
|---------------------------------|---------------------------|
| <b>STANDARD CMOS SETUP</b>      | CPU SPEED SETTING         |
| BIOS FEATURES SETUP             | INTEGRATED PERIPHERALS    |
| CHIPSET FEATURES SETUP          | SUPERVISOR PASSWORD       |
| POWER MANAGEMENT SETUP          | USER PASSWORD             |
| PNP / PCI CONFIGURATION         | IDE HDD AUTO DETECTION    |
| LOAD BIOS DEFAULTS              | SAVE & EXIT SETUP         |
| LOAD SETUP DEFAULTS             | EXIT WITHOUT SAVING       |
| Esc : Quit    F5 : Menu in BIOS | ↑ ↓ → ← : Select Item     |
| F10 : Save & Exit Setup         | (Shift) F2 : Change Color |
| Time, Date, Hard Disk Type...   |                           |

### Standard CMOS Setup

This setup page includes all the items in a standard compatible BIOS.

**BIOS Features Setup**

This setup page includes all the items for the BIOS special enhanced features.

**Chipset Features Setup**

This setup page includes all the items of chipset special features.

**Power Management Setup**

This setup page includes all the items for power management features.

**PNP / PCI Configuration**

This category specifies the value (in units of PCI bus clocks) of the latency timer for this PCI bus master and the IRQ level for PCI device.

**Load BIOS Defaults**

The BIOS defaults have been set by the manufacturer and represent settings which provide the minimum requirements for your system to operate.

**Load Setup Defaults**

Chipset defaults indicates the values required by the system for maximum performance.

**CPU Speed Setting**

This setup page includes Hardware monitor & Jumper-less features setup.

**Integrated Peripherals**

This setup page includes all the items for Integrated Peripherals features.

**User Password**

Change, set, or disable password. It allows you to limit access to the system and Setup, or just to Setup.

**IDE HDD Auto Detection**

Automatically close figure hard disk parameters.

**Save & Exit Setup**

Save CMOS value changes to CMOS and exit setup.

**Exit Without Saving**

Abandon all CMOS value changes and exit setup.

## 2.2 Standard CMOS Setup

The items in the Standard CMOS Setup Menu are divided into categories. Each category includes setup item(s). Use the arrow keys to highlight the item and then use the <PgUp> or <PgDn> keys to select the value you want for each item.

**Figure 2. Standard CMOS Setup Menu**

ROM PCI/ISA BIOS (xxxxxxx)  
STANDARD CMOS SETUP  
AWARD SOFTWARE, INC.

|   |   |
|---|---|
| Date (mm:dd:yy) : Sat, <b>Mar</b> 11 2000 |   |
| Time (hh:mm:ss) : 9 : 6 : 43              |   |
| HARD DISKS                                | TYPE SIZE CYLS HEAD PRECOMP LANDZ SECTOR MODE |
| Primary Master                            | : Auto 0M 0 0 0 0 0 Auto                      |
| Primary Slave                             | : Auto 0M 0 0 0 0 0 Auto                      |
| Secondary Master                          | : Auto 0M 0 0 0 0 0 Auto                      |
| Secondary Slave                           | : Auto 0M 0 0 0 0 0 Auto                      |
| Drive A                                   | :1.44 M, 3.5 in.                              |
| Drive B                                   | :None   |
| Video                                     | :EGA/VGA                                      |
| Halt On                                   | :All, But Keyboard                            |
|   | Base Memory :640k                             |
|   | Extendd Memory :56320k                        |
|   | O ther Memory :384k                           |
|   | Total Memory :57344k                          |
| Esc : Quit                                | ↑ ↓ → ← : Select Item PU/PD/+/-:Modify        |
| F1 : Help                                 | (Shift) F2 : Change Color                     |

### Date

The Date format is <day><month><date><year>.

|       |   |
|-------|---|
| Day   | The day, from Sun to Sat, is stored by the BIOS and is display-only |
| Date  | The date, from 1 to 31 (or the maximum allowed in the month)        |
| month | The month, Jan through Dec  |
| year  | The year, from 1994 through 2079                                    |

**Time**

The time format is <hour><minute><second>. The time is calculated based on the 24-hour military-time clock. For example, 2 p.m. is 14:00:00.

**Hard Disk Type**

This category identifies the type(s) of hard disk(s) that have been installed in the computer. There are 46 predefined types and a user definable type. Type 1 to Type 45 are predefined. Type "User" is user-definable. Type "Auto" is automatically defined by BIOS.

Press <PgUp> or <PgDn> to select a numbered hard disk type or type the number and press <Enter>. Note that the specifications of your drive must match with the drive table. The hard disk will not work properly if you enter improper information for this category. If your hard disk drive type is not listed, you can use Type "User" to define your own drive type manually.

If you select type "User", information is to be entered for the items in the following chart. Enter the information directly from the keyboard and press <Enter>. This information should be provided in the documentation from your hard disk vendor or the system manufacturer.

**Hint:** Most new drives give the parameters on the label on top of the drive.

|                   |                              |
|-------------------|------------------------------|
| <b>CYLN</b>       | number of cylinders          |
| <b>HEAD</b>       | number of heads              |
| <b>WPCOM</b>      | write precompensation        |
| <b>SEC</b>        | number of sectors            |
| <b>LBA MODE</b>   | type of LBA mode             |
| <b>BLK MODE</b>   | type of Block mode           |
| <b>PIO MODE</b>   | type of PIO                  |
| <b>32BIT MODE</b> | type of 32-Bit transfer mode |

If a hard disk has not been installed select "NOT Installed" and press <Enter>.



**Drive A Type/Drive B Type**

The category identifies the types of floppy disk, drive A or drive B, which has been installed in the computer.

|              |  |
|--------------|--|
| None         | No floppy drive installed                                    |
| 360K, 5 1/4  | 5-1/4 inch PC-type standard drive; 360 kilobyte capacity     |
| 1.2M, 5 1/4  | 5-1/4 inch AT-type high-density drive; 1.2 megabyte capacity |
| 720K, 3 1/2  | 3-1/2 inch double-sided drive; 720 kilobyte capacity         |
| 1.44M, 3 1/2 | 3-1/2 inch double-sided drive; 1.44 megabyte capacity        |
| 2.88M, 3 1/2 | 3-1/2 inch double-sided drive; 2.88 megabyte capacity        |

**Video**

The category selects the type of adapter used for the primary system monitor, and must match your video display card and monitor. Although secondary monitors are supported, you do not have to select the type in Setup.

|                |  |
|----------------|--|
| <b>EGA/VGA</b> | Enhanced Graphics Adapter/Video Graphics Array. For EGA, VGA, SEGA, or PGA monitor adapters. |
| <b>CGA 40</b>  | Color Graphics Adapter, power up in 40 column mode   |
| <b>CGA 80</b>  | Color Graphics Adapter, power up in 80 column mode   |
| <b>MONO</b>    | Monochrome adapter, includes high resolution monochrome adapters                             |

**Halt On**

The category determines whether the computer will stop if an error is detected during power up.

|                   |  |
|-------------------|--|
| No errors         | Whenever the BIOS detects a non-fatal error the system will be stopped and you will be prompted. |
| All errors        | The system boot will not stop for any error that may be detected.                                |
| All, But Keyboard | The system boot will not stop for a keyboard error, it will stop for all other errors.           |
| All, But Diskette | The system boot will not stop for a disk error, it will stop for all other errors.               |
| All, But Disk/Key | The system boot will not stop for a keyboard or disk error, it will stop for all other errors.   |

**Memory**

This category is display-only which is determined by the POST (Power On Self Test) of the BIOS.

**Base Memory**

The POST of the BIOS will determine the amount of base (or conventional) memory installed in the system. The value of the base memory is typically 512K for system with 512K memory installed on the motherboard, or 640K for system with 640K or more memory installed on the motherboard.

**Extended Memory**

The BIOS determines how much extended memory is present during the POST. This is the amount of memory located above 1MB in the CPU's memory address map.

**Other Memory**

This refers to the memory located in the 640K address space. This is the memory that can be used for different applications. DOS uses this area to load device drivers to keep as much base memory free application programs. The most common use for this area is Shadow RAM.

## 2.3 BIOS Features Setup

Figure 3. BIOS Features Setup Menu

ROM PCI/ISA BIOS (xxxxxxx)  
 BIOS FEATURES SETUP  
 AWARD SOFTWARE, INC.

|                           |            |                          |                       |            |
|---------------------------|------------|--------------------------|-----------------------|------------|
| Virus Warning             | : Disabled | Video BIOS               | Shadow                | : Enabled  |
| CPU Internal Cache        | : Enabled  | C8000-CBFFF              | Shadow                | : Disabled |
| External Cache            | : Enabled  | CC000-CFFFF              | Shadow                | : Disabled |
| Quick Power On Self Test  | : Enabled  | D0000-D3FFF              | Shadow                | : Disabled |
| Boot Sequence             | : A,C,SCSI | D8000-DBFFF              | Shadow                | : Disabled |
| Swap Floppy Drive         | : Disabled | DC000-DFFFF              | Shadow                | : Disabled |
| Boot Up Floppy Seek       | : Enabled  |                          |                       |            |
| Boot Up NumLock Status    | : On       |                          |                       |            |
| Gate A20 Option           | : Fast     |                          |                       |            |
| Memory Parity / ECC Check | : Disabled |                          |                       |            |
| Typematic Rate Setting    | : Enabled  |                          |                       |            |
| Typematic Rate(Chars/Sec) | : 6        |                          |                       |            |
| Typematic Delay (Msec)    | : 250      |                          |                       |            |
| Security Option           | : Setup    |                          |                       |            |
| PCI / VGA Palette Snoop   | : Disabled | ESC : Quit               | ↑ ↓ → ← : Select Item |            |
| OS Select For DRAM > 64MB | : Non-OS2  | F1 : Help                | PU/PD/+/- : Modify    |            |
|                           |            | F5 : Old Values          | (Shift) F2 : Color    |            |
|                           |            | F6 : Load BIOS Defaults  |                       |            |
|                           |            | F7 : Load Setup Defaults |                       |            |

**Virus Warning**

This category flashes on the screen. During and after the system boot up, any attempt to write to the boot sector or partition table of the hard disk drive will halt the system and an error message will appear. In the mean time, you can run an anti-virus program to locate the problem.

|                           |   |
|---------------------------|---|
| <b>Disabled</b> (default) | No warning message will appear when any attempts are made to access the boot sector or hard disk partition table.   |
| Enabled                   | Activates automatically when the system boots up causing a warning message to appear when anything attempts to access the boot sector of hard disk partition table. |

**CPU Internal Cache**

These fields allow you to Enabled or Disable the CPU Internal Cache. Caching allow better performance.

|                          |               |
|--------------------------|---------------|
| <b>Enabled</b> (default) | Enable cache  |
| Disabled                 | Disable cache |

**External Cache**

These fields allow you to Enable or Disable the CPU's "Level 2" secondary cache. Caching allows better performance.

|                          |               |
|--------------------------|---------------|
| <b>Enabled</b> (default) | Enable cache  |
| Disabled                 | Disable cache |

**Quick Power On Self Test**

Select Enabled to reduce the amount of time required to run the power-on self-test (POST). A quick POST skips certain steps. We recommend that you normally disable quick POST. Better to find a problem during POST than lose data during your work.

|                          |                   |
|--------------------------|-------------------|
| <b>Enabled</b> (default) | Enable quick POST |
| Disabled                 | Normal POST       |

**Boot Sequence**

This option determines the drive sequence the computer searches for the OS for at boot-up. The settings are "A, C, SCSI", "C, A, SCSI", "C, CDROM, A", "CDROM, C, A", "D, A, SCSI", "E, A, SCSI", "F, A, SCSI", "SCSI, A, C", "SCSI, C, A" or "C only", "LS/ZIP, C", etc. **The default is "A, C, SCSI"**.

**Swap Floppy Drive**

Switches the floppy disk drive between being designated as A and B.  
**Default is Disabled.**

**Boot Up Floppy Seek**

During POST, BIOS will determine if the floppy disk drive installed is 40 or 80 tracks. 360K type is 40 tracks while 720K, 1.2M, and 1.44M are all 80 tracks.

**Enabled** (default)

BIOS searches for the floppy disk drive to determine if it is 40 or 80 tracks. Note that BIOS cannot tell from 720K, 1.2M or 1.44M drive type as they are all 80 tracks.

Disabled

BIOS will not search for the type of floppy disk drive by track number. Note that there will not be any warning message if the drive installed is 360K.

**Boot Up NumLock Status**

**On** (default)

Numpad is number keys.

Off

Numpad is arrow keys.

**Gate A20 Option**

Gate A20 refers to the way the system address memory above 1 MB (extended memory). When set Fast, the system chipset controls Gate A20. When set to Normal, a pin in the Keyboard controller controls Gate A20. Setting Gate A20 to Fast improves system speed, particularly with OS/2 and Windows.

**Fast** (default)

**Memory Parity/ECC Check**

Select Enabled if the DRAM chips in your system support parity.

Enabled

**Disabled** (default)

**Typematic Rate Setting**

This determines the typematic rate.

**Enabled** (default)

Enable typematic rate and typematic delay programming.

Disabled

Disable typematic rate and typematic delay programming. The system BIOS will use

default value and the keyboard controls the function.

### **Typematic Rate (Chars/Sec)**

|             |                          |
|-------------|--------------------------|
| 6 (default) | 6 characters per second  |
| 8           | 8 characters per second  |
| 10          | 10 characters per second |
| 12          | 12 characters per second |
| 15          | 15 characters per second |
| 20          | 20 characters per second |
| 24          | 24 characters per second |
| 30          | 30 characters per second |

### **Typematic Delay (Msec)**

Choose the length of delay from the time you press a key and the character repeating. (units are mil-sec)

### **Security Option**

This category allows you to limit access to the system and Setup, or just to Setup.

|                 |   |
|-----------------|---|
| System          | The system will not boot and access to Setup will be denied if the correct password is not entered at the prompt. |
| Setup (default) | The system will boot, but access to Setup will be denied if the correct password is not entered at the prompt.    |

### **PCI/VGA Palette Snoop**

Choose Disabled or Enabled. Some graphic controllers which are not VGA compatible take the output from a VGA controller and map it to their display as a way to provide boot information and VGA compatibility.

However, the color information coming from the VGA controller is drawn from the palette table inside the VGA controller to generate the proper colors, and the graphic controller needs to know what is in the palette of the VGA controller. To do this, the non-VGA graphic controller watches for the Write access to the VGA palette and registers the snoop data. In PCI based system, where the VGA controller is on the PCI bus and a non-VGA graphic controller is on an ISA bus, the Write Access to the palette will not show up on the ISA bus if the PCI VGA controller responds to the Write.

In this case, the PCI VGA controller should not respond to the Write, it should

only snoop the data and permit the access to be forwarded to the ISA bus. The non-VGA ISA graphic controller can then snoop the data on the ISA bus. Unless you have the above situation, you should disable this option.

|                           |                       |
|---------------------------|-----------------------|
| Enabled                   | Enables the function. |
| <b>Disabled</b> (default) | Disable the function. |

### **OS Select for DRAM > 64MB**

Allows OS/2 to be used with > 64MB of DRAM. Settings are Non-OS/2 and OS/2. Set to OS/2 if using more than 64MB and running OS/2.

**Default is Non-OS2.**

### **Video BIOS Shadow**

Determines whether video BIOS will be copied to RAM for faster execution.

|                          |                           |
|--------------------------|---------------------------|
| <b>Enabled</b> (default) | Optional ROM is enabled.  |
| Disabled                 | Optional ROM is disabled. |

### **C8000 - CBFFF Shadow / DC0000 - DFFFF Shadow**

Determines whether the optional ROM will be copied to RAM for faster execution.

|                           |                               |
|---------------------------|-------------------------------|
| Enabled                   | Optional ROM is shadowed.     |
| <b>Disabled</b> (default) | Optional ROM is not shadowed. |

**Note :** For C8000 - DFFFF option - ROM on PCI BIOS, BIOS will automatically enable the shadow RAM. User does not have to select the item.

## 2.4 Chipset Features Setup

The Chipset Features Setup option is used to change the values of the chipset registers. These registers control most of the system options in the computer.

**Figure 4. Chipset Feature Setup Menu**

| ROM PCI/ISA BIOS (xxxxxxx)   |                        |
|--|------------------------|
| CHIPSET FEATURES SETUP   |                        |
| AWARD SOFTWARE, INC.   |                        |
| Bank 0/1 DRAM Timing   | : <b>SDRAM 8/10 ns</b> |
| Bank 2/3 DRAM Timing   | : SDRAM 8/10 ns        |
| Bank 4/5 DRAM Timing   | : SDRAM 8/10 ns        |
| SDRAM Cycle Length   | : 3                    |
| Video BIOS Cacheable   | : Enabled              |
| Memory Hole  | : Disabled             |
| Init Display First   | : PCI Slot             |
| Frame Buffer Size  | : 8M                   |
| AGP Aperture Size  | : 64M                  |
| OnChip USB   | : Enabled              |
| USB Keyboard Support   | : Disabled             |
| OnChip Sound   | : Auto                 |
| OnChip Modem   | : Auto                 |
| ESC :Quit    ↑↓ →← : Select Item<br>F1 : Help     PU/PD/+/- : Modify<br>F5 : Old Values    (Shift) F2 : Color<br>F6 : Load BIOS Defaults<br>F7 : Load Setup Defaults |                        |

### **Bank 0/1, 2/3, 4/5, DRAM Timing**

The DRAM timing of Bank 0/1, 2/3, 4/5 in this field is set by the system board manufacturer.

**The Choices: Normal, Medium, Fast Turbo, SDRAM 8/10ns.**



**SDRAM Cycle Length**

This field sets the CAS length timing.

**The Choices:** 3 (default), 2.

**Video BIOS Cacheable**

Select Enabled allows caching of the video RAM, resulting in better system performance. However, if any program writes to this memory area, a system error may result. .

**The choices:** Enabled (default), Disabled.

**Memory Hole**

In order improve performance, certain space in memory is reserved for ISA cards. This memory must be mapped into the memory space below 16 MB.

**The choices:** Disabled (default), 15M -16M.

**Init Display First**

This item allows you to decide to active PCI Slot or AGP first.

**The choices:** PCI Slot (default), AGP.

**Frame Buffer Size**

This item allows you to control the VGA frame buffer size.

**The choices:** 8M (default), NA, 4M.

**AGP Aperture Size**

Select the size of the Accelerated Graphics Port (AGP) aperture. The aperture is a portion of the PCI memory address range dedicated for graphics memory address space. Host cycles that hit the aperture range are forwarded to the AGP without any translation.

**The choices:** 64M (default), 64M, 32M, 16M, 8M, 4M, 128M.

**OnChip USB**

This should be enabled if your system has a USB installed on the system board and you wish to use it. Even when so equipped, if you add a higher performance controller, you will need to disable this feature.

**The choices:** **Enabled** (default), Disabled.

**USB Keyboard Support**

Select Enabled if your system contains a Universal Serial Bus (USB) controller and you have a USB keyboard.

**The choices:** **Disabled** (default), Enabled.

**OnChip Sound**

The default setting of this item utilizes an onboard sound chip for audio output. There is no need to buy and insert a sound card. If sound card is installed, disable this item.

**OnChip Modem**

This item allows you to control the onboard MC97 Modem controller.

**The choices:** **Auto** (default), Disabled.

## 2.5 Power Management Setup

Figure 5. Power Management Setup Menu

ROM PCI/ISA BIOS (xxxxxxxx)  
POWER MANAGEMENT SETUP  
AWARD SOFTWARE, INC.

|                     |                  |                          |                       |
|---------------------|------------------|--------------------------|-----------------------|
| ACPI function       | : Enabled        | Primary INTR             | : ON                  |
| Power Management    | : User Define    | IRQ 3 (COM2)             | : Primary             |
| PM Control by APM   | : Yes            | IRQ 4 (COM1)             | : Primary             |
| Video Off Method    | : V/H SYNC+Blank | IRQ 5 (LPT2)             | : Primary             |
| Video Off After     | : Suspend        | IRQ 6 (FDD)              | : Primary             |
| MODEM Use IRQ       | : 3              | IRQ 7 (LPT1)             | : Primary             |
| Doze Mode           | : Disabled       | IRQ 8 (Alarm)            | : Disabled            |
| Suspend Mode        | : Disabled       | IRQ 9 (IRQ 2 Redir)      | : Secondary           |
| HDD Power Down      | : Disabled       | IRQ10 (Rsv)              | : Secondary           |
| Soft-off by PWRBTN  | : Instant-Off    | IRQ11 (Rsv)              | : Secondary           |
| PWRON After PW-Fail | : Former-Sts     | IRQ12 (PS/2)             | : Primary             |
| ** PM Events **     |                  | IRQ13 (CoPro)            | : Primary             |
| VGA                 | : OFF            | IRQ14 (HDD)              | : Primary             |
| LPT & COM           | : LPT/COM        | IRQ15 (Rsv)              | : Disabled            |
| HDD & FDD           | : ON             |                          |                       |
| PCI Master          | : OFF            |                          |                       |
| RTC Alarm Resume    | : Disabled       | ESC : Quit               | ↑ ↓ → ← : Select Item |
| Modem Ring Resume   | : Disabled       | F1 : Help                | PU/PD/+/- : Modify    |
|                     |                  | F5 : Old Values          | (Shift) F2 : Color    |
|                     |                  | F7 : Load Setup Defaults |                       |

### ACPI Function

This item allows you to enable / disable the Advanced Configuration and Management (ACPI).

**The Choices:** Enabled (default), Disabled.

**Power Management**

|                              |  |
|------------------------------|--|
| <b>User Define</b> (default) | Users can configure their own power management.                                |
| Min Saving                   | Pre-defined timer values are used such that all timers are at their MAX value. |
| Max Saving                   | Pre-defined timer values are used such that all timers are at their MIN value. |

**PM Control by APM**

|                      |  |
|----------------------|--|
| No                   | System BIOS will ignore APM when Power Management is on.             |
| <b>Yes</b> (default) | System BIOS will wait for ROM's prompt before it enters any PM mode. |

**Video Off Method**

|                                 |   |
|---------------------------------|---|
| <b>V/H SYNC+Blank</b> (default) | In addition to the above, BIOS will also turn off the V-SYNC & H-SYNC signals from VGA card to monitor. |
| DPMS supported                  | This function is enabled only for a VGA card supporting DPMS.   |
| Blank Screen                    | The system BIOS will only blank the screen when disabling video.  |

**Video Off After**

The setting are M/A, Standby, Doze, or Suspend. This option is for choosing the setting in which the monitor will turn off.

|                          |  |
|--------------------------|--|
| NA                       | Always turn on.                                      |
| Doze                     | During Doze mode, the monitor will be turned off.    |
| <b>Suspend</b> (default) | During Suspend mode, the monitor will be turned off. |

**MODEM Use IRQ**

This determines the IRQ, which the MODEM can use.

**3** (default)  
**4 / 5 / 7 / 9 / 10 / 11 / NA**

### **Doze Mode / Suspend Mode**

The **Doze Mode**, and **Suspend Mode** fields set the Period of time after which each of these modes activate. At *Max Saving*, these modes activate sequentially (in the given order) after one minute; at *Min Saving* after one hour.

### **HDD Power Down**

By default, this is Disabled, meaning that no matter the mode the rest of the system, the hard drive will remain ready. Otherwise, you have a range of choices from 1 to 15 minutes or Suspend. This means that you can elect to have your hard disk drive be turned off after a selected number of minutes or when the rest of the system goes into a suspend mode.

**Disabled** (default).

### **Soft-Off by PWRBTN**

Pressing the power button for more than 4 seconds forces the system to enter the Soft-Off states when the system has “hung”.

**The Choices:**, **Instant-Off** (default), Delay 4 Sec.

### **PWRON After PW-Fail**

AC Power Supply provides power for whole system. ATX Power Supply "ON" and "OFF" can be controlled by motherboard. It is saved in south bridge chipset CMOS area are 3 sources provide current save this area; Mother board battery (3V), Power Supply (5VSB), Power Supply (3.3V). Before AC power cables not plug in, CMOS use motherboard (3V). After AC power connects in and Power Supply not open, CMOS use 5VSB in this mean time. Later, when we power ON Power Supply, CMOS use 3.3V.

Whit above controlled function CMOS, there CMOS 3 options which we can select from BIOS setup: "Formor-Sts", "On", "Off". "Formor-Sts" means follow last status of CMOS setting when AC power lost; failed "On", "Off". "Formor-Sts" means follow last status of CMOS setting when AC power lost; failed. "On" means always set CMOS in "On" status when AC power lost; failed. "Off" means always set CMOS in "Off" status when AC power lost; failed. For example: BIOS setup to "Formor-Sts". If AC power lost when system in power on "status, then after AC power retrieved, system will automatic power on. If AC power lost when system in "power off" status, then after AC power retrieved, system will still in power off status.

**VGA**

When set to On, any event occurring at a VGA port will awaken a system which has been powered down.

**LPT & COM**

When set to On, any event occurring at a COM(serial)/LPT (printer) port will awaken a system which has been powered down.

**HDD & FDD**

When set to On (default), any event occurring at a hard or floppy drive will awaken a system which has been powered down.

**PCI Master**

When set to On, any event occurring at PCI will awaken a system which has been powered down.

**RTC Alarm Resume**

When Enabled, you can set the date and time at which the RTC (real-time clock) alarm awakens the system from Suspend mode.

**Modem Ring Resume**

When set to Enabled, any event occurring to the Modem Ring will awaken a system which has been powered down,  
**Disabled** (default)

**Primary INTR**

When set to ON (default), any event occurring at Primary INTR will awaken a system which has been powered down.

The following is a list of IRQ, Interrupt ReQuests, which can be exempted much as the COM ports and LPT ports above can. When an I/O device wants to gain the attention of the operating system, it signals this by causing an IRQ to occur. When the operating system is ready to respond to the request, it interrupts itself and performs the service.

As above, the choices are On and OFF. Off is the default.

When set On, activity will neither prevent the system from going into a power management mode nor awaken it.

|              |                |
|--------------|----------------|
| <b>IRQ3</b>  | <b>(COM2)</b>  |
| <b>IRQ4</b>  | <b>(COM1)</b>  |
| <b>IRQ5</b>  | <b>(LPT2)</b>  |
| <b>IRQ6</b>  | <b>(FDD)</b>   |
| <b>IRQ7</b>  | <b>(LPT1)</b>  |
| <b>IRQ8</b>  | <b>(Alarm)</b> |
| <b>IRQ9</b>  | <b>(Rsv)</b>   |
| <b>IRQ10</b> | <b>(Rsv)</b>   |
| <b>IRQ11</b> | <b>(Rsv)</b>   |
| <b>IRQ12</b> | <b>(PS/2)</b>  |
| <b>IRQ13</b> | <b>(CoPro)</b> |
| <b>IRQ14</b> | <b>(HDD)</b>   |
| <b>IRQ15</b> | <b>(Rsv)</b>   |

## 2.6 PNP / PCI Configuration Setup

Figure 6. PNP / PCI Configuration Setup Menu

ROM PCI/ISA BIOS (xxxxxxx)  
 PNP / PCI FUNCTION SETUP  
 AWARD SOFTWARE, INC.

|  |             |                    |           |
|--|-------------|--------------------|-----------|
| PNP OS Installed   | : <b>No</b> | Assign IRQ For USB | : Enabled |
| Resources Controlled By  | : Auto      | Assign IRQ For VGA | : Enabled |
| Reset Configuration Data   | : Disabled  |                    |           |
| ESC : Quit    ↑ ↓ → ← : Select Item<br>F1 : Help    PU/PD/+/- : Modify<br>F5 : Old Values    (Shift) F2 : Color<br>F6 : Load BIOS Defaults<br>F7 : Load Setup Defaults |             |                    |           |

### PNP OS Installed

This item allows you to determine PnP OS is installed or not.

**The Choices:** No (default), Yes.



**Resources Controlled By “Auto” or “Manual”**

By Choosing “Auto” the system BIOS will detect the system resource and automatically assign the relative IRQ and DMA channel for each peripheral.

By Choosing “Manual”, the user will need to assign IRQ & DMA for add-on cards. Be sure that there are no IRQ/DMA and I/O port conflicts.

**Reset Configuration Data**

The system BIOS supports the PnP feature so the system needs to record which resource is assigned and protect resources from conflicts. Every peripheral device has a node which is called ESCD. This node records which resources are assigned to it. The system needs to record and update ESCD to the memory locations. These locations (4K) are reserved at the system BIOS.

If Disabled (default) is chosen, the system’s ESCD will update only when the new configuration varies from the last one.

If Enabled is chosen, the system is forced to update ESCDs and then is automatically set to the “Disabled” mode.

The above settings will be shown on the screen only if “Manual” is chosen for the Resources Controlled By function.

Legacy is the term which signifies that a resource is assigned to the ISA Bus and provides for non PnP ISA add-on cards. PCI / ISA PnP signifies that a resource is assigned to the PCI Bus or provides for ISA PnP add-on cards and peripherals.

**Assign IRQ For USB**

Lets the user choose which IRQ to assign for USB.

**Assign IRQ For VGA**

Lets the user choose which IRQ to assign for the VGA.

## 2.7 Load BIOS Defaults

Chipset defaults indicate the values required by the system for maximum performance.

**Figure 7. Load BIOS Defaults Screen**

ROM PCI/ISA BIOS (xxxxxxx)  
CMOS SETUP UTILITY  
AWARD SOFTWARE, INC.

|   |                                     |
|---|-------------------------------------|
| STANDARD CMOS SETUP                           | CPU SPEED SETTING                   |
| BIOS FEATURES SETUP                           | INTEGRATED PERIPHERALS              |
| CHIPSET FEATURES SETUP                        | SUPERVISOR PASSWORD                 |
| POWER MANAGEMENT SETUP                        | USER PASSWORD                       |
| PCI & PCI C                                   | DETECTION                           |
| <b>LOAD BIOS</b>                              | <b>Load BIOS Defaults (Y/N) ? N</b> |
| LOAD SET                                      | ING                                 |
| Esc : Quit                                    | ↑ ↓ → ← : Select Item               |
| F10 : Save & Exit Setup                       | (Shift) F2 : Change Color           |
| Load BIOS Defaults except Standard CMOS SETUP |                                     |

If you wish to load the BIOS Defaults, change the prompt to <Y> and press <ENTER>.

## 2.8 Load SETUP Defaults

Chipset defaults indicate the values required by the system for maximum performance.

**Figure 8. Load SETUP Defaults Screen**

ROM PCI/ISA BIOS (xxxxxxxx)  
CMOS SETUP UTILITY  
AWARD SOFTWARE, INC.

|   |                           |
|---|---------------------------|
| STANDARD CMOS SETUP   | CPU SPEED SETTING         |
| BIOS FEATURES SETUP   | INTEGRATED PERIPHERALS    |
| CHIPSET FEATURES SETUP  | SUPERVISOR PASSWORD       |
| POWER MANAGEMENT SETUP  | USER PASSWORD             |
| PCI & PCI CO  | DETECTION                 |
| LOAD BIOS D   |                           |
| <b>LOAD SETUP</b>   |                           |
| <div style="border: 1px solid black; background-color: #cccccc; padding: 5px; width: fit-content; margin: 0 auto;"> <b>Load SETUP Defaults (Y/N) ? N</b> </div> |                           |
| Esc : Quit  | ↑ ↓ → ← : Select Item     |
| F10 : Save & Exit Setup   | (Shift) F2 : Change Color |
| Load Setup Defaults except Standard CMOS SETUP  |                           |

If you wish to load the SETUP Defaults, change the prompt to <Y> and press <ENTER>.

## 2.9 CPU Speed Setting

**Figure 9.CPU Speed Setting Menu**

ROM PCI/ISA BIOS (xxxxxxxx)  
CPU SPEED SETTING  
AWARD SOFTWARE, INC.

|  |   |
|--|---|
| Auto Detect DIMM/PCI Clk :Enabled<br>CPU Host Clock (CPU/PCI) :Default |   |
| Current CPUFAN Speed :<br>Vcore :<br>2.5V<br>3.3V<br>5V<br>12V         | ESC : Quit    ↑ ↓ → ← : Select Item<br>F1 : Help      PU/PD/+/- : Modify<br>F5 : Old Values      (Shift) F2 : Color<br>F7 : Load Setup Defaults |

### **Auto Detect DIMM/PCI Clk**

This item allows you to enable/disable auto detect DIMM/PCI Clock.

### **CPU Host Clock (CPU/PCI)**

The item allows you select CPU Host / PCI clock / Spectrum.

### **Current CPUFAN Speed**

Detects CPU Fan1 speed status automatically.

### **Current Vcore, +2.5V, +3.3V, +5.0V, +12.0V**

Detects System Voltage automatically.

## 2.10 Integrated Peripherals Setup

**Figure 10. Integrated Peripherals Setup Menu**

ROM PCI/ISA BIOS (xxxxxxx)  
 INTEGRATED PERIPHERALS  
 AWARD SOFTWARE, INC.

|                        |   |          |                          |                    |               |
|------------------------|---|----------|--------------------------|--------------------|---------------|
| OnChip IDE Channel 0   | : | Enabled  | Onboard Parallel Mode    | :                  | Normal        |
| OnChip IDE Channel 1   | : | Enabled  |                          |                    |               |
| IDE Prefetch Mode      | : | Enabled  |                          |                    |               |
| IDE HDD Block Mode     | : | Enabled  | Onboard Legacy Audio     | :                  | Enabled       |
| Primary Master PIO     | : | Auto     | Sound Blaster            | :                  | Disabled      |
| Primary Slave PIO      | : | Auto     | SB I/O Base Address      | :                  | 220H          |
| Secondary Master PIO   | : | Auto     | SB IRQ Select            | :                  | IRQ5          |
| Secondary Slave PIO    | : | Auto     | SB DMA Select            | :                  | DMA1          |
| Primary Master UDMA    | : | Auto     | MPU-401                  | :                  | Disabled      |
| Primary Slave UDMA     | : | Auto     | MPU-401 I/O Address      | :                  | 330-333H      |
| Secondary Master UDMA  | : | Auto     | Game Port (200-207H)     | :                  | Enabled       |
| Secondary Slave UDMA   | : | Auto     |                          |                    |               |
| Onboard FDD Controller | : | Enabled  |                          |                    |               |
| Onboard Serial Port 1  | : | Auto     |                          |                    |               |
| Onboard Serial Port 2  | : | Auto     |                          |                    |               |
| UART 2 Mode            | : | Standard |                          |                    |               |
| Onboard Parallel Port  | : | 378/IRQ7 |                          |                    |               |
|                        |   |          | ESC : Quit               | ↑ ↓ → ←            | : Select Item |
|                        |   |          | F1 : Help                | PU/PD/+/-          | : Modify      |
|                        |   |          | F5 : Old Values          | (Shift) F2 : Color |               |
|                        |   |          | F7 : Load Setup Defaults |                    |               |

### OnChip IDE Channel 0

This chipset contains a PCI IDE interface with support for two IDE channels. Select Enabled to activate the first and/or second IDE interface. Select Disabled to deactivate an interface, if you install a primary and/or secondary add-in IDE interface.

**OnChip IDE Channel 1**

This chipset contains a PCI IDE interface with support for two IDE channels. Select Enabled to activate the first and/or second IDE interface. Select Disabled to deactivate an interface, if you install a primary and/or secondary add-in IDE interface.

**IDE Prefetch Mode**

The onboard IDE drive interfaces supports IDE perfecting, for faster drive accesses. If you install a primary and/or secondary add-in IDE interfaces, set this field to Disabled if the interface does not support prefetching.

**The choices:** Enabled (default), Disabled.

**Onboard FDD Controller**

**Enabled/Disabled** The system has an on-board Super I/O chip with a FDD controller that supports 2 FDDs for 360K/720K/1.2M/1.44M/2.8M. Choose “Enabled” to use the on-board FDD controller for accessing the FDD. Otherwise choose “Disabled” to use the off-board FDD controllers.

**Onboard Serial Port 1/Port 2**

Select an address and corresponding interrupt for the first and second serial ports.

**The Choices:** (3F8/IRQ4), (2F8/IRQ3), (3E8/IRQ4), (2E8/IRQ3), Auto, Disabled.

**Onboard Parallel Port**

This item allows you to determine access onboard parallel port controller with which I/O address.

**The choices:** 378 / IRQ7 (default), 278/IRQ5, 3BC/IRQ7, Disabled.

**Onboard Parallel Mode**

Select EPP Port type **Normal** (default), EPP, ECP, ECP / EPP.

**Onboard Legacy Audio**

Select an operating mode for the second serial port:

**The choices:** Enabled (default), Disabled.

**Sound Blaster**

Hardware SoundBlaster Pro for Windows DOS box and real-mode DOS legacy compatibility.

**SB I/O Base Address**

Change the SoundBlaster Pro Base I/O Address settings.

**SB IRQ Select**

Change the SoundBlaster Pro interrupt signal.

**SB DMA Select**

Change the SoundBlaster Pro direct memory access setting.

**MPU-401**

Enable or Disable MPU-401 function.

**MPU-401 I/O Address**

Change the SoundBlaster Pro MPU-401 I/O address.

**Game Port (200-207H)**

Change the joystick connect port address.

## 2.11 Supervisor / User Password Setting

Figure 11. Supervisor Password Setting

ROM PCI/ISA BIOS (xxxxxxx)  
CMOS SETUP UTILITY  
AWARD SOFTWARE, INC.

|                                 |                            |
|---------------------------------|----------------------------|
| STANDARD CMOS SETUP             | CPU SPEED SETTING          |
| BIOS FEATURES SETUP             | INTEGRATED PERIPHERALS     |
| CHIPSET FEATURES SETUP          | <b>SUPERVISOR PASSWORD</b> |
| POWER MANAGEMENT SETUP          | USER PASSWORD              |
| PNP / PCI CONFIGURATION         | IDE HDD AUTO DETECTION     |
| LOAD BIOS DEF                   | <b>Enter Password :</b>    |
| LOAD SETUP DEFAULTS             | EXIT WITHOUT SAVING        |
| Esc : Quit    F5 : Menu in BIOS | ↑ ↓ → ← : Select Item      |
| F10 : Save & Exit Setup         | (Shift) F2 : Change Color  |
| Change / Set / Disable Password |                            |

When you select this function, the following message will appear at the center of the screen to assist you in creating a password.



**ENTER PASSWORD**

Type the password, up to eight characters, and press <Enter>. The password you type now will clear any previously entered password from CMOS memory. You will be asked to confirm the password. Type the password again and press <Enter>. You may also press <ESC> to abort the selection and not enter a password. To disable password, just press <Enter> when you are prompted to enter password. A message will confirm that you wish to disable the password. Once the password is disabled, the system will boot and you can enter setup freely.

**PASSWORD DISABLED**

If you select "System" at the Security Option of BIOS Features Setup Menu, you will be prompted for the password every time the system is rebooted or any time you try to enter Setup. If you select "Setup" at Security Option of BIOS Feature Setup Menu, you will be prompted only when you try to enter Setup.

## 2.12 IDE HDD Auto Detection

Automatically configures hard disk parameters. The parameters shown below are only examples.

**Figure 12. Auto Configuration with Optimal Settings Screen**

ROM PCI/ISA BIOS (xxxxxxx)  
CMOS SETUP UTILITY  
AWARD SOFTWARE, INC.

| HARD DISKS   | TYPE | SIZE | CYLS | HEAD    | PRECOMP | LAND   | SECTOR | MODE |
|--|------|------|------|---------|---------|--------|--------|------|
| Primary Master :   |      |      |      |         |         |        |        |      |
| Select Primary Slave Option (N=Skip) N                                     |      |      |      |         |         |        |        |      |
| OPTIONS  | SIZE | CYLS | HEAD | PRECOMP | LANDZ   | SECTOR | MODE   |      |
| 1(Y)   | 0    | 0    | 0    | 0       | 0       | 0      | NORMAL |      |
| Note : Some OSes (SCO-UNIX Before v5.0) must use "NORMAL" for installation |      |      |      |         |         |        |        |      |
| ESC : Skip   |      |      |      |         |         |        |        |      |

When you enter this utility, the screen asks you to select a specific hard disk for Primary Master. If you accept a hard disk detected by the BIOS, you can enter "Y" to confirm and then press <Enter> to check next hard disk. This function allows you to check four hard disks and you may press the <Esc> after the <Enter> to exit this function and go back to the Main Menu.

## 2.13 Save & Exit Setup

Save CMOS value changes to CMOS and exit setup.

**Figure 13. Save & Exit Setup Screen**

ROM PCI/ISA BIOS (xxxxxxx)  
CMOS SETUP UTILITY  
AWARD SOFTWARE, INC.

|                                      |                           |
|--------------------------------------|---------------------------|
| STANDARD CMOS SETUP                  | CPU SPEED SETTING         |
| BIOS FEATURES SETUP                  | INTEGRATED PERIPHERALS    |
| CHIPSET FEATURES SETUP               | SUPERVISOR PASSWORD       |
| POWER MANAGEMENT SETUP               | USER PASSWORD             |
| PNP / PCI CONFIGURATION              | LOAD BIOS DEFAULT SETUP   |
| LOAD BIOS DEFAULT SETUP              | LOAD SETUP DEFAULTS       |
| <b>SAVE to CMOS and EXIT (Y/N)?N</b> |                           |
| Esc : Quit    F5 : Menu in BIOS      | ↑ ↓ → ← : Select Item     |
| F10 : Save & Exit Setup              | (Shift) F2 : Change Color |
| Save Datas to CMOS & Exit SETUP      |                           |

Pressing <N> and <ENTER> will return you to the Main Menu.

Pressing <Y> and <ENTER> will save the system parameters and continue with the booting process.

## 2.14 Exit Without Saving

Abandon all CMOS value changes and exit setup.

**Figure 14. The Save Settings and Exit Screen**

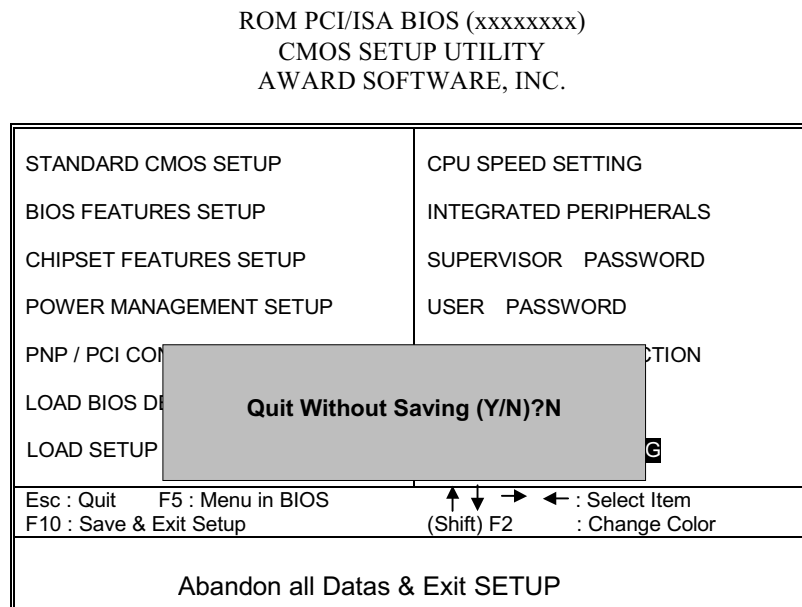

Pressing <N> and <ENTER> will return you to the Main Menu.

Pressing <Y> and <ENTER> will continue with booting process without saving any system parameters.

## 3. Software Setup

NOTE: The mark \* means it can be installed directly from CD by using CD Installation Utility ( i.e. START.EXE).

### 3.1 Software List

| Category                    | Description  | Platform                             | Location in CD  |
|-----------------------------|--|--------------------------------------|-----------------|
| VIA Service Pack (4 In 1)   | VIA 4 In 1 driver includes (VIA Registry (ACPI) Driver /VIA AGP VxD driver /VIA ATAPI Vendor Support Driver /VIA PCI IRQ Miniport Driver) four system drivers to improve the performance and maintain the stability of system using VIA chipset. | Windows 95 / 98 / NT 4.0             | \Mb_drv\Service |
| Trident display drivers     | Install the drivers to enable the Trident Video Device.  | WIN9X/NT4.0<br>WIN2000               | \VGA            |
| VIA Hardware Monitor *      | VIA Hardware Monitor is a self-diagnostic system for PC.   | Windows 95/98                        | \Mb_drv\Sysdiag |
| HighPoint XStore Pro *      | Install the drivers to support Ultra DMA mode Hard Drive.  | Windows 95/98                        | \Mb_drv\XStore  |
| VIA AC97 Audio*             | Install the driver to enable the VIA AC97 Audio Device   | DOS, Windows 95/98/NT4.0/<br>WIN2000 | \Audio\VIA      |
| Aureal Vortex Au8810 Audio* | Install the driver to enable the Aureal Audio device   | WIN9X/NT4.0<br>WIN2000               | \Audio\Aureal   |
| Creative SB PCI128 Audio*   | Install the driver to enable the Creative Audio Device   | WIN9X/NT4.0<br>WIN2000               | \Audio\Creative |
| Award Flash Utility         | Used for updating BIOS.  |                                      | \Flash          |

## 3.2 Software Installation

We provide an installation wizard, Driver CD Installation Utility (START.EXE), located in the root of Driver CD to let users install some common used drivers conveniently.

➤ **The drivers can be installed from CD by using CD Installation Utility:**

You can simply put Driver CD into CD-ROM drive and the Installation Utility will autorun or you can run the Driver CD Installation Utility directly by using mouse cursor to click the proper option on the page. Utility will invoke other applications to complete the rest of installation.

➤ **The drivers CAN NOT be installed directly from CD by using CD Installation Utility:**

Please read the README.TXT located in the root directory on Multimedia CD to get drivers' location and then refer to the INSTALL.TXT or README.TXT files located in each driver directory on the Driver CD to install drivers.

### 3.3 Using Software

- In general, you can get more detailed information in the on-line help or readme for the softwares.
- **Using VIA Hardware Monitor**  
After the utility is installed, you can follow the sequence, **Start** → **Program** → **VIA Hardware Monitor System**, to launch the monitor application.

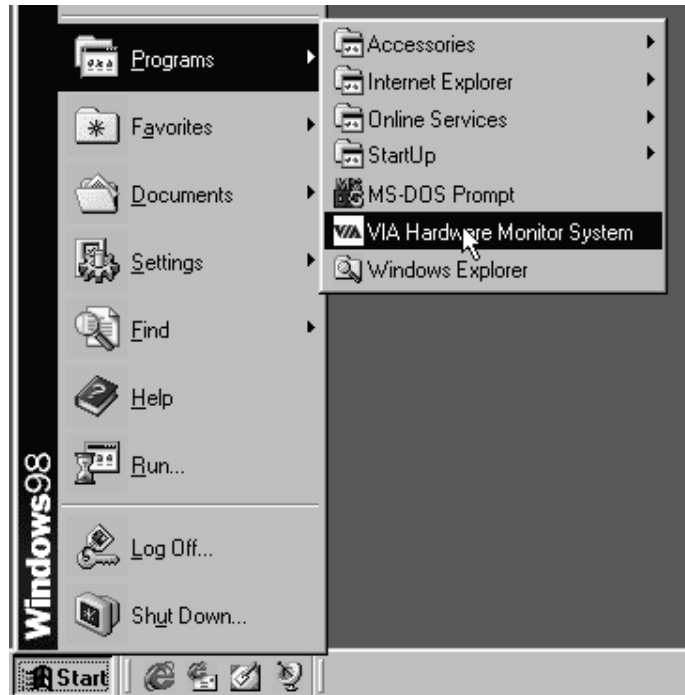

The following figure is the main panel of VIA Hardware Monitor. In the panel, you can get some real-time and important information -- Voltage, Fan speed, and temperature, for example. If there is an abnormal situation, you can resolve it immediately.

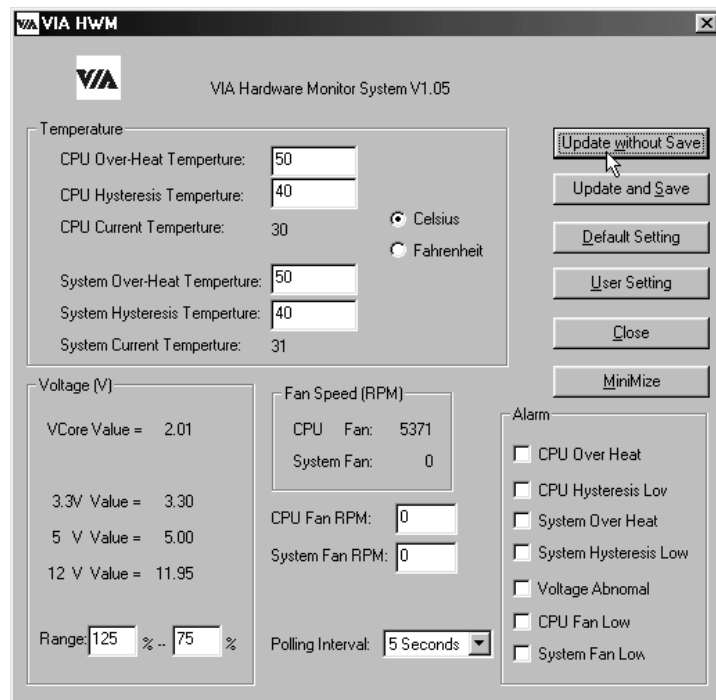



## 4. Trouble Shooting

### PROBLEM

No power to the system at all. Power light does not illuminate, fan inside power supply does not turn on. Indicator light on keyboard does not turn on.

| <b>PROBABLE CAUSE</b>                              | <b>DIAGNOSIS</b>  | <b>SOLUTION</b>   |
|--|---|---|
| Power cable is unplugged.                          | Visually inspect power cable                                  | Make sure power cable is securely plugged in                                |
| Defective power cable.                             | Visual inspection, try another cable.                         | Replace cable.  |
| Power supply failure.                              | Power cable and wall socket are OK, but system is still dead. | Contact technical support.  |
| Faulty wall outlet; circuit Breaker or fuse blown. | Plug in device known to work in socket and test               | Use different socket, repair outlet, reset circuit breaker or replace fuse. |

**PROBLEM**

System inoperative. Keyboard lights are on, power indicator lights are lit, hard drive is spinning.

| <b>PROBABLE CAUSE</b>   | <b>DIAGNOSIS</b>   | <b>SOLUTION</b>  |
|---|--|--|
| Expansion card is partially dislodged from expansion slot on the motherboard. | Turn off computer. Take cover off system unit. Check all expansion cards to ensure they are securely seated in slots.  | Using even pressure on both ends of the expansion card, press down firmly on expansion card. |
| Defective floppy disk drive or tape drive.                                    | Turn system off. Disconnect the cables from one of the floppy drives. Turn on the floppy drives. Turn on the system, check to see if the keyboard operates normally. Repeat until you have located defective unit. | Contact Technical Support.   |
| Defective expansion card.   | Turn computer off. Remove the expansion card.  | Make sure expansion card is secure in expansion socket.                                      |

**PROBLEM**

System does not boot from hard disk drive, can be booted from floppy disk drive.

| <b>PROBABLE CAUSE</b>                                    | <b>DIAGNOSIS</b>   | <b>SOLUTION</b>  |
|--|--|--|
| Connector between hard drive and system board unplugged. | When attempting to run the FDISK utility described in the HARD DISK section of this manual you get a message, INVALID DRIVE SPECIFICATION. | Check cable running from disk to disk controller board. Make sure both ends are securely plugged in; check the drive type in the Standard CMOS Setup (see HARD DISK section of this manual). |
| Damaged Hard Disk or Disk Controller.                    | Format hard disk; if unable to do so the hard disk may be defective.   | Contact Technical Support.   |
| Hard Disk directory or FAT is scrambled.                 | Run the FDISK program, format the hard drive (see HARD DRIVE section of manual). Copy data that was backed up onto Hard Drive.             | Backing up the hard drive is extremely important. All Hard Disk are capable of breaking down at any time.  |

**PROBLEM**

System only boots from floppy Disk. Hard disk can be read and applications can be used but booting from Hard Disk is impossible.

| <b>PROBABLE CAUSE</b>                      | <b>DIAGNOSIS</b>                         | <b>SOLUTION</b>  |
|--|--|--|
| Hard Disk boot program has been destroyed. | A number of causes could be behind this. | Back up data and applications files. Reformat the Hard Drive as described in the Hard Drive section of this manual. Re-install applications and data using backup disks. |

**PROBLEM**

Error message reading "SECTOR NOT FOUND" or other error messages not allowing certain data to be retrieved.

| <b>PROBABLE CAUSE</b>                    | <b>DIAGNOSIS</b>   | <b>SOLUTION</b>   |
|--|--|---|
| A number of causes could be behind this. | Use a file by file backup instead of an image backup in order to backup the Hard Disk. | Back up any salvageable data. Then low level format, partition, and high level format the hard drive (see Hard Disk section of this manual for instructions). Re-install all saved data when completed. |

**PROBLEM**

Disk formatted on IBM PS/2 will not operate with this system.

| <b>PROBABLE CAUSE</b>                                      | <b>DIAGNOSIS</b>   | <b>SOLUTION</b>  |
|--|--|--|
| The IBM PS/2 uses a different format than other computers. | IBM PS/2 disk format will not work in an AT type computer. | Format disk in the AT type computer insert disk into the IBM PS/2 and copy the files you wish. |

**PROBLEM**

After installing an expansion card (network card, tape drive card, etc.) the system no longer works properly.

| <b>PROBABLE CAUSE</b> | <b>DIAGNOSIS</b>  | <b>SOLUTION</b>   |
|-----------------------|---|---|
| No power to monitor.  | All or part of the system may be inoperable. The new card may work but a mouse or COM port may not work | Change the interrupt or RAM address on the new expansion card. See the documentation that came with the new card in order to change pin settings. Many expansion devices come with proprietary software that will assist you in doing this. |

**PROBLEM**

Screen message says "Invalid Configuration" or "CMOS Failure."

| <b>PROBABLE CAUSE</b>   | <b>DIAGNOSIS</b>  | <b>SOLUTION</b>  |
|---|---|--|
| Incorrect information entered into the configuration (setup) program. | Check the configuration program. Replace any incorrect information. | Review system's equipment . Make sure correct information is in setup. |

**PROBLEM**

Screen is blank.

| <b>PROBABLE CAUSE</b>              | <b>DIAGNOSIS</b> | <b>SOLUTION</b>   |
|------------------------------------|------------------|---|
| No power to monitor.               |                  | Check the power connectors to monitor and to system. Make sure monitor is connected to display card, change I/O address on network card if applicable |
| Monitor not connected to computer. |                  | See instructions above.   |
| Network card I/O address conflict. |                  | See instructions above.   |

**PROBLEM**

| <b>PROBABLE CAUSE</b>                                   | <b>DIAGNOSIS</b> | <b>SOLUTION</b>  |
|---|------------------|--|
| Memory problem, display card jumpers not set correctly. |                  | Reboot computer. Reinstall memory, make sure that all memory modules are installed in correct sockets. Check jumper and switch settings on display card. See display card section for information on settings. |
| Computer virus.   |                  | Use anti-virus programs (McAfee, E-Prot, etc) to detect and clean viruses.   |

**PROBLEM**

Screen goes blank periodically.

| <b>PROBABLE CAUSE</b>    | <b>DIAGNOSIS</b> | <b>SOLUTION</b>       |
|--------------------------|------------------|-----------------------|
| Screen saver is enabled. |                  | Disable screen saver. |

**PROBLEM**

Keyboard failure.

| <b>PROBABLE CAUSE</b>     | <b>DIAGNOSIS</b> | <b>SOLUTION</b>  |
|---------------------------|------------------|--|
| Keyboard is disconnected. |                  | Reconnect keyboard.<br>Check keys again, if no improvement replace keyboard. |

**PROBLEM**

No color on screen.

| <b>PROBABLE CAUSE</b>    | <b>DIAGNOSIS</b> | <b>SOLUTION</b>  |
|--------------------------|------------------|--|
| Faulty Monitor.          |                  | If possible, connect monitor to another system. If no color replace monitor. |
| CMOS incorrectly set up. |                  | Call technical support.  |

**PROBLEM**

Floppy drive light stays on.

| <b>PROBABLE CAUSE</b>                       | <b>DIAGNOSIS</b> | <b>SOLUTION</b>  |
|---|------------------|--|
| Floppy Drive cable not connected correctly. |                  | Reconnect floppy cable making sure PIN1 on the Floppy Drive corresponds with PIN1 on Floppy cable connector. |

**PROBLEM**

Error reading drive A:

| <b>PROBABLE CAUSE</b>     | <b>DIAGNOSIS</b> | <b>SOLUTION</b>                                      |
|---------------------------|------------------|--|
| Bad floppy disk.          |                  | Try new floppy disk                                  |
| Floppy disk not formatted |                  | Format floppy disk (type<br>FORMAT A:type<br>ENTER)> |

**PROBLEM**

C: drive failure.

| <b>PROBABLE CAUSE</b>                            | <b>DIAGNOSIS</b> | <b>SOLUTION</b>   |
|--|------------------|---|
| SETUP program does not have correct information. |                  | Boot from drive A: using DOS system disk. Input correct information to SETUP program. |
| Hard Drive cable not connected properly.         |                  | Check Hard Drive cable.   |

**PROBLEM**

Cannot boot system after installing second hard drive.

| <b>PROBABLE CAUSE</b>                                 | <b>DIAGNOSIS</b> | <b>SOLUTION</b>   |
|---|------------------|---|
| Master/Slave jumpers not set correctly.               |                  | Set Master/Slave jumpers correctly.   |
| Hard Drives not compatible / different manufacturers. |                  | Run SETUP program and select correct drive types. Call Drive manufacturers for compatibility with other drives. |



**PROBLEM**

Missing operating system on hard drive.

| <b>PROBABLE CAUSE</b>        | <b>DIAGNOSIS</b> | <b>SOLUTION</b>                          |
|------------------------------|------------------|--|
| CMOS setup has been changed. |                  | Run setup and select correct drive type. |

**PROBLEM**

Certain keys do not function.

| <b>PROBABLE CAUSE</b>     | <b>DIAGNOSIS</b> | <b>SOLUTION</b>   |
|---------------------------|------------------|-------------------|
| Keys jammed or defective. |                  | Replace keyboard. |

**PROBLEM**

Keyboard is locked, no keys function.

| <b>PROBABLE CAUSE</b> | <b>DIAGNOSIS</b> | <b>SOLUTION</b> |
|-----------------------|------------------|-----------------|
| Keyboard is locked.   |                  | Unlock keyboard |

05/26/2000  
MADE IN TAIWAN  
R.O.C.