

---

## **Federal Communications Commission (F.C.C) Statement**

This device complies with Part 15 of the FCC Rules. Operation of this device is subject to the following two conditions: (1) this device may not cause harmful interference, and (2) this device must accept any interference received, including interference that may cause undesired operation.

Accessories: This device has been tested and found to comply with the limits of a Class B digital device, the accessories associated with this equipment are as follows:

1. Shielded serial cable. (Can be obtained from multiple retail outlets)
2. Shielded printer cable. (Can be obtained from multiple retail outlets)
3. Shielded video cable. (Can be obtained from multiple retail outlets)
4. Shielded power cord. (Provided by manufacturer)

These accessories are required to be used in order to ensure compliance with FCC Rules. It is the responsibility of the user to provide and use these accessories properly.

This equipment has been tested and found to comply with the limits of a Class B digital device, pursuant to Part 15 of the FCC Rules. These limits are designed to provide reasonable protection against harmful interference in a residential installation. This equipment generates, uses and can radiate radio frequency energy and, if not installed and used in accordance with the instructions, may cause harmful interference to radio communications. However, there is no guarantee that interference will not occur in a particular installation. If this equipment does cause harmful interference to radio or television reception, which can be determined by turning the equipment off and on, the user is encouraged to try to correct the interference by one or more of the following measures:

1. Reorient / Relocate the receiving antenna.
  2. Increase the separation between the equipment and receiver.
  3. Connect the equipment into an outlet on a circuit different from that to which the receiver is connected.
-

---

4. Consult the dealer or an experienced radio/TV technician for help.

Caution: Changes or modifications not expressly approved by the manufacturer could void the user's authority to operate the equipment.

## **Disclaimer**

The Vendor makes no representations or warranties with respect to the contents here of and specially disclaims any implied warranties of merchantability or fitness for any purpose. Further the Vendor reserves the right to revise this publication and to make changes from time to time in the contents here of without obligation to notify any party beforehand. Duplication of this publication, in part or in whole, is not allowed without first obtaining the Vendor's approval in writing.

## **Trademarks and Remarks**

MS-DOS, Windows, Windows NT, and Windows 9x are products of Microsoft Corp, with its ownership of trademark, and are distributed by the Vendor under a license agreement.

All trademarks used in this manual are the property of their respective owners.

Copyright(C) 1992  
All Rights Reserved

## **Canadian D.O.C. Statement**

This digital apparatus does not exceed the Class B limits for radio noise emissions from digital apparatus as set out in the radio interference regulations of the Canadian Department of Communications.

Cet appareil numérique n'émet pas de bruits radioélectriques dépassant les limites appliqués aux appareils numériques de Class B prescrits dans le règlement du brouillage radioélectrique édicté par le ministère Des Communications du Canada.

---

## **Contents**

---

<b>Introduction .....</b>	<b>1-1</b>
<b>1 Motherboard Description .....</b>	<b>1-2</b>
1.1 Features .....	1-2
1.1.1 Hardware .....	1-2
1.1.2 Software .....	1-8
1.1.3 Attachments .....	1-8
1.2 Motherboard Installation .....	1-9
1.2.1 Layout of Motherboard .....	1-9
1.3 Motherboard Connectors .....	1-10
1.3.1 Front Panel Connectors (J8) .....	1-11
1.3.2 PC Speaker (J7) .....	1-12
1.3.3 ATX 20-pin Power Connector (ATXCON) .....	1-14
1.3.4 Hard Disk Connectors (IDE1/ IDE2) .....	1-15
1.3.5 Floppy Disk Connector (FDD1) .....	1-15
1.4 Back Panel Connectors .....	1-16
1.4.1 PS/2 Mouse / Keyboard Connector (KBMS1) .....	1-16
1.4.2 USB Connector (USB) .....	1-17
1.5 Serial and Parallel Interface Ports .....	1-18
1.6 CPU Installation /Jumper Setting .....	1-23
1.6.1 CPU Installation Procedure .....	1-23
1.6.2 CPU Voltage Selection (JP3/JP1) .....	1-24
1.6.3 CPU / SDRAM and PCI Frequency Selection (JP4) .....	1-27

## **Contents**

---

1.6.4 CPU CORE /BUS Frequency RATIO Selection (JP2/JP4).....	1-28
1.7 Jumper Settings .....	1-34
1.7.1 Wake-On-LAN Header (J4) .....	1-34
1.7.2 Ring-in by MODEM Card Connector (J9) .....	1-35
1.7.3 Telephony Connector (J10).....	1-35
1.7.4 VGA Function Selection (JP5).....	1-35
1.7.5 CMOS Function Selection (JP7) .....	1-36
1.8 DRAM Installation.....	1-37
1.8.1 DIMM .....	1-37
1.8.2 How to install a DIMM Module.....	1-39
1.9 Audio Subsystem.....	1-40
1.9.1 CD Audio-In Connectors (J2/J3).....	1-41
<b>2. AWARD BIOS Setup .....</b>	<b>2-1</b>
2.1 Main Menu.....	2-3
2.2 Standard CMOS Setup Menu.....	2-5
2.3 BIOS Features Setup .....	2-9
2.4 Chipset Features Setup.....	2-14
2.5 Power Management Setup.....	2-16
2.6 PNP / PCI Configuration Setup.....	2-20
2.7 Load SETUP Defaults.....	2-22
2.8 CPU FEATURES & MISCELLANEOUS.....	2-23
2.9 Integrated Peripherals Setup .....	2-24
2.10 Password Setting .....	2-29

## **Contents**

---

2.11 IDE HDD Auto Detection.....	2-31
2.12 Save & Exit Setup.....	2-32
2.13 Exit Without Saving.....	2-33
<b>3. Driver Setup.....</b>	<b>3-1</b>
3.1 ESS Solo-1 (on-board) Software.....	3-1
3.1.1 Software List.....	3-1
3.1.2 Software Installation.....	3-2
3.1.3 Using Software.....	3-2
3.2 Motherboard Software.....	3-3
3.2.1 Software List.....	3-3
3.2.2 Software Installation.....	3-4
3.2.3 Using Software.....	3-5
<b>4. Trouble Shooting.....</b>	<b>4-1</b>

## Introduction

### System Overview

Thanks for buying this product! This manual was written to help you start using this product as quickly and smoothly as possible. Inside you will find adequate explanations to solve most problems. In order for this reference material to be of greatest use, refer to the “expanded table of contents” to find relevant topics.

This board incorporates the system board, ISA I/O, and PCI IDE and AGP VGA into one board that provides a total PC solution. The motherboard, a Pentium™ processor based PC/Micro ATX system, supports a 512KB/1024KB cache with ISA Bus, AGP Bus and PCI Local Bus to support upgrades to your system performance. It is ideal for multi-tasking and fully supports MS-DOS, Windows, Windows NT, Novell, OS/2, Windows9x, UNIX, SCO UNIX etc. This manual also explains how to install the motherboard for operation, and how to setup your CMOS configuration with the BIOS setup program.

# 1 Motherboard Description

## 1.1 Features

### 1.1.1 Hardware

#### CPU

- Supported CPUs: Pentium™ microprocessor P54C/ CT/ CS/ CQS, MMX™; Cyrix6x86™/ 6x86L™/ 6x86MX™/ MII microprocessor; Idt-win™ 2A/3 microprocessor, Rise™ -MP6 microprocessor; AMDK5™/ AMDK6™/ K6-2™/ K6-3™ microprocessor.
- Provides 321-pin ZIF socket (Socket 7).

#### Green Function

- Supports power management operation via BIOS.
- Power down timer from 10 Sec to 4 Hours.
- Wakes up by any key/press or mouse activity.
- Wake on LAN supported.
- Ring-in resume on internal / external modem supported.
- Power-on by keyboard or PS/2 mouse
- ACPI supported

#### Speed

- Supports CPU bus clock 66/75/83/90/95/100 MHz.
- Supports 33/30/33/32/33 MHz PCI Bus speed.
- I/O clock 8 MHz for ISA Bus.

#### Shadow RAM

- A memory controller that provides shadow RAM and supports 8-bit ROM BIOS.

#### Platform

- Micro ATX Form Factor.

#### DRAM Memory

- Supports SDRAM 168-pin DIMM module sockets.
- Supports DRAM memory 8MB to 768MB onboard.

- Supports Symmetrical and Asymmetrical DRAM.
- Supports 3 banks DIMM, 3.3V Unbuffered Synchronous DRAM.

**Cache Memory**

- Supports Pipelined Burst SRAM up to 1024KB.

**BUS Slots**

- Provides one 16-bit ISA Bus slots.
- Three 32-bit PCI Bus master slots.
- PCI V2.2 compliant.

**Flash Memory**

- Supports PnP functionality for better system compatibility.
- Allows you to easily upgrade system BIOS .

**PCI Enhanced IDE Built-in onboard**

- Supports 4 IDE hard disk drives.
- Supports Mode 4, Bus Master Mode, high performance hard disk drives.
- Supports Ultra DMA33/66, Bus Master Mode.
- Supports IDE interface with CD-ROM.
- Supports high capacity hard disk drives.
- Supports LBA Mode.
- Supports booting from LS-120 “SuperDisk” or Iomega ZIP 100MB disk.

**ISA I/O Built-in onboard**

- Supports one multi-mode Parallel Port:
  - (1) Standard & Bidirection Parallel Port (SPP).
  - (2) Enhanced Parallel Port (EPP).
  - (3) Extended Capabilities Port (ECP).
- Supports two serial ports, 16550 UART with 16 byte FIFO.
- UART data rates up to 1.5 Mbaud.
- Supports one Infrared transmission (IR) port.
- Supports PS/2 Mouse.
- Supports 360KB, 720KB, 1.2MB, 1.44MB and 2.88MB floppy disk drives.



**Integrated High Performance & High Quality 3D Graphics/Video Accelerators*****High Performance & High Quality 3D Accelerator***

- Integrated a high performance 3D engine.
- Integrated 32-bit floating point format VLIW triangle setup engine.
- Integrated 16Kbit texture cache.
- Supports Super-AGP for texture fetch.
- Peak polygon rate: 800K polygon/sec @ 50 pixel/polygon with gouraud shaded, point-sampled, linear and bilinear texture mapping.
- Peak fill rate: 40M pixel/sec.
- Integrated a high quality 3D engine.
- Supports solid, flat, and Gouraud shading.
- Supports high quality dithering.
- Supports Z-test, Alpha-test, and scissors clipping test.
- Supports line pattern, and ROP.
- Supports Z-buffer and Alpha buffer.
- Supports per-pixel texture perspective correction.
- Supports point-sampled, linear, bi-linear, and tri-linear texture filtering.
- Supports MIP structure texture.
- Supports rectangle structure texture.
- Supports 1/2/4 BPP palletize texture.
- Supports 1/2/4/8 BPP luminance texture.
- Supports 4/8 BPP mix mode texture format.
- Supports 8/16/24/32 BPP RGB/ARGB texture format.
- Supports video texture in all supported texture formats.
- The supported video formats are RGB555, RGB565, and YUV422 formats.
- Supports texture transparency, blending, wrapping, mirror, and clamping.
- Supports fogging, alpha blending, and primitive transparency.

***High Performance 2D Accelerator***

- Integrated 42 double-words hardware command queue.

- Supports Turbo Queue (Software Command Queue in off-screen memory) architecture to achieve extra-high performance.
- Integrated direct Draw Accelerator.
- Integrated 1T 64-bit BITBLT graphics engine with the following functions:
  - 256 raster operations
  - Rectangle fill.
  - Color expansion
  - Enhanced Color expansion
  - Multiple Scan-line
  - Poly-Line-drawing with styled pattern
  - Integrated 8x8 pattern registers
  - Integrated 8x8 mask registers
  - Rectangle Clipping
  - Transparent BitBit
  - Trapezoid Fill
- Supports memory-mapped, zero wait-state, burst engine write.
- Supports burst frame buffer read/write for SDRAM.
- Integrated 64x64x2 bit-mapped hardware cursor.
- Integrated 4-stage engine write-buffer and 9x64 bits read-buffer to minimize engine wait-state.
- Integrated 64x32 CRT FIFO's to support super high resolution graphics modes and reduce CPU wait-state.

***Video Accelerator***

- Supports single frame buffer architecture.
- Supports YUV-to-RGB color space conversion.
- Supports bi-linear video interpolation with integer increments of 1/64.
- Supports graphics and video overlay function.
- Independent graphics and video formats.
- 16 color-key and/or chroma-key operation.
- 3-bit graphics and video blending.
- Supports current scan line of refresh read-back.
- Supports tearing free double buffer swapping.
- Supports RGB55, RGB565, YUV422, and YUV420 video format.
- Integrated two 96x64 video playback line buffers.
- Supports DCI Drivers.
- Supports direct Draw Drivers.

***DVD H/W Accelerator***

- Supports Color space Conversion.
- Supports Video Scaling.
- Supports YUV12 Format.

***Display Memory Interface*****Supports Local frame Buffer (Optional) :**

- Supports SDRAM timing.
- Supports 8MB memory configuration
- Supports 1Mx16, SDRAM types up to 100MHz .

**Supports Shared Frame Buffer (Optional):**

- Supports SDRAM timing.
- Supports 64 bit memory data bus interface.
- Supports porogrammable 2MB, 4MB, 8MB memory configuration.

***High Integration***

- Integrated programmable 24-bit true-color RAMDAC up to 230 MHz pixel clock.
- Integrated reference voltage generator and monitor sense circuit.supports loadable RAMDAC for gamma correction in high color and true color modes.
- Integrated two 96x64 video line buffers for MPEG video playback.
- Integrated PCI multimedia interface.

***Resolution, Color & Frame Rate***

- Supports 230 MHz pixel clock.
- Supports super high resolution graphics modes.
- 640x480 4/8/16/32 bpp @85Hz NI.
- 800x600 8/16/32 bpp @85Hz NI.
- 1024x768 8/16/32 bpp @85Hz NI.
- 1280x1024 8/16/32 bpp @85Hz NI (32-bpp mode for local frame buffer only).
- 1600x1200 8/16 bpp @256 colors 85Hz NI (16-bpp mode for local frame buffer only).
- Supports virtual screen up to 2048x2048.
- Supports 80/132 columns text modes.

***Power Management***

- Supports VESA Display Power Management Signaling (DPMS) compliant VGA monitor for power management.
- Supports direct I/O command to force graphics controller into standby/suspend/off state.

***Multimedia Application***

- Supports DDC1 and DDC2B specifications.
- Supports RAMDAC snoop for multimedia applications.

**Stereo Sound Chip Built-in Onboard**

- ESS™ Solo1™ Sound Chip.
- Full native DOS games compatibility.
- High-Quality ESFM music synthesizer.
- Software Wavetable synthesizer.
- Integrated Spatializer 3D audio effects processor.
- 16-Bit stereo ADC and DAC.
- Full-Duplex operation for simultaneous record and playback.
- Supports:
  - (1) PC games and applications for Sound Blaster™ and Sound Blaster Pro™.
  - (2) Microsoft Windows Sound System, PC 97™/PC 98™ and WHQL™ specifications.

**Universal Serial Bus**

- Supports two Universal Serial Bus (USB) ports.
- Supports 48MHz USB.
- Supports overcurrent detection.

**Dimension**

- 24.5 cm X 20.9 cm (W x L)

## **1.1.2 Software**

### **BIOS**

- AWARD legal & user-friendly BIOS.
- Supports PnP functions.

### **Operating Systems**

- Offers the highest performance for MS-DOS OS/2, Windows, Windows NT, Windows 95 / 98, Novell, UNIX, SCO UNIT, and others.

## **1.1.3 Attachments**

- HDD Cable
- FDD Cable
- Rear I/O Panel for ATX case
- CD for IDE / VGA / Sound Chip Driver and BIOS flash writer utility
- Cable for Serial Port-II

## 1.2 Motherboard Installation

### 1.2.1 Layout of Motherboard

#### Model No.M5SAA

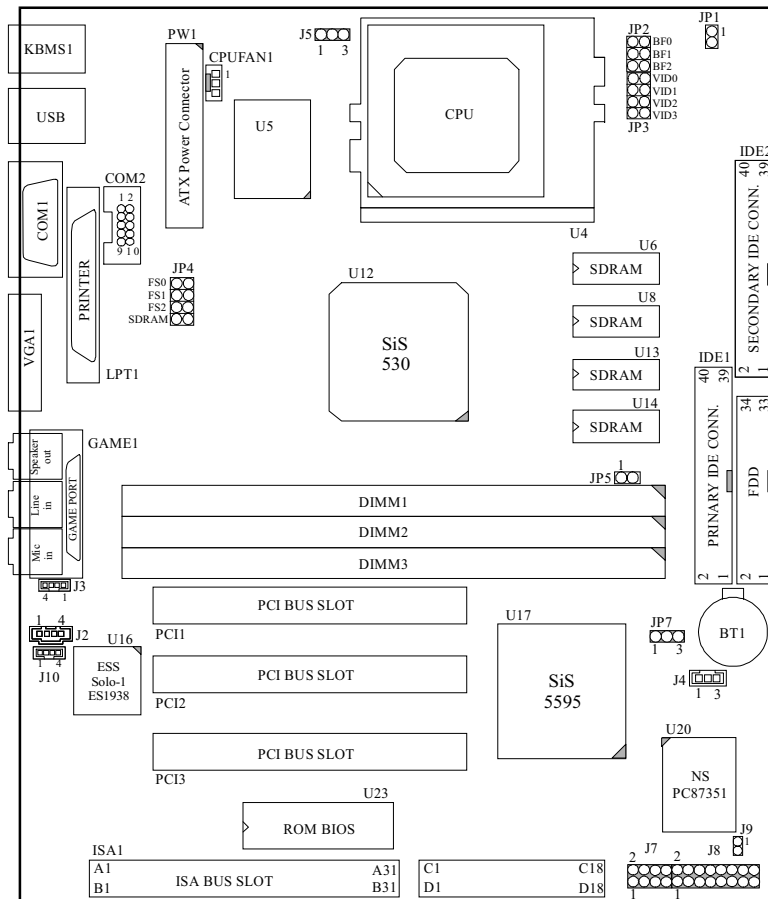

## 1.3 Motherboard Connectors

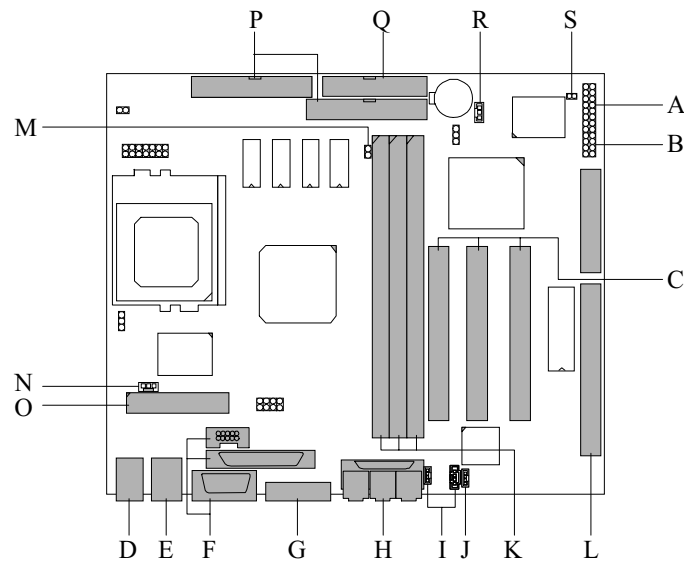

- |   |   |
|---|---|
| <b>A. Front Panel Connectors (J8)</b>             | <b>J. Telephony Connector (J10)</b>         |
| <b>B. PC Speaker (J7)</b>                         | <b>K. DIMMs (DIMM1-3)</b>                   |
| <b>C. PCI Slots (PCI1-PCI3)</b>                   | <b>L. ISA Slots (ISA1)</b>                  |
| <b>D. PS/2 Mouse /Keyboard Connectors (KBMS1)</b> | <b>M. VGA Function Selection (JP5)</b>      |
| <b>E. USB Connectors (USB)</b>                    | <b>N. CPU FAN Connector (CPUFAN1)</b>       |
| <b>F. Serial /Parallel Interface Ports</b>        | <b>O. ATX Power Connector (PW1)</b>         |
| <b>G. VGA Port (VGA1)</b>                         | <b>P. Hard Disk Connectors (IDE1/ IDE2)</b> |
| <b>H. Game Ports (GAME1)</b>                      | <b>Q. Floppy Disk Connector (FDD)</b>       |
| <b>I. CD Audio-In Connector (J2/J3)</b>           | <b>R. Wake-On-LAN Header (J4)</b>           |
|   | <b>S. Ring-in by MODEM Card Conn. (J9)</b>  |

### 1.3.1 Front Panel Connectors (J8)

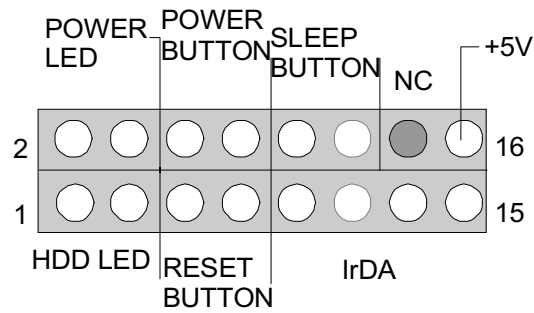

Pin No.	Assignment	Function	Pin No.	Assignment	Function
1	HDD LED (+)	Hard Drive LED	2	Green LED (+)	Power LED
3	HDD LED (-)		4	Yellow LED (+)	
5	Ground	Reset button	6	Power Button	Power Button
7	Reset control		8	Ground	
9	+5V	IrDA Connector	10	Sleep Control	Sleep Button
11	Ir-IN		12	Ground	
13	Ground		14	No Connection	No Connection
15	Ir-out		16	+5V	



### 1.3.2 PC Speaker (J7)

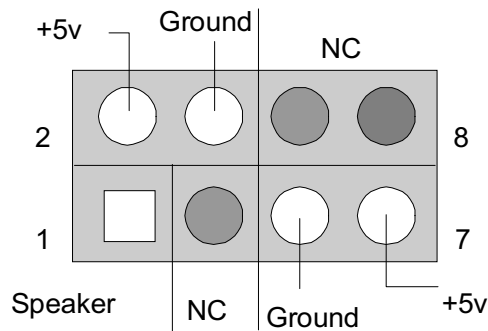

Pin No.	Assignment	Function	Pin No.	Assignment	Function
1	Speaker	PC Speaker Connector	2	+5V	VCC
3	NC		4	Ground	Ground
5	Ground		6	NC	No
7	+5V		8	NC	Connection

#### Speaker Connector

An offboard speaker can be installed on the motherboard as a manufacturing option. An offboard speaker can be connected to the motherboard at the front panel connector. The speaker (onboard or offboard) provides error beep code information during the Power On Self-Test when the computer cannot use the video interface. The speaker is not connected to the audio subsystem and does not receive output from the audio subsystem.

#### Reset Button

This connector can be connected to a momentary SPST type switch that is normally open. When the switch is closed, the motherboard resets and runs the POST.

**Power LED Connector**

This connector can be connected to an LED that will light when the computer is powered on.

**Hard Drive LED Connector**

This connector can be connected to an LED to provide a visual indicator that data is being read from or written to a hard drive. For the LED to function properly, an IDE drive must be connected to the onboard hard drive controller.

**Infrared Connector**

After the IrDA interface is configured, files can be transferred from or to portable devices such as laptops, PDAs, and printers using application software.

**Sleep Button**

When APM is enabled in the system BIOS, and the operating system's APM driver is loaded, the system can enter sleep (standby) mode in one of the following ways:

**Power On Button**

This connector can be connected to a front panel power switch. The switch must pull the Power Button pin to ground for at least 50 ms to signal the power supply to switch on or off. (The time requirement is due to internal debounce circuitry on the motherboard.) At least two seconds must pass before the power supply will recognize another on/off signal.

### 1.3.3 ATX 20-pin Power Connector (ATXCON)

This connector supports the power button on-board. Using the ATX power supply, functions such as Modem Ring Wake-Up and Soft Power Off are supported on this motherboard. This power connector supports instant power-on functionality, which means that the system will boot up instantly when the power connector is inserted on the board.

PIN	VOLTAGE	PIN	VOLTAGE
1	3.3 V	11	3.3 V
2	3.3 V	12	-12 V
3	GND	13	GND
4	5 V	14	PS_ON
5	GND	15	GND
6	5 V	16	GND
7	GND	17	GND
8	PW_OK	18	-5 V
9	5V_SB	19	5 V
10	12 V	20	5 V

*Warning: Since the motherboard has the instant power on function, make sure that all components are installed properly before inserting the power connector to ensure that no damage will be done.*

### **1.3.4 Hard Disk Connectors (IDE1/ IDE2)**

The motherboard has a 32-bit Enhanced PCI IDE Controller that provides PIO Mode 0-4, Bus Master, and Ultra DMA / 66 functionality. It has two HDD connectors IDE1 (primary) and IDE2 (secondary). You can connect up to four hard disk drives, a CD-ROM, a 120MB Floppy (reserved for future BIOS) and other devices to IDE1 and IDE2. These connectors support the IDE hard disk cable provided.

- **IDE1 (Primary IDE Connector)**

The first hard drive should always be connected to IDE1. IDE1 can connect a Master and a Slave drive. You must configure the second hard drive on IDE1 to Slave mode by setting the jumper accordingly.

- **IDE2 (Secondary IDE Connector)**

The IDE2 controller can also support a Master and a Slave drive. The configuration is similar to IDE1. The second drive on this controller must be set to slave mode.

### **1.3.5 Floppy Disk Connector (FDD1)**

The motherboard provides a standard floppy disk connector (FDC) that supports 360K, 720K, 1.2M, 1.44M and 2.88M floppy disk types. This connector supports the provided floppy drive ribbon cables.

## 1.4 Back Panel Connectors

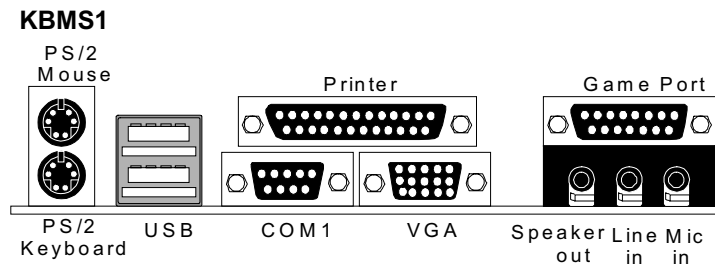

### 1.4.1 PS/2 Mouse / Keyboard Connector (KBMS1)

The motherboard provides a standard PS/2 mouse / Keyboard mini DIN connector for attaching a PS/2 mouse. You can plug a PS/2 mouse / Keyboard directly into this connector. The connector location and pin definition are shown below:

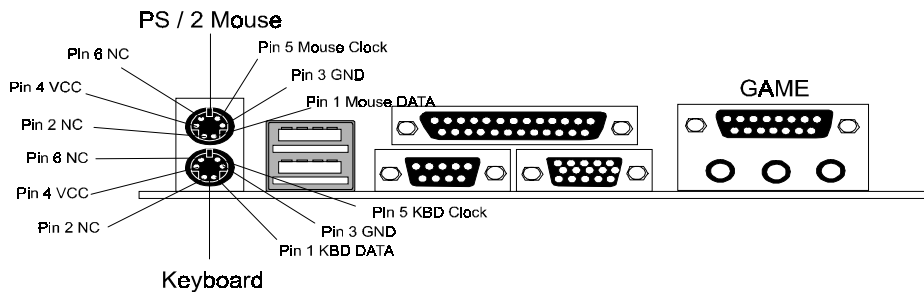

**PS/2 Mouse / Keyboard Connectors**

Pin	Signal Name
1	Data
2	No connect
3	Ground
4	+5 V (fused)
5	Clock
6	No connect

**1.4.2 USB Connector (USB)**

The motherboard provides a **OHCI (Open Host Controller Interface) Universal Serial Bus roots** for attaching USB devices such as: keyboard, mouse and other USB devices. You can plug the USB devices directly into this connector.

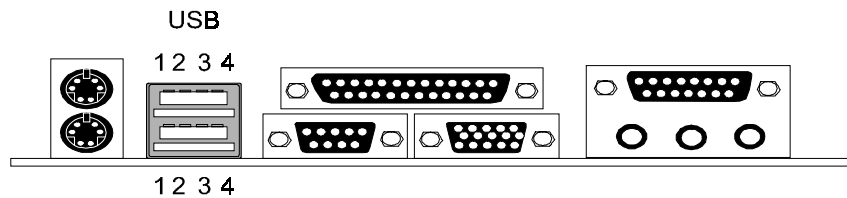
**Stacked USB Connectors**

Pin	Signal Name
1	+5 V (fused)
2	USBP0- [USBP1-]
3	USBP0+ [USBP1+]
4	Ground

Signal names in brackets ([ ]) are for USB port 1.

## 1.5 Serial and Parallel Interface Ports

This system comes equipped with two serial ports and one parallel port. Both types of interface ports will be explained in this chapter.

### The Serial Interface Port-I : COM1

The serial interface port is sometimes referred to as an RS-232 port or an asynchronous communications port. Mice, printers, modems and other peripheral devices can be connected to a serial port. The serial port can also be used to connect your computer with another computer system. If you wish to transfer the contents of your hard disk to another system it can be accomplished by using each machine's serial port.

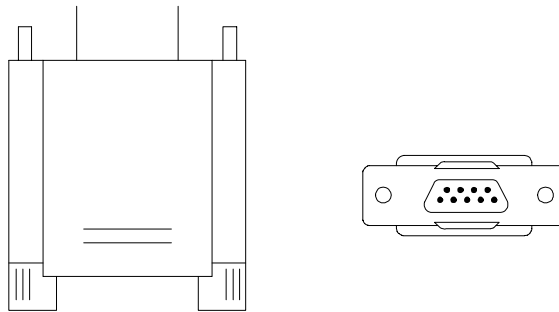

The serial ports on this system have two 9-pin connector. Some older computer systems and peripherals used to be equipped with only one 25-pin connector. Should you need to connect your 9-pin serial port to an older 25-pin serial port, you can purchase a 9-to-25 pin adapter.

**Connectivity**

The serial port can be used many ways, and it may be necessary to become familiar with the pinout diagram. The following chart gives you the function of each pin on the 9-pin connector and some of the 25-pin connector. This information can be used when configuring certain software programs to work with the serial port.

<b>Signal</b>	<b>Name</b>	<b>DB9 PIN</b>	<b>DB25 PIN</b>
DCD	Data Carrier Detect	1	8
RX	Receive Data	2	3
TX	Transmit Data	3	2
DTR	Data Terminal Ready	4	20
GND	Signal Ground	5	7
DSR	Data Set Ready	6	6
RTS	Request to Send	7	4
CTS	Clear to Send	8	5
RI	Ring Indicator	9	22

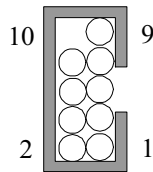

**The Serial Interface Port-II : COM2**

Signal	Name	IDC PIN
DCD	Data Carrier Detect	1
RX	Receive Data	2
TX	Transmit Data	3
DTR	Data Terminal Ready	4
GND	Signal Ground	5
DSR	Data Set Ready	6
RTS	Request to Send	7
CTS	Clear to Send	8
RI	Ring Indicator	9

**Special Applications**

There are two types of serial devices that can be connected to a serial port. One of the devices is called "DTE" (Data Terminal Equipment) and the other device is called "DCE" (Data Communications Equipment). If a modem is connected to a computer, for example, the modem is called the DCE and the computer is called the DTE. In situations such as this, the pins on the serial ports can be connected straight through.

In instances when there are two DTE devices connected together, such as a computer and a printer, a special adapter called a "Null Modem" is needed to make communication between the two devices possible.

When using the serial port to communicate between devices, one problem in particular may arise. Some manufacturers use one set of signals to begin communication with another device and other manufacturers do not use these

signals to initiate communication. If you encounter a communication problem that cannot be resolved using a null modem, it can generally be assumed that one device is using the initialization signals and the other device is not. This can usually be resolved by wiring the RTS, CTS, and DCD pins together.

### **Serial Ports/COM Ports**

The two serial ports on the computer are called COM1 and COM2, respectively. If you wish, two more serial ports can be added onto the computer using optional hardware. Should you choose to add the extra Serial ports (COM ports) they would be called COM3 and COM4.

When using serial ports to communicate with a peripheral device, be sure to assign only one COM port number to each device. For example, if a printer and a scanner are both connected to your computer through serial ports, the printer must be assigned one COM port (i.e. COM1) and the scanner must be assigned the other COM port (i.e. COM2). No two devices can be assigned to one COM port. Each peripheral must have its own COM port.

NOTE: Four serial ports may be installed on the computer. However, no more than two ports can be used simultaneously.

\*If you have installed an internal modem, be careful not to assign a COM port number that has already been assigned to another device. This error is common.

When installing a device that is going to require the use of a serial port, use a diagnostic program to find out which ports are available. It may be necessary to remove expansion cards that have serial ports in order to check their jumper settings. The jumper settings will indicate which COM port the card has been assigned. Checking the expansion card will eliminate mistakes in overlapping COM ports. Once you have completed the installation of peripheral devices using the serial ports, be sure that the communication parameters such as baud rate, parity bit, etc. are matching. If your computer is set for a baud rate of 9600 and your modem is set for a baud rate of 2400 you will not be able to send messages. The manuals that accompany the peripheral devices will inform you on the procedure for setting their parameters. Software manuals also have instructions on setting parameters.

**Parallel Interface Port (LPT1)**

Unlike the serial port, parallel interface ports have been standardized and should not present any difficulty interfacing peripherals to your system. Sometimes called a Centronics port, the parallel port is almost exclusively used with printers. The parallel port on your system has a 25-pin, DB5 connector (see picture below). The pinouts for the parallel port are shown in the table below.

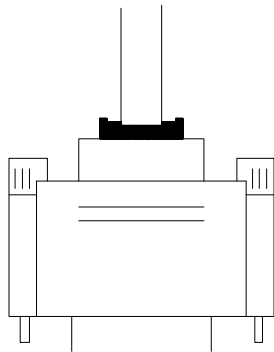
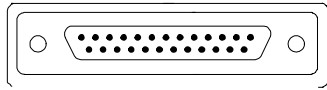

Signal	Pin
-Strobe	1
Data 0	2
Data 1	3
Data 2	4
Data 3	5
Data 4	6
Data 5	7
Data 6	8
Data 7	9
-Ack	10
Busy	11
Paper Empty	12
+Select	13
-Auto FDXT	14
-Error	15
-Init	16
-SLCTN	17
Ground	18
Ground	19
Ground	20
Ground	21
Ground	22
Ground	23
Ground	24
Ground	25

## 1.6 CPU Installation /Jumper Setting

### 1.6.1 CPU Installation Procedure

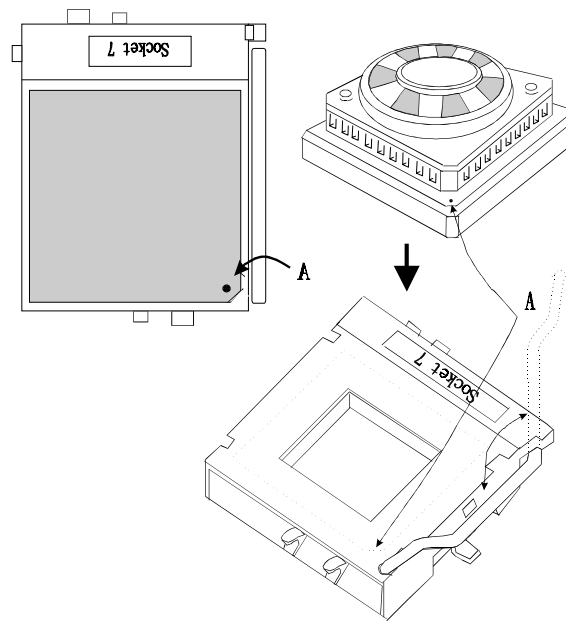

1. Pull the lever sideways away from the socket then raise the lever up to a 90-degree angle.
2. Locate Pin A in the socket and look for the white dot or cut edge in the CPU. Match Pin A with the white dot/cut edge then insert the CPU.
3. Press the lever down to complete the installation.

### 1.6.2 CPU Voltage Selection (JP3/JP1)

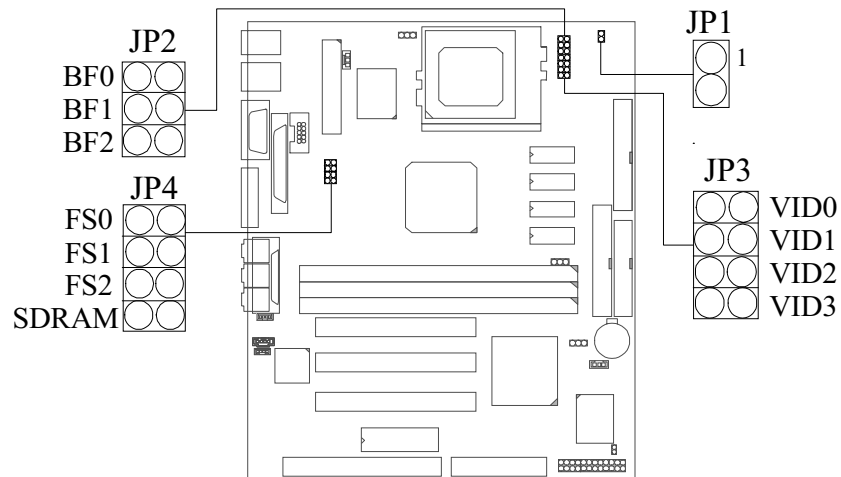

CPU TYPE	CPU Voltage		JP3	JP1
	CORE	I / O		
<b>Single Voltage</b> <b>INTEL™</b> P54C/CQS/CT <b>Cyrix™</b> 6x86 <b>idt-Win™</b> Chip CPU <b>AMD™</b> K5	3.3V	3.3V	VID0 CLOSED VID1 OPEN VID2 CLOSED VID3 CLOSED	CLOSED
<b>Dual Voltage</b> <b>INTEL™</b> P55C/MMX™  <b>Cyrix™</b> 6x86L / 6x86MII  <b>AMD™</b> K6/ K6-2/ K6-3	2.1V	3.3V	VID0 CLOSED VID1 OPEN VID2 OPEN VID3 OPEN	OPEN
	2.2V	3.3V	VID0 OPEN VID1 CLOSED VID2 OPEN VID3 OPEN	OPEN

CPU TYPE	CPU Voltage		JP3	JP1
	CORE	I / O		
<b>Dual Voltage</b> <b>INTEL™</b> P55C/MMX™  <b>Cyrix™</b> 6x86L / 6x86MII  <b>AMD™</b> K6/ K6-2/ K6-3  <b>Rise™</b> -MP6	2.3V	3.3V	VID0 CLOSED VID1 CLOSED VID2 OPEN VID3 OPEN	OPEN
	2.4V	3.3V	VID0 OPEN VID1 OPEN VID2 CLOSED VID3 OPEN	OPEN
	2.5V	3.3V	VID0 CLOSED VID1 OPEN VID2 CLOSED VID3 OPEN	OPEN
	2.6V	3.3V	VID0 OPEN VID1 CLOSED VID2 CLOSED VID3 OPEN	OPEN
	2.7V	3.3V	VID0 CLOSED VID1 CLOSED VID2 CLOSED VID3 OPEN	OPEN
	2.8V	3.3V	VID0 OPEN VID1 OPEN VID2 OPEN VID3 CLOSED	OPEN
	2.9V	3.3V	VID0 CLOSED VID1 OPEN VID2 OPEN VID3 CLOSED	OPEN

CPU TYPE	CPU Voltage		JP3	JP1
	CORE	I / O		
<b>Dual Voltage</b> <b>INTEL</b> ™ P55C/MMX™	3.0V	3.3V	VID0 OPEN VID1 CLOSED VID2 OPEN VID3 CLOSED	OPEN
<b>Cyrix</b> ™ 6x86L / 6x86MII	3.1V	3.3V	VID0 CLOSED VID1 CLOSED VID2 OPEN VID3 CLOSED	OPEN
<b>AMD</b> ™ K6/ K6-2/ K6-3	3.2V	3.3V	VID0 OPEN VID1 OPEN VID2 CLOSED VID3 CLOSED	OPEN
<b>Rise</b> ™ -MP6	3.3V	3.3V	VID0 CLOSED VID1 OPEN VID2 CLOSED VID3 CLOSED	OPEN
	3.4V	3.3V	VID0 OPEN VID1 CLOSED VID2 CLOSED VID3 CLOSED	OPEN
	3.5V	3.3V	VID0 CLOSED VID1 CLOSED VID2 CLOSED VID3 CLOSED	OPEN

\*\* The voltage listed above is for reference. Please verify actual voltage before setting jumper.

### 1.6.3 CPU / SDRAM and PCI Frequency Selection (JP4)

CPU	SDRAM	PCI	FS0	FS1	FS2	SD
90 MHz	90 MHz	30 MHz	Closed	Closed	Closed	Closed
95 MHz	63.3 MHz	31.7 MHz	Closed	Open	Closed	Closed
100 MHz	66.7 MHz	33.3 MHz	Open	Open	Closed	Closed
100 MHz	75 MHz	30 MHz	Closed	Closed	Open	Open
66.7 MHz	66.7 MHz	33.3 MHz	Closed	Closed	Closed	Open
75 MHz	75 MHz	30 MHz	Open	Closed	Closed	Open
83.3 MHz	83.3 MHz	33.3 MHz	Closed	Open	Closed	Open
95 MHz	95 MHz	31.7 MHz	Open	Open	Closed	Open
100 MHz	100 MHz	33.3 MHz	Closed	Closed	Open	Open

**SD of JP4:**

**OPEN:** CPU & SDRAM running at the same clock frequency.

**CLOSE:** SDRAM CPU and SDRAM running at individual clock frequency.



### 1.6.4 CPU CORE /BUS Frequency RATIO Selection (JP2/JP4)

#### (a) INTEL CPU

CPU Speed	Bus Clock & Multiplier	JP2 BF0	JP2 BF1	JP2 BF2	JP4 FS0	JP4 FS1	JP4 FS2	JP4 SD
100MHz	66 x 1.5	OPEN	OPEN	OPEN	CLOSE	CLOSE	CLOSE	OPEN
133MHz	66 x 2	CLOSE	OPEN	OPEN	CLOSE	CLOSE	CLOSE	OPEN
166MHz	66 x 2.5	CLOSE	CLOSE	OPEN	CLOSE	CLOSE	CLOSE	OPEN
200MHz	66 x 3	OPEN	CLOSE	OPEN	CLOSE	CLOSE	CLOSE	OPEN
233MHz	66 x 3.5	OPEN	OPEN	OPEN	CLOSE	CLOSE	CLOSE	OPEN

#### (b) Cyrix 6x86™ / 6x86L™ CPU

CPU Speed	Bus Clock & Multiplier	JP2 BF0	JP2 BF1	JP2 BF2	JP4 FS0	JP4 FS1	JP4 FS2	JP4 SD
PR-166+ 133MHz	66 x 2	CLOSE	OPEN	OPEN	CLOSE	CLOSE	CLOSE	OPEN
PR-200+ 150MHz	75 x 2	CLOSE	OPEN	OPEN	OPEN	CLOSE	CLOSE	OPEN

## (c) Cyrix 6x86MII™ CPU

CPU Speed	Bus Clock & Multiplier	JP2 BF0	JP2 BF1	JP2 BF2	JP4 FS0	JP4 FS1	JP4 FS2	JP4 SD
PR-166+ 133MHz	66 X 2	CLOSE	OPEN	OPEN	CLOSE	CLOSE	CLOSE	OPEN
PR-200+ 150MHz	75 X 2	CLOSE	OPEN	OPEN	OPEN	CLOSE	CLOSE	OPEN
PR-200+ 166MHz	66 X 2.5	CLOSE	CLOSE	OPEN	CLOSE	CLOSE	CLOSE	OPEN
PR-233+ 166MHz	83 X 2	CLOSE	OPEN	OPEN	CLOSE	OPEN	CLOSE	OPEN
PR-233+ 188MHz	75 X 2.5	CLOSE	CLOSE	OPEN	OPEN	CLOSE	CLOSE	OPEN
PR-266+ 200MHz	66 X 3	OPEN	CLOSE	OPEN	CLOSE	CLOSE	CLOSE	OPEN
PR-233+ 200MHz	100 X 2	CLOSE	OPEN	OPEN	CLOSE	CLOSE	OPEN	OPEN
PR-266+ 208MHz	83 X 2.5	CLOSE	CLOSE	OPEN	CLOSE	OPEN	CLOSE	OPEN
PR-300+ 225MHz	75 X 3	OPEN	CLOSE	OPEN	OPEN	CLOSE	CLOSE	OPEN
PR-300+ 225MHz	90 X 2.5	CLOSE	CLOSE	OPEN	CLOSE	CLOSE	CLOSE	CLOSE
PR-300+ 233MHz	66 X 3.5	OPEN	OPEN	OPEN	CLOSE	CLOSE	CLOSE	OPEN
PR-300+ 237MHz	95 X 2.5	CLOSE	CLOSE	OPEN	OPEN	OPEN	CLOSE	OPEN
PR-366+ 250MHz	100 X 2.5	CLOSE	CLOSE	OPEN	CLOSE	CLOSE	OPEN	OPEN
PR-333+ 250MHz	83 X 3	OPEN	CLOSE	OPEN	CLOSE	OPEN	CLOSE	OPEN
PR-333+ 263MHz	75 X 3.5	OPEN	OPEN	OPEN	OPEN	CLOSE	CLOSE	OPEN
PR-333+ 266MHz	66 X 4	CLOSE	OPEN	CLOSE	CLOSE	CLOSE	CLOSE	OPEN

CPU Speed	Bus Clock & Multiplier	JP2 BF0	JP2 BF1	JP2 BF2	JP4 FS0	JP4 FS1	JP4 FS2	JP4 SD
PR-350+ 270MHz	90 X 3	OPEN	CLOSE	OPEN	CLOSE	CLOSE	CLOSE	CLOSE
PR-350+ 285MHz	95 X 3	OPEN	CLOSE	OPEN	OPEN	OPEN	CLOSE	OPEN
PR-366+ 292MHz	83 X 3.5	OPEN	OPEN	OPEN	CLOSE	OPEN	CLOSE	OPEN
PR-366+ 300MHz	75 X 4	CLOSE	OPEN	CLOSE	OPEN	CLOSE	CLOSE	OPEN
PR-380+ 300MHz	100 X 3	OPEN	CLOSE	OPEN	CLOSE	CLOSE	OPEN	OPEN
PR-366+ 315MHz	90 X 3.5	OPEN	OPEN	OPEN	CLOSE	CLOSE	CLOSE	CLOSE
PR-400+ 333MHz	83 X 4	CLOSE	OPEN	CLOSE	CLOSE	OPEN	CLOSE	OPEN
PR-400+ 333MHz	95 X 3.5	OPEN	OPEN	OPEN	OPEN	OPEN	CLOSE	OPEN
PR-433+ 350MHz	100 X 3.5	OPEN	OPEN	OPEN	CLOSE	CLOSE	OPEN	OPEN
PR-433+ 360MHz	90 X 4	CLOSE	OPEN	CLOSE	CLOSE	CLOSE	CLOSE	CLOSE
PR-450+ 380MHz	95 X 4	CLOSE	OPEN	CLOSE	OPEN	OPEN	CLOSE	OPEN
PR-466+ 400MHz	100 X 4	CLOSE	OPEN	CLOSE	CLOSE	CLOSE	OPEN	OPEN

**(d) AMD-K5™ CPU**

CPU Speed	JP2 BF0	JP2 BF1	JP2 BF2	JP4 FS0	JP4 FS1	JP4 FS2	JP4 SD
PR-133	CLOSE	OPEN	OPEN	CLOSE	CLOSE	CLOSE	OPEN
PR-166	CLOSE	CLOSE	OPEN	CLOSE	CLOSE	CLOSE	OPEN
PR-200	OPEN	CLOSE	OPEN	CLOSE	CLOSE	CLOSE	OPEN

**(e) AMD-K6™ CPU**

CPU Speed	Bus Clock & Multiplier	JP2 BF0	JP2 BF1	JP2 BF2	JP4 FS0	JP4 FS1	JP4 FS2	JP4 SD
166MHz	66 x 2.5	CLOSE	CLOSE	OPEN	CLOSE	CLOSE	CLOSE	OPEN
200MHz	66 x 3	OPEN	CLOSE	OPEN	CLOSE	CLOSE	CLOSE	OPEN
233MHz	66 x 3.5	OPEN	OPEN	OPEN	CLOSE	CLOSE	CLOSE	OPEN
266MHz	66 x 4	CLOSE	OPEN	CLOSE	CLOSE	CLOSE	CLOSE	OPEN
300MHz	66 x 4.5	CLOSE	CLOSE	CLOSE	CLOSE	CLOSE	CLOSE	OPEN

**(f) AMD-K6-2 and K6-3 CPU**

CPU Speed	Bus clock & Multiplier	JP2 BF0	JP2 BF1	JP2 BF2	JP4 FS0	JP4 FS1	JP4 FS2	JP4 SD
266MHz	66 x 4	CLOSE	OPEN	CLOSE	CLOSE	CLOSE	CLOSE	OPEN
300MHz	66 x 4.5	CLOSE	CLOSE	CLOSE	CLOSE	CLOSE	CLOSE	OPEN
300MHz	100 x 3	OPEN	CLOSE	OPEN	CLOSE	CLOSE	OPEN	OPEN
333MHz	66 x 5	OPEN	CLOSE	CLOSE	CLOSE	CLOSE	CLOSE	OPEN
333MHz	95 x 3.5	OPEN	OPEN	OPEN	OPEN	OPEN	CLOSE	OPEN
350MHz	100 x 3.5	OPEN	OPEN	OPEN	CLOSE	CLOSE	OPEN	OPEN
366MHz	66 x 5.5	OPEN	OPEN	CLOSE	CLOSE	CLOSE	CLOSE	OPEN
380MHz	95 x 4	CLOSE	OPEN	CLOSE	OPEN	OPEN	CLOSE	OPEN
400MHz	100 x 4	CLOSE	OPEN	CLOSE	CLOSE	CLOSE	OPEN	OPEN
450MHz	100 x 4.5	CLOSE	CLOSE	CLOSE	CLOSE	CLOSE	OPEN	OPEN

**(g) Rise™ -MP6 CPU**

CPU Speed	Bus Clock & Multiplier	JP2 BF0	JP2 BF1	JP2 BF2	JP4 FS0	JP4 FS1	JP4 FS2	JP4 SD
166MHz	83 x 2	CLOSE	OPEN	OPEN	CLOSE	OPEN	CLOSE	OPEN
190MHz	95 x 2	CLOSE	OPEN	OPEN	OPEN	OPEN	CLOSE	OPEN
200MHz	100 x 2	CLOSE	OPEN	OPEN	CLOSE	CLOSE	OPEN	OPEN

**(h) Idt-Win™ 2A Chip CPU**

<b>CPU Speed</b>	<b>Bus Clock &amp; Multiplier</b>	<b>JP2 BF0</b>	<b>JP2 BF1</b>	<b>JP2 BF2</b>	<b>JP4 FS0</b>	<b>JP4 FS1</b>	<b>JP4 FS2</b>	<b>JP4 SD</b>
<b>PR-200+ 200MHz</b>	66 x 3	OPEN	CLOSE	OPEN	CLOSE	CLOSE	CLOSE	OPEN
<b>PR-233+ 200MHz</b>	100 x 2	CLOSE	OPEN	OPEN	CLOSE	CLOSE	OPEN	OPEN
<b>PR-233+ 208MHz</b>	83 x 2.5	CLOSE	CLOSE	OPEN	CLOSE	OPEN	CLOSE	OPEN
<b>PR-233+ 233MHz</b>	66 x 3.5	OPEN	OPEN	OPEN	CLOSE	CLOSE	CLOSE	OPEN
<b>PR-266+ 233MHz</b>	100 x 2.33	OPEN	CLOSE	CLOSE	CLOSE	CLOSE	OPEN	OPEN
<b>PR-266+ 250MHz</b>	83 x 3	OPEN	CLOSE	OPEN	CLOSE	OPEN	CLOSE	OPEN
<b>PR-300+ 250MHz</b>	100 x 2.5	CLOSE	CLOSE	OPEN	CLOSE	CLOSE	OPEN	OPEN
<b>PR-266+ 266MHz</b>	66 x 4	CLOSE	OPEN	CLOSE	CLOSE	CLOSE	CLOSE	OPEN
<b>PR-300+ 266MHz</b>	100 x 2.66	OPEN	OPEN	CLOSE	CLOSE	CLOSE	OPEN	OPEN

**(i) Idt-Win™ 3 Chip CPU**

<b>CPU Speed</b>	<b>Bus Clock &amp; Multiplier</b>	<b>JP2 BF0</b>	<b>JP2 BF1</b>	<b>JP2 BF2</b>	<b>JP4 FS0</b>	<b>JP4 FS1</b>	<b>JP4 FS2</b>	<b>JP4 SD</b>
<b>PR-233+ 200MHz</b>	66 x 3	OPEN	CLOSE	OPEN	CLOSE	CLOSE	CLOSE	OPEN
<b>PR-266+ 233MHz</b>	66 x 3.5	OPEN	OPEN	OPEN	CLOSE	CLOSE	CLOSE	OPEN
<b>PR-300+ 233MHz</b>	100 x 2.33	OPEN	CLOSE	CLOSE	CLOSE	CLOSE	OPEN	OPEN
<b>PR-300+ 266MHz</b>	66 x 4	CLOSE	OPEN	CLOSE	CLOSE	CLOSE	CLOSE	OPEN
<b>PR-333+ 266MHz</b>	100 x 2.66	OPEN	OPEN	CLOSE	CLOSE	CLOSE	OPEN	OPEN
<b>PR-350+ 285MHz</b>	95 x 3	OPEN	CLOSE	OPEN	OPEN	OPEN	CLOSE	OPEN
<b>PR-333+ 300MHz</b>	66 x 4.5	CLOSE	CLOSE	CLOSE	CLOSE	CLOSE	CLOSE	OPEN
<b>PR-366+ 300MHz</b>	100 x 3	OPEN	CLOSE	OPEN	CLOSE	CLOSE	OPEN	OPEN
<b>PR-380+ 316MHz</b>	95 x 3.33	CLOSE	OPEN	OPEN	OPEN	OPEN	CLOSE	OPEN
<b>PR-366+ 333MHz</b>	66 x 5	OPEN	CLOSE	CLOSE	CLOSE	CLOSE	CLOSE	OPEN
<b>PR-400+ 333MHz</b>	100 x 3.33	CLOSE	OPEN	OPEN	CLOSE	CLOSE	OPEN	OPEN

## 1.7 Jumper Settings

A jumper is two or more pins which may be covered by a plastic jumper cap, allowing you to select different system options.

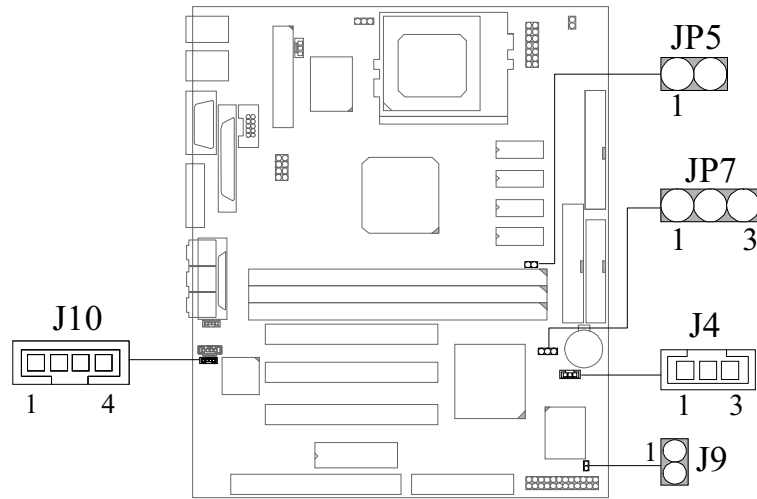

### 1.7.1 Wake-On-LAN Header (J4)

Pin No.	Assignment
1	Standby Voltage + 5V
2	Ground
3	Wakeup Signal Input

### 1.7.2 Ring-in by MODEM Card Connector (J9)

Pin No.	Assignment
1	GND
2	RING

### 1.7.3 Telephony Connector (J10)



Pin No.	TAD
1	MONO_IN
2	GND
3	GND
4	MONO_OUT

### 1.7.4 VGA Function Selection (JP5)

JP5	On Board VGA Function
OPEN	Enable
CLOSE	Disable

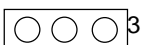

### 1.7.5 CMOS Function Selection (JP7)

JP7	Assignment
 1-2 Closed	Normal Operation (default)
 2-3 Closed	Clear CMOS Data (*Note)
 Open	Onboard Battery Disabled

**Note : Please follow the procedure as below to clear CMOS Data.**

**Note : Please follow the procedure as below to clear BIOS Password if your password is lost or forgotten.**

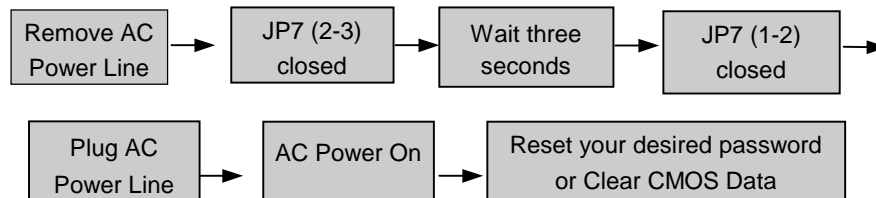

## 1.8 DRAM Installation

### 1.8.1 DIMM

DRAM Access Time : 3.3V Unbuffered SDRAM PC100 Type required.

DRAM Type : 8MB/16MB/32MB/64MB/128MB/256MB DIMM Module (168pin)

Total	Bank 0	Bank 1	Bank 2
Memory Size (MB)	DIMM1	DIMM2	DIMM3
8 M	8M x 1 pc	----	----
16 M	16M x 1 pc	----	----
32 M	32M x 1 pc	----	----
64 M	64M x 1 pc	----	----
128 M	128M x 1 pc	----	----
16 M	8M x 1 pc	8M x 1 pc	----
32 M	16M x 1 pc	16M x 1 pc	----
64 M	32M x 1 pc	32M x 1 pc	----
128 M	64M x 1 pc	64M x 1 pc	----
24 M	8M x 1 pc	8M x 1 pc	8M x 1 pc
40 M	16M x 1 pc	16M x 1 pc	8M x 1 pc
72 M	32M x 1 pc	32M x 1 pc	8M x 1 pc
136 M	64M x 1 pc	64M x 1 pc	8M x 1 pc
32 M	8M x 1 pc	8M x 1 pc	16M x 1 pc
48 M	16M x 1 pc	16M x 1 pc	16M x 1 pc
80 M	32M x 1 pc	32M x 1 pc	16M x 1 pc
144 M	64M x 1 pc	64M x 1 pc	16M x 1 pc
48 M	8M x 1 pc	8M x 1 pc	32M x 1 pc
64 M	16M x 1 pc	16M x 1 pc	32M x 1 pc
96 M	32M x 1 pc	32M x 1 pc	32M x 1 pc
160 M	64M x 1 pc	64M x 1 pc	32M x 1 pc
80 M	8M x 1 pc	8M x 1 pc	64M x 1 pc
96 M	16M x 1 pc	16M x 1 pc	64M x 1 pc
128 M	32M x 1 pc	32M x 1 pc	64M x 1 pc
192 M	64M x 1 pc	64M x 1 pc	64M x 1 pc
384 M	128M x 1 pc	128M x 1 pc	128M x 1 pc
768 M	256M x 1 pc	256M x 1 pc	256M x 1 pc

DRAM must first be installed to Bank0.



\*The list shown above for DRAM configuration is only for reference.

## 1.8.2 How to install a DIMM Module

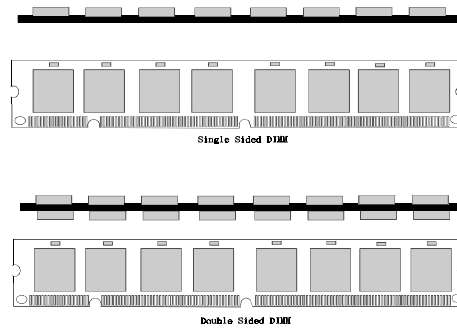

1. The DIMM socket has a “*Plastic Safety Tab*” and the DIMM memory module has an asymmetrical notch”, so the DIMM memory module can only fit into the slot in one direction.

2. Push the tabs out. Insert the DIMM memory modules into the socket at a 90-degree angle then push down vertically. Position so that it will fit into place.

3. The Mounting Holes and plastic tabs should fit over the edge and hold the DIMM memory modules in place.

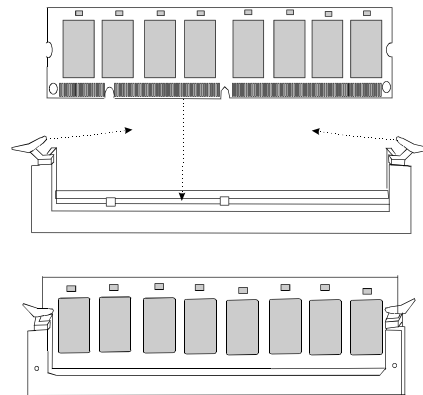

## 1.9 Audio Subsystem

**Chipset:**

- ESS ES1938S Solo-1

**Interface:**

- PCI Interface

**Features**

- Full native DOS games compatibility
- High-Quality ESFM music synthesizer.
- Software Wavetable synthesizer.
- Integrated Spatializer 3D audio effects processor.
- 16-Bit stereo ACD and DAC.
- Full-Duplex operation for simultaneous record and playback.
- Advanced power management meets ACPI standards.
- Supports PC games and applications for Sound Blaster and Sound Blaster Pro, Microsoft Windows Sound System, PC 97/PC 98 and WHQL specifications.
- PCI 2.1 interface support.

### 1.9.1 CD Audio-In Connectors (J2/J3)

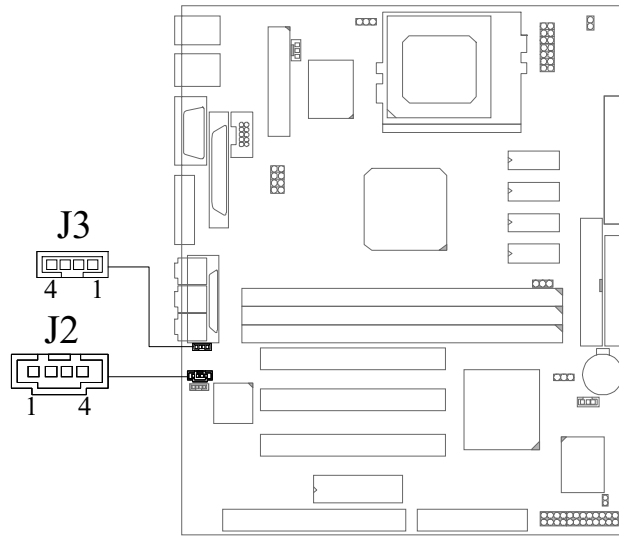

Pin No.of J2	Assignment
1	Left Channel In
2	Ground
3	Ground
4	Right Channel In

Pin No. of J3	Assignment
1	Ground
2	Left Channel
3	Ground
4	Right Channel

## 2. AWARD BIOS Setup

### Entering Setup

Power on the computer and press <Del> immediately allowing you to enter Setup. The other way to enter Setup is to power on the Computer, and when the message below appears briefly at the bottom of the screen during the POST (Power On Self Test), press the <Del> key or simultaneously press the <CTRL>, <Alt>, and <Esc> keys.

### TO ENTER SETUP BEFORE BOOT PRESS CTRL-ALT-ESC OR DEL KEY

If the message disappears before you respond and you still wish to enter Setup, restart the system again by turning it OFF then ON or pressing the "RESET" button on the system case. You may also restart by simultaneously pressing the <CTRL>, <Alt>, and <Delete> keys. If you do not press the keys at the correct time and the system does not boot, an error message will be displayed, and you will again be asked to:

**PRESS F1 TO CONTINUE, CTRL-ALT-ESC OR DEL TO ENTER SETUP**

### Main Menu

The on line description of the highlighted setup function is displayed at the bottom of the screen.

### Status Page Setup Menu/Option Page Setup Menu

Press <F1> to pop up a small help window that describes the appropriate keys to use and the possible selections for the highlighted item. To exit the Help Window Press <Esc>.

### Control Keys

Up arrow	Move to previous item
Down arrow	Move to next item
Left arrow	Move to the item at left
Right arrow	Move to the item at right
Esc key	Main Menu:make a space Quit and do not save changes into CMOS Status Page Setup Menu and Option Page Setup Menu: Exit current page and return to Main Menu
PgUp key	Increase the numeric value or make changes
PgDn key	Decrease the numeric value or make changes
+ key	Increase the numeric value or make changes
- key	Decrease the numeric value or make changes
F1 key	General help, only for Status Page Setup Menu and Option Page Setup Menu
(Shift) F2 key	Change color to one of 16 colors. F2 to select color forward, (Shift) F2 to select color backward
F3 key	Reserved
F4 key	Reserved
F5 key	Restore the previous CMOS value, only for Option Page Setup Menu
F6 key	Load the default CMOS value from BIOS default table, only for Option Page Setup Menu
F7 key	Load the default
F8 key	Reserved
F9 key	Reserved
F10 key	Save all the CMOS changes, only for Main Menu



## 2.1 Main Menu

Once you enter AWARD BIOS CMOS Setup Utility, the Main Menu(**Figure 1**) will appear on the screen. The Main Menu allows you to select an item and press <Enter> to accept or enter its sub-menu.

### ■ Figure 1. Main Menu

ROM PCI/ISA BIOS (xxxxxxxx)  
CMOS SETUP UTILITY  
AWARD SOFTWARE, INC.

<b>STANDARD CMOS SETUP</b>	CPU FEATURES & MISCELLANEOUS
BIOS FEATURES SETUP	INTEGRATED PERIPHERALS
CHIPSET FEATURES SETUP	PASSWORD SETTING
POWER MANAGEMENT SETUP	IDE HDD AUTO DETECTION
PNP / PCI CONFIGURATION	SAVE & EXIT SETUP
LOAD SETUP DEFAULTS	EXIT WITHOUT SAVING
Esc : Quit	↑ ↓ → ← : Select Item
F10 : Save & Exit Setup	(Shift) F2 : Change Color
Time, Date, Hard Disk Type...	

#### Standard CMOS Setup

This setup page includes all the items in a standard compatible BIOS.

#### BIOS Features Setup

This setup page includes all the items for the BIOS special enhanced features.

#### Chipset Features Setup

This setup page includes all the items of chipset special features.

**Power Management Setup**

This setup page includes all the items for power management features.

**PnP / PCI Configuration**

This category specifies the value (in units of PCI bus clocks) of the latency timer for this PCI bus master and the IRQ level for PCI device.

**Load Setup Defaults**

Chipset defaults indicates the values required by the system for maximum performance.

**CPU FEATURES & MISCELLANEOUS**

This setup page includes Hardware monitor.

**Integrated Peripherals**

This setup page includes all the items for Integrated Peripherals features.

**Password Setting**

Change, set, or disable password. It allows you to limit access to the system and Setup, or just to Setup.

**IDE HDD Auto Detection**

Automatically configures hard disk parameters.

**Save & Exit Setup**

Saves CMOS value changes to CMOS and exit setup.

**Exit Without Saving**

Abandons all CMOS value changes and exits setup.

## 2.2 Standard CMOS Setup Menu

The items in the Standard CMOS Setup Menu are divided into categories. Each category includes setup item(s). Use the arrow keys to highlight the item and then use the <PgUp> or <PgDn> keys to select the value you want for each item.

### ■ Figure 2. Standard CMOS Setup Menu

ROM PCI/ISA BIOS (xxxxxxxx)  
STANDARD CMOS SETUP  
AWARD SOFTWARE, INC.

Date (mm:dd:yy) : Wed <b>Jun</b> 20 1999									
Time (hh:mm:ss) : 11 : 37 : 30									
HARD DISKS	TYPE	SIZE	CYLS	HEAD	PRECOMP	LAND	SECTOR	MODE	
Primary Master	: Auto	0	0	0	0	0	0	Auto	
Primary Slave	: Auto	0	0	0	0	0	0	Auto	
Secondary Master	: Auto	0	0	0	0	0	0	Auto	
Secondary Slave	: Auto	0	0	0	0	0	0	Auto	
Drive A	:1.44MB, 3.5 in.								
Drive B	:None								
Video	:EGA/VGA								
Halt On	:All, But Keyboard								
		Base Memory		:		640K			
		Extended Memory		:		191488			
		Other Memory		:		384K			
		Total Memory		:		1925128			
Esc : Quit			↑ ↓ → ← : Select Item			PU/PD/+/-:Modify			
F1 : Help			(Shift) F2 : Change Color						

### Date

The Date format is <day><month><date><year>.

Day	The day, from Sun to Sat, is stored by the BIOS and is display-only
Date	The date, from 1 to 31 (or the maximum allowed in the month)
month	The month, Jan through Dec
year	The year, from 1994 through 2079

**Time**

The time format is <hour><minute><second>. The time is calculated based on the 24-hour military-time clock. For example, 2 p.m. is 14:00:00.

**Hard Disk Type**

This category identifies the type(s) of hard disk(s) that have been installed in the computer. There are 46 predefined types and a user definable type. Type 1 to Type 45 are predefined. Type "User" is user-definable. Type "Auto" is automatically defined by BIOS.

Press <PgUp> or <PgDn> to select a numbered hard disk type or type the number and press <Enter>. Note that the specifications of your drive must match with the drive table. The hard disk will not work properly if you enter improper information for this category. If your hard disk drive type is not listed, you can use Type "User" to define your own drive type manually.

If you select type "User", information is to be entered for the items in the following chart. Enter the information directly from the keyboard and press <Enter>. This information should be provided in the documentation from your hard disk vendor or the system manufacturer.

**Hint:** Most new drives give the parameters on the label on top of the drive.

<b>CYLN</b>	number of cylinders
<b>HEAD</b>	number of heads
<b>WPCOM</b>	write precompensation
<b>SEC</b>	number of sectors
<b>LBA MODE</b>	type of LBA mode
<b>BLK MODE</b>	type of Block mode
<b>PIO MODE</b>	type of PIO
<b>32BIT MODE</b>	type of 32-Bit transfer mode

If a hard disk has not been installed select "NOT Installed" and press <Enter>.

### Drive A Type/Drive B Type

The category identifies the types of floppy disk, drive A or drive B, which has been installed in the computer.

None	No floppy drive installed
360K, 5 1/4	5-1/4 inch PC-type standard drive; 360 kilobyte capacity
1.2M, 5 1/4	5-1/4 inch AT-type high-density drive; 1.2 megabyte capacity
720K, 3 1/2	3-1/2 inch double-sided drive; 720 kilobyte capacity
1.44M, 3 1/2	3-1/2 inch double-sided drive; 1.44 megabyte capacity
2.88M, 3 1/2	3-1/2 inch double-sided drive; 2.88 megabyte capacity

### Video

The category selects the type of adapter used for the primary system monitor, and must match your video display card and monitor. Although secondary monitors are supported, you do not have to select the type in Setup.

<b>EGA/VGA</b>	Enhanced Graphics Adapter/Video Graphics Array. For EGA, VGA, SEGA, or PGA monitor adapters.
<b>CGA 40</b>	Color Graphics Adapter, power up in 40 column mode
<b>CGA 80</b>	Color Graphics Adapter, power up in 80 column mode
<b>MONO</b>	Monochrome adapter, includes high resolution monochrome adapters

### Halt On

The category determines whether the computer will stop if an error is detected during power up.

No errors	Whenever the BIOS detects a non-fatal error the system will be stopped and you will be prompted.
All errors	The system boot will not stop for any error that may be detected.
All, But Keyboard	The system boot will not stop for a keyboard error, it will stop for all other errors.
All, But Diskette	The system boot will not stop for a disk error, it will stop for all other errors.
All, But Disk/Key	The system boot will not stop for a keyboard or disk error, it will stop for all other errors.

**Memory**

This category is display-only which is determined by the POST (Power On Self Test) of the BIOS.

**Base Memory**

The POST of the BIOS will determine the amount of base (or conventional) memory installed in the system. The value of the base memory is typically 512K for system with 512K memory installed on the motherboard, or 640K for system with 640K or more memory installed on the motherboard.

**Extended Memory**

The BIOS determines how much extended memory is present during the POST. This is the amount of memory located above 1MB in the CPU's memory address map.

**Other Memory**

This refers to the memory located in the 640K address space. This is the memory that can be used for different applications. DOS uses this area to load device drivers to keep as much base memory free application programs. The most common use for this area is Shadow RAM.

## 2.3 BIOS Features Setup

**!! WARNING !!** The information about BIOS defaults in this manual (Figure 3.4.5.6.8) is for reference only, please refers to the BIOS installed on-board, for update information.

### ■ Figure 3. BIOS Features Setup Menu

ROM PCI/ISA BIOS (xxxxxxxx)  
 BIOS FEATURES SETUP  
 AWARD SOFTWARE, INC.

<b>Virus Warning</b>	: Disabled	Video BIOS Shadow	: Enabled
CPU Internal Cache	: Enabled	C8000-CBFFF Shadow	: Disabled
External Cache	: Enabled	CC000-CFFFF Shadow	: Disabled
Quick Power On Self Test	: Enabled	D0000-D3FFF Shadow	: Disabled
Boot Sequence	: A,C,SCSI	D4000-D7FFF Shadow	: Disabled
Swap Floppy Drive	: Disabled	D8000-DBFFF Shadow	: Disabled
Boot Up Floppy Seek	: Enabled	DC000-DFFFF Shadow	: Disabled
Boot Up NumLock Status	: On		
Memory Parity Check	: Enabled		
Typematic Rate Setting	: Disabled		
Typematic Rate(Chars/Sec)	: 6		
Typematic Delay (Msec)	: 250		
Security Option.	: Setup		
PCI / VGA Palette Snoop	: Disabled	ESC : Quit	↑ ↓ → ← : Select Item
OS Select For DRAM > 64MB	: Non-OS2	F1 : Help	PU/PD/+/- : Modify
Report No FDD For WIN 95	:Yes	F5 : Old Values	<Shift> F2 : Color
		F7 : Load Setup Defaults	

### Virus Warning

This category flashes on the screen. During and after the system boot up, any attempt to write to the boot sector or partition table of the hard disk drive will halt the system and an error message will appear. In the mean time, you can run an anti-virus program to locate the problem.

**Disabled** (default)

No warning message will appear when any attempts are made to access the boot sector or hard disk partition table.

**Enabled** Activates automatically when the system boots up causing a warning message to appear when anything attempts to access the boot sector of hard disk partition table.

### **CPU Internal Cache**

**Enabled** (default) Enable cache  
**Disabled** Disable cache

### **External Cache**

These fields allow you to Enable or Disable the CPU's "Level 2" secondary cache. Caching allows better performance.

**Enabled** (default) Enable cache  
**Disabled** Disable cache

### **Quick Power On Self Test**

Select Enabled to reduce the amount of time required to run the power-on self-test (POST). A quick POST skips certain steps. We recommend that you normally disable quick POST. Better to find a problem during POST than lose data during your work.

**Enabled** (default) Enable quick POST  
**Disabled** Normal POST

### **Boot Sequence**

This option determines the drive sequence the computer searches for the OS for at boot-up. The settings are "A, C, SCSI", "C, A, SCSI", "C, CDROM, A", "CDROM, C, A", "D, A, SCSI", "E, A, SCSI", "F, A, SCSI", "SCSI, A, C", "SCSI, C, A" or "C only", "LS/ZIP, C", etc. **The default is "A, C, SCSI".**

### **Swap Floppy Drive**

Switches the floppy disk drive between being designated as A and B. **Default is Disabled.**

### **Boot Up Floppy Seek**

During POST, BIOS will determine if the floppy disk drive installed is 40 or 80 tracks. 360K type is 40 tracks while 720K, 1.2M, and 1.44M are all 80 tracks.



<b>Enabled</b> (default)	BIOS searches for the floppy disk drive to determine if it is 40 or 80 tracks. Note that BIOS cannot tell from 720K, 1.2M or 1.44M drive type as they are all 80 tracks.
<b>Disabled</b>	BIOS will not search for the type of floppy disk drive by track number. Note that there will not be any warning message if the drive installed is 360K.

**Boot Up NumLock Status**

<b>On</b> (default)	Numpad is number keys.
<b>Off</b>	Numpad is arrow keys.

**Memory Parity Check**

Select Enabled if the DRAM chips in your system support parity.

<b>Enabled</b> (default)
<b>Disabled</b>

**Typematic Rate Setting**

This determines the typematic rate.

<b>Enabled</b>	Enable typematic rate and typematic delay programming.
<b>Disabled</b> (default)	Disable typematic rate and typematic delay programming. The system BIOS will use default value and the keyboard controls the function.

**Typematic Rate (Chars/Sec)**

6 (default)	6 characters per second
8	8 characters per second
10	10 characters per second
12	12 characters per second
15	15 characters per second
20	20 characters per second
24	24 characters per second
30	30 characters per second

**Typematic Delay (Msec)**

Choose the length of delay from the time you press a key and the character repeating. (units are mil-sec)

**Security Option**

This category allows you to limit access to the system and Setup, or just to Setup.

<b>System</b>	The system will not boot and access to Setup will be denied if the correct password is not entered at the prompt.
<b>Setup (default)</b>	The system will boot, but access to Setup will be denied if the correct password is not entered at the prompt.

**PCI/VGA Palette Snoop**

The default value is Disabled.

<b>Enabled</b>	For giving Video Card on ISA Bus and Card on PCI Bus.
<b>Disabled (default)</b>	For VGA Card only.

**OS Selection for DRAM > 64MB**

Allows OS/2 to be used with > 64MB of DRAM. Settings are Non-OS/2 (default) and OS/2. Set to OS/2 if using more than 64MB and running OS/2.

**DEFAULT is Non-OS2.**

**Report No FDD For WIN 95**

The default value is Yes.

<b>No</b>	Assign IRQ6 For FDD.
<b>Yes (default)</b>	FDD Detect IRQ6 Automatically.

**Video BIOS Shadow**

Determines whether video BIOS will be copied to RAM for faster execution.

<b>Enabled (default)</b>	Optional ROM is enabled.
<b>Disabled</b>	Optional ROM is disabled.

**C8000 - CFFFF Shadow / DC000 - DFFFF Shadow**

Determines whether the optional ROM will be copied to RAM for faster execution.

<b>Enabled</b>	Optional ROM is shadowed.
<b>Disabled</b> (default)	Optional ROM is not shadowed.

**Note :** For C8000 - DFFFF option - ROM on PCI BIOS, BIOS will automatically enable the shadow RAM. User does not have to select the item.

## 2.4 Chipset Features Setup

The Chipset Features Setup option is used to change the values of the chipset registers. These registers control most of the system options in the computer.

### ■ Figure 4. Chipset Feature Setup Menu

ROM PCI/ISA BIOS (xxxxxxx)  
CHIPSET FEATURES SETUP  
AWARD SOFTWARE, INC.

SDRAM CAS Latency	: 3T	
SDRAM WR Retire Date	: X-1-1-1	
CPU to PCI Burst Mem. WR	: Enabled	
CPU to PCI Post Write	: Enabled	
AGP Aperture Size	: 64MB	
Memory Hole at 15M-16M	: Disabled	
PCI Post Write Buffer	: Enabled	
Onboard PCI Sound chip	: Enabled	
		ESC : Quit    ↑ ↓ → ← : Select Item
		F1 : Help      PU/PD/+/- : Modify
		F5 : Old Values    <Shift> F2 : Color
		F7 : Load Setup Defaults

#### **SDRAM CAS Latency**

This option determines the CAS latency time parameter of SDRAM.  
The settings are 2 or 3 clks.

#### **SDRAM WR Retire Rate**

SDRAM Write Retire Rate.  
**X-2-2-2**  
**X-1-1-1** (default)

#### **CPU to PCI Burst Mem. WR**

Select enabled permits PCI burst memory write cycles, for faster performance.  
When disabled, performance is slightly slower, but more reliable.

**Disabled**  
**Enabled** (default)

**CPU to PCI Post Write**

Select enabled to use a fast buffer for posting writes to memory. Using a fast buffer releases the CPU before completion of a write cycle to DRAM.

**Disabled**  
**Enabled** (default)

**AGP Aperture Size**

This option determines the effective size of the graphics aperture used in the particular PAC configuration. The AGP aperture is memory mapped, while graphics data structure can reside in a graphics aperture. The aperture range should be programmed as not cacheable in the processor cache, accesses with the aperture range are forwarded via a translation table that is maintained on the main memory. The option allows the selection of an aperture of 4MB,8MB,16MB,32MB,64MB,128MB,or 256MB.

**Memory hole at 15M-16M**

In order to improve performance, certain space in memory can be reserved for ISA cards. This memory must be mapped into the memory space below 16MB.

**Enabled**                      Memory hole supported.  
**Disabled** (default)        Memory hole not supported.

**PCI Post Write Buffer**

Enable/disable PCI post write buffer.

**Disabled**  
**Enabled** (default)

**Onboard PCI Sound chip**

This item allows you determine to use the function of PCI Sound chip built on board.

**Disabled**  
**Enabled** (default)

## 2.5 Power Management Setup

### ■ Figure 5. Power Management Setup Menu

ROM PCI/ISA BIOS (xxxxxxx)  
POWER MANAGEMENT SETUP  
AWARD SOFTWARE, INC.

<b>Power Management</b> : User Define	VGA Activity : Enabled
PM Control by APM : Yes	IRQ (3-7,9-15),NMI : Enabled
Video Off Option : Suspend ->Off	IRQ 8 Break Suspend : Disabled
Video Off Method : DPMS Supported	Power Button Over Ride : Instant off
Doze Speed (div by) : 2/8	Ring Power Up Control : Disabled
Stdby Speed (div by) : 1/8	Power on by PCI Card : Disabled
MODEM Use IRQ : 3	LAN Powr Up Control : Disabled
	Power Up by Alarm : Disabled
** PM Timers **	
HDD Off After : Disabled	
Doze Mode : Disabled	
Standby Mode : Disabled	
Suspend Mode : Disabled	
** PM Events **	
HDD Ports Activity : Enabled	ESC : Quit ↑↓ → ← : Select Item
COM Ports Activity : Enabled	F1 : Help PU/PD/+/- : Modify
LPT Ports Activity : Enabled	F5 : Old Values <Shift> F2 : Color
	F7 : Load Setup Defaults

### Power Management

<b>Disable</b> (Min. Saving)	Global Power Management will be disabled.
<b>User Define</b> (default) (Max. Saving)	Users can configure their own power management.
Min Saving	Pre-defined timer values are used such that all timers are at their MAX value.
Max Saving	Pre-defined timer values are used such that all timers are at their MIN value.

**PM Control by APM**

<b>No</b>	System BIOS will ignore APM when Power Management is on.
<b>Yes (default)</b>	System BIOS will wait for APM's prompt before it enters any PM mode.

**Video Off Option**

This field determines when to activate the video off feature for monitor power management. The settings are All Modes->Off; Always On; Suspend-> Off; and Susp, Stby-> Off.

**Video Off Method**

<b>Blank Screen</b>	The system BIOS will only blank the screen when disabling video.
<b>V/H SYNC+Blank</b>	In addition to the above, BIOS will also turn off the V-SYNC & H-SYNC signals from VGA card to monitor.
<b>DPMS (default)</b>	This function is enabled only for a VGA card supporting DPMS.

**Doze Speed /Stdby Speed**

These two fields set the CPU speed during each mode. The number indicates what the normal CPU speed is divided by

**MODEM Use IRQ**

This determines the IRQ, which the MODEM can use.

**3 is (default)**  
**4 / 5 / 7 / 9 / 10 / 11 / NA**

**HDD Off After**

By default, this item is Disabled, meaning that no matter the mode the rest of the system, the hard drive will remain ready. Otherwise, you have a range of choices from 1 to 15 minutes or Suspend. This means that you can elect to have your hard disk drive be turned off after a selected number of minutes or when the rest of the system goes into a Suspend mode.

**Doze Mode /Standby Mode /Suspend Mode**

The **Doze Mode**,**Standby Mode**,and **Suspend Mode** fields set the Period of time after which each of these modes activate. At *Max Saving*, these modes activate sequentially (in the given order) after one minute; at *Min Saving* after one hour.

**HDD Ports Activity**

When set to On (default), any event occurring at a HDD (serial) port will awaken a system which has been powered down.

**COM Ports Activity**

When set to On (default), any event occurring at a hard or floppy drive port will awaken a system which has been powered down.

<b>Disabled</b>	Disable COM Ports Activity.
<b>Enabled</b> (default)	Enable COM Ports Activity.

**LPT Ports Activity**

When set to On (default), any event occurring at a LPT (printer) port will awaken a system which has been powered down.

<b>Disabled</b>	Disable LPT Ports.
<b>Enabled</b> (default)	Enable LPT Ports.

**VGA Active**

The default value is Disabled.

<b>Disabled</b>	Disabled monitor VGA activity.
<b>Enabled</b> (default)	Enabled monitor VGA activity.

**IRQ [3-7,9-15],NMI**

The default value is Enabled.

<b>Disabled</b>	Disable this function.
<b>Enabled</b> (default)	Enable monitor IRQ [3-7,9-15] for Green event.



**IRQ8 Break Suspend**

The default value is Disabled.

**Disabled** (default)

**Enabled**

Disable this function.

Enable IRQ8 (Timer) Wake up system from Suspend.

**Power Button Over Ride**

This item allows you to set the 'off-function' of the power button by software control. The default : Delay 4 Sec. Instant Off.

**Instant Off** (default)

**Ring Power Up Control**

An input signal on the serial Ring Indicator (RI) line (in other words, an incoming call on the modem) awakens the system from a soft off state.

**Disabled** (default)

**Power on by PCI CARD**

To use function, you need PCI card which support power on functions. It can control power status from PCI device.

**Disabled** (default)

**Enabled**

**LAN Power Up Control**

To use this function, you need a LAN add-on card which support power on functions. It should also support the wake-up on LAN jumper

**Disabled** (default)

**Enabled**

**Power Up by Alarm**

When set to Enabled RTA Alarm Resume, you can set the date (of month) and time (hh:mm:ss), to any date occurring, at which a system that has been powered down will awaken.

**Disabled** (default)

## 2.6 PNP / PCI Configuration Setup

### ■ Figure 6. PNP / PCI Configuration Setup Menu

ROM PCI/ISA BIOS (xxxxxxx)  
 PNP / PCI FUNCTION SETUP  
 AWARD SOFTWARE, INC.

Resources Controlled By : Auto	PCI IRQ Activated By : Level
Reset Configuration Data : Disabled	
	ESC : Quit    ↑↓ → ← : Select Item F1 : Help      PU/PD/+/- : Modify F5 : Old Values   <Shift> F2 : Color F7 : Load Setup Defaults

#### Resources Controlled By “Auto” or “Manual”

By Choosing “Auto” the system BIOS will detect the system resource and automatically assign the relative IRQ and DMA channel for each peripheral.

By Choosing “Manual”(default), the user will need to assign IRQ & DMA for add-on cards. Be sure that there are no IRQ/DMA and I/O port conflicts.

#### Resources Configuration Data

The system BIOS supports the PnP feature so the system needs to record which resource is assigned and protect resources from conflict. Every peripheral device has a node which is called ESCD. This node records which resources are assigned to it. The system needs to record and update ESCD to the memory locations. These locations (4K) are reserved at the system BIOS.

If Disabled (default) is chosen, the system’s ESCD will update only when the new configuration varies from the last one.

If Enabled, the system will be forced to update ESCDs if the system configuration has changed and then auto set this option to the "Disabled" mode.

IRQ-3	assigned to : PCI / ISA PnP
IRQ-4	assigned to : PCI / ISA PnP
IRQ-5	assigned to : PCI / ISA PnP
IRQ-7	assigned to : PCI / ISA PnP
IRQ-9	assigned to : PCI / ISA PnP
IRQ-10	assigned to : PCI / ISA PnP
IRQ-11	assigned to : PCI / ISA PnP
IRQ-12	assigned to : PCI / ISA PnP
IRQ-14	assigned to : PCI / ISA PnP
IRQ-15	assigned to : PCI / ISA PnP
DMA-0	assigned to : PCI / ISA PnP
DMA-1	assigned to : PCI / ISA PnP
DMA-3	assigned to : PCI / ISA PnP
DMA-5	assigned to : PCI / ISA PnP
DMA-6	assigned to : PCI / ISA PnP
DMA-7	assigned to : PCI / ISA PnP

The above settings will be shown on the screen only if "Manual" is chosen for the Resources Controlled By function.

Legacy is the term which signifies that a resource is assigned to the ISA Bus and provides for non PnP ISA add-on cards. PCI / ISA PnP signifies that a resource is assigned to the PCI Bus or provides for ISA PnP add-on cards and peripherals.

#### **PCI IRQ Activated By**

This sets the method by which the PCI bus recognizes that an IRQ service is being requested by a device. Under all circumstances, you do not choose this option unless advised by the system manufacturer.

**Level** (default)

**Edge**

## 2.7 Load SETUP Defaults

Chipset defaults indicate the values required by the system for maximum performance.

### ■ Figure 7. Load SETUP Defaults Screen

ROM PCI/ISA BIOS (xxxxxxx)  
 CMOS SETUP UTILITY  
 AWARD SOFTWARE, INC.

STANDARD CMOS SETUP	CPU FEATURES & MISCELLANEOUS
BIOS FEATURES SETUP	INTEGRATED PERIPHERALS
CHIPSET FEATURES SETUP	PASSWORD SETTING
POWER MANAGEMENT SETUP	IDE HDD AUTO DETECTION
PCI & PCI CON	
LOAD SETUP D	
<b>Load SETUP Defaults (Y/N) ? N</b>	
Esc : Quit	↑ ↓ → ← : Select Item
F10 : Save & Exit Setup	(Shift) F2 : Change Color
Load SETUP Defaults except Standard CMOS SETUP	

If you wish to load the SETUP Defaults, change the prompt to <Y> and press <ENTER>.

## 2.8 CPU FEATURES & MISCELLANEOUS

### ■ Figure 8.CPU Speed Setting Menu

ROM PCI/ISA BIOS (xxxxxxx)  
CPU SPEED SETTING  
AWARD SOFTWARE, INC.

<b>Current CPU Temperature</b> : xxx Current CPUFAN1 Speed : xxx  12 (V) :xx.x (V) 5 (V) :x.x (V) 3.3(V) :x.xx (V) Vcore :x.xx (V)	ESC : Quit    ↑    →    ↓    ← Select Item F1 : Help            PU/PD/+/- : Modify F5 : Old Values    <Shift> F2 : Color F7 : Load Setup Defaults
--	--

#### **Current CPU Temperature**

This field displays the current CPU temperature, if your computer contains a monitoring system.

#### **Current CPU FAN1 Speed**

Detect CPU Fan speed status automatically.

#### **Current CPU Vcore +3.3V,+5V,+12V**

Detect system's voltage status automatically.

## 2.9 Integrated Peripherals Setup

### ■ Figure 9. Integrated Peripherals Setup Menu

ROM PCI/ISA BIOS (xxxxxxxx)  
INTEGRATED PERIPHERALS  
AWARD SOFTWARE, INC.

<b>Internal PCI/IDE</b>	: Both	Onboard Parallel Port	: 378/IRQ7
IDE Primary Master PIO	: Auto	Parallel Port Mode	: SPP
IDE Primary Slave PIO	: Auto	USB Controller	: Enabled
IDE Secondary Master PIO	: Auto	USB Keyboard Support	: Disabled
IDE Secondary Slave PIO	: Auto	Init Display First	: PCI Slot
Primary Master UltraDMA	: Auto	VGA Shared Memory Size	: 8 MB
Primary Slave UltraDMA	: Auto	VGA Memory Clock (MHz)	: 66
Secondary Master UltraDMA	: Auto		
Secondary Slave UltraDMA	: Auto		
IDE Burst Mode	: Enabled		
IDE Data Port Post Write	: Disabled		
IDE HDD Block Mode	: Enabled		
		ESC : Quit	↑ ↓ → ← : Select Item
Onboard FDC Controller	: Enabled	F1 : Help	PU/PD/+/- : Modify
Onboard Serial Port 1	:3F8/IRQ4	F5 : Old Values	<Shift> F2 : Color
Onboard Serial Port 2	:2F8/IRQ3	F7 : Load Setup Defaults	
UR2 Mode	: Standard		

#### **Internal PCI / IDE**

This chipset contains an internal PCI IDE interface with support for two IDE channels.

**Both** (default)

#### **IDE Primary /Secondary Master /Slave PIO**

The four IDE PIO (programmed Input / Output ) fields let you set a PIO mode (0-4) for each of the four IDE devices that the onboard IDE interface supports.

Modes 0 through 4 provide successively increased performance. In *Auto* mode, the system automatically determines the best mode for each device.

**The choices:** Auto (default) , Mode 0, Mode 1, Mode 2, Mode 3, Mode 4.

**IDE Primary / Secondary Master / Slave UltraDMA**

Ultra DMA / 33 implementation is possible only if your IDE hard drive supports it and the operating environment includes a DMA driver (Windows 95 OSR2 or a thirdparty IDE bus master driver). If your hard drive and your system software both support Ultra DMA / 33, select Auto to enable BIOS support.

**AUTO** (default)

**Disabled**

**IDE Burst Mode**

Selecting *Enabled* reduces latency between each drive read/write cycle, but may cause instability in IDE subsystems that cannot support such fast performance. If you are getting disk drive errors, try setting this value to *Disabled*. This field does not appear when the Internal PCI/IDE field, above, is Disabled.

**Enabled** (default)

**Disabled**

**IDE HDD Block Mode**

This item allows your hard disk controller to use the fast block mode to transfer data to and from your hard disk drive (HDD). Select Enabled only if your hard drives support block mode.

**Enabled** (default)

**Disabled**

Secondary HDD controller used

Secondary HDD controller not used.

**Onboard FDC Controller**

**Enabled / Disabled** The system has an on-board Super I/O chip with a FDD controller that supports 2 FDDs for 360K / 720K / 1.2M / 1.44M / 2.8M. Choose "Enabled" to use the on-board FDD controller for accessing the FDD. Otherwise choose "Disabled" to use an off-board FDD controller.

**Onboard Serial Port 1**

**Disabled / (3F8 / IRQ4) / (2F8 / IRQ3) / (3E8 / IRQ4) / (2E8 / IRQ3)**

**Onboard Serial Port 2****Disabled / (3F8 / IRQ4) / (2F8 / IRQ3) / (3E8 / IRQ4) / (2E8 / IRQ3)**

The system has an Onboard Super I/O chipset with 2 serial ports.

The Onboard serial ports can be selected as:

**Disabled**

3F8 / IRQ4	COM1 uses IRQ4
2F8 / IRQ3	COM2 uses IRQ3
3F8 / IRQ4	COM3 uses IRQ4
2F8 / IRQ3	COM4 uses IRQ3

**UR2 Mode**

This item allow you to determine which Infra Red(IR) function of onboard I/O chip.

**Onboard Parallel Port**

**Disabled/  
(3BC/IRQ7)/  
(278 /IRQ5)/  
(378 /IRQ7)  
Disable**

There is a built-in parallel port on the on-board Super I/O chipset that provides standard, ECP, and EPP features. It has the following options:  
(3BC/IRQ7)Line Printer port 0  
(278 / IRQ5)Line Printer port 2  
(378 / IRQ7)Line Printer port 1

**Parallel Port Mode**

SPP : Standard Parallel Port

EPP : Enhanced Parallel Port

ECP : Extended Capability Port

To operate the onboard parallel port as Standard Parallel Port only, choose "SPP." To operate the onboard parallel port in the ECP and SPP modes simultaneously, choose "ECP/SPP." By choosing "ECP" the onboard parallel port will operate in ECP mode only. Choosing "ECP+EPP" will allow the onboard parallel port to support both the ECP and EPP modes simultaneously. The ECP mode has to use a DMA channel so choose the onboard parallel port with the ECP feature. After selecting it the following message will appear: "ECP Mode Use DMA". At this time the user can choose between DMA channels 3 or 1. The onboard parallel port is EPP Spec. compliant so after the user chooses the onboard parallel port with the EPP function, the following message will be displayed on the screen: "Parallel port EPP Type." At this time either EPP 1.7 spec. or EPP 1.9 spec. can be chosen.





**USB Controller**

The default value is Disabled

**Disabled**

Disable the onboard USB function.

**Enabled**

Enable the onboard USB function.

**USB Keyboard Support**

The default value is Disabled.

**Enabled**

Enable USB Keyboard Support.

**Disabled**

Disable USB Keyboard Support.

**Init Display First**

This item allows you to decide to active PCI Slot or AGP first.

**The choices:** PCI Slot (default), AGP.

**VGA Shared Memory Size**

Specify the size of system memory to allocate for video memory, from 1 MB to 8 MB.

**The choices:** 2MB, 4MB, 8MB (default)

**VGA Memory Clock (MHz)**

Set the speed (MHz) of the VGA memory clock.

**The choices:** 66 (default), 75, 83, 100.

## 2.10 Password Setting

### ■ Figure 10. Supervisor Password Setting

ROM PCI/ISA BIOS (xxxxxxx)  
CMOS SETUP UTILITY  
AWARD SOFTWARE, INC.

STANDARD CMOS SETUP	CPU FEATURES & MISCELLANEOUS
BIOS FEATURES SETUP	INTEGRATED PERIPHERALS
CHIPSET FEATURES SETUP	PASSWORD SETTING
POWER MANAGEMENT SETUP	IDE HDD AUTO DETECTION
PNP / PCI CONFIG	
LOAD SETUP DEF	
Enter Password :	
Esc : Quit	↑ ↓ → ← : Select Item
F10 : Save & Exit Setup	(Shift) F2 : Change Color
Change / SCT / Disable Password	

When you select this function, the following message will appear at the center of the screen to assist you in creating a password.

### ENTER PASSWORD

Type the password, up to eight characters, and press <Enter>. The password you type now will clear any previously entered password from CMOS memory. You will be asked to confirm the password. Type the password again and press <Enter>. You may also press <ESC> to abort the selection and not enter a password. To disable password, just press <Enter> when you are prompted to enter password. A message will confirm that you wish to disable the password. Once the password is disabled, the system will boot and you can enter setup freely.

**PASSWORD DISABLED**

If you select “System” at the Security Option of BIOS Features Setup Menu, you will be prompted for the password every time the system is rebooted or any time you try to enter Setup. If you select “Setup” at Security Option of BIOS Feature Setup Menu, you will be prompted only when you try to enter Setup.

## 2.11 IDE HDD Auto Detection

Automatically configures hard disk parameters. The parameters shown below are only examples.

### ■ Figure 11. Auto Configuration with Optimal Settings Screen

ROM PCI/ISA BIOS (xxxxxxx)  
CMOS SETUP UTILITY  
AWARD SOFTWARE, INC.

HARD DISKS	TYPE	SIZE	CYLS	HEAD	PRECOMP	LAND	SECTOR	MODE
Primary Master	:User	343	665	16	65535	664	63	NORMAL

Select Primary Slave Option (N=Skip) N							
OPTIONS	SIZE	CYLS	HEAD	PRECOMP	LANDZ	SECTOR	MODE
1(Y)	0	0	0	0	0	0	NORMAL

Note : Some Oses (like SCO-UNIX) must use "NORMAL" for installation

ESC : Skip

When you enter this utility, the screen asks you to select a specific hard disk for Primary Master. If you accept a hard disk detected by the BIOS, you can enter "Y" to confirm and then press <Enter> to check next hard disk. This function allows you to check four hard disks and you may press the <Esc> after the <Enter> to exit this function and go back to the Main Menu.

## 2.12 Save & Exit Setup

Save CMOS value changes to CMOS and exit setup.

### ■ Figure 12. Save & Exit Setup Screen

ROM PCI/ISA BIOS (xxxxxxx)  
 CMOS SETUP UTILITY  
 AWARD SOFTWARE, INC.

STANDARD CMOS SETUP	CPU FEATURES & MISCELLANEOUS
BIOS FEATURES SETUP	INTEGRATED PERIPHERALS
CHIPSET FEATURES SETUP	PASSWORD SETTING
POWER MANAGEMENT SETUP	IDE HDD AUTO DETECTION
PNP / PCI CONF	
LOAD SETUP DE	
<b>SAVE to CMOS and Exit (Y/N)?N</b>	
Esc : Quit	↑ ↓ → ← : Select Item
F10 : Save & Exit Setup	(Shift) F2 : Change Color
Save Data to CMOS & Exit SETUP	

Pressing <N> and <ENTER> will return you to the Main Menu.

Pressing <Y> and <ENTER> will save the system parameters and continue with the booting process.

## 2.13 Exit Without Saving

Abandon all CMOS value changes and exit setup.

■ **Figure 13. The Save Settings and Exit Screen**

ROM PCI/ISA BIOS (xxxxxxx)  
CMOS SETUP UTILITY  
AWARD SOFTWARE, INC.

STANDARD COMS SETUP	CPU FEATURES & MISCELLANEOUS
BIOS FEATURES SETUP	INTEGRATED PERIPHERALS
CHIPSET FEATURES SETUP	PASSWORD SETTING
POWER MANA	ON
PNP / PCI CON	<b>Quit Without Saving (Y/N)?N</b>
LOAD SETUP D	
Esc : Quit	↑ ↓ → ← : Select Item
F10 : Save & Exit Setup	(Shift) F2 : Change Color
Abandon all Datas & Exit SETUP	

Pressing <N> and <ENTER> will return you to the Main Menu.

Pressing <Y> and <ENTER> will continue with booting process without saving any system parameters

## 3. Driver Setup

### 3.1 ESS Solo-1 (on-board) Software

#### 3.1.1 Software List

**NOTE:** The mark \* means it can be installed directly from CD by using CD Installation Utility ( i.e. START.EXE).

#### Drivers

Category	Location in CD
Windows 95 / 98	\Solo1\Win9x
Windows NT 4.0	\Solo1\WinNT40

#### Applications

Name	Location in CD	Platform
AudioRack 32 *	\Solo1\Arakp311	Windows 95 / 98



### 3.1.2 Software Installation

- **Installation for Windows 95/98:**

There is an installation wizard, **Driver CD Installation Utility** (START.EXE), located in the root of the CD to let users install drivers directly and conveniently.

- **Installation for Windows NT 4.0:**

1. Start Windows NT 4.0 and open Devices tab in Multimedia Properties Panel  
(Control Panel, Multimedia)
2. Click "Add..." button and choose "Unlisted or Updated Driver" option, then click "OK" button.
3. Point to the location of ESS Solo-1 on-board sound drivers  
For example: X:\Esstech\Winnt40  
X: is your CD-ROM drive where this CD is located.  
and click "OK".
4. In Add Unlisted or Updated Driver Dialog, click "OK" button.
5. Windows will copy the drivers.

### 3.1.3 Using Software

- **Using AudioRack 32**

After the AudioRack 32 Software Installation completed, please refer to Readme.txt and On-line Help come with AudioRack 32 for the detailed information before using AudioRack 32.

## 3.2 Motherboard Software

**NOTE: The mark \* means it can be installed directly from CD by using CD Installation Utility ( i.e. START.EXE).**

### 3.2.1 Software List

Category	Description	Platform	Location in CD
SiS 530 VGA Driver *	Drivers for SiS 530 VGA	Windows 95/98/NT40	\Mb_drv\Vga
SiS IRQ Routing Miniport Patch *	Used for enable PCI bus IRQ Steering function.	Win95(OSR2.1 only)	\Mb_drv\Sisirq
HighPoint XStore Pro *	Install the drivers to support Ultra DMA mode Hard Drive.	Windows 95/98	\Mb_drv\XStore
SiS Bus Master IDE Drivers *	Install the drivers to support Ultra DMA mode Hard Drive.	Windows NT4.0	\Mb_drv\Ide
SiS System Hardware Monitor *	Hardware Monitor is a self-diagnostic system for PC.	Windows 95/98/NT40	\Mb_drv\Hwmon
Award Flash Utility	Used for updating BIOS. (Please refer to chapter - Application Software.)		\Mb_drv \Flash

### 3.2.2 Software Installation

There is an installation wizard, **Driver CD Installation Utility** (START.EXE), located in the root of Driver CD to let users install some common used drivers conveniently.

➤ **The drivers can be installed from CD by using CD Installation Utility:**

You can simply put Driver CD into CD-ROM drive and the Installation Utility will autorun or you can run the Driver CD Installation Utility directly by using mouse cursor to click the proper option on the page. Utility will invoke other applications to complete the rest of installation.

➤ **The drivers CAN NOT be installed directly from CD by using CD Installation Utility:**

Please read the README.TXT located in the root directory on Multimedia CD to get drivers' location and then refer to the INSTALL.TXT or README.TXT files located in each driver directory on the Driver CD to install drivers.

### 3.2.3 Using Software

- In general, you can get more detailed information in the on-line help or readme for the softwares.

- **Using SiS System Hardware Monitor**

After the utility is installed, you can see a tiny icon in the right side of the Task Bar and you can click the icon to invoke the utility again.

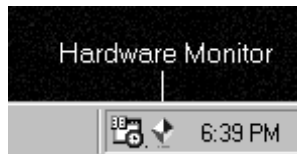

The following figure is the main panel of SiS System Hardware Monitor. In the panel, you can get some real-time and important information -- Voltage, Fan speed, and temperature, for example. If there is an abnormal situation, you can resolve it immediately.

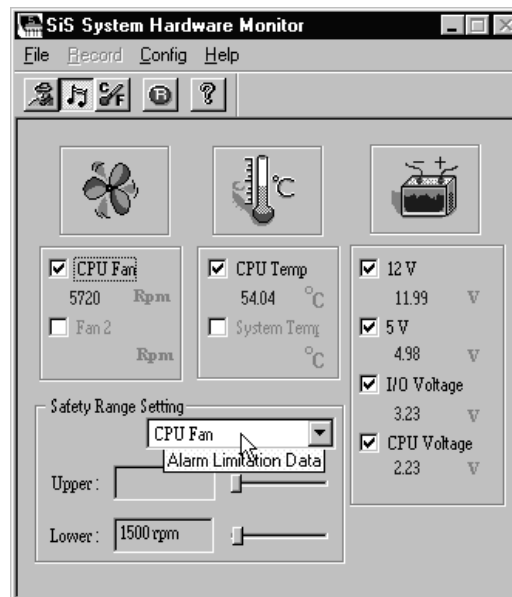

If you want to get more detailed information about SiS System Hardware Monitor, on-line help comes with the utility. You can refer to on-line help to make use of the utility.



## 4. Trouble Shooting

### **PROBLEM**

No power to the system at all. Power light does not illuminate, fan inside power supply does not turn on. Indicator light on keyboard does not turn on.

<b>PROBABLE CAUSE</b>	<b>DIAGNOSIS</b>	<b>SOLUTION</b>
Power cable is unplugged.	Visually inspect power cable	Make sure power cable is securely plugged in
Defective power cable.	Visual inspection, try another cable.	Replace cable.
Power supply failure.	Power cable and wall socket are OK, but system is still dead.	Contact technical support.
Faulty wall outlet; circuit Breaker or fuse blown.	Plug in device known to work in socket and test	Use different socket, repair outlet, reset circuit breaker or replace fuse.

**PROBLEM**

System inoperative. Keyboard lights are on, power indicator lights are lit, hard drive is spinning.

<b>PROBABLE CAUSE</b>	<b>DIAGNOSIS</b>	<b>SOLUTION</b>
Expansion card is partially dislodged from expansion slot on the motherboard.	Turn off computer. Take cover off system unit. Check all expansion cards to ensure they are securely seated in slots.	Using even pressure on both ends of the expansion card, press down firmly on expansion card.
Defective floppy disk drive or tape drive.	Turn system off. Disconnect the cables from one of the floppy drives. Turn on the floppy drives. Turn on the system, check to see if the keyboard operates normally. Repeat until you have located defective unit.	Contact Technical Support.
Defective expansion card.	Turn computer off. Remove an expansion card	Make sure expansion card is secure in expansion socket.

**PROBLEM**

System does not boot from hard disk drive, can be booted from floppy disk drive.

<b>PROBABLE CAUSE</b>	<b>DIAGNOSIS</b>	<b>SOLUTION</b>
Connector between hard drive and system board unplugged.	When attempting to run the FDISK utility described in the HARD DISK section of this manual you get a message, INVALID DRIVE SPECIFICATION.	Check cable running from disk to disk controller board. Make sure both ends are securely plugged in; check the drive type in the Standard CMOS Setup (see HARD DISK section of this manual).
Damaged Hard Disk or Disk Controller.	Format hard disk; if unable to do so the hard disk may be defective.	Contact Technical Support.
Hard Disk directory or FAT is scrambled.	Run the FDISK program, format the hard drive (see HARD DRIVE section of manual). Copy data that was backed up onto Hard Drive.	Backing up the hard drive is extremely important. All Hard Disk are capable of breaking down at any time.

**PROBLEM**

System only boots from floppy Disk. Hard disk can be read and applications can be used but booting from Hard Disk is impossible.

<b>PROBABLE CAUSE</b>	<b>DIAGNOSIS</b>	<b>SOLUTION</b>
Hard Disk boot program has been destroyed.	A number of causes could be behind this.	Back up data and applications files. Reformat the Hard Drive as described in the Hard Drive section of this manual. Re-install applications and data using backup disks.



**PROBLEM**

Error message reading "SECTOR NOT FOUND" or other error messages not allowing certain data to be retrieved.

<b>PROBABLE CAUSE</b>	<b>DIAGNOSIS</b>	<b>SOLUTION</b>
A number of causes could be behind this.	Use a file by file backup instead of an image backup in order to backup the Hard Disk.	Back up any salvageable data. Then low level format, partition, and high level format the hard drive (see Hard Disk section of this manual for instructions). Re-install all saved data when completed.

**PROBLEM**

Disk formatted on IBM PS/2 will not operate with this system.

<b>PROBABLE CAUSE</b>	<b>DIAGNOSIS</b>	<b>SOLUTION</b>
The IBM PS/2 uses a different format than other computers.	IBM PS/2 disk format will not work in an AT type computer.	Format disk in the AT type computer insert disk into the IBM PS/2 and copy the files you wish.

**PROBLEM**

After installing an expansion card (network card, tape drive card, etc.) the system no longer works properly.

<b>PROBABLE CAUSE</b>	<b>DIAGNOSIS</b>	<b>SOLUTION</b>
No power to monitor.	All or part of the system may be inoperable. The new card may work but a mouse or COM port may not work	Change the interrupt or RAM address on the new expansion card. See the documentation that came with the new card in order to change pin settings. Many expansion devices come with proprietary software that will assist you in doing this.

**PROBLEM**

Screen message says "Invalid Configuration" or "CMOS Failure."

<b>PROBABLE CAUSE</b>	<b>DIAGNOSIS</b>	<b>SOLUTION</b>
Incorrect information entered into the configuration (setup) program.	Check the configuration program. Replace any incorrect information.	Review system's equipment . Make sure correct information is in setup.

**PROBLEM**

Screen is blank.

<b>PROBABLE CAUSE</b>	<b>DIAGNOSIS</b>	<b>SOLUTION</b>
No power to monitor.		Check the power connectors to monitor and to system. Make sure monitor is connected to display card, change I/O address on network card if applicable
Monitor not connected to computer.		See instructions above.
Network card I/O address conflict.		See instructions above.

**PROBLEM**

<b>PROBABLE CAUSE</b>	<b>DIAGNOSIS</b>	<b>SOLUTION</b>
Memory problem, display card jumpers not set correctly.		Reboot computer. Reinstall memory, make sure that all memory modules are installed in correct sockets. Check jumper and switch settings on display card. See display card section for information on settings.
Computer virus.		Use anti-virus programs (McAfee, E-Prot, etc) to detect and clean viruses.

**PROBLEM**

Screen goes blank periodically.

<b>PROBABLE CAUSE</b>	<b>DIAGNOSIS</b>	<b>SOLUTION</b>
Screen saver is enabled.		Disable screen saver.

**PROBLEM**

Keyboard failure.

<b>PROBABLE CAUSE</b>	<b>DIAGNOSIS</b>	<b>SOLUTION</b>
Keyboard is disconnected.		Reconnect keyboard. Check keys again, if no improvement replace keyboard.

**PROBLEM**

No color on screen.

<b>PROBABLE CAUSE</b>	<b>DIAGNOSIS</b>	<b>SOLUTION</b>
Faulty Monitor.		If possible, connect monitor to another system. If no color replace monitor.
CMOS incorrectly set up.		Call technical support.

**PROBLEM**

Floppy drive light stays on.

<b>PROBABLE CAUSE</b>	<b>DIAGNOSIS</b>	<b>SOLUTION</b>
Floppy Drive cable not connected correctly.		Reconnect floppy cable making sure PIN1 on the Floppy Drive corresponds with PIN1 on Floppy cable connector.

**PROBLEM**

Error reading drive A:

<b>PROBABLE CAUSE</b>	<b>DIAGNOSIS</b>	<b>SOLUTION</b>
Bad floppy disk.		Try new floppy disk
Floppy disk not formatted		Format floppy disk (type FORMAT A:type ENTER)>

**PROBLEM**

C: drive failure.

<b>PROBABLE CAUSE</b>	<b>DIAGNOSIS</b>	<b>SOLUTION</b>
SETUP program does not have correct information.		Boot from drive A: using DOS system disk. Input correct information to SETUP program.
Hard Drive cable not connected properly.		Check Hard Drive cable.

**PROBLEM**

Cannot boot system after installing second hard drive.

<b>PROBABLE CAUSE</b>	<b>DIAGNOSIS</b>	<b>SOLUTION</b>
Master/Slave jumpers not set correctly.		Set Master/Slave jumpers correctly.
Hard Drives not compatible / different manufacturers.		Run SETUP program and select correct drive types. Call Drive manufacturers for compatibility with other drives.

**PROBLEM**

Missing operating system on hard drive.

<b>PROBABLE CAUSE</b>	<b>DIAGNOSIS</b>	<b>SOLUTION</b>
CMOS setup has been changed.		Run setup and select correct drive type.

**PROBLEM**

Certain keys do not function.

<b>PROBABLE CAUSE</b>	<b>DIAGNOSIS</b>	<b>SOLUTION</b>
Keys jammed or defective.		Replace keyboard.

**PROBLEM**

Keyboard is locked, no keys function.

<b>PROBABLE CAUSE</b>	<b>DIAGNOSIS</b>	<b>SOLUTION</b>
Keyboard is locked.		Unlock keyboard

08/09/1999  
MADE IN TAIWAN  
R.O.C