

430TX

AT

SYSTEM BOARD

OPERATION MANUAL

TABLE OF CONTENTS

| Chapter & Section | Page |
|--|------|
| 1. INTRODUCTION | 1-1 |
| 1.1 SYSTEM OVERVIEW | 1-1 |
| 2. FEATURES | 2-1 |
| 2.1 SYSTEM BOARD LAYOUT | 2-1 |
| 2.2 SPECIFICATIONS | 2-2 |
| 3. HARDWARE SETUP | 3-1 |
| 3.1 UNPACKING..... | 3-1 |
| 3.2 HARDWARE CONFIGURATION | 3-1 |
| 3.2.1 CONNECTORS..... | 3-2 |
| 3.2.2 JUMPERS | 3-10 |
| 3.3 INSTALLING A CPU ONTO THE ZIF SOCKET | 3-11 |
| 3.4 INSTALLATION OF CPU COOLING FAN | 3-13 |
| 3.5 UPGRADING SYSTEM MEMORY | 3-14 |
| 3.5.1 Installing a SIMM module | 3-14 |
| 3.5.2 Installing a DIMM Module | 3-15 |
| 3.5.3 Memory Module Installing..... | 3-16 |
| 4. AWARD BIOS SETUP | 4-1 |
| 4.1 GETTING STARTED..... | 4-1 |
| 4.2 MAIN MENU | 4-2 |
| 4.3 STANDARD CMOS SETUP | 4-4 |
| 4.4 BIOS FEATURES SETUP | 4-5 |
| 4.5 CHIPSET FEATURES SETUP | 4-6 |
| 4.6 POWER MANAGEMENT SETUP | 4-9 |
| 4.7 INTEGRATED PERIPHERALS..... | 4-15 |
| 4.8 LOAD SETUP DEFAULTS | 4-16 |
| 4.9 SUPERVISOR PASSWORD / USER PASSWORD | 4-16 |
| 4.10 HDD LOW LEVEL FORMAT | 4-17 |
| 4.11 SAVE &EXIT SETUP | 4-17 |
| 4.12 EXIT WITHOUT SAVING | 4-17 |

TRADEMARKS

All trademarks used in this manual are the property of their respective owners.

NOTE

The “LOAD SETUP DEFAULTS” function loads the default settings directly from BIOS default table, these default settings are the best-case values that will optimize the system performance and increase the system stability. This is strongly recommended when you first receive this system board, or the system CMOS data is corrupted.

Move the selection bar to “LOAD SETUP DEFAULTS” and then press the “ENTER” key and then the SETUP default values will be loaded into the system. (Please refer to the Chapter 4 AWARD BIOS SETUP procedures in this manual.)

NOTICE

Information presented in this manual has been carefully checked for reliability; however, no responsibility is assumed for inaccuracies. The information contained in this manual is subject to change without prior notice.

1. INTRODUCTION

1.1 SYSTEM OVERVIEW

This mainboard is a AT form-factor PCI Local Bus Pentium system mainboard. It uses the 82430TX PCIset system chipsets and Winbond I/O chipset, which build-in two channel PIO and Bus Master Enhanced PCI IDE ports, one Floppy Disk control port, two high speed Serial ports (UARTs), one multi-mode Parallel port, one PS/2 keyboard port, one PS/2 mouse port, one IR port, two USB ports, and support PC97 specification. This mainboard is designed for the high performance Pentium or other equivalent processors for high-end application and it is a true GREEN-PC computer system.

This system board supports the Peripheral Component Interconnect (PCI) Local Bus standard (PCI Specification Rev. 2.1 compliant). It not only breaks through the I/O bottlenecks if the traditional ISA mainboard, but also provides the performance needs for networking and multi-user environments.

There are two power connectors built on the board, they are the AT and ATX power supply connectors. When you connect the ATX power supply to the mainboard, your PC system will comply with PC 97 features and you will be able to benefit from the ACPI features which is provided on the mainboard. If you choose the AT type power supply, the ACPI feature will be disabled.

2. FEATURES

2.1 SYSTEM BOARD LAYOUT

Explanation : All connectors, jumpers and components which are marked by a black point on the corner means the pin-1 side of the connector, jumper and component.

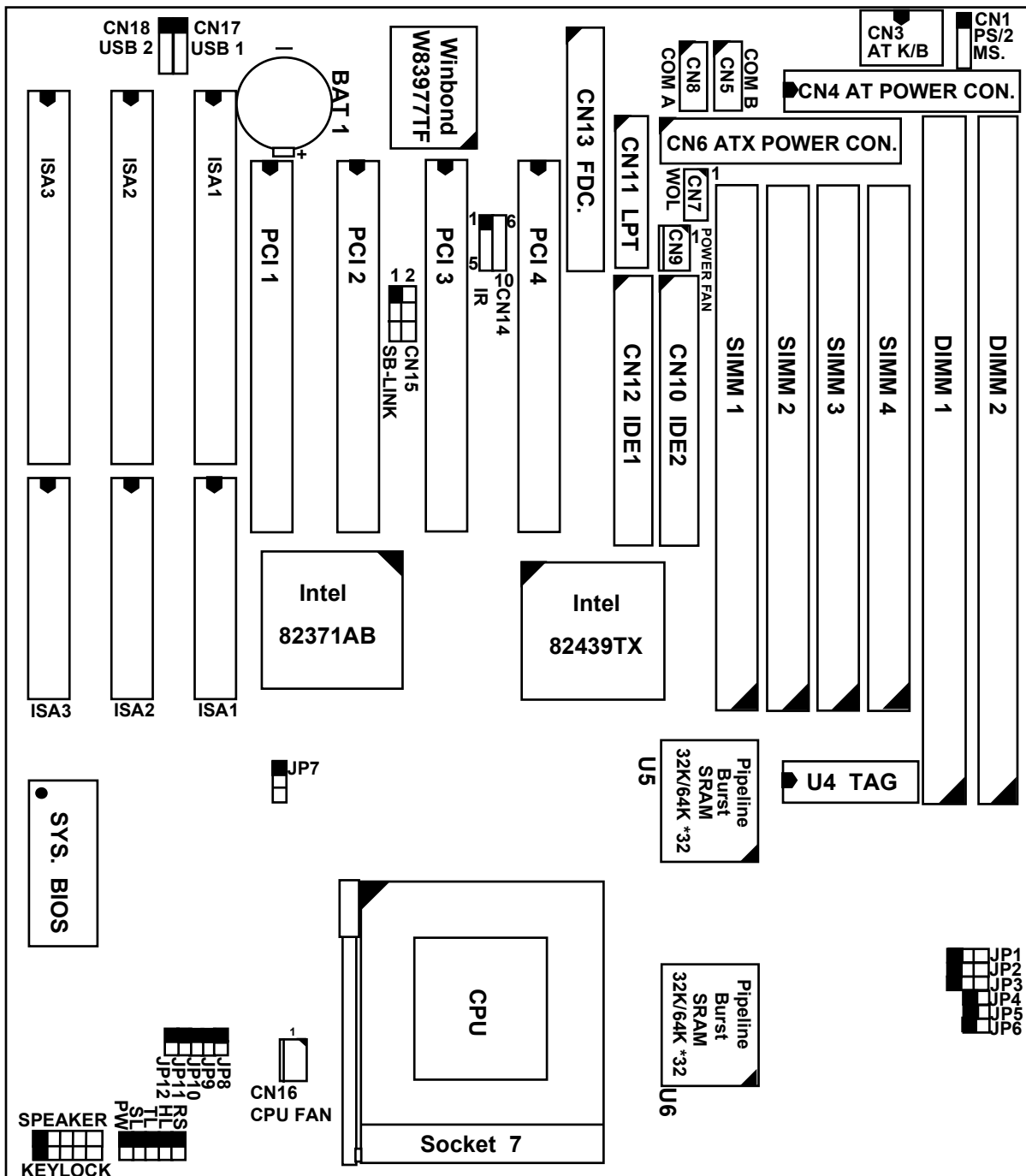

2.2 SPECIFICATIONS

Chipset

Intel 82430TX (82439TX (MTXC), 82371AB(PIIX4)) and Winbond W83977TF-A (-AW / ATF-AW).

CPU (Jumper free)

Intel : Pentium processor and OverDrive processor (P54C / P54CS / P54CTB / P55C) 90 / 100 / 120 / 133 / 150 / 166 / 200 / 233 MHz.

Cyrix : 6x86 / 6x86L - P150+ / P166+ / P200+.

6x86MX - PR166 / PR200 / PR233 / PR266.

AMD : K6 / PR2-166 / PR2-200 / PR2-233 / PR2-266.

IDT : C6 - DS180 / DS200

CPU Voltage (Jumpers Setting or Jumper free)

(1).CPU I/O voltage : +3.4V DC or +3.5V DC.

(2).CPU CORE voltage: +2.1V, +2.8V, +2.9V, +3.2V,+3.4V, +3.5V .

System Clock (Jumper free)

60 / 66.6 / 75 MHz.

Memory

DRAM : Two banks, each bank could be single or double sided, 8MB up to 256MB.

Supports fast page mode (FPM), Extended Data Out (EDO), and SDRAM memory (Using 72-pin SIMM module x 4, and 168-pin DIMM module x 2).

DIMMs' operating voltage supports +3.3V DC.

SRAM : 256KB or 512KB pipelined burst SRAM on board.

BIOS

AWARD System BIOS. 128KB x 8 Flash ROM (for Plug & Play BIOS).

Expansion Slots

PCI Slots : 32-bit x 4 (All Master / Slave, PCI 2.1 Compliant).

ISA Slots : 16-bit x 3 (One PCI / ISA slot shared).

Supports AT and ATX Power connector.

ACPI (only for ATX Power)

- 1.Powered on by Panel-Switch, or Modem Ring-In.
- 2.Powered on by Keyboard, PS/2 Mouse, or LAN Signal. (optional)
- 3.Powered off (Soft-off) by OS or Panel-Switch.

 WOL (optional)

One WOL connector supports Wake-On-LAN (For ATX Power).

 IDE Ports

Two channel PIO and “Ultra DMA/33” Bus Master PCI IDE ports, which will connect maximum 4 IDE devices like IDE Hard Disk and ATAPI CD-ROM device. PIO Mode 4 transfer rate up to 14 Mbytes/s transfer rates and supports “Ultra DMA/33” mode transfers up to 33 Mbytes/sec.

 USB Ports

Two Universal Serial Bus (USB) ports.

 Super I/O Ports

- 1.Two high speed NS16C550 compatible Serial ports (UARTs).
- 2.One SPP / EPP / ECP mode Bi-directional parallel port.
- 3.One Floppy Disk Control port.

 IR Port

One HPSIR and ASKIR or Faster IR (optional) compatible Infrared port. One Consumer IR port (optional).

NOTE : Winbond W83977TF support HPSIR and ASKIR, W83977ATF support Faster IR and Consumer IR.

 Mouse and Keyboard

Supports PS/2 Mouse connector, PS/2 Keyboard connector (optional) and AT Keyboard connector.

 Support SB-LINK Connector

Support Creative PCI sound card, or others PCI sound card.

 Hardware Monitoring (optional)

1. Monitor the Positive Voltage, CPU temperature, and two fan speed monitoring.
2. Supports speaker beep alarming when abnormal detected.
3. Protects CPU by slowing down the CPU speed when overheat.

Software compatibility

MS-DOS, Windows NT, OS/2, UNIX, NOVELL, Windows, Windows 95, CAD/CAM, Memphis (Beta 2), ...etc, full tested.

 DIMENSION

Width & Length : 220 mm x 231 mm.

Height : 3/4 inches with components mounted.

PCB Thickness : 4-layers, 0.05 inches normal.

Weight : 20 ounces.

 ENVIRONMENT

Operating Temperature : 10°C to 40°C. (50°F to 104°F).

Require Airflow : 50 linear feet per minute across CPU.

Storage Temperature : -40°C to 70°C. (-40°F to 158°F).

Humidity : 0 to 90% non-condensing.

Altitude : 0 to 10,000 feet.

3. HARDWARE SETUP

This chapter explains how to configure the mainboard hardware. When you are installing the mainboard, you will have to make jumper settings and cable connections. Please refer to the following sections for the details:.

3.1 UNPACKING

The system board package contains the following parts :

- This system board.
- Operation manual.
- Cable set for IDE and I/O device.

The mainboard contains electric sensitive component which can be easily damaged by static electricity, so the mainboard should be left in its original packing until it is installed.

Unpacking and installation should be done on a grounded anti-static mat. The operator should be wearing an anti static wristband, grounded at the same point as the anti-static mat.

Inspect the mainboard carton for obvious damage. Shipping and handling may cause damage to your board. Be sure there are no shipping and handling damages on the board before proceeding.

After opening the motherboard carton, extract the mainboard and place it only on a grounded anti-static surface with the component side up. Inspect the board again to see whether there is any damage.

Press on all of the socket IC's to make sure that they are properly seated. Do this only with the board placed on a firm flat surface.

3.2 HARDWARE CONFIGURATION

Before the system board is ready for operating, the hardware must be configured to make sure it will work properly with different environment. To configure the system board is a simple task, only a few jumpers, connectors, cables and sockets need to be selected and installed. (For the detailed locations of each component please refer to the "system board layout figure" which appears in page 2-1.)

3.2.1 CONNECTORS

A connector is two or more pins that are used make connections to the system standard accessories (such as power, mouse, printer,...etc.). The following is a list of connectors on board, as well as descriptions of each individual connector.

(A) BAT1 Non-rechargeable battery (Using 3V Lithium battery : CR2032)

Pin # Assignment

- + Battery Positive
- Ground

(B) CN1 PS/2 Mouse converted connector

Pin # Assignment

| | | | |
|---|---|---|---------------|
| 1 | ● | 1 | Mouse Data |
| 2 | | 2 | No Connection |
| 3 | ● | 3 | Ground |
| 4 | ● | 4 | +5V DC |
| 5 | ● | 5 | Mouse Clock |

(C) CN2 PS/2 Keyboard connector (optional)

Pin # Assignment

- 1 Keyboard Data
- 3 Ground
- 5 Keyboard Clock

Pin # Assignment

- 2 No Connection
- 4 +5V DC
- 6 No Connection

(D) CN3 AT Keyboard connector

Pin # Assignment

- 1 Keyboard Clock
- 3 No Connection
- 5 +5V DC

Pin # Assignment

- 2 Keyboard Data
- 4 Ground

(E) CN4 AT Power connector

| | | <u>Pin #</u> | <u>Assignment</u> | |
|----|----|--------------|-------------------|------------|
| P8 | 1 | 1 | Power Good | (Orange) |
| | 2 | 2 | +5V DC | (Red) |
| | 3 | 3 | +12V DC | (Yellow) |
| | 4 | 4 | -12V DC | (Blue) |
| | 5 | 5 | Ground | (Black) |
| P9 | 6 | 6 | Ground | (Black) |
| | 7 | 7 | Ground | (Black) |
| | 8 | 8 | Ground | (Black) |
| | 9 | 9 | -5V DC | (White) |
| | 10 | 10 | +5V DC | (Red) |
| | 11 | 11 | +5V DC | (Red) |
| | 12 | 12 | +5V DC | (Red) |

Note: There are two connectors from the switching power supply (P8 & P9), Wrong connection will cause permanent damage to the mainboard. So be sure to make the power connector correctly all the time. When you are connecting the power connector to the mainboard, please look at the power cable carefully and you will see the black color wire on both cables, Joint the black cable and then have the connectors connected to the mainboard.



(F) CN5 COM B (Serial Port 2) connector
COM 1/2/3/4, selected by BIOS setup, using IRQ 3 or 4

| <u>1</u> | <u>2</u> | <u>Pin #</u> | <u>Assignment</u> | <u>Pin #</u> | <u>Assignment</u> |
|----------|----------|--------------|---------------------------|--------------|---------------------------|
| ● | ● | 1 | DCD (Data Carrier Detect) | 2 | RD (Received Data) |
| ● | ● | 3 | TD (Transmit Data) | 4 | DTR (Data Terminal Ready) |
| ● | ● | 5 | Ground | 6 | DSR (Data Set Ready) |
| ● | ● | 7 | RTS (Request To Send) | 8 | CTS (Clear To Send) |
| ● | ● | 9 | RI (Ring Indicator) | 10 | No Connection |
| 9 | 10 | | | | |

(G) CN6 ATX Power connector











| <u>Pin #</u> | <u>Assignment</u> | <u>Pin #</u> | <u>Assignment</u> |
|--------------|-------------------|--------------|-------------------|
| 1 | +3.3V DC | 2 | +3.3V DC |
| 2 | Ground | 4 | +5V DC |
| 5 | Ground | 6 | +5V DC |
| 7 | Ground | 8 | PW_OK |
| 9 | +5V DC | 10 | +12V DC |
| 11 | +3.3V DC | 12 | -12V DC |
| 13 | Ground | 14 | PS-ON |
| 15 | Ground | 16 | Ground |
| 17 | Ground | 18 | -5V DC |
| 19 | +5V DC | 20 | +5V DC |

(H) CN7 WOL (Wake On LAN) connector



| <u>Pin #</u> | <u>Assignment</u> |
|---|-------------------|
|  1 | 5V standby |
|  2 | Ground |
|  3 | WOL Signal |

(I) CN8 COM A (Serial Port 1) connector

COM 1/2/3/4, selected by BIOS setup, using IRQ4 or 3

| <u>Pin #</u> | <u>Assignment</u> | <u>Pin #</u> | <u>Assignment</u> |
|---|-----------------------------|--------------|---------------------------|
|   | 1 DCD (Data Carrier Detect) | 2 | RD (Received Data) |
|   | 3 TD (Transmit Data) | 4 | DTR (Data Terminal Ready) |
|   | 5 Ground | 6 | DSR (Data Set Ready) |
|   | 7 RTS (Request To Send) | 8 | CTS (Clear To Send) |
|   | 9 RI (Ring Indicator) | 10 | No Connection |

(J) CN9 POWER FAN connector

| <u>Pin #</u> | <u>Assignment</u> |
|---|------------------------|
|  1 | GND |
|  2 | +12V DC |
|  3 | SIN (Fan Sense Signal) |

(K) CN10 IDE 2 connector (Secondary IDE Port, using IRQ15)

(L) CN11 Parallel Port Connector

(Supports SPP/EPP/ECP mode, using IRQ7 or IRQ5, ECP modes use DMA channel 3 or channel 1, and it can be programmed by CMOS setup)

| 1 | 14 | <u>Pin #</u> | <u>Assignment</u> | <u>Pin #</u> | <u>Assignment</u> |
|----|----|--------------|-------------------|--------------|-------------------|
| ● | ● | 1 | STROBE- | 14 | AUTO FEED- |
| ● | ● | 2 | Data Bit 0 | 15 | ERROR- |
| ● | ● | 3 | Data Bit 1 | 16 | INIT- |
| ● | ● | 4 | Data Bit 2 | 17 | SLCT IN- |
| ● | ● | 5 | Data Bit 3 | 18 | Ground |
| ● | ● | 6 | Data Bit 4 | 19 | Ground |
| ● | ● | 7 | Data Bit 5 | 20 | Ground |
| ● | ● | 8 | Data Bit 6 | 21 | Ground |
| ● | ● | 9 | Data Bit 7 | 22 | Ground |
| ● | ● | 10 | ACK- | 23 | Ground |
| ● | ● | 11 | BUSY | 24 | Ground |
| ● | ● | 12 | PE | 25 | Ground |
| ● | ● | 13 | SLCT | 26 | No Connection |
| 13 | 26 | | | | |

(M)CN12 IDE 1 connector (Primary IDE Port, using IRQ 14)

(N)CN13 Floppy Disk Control Port connector (Using IRQ6, DMA channel 2)

(O)CN14 IR / FIR (Infrared Rays) connector

| | <u>Pin #</u> | <u>Assignment</u> |
|---|--------------|---|
| ● | 1 | +5V DC |
| | 2 | No Connection (Fast IR Receive, optional for W83977ATF) |
| ● | 3 | IR Receive |
| ● | 4 | Ground |
| ● | 5 | IR Transmit |

- (P) CN14 Consumer IR connector
(optional and available only while U10 using W83977ATF I/O Chip)

| | | <u>Pin #</u> | <u>Assignment</u> |
|---|---|--------------|---------------------|
| ● | 6 | 6 | +5V DC |
| ● | 7 | 7 | IR Transmit |
| ● | 8 | 8 | Consumer IR Receive |
| ● | 9 | 9 | Ground |

- (Q) CN15 SB-LINK connector
(For PCI bus sound cards. Such as Creative™ Labs EMU8008 sound chip)

| | | <u>Pin #</u> | <u>Assignment</u> | <u>Pin #</u> | <u>Assignment</u> |
|---|---|--------------|-------------------|--------------|-------------------|
| ● | 1 | 1 | GNT# | 2 | Ground |
| | 2 | 3 | Key | 4 | REQ# |
| ● | 3 | 5 | Ground | 6 | SERIRQ |
| ● | 4 | | | | |
| ● | 5 | | | | |
| | 6 | | | | |

- (R) CN16 CPU Cooling Fan Power connector

| | | <u>Pin #</u> | <u>Assignment</u> |
|---|---|--------------|-------------------|
| ● | 1 | 1 | Ground |
| ● | 2 | 2 | +12V DC |
| ● | 3 | 3 | Fan Sense Signal |

- (S) CN17 USB Port 1 (Universal Serial Bus port 1) connector

| | | <u>Pin #</u> | <u>Assignment</u> |
|---|---|--------------|---------------------|
| ● | 1 | 1 | +5V DC (RED WIRE) |
| ● | 2 | 2 | DATA- (WHITE WIRE) |
| ● | 3 | 3 | DATA+ (GREEN WIRE) |
| ● | 4 | 4 | Ground (BLACK WIRE) |
| ● | 5 | 5 | Ground (BLACK WIRE) |

(T) CN18 USB Port 2 (Universal Serial Bus port 2) connector

| 1 | <u>Pin #</u> | <u>Assignment</u> |
|---|--------------|---------------------|
| ● | 1 | +5V DC (RED WIRE) |
| ● | 2 | DATA- (WHITE WIRE) |
| ● | 3 | DATA+ (GREEN WIRE) |
| ● | 4 | Ground (BLACK WIRE) |
| ● | 5 | Ground (BLACK WIRE) |

(U) KEYLOCK Front Panel Power LED & Key-Lock connector

| 1 | <u>Pin #</u> | <u>Assignment</u> |
|---|--------------|-------------------------------|
| ● | 1 | Pullup (+5V DC for Power LED) |
| ● | 2 | No Connection |
| ● | 3 | Ground |
| ● | 4 | Keyboard Lock |
| ● | 5 | Ground |

(V) SPEAKER Speaker connector

| 1 | <u>Pin #</u> | <u>Assignment</u> |
|---|--------------|---------------------|
| ● | 1 | +5V DC |
| ● | 2 | No Connection |
| ● | 3 | No Connection |
| ● | 4 | Speaker Data Signal |

(W) RS Reset Button connector

Open : No action

Pin # Assignment

1 Ground

Short : System Reset

Pin # Assignment

2 Reset Control

(X) HL IDE HDD LED connector

Pin # Assignment

1 Pullup (+5V DC)

Pin # Assignment

2 Signal Pin

| | | | |
|--------|---------------------|--|------------------|
| (Y) TL | Turbo LED connector | | |
| | Pin # Assignment | | Pin # Assignment |
| | 1 Pullup (+5V DC) | | 2 Ground |

| | | | |
|--------|-------------------------|--|-------------------------|
| (Z) SL | Sleep LED connector | | |
| | ATX Power Off | | : LED Turn On |
| | ATX Power On | | : LED Turn Off |
| | <u>Pin # Assignment</u> | | <u>Pin # Assignment</u> |
| | 1 Signal Pin | | 2 Ground |

(AA) PW

(a.) For ATX power

According to the setup in CMOS, the PW connector has two functions. It can be the Power Switch or Suspend Switch of your PC system. (the PW switch can be programmed by the BIOS setup "Soft-off by PWR-BTTN")

- ① **If the setup in CMOS is "Delay 4 Sec.", the switch function will be:**
 - i. **When system is power off :**
Press this switch, the system will power on.
 - ii. **When system power is on :**
 - a. The system is in Full-ON mode :
 - a-1. Click on this switch (less than 4 seconds), the system will be turned into Suspend mode. (turn into the GREEN mode)
 - a-2. Press and hold this switch for more than 4 seconds, the system will be powered off.
 - b. When the system is in Suspend mode :
 - b-1. Click on this switch (less than 4 seconds), the system will return to Full-ON mode.
 - b-2. Press and hold this switch more than 4 seconds, the system will be powered off.
- ② **The setup in CMOS is "Instant-off":**
 - i. When system power is off :
Click on this switch, the system will be powered on.
 - ii. When system power is on :
Click on this switch, the system will be powered off instantly.

(b.) For AT power

When you are using the AT type power supply, you can always use the power button to turn the system power on and off. However, If you will leave your PC system for a while and you don't want to turn the power off, you can use the PW button to turn your PC system into suspend mode.

Note: this feature will work only when "Delay 4 Sec." is selected in the "Soft-off by PWR-BTTN" selection field of the BIOS setup utility. (please refer to Chapter 4)

One click on the PW button : Turn into suspend mode.

Another click on the PW button : Return to the full on mode.

3.2.2 JUMPERS

There is only one jumper on the board, it is JP7 and it will be used to discharge the CMO. Please see the following for the details.

(A) JP7 Clear CMOS button

| <u>Pin #</u> | <u>Function</u> |
|--------------|-----------------|
|--------------|-----------------|

| | |
|-----|------------------|
| 1-2 | Normal Operation |
|-----|------------------|

| | |
|-----|------------|
| 2-3 | Clear CMOS |
|-----|------------|

Note: *Improper BIOS setting may cause hang-up to the PC system. In case that it should be happened, you may use JP7 to clear the information which is stored in the CMOS memory and get the PC system back to its default settings. Improper connection on JP7 may cause permanent damage to the mainboard. Please refer to the following steps to clear the CMOS:*

1. Unplug the AC power cable from your PC system
2. Put the mini jumper onto pin2 and pin3 of JP7 around 3~5 seconds and then return the mini jumper to its original position (pin1 and pin2).
3. Re-connect the AC power cable.

3.3 INSTALLING A CPU ONTO THE ZIF SOCKET

The ZIF type Socket located on U13 is the so called Socket 7. It is designed for the Pentium or other equivalent processors. inserting the Pentium processor onto the Socket 7, certain precautionary steps must be followed. The following diagrams will show you how to install the CPU step by step.

1. Make sure the ZIF socket level is up.

To raise the lever, pull it out to the side a little and raise it as far as it will go. Pin 1 is at the arm corner.

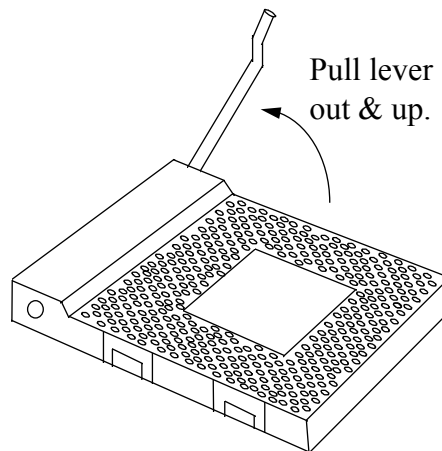

2. Align the CPU and socket pin 1 corners. Match the processor corner containing the blunt edge and the white dot to the socket corner with the distinctive pin arrangement. The pins on the bottom should align with the inner 3 rings of holes in the socket, then place the CPU in the socket. It should insert easily. If it doesn't, pull the level up a little more.

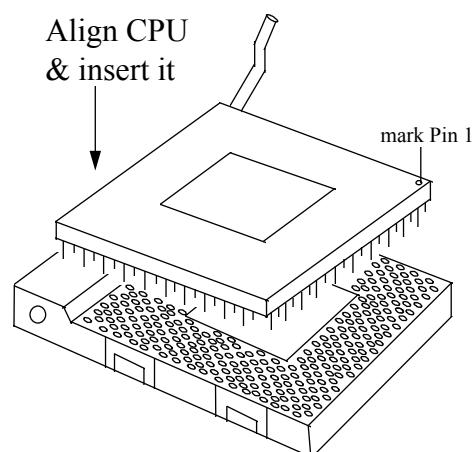

3. Press the lever down. The plate will slide forward. You will feel some resistance as the pressure starts to secure the CPU in the socket. When the CPU is installed, the lever should snap into place at the side of the socket.

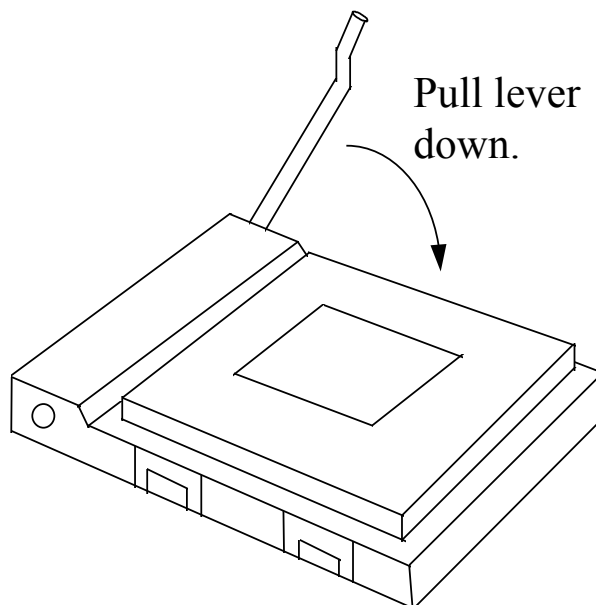

3.4 INSTALLATION OF CPU COOLING FAN

Improper installation of CPU cooling fan may cause serious damage to the motherboard. Please follow the procedures carefully:

1. There is a metal clip attached to the CPU cooler as shown below.

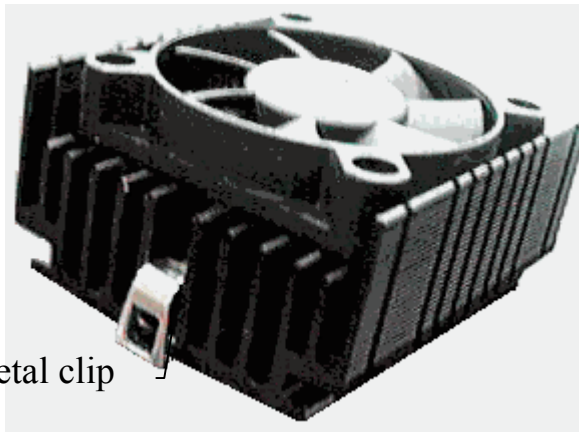

Metal clip

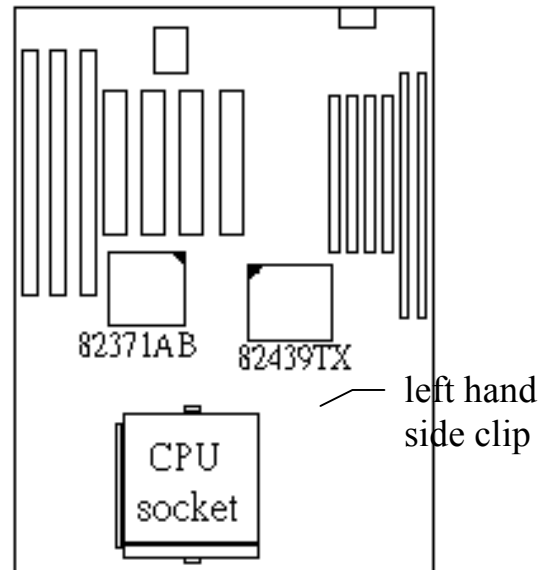

2. Place the CPU cooler squarely on the top of CPU.

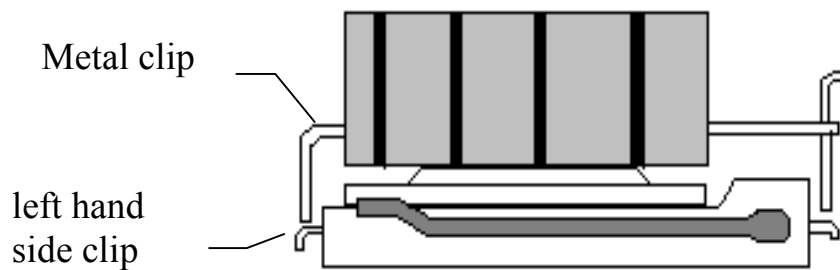

3. Hook the left hand side clip on the CPU socket first.

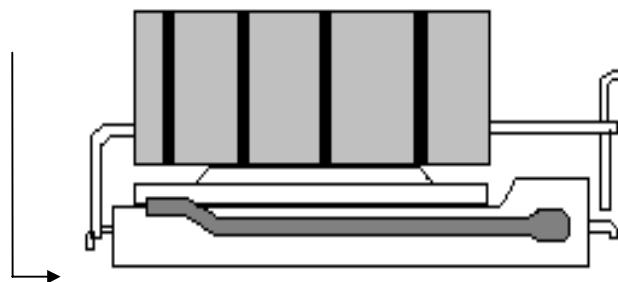

4. Push down the opposite side of the metal clip firmly and carefully to lock the cooler in place.

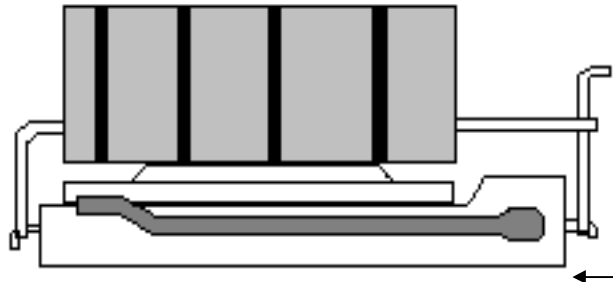

3.5 UPGRADING SYSTEM MEMORY

This mainboard can use up to four 72-pin SIMM sockets (SIMM1, SIMM2, SIMM3, SIMM4), and two 168-pin DIMM sockets (DIMM1, DIMM2). Upgradable from 8MB to 256MB.

3.5.1 Installing a SIMM module

1.

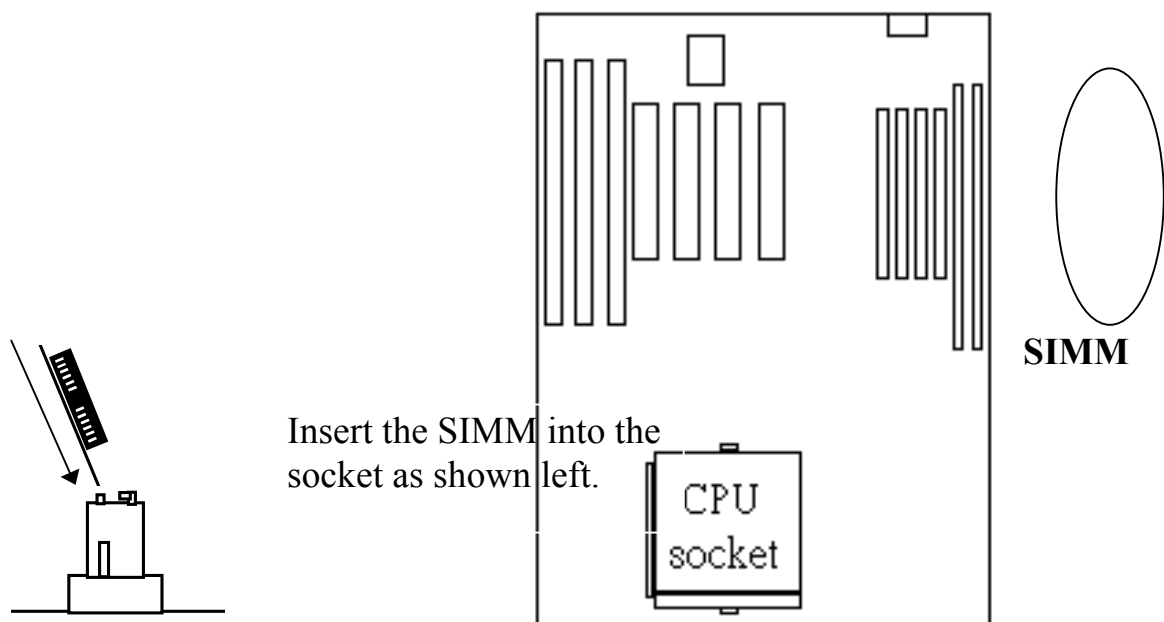

2.

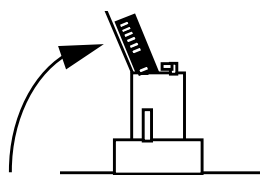

Press it forward onto the positioning pins.

3.

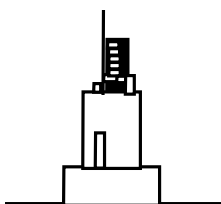

The retaining clips should fit over the edge and hold the SIMM in place.

3.5.2 Installing a DIMM Module

1.

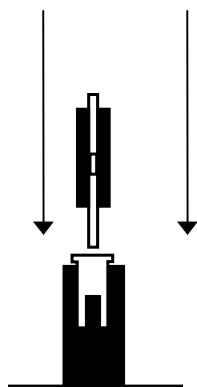

Insert the DIMM module into the socket as shown in the left picture.

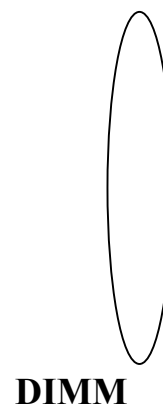
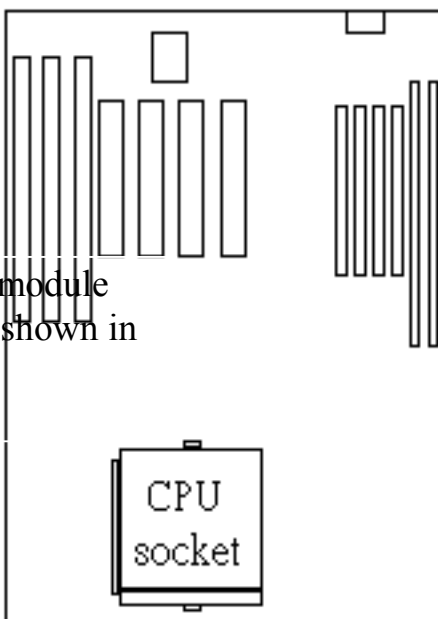

DIMM

2. Put out the DIMM module from the DIMM socket.

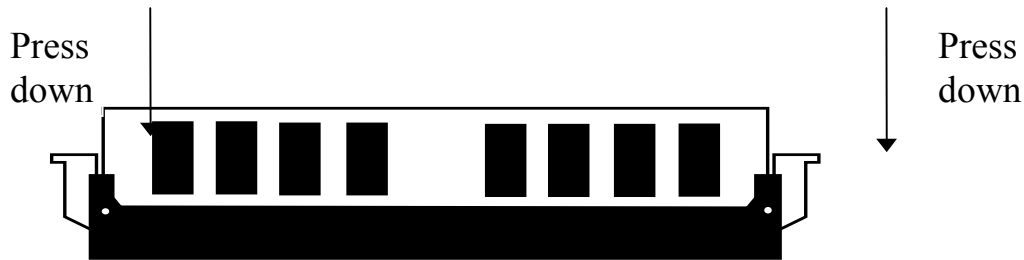

3.5.3 Memory Module Installing

The speed of FPM DRAMs must be either 70ns or faster than 70ns, the speed of EDO DRAMs and SDRAMs must be 60ns or faster than 60ns.

The DC voltage are different on SIMM and DIMM subsystem. Please refer to the followings for the details. Please make sure to check it with your memory module before you can install it on to the mainboard.

SIMMs' and DIMM's operating voltage :

- (1) SIMM1- SIMM4 : +5V DC
- (2) DIMM1- DIMM2 : +3.3V DC

In order to make the mainboard working, at least one bank of memory have to be installed on the board. The "BANK" is the definition of the memory subsystem addressing. Please refer to the following for the definition of "BANK"

BANK0: DIMM 1 or SIMM 1 plus SIMM 2
BANK1: DIMM 2 or SIMM 3 plus SIMM 4

According to what mentioned above, you can see DIMM1 has the same address space as SIMM1 and SIMM2. And DIMM2 has the same address space as SIMM3 and SIMM4. In other word, you can not install any memory module in SIMM1 and SIMM2 when you have the memory installed in DIMM1, the same to DIMM2 and SIMM3, SIMM4.

This mainboard supports EDO, FPM and SDRAM types of memory module. When installing memory modules, you don't have to start from Bank0 first. Basically, the memory can be populated on the board in any order and the system board will detect the memory installed on the board automatically.

So you can install a DIMM module onto either Bank0 or Bank 1 first and afterward you may upgrade your system memory by plugging in another DIMM module in the DIMM socket and need not to worry about the memory type which is installed on the board.

However, when you are installing the memory modules in the SIMM sockets, you have to make sure that the module must be the same type. The reason is because SIMM1 and SIMM2 are defined as Bank 0, SIMM3 and SIMM4 are defined as Bank1. Since the memory installed in the same bank must be the same type. So you will have to install two SIMM same modules in one single Bank to make the mainboard working.

There is no jumper required when you are installing memory modules onto the mainboard. The system BIOS will detect the DRAMs type and it's size automatically. However, you must be careful not to use SIMM and DIMM module at the same time.

Caution: Be sure not to use DIMM and SIMM module on the mainboard at the same time. The voltage requirement for DIMM and SIMM is different. If you mix these two types of module on the mainboard, the memory module can be damaged.

The following table provides the possible combinations for DRAM memory installation.

| Bank 0 | | Bank 1 | |
|-----------------|--------------|-----------------|--------------|
| SIMM1 and SIMM2 | DIMM1 | SIMM3 and SIMM4 | DIMM2 |
| Single-sided | Empty | Single-sided | Empty |
| Double-sided | Empty | Double-sided | Empty |
| Empty | Single-sided | Empty | Single-sided |
| Empty | Double-sided | Empty | Double-sided |

Note : Never install the 5V SIMM module and 3.3V DIMM module at the same time.

4. AWARD BIOS SETUP

4.1 GETTING STARTED

When the system is powered on or reset, the BIOS will execute the Power-On Self Test routines (POST) and checks the functionality of every component in the PC system. During the POST, you will see a copyright message on the screen followed by a diagnostics and initialization procedure. (If an EGA or VGA card is installed, the copyright message of the video card maybe displayed on the screen first.) When the system detects any error, it will gives a series of beeping sounds or display the error message on your screen.

Normally, figure 4-1 will be the screen display when the system is powered on.

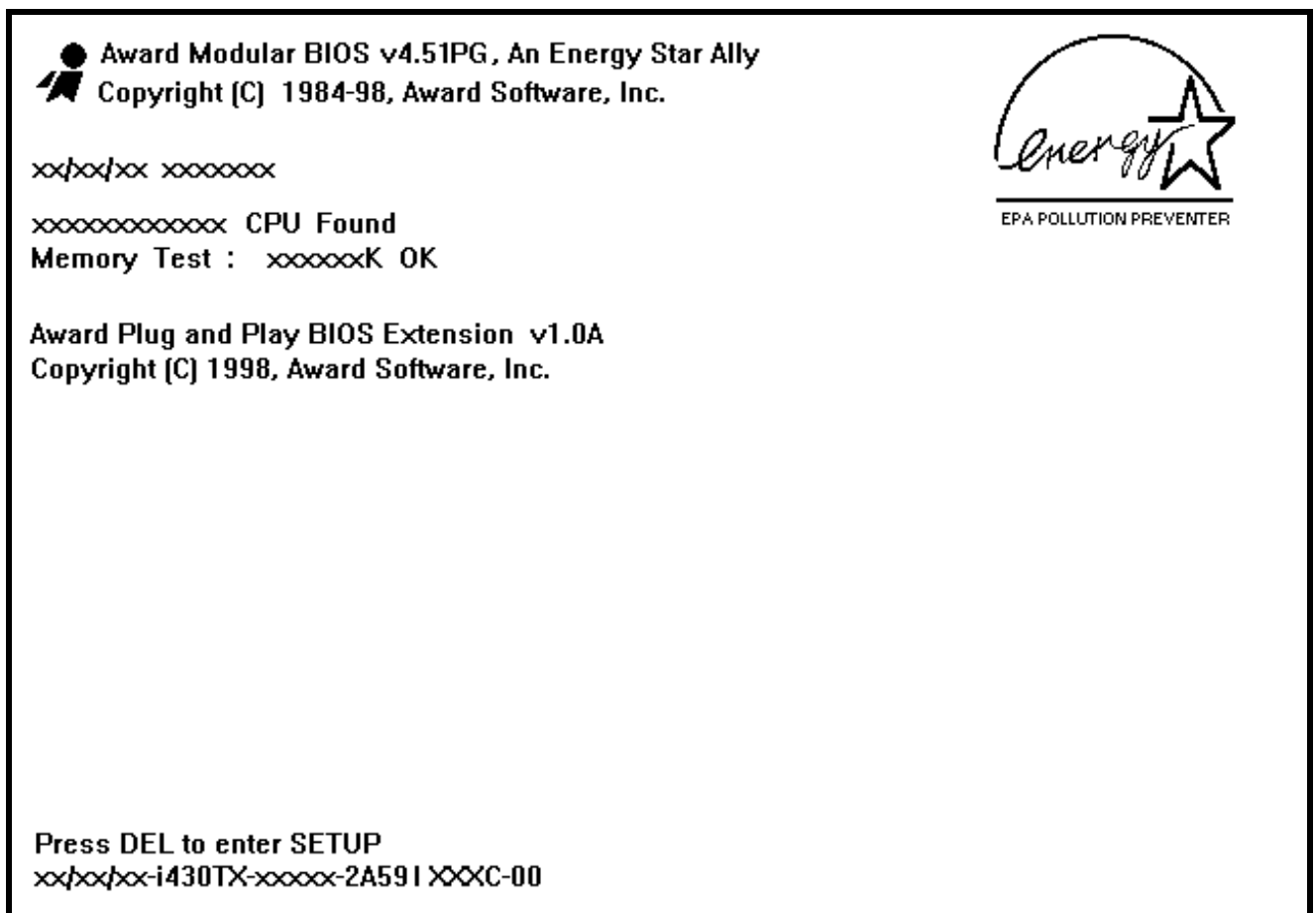

Fig. 4-1 Initial Power-On screen.

After the POST routines are completed, you will find the following message appears on the lower-left screen:

“ Press **DEL** to enter SETUP ”

To execute the Award BIOS Setup program, press the **DEL** key and the “MAIN MENU” of the BIOS setup utility as shown in Fig 4-2 will be triggered.

4.2 MAIN MENU

ROM PCI / ISA BIOS (2A59IXXX)
CMOS SETUP UTILITY
AWARD SOFTWARE, INC.

| | |
|--------------------------------|---------------------------|
| STANDARD CMOS SETUP | SUPERVISOR PASSWORD |
| BIOS FEATURES SETUP | USER PASSWORD |
| CHIPSET FEATURES SETUP | IDE HDD AUTO DETECTION |
| POWER MANAGEMENT SETUP | HDD LOW LEVEL FORMAT |
| PNP/PCI CONFIGURATION | SAVE & EXIT SETUP |
| INTEGRATED PERIPHERALS | EXIT WITHOUT SAVING |
| LOAD SETUP DEFAULTS | |
| ESC : Quit | ↑↓←→ : Select Item |
| F10 : Save & Exit Setup | (Shift) F2 : Change Color |
| Time, Date, Hard Disk Type ... | |

Fig. 5-2 CMOS SETUP MAIN MENU screen.

CONTROL KEYS

Listed below is the explanation of the keys displayed at the bottom of the screens accessed through the BIOS SETUP program :

- Arrow Keys** : Use the arrow keys to move the cursor to the desired item.
- Enter** : To select the desired item.
- F1** : Display the help screen for the selected feature.
- (Shift)F2** : To change the screen color, total 16 colors.
- ESC** : Exit to the previous screen.
- PgUp(-)/PgDn(+)** : To modify the default value of the options for the highlighted feature.
- F5** : Retrieves the previous CMOS values from CMOS, only for the current option page setup menu.
- F7** : Loads the SETUP default values from BIOS default table, only for the current option page setup menu.
- F10** : Save all changes made to CMOS RAM, only for the MAIN MENU.

The following pages will show the figure of each CMOS SETUP screen, each figure contains the selection fields and its default settings. There are the function descriptions for commonly used settings at the bottom of some screen display.. If you are not quite sure of the setting details, please contact with your supplier for the detail function.

4.3 STANDARD CMOS SETUP

ROM PCI / ISA BIOS (2A59IXXX)
STANDARD CMOS SETUP
AWARD SOFTWARE, INC.

| Date (mm : dd : yy) Fri Feb 13 1998 | | | | | | | | |
|--|--------------------------|----------------------------|------|------|---------|-------|--------|-------|
| Time (hh : mm : ss) : 08 : 35 : 45 | | | | | | | | |
| HARD DISKS | TYPE | SIZE | CYLS | HEAD | PRECOMP | LANDZ | SECTOR | MODE |
| Primary Master | Auto | 0 | 0 | 0 | 0 | 0 | 0 | Auto |
| Primary Slave | None | 0 | 0 | 0 | 0 | 0 | 0 | ----- |
| Secondary Master | Auto | 0 | 0 | 0 | 0 | 0 | 0 | Auto |
| Secondary Slave | None | 0 | 0 | 0 | 0 | 0 | 0 | ----- |
| Drive A : 1.44M, 3.5 in. | | Base Memory : 640 K | | | | | | |
| Drive B : None | | Extended Memory : xxxxxx K | | | | | | |
| Floppy 3 Mode Support : Disabled | | Other Memory : xxxxxx K | | | | | | |
| Video : EGA/VGA | | Total Memory : xxxxxx K | | | | | | |
| Halt On : All Errors | | | | | | | | |
| ESC : Quit | ↑↓←→ : Select Item | PU/PD/+/- : Modify | | | | | | |
| F1 : Help | (Shift)F2 : Change Color | | | | | | | |

Fig. 5-3 STANDARD CMOS SETUP screen.

MODE:

For IDE hard disks, this BIOS provides three modes to support both normal size IDE hard disks and also disks size larger the 528MB :

- **NORMAL** : For IDE hard disks size smaller then 528MB.
- **LBA** : For IDE hard disks size larger then 528MB and up to 8.4GB (Giga Bytes) that use Logic Block Addressing (LBA) mode.
- **Large** : For IDE hard disks size larger then 528MB that do not use LBA mode. Large mode is a new specification which may not be fully supported by all operation systems. Now it can only be used with the MS-DOS and is uncommon.

Note : Some OS (like SCO-UNIX) have to select the "NORMAL" mode when installation.

4.4 BIOS FEATURES SETUP

ROM PCI / ISA BIOS (2A59IXXX)
 BIOS FEATURES SETUP
 AWARD SOFTWARE, INC.

| | | | |
|-----------------------------|------------|--------------------------|--------------------|
| Virus Warning | : Disabled | Video BIOS Shadow | : Enabled |
| CPU Internal Cache | : Enabled | C8000-CBFFF Shadow | : Disabled |
| External Cache | : Enabled | CC000-CFFFF Shadow | : Disabled |
| Quick Power On Self Test | : Enabled | D0000-D3FFF Shadow | : Disabled |
| Boot Sequence | : A,C,SCSI | D4000-D7FFF Shadow | : Disabled |
| Swap Floppy Drive | : Disabled | D8000-DBFFF Shadow | : Disabled |
| Boot Up Floppy Seek | : Enabled | DC000-DFFFF Shadow | : Disabled |
| Boot Up NumLock Status | : On | | |
| Boot Up System Speed | : High | | |
| Gate A20 Option | : Fast | | |
| Typematic Rate Setting | : Disabled | | |
| Typematic Rate (Chars/Sec) | : 6 | | |
| Typematic Delay (Msec) | : 250 | | |
| Security Option | : Setup | | |
| PCI/VGA Palette Snoop | : Disabled | | |
| OS Select For DRAM > 64MB | : Non-OS2 | ESC : Quit | ↑↓←→ : Select Item |
| PS/2 mouse function control | : Enabled | F1 : Help | PU/PD/+/- : Modify |
| | | F5 : Old Values (Shift) | F2 : Color |
| | | F7 : Load Setup Defaults | |

Fig. 4-4 BIOS FEATURES SETUP screen.

Virus Warning : (Default values is “Disabled”)

In order to avoid virus infection happens on your PC system, PT-6IL provides the virus warning features in the BIOS. During and after the operation system is loaded, any attempt to write to the boot sector or partition table on the IDE hard disk drive will trigger this feature and give you some warning messages on the screen and then halt the system. When you find the message on your screen, please run an anti-virus program to see whether your system is infected by a virus or not.

Enabled : Activate automatically when the system boots up causing a warning message to appear on the screen when anything attempts to access the boot sector of the hard disk partition table.

Disabled : No warning message to appear when anything attempts to access the boot sector or hard disk partition table.

CPU Internal Cache :

There is the cache memory in the CPU itself and we call it the L1 cache. You can use the BIOS setup program to enable or disable CPU's internal (L1) cache memory. If you want to use the internal (L1) cache memory, you can use this option to enable or disable the cache memory.

External Cache :

Beside the cache memory inside the CPU, there is still the secondary cache memory on the mainboard and we call it L2 cache. You can change the setting in this field to enable or disable the L2 (secondary) external cache memory. If there is no external cache memory on board you must set this option to "disabled", otherwise, your PC system will not be working normally.

4.5 CHIPSET FEATURES SETUP

ROM PCI / ISA BIOS (2A59IXXX)
CHIPSET FEATURES SETUP
AWARD SOFTWARE, INC.

| | | | |
|---------------------------|------------------|---------------------------|-----------------------|
| Auto Configuration | : Enabled | <i>CPU Type</i> | : <i>Intel P55C</i> |
| DRAM Timing | : 60 ns | <i>CPU Vcore</i> | : <i>2.80V</i> |
| DRAM Leadoff Timing | : 10/6/3 | <i>CPU Speed</i> | : <i>166 (66*2.5)</i> |
| DRAM Read Burst (EDO/FP) | : x222/x333 | Auto Detect DIMM/PCI Clk | : Enabled |
| DRAM Write Burst Timing | : x222 | Spread Spectrum | : Disabled |
| Fast EDO Lead Off | : Enabled | CPU Warning Temperature | : Disabled |
| Refresh RAS# Assertion | : 4 Clks | Current CPU Temperature | : 29°C/84°F |
| Fast RAS To CAS Delay | : 3 | Current CPUFAN1 Speed | : 0 RPM |
| DRAM Page Idle Timer | : 2Clks | Current CPUFAN2 Speed | : 0 RPM |
| DRAM Enhanced Paging | : Enabled | Current Vin(V) | : 2.81V |
| Fast MA to RAS# Delay | : 2 Clks | | |
| SDRAM(CAS Lat/RAS-to-CAS) | : 3/3 | | |
| SDRAM Speculative Read | : Disabled | | |
| System BIOS Cacheable | : Disabled | ESC : Quit | ↑↓←→ : Select Item |
| Video BIOS Cacheable | : Disabled | F1 : Help | PU/PD/+/- : Modify |
| 8 Bit I/O Recovery Time | : 1 | F5 : Old Values (Shift)F2 | : Color |
| 16 Bit I/O Recovery Time | : 2 | F7 : Load Setup Defaults | |
| Memory Hole At 15M-16M | : Disabled | | |
| PCI 2.1 Compliance | : Disabled | | |

Fig. 4-5 CHIPSET FEATURES SETUP screen.

WARNING : The “CHIPSET FEATURES SETUP” on this screen are provided for the professional technician who can modify the Chipset features to meet some specific requirement. If you do not have the related technical background, do not attempt to make any change except the following items.

NOTE :

* **CPU Type: IDT-C6**

CPU Vcore: 3.5V

CPU Speed: 180 (60*3)

IDT-C6 CPU: The system BIOS only supports 3.5V, if your IDT-C6 CPU Vcore voltage is not 3.5V DC, please page 3-14 and select the correct CPU Vcore voltage.

AMD K6 CPU:

The system BIOS provides 2.9V and 3.2V DC for AMD K6 CPU. Followings are the table for the reference settings:.

| CPU TYPE | CPU Vcore | CPU Speed: |
|---------------|-----------|-------------|
| AMD K6/PR-166 | 2.9V DC | 66MHz * 2.5 |
| AMD K6/PR-200 | 2.9V DC | 66MHz * 3 |
| AMD K6/PR-233 | 3.2V dc | 66MHz * 3.5 |

The default setting is 2.9V in the BIOS for the AMD CPU. If your AMD CPU (for example, the AMD K6/PR-233) is not 2.9V, you will have to select Vcore voltage so that it will work normally. Please use the PgUp or PgDn key to the “CPU Vcore” field and select correct voltage for your CPU.

Cyrix 6x86 CPU:

The system BIOS provides 3.4V and 3.5V DC for Cyrix CPU please refer to the following information to select the speed and voltage for your Cyrix CPU..

| | |
|-----------|--------------|
| CPU Type | Cyrix 6x86 |
| CPU Vcore | 3.5V DC |
| CPU Speed | P166+ (66*2) |

The CPU Vcore default values is “3.5V” for the Cyrix CPU. If your Cyrix CPU Vcore voltage is not 3.5V, please use the PgUp or PgDn key to the “CPU Vcore” field and select correct voltage for your CPU

Auto Configuration :

When “Enabled”, the system BIOS will load the optimum parameters which is stored in the BIOS table. Enable the “Auto Configuration” is recommended because it will use these default parameters to configure the chipset and decide the memory access time to make the mainboard working normally.

If you select “Disabled”, you can change the chipset parameters and decide the features of the system devices like DRAM, SRAM ... etc. Basically, it is not recommended to users who do not have the technical background. Improper setting may cause system unstable. So please that you know the purpose of the setting before you can proceed. (If the system hangs after you change the settings, you can use JP7 to clear the CMOS setting and the system BIOS will load the default setting to get the PC system back to normal.)

DRAM Timing :

When “Auto Configuration” is “Enabled”, you will find there are two DRAM timing suggested – 60ns and 70ns. In the “DRAM Timing” field, you can use the **PgUp** or **PgDn** key to toggle between 60ns and 70ns and the DRAM parameters below will be changed accordingly. Basically, 60ns will let you have better system performance but you have to make sure that your DRAM modules are fast enough before you can choose this option.

Basically, 70ns is recommended, the system performance will be decreased slightly but it works with most memory modules. If you are not sure what type of memory module you are going to install to the mainboard, select 70ns for your memory subsystem.

4.6 POWER MANAGEMENT SETUP

ROM PCI / ISA BIOS (2A59IXXX)
 POWER MANAGEMENT SETUP
 AWARD SOFTWARE, INC.

| | | | |
|----------------------|----------------|----------------------------------|--------------------|
| Power Management | : User Define | ** Reload Global Timer Events ** | |
| PM Control by APM | : Yes | IRQ[3-7 , 9-15], NMI | : Enabled |
| Video Off Method | : Blank Screen | Primary IDE 0 | : Disabled |
| Video Off After | : Standby | Primary IDE 1 | : Disabled |
| MODEM Use IRQ | : 3 | Secondary IDE 0 | : Disabled |
| Doze Mode | : Disabled | Secondary IDE 1 | : Disabled |
| Standby Mode | : Disabled | Floppy Disk | : Disabled |
| Suspend Mode | : Disabled | Serial Port | : Enabled |
| HDD Power Down | : Disabled | Parallel Port | : Disabled |
| VGA Active Monitor | : Enabled | | |
| Soft-Off by PWR-BTTN | : Delay 4 Sec. | | |
| Resume by Ring | : Enabled | | |
| Resume by Alarm | : Disabled | | |
| IRQ 8 Break Suspend | : Disabled | ESC : Quit | ↑↓←→ : Select Item |
| | | F1 : Help | PU/PD/+/- : Modify |
| | | F5 : Old Values | (Shift)F2 : Color |
| | | F7 : Load Setup Defaults | |

Fig. 4-6 POWER MANAGEMENT SETUP screen.

WARNING : *The “POWER MANAGEMENT SETUP” fields on this screen are provided for the professional technician who can modify the Chipset features to meet some specific requirement. If you do not have the related technical background, do not attempt to make any change except the following items.*

Power management : . (default setting “User Define”).

This setting controls the Power Management functions which is provided on the mainboard. This mainboard comply with the GREEN PC standard and it provides several power saving features. For example, you can slow or stop the CPU if you do not to use the PC system for some while. The PC system will tell your monitor to “sleep” when it “feels” that you are not using your PC system. The major purpose of the power management is to save the power consumption when you do not use the PC system. There is only one earth and it is still GREEN so far, so please try your best to utilize the power saving feature provided on the board so that our planet will stay GREEN and won’t be deserted..

There are three different power saving modes available on the board, they are “**User Define**”, “**Min Saving**” and “**Max Saving**” modes, please refer to the followings for the details.

“User Define”:

This allows you to select the setting in each field to define the power saving mode. When you select the “**User Define**” mode, you can select your personal settings in **Doze mode, Standby Mode, Suspend Mode and Power Down modes**.

“Min Saving” and “Max Saving”

If you do not know how to use the “**User Define**” to select the power saving modes, you can select the “**Min Saving**” or “**Max Saving**” mode and it will define the power saving parameters for you.

4.7 PNP/PCI CONFIGURATION

ROM PCI / ISA BIOS (2A59IXXX)
PNP/PCI CONFIGURATION
AWARD SOFTWARE, INC.

| | | | |
|--------------------------|---------------|--------------------------|--------------------|
| PNP OS Installed | : No | PCI IDE IRQ Map To | : PCI-AUTO |
| Resources Controlled By | : Manual | Primary IDE INT# | : A |
| Reset Configuration Data | : Disabled | Secondary IDE INT# | : B |
| IRQ-3 assigned to | : Legacy ISA | Used MEM base addr | : N/A |
| IRQ-4 assigned to | : Legacy ISA | | |
| IRQ-5 assigned to | : PCI/ISA PnP | | |
| IRQ-7 assigned to | : Legacy ISA | | |
| IRQ-9 assigned to | : PCI/ISA PnP | | |
| IRQ-10 assigned to | : PCI/ISA PnP | | |
| IRQ-11 assigned to | : PCI/ISA PnP | | |
| IRQ-12 assigned to | : Legacy ISA | | |
| IRQ-14 assigned to | : Legacy ISA | | |
| IRQ-15 assigned to | : Legacy ISA | | |
| DMA-0 assigned to | : PCI/ISA PnP | | |
| DMA-1 assigned to | : PCI/ISA PnP | ESC : Quit | ↑↓←→ : Select Item |
| DMA-3 assigned to | : PCI/ISA PnP | F1 : Help | PU/PD/+/- : Modify |
| DMA-5 assigned to | : PCI/ISA PnP | F5 : Old Values | (Shift)F2 : Color |
| DMA-6 assigned to | : PCI/ISA PnP | F7 : Load Setup Defaults | |
| DMA-7 assigned to | : PCI/ISA PnP | | |

Fig. 4-7 PNP/PCI CONFIGURATION setup screen.

WARNING : *The settings on this screen are provided for the professional technician who can modify the Chipset features to meet some specific requirement. If you do not have the related technical background, do not attempt to make any change except the following items.*

Resources Controlled by :

Manual : The system BIOS will not refer to the ESCD data to assign IRQ & DMA. Instead, it will refer to the information recorded in this field when assigning the IRQ & DMA resource. (anyhow, the system BIOS will always refer to the ESCE data to assign the I/O and memory space resources).

Auto : The system BIOS will refer to the ESCD segment for all legacy information.

Reset Configuration Data :

Disabled : The system BIOS will do nothing.

Enabled : The system BIOS will clear/reset the ESCD which is stored in the Flash ROM during the Power On Self Test (POST). When the ESCD data is cleared, the system BIOS will change this field back to “Disable” so that the ESCD data will be valid.

IRQ # / DMA # assigned to :

There are only 15 IRQs and 8 DMAs available on the mainboard and most of them are assigned for some specific purposes. Sometimes, user may feel like to have some more IRQ and DMA in order to install the new add on cards. In this case, you may use this field to assign some certain IRQ and DMA to “PCI/ISA PnP” so that the new add on card will find the free IRQ or DMA available for it.

Legacy ISA The system BIOS will skip and never assign the specified IRQ/DMA resource to PCI or ISA PnP devices and the IRQ and DMA can only be used by their specified Legacy ISA cards.

PCI/ISA PnP When the “PCI/ISA PnP” is been selected, the related IRQ and DMA will be released and they can be used by other PCI or ISA devices. Whenever there is the new PCI or ISA devices plugged onto the mainboard, the system BIOS will detect it and assign a free IRQ or DMA for the new devices.

.Note: Most IRQ and DMA have its own purpose and they can not be assigned to “PCI/ISA PnP”. For example, IRQ14 and IRQ15 is used by the onboard IDE device. If you change the setting on IRQ14 and IRQ15, you will be unable to connect the hard disk drive or CD ROM drive to the IDE interface on the mainboard. So please make sure to check the IRQ and DMA assignment in your system before you proceed to do the setting. For instance, if you do not have the printer (IRQ7) or PS/2™ mouse (IRQ12) connected to your PC system, you may assign IRQ7 and IRQ12 to “PCI/ISA PnP” so that you can have more IRQs available for new add on cards.

PCI IDE IRQ Map To : (for off-board PCI IDE cards)

PCI-AUTO : The BIOS will scan and detect the existing of the PCI IDE devices and try to locate the position where is the PCI IDE device, and the system BIOS will assign IRQ 14 for the primary IDE device, and assign IRQ 15 for secondary IDE device.

ISA : The BIOS will not assign any IRQ even when the system BIOS detects the PCI IDE card installed on the PCI slots. The reason is because some certain IDE cards will connect the IRQ14 and IRQ15 directly from the ISA slot and have them occupied. (such card is called Legacy Header)

PCI-SLOT1 To PCI-SLOT4 : In this field, you can tell the system BIOS to assign IRQ14 for the primary IDE and IRQ for the secondary IDE on some certain PCI slot. Under the normal condition, this selection is not recommended because the IDE interfaces are already built on the mainboard.

Used MEM base addr and Used MEM Length :

These fields are used for some special ISA legacy cards which will request memory space below 1M address. Please refer to the user's manual of your add on card to find whether it will need such memory space. If your add on card does need to have such memory space, please point out the memory address and its length of the legacy area in this field. According to what is recorded in this field, BIOS will skip the UMB area that is used by the legacy device to avoid the memory conflicting.

Note : No matter what is defined in the "Resources Controlled By" field ("Manual" or "Auto"), the system BIOS will always assign IRQ resources to PCI devices from the highest one first (ie. IRQ15, 14, 13 ...) while assign IRQ resources to ISA PnP devices from the lowest one first (ie. IRQ3,4,5 ..).

Explanation for technical issues :**PnP device :**

- Device that has Plug & Play compatibility. That means it will request for DMA, IRQ, I/O and Memory from the PnP BIOS and all these requests can be re-locatable. In other words, these devices do not utilize any fixed resources.
- All PCI devices and all ISA PnP devices are PnP devices.

Legacy device :

- A legacy device is a device that all its resources are fixed by hardware (or selected by jumpers).
- All ISA Non-PnP devices are legacy device.

Extended System Configuration Data (ESCD) :

- A media between the user and the system BIOS for passing the legacy devices information's. This information is stored in the onboard NVRAM (flash ROM).

4.8 INTEGRATED PERIPHERALS

ROM PCI/ISA BIOS (2A59IXXX)
INTEGRATED PERIPHERALS
AWARD SOFTWARE, INC.

| | | | |
|---------------------------|---------------|-----------------------|-----------------------|
| IDE HDD Block Mode | : Enabled | UART Mode Select | : Normal |
| IDE Primary Master PIO | : Auto | | |
| IDE Primary Slave PIO | : Auto | | |
| IDE Secondary Master PIO | : Auto | Onboard Parallel Port | : 378 / IRQ 7 |
| IDE Secondary Slave PIO | : Auto | Parallel Port Mode | : SPP |
| IDE Primary Master UDMA | : Auto | | |
| IDE Primary Slave UDMA | : Auto | | |
| IDE Secondary Master UDMA | : Auto | | |
| IDE Secondary Slave UDMA | : Auto | | |
| On-Chip Primary PCI IDE | : Enabled | | |
| On-Chip Secondary PCI IDE | : Enabled | | |
| USB Keyboard Support | : Disabled | | |
| | | ESC | : Quit |
| | | F1 | : Help |
| | | F5 | : Old Values |
| | | F7 | : Load Setup Defaults |
| Onboard FDC Controller | : Enabled | ↑↓←→ | : Select Item |
| Onboard Serial Port 1 | : 3F8 / IRQ 4 | PU/PD/+/- | : Modify |
| Onboard Serial Port 2 | : 2F8 / IRQ 3 | (Shift)F2 | : Color |

Fig. 4-8 INTEGRATED PERIPHERALS setup screen.

WARNING : *The settings on this screen are provided for the professional technician who can modify the Chipset features to meet some specific requirement. If you do not have the related technical background, do not attempt to make any change except the following items.*

UART 2 Mode :

This setting determines the IR port (CN6) function mode. Supports both HPSIR and ASKIR.

Onboard Parallel Mode :

This setting determines the onboard parallel port (CN11) transmission mode. It supports four different modes: SPP, EPP, ECP, or ECP+EPP.

4.9 LOAD SETUP DEFAULTS

If you lost the CMOS data or you don't know how to complete the setup procedure, you may use this option to load the SETUP default values from the BIOS default table. It is easy to load the default value, simply highlight the "LOAD SETUP DEFAULTS" field and then press the "Enter" key, when you see the "LOAD SETUP DEFAULTS (Y/N)" displayed on the screen, response to it with "Y" and then press the "Enter" key. the SETUP default values will be loaded. Basically, the SETUP default settings are the best-case values that will optimize system performance and increase system stability.

In case that the CMOS data is corrupted, the SETUP DEFAULTS settings will be loaded automatically when you press the "Del" key and enter the main setup screen. So you may select "SAVE & EXIT SETUP" to leave setup program and the system is loaded with the default settings.

4.10 SUPERVISOR PASSWORD / USER PASSWORD

The "SUPERVISOR PASSWORD" and "USER PASSWORD" will be used to check the authority when power-on. Whenever there is the password stored in either of these fields, the correct password will be requested so that the PC system will continue to load the operation system.

You can enter up to eight alphanumeric characters here. When you have typed in the password and pressed the "Enter" key, you will be asked to reconfirm your password again to complete password setup. If you press the "Enter" key twice without any alphanumeric character entered, the PASSWORD will be disabled.

If the "User Password" and the "Supervisor Password" are both enabled and they have different password setup, "Supervisor Password" is always has the higher priority, Basically, an "User" is only authorized to change the content of "User Password", while a "Supervisor" has the authorization to dominate all settings.

In order to make the IDE hard disk known to the system, you need to tell the system what kind of hard disk is connected to the mainboard by giving a set of hard disk parameters. Sometimes it is not easy for users to find the proper parameters for their IDE hard disk drive. In order to help users to find the parameters, the system BIOS provides a convenient way – the auto detection of IDE hard disk drive.

To run the auto detection program is extremely easy. Move the selection bar to “IDE HDD AUTO DETECTION” and then press “Enter”, the system BIOS take over the job and try to detect the type of IDE hard disk. If it succeeds, you will see a list of hard disk with its related parameters. You may press on the “Y” key (or select one of the hard disk type listed on the screen). The system BIOS will transfer the parameters to the corresponding fields in the STANDARD CMOS SETUP menu and you have completed the IDE hard disk setup.

4.11 HDD LOW LEVEL FORMAT

This option provides an utility program for IDE HDD Low Level Format. Performing the Hard Disk low lever Format will destroy any data on the Hard Disk. Please make sure to back up the Hard Disk(s) before actually performing of these routines.

*Note : These routines are not valid for a **SCSI** Disk Drive.*

4.12 SAVE &EXIT SETUP

This option will save all setup values to CMOS RAM & EXIT SETUP routine. By moving the selection bar to “SAVE & EXIT SETUP” and press the “Enter” key, and then response with “Y” and “Enter” key to the confirming message displayed on the screen. The values will be saved and all the information will be stored in the CMOS memory, and then the setup program will be terminated and the system will start to reboot.

4.13 EXIT WITHOUT SAVING

This item exit the setup routine without saving any changed values to CMOS RAM, When you do not want to save your change to the CMOS memory, you may choose to run this option and the setting what you made in the BIOS setup routine will be given away.

Move the selection bar to “EXIT WITHOUT SAVING” and click on the “Enter” key, then you will be asked to confirm the action to exit, press the “Y” and “Enter” key, the setup program will be terminated and the system will start to reboot.