



P/I-P55SP4V Motherboard

USER'S MANUAL

USER'S NOTICE

No part of this product, including the product and software may be reproduced, transmitted, transcribed, stored in a retrieval system, or translated into any language in any form by any means without the express written permission of ASUSTeK COMPUTER INC. (hereinafter referred to as ASUS) except documentation kept by the purchaser for backup purposes.

ASUS provides this manual "as is" without warranty of any kind, either express or implied, including but not limited to the implied warranties or conditions of merchantability or fitness for a particular purpose. In no event shall ASUS be liable for any loss or profits, loss of business, loss of use or data, interruption of business, or for indirect, special, incidental, or consequential damages of any kind, even if ASUS has been advised of the possibility of such damages arising from any defect or error in this manual or product. ASUS may revise this manual from time to time without notice.

Products mentioned in this manual are mentioned for identification purposes only. Product names appearing in this manual may or may not be registered trademarks or copyrights of their respective companies.

The product name and revision number are both printed on the board itself. Manual revisions are released for each board design represented by the digit before and after the period of the manual revision number. Manual updates are represented by the third digit in the manual revision number. For updated BIOS, drivers, or product release information you may visit ASUS' home page at: <http://www.asus.com.tw/>

© Copyright 1996 ASUSTeK COMPUTER INC. All rights reserved.

Product Name:	P/I-P55SP4V
Manual Revision:	1.72
Release Date:	December 1996

ASUS CONTACT INFORMATION

ASUSTeK COMPUTER INC.

Marketing Info:

Address: 150 Li-Te Road, Peitou, Taipei, Taiwan, ROC
Telephone: 886-2-894-3447
Fax: 886-2-894-3449
Email: info@asus.com.tw

Technical Support:

Fax: 886-2-895-9254
BBS: 886-2-896-4667
Email: tsd@asus.com.tw
WWW: <http://www.asus.com.tw/>
Gopher: gopher.asus.com.tw
FTP: ftp.asus.com.tw/pub/ASUS

ASUS COMPUTER INTERNATIONAL

Marketing Info:

Address: 721 Charcot Avenue, San Jose, CA 95131, USA
Telephone: 1-408-474-0567
Fax: 1-408-474-0568
Email: info-usa@asus.com.tw

Technical Support:

BBS: 1-408-474-0569
Email: tsd-usa@asus.com.tw

ASUS COMPUTER GmbH

Marketing Info:

Address: Harkort Str. 25, 40880 Ratingen, BRD, Germany
Telephone: 49-2102-445011
Fax: 49-2102-442066
Email: info-ger@asus.com.tw

Technical Support:

BBS: 49-2102-448690
Email: tsd-ger@asus.com.tw

CONTENTS

I. INTRODUCTION	1
How this manual is organized	1
Item Checklist	1
Features of This Motherboard	2
II. FEATURES	2
Parts of the Motherboard	3
III. INSTALLATION	4
Map of the Motherboard	4
Jumpers	5
Expansion Slots	5
Connectors	5
Installation Steps	6
1. Jumpers	6
Jumper Settings	7
Cyril CPU Identification	11
2. System Memory (DRAM & SRAM)	12
DRAM Memory Installation Procedures:	13
3. Central Processing Unit (CPU)	15
4. Expansion Cards	16
Expansion Card Installation Procedure:	16
Assigning IRQs for Expansion Cards	16
Assigning DMA Channels for ISA Cards	17
ASUS MediaBus Card	18
5. External Connectors	19
Power Connection Procedures	25
Support Software	25
The Flash Memory Writer Utility Screen:	26
IV. BIOS SOFTWARE	26
Flash Memory Writer Utility	26
6. BIOS Setup	29
Load Defaults	30
Standard CMOS Setup	30
Details of Standard CMOS Setup:	31
BIOS Features Setup	34
Details of BIOS Features Setup:	34
Chipset Features Setup	37
Details of Chipset Features Setup:	37
Power Management Setup	39
Details of Power Management Setup:	40
PNP and PCI Setup	42
Details of PNP and PCI Setup:	42
Load BIOS Defaults	44
Load Setup Defaults	44

CONTENTS

Supervisor Password and User Password	45
IDE HDD Auto Detection	46
Save and Exit Setup	47
Exit Without Saving	47
V. DESKTOP MANAGEMENT	49
Desktop Management Interface (DMI)	49
Introducing the ASUS DMI Configuration Utility	49
System Requirements	49
Using the ASUS DMI Configuration Utility	50
Notes:	50
VI. PCI-SC200 SCSI Card	53
NCR SCSI BIOS and Drivers	53
The PCI-SC200 SCSI Interface Card	54
Setting Up the PCI-SC200	54
Setting the INT Assignment	55
Terminator Settings	55
SCSI ID Numbers	56
VII. I-A16C Audio Card	57
I-A16C Audio Features	57
Unpacking and Handling Precautions	57
Layout and Connectors	58
Connectors	58
Video Software Manual	59
VIII. DOS UTILITY	61
DOS Utility	61
1. SVGAUTL.EXE	61
2. Video Modes	63
IX. SOFTWARE DRIVERS	68
Software Drivers	68
1. Windows 3.1	69
2. Windows 95	77
3. Windows NT 3.1	80
4. Windows NT 3.5, 3.51, & 4.0	80
5. Autodesk ADI 4.2 -Protected Mode	82
6. OS/2 V2.1	88
7. OS/2 V3.0 (Warp)	89
8. Double Bytes OS/2 Warp	90
X. DOS 3.1 & Windows 3.1x Audio Software (with optional I-A16C Audio Card Bundle Only)	
XI. Windows 95 Audio Software (with optional I-A16C Audio Card Bundle Only)	

FCC & DOC COMPLIANCE

Federal Communications Commission Statement

This device complies with FCC Rules Part 15. Operation is subject to the following two conditions:

- This device may not cause harmful interference, and
- This device must accept any interference received, including interference that may cause undesired operation.

This equipment has been tested and found to comply with the limits for a Class B digital device, pursuant to Part 15 of the FCC Rules. These limits are designed to provide reasonable protection against harmful interference in a residential installation. This equipment generates, uses and can radiate radio frequency energy and, if not installed and used in accordance with manufacturer's instructions, may cause harmful interference to radio communications. However, there is no guarantee that interference will not occur in a particular installation. If this equipment does cause harmful interference to radio or television reception, which can be determined by turning the equipment off and on, the user is encouraged to try to correct the interference by one or more of the following measures:

- Re-orient or relocate the receiving antenna.
- Increase the separation between the equipment and receiver.
- Connect the equipment to an outlet on a circuit different from that to which the receiver is connected.
- Consult the dealer or an experienced radio/TV technician for help.

WARNING: The use of shielded cables for connection of the monitor to the graphics card is required to assure compliance with FCC regulations. Changes or modifications to this unit not expressly approved by the party responsible for compliance could void the user's authority to operate this equipment.

Canadian Department of Communications Statement

This digital apparatus does not exceed the Class B limits for radio noise emissions from digital apparatus set out in the Radio Interference Regulations of the Canadian Department of Communications.

I. INTRODUCTION

How this manual is organized

This manual is divided into the following sections:

- I. Introduction:** Manual information and checklist
- II. Features:** Information and specifications
- III. Installation:** Instructions on setting up the motherboard
- IV. BIOS Setup:** BIOS software setup information
- V. DMI Utility:** BIOS supported Desktop Management Interface
- VI. PCI-SC200:** Installation of an optional SCSI card
- VII. I-A16C:** Installation of an optional Audio card
- VIII. SiS Video:** Installation and information for SiS video
- IX. DOS/Win3.1x:** Audio Software Manual (with I-A16C bundle)
- X. Windows 95:** Audio Software Manual (with I-A16C bundle)

Item Checklist

Please check that your package is complete. If you discover damaged or missing items, please contact your retailer.

- The P/I-P55SP4V motherboard
- 2 serial port ribbon cables attached to a mounting bracket
- 1 parallel ribbon cable with mounting bracket
- 1 IDE ribbon cable
- 1 floppy ribbon cable
- 1 Video + PS/2 Mouse Card (on 16-pin connector)
- Support software on CD or diskettes (view FILELIST.TXT for contents)
- This user's manual (audio sections included with I-A16C bundle)
- Optional infrared module
- Optional PCI-SC200 Fast-SCSI card
- Optional I-A16C Audio Card

II. FEATURES

Features of This Motherboard

The P/I-P55SP4V is carefully designed for the demanding PC user who wants a great many features in a small package. This motherboard:

- **Easy Installation:** Is equipped with BIOS that supports auto detection of hard drives and Plug and Play to make setup of hard drives and expansion cards virtually automatic.
- **Multi-Processor/Multi-Speed Support:** Supports one Pentium (75-200MHz), Cyrix P166+ (Rev 2.7 or later), or AMD-K5 (PR75-100MHz) (See page 11).
- **SiS Chipset:** Features SiS5596 chipset with built-in video controller. Supports video shared memory from 1MB to 2MB.
- **Desktop Management Interface (DMI):** Supports DMI through BIOS which allows hardware to communicate within a standard protocol creating a higher level of compatibility (see section V).
- **L2 Cache:** Provides 512KB Pipelined Burst SRAM onboard.
- **Versatile DRAM Memory Support:** Supports 72-pin SIMMs of 4MB, 8MB, 16MB, 32MB, 64MB to form a memory size between 8MB to 256MB. Supports both Fast Page Mode (FPM) and Extended Data Output (EDO) SIMM's.
- **ISA and PCI Expansion Slots:** Provides three 16-bit ISA slots, three 32-bit PCI slots, and one PCI/MediaBus 2.0 which allows the use of either a standard PCI card or the ASUS MediaBus Card.
- **ASUS MediaBus Rev 2.0:** Features an expansion slot extension shared with PCI Slot 4 for an optional high-performance expansion card which includes two functions in one easy-to-install card. **(For revision compatibility information, please refer to page 18.)**
- **Super Multi-I/O:** Provides two high-speed UART compatible serial ports and one parallel port with EPP and ECP capabilities. UART2 can also be directed from COM2 to the Infrared Module for wireless connections. Two floppy drives of either 5.25" or 3.5" (1.44MB or 2.88MB) are also supported without an external card. **The Japanese "Floppy 3 mode" (3.5" 1.2MB) floppy standard is also supported.**
- **PCI Bus Master IDE Controller:** Comes with an onboard PCI Bus Master IDE controller with two connectors that supports four IDE devices in two channels, provides faster data transfer rates, and supports Enhanced IDE devices such as CD-ROM drives. This controller supports PIO Modes 3 & 4 and Bus Master IDE DMA Mode 2. **BIOS supports IDE CD-ROM or SCSI drive bootup.**

II. FEATURES

- **Optional IrDA :** This motherboard supports an optional infrared port module for wireless interface.
- **NCR SCSI BIOS:** This motherboard has firmware that supports the optional ASUS PCI-SC200 SCSI controller cards.

Parts of the Motherboard

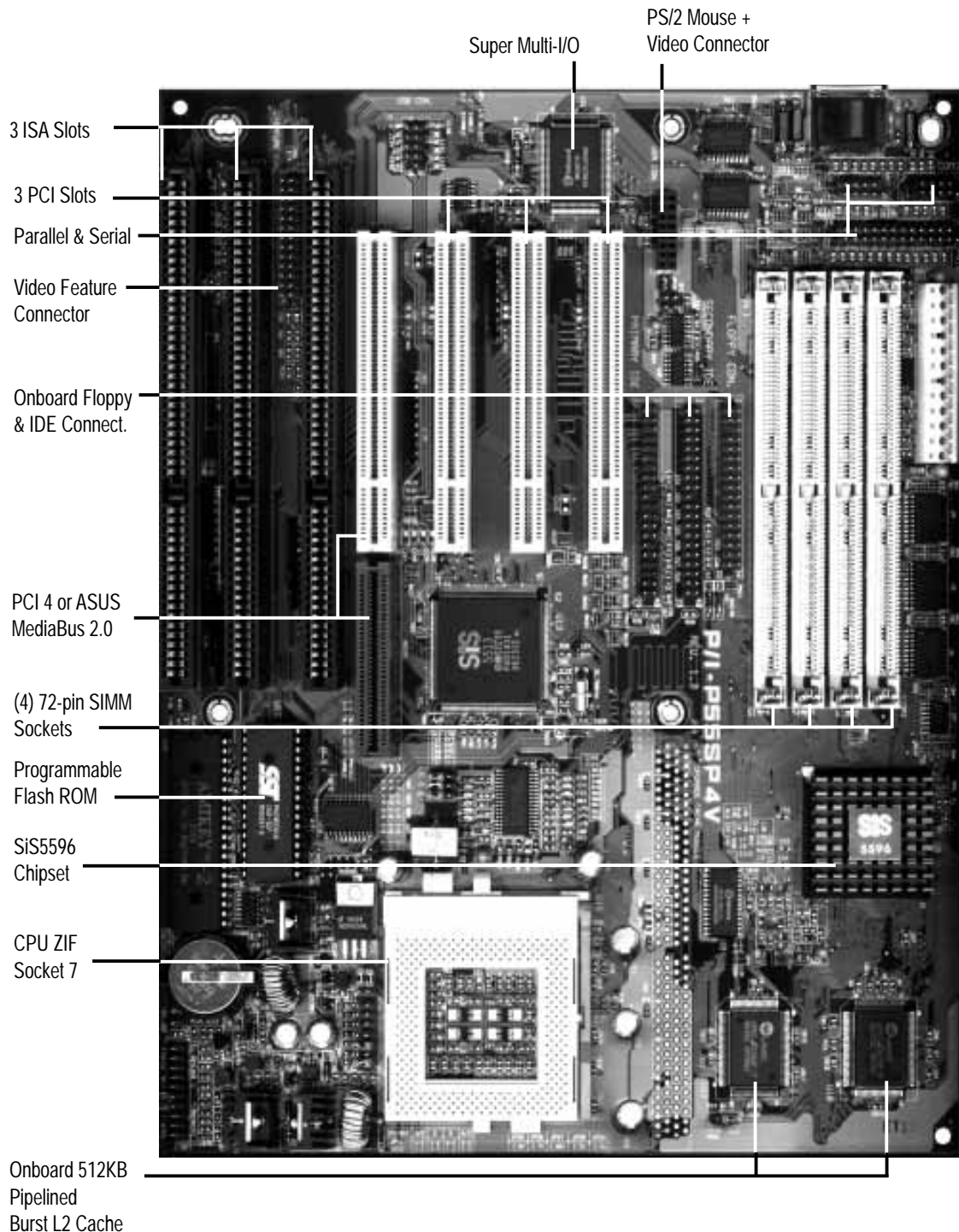

II. FEATURES
(Parts of Board)

III. INSTALLATION

Map of the Motherboard

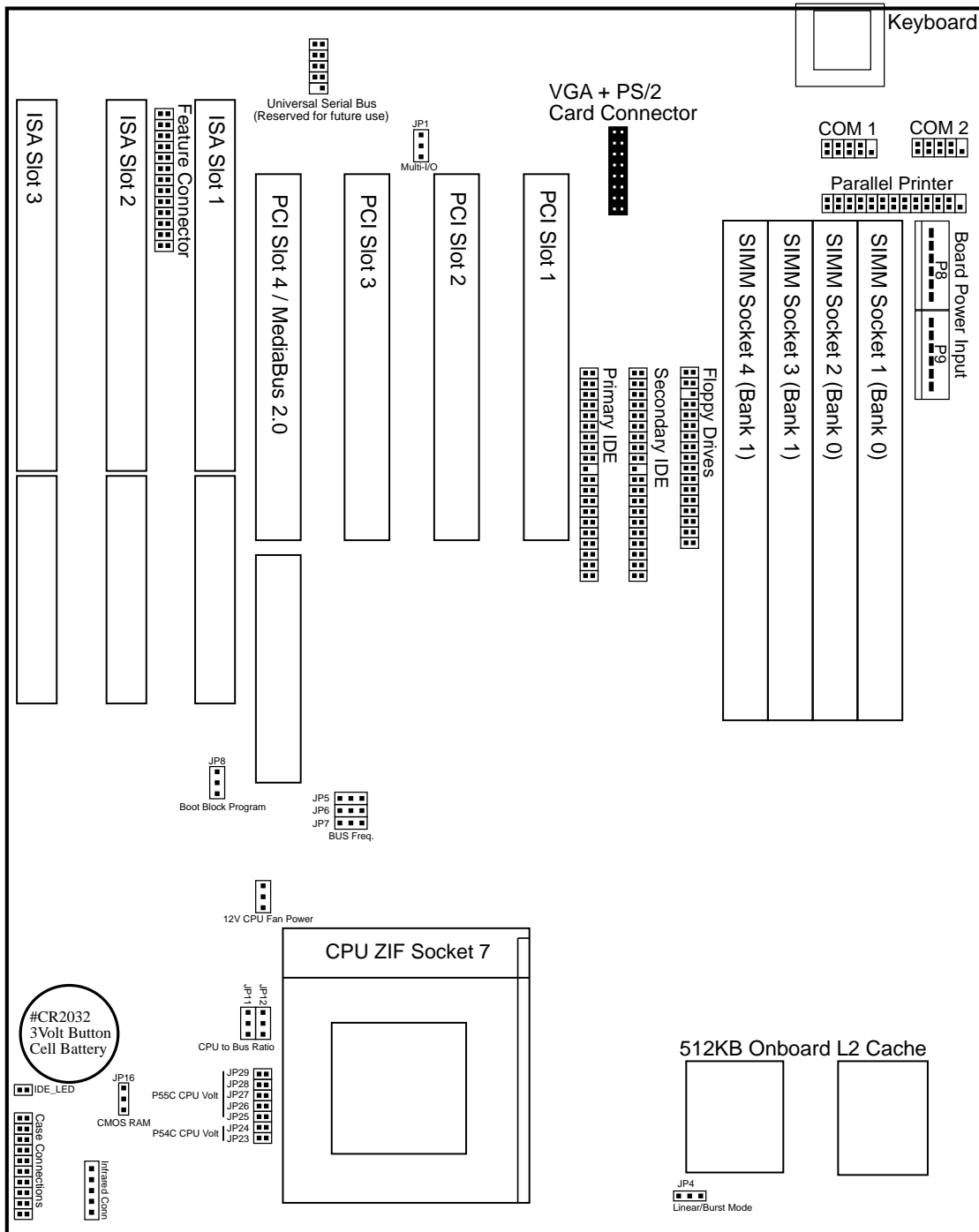

III. INSTALLATION
(Map of Board)

III. INSTALLATION

Jumpers

- | | | |
|------------------|-------|---|
| 1) JP1 | p. 7 | Multi-I/O Selection (Enable/Disable) |
| 2) JP8 | p. 7 | Flash ROM Boot Block Program (Disable/Enable) |
| 3) JP16 | p. 8 | CMOS RAM (Operation/Clear CMOS Data) |
| 4) JP23-29 | p. 9 | Voltage Regulator Output Selection |
| 5) JP5, JP6, JP7 | p. 10 | CPU External Clock (BUS) Frequency Selection |
| 6) JP11, JP12 | p. 10 | CPU:BUS Frequency Ratio |

Expansion Slots

- | | | |
|----------------------|-------|--|
| 1) SIMM Sockets | p. 12 | DRAM Memory Expansion sockets |
| 2) CPU ZIF Socket 7 | p. 15 | Socket for Central Processing Unit (CPU) |
| 3) ISA Slots 1, 2, 3 | p. 16 | 16-bit ISA Bus Expansion slots |
| 4) PCI Slots 1, 2, 3 | p. 16 | 32-bit PCI Bus Expansion slots |
| 5) PCI 4 / MediaBus | p. 18 | 32-bit PCI Bus Slot and MediaBus |

Connectors

- | | | |
|----------------------------|-------|--|
| 1) Keyboard | p. 19 | Keyboard connector (5-pin Female) |
| 2) Video + PS/2 Mouse | p. 19 | Video + PS/2 Mouse Card connector |
| 3) Parallel Port (Printer) | p. 20 | Parallel Port (Printer) connector (26-pin Block) |
| 4) Serial Port | p. 20 | Serial Port (COM1 & COM2) (10-pin Blocks) |
| 5) Floppy Drive | p. 21 | Floppy Drive connector (34-pin Block) |
| 6) Power Input | p. 21 | Motherboard Power connector (12-pin Block) |
| 7) Primary/Second. IDE | p. 22 | Primary/Secondary IDE connectors (40-pin Blocks) |
| 8) IDE_LED | p. 22 | IDE_LED activity light |
| 9) Turbo/Power (CON1) | p. 23 | Turbo LED/Power LED (2-pins) |
| 10) SMI Switch (CON1) | p. 23 | SMI Switch lead (2-pins) |
| 11) Reset Switch (CON1) | p. 23 | Reset Switch lead (2-pins) |
| 12) Key Lock (CON1) | p. 23 | Keyboard Lock Switch lead (5-pins) |
| 13) Speaker (CON1) | p. 23 | Speaker connector (4-pins) |
| 14) FAN | p. 24 | CPU 12V Cooling Fan connector |
| 15) IR CON. | p. 24 | Infrared Port Module connector |







III. INSTALLATION

Installation Steps

Before using your computer, you must complete the following steps:

1. Set Jumpers on the Motherboard
2. Install DRAM and SRAM Modules
3. Install the Central Processing Unit (CPU)
4. Install Expansion Cards
5. Connect Ribbon Cables, Cabinet Wires, and Power Supply
6. Setup the BIOS Software

1. Jumpers

Several hardware settings are made through the use of jumper caps to connect jumper pins (JP) on the motherboard. See "Map of the Motherboard" on page 4 for locations of jumpers. The jumper settings will be described numerically such as [----], [1-2], [2-3] for no connection, connect pins 1&2, and connect pins 2&3 respectively. Pin 1 for our motherboards is always on top  or on the left  when holding the motherboard with the keyboard connector away from yourself. A "1" is written besides pin 1 on jumpers with three pins. The jumpers will also be shown graphically such as  to connect pins 1&2 and  to connect pins 2&3. Jumpers with two pins will be shown as  for Short (On) and  for Open (Off). For manufacturing simplicity, the jumpers may be sharing pins from other groups. Use the diagrams in this manual instead of following the pin layout on the board. Settings with two jumper numbers require that both jumpers be moved together. To connect the pins, simply place a plastic jumper cap over the two pins as diagramed.

WARNING: Computer motherboards and components contain very delicate Integrated Circuit (IC) chips. To protect the motherboard and other components against damage from static electricity, you should follow some precautions whenever you work on your computer.

1. Unplug your computer when working on the inside.
2. Hold components by the edges and try not to touch the IC chips, leads, or circuitry.
3. Use a grounded wrist strap before handling computer components.
4. Place components on a grounded antistatic pad or on the bag that came with the component whenever the components are separated from the system.

III. INSTALLATION

Jumper Settings

1. Onboard Multi-I/O Selection (JP1)

You can selectively disable each onboard Multi-I/O item (floppy, serial, parallel, and IrDA) through BIOS (see CHIPSET FEATURES SETUP) *or* disable all Multi-I/O items at once with the following jumper in order to use your own Multi-I/O card.

<u>Selections</u>	<u>JP1</u>
Enable	[1-2] (Default)
Disable	[2-3]

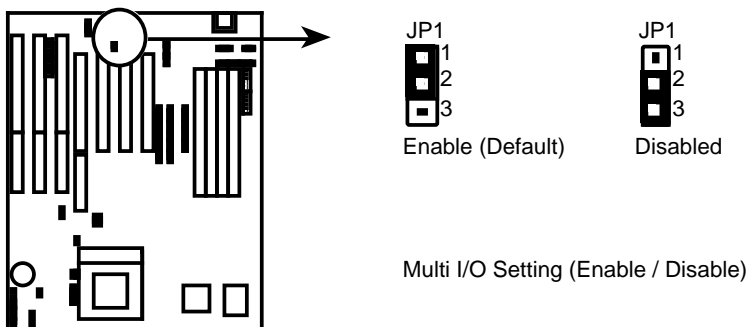

2. Flash ROM Boot Block Programming (JP8)

This sets the operation mode of the boot block area of the BIOS Flash ROM to allow programming in the *Enabled* position.

<u>Programming</u>	<u>JP8</u>
Disabled	[1-2] (Default)
Enabled	[2-3]

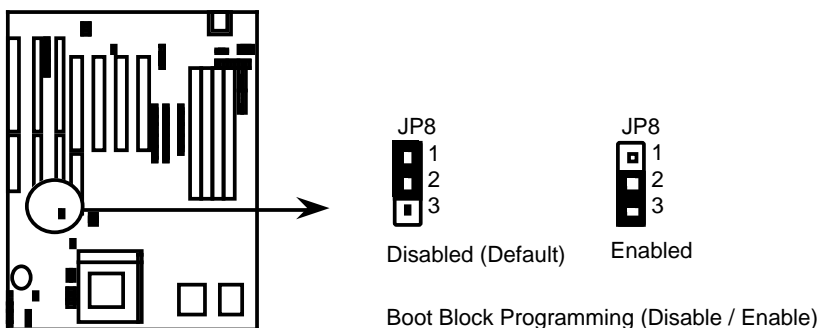

III. INSTALLATION

3. CMOS RAM (JP16)

This clears the user-entered information stored in the CMOS RAM of the Real Time Clock such as hard disk information and passwords. To clear the CMOS data: (1) Turn off the PC, (2) Set jumper to "Clear", (3) Power on the PC, (4) Turn off the PC, (5) Set jumper to "Operation", (6) Power on the PC, (7) Hold down <Delete> during bootup and enter BIOS setup to re-enter user preferences.

<u>Selections</u>	<u>JP16</u>
Operation	[1-2] (Default)
Clear CMOS Data	[2-3] (momentarily)

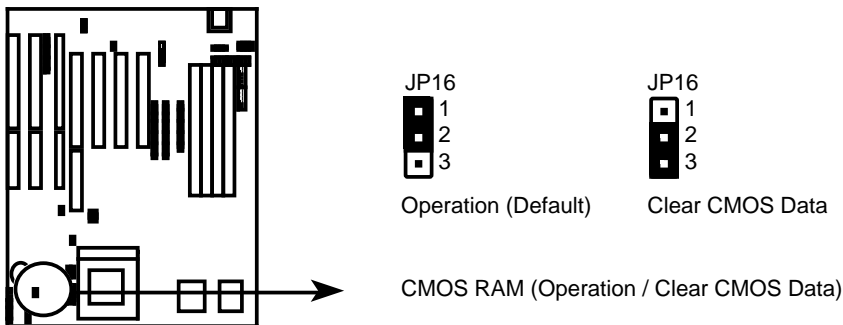

III. INSTALLATION

4. Voltage Regulator Output Selection (JP23-29)

These jumpers set the voltage supplied to the CPU. Determine whether your CPU has a single power plane or dual power planes and then the voltage that it uses. Current Intel CPU's marked "Pentium" has only a single power plane and uses the standard 3.38 volts (STD) or 3.5 volts (VRE). When a single power plane CPU is installed, the dual power plane selections will be automatically disabled. When a dual power plane CPU is installed, the single power plane selections will be automatically disabled. You may have one jumper on the **Single Power Plane** and another on the **Dual Power Planes** at the same time.

<u>Single Power Plane</u>	<u>Type</u>	<u>Voltage</u>	<u>Dual Power Planes</u>	<u>Voltage</u>
JP24 [short]	VRE	3.52V	JP29 [short]	Reserved
JP23 [short] (Default)	STD	3.38V	JP28 [short]	2.5V
			JP27 [short]	2.88V
			JP26 [short]	2.7V
			JP25 [short] (Default)	2.8V

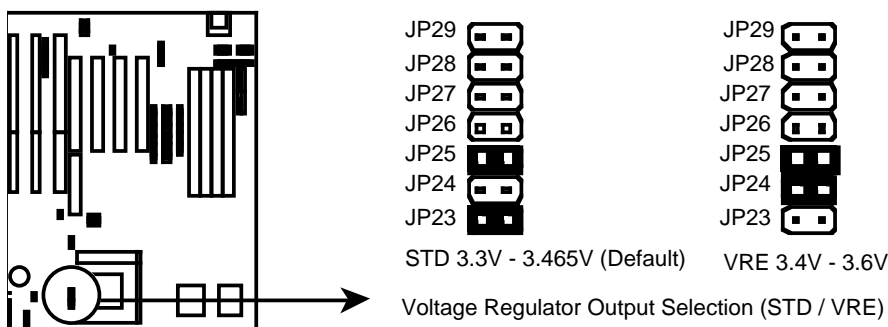

III. INSTALLATION
(Jumpers)

III. INSTALLATION

5. CPU External (BUS) Frequency Selection (JP5, JP6, JP7)

These jumpers tell the clock generator what frequency to send to the CPU. These allow the selection of the CPU's *External* frequency (or *BUS Clock*). The *BUS Clock* times the *BUS Ratio* equals the CPU's *Internal* frequency (the advertised CPU speed).

6. CPU to BUS Frequency Ratio (JP11, JP12)

These jumpers set the frequency ratio between the *Internal* frequency of the CPU and the *External* frequency (called the *BUS Clock*) within the CPU. These must be set together with the above jumpers *CPU External (BUS) Frequency Selection*.

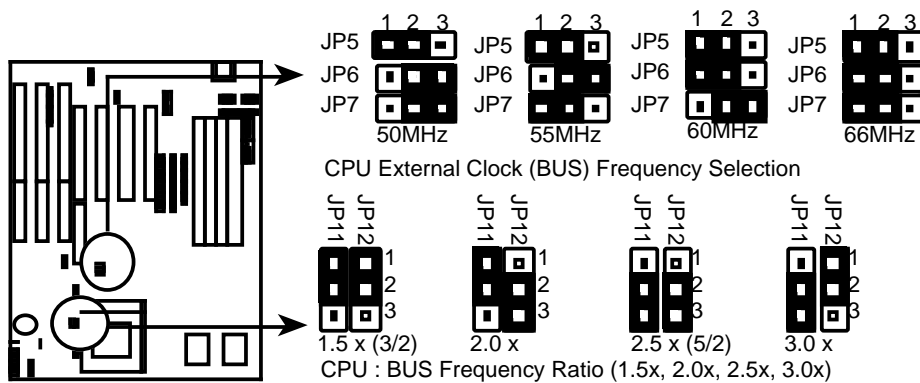

Set the jumpers by the Internal speed of the Intel, AMD, Cyrix, or CPU as follows:

CPU Model	Freq.	Ratio	(BUS Freq.)	(BUS Freq.)			(Freq. Ratio)	
				JP5	JP6	JP7	JP11	JP12
Intel Pentium	200MHz	3.0x	66MHz	[1-2]	[1-2]	[1-2]	[2-3]	[1-2]
Intel Pentium	180MHz	3.0x	60MHz	[1-2]	[1-2]	[2-3]	[2-3]	[1-2]
Intel Pentium	166MHz	2.5x	66MHz	[1-2]	[1-2]	[1-2]	[2-3]	[2-3]
Intel Pentium	150MHz	2.5x	60MHz	[1-2]	[1-2]	[2-3]	[2-3]	[2-3]
Intel Pentium	133MHz	2.0x	66MHz	[1-2]	[1-2]	[1-2]	[1-2]	[2-3]
Intel Pentium	120MHz	2.0x	60MHz	[1-2]	[1-2]	[2-3]	[1-2]	[2-3]
Intel Pentium	100MHz	1.5x	66MHz	[1-2]	[1-2]	[1-2]	[1-2]	[1-2]
Intel Pentium	90MHz	1.5x	60MHz	[1-2]	[1-2]	[2-3]	[1-2]	[1-2]
Intel Pentium	75MHz	1.5x	50MHz	[1-2]	[2-3]	[2-3]	[1-2]	[1-2]
AMD-K5	100MHz	1.5x	66MHz	[1-2]	[1-2]	[1-2]	[1-2]	[1-2]
AMD-K5	90MHz	1.5x	60MHz	[1-2]	[1-2]	[2-3]	[1-2]	[1-2]
AMD-K5	75MHz	1.5x	50MHz	[1-2]	[2-3]	[2-3]	[1-2]	[1-2]
*Cyrix 166+	133MHz	2.0x	66MHz	[1-2]	[1-2]	[1-2]	[1-2]	[2-3]

***NOTE:** Only Cyrix Revision 2.7 or later is supported on this motherboard. See next page for revision identification. Bootup screen will show **6x86-P166+ -S CPU at 133MHz** with the Cyrix 166+ installed on this motherboard.

III. INSTALLATION

Cyrix CPU Identification

The Cyrix CPU that is supported on this motherboard is labeled Cyrix 6x86 P166+ but must be Revision 2.7 and later. Look on the underside of the CPU for the serial number. The number should read G8DC6620A or larger.



III. INSTALLATION

2. System Memory (DRAM & SRAM)

This motherboard supports four 72-pin SIMMs of 4MB, 8MB, 16MB, 32MB, or 64MB to form a memory size between 8MB to 256MB. The DRAM can be either 60ns or 70ns Fast Page Mode (Asymmetric or Symmetric) or EDO.

Install memory in any or all of the banks in any combination as follows:

Bank	Memory Module		Total Memory
Bank 0 SIMM Sockets 1&2	4MB, 8MB, 16MB, 32MB, 64MB 72-pin FPM or EDO SIMM	x2	
Bank 1 SIMM Sockets 3&4	4MB, 8MB, 16MB, 32MB, 64MB 72-pin FPM or EDO SIMM	x2	
	Total System Memory (Max 256MB)	=	

IMPORTANT: Memory setup is required in "Auto Configuration" in the CHIPSET FEATURES SETUP of Section IV BIOS software.

IMPORTANT: Each bank must have the same size memory installed in pairs. Do not use memory modules with more than 24 chips per module. Modules with more than 24 chips exceed the design specifications of the memory subsystem and will be unstable.

III. INSTALLATION

DRAM Memory Installation Procedures:

1. The SIMM memory modules will only fit in one orientation as shown because of a "Plastic Safety Tab" on one end of the SIMM sockets which requires the "Notched End" of the SIMM memory modules.

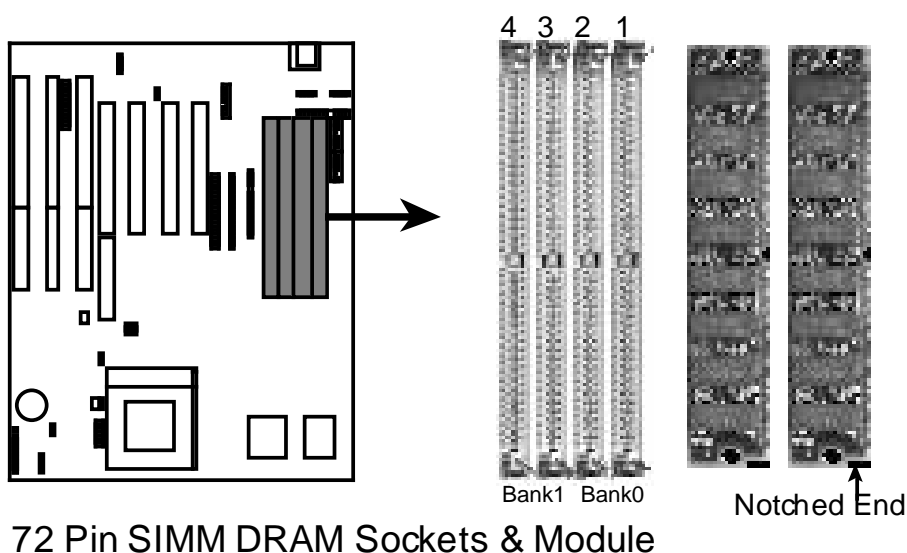

72 Pin SIMM DRAM Sockets & Module

2. Press the memory module firmly into place starting from a 45 degree angle making sure that all the contacts are aligned with the socket.
3. With your finger tips, rock the memory module into a vertical position so that it clicks into place.

72 Pin DRAM in SIMM Socket

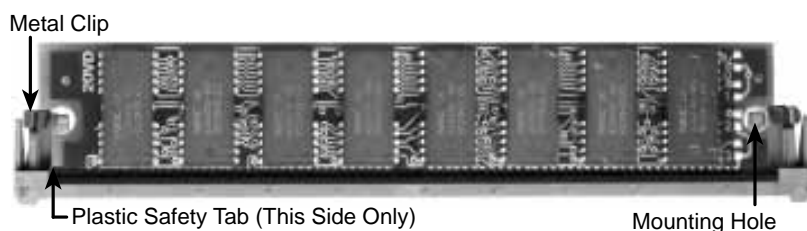

4. The plastic guides should go through the two "Mounting Holes" on the sides and the "Metal Clips" should snap on the other side.
5. To release the memory module, squeeze both "Metal Clips" outwards and rock the module out of the "Metal Clips".

III. INSTALLATION

(This page was intentionally left blank)

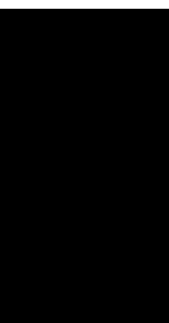

III. INSTALLATION

3. Central Processing Unit (CPU)

The motherboard provides a 321-pin ZIF Socket 7 that is backwards compatible with ZIF Socket 5 processors. The CPU that came with the motherboard should have a fan attached to it to prevent overheating. If this is not the case then purchase a fan before you turn on your system. Apply thermal jelly to the CPU top and then install the fan onto the CPU. Orientate the fan so that the heat sink fins allow air flow to go across the onboard heat sink(s) instead of the expansion slots.

WARNING: Without a fan, the CPU and motherboard heatsink(s) can overheat and cause damage to both the CPU and the motherboard.

To install a CPU, first turn off your system and remove its cover. Locate the ZIF socket and open it by first pulling the lever sideways away from the socket then upwards to a 90-degree right angle. Insert the CPU with the correct orientation as shown. Use the notched corner of the CPU with the white dot as your guide. The white dot should point towards the end the of the lever. Notice that there is a blank area where one hole is missing from that corner of the square array of pin holes and a "1" printed on the motherboard next to that corner. Because the CPU has a corner pin for three of the four corners, the CPU will only fit in the one orientation as shown. The picture is for reference only; you should have a CPU fan that will cover the face of the CPU. With the added weight of the CPU fan, no force is required to insert the CPU. Once completely inserted, hold down on the fan and close the socket's lever.

IMPORTANT: You must set jumpers for "BUS Frequency Selection" and jumpers for "CPU to BUS Frequency Ratio" on page 10 depending on the CPU that you install.

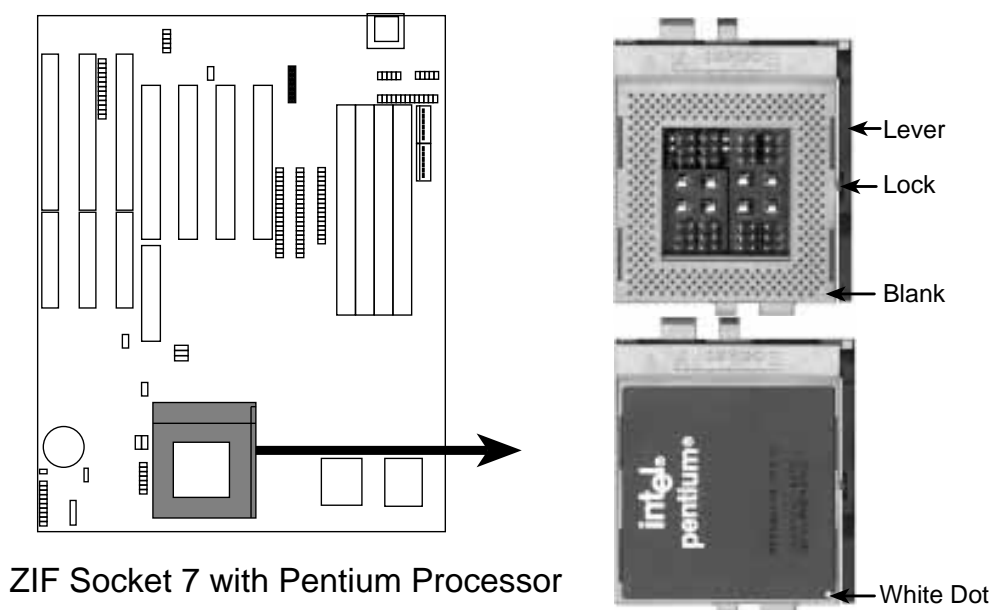

III. INSTALLATION

4. Expansion Cards

WARNING: Make sure that you unplug your power supply when adding or removing expansion cards or other system components. Failure to do so may cause severe damage to both your motherboard and expansion cards.

First read your expansion card documentation on any hardware and software settings that may be required to setup your specific card.

NOTE: PCI Slot 4 has a MediaBus extension 2.0 (see page 18) which allows the installation of a PCI card or a MediaBus card (optional multifunctional card) but not both.

Expansion Card Installation Procedure:

1. Read the documentation for your expansion card.
2. Set any necessary jumpers on your expansion card.
3. Remove your computer system's cover.
4. Remove the bracket on the slot you intend to use. Keep the bracket for possible future use.
5. Carefully align the card's connectors and press firmly.
6. Secure the card on the slot with the screw you removed in step 4.
7. Replace the computer system's cover.
8. Setup the BIOS if necessary (such as "IRQ xx Used By ISA: Yes" in PNP AND PCI SETUP)
9. Install the necessary software drivers for your expansion card.

Assigning IRQs for Expansion Cards

Some expansion cards need to use an IRQ to operate. Generally an IRQ must be exclusively assigned to one use. In a standard design there are 16 IRQs available but most of them are already in use by parts of the system which leaves 6 free for expansion cards.

Both ISA and PCI expansion cards may need to use IRQs. System IRQs are available to cards installed in the ISA expansion bus first, and any remaining IRQs are then used by PCI cards. Currently, there are two types of ISA cards. The original ISA expansion card design, now referred to as "Legacy" ISA cards, requires that you configure the card's jumpers manually and then install it in any available slot on the ISA bus. You may use Microsoft's Diagnostic (MSD.EXE) utility included

III. INSTALLATION

in the Windows directory to see a map of your used and free IRQs. For Windows 95 users, the "Control Panel" icon in "My Computer," contains a "System" icon which gives you a "Device Manager" tab. Double clicking on a specific device give you "Resources" tab which shows the Interrupt number and address. Make sure that no two devices use the same IRQs or your computer will experience problems when those two devices are in use at the same time.

To simplify this process this motherboard has complied with the Plug and Play (PNP) specification which was developed to allow automatic system configuration whenever a PNP-compliant card is added to the system. For PNP cards, IRQs are assigned automatically from those available.

If the system has both Legacy and PNP ISA cards installed, IRQs are assigned to PNP cards from those not used by Legacy cards. The PCI and PNP configuration of the BIOS setup utility can be used to indicate which IRQs are being used by Legacy cards. For older Legacy cards that does not work with the BIOS, you can contact your vendor for an ISA Configuration Utility.

An IRQ number is automatically assigned to PCI expansion cards after those used by Legacy and PNP ISA cards. In the PCI bus design, the BIOS automatically assigns an IRQ to a PCI slot that has a card in it that requires an IRQ. To install a PCI card, you need to set something called the INT (interrupt) assignment. Since all the PCI slots on this motherboard use an INTA #, be sure that the jumpers on your PCI cards are set to INT A.

Assigning DMA Channels for ISA Cards

Some ISA cards, both Legacy and PNP may also need to use a DMA (Direct Memory Access) channel. DMA assignments for this motherboard are handled the same way as the IRQ assignment process described above. You can select a DMA channel in the PCI and PNP configuration section of the BIOS Setup utility.

IMPORTANT: In BIOS setup page 40, you should choose "Yes" for those IRQ's and DMA's you wish to reserve for Legacy (Non-PnP) ISA cards, otherwise conflicts may occur.

III. INSTALLATION

ASUS MediaBus Card

MediaBus allows a cost-efficient solution to a complete multimedia system. The advantages of using one add-on card is to reduce the slot requirements and compatibility problems in order to maximize the Plug and Play advantages. The add-on card inserts into the shared PCI 4 / MediaBus 2.0 Slot.

NOTE: This motherboard uses MediaBus Rev. 2.0. The previous MediaBus cards designed for MediaBus Rev. 1.2 will not fit into the MediaBus Rev 2.0 that is on this motherboard.

The difference between Rev. 1.2 and Rev. 2.0 is that the later revision has 72 pins instead of 68 pins so it does not have to use any PCI slot signals reserved for PCI cards, therefore the motherboard's PCI Slot 4 can meet standard specifications. The gap between the MediaBus extension and the PCI Slot 4 has been increased from 0.32" to 0.40" in order to prevent Rev. 1.2 MediaBus cards from being installed into the new motherboards and vice versa.

The following are MediaBus cards designed for **MediaBus 2.0** that *can* be used on this motherboard:

- PCI-AS2940UW Ultra Fast/Wide SCSI & Audio MediaBus Card
- PCI-AV264CT-N PCI Audio & Video MediaBus Card
- PCI-AV264VT PCI Audio & Video MediaBus Card
- PCI-AV264GT PCI Audio & Video MediaBus Card
- PCI-AV264GT/Plus PCI Audio & Video MediaBus Card

The following are MediaBus cards designed for **MediaBus 1.2** and therefore *cannot* be used on this motherboard:

- PCI-AS7870 Fast/Wide SCSI & Audio MediaBus Card
- PCI-AV264CT PCI Audio & Video MediaBus Card
- PCI-AV868 PCI Audio & Video MediaBus Card

* All the above Audio features Creative Technology, Ltd.

* All the above Video features ATI, Inc. (AV868 Video features S3, Inc.)

* All the above SCSI features Adaptec, Inc.

III. INSTALLATION

5. External Connectors

WARNING: Some pins are used for connectors or power sources. These are clearly separated from jumpers in "Map of the Motherboard" on page 4. Placing jumper caps over these will cause damage to your motherboard.

IMPORTANT: Ribbon cables should always be connected with the red stripe on the Pin 1 side of the connector. The four corners of the connectors are labeled on the motherboard. Pin 1 is the side closest to the power connector on hard drives and floppy drives. IDE ribbon cable must be less than 18in. (46cm), with the second drive connector no more than 6in. (15cm) from the first connector.

1. Keyboard Connector (5-pin female)

This connection is for a standard IBM-compatible keyboard. May also be known as a 101 enhanced keyboard.

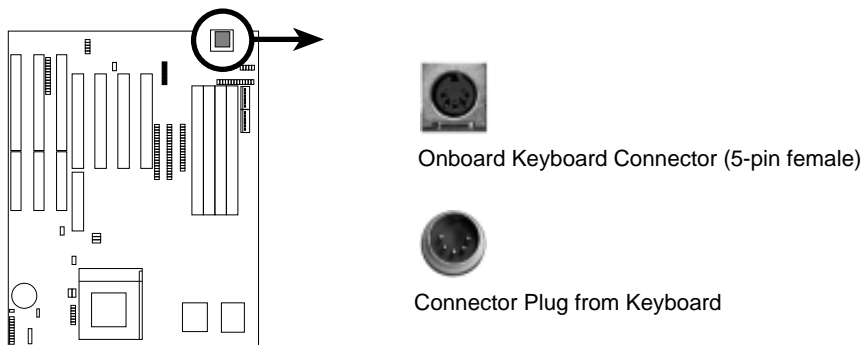

2. Video + PS/2 Mouse Connector (16-pin card)

The following video + PS/2 mouse card connects to the motherboard on the first slot opening nearest the keyboard connector. Remove the slot cover and insert this card. Mount the card's bracket to the case using the screw from the slot cover. The card will then be available for a monitor and PS/2 mouse.

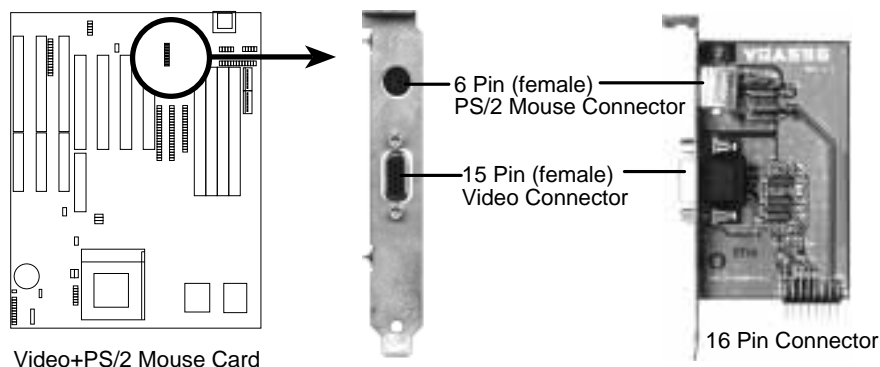

III. INSTALLATION

3. Parallel port (Printer) Connector (26 Pin Block)

Connection for the included parallel port ribbon cable with mounting bracket. Connect the ribbon cable to this connection and mount the bracket to the case on an open slot. It will then be available for a parallel printer cable. **Note:** Serial printers must be connected to the serial port. You can enable the parallel port and choose the IRQ through BIOS Setup on page 36 "Onboard Parallel Port". **(Pin 26 is removed to prevent inserting in the wrong orientation when using ribbon cables with pin 26 plugged).**

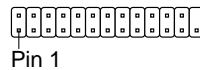
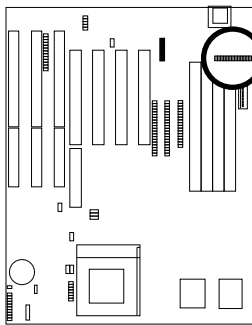

Onboard Parallel (Printer) Connector

4. Serial port (COM1 and COM2) connectors (Two 10-pin blocks)

These connectors support the provided serial port ribbon cables with mounting bracket. Connect the ribbon cables to these connectors and mount the bracket to the case on an open slot. The two serial ports on the mounting bracket will then be used for pointing devices or other serial devices. See page 35 for BIOS configuration of "Onboard Serial Port". **(Pin 10 is removed to prevent inserting in the wrong orientation when using ribbon cables with pin 10 plugged).**

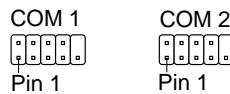
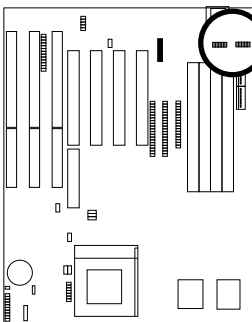

Onboard Serial Port Connectors

III. INSTALLATION

5. Floppy drive connector (34-pin block)

This connector supports the provided floppy drive ribbon cable. After connecting the single end to the board, connect the two plugs on the other end to the floppy drives. **(Pin 5 is removed to prevent inserting in the wrong orientation when using ribbon cables with pin 5 plugged).**

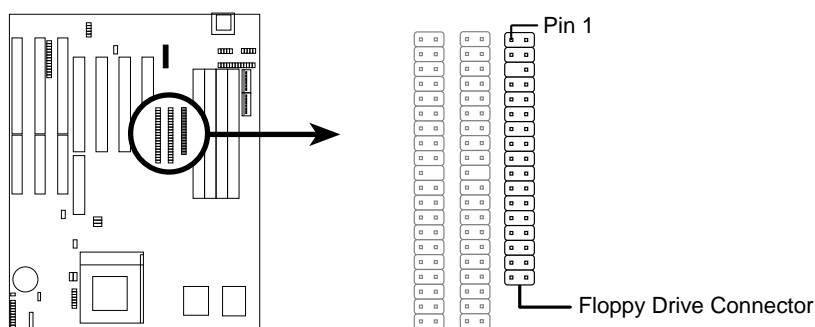

6. Power connector (12-pin block)

This connector connects to a standard 5 Volt power supply. To connect the leads from the power supply, ensure first that the power supply is not plugged. Most power supplies provide two plugs (P8 and P9), each containing six wires, two of which are black. Orient the connectors so that the black wires are located in the middle.

Using a slight angle, align the plastic guide pins on the lead to their receptacles on the connector. Once aligned, press the lead onto the connector until the lead locks into place.

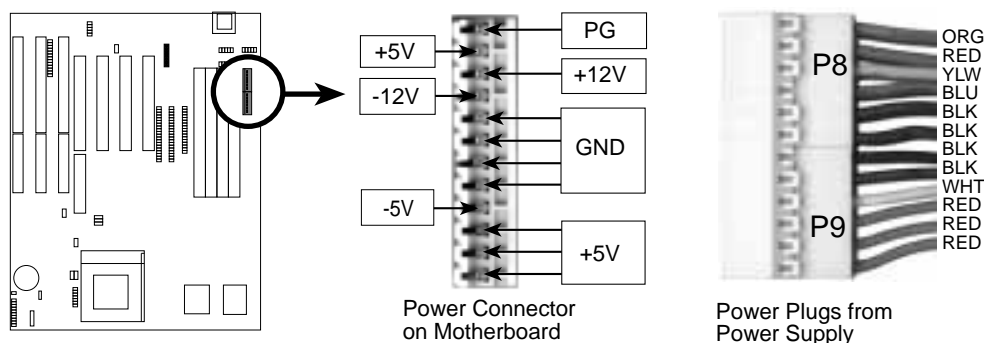

III. INSTALLATION

7. Primary / Secondary IDE connectors (Two 40-pin Block)

These connectors support the provided IDE hard disk ribbon cable. After connecting the single end to the board, connect the two plugs at the other end to your hard disk(s). If you install two hard disks, you must configure the second drive to Slave mode by setting its jumper accordingly. Please refer to the documentation of your hard disk for the jumper settings. You may also configure two hard disks to be both Masters using one ribbon cable on the primary IDE connector and another ribbon cable on the secondary IDE connector. BIOS now supports SCSI device or IDE CD-ROM bootup (see "HDD Sequence SCSI/IDE First" & "Boot Sequence" in the BIOS FEATURES SETUP of the BIOS software) **(Pin 20 is removed to prevent inserting in the wrong orientation when using ribbon cables with pin 20 plugged).**

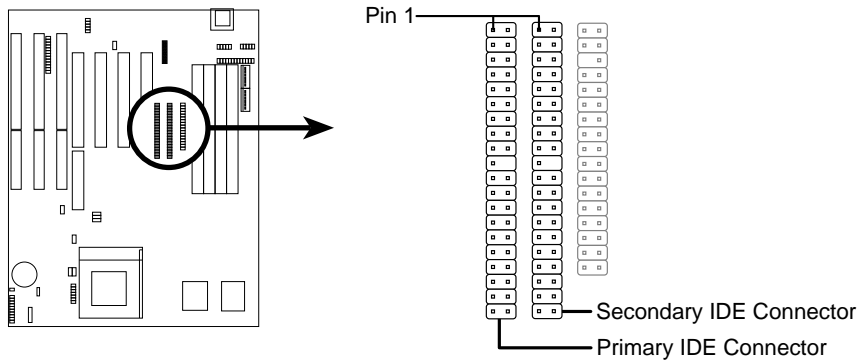

8. IDE activity LED (IDE_LED)

This connector connects to the hard disk activity indicator light on the system cabinet.

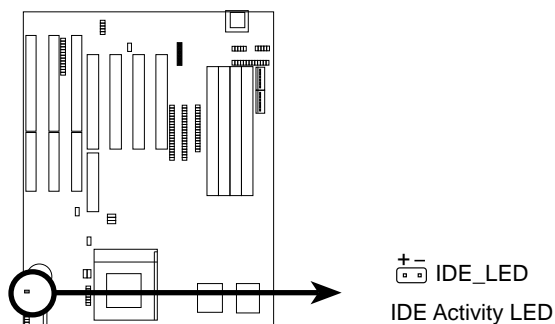

III. INSTALLATION

9. Turbo LED lead (CON1)

The motherboard's turbo function is always on. The turbo LED connection is labeled here but the LED will remain constantly lit while the system power is on. You may wish to connect the Power LED from the system case to this lead. See the figure below.

10. SMI suspend switch lead (CON1)

This allows the user to manually place the system into a suspend mode or "Green" mode where system activity will be instantly decreased to save electricity and expand the life of certain components when the system is not in use. This 2-pin connector (see the figure below) connects to the case-mounted suspend switch. If you do not have a switch for the connector, you may use the "Turbo Switch" since it does not have a function. SMI is activated when it detects a *short to open* moment and therefore leaving it shorted will not cause any problems. May require one or two pushes depending on the position of the switch. Wake-up can be controlled by settings in the BIOS but the keyboard will always allow wake-up (the SMI lead cannot wake-up the system). If you want to use this connector, "Suspend Switch" in the POWER MANAGEMENT SETUP of the BIOS software should be on the default setting of *Enable*.

11. Reset switch lead (CON1)

This 2-pin connector connects to the case-mounted reset switch for rebooting your computer without having to turn off your power switch. This is a preferred method of rebooting in order to prolong the life of the system's power supply. See the figure below.

12. Keyboard lock switch lead & Power LED lead (CON1)

This 5-pin connector uses 3-pins for the case-mounted key switch for locking the keyboard to prevent unwanted users. Two of the 5-pins are used for the case-mounted power LED. See the figure below.

13. Speaker connector (CON1)

This 4-pin connector connects to the case-mounted speaker.

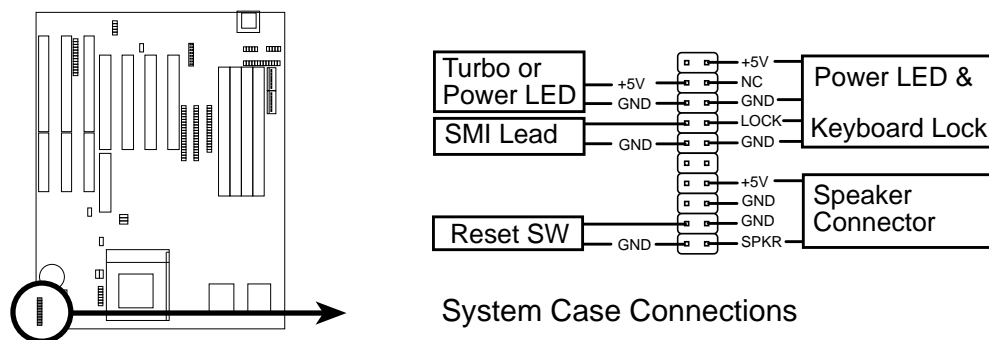

III. INSTALLATION

14. CPU cooling fan connector (FAN)

This connector supports a CPU cooling fan of 500mAMP (6WATT) or less. Orientate the fan so that the heat sink fins allow airflow to go across the on-board heat sink(s) instead of the expansion slots. Depending on the fan manufacturer, the wiring and plug may be different. The red wire should be positive, while the black should be ground. Connect the fan's plug to the board taking into consideration the polarity of the this connector.

WARNING: The CPU and/or motherboard will overheat if there is no airflow across the CPU and onboard heatsinks. Damage may occur to the motherboard and/or the CPU fan if these pins are incorrectly used.

These are not jumpers, do not place jumper caps over these pins.

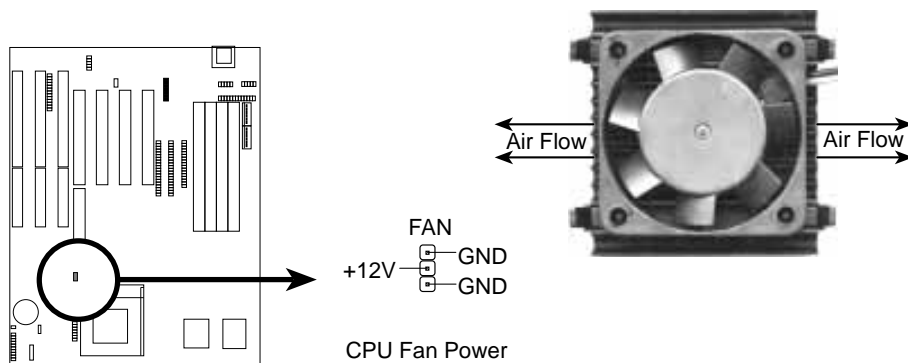

15. IrDA-compliant infrared module connector (IR CON.)

This connector supports the optional wireless transmitting and receiving infrared module. This module mounts to a small opening on system cases that support this feature. You must also configure the setting through BIOS setup "UART2 Use Infrared" to select whether UART2 is directed for use with COM2 or IrDA. Use the five pins as shown on the Back View and connect a ribbon cable from the module to the motherboard according to the pin definitions.

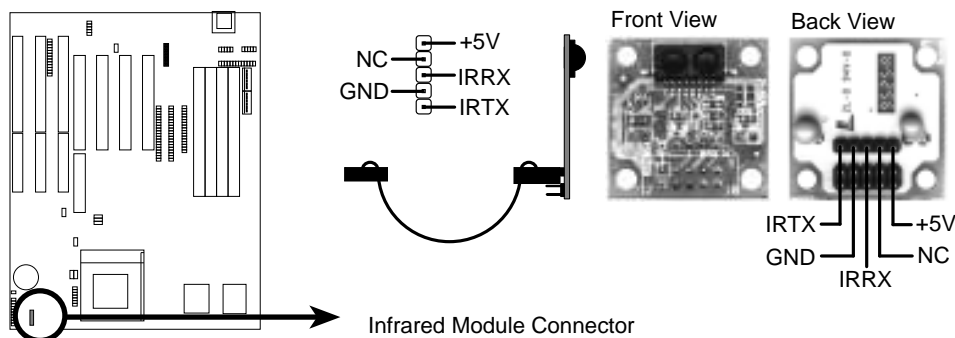

III. INSTALLATION

Power Connection Procedures

1. After all jumpers and connections are made, close the system case cover.
2. Make sure that all switches are in the off position as marked by \bigcirc .
3. Connect the power supply cord into the power supply located on the back of your system case as instructed by your system user's manual.
4. Connect the power cord into an power outlet that is equipped by a surge protector.
5. You may then turn on your devices in the following order:
 - a. Your monitor
 - b. External SCSI devices (starting with the last device on the chain)
 - c. Your system power
6. The power LED on the front panel of the system case will light and the monitor LED as well. The system will then run power-on tests. While the tests are running, additional messages will appear on the screen. If you do not see anything within 30 seconds from the time you turn on the power, the system may have failed a power-on test. Recheck your jumper settings and connections or call your authorized dealer for assistance.
7. During power-on, hold down the <Delete> key to enter BIOS setup. Follow the next section "BIOS SOFTWARE" for instructions.

Support Software

FILELIST.TXT - View this file to see the files included in the support software.

PFLASH.EXE - This is the Flash Memory Writer utility. The Flash Memory Writer utility updates the BIOS by uploading a new BIOS file to the programmable flash ROM chip on the motherboard. This BIOS file is included with each motherboard, and may be newer than the BIOS on the motherboard. To determine whether or not the provided BIOS file is newer than the current motherboard BIOS, compare the BIOS file name with the last four numbers of the code displayed on the upper left-hand corner of your screen during bootup. If the number of the BIOS file in the support diskette is larger, continue with the following section to reprogram the motherboard BIOS. If the number is smaller, skip the Flash Memory Writer section.

NOTE: A binary BIOS file is no longer included with the support software. Save the motherboard's BIOS file to a floppy diskette as soon as your system is operational. See "Flash Memory Writer Utility" in this section to "Save Current BIOS to File."

IV. BIOS SOFTWARE

Flash Memory Writer Utility

1. Enable "Boot Block Programming" jumper as shown in section III.
2. Make sure the system is running in real mode. This utility will not operate if the system is under protected mode or virtual mode. This means that you cannot reprogram the motherboard BIOS under the Windows environment or with any memory management software, including HIMEM.SYS. The following describes the easiest way run your system from real mode:
 - Boot from a floppy disk formatted with the "FORMAT A:/S" command without creating CONFIG.SYS and AUTOEXEC.BAT files.
 - If you are using MS-DOS 6.x, you can bypass the AUTOEXEC.BAT and CONFIG.SYS by pressing <F5> when "Starting MS-DOS . . ." line is displayed on the screen.
 - For Windows 95 users, press <F8> to enter the Microsoft Windows 95 Startup Menu and then choose "Safe mode command prompt only"
3. You should copy the contents of the \FLASH directory to your hard disk drive. Once you have accomplished the above tasks, you can run the Flash Memory Writer utility. To run the utility, change to the directory containing PFLASH.EXE and then at the DOS prompt, type: **PFLASH <Enter>**

The Flash Memory Writer Utility Screen:

```
ASUSTeK PNP BIOS
FLASH MEMORY WRITER V1.5
Copyright (C) 1995, ASUSTeK COMPUTER Inc.

Flash Type -- SST 29EE010
Current BIOS Revision: #401A0-xxxx
Choose one of the following:
1. Save Current BIOS To File
2. Update BIOS Main Block From File
3. Advanced Features

Enter Choice: [ 1]

Press ESC To Exit
```

xxxx denotes the current BIOS version stored in the Flash EPROM

IMPORTANT: Flash Type may also be "INTEL 28F001BXT." If "unknown" is after "Flash type --," then this ROM chip is not programmable or not supported with the PnP BIOS and therefore cannot be programmed by the Flash Memory Writer.

This screen provides three command options, which you can invoke by typing the corresponding number of the command and pressing <Enter> key. The following describes each command:

IV. BIOS SOFTWARE

1. Save Current BIOS to File (Perform as soon as system is running)

This option allows you to copy the contents of the Flash memory chip into a file in the \FLASH directory. This gives you a backup copy of the original motherboard BIOS in case you need to re-install it. In such cases where the data on the chip get lost or corrupted, you can reprogram the chip using this backup copy.

2. Update BIOS Main Block from File

This option updates the BIOS from a file on the disk. This can either be a new file or a backup file created by the “Save Current BIOS to File” option. This will not update the Boot Block if the Boot Block is different. You will be prompted with the following if advanced features if necessary.

Boot Block of New BIOS is different from old one !!!

Please Use 'Advanced Feature' to flash whole bios !!!

3. Advanced Features

Selecting this option brings up the Advanced Features screen for clearing the PnP configuration record and updating the motherboard BIOS.

To terminate the program and return to the DOS prompt, press the <Esc> key. Selecting the third option displays the Advanced Features screen.

```
Advanced Features

Flash Type -- SST 29EE010
Current BIOS Revision: #401A0-xxxx
Choose one of the following:
1. Clear PNP ESCD Parameter Block
2. Update BIOS Including Boot Block and ESCD

Enter Choice: [ 2]

Press ESC To Exit
```

xxxx denotes the current BIOS version stored in the Flash EPROM

Clear PNP ESCD Parameter Block

This option erases the Plug-and-Play (PnP) configuration record.

Update BIOS Including Boot Block and ESCD

This option updates the Boot Block, the motherboard BIOS and the PnP ESCD Parameter Block from a new BIOS file in the \FLASH directory.

IV. BIOS SOFTWARE

To select an option, type its corresponding number in the provided space and then press the <Enter> key. Follow these procedure to update the PnP motherboard BIOS.

1. Download the new BIOS by selecting the second command option from the Advanced Features screen. The program displays a second screen prompting you for the name of the BIOS file. Type in the complete name of the file, including the file name extension, and then press the <Enter> key. The utility then downloads the new BIOS file. The following message appears:

DO NOT TURN OFF THE SYSTEM IF THERE IS A PROBLEM!

If you encounter problems while downloading the new BIOS, **DO NOT** turn off your system since this might prevent your system from booting up. Just repeat the process, and if the problem still persists, download the original BIOS file you saved to disk.

2. After successfully downloading the new BIOS file, exit the Flash Memory Writer utility and **then turn off your system**. Set the jumper back to its default setting of Programming "Disabled."
3. Turn on the system and hold down to enter BIOS Setup. You must load "**Setup Default**" to affect the new BIOS.

WARNING: If the Flash Memory Writer utility was not able to successfully download a complete BIOS file, your system may not be able to boot up. If this happens, your system will require service from your vendor.

IV. BIOS SOFTWARE

6. BIOS Setup

The motherboard supports two programmable Flash ROM chips: 5 Volt and 12 Volt. Either of these memory chips can be updated when BIOS upgrades are released. Use the Flash Memory Writer utility to download the new BIOS file into the ROM chip as described in detail at the beginning of BIOS Software section IV.

All computer motherboards provide a Setup utility program for specifying the system configuration and settings. If your motherboard came in a computer system, the proper configuration entries may have already been made. If so, invoke the Setup utility, as described later, and take note of the configuration settings for future reference; in particular, the hard disk specifications.

If you are installing the motherboard, reconfiguring your system or you receive a Run Setup message, you will need to enter new setup information. This section describes how to configure your system using this utility.

The BIOS ROM of the system stores the Setup utility. When you turn on the computer, the system provides you with the opportunity to run this program. This appears during the Power-On Self Test (POST). Press the <Delete> key to call up the Setup utility. If you are a little bit late pressing the mentioned key(s), POST will continue with its test routines, thus preventing you from calling up Setup. If you still need to call Setup, reset the system by simultaneously pressing the <Ctrl>, <Alt> and <Delete> keys, or by pushing the Reset button on the system case. You can also restart by turning the system off and then back on again. But do so only if the first two methods fail.

When you invoke Setup, the CMOS SETUP UTILITY main program screen will appear with the following options:

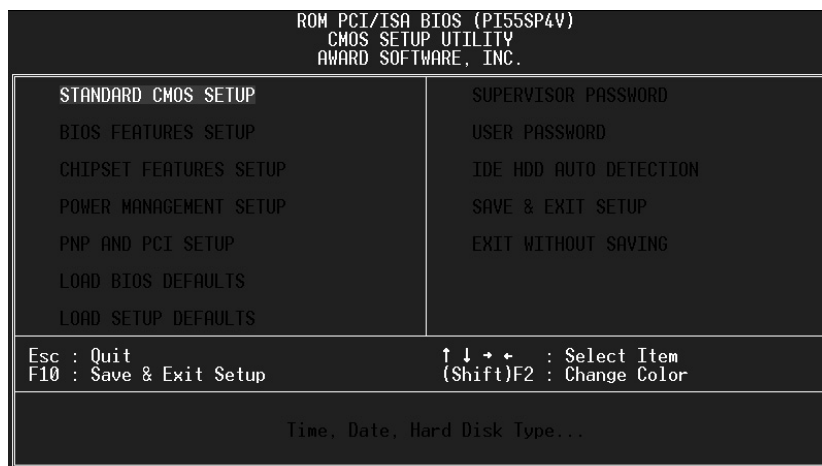

IV. BIOS SOFTWARE

Load Defaults

The “Load BIOS Defaults” option loads the minimized settings for troubleshooting. “Load Setup Defaults”, on the other hand, is for loading optimized defaults for regular use. Choosing defaults at this level, will modify all applicable settings.

A section at the bottom of the above screen displays the control keys for this screen. Take note of these keys and their respective uses. Another section just below the control keys section displays information on the currently highlighted item in the list.

Standard CMOS Setup

This “Standard CMOS Setup” option allows you to record some basic system hardware configuration and set the system clock and error handling. If the motherboard is already installed in a working system, you will not need to select this option anymore. However, if the configuration stored in the CMOS memory on the board gets lost or damaged, or if you change your system hardware configuration, you will need to respecify the configuration values. The configuration values usually get lost or corrupted when the power of the onboard CMOS battery weakens.

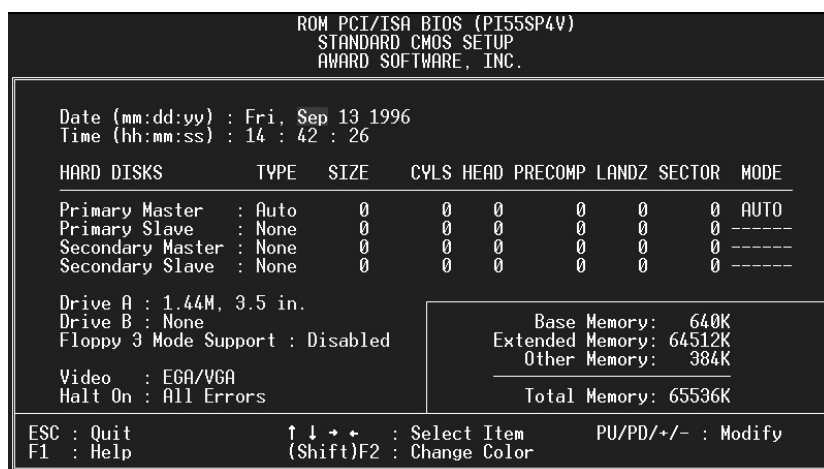

The above screen provides you with a list of options. At the bottom of this screen are the control keys for use on this screen. Take note of these keys and their respective uses.

User-configurable fields appear in a different color. If you need information on the selected field, press the <F1> key. The help menu will then appear to provide you with the information you need. The memory display at the lower right-hand side of the screen is read-only and automatically adjusts accordingly.

IV. BIOS SOFTWARE

Details of Standard CMOS Setup:

Date

To set the date, highlight the “Date” field and then press the page up/page down or +/- keys to set the current date. Follow the month, day and year format. Valid values for month, day and year are:

Month:	1 to 12
Day:	1 to 31
Year:	up to 2099

Time

To set the time, highlight the “Time” field and then press the page up/page down or +/- keys to set the current time. Follow the hour, minute and second format. Valid values for hour, minute and second are:

Hour:	00 to 23
Minute:	00 to 59
Second:	00 to 59

time, just press the <Enter> key twice if you do not want to modify the current

You can bypass the date and time prompts by creating an AUTOEXEC.BAT file. For information on how to create this file, please refer to the MS-DOS manual.

Hard Disks

This field records the specifications for all non-SCSI hard disk drives installed in your system. The onboard PCI IDE connectors provide Primary and Secondary channels for connecting up to four IDE hard disks or other IDE devices. Each channel can support up to two hard disks; the first of which is the “master” and the second is the “slave”.

Specifications for SCSI hard disks need not to be entered here since they operate using device drivers and are not supported by any the BIOS. If you install the optional PCI-SC200 SCSI controller card into the motherboard (see section VI for instructions). If you install other vendor’s SCSI controller card, please refer to their respective documentations on how to install the required SCSI drivers.

For IDE hard disk drives, you can:

- Use the *Auto* setting for detection during bootup (see below)
- Use the IDE HDD AUTO DETECTION in the main menu to automatically enter the drive specifications, or you can:
- Enter the specifications yourself manually by using the “User” option

IV. BIOS SOFTWARE

The entries for specifying the hard disk type include **CYLS** (number of cylinders), **HEAD** (number of read/write heads), **PRECOMP** (write precompensation), **LANDZ** (landing zone), **SECTOR** (number of sectors) and **MODE**. The **SIZE** field automatically adjusts according to the configuration you specify. The documentation that comes with your hard disk should provide you with the information regarding the drive specifications.

The **MODE** entry is for IDE hard disks only, and can be ignored for MFM and ESDI drives. This entry provides three options: *Normal*, *Large*, *LBA*, or *Auto* (see below). Set **MODE** to the *Normal* for IDE hard disk drives smaller than 528MB; set it to *LBA* for drives over 528MB that support Logical Block Addressing (LBA) to allow larger IDE hard disks; set it to *Large* for drives over 528MB that do not support LBA. *Large* type of drive can only be used with MS-DOS and is very uncommon. Most IDE drives over 528MB support the *LBA* mode.

Auto detection of hard disks on bootup (New Feature)

For each field: Primary Master, Primary Slave, Secondary Master, and Secondary Slave, you can select *Auto* under the TYPE and MODE fields. This will enable auto detection of your IDE drives during bootup. This will allow you to change your hard drives (with the power off) and then power on without having to reconfigure your hard drive type. If you use older hard drives which do not support this feature, then you must configure the hard drive in the standard method as described above by the "User" option.

NOTE: After the IDE hard disk drive information has been entered into BIOS, new IDE hard disk drives must be partitioned (such as with FDISK) and then formatted before data can be read from and write on. Primary IDE hard disk drives must have its partition set to *active* (also possible with FDISK).

IV. BIOS SOFTWARE

Drive A, Drive B (None)

These fields record the types of floppy disk drives installed in your system. The available options for drives A and B are:

360KB, 5.25 in.

1.2MB, 5.25 in.

720KB, 3.5 in.

1.44MB, 3.5 in.

2.88MB, 3.5 in.

None

To enter the configuration value for a particular drive, highlight its corresponding field and then select the drive type using the left- or right-arrow key.

Floppy 3 Mode Support (Disabled)

This is the Japanese standard floppy drive. The standard stores 1.2MB in a 3.5" diskette. This is normally disabled but you may choose from either:

Drive A

Drive B

Both

Disabled (Default)

Video (EGA/VGA)

Set this field to the type of video display card installed in your system. The options are:

EGA/VGA (Default)

Mono (for Hercules or MDA)

CGA 40

CGA 80

If you are using a VGA or any higher resolution card, choose the "EGA/VGA" option.

Halt On (All Errors)

This field determines which types of errors will cause the system to halt.

All Errors (Default)

No Errors

All, But Keyboard

All, But Diskette

All, But Disk/Key

IV. BIOS SOFTWARE

BIOS Features Setup

This “BIOS Features Setup” option consists of configuration entries that allow you to improve your system performance, or let you set up some system features according to your preference. Some entries here are required by the motherboard’s design to remain in their default settings.

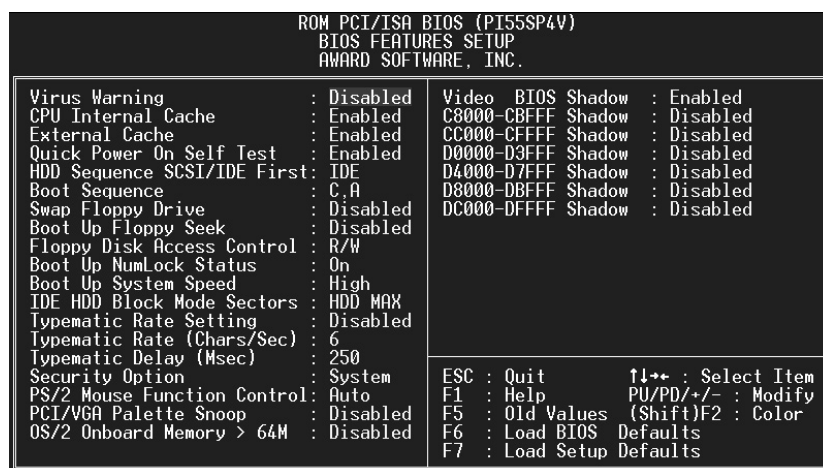

A section at the lower right of the screen displays the control keys you can use. Take note of these keys and their respective uses. If you need information on a particular entry, highlight it and then press the <F1> key. A pop-up help menu will appear to provide you with the information you need. To load the last set values, press the <F5> key. <F6> and <F7> load the BIOS default values and Setup default values, respectively.

NOTE: SETUP Defaults are noted in parenthesis next to each function heading.

Details of BIOS Features Setup:

Virus Warning (Disabled)

This field protects the boot sector and partition table of your hard disk against accidental modifications. Any attempt to write to them will cause the system to halt and display a warning message. If this occurs, you can either allow the operation to continue or use a bootable virus-free floppy disk to reboot and investigate your system. Disabled is recommended because of conflicts with new operating systems. Installation of new operating systems require that you disable this to prevent write errors.

IV. BIOS SOFTWARE

CPU Internal Cache (Enabled)

These fields allow you to *Enable* or *Disable* the CPU's "Level 1" primary cache. Caching allows better performance.

External Cache (Enabled)

These fields allow you to *Enable* or *Disable* the CPU's "Level 2" secondary cache. Caching allows better performance.

Quick Power On Self Test (Enabled)

This field speeds up the Power-On Self Test (POST) routine by skipping retesting a second, third, and fourth time. A complete test of the system is done on each test.

HDD Sequence SCSI/IDE First (IDE)

When using both SCSI and IDE hard disk drives, IDE is always the boot disk using drive letter C. This new feature allows a SCSI hard disk drive to be the boot disk when set to *SCSI*. This allows multiple operating systems to be used on both IDE and SCSI drives or the primary operating system to boot using a SCSI hard disk drive.

Boot Sequence (C,A)

This field determines where the system looks first for an operating system. Options are *C,CDROM,A; CDROM,C,A; A,C; C,A*. The setup default setting is to check first the hard disk and then the floppy drive; that is, *C, A*.

Swap Floppy Drive (Disabled)

When enabled, the BIOS swaps floppy drive assignments so that Drive A becomes Drive B, and Drive B becomes Drive A under DOS.

Boot Up Floppy Seek (Disabled)

When enabled, the BIOS will seek the floppy "A" drive one time.

Floppy Disk Access Control (R/W)

This allows protection of files from the computer system to be copied to floppy drives by allowing the setting of *Read Only* to only allow reads from the floppy but not writes. The setup default *R/W* allows both reads and writes.

Boot Up NumLock Status (On)

This field enables users to activate the Number Lock function upon system boot. The setup default setting for this field is *On*.

Boot Up System Speed (High)

This has no function and should be left at the setup default of *High*.

IDE HDD Block Mode Sectors (HDD MAX)

This field enhances hard disk performance by making multi-sector transfers instead of one sector per transfer. Most IDE drives, except older versions, can utilize this feature. By setup default, this field is set to *HDD MAX*, other selections are *Disabled 2, 4, 8, 16, and 32*.

IV. BIOS SOFTWARE

Typematic Rate Setting (Disabled)

When enabled, you can set the two typematic controls listed next.

Typematic Rate (Chars/Sec) (6)

This field controls the speed at which the system registers repeated keystrokes. Options range from 6 to 30 characters per second. Setup default setting is **6**; other settings are **8, 10, 12, 15, 20, 24, and 30**.

Typematic Delay (Msec) (250ms)

This field sets the time interval for displaying the first and second characters. Four delay rate options are available: 250ms, 500ms, 750ms and 1000ms.

Security Option (System)

This field determines when the system prompts for the password. The default setting is *System*, where the system prompts for the User Password every time you boot up. The other option is *Setup*, where the system always boots up, and prompts for the Supervisor Password only when the Setup utility is called up. You can specify a password by using the *Supervisor Password* or *User Password* option from the main screen as explained later in this section.

PS/2 Mouse Function Control (Auto)

The default of *Auto* allows the system to detect a PS/2 Mouse on bootup. If detected, IRQ12 will be used for the PS/2 Mouse. IRQ12 will be reserved for expansion cards if a PS/2 Mouse is not detected. *Disabled* will reserve IRQ12 for expansion cards and therefore the PS/2 Mouse will not function.

PCI/VGA Palette Snoop (Disabled)

Some display cards that are nonstandard VGA such as graphics accelerators or MPEG Video Cards may not show colors properly. The setting *Enabled* should correct this problem. Otherwise leave this on the setup default setting of *Disabled*.

OS/2 Onboard Memory > 64M (Disabled)

When using OS/2 operating systems with installed DRAM of greater than 64MB, you need to *Enable* this option otherwise leave this on the setup default of *Disabled*.

.....

Video BIOS Shadow (Enabled)

This field allows you to change the video BIOS location from ROM to RAM. Relocating to RAM enhances system performance, as information access is faster than the ROM.

C8000-CBFFF to DC000-DFFFF (Disabled)

These fields are used for shadowing other expansion card ROMs. If you install other expansion cards with ROMs on them, you will need to know which addresses the ROMs use to shadow them specifically. Shadowing a ROM reduces the memory available between 640KB and 1024KB by the amount used for this purpose. Leave on default setting of *Disabled*.

IV. BIOS SOFTWARE

Chipset Features Setup

This “Chipset Features Setup” option controls the configuration of the board’s chipset. Control keys for this screen are the same as for the previous screen.

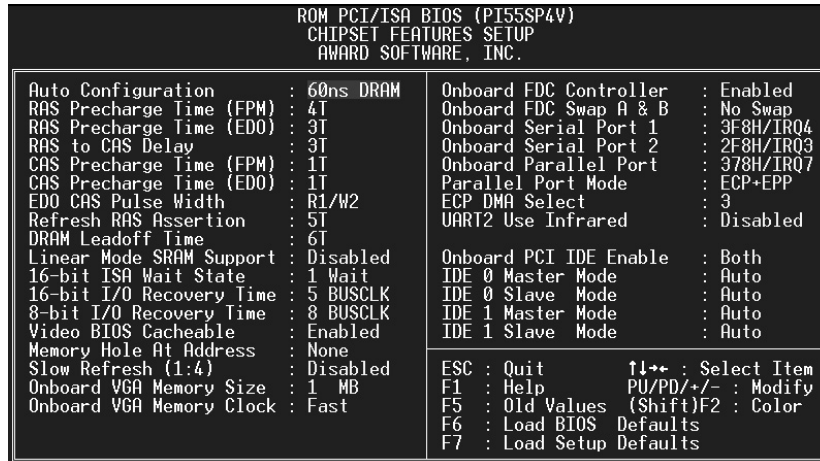

NOTE: SETUP Defaults are noted in parenthesis next to each function heading.

Details of Chipset Features Setup:

Auto Configuration (60ns DRAM)

The default setting of **60ns DRAM** sets the optimal timings for items 2 through 8 for 60ns DRAM modules. If you are using 70ns DRAM modules, you must change this item to **70ns DRAM**. See pages 12-13 for DRAM installation information.

DRAM Leadoff Time (Leave on default setting of 6T)

Linear Mode SRAM Support (Leave on default setting of Disabled)

For a slightly better performance on Cyrix CPU’s, this function can be Enabled to switch from Toggle mode SRAM to Linear mode SRAM support. **WARNING:** Intel CPU’s currently only support the Toggle mode so this function should be Disabled when using Intel CPU’s.

16-bit ISA Wait State (Leave on default setting of 1 Wait)

Timing for 16-bit ISA cards

16-bit I/O Recovery Time (Leave on default setting of 5 BUSCLK)

Timing for 16-bit ISA cards

8-bit I/O Recovery Time (Leave on default setting of 8 BUSCLK)

Timing for 8-bit ISA cards

Video BIOS Cacheable (Leave on default setting of Enabled)

Allows the Video BIOS to be cached to allow faster execution.

IV. BIOS SOFTWARE

Memory Hole at Address (None)

This feature reserves memory address space 12MB to 16MB, 14MB to 16MB, or 15MB to 16MB to ISA expansion cards that specifically require this setting. **WARNING:** This makes the memory from the specified and up unavailable to the system because expansion cards can only access memory up to 16MB.

Slow Refresh (1:4) (Disabled)

This function set to Enabled will decrease the DRAM refresh rate and increase the bandwidth available for data transfers. **WARNING:** Some DRAM's are known to lose data without frequent refreshing so this function is set to Disabled by the manufacturer.

Onboard VGA Memory Size (1MB)

This function allows the user to allocate either 1MB or 2MB memory for the onboard video controller. Larger memory allows more colors and a higher resolution to be selected within each operating system.

Onboard VGA Memory Clock (Leave on default setting of Fast)

This function allows the selection of the video speed. Normal uses 50MHz, Fast uses 60MHz, and Fastest uses 66MHz. **WARNING:** If your monitor displays unrecognizable information, you must decrease the speed to match your monitor frequency rate.

.....

Onboard FDC Controller (Enabled)

When enabled, this field allows you to connect your floppy disk drives to the onboard floppy drive connector instead of a separate controller card. If you want to use a different controller card to connect the floppy drives, set this field to "Disabled."

Onboard FDC Swap A: B: (No Swap)

This field reverses the drive letter assignments of your floppy disk drives in the *Swap AB* setting, otherwise leave on the default setting of *No Swap*. This works separately from the BIOS Features floppy disk swap feature. It is functionally the same as physically interchanging the connectors of the floppy disk drives.

Onboard Serial Port 1 (3F8H/IRQ4)

Settings are *3F8H/IRQ4* (default), *2F8H/IRQ3*, *3E8H/IRQ4*, *2E8H/IRQ10*, and *Disabled* for the onboard serial connector.

Onboard Serial Port 2 (2F8H/IRQ3)

Settings are *3F8H/IRQ4*, *2F8H/IRQ3* (default), *3E8H/IRQ4*, *2E8H/IRQ10*, and *Disabled* for the onboard serial connector.

Onboard Parallel Port (378H/IRQ7)

This field sets the address of the onboard parallel port connector. You can select either: *3BCH/IRQ 7*, *378H/IRQ 7* (default), *278H/IRQ 5*, *Disabled*. If you install an I/O card with a parallel port, ensure that there is no conflict in the address assignments. The PC can support up to three parallel ports as long as there are no conflicts for each port.

IV. BIOS SOFTWARE

Parallel Port Mode (ECP+EPP)

This field allows you to set the operation mode of the parallel port. The setting *Normal*, allows normal-speed operation but in one direction only; *EPP* allows bidirectional parallel port operation at maximum speed; *ECP* allows the parallel port to operate in bidirectional mode and at a speed faster than the maximum data transfer rate; *ECP+EPP* (default) allows normal speed operation in a two-way mode.

ECP DMA Select (3)

This selection is available only if you select *ECP* or *ECP+EPP* in the **Parallel Port Mode**. Select either DMA Channel *1*, *3* (default), or *Disable*.

UART2 Use Infrared (Disabled)

When enabled, this field activates the onboard infrared feature and sets the second serial UART to support the infrared module connector on the motherboard. If your system already has a second serial port connected to the onboard COM2 connector, it will no longer work if you enable the infrared feature. By default, this field is set to *Disabled*, which leaves the second serial port UART to support the COM2 serial port connector. See section III of the baseboard manual for the **IrDA-compliant infrared module connector**.

Onboard PCI IDE Enable (Both)

You can select to enable the *primary* IDE channel, *secondary* IDE channel, *both* (default), or *disable* both channels (for systems with only SCSI drives).

IDE 0 Master/Slave Mode, IDE 1 Master/Slave Mode (Auto)

Each channel (0 and 1) has both a master and a slave making four IDE devices possible. Because each IDE device may have a different Mode timing (0, 1, 2, 3, 4), it is necessary for these to be independent. The default setting of *Auto* will allow auto-detection to ensure the optimal performance.

Power Management Setup

This “Power Management Setup” option allows you to reduce power consumption. This feature turns off the video display and shuts down the hard disk after a period of inactivity.

```
ROM PCI/ISA BIOS (PI55SP4V)
POWER MANAGEMENT SETUP
AWARD SOFTWARE, INC.

Power Management : User Define
Video Off Option : Susp,Stby -> Off
Video Off Method : V/H SYNC+Blank
Suspend Switch : Enable
Doze Speed (div by): 8
Stdbby Speed(div by): 32

** PM Timers **
HDD Power Down : Disable
Doze Mode : Disable
Standby Mode : Disable
Suspend Mode : Disable

** PM Events **
COM Ports Activity : Enable
LPT Ports Activity : Enable
HDD Ports Activity : Enable
PCI/ISA Master Act.: Enable
IRQ1-15 Activity : Enable
VGA Activity : Disable

IRQ3 (COM 2) : Enable
IRQ4 (COM 1) : Enable
IRQ5 (LPT 2) : Enable
IRQ6 (Floppy Disk): Enable
IRQ7 (LPT 1) : Enable
IRQ8 (RTC Alarm) : Disable
IRQ9 (IRQ2 Redir) : Enable
IRQ10 (Reserved) : Enable
IRQ11 (Reserved) : Enable
IRQ12 (PS/2 Mouse) : Enable
IRQ13 (Coprocessor): Enable
IRQ14 (Hard Disk 1): Enable
IRQ15 (Hard Disk 2): Enable

ESC : Quit
F1 : Help
F5 : Old Values
F6 : Load BIOS Defaults
F7 : Load Setup Defaults

↑↓+* : Select Item
PU/PD/+/- : Modify
(Shift)F2 : Color
```

IV. BIOS SOFTWARE

NOTE: SETUP Defaults are noted in parenthesis next to each function heading.

Details of Power Management Setup:

Power Management (User Defined)

This field acts as the master control for the power management modes. There are four options: *Max Saving*, *Min Saving*, *Disabled*, and *User Defined*. *Max Saving* puts the system into power saving mode after a brief period of system inactivity; *Min Saving* is almost the same as *Max Saving* except that this time the system inactivity period is longer; *Disabled* disables the power saving features; *User Defined* allows you to set power saving options according to your preference.

IMPORTANT: Advanced Power Management (APM) should be installed to keep the system time updated when the computer enters suspend mode activated by the BIOS Power Management. For DOS environments, you need to add `DEVICE=C:\DOS\POWER.EXE` in you `CONFIG.SYS`. For Windows 3.1x and Windows 95, you need to install Windows including the APM feature. A battery and power cord icon labeled "Power" will appear in the "Control Panel." Choose "Advanced" in the Power Management Field.

Video Off Option (Susp, Stby->Off)

This field determines when to activate the video off feature for monitor power management. The settings are *Susp, Stby->Off (default)*, *Suspend->Off*, *Always on*, and *All modes->off*.

Video Off Method (V/H SYNC+Blank)

This field defines the video off features. Three options are available: *V/H SYNC + Blank*, *DPMS*, and *Blank Only*. The first option, which is the default setting, blanks the screen and turns off vertical and horizontal scanning; *DPMS* (acronym for Display Power Management System) allows the BIOS to control the video display card if it supports the DPMS feature; *Blank Screen* only blanks the screen. Use the latter for monitors that do not support the "Green" (no power management) feature.

Take note that a screen saver software does not work with this feature. While the monitor is shut off, this software cannot display.

Suspend Switch (Enable)

This field enables or disables the SMI connector on the motherboard. This connector connects to the lead from the Suspend switch mounted on the system case.

Doze Speed (8)

These two fields set the CPU speed during each mode. The number indicates what the normal CPU speed is divided by.

IV. BIOS SOFTWARE

Stdby Speed (32)

These two fields set the CPU speed during each mode. The number indicates what the normal CPU speed is divided by.

PM Timers (Disable)

This section controls the time-out settings for the Power Management scheme. The fields included in this section are “HDD Power Down”, which places the hard disk into its lowest power consumption mode, and the Doze, Standby and Suspend system inactivation modes.

The system automatically “wakes up” from any power saving mode when there is system activity such as when a key is pressed from the keyboard, or when there is activity detected from the enabled IRQ channels.

HDD Power Down shuts down any IDE hard disk drives in the system after a period of inactivity. This time period is user-configurable to *1-15 Mins* or *Disable*. This feature does not affect SCSI hard drives.

The **Doze Mode**, **Standby Mode**, and **Suspend Mode** fields set the period of time after which each of these modes activate. At *Max Saving*, these modes activate sequentially (in the given order) after one minute; at *Min Saving* after one hour.

PM Events

This section sets the wake-up call of the system. If activity is detected from any enabled IRQ channels in the left-hand group, the system wakes up from suspended mode. You can enable power management for IRQs 3 ~ 15 individually in the list at the right of the screen. The power management feature will work on the enabled IRQ channels.

Take note that a Microsoft serial mouse or compatible will use either COM1 (IRQ4) or COM2 (IRQ3), and a PS/2 mouse will use IRQ12. If you know which IRQ your mouse is using, you can enable the Wake-up Event for that IRQ here and the system will wake up when you move the mouse or click its button.

.....

Sleep Items (IRQ3-IRQ15)

You can individually *Enable* or *Disable* each IRQ to include in the sleep function. IRQ8 (Real Time Alarm) is usually set to *Disable* so that any software alarm clock or event calendar can wake up the system.

IV. BIOS SOFTWARE

PNP and PCI Setup

This “PNP and PCI Setup” option configures the PCI bus slots. All PCI bus slots on the system use INTA#, thus all installed PCI cards must be set to this value.

```
ROM PCI/ISA BIOS (PI55SP4V)
PNP AND PCI SETUP
AWARD SOFTWARE, INC.

Slot 1 (RIGHT) IRQ : Auto
Slot 2 IRQ : Auto
Slot 3 IRQ : Auto
Slot 4 (LEFT) IRQ : Auto
PCI Latency Timer : 32 PCI Clock

IRQ 3 Used By ISA : No/ICU
IRQ 4 Used By ISA : No/ICU
IRQ 5 Used By ISA : No/ICU
IRQ 7 Used By ISA : No/ICU
IRQ 9 Used By ISA : No/ICU
IRQ 10 Used By ISA : No/ICU
IRQ 11 Used By ISA : No/ICU
IRQ 12 Used By ISA : No/ICU
IRQ 14 Used By ISA : No/ICU
IRQ 15 Used By ISA : No/ICU

DMA 1 Used By ISA : No/ICU
DMA 3 Used By ISA : No/ICU
DMA 5 Used By ISA : No/ICU

ISA MEM Block BASE : No/ICU

NCR SCSI BIOS : Auto
PCI 2.1 Support : Enabled

ESC : Quit          ↑↓←→ : Select Item
F1 : Help          PU/PD/+/- : Modify
F5 : Old Values   (Shift)F2 : Color
F6 : Load BIOS Defaults
F7 : Load Setup Defaults
```

NOTE: SETUP Defaults are noted in parenthesis next to each function heading.

Details of PNP and PCI Setup:

The first four fields on the screen set how IRQ use is determined for each PCI slot. The default setting for each field is *Auto*, which uses auto-routing to determine IRQ use. The other options are manual settings of *14* or *15* for each slot.

PCI Latency Timer (32 PCI Clock)

The default setting of *32 PCI Clock* enables maximum PCI performance for this motherboard.

IRQ xx Used By ISA (No/ICU)

These fields indicate whether or not the displayed IRQ for each field is being used by a Legacy (non-PnP) ISA card. Two options are available: *No/ICU* and *Yes*. The first option, the default value, indicates either that the displayed IRQ is not used or an ISA Configuration Utility (ICU) is being used to determine if an ISA card is using that IRQ. If you install a Legacy ISA card that requires a unique IRQ, and you are not using an ICU, you must set the field for that IRQ to *Yes*. For example: If you install a Legacy ISA card that requires IRQ 10, then set **IRQ10 Used By ISA** to *Yes*.

DMA x Used By ISA (No/ICU)

These fields indicate whether or not the displayed DMA channel for each field is being used by a Legacy (non-PnP) ISA card. Available options include: *No/ICU* and *Yes*. The first option, the default setting, indicates either that the displayed DMA channel is not used or an ICU is being used to determine if an ISA card is using that channel. If you install a Legacy ISA card that requires a unique DMA channel, and you are not using an ICU, you must set the field for that channel to *Yes*.

IV. BIOS SOFTWARE

ISA MEM Block BASE (No/ICU)

This field allows you to set the base address and block size of a Legacy ISA card that uses any memory segment within the C800H and DFFFH address range. If you have such a card, and you are not using an ICU to specify its address range, select a base address from the six available options; the **ISA MEM Block SIZE** field will then appear for selecting the block size. If you have more than one Legacy ISA card in your system that requires to use this address range, you can increase the block size to either 8K, 16K, 36K, or 64K. If you are using an ICU to accomplish this task, leave **ISA MEM Block BASE** to its default setting of *No/ICU*.

NCR SCSI BIOS (Auto)

The default uses *Auto* settings for the onboard NCR SCSI BIOS (see section VI). If you wish not to use the onboard NCR SCSI BIOS, choose *Disabled*

PCI 2.1 Support (Enabled)

PCI 2.1 if Enabled is better at PCI BUS utilization compared to the previous PCI 2.0 standard. **NOTE:** Some older PCI cards may not be PCI 2.1 complaint and will result in system hangups or other problems.

IV. BIOS SOFTWARE

Load BIOS Defaults

This “Load BIOS Defaults” option allows you to load the troubleshooting default values permanently stored in the BIOS ROM. These default settings are non-optimal and disable all high performance features. To load these default settings, highlight “Load BIOS Defaults” on the main screen and then press the <Enter> key. The system displays a confirmation message on the screen. Press the <Y> key and then the <Enter> key to confirm. Press the <N> key and then the <Enter> key to abort. This feature does not affect the fields on the Standard CMOS Setup screen.

Load Setup Defaults

This “Load Setup Defaults” option allows you to load the default values to the system configuration fields. These default values are the optimized configuration settings for the system. To load these default values, highlight “Load Setup Defaults” on the main screen and then press the <Enter> key. The system displays a confirmation message on the screen. Press the <Y> key and then the <Enter> key to confirm. Press the <N> key and then the <Enter> key to abort. This feature does not affect the fields on the Standard CMOS Setup screen.

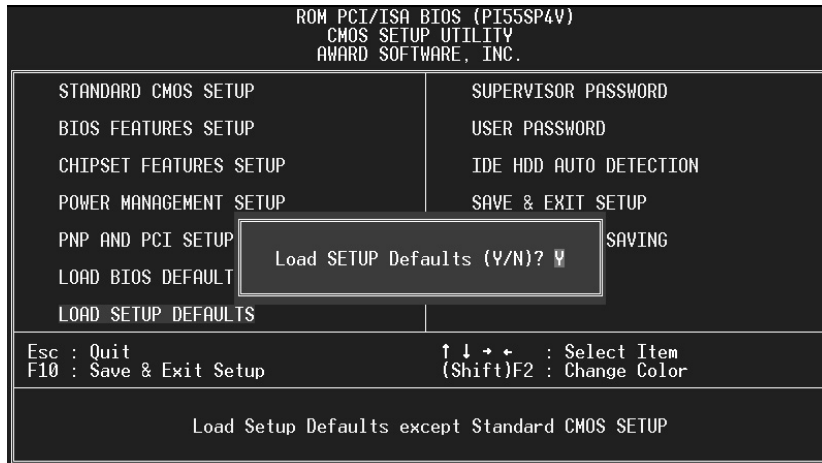

IV. BIOS SOFTWARE

Supervisor Password and User Password

These two options set the system passwords. “Supervisor Password” sets a password that will be used to protect the system and the Setup utility; “User Password” sets a password that will be used exclusively on the system. By default, the system comes without any passwords. To specify a password, highlight the type you want and then press the <Enter> key. A password prompt appears on the screen. Taking note that the password is case sensitive, and can be up to 8 alphanumeric characters long, type in your password and then press the <Enter> key. The system confirms your password by asking you to type it again. After setting a password, the screen automatically reverts to the main screen.



To implement the password protection, specify in the “Security Option” field of the BIOS Features Setup screen when the system will prompt for the password. If you want to disable either password, press the <Enter> key instead of entering a new password when the “Enter Password” prompt appears. A message confirms the password has been disabled.

NOTE: If you forget the password, see CMOS RAM in section III for procedures on clearing the CMOS.

IV. BIOS SOFTWARE

IDE HDD Auto Detection

This “IDE HDD Auto Detection” option detects the parameters of an IDE hard disk drive, and automatically enters them into the Standard CMOS Setup screen.

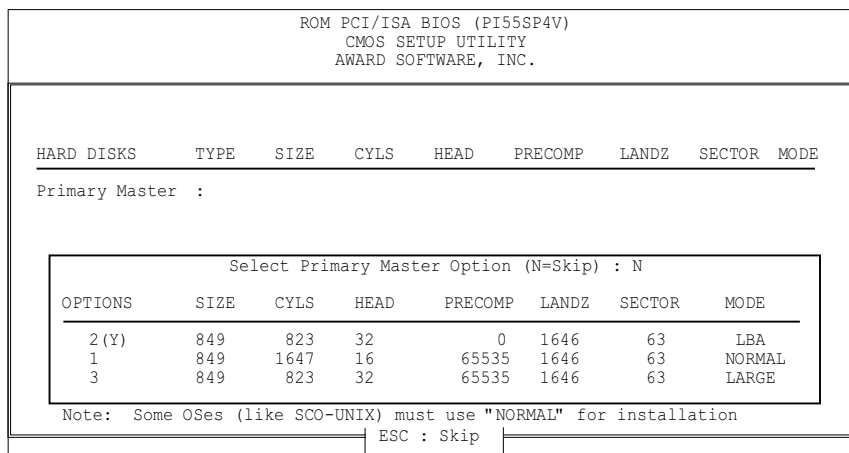

Up to four IDE drives can be detected, with parameters for each listed inside the box. To accept the optimal entries, press the <Y> key or else select from the numbers displayed under the OPTIONS field (2, 1, 3 in this case); to skip to the next drive, press the <N> key. If you accept the values, the parameters will appear listed beside the drive letter on the screen. The process then proceeds to the next drive letter. Pressing the <N> key to skip rather than to accept a set of parameters causes the program to enter zeros after that drive letter.

Remember that if you are using another IDE controller that does not feature Enhanced IDE support for four devices, you can only install two IDE hard disk drives. Your IDE controller must support the Enhanced IDE features in order to use Drive E and Drive F. The onboard PCI IDE controller supports Enhanced IDE, with two connectors for connecting up to four IDE devices. If you want to use another controller that supports four drives, you must disable the onboard IDE controller in the Chipset Features Setup screen.

When auto-detection is completed, the program automatically enters all entries you accepted on the field for that drive in the Standard CMOS Setup screen. Skipped entries are ignored and are not entered in the screen.

If you are auto-detecting a hard disk that supports the LBA mode, three lines will appear in the parameter box. Choose the line that lists LBA for an LBA drive. Do not select Large or Normal.

The auto-detection feature can only detect one set of parameters for a particular IDE hard drive. Some IDE drives can use more than one set. This is not a problem if the drive is new and there is nothing on it.

IV. BIOS SOFTWARE

IMPORTANT: If your hard drive was already formatted on an older previous system, incorrect parameters may be detected. You will need to enter the correct parameters manually or use low-level format if you do not need the data stored on the hard drive.

If the parameters listed differ from the ones used when the drive was formatted, the drive will not be readable. If the auto-detected parameters do not match the ones that should be used for your drive, do not accept them. Press the <N> key to reject the presented settings and enter the correct ones manually from the Standard CMOS Setup screen.

Save and Exit Setup

Select this option to save into the CMOS memory all modifications you specify during the current session. To save the configuration changes, highlight the “Save & Exit Setup” option on the main screen and then press the <Enter> key.

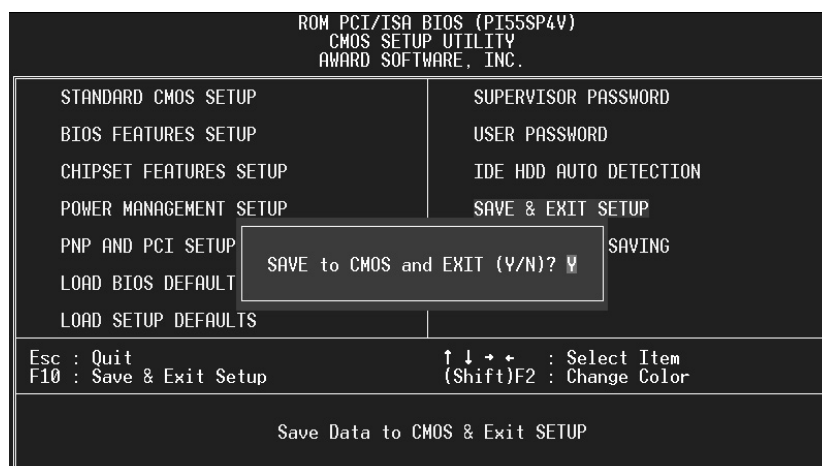

IV. BIOS
(Hard Drive Detect)

Exit Without Saving

Select this option to exit the Setup utility without saving the modifications you specify during the current session. To exit without saving, highlight the “Exit Without Saving” option on the main screen and then press the <Enter> key.

(This page was intentionally left blank)

V. DESKTOP MANAGEMENT

Desktop Management Interface (DMI)

Introducing the ASUS DMI Configuration Utility

This motherboard supports DMI within the BIOS level and provides a DMI Configuration Utility to maintain the Management Information Format Database (MIFD). DMI is able to auto-detect and record information pertinent to a computer's system such as the CPU type, CPU speed, and internal/external frequencies, and memory size. The onboard BIOS will detect as many system information as possible and store those collected information in a 4KB block in the motherboard's Flash EPROM and allow the DMI to retrieve data from this database. Unlike other BIOS software, the BIOS on this motherboard uses the same technology implemented for Plug and Play to allow dynamic real-time updating of DMI information versus creating a new BIOS image file and requiring the user to update the whole BIOS. This DMI Configuration Utility also allows the system integrator or end user to add additional information into the MIFD such as serial numbers, housing configurations, and vendor information. Those information not detected by the motherboard BIOS and has to be manually entered through the DMI Configuration Utility and updated into the MIFD. This DMI Configuration Utility provides the same reliability as PnP updating and will prevent the refreshing failures associated with updating the entire BIOS.

System Requirements

The motherboard BIOS must support DMI. The following motherboards do not support DMI:

- P/I-P6RP4 (not supported)
- PCI/E-P54NP4 (not supported)
- PCI/I-P54NP4D (not supported)

The DMI Configuration Utility (DMICFG.EXE) must be ran in real mode in order for the program to run, the base memory must be at least 180K. Memory managers like HIMEM.SYS (required by windows) must not be installed. You can boot up from a system diskette without AUTOEXEC.BAT and CONFIG.SYS files, "REM" HIMEM.SYS in the CONFIG.SYS, or press <F5> during bootup to bypass your AUTOEXEC.BAT and CONFIG.SYS files.

V. DESKTOP MANAGEMENT

Using the ASUS DMI Configuration Utility

Edit DMI (or delete)

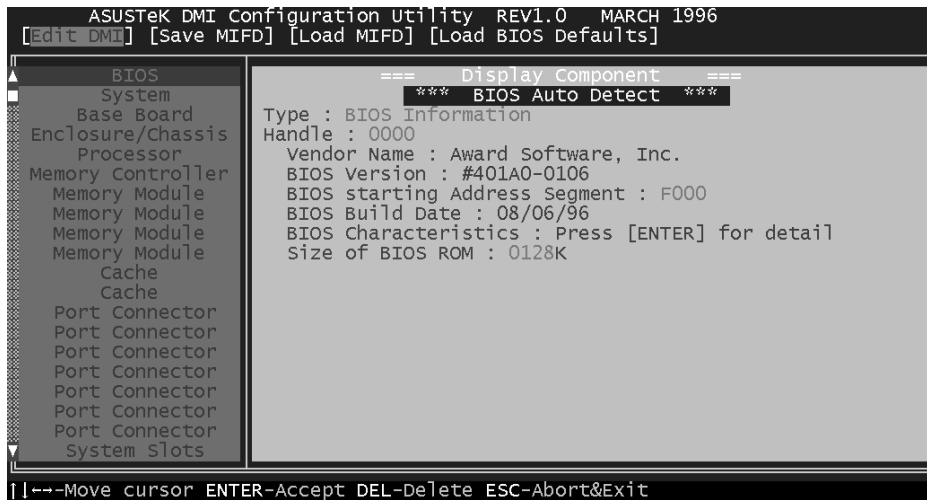

Use the ←→ (left-right) cursors to move the top menu items and the ↑↓ (up-down) cursor to move between the left hand menu items. The bottom of the screen will show the available keys for each screen. Press enter at the menu item to enter the right hand screen for editing. “Edit component” appears on top. The reversed color field is the current cursor position and the blue text are available for editing. The orange text shows auto-detected information and are not available for editing. The blue text “Press [ENTER] for detail” contains a second pop-up menu is available, use the + - (plus-minus) keys to change the settings. Enter to exit *and save*, ESC to exit *and not save*.

If the user has made changes, ESC will prompt you to answer Y or N. Enter Y to go back to the left-hand screen *and save*, enter N to go back to left-hand screen *and not save*. If editing has not been made, ESC will send you back to the left hand menu without any messages.

Notes:

A heading, *** BIOS Auto Detect *** appears on the right for each menu item on the left side that has been auto detected by the system BIOS.

A heading, *** User Modified *** will appear on the right for menu items that has been modified by the user.



V. DESKTOP MANAGEMENT

Save MIFD



You can save the MIFD (normally only saved to flash ROM) to a file by entering the drive and path here. If you want to cancel save, you may press ESC and a message “Bad File Name” appears here to show it was not saved.

Load MIFD



You can load the disk file to memory by entering a drive and path and file name here.

Load BIOS Defaults



You can load the BIOS defaults from a MIFD file and can clear all user modified and added data. You must reboot your computer in order for the defaults to be saved back into the Flash BIOS.

(This page was intentionally left blank)

VI. PCI-SC200 SCSI Card

NCR SCSI BIOS and Drivers

Aside from the system BIOS, the Flash memory chip on the motherboard also contains the NCR SCSI BIOS. This SCSI BIOS works in conjunction with the optional PCI-SC200 SCSI controller card to provide a complete PCI Fast SCSI-2 interface.

All SCSI devices you install to your system require driver software to function. The NCR SCSI BIOS directly supports SCSI hard disks under the DOS, Windows and OS/2 environments. It also uses device drivers from the DOS floppy disk included in the PCI-SC200 controller card package to support hard disks and other SCSI devices working under DOS, Windows, Windows NT, Novell NetWare and OS/2. These drivers provide higher performance than the direct BIOS support. To use these drivers, you must install them into your system and add them to your system configuration files. Driver support for SCSI devices used with SCO UNIX is also provided. These drivers are included in the second SCO UNIX floppy disk. Windows 95 support is also available using the device drivers included within the Windows software. The PCI-SC200 adapter is auto detected as PCI NCRC810 SCSI HOST ADAPTER and uses the NCRC810.MPD driver.

For information about these drivers and their usage, see the Readme files included in the driver packages. You can print out the contents of these files using any text editor program.

The next few pages will instruct you on the installation of the PCI-SC200 Fast SCSI Card.

VI. PCI-SC200 SCSI Card

The PCI-SC200 SCSI Interface Card

Your motherboard may have come with an optional SCSI (Small Computer System Interface) controller card, the PCI-SC200. The card is also available separately. This card works with the SCSI BIOS on the motherboard. Together, they provide a complete PCI Fast SCSI-2 interface. With the card installed in your system you can connect SCSI devices installed in your system case to the internal connector on the card. You also have the additional option of connecting external SCSI devices to the external SCSI-2 connector on the card.

If you get the PCI-SC200 later on as an option, you will need to install it yourself. The setup procedure is explained here.

Setting Up the PCI-SC200

There are two jumper settings you may need to make on the card to set it up. One setting assigns the PCI INT interrupt, the other sets the card's termination.

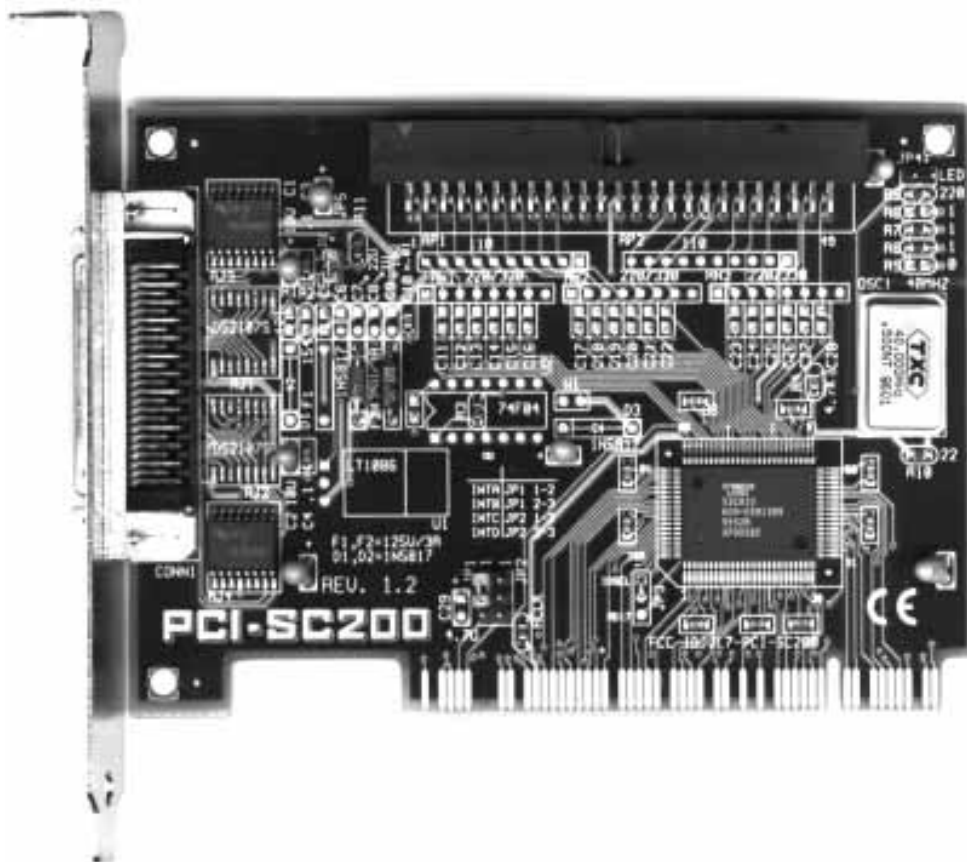

VI. PCI-SC200 SCSI Card

Setting the INT Assignment

You must use PCI INT A setting in order to properly assign the card's interrupt. On the PCI-SC200, you assign the INT by setting jumper JP1 or JP2. The default setting for the card already is INT A, so you do not need to change the setting to use the PCI-SC200 with this motherboard.

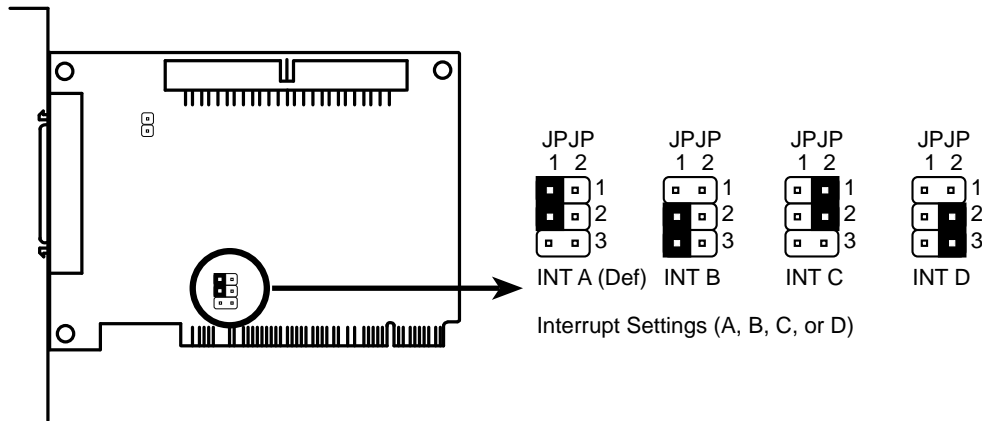

Terminator Settings

SCSI devices are connected together in a “chain” by cables. Internal devices connect to the PCI-SC200 with a fifty-pin flat ribbon cable. External devices connect to the external port with a SCSI-2 cable. If there are more than one internal or external devices, additional devices are connected with cables to form a “daisy chain.” The SCSI chain must be “terminated” at both ends, or the devices in the chain will not work properly.

Many SCSI devices use a set of terminating resistors to terminate the device. The PCI-SC200 has “active” termination that you set using jumper JP5. If you need to terminate the PCI-SC200, you do it by setting the jumper. There are two settings, "terminated" and "not terminated," as shown below.

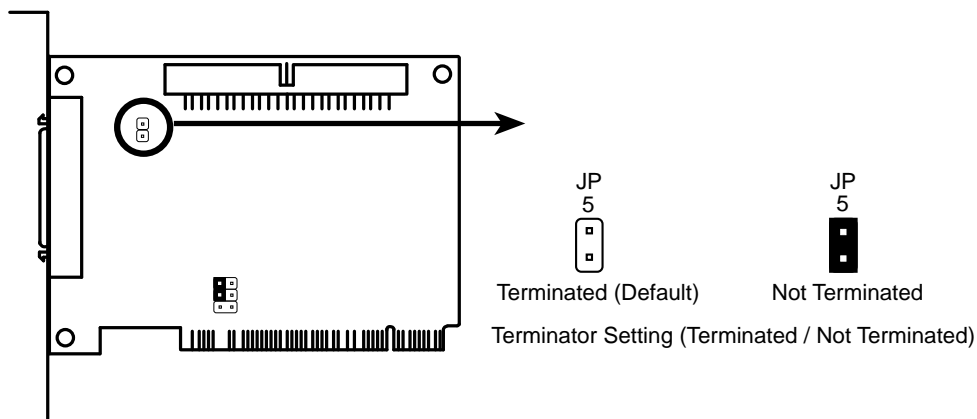

VI. PCI-SC200 SCSI Card

Decide whether or not you need to terminate the PCI-SC200 based on its position in the SCSI chain. Only the devices at each end of the chain need to be terminated. If you have **only** internal or **only** external devices connected to the PCI-SC200, then you **must** terminate the PCI-SC200. If you have **both** internal and external devices connected, you **must not** terminate the card. See the following example which illustrates this concept.

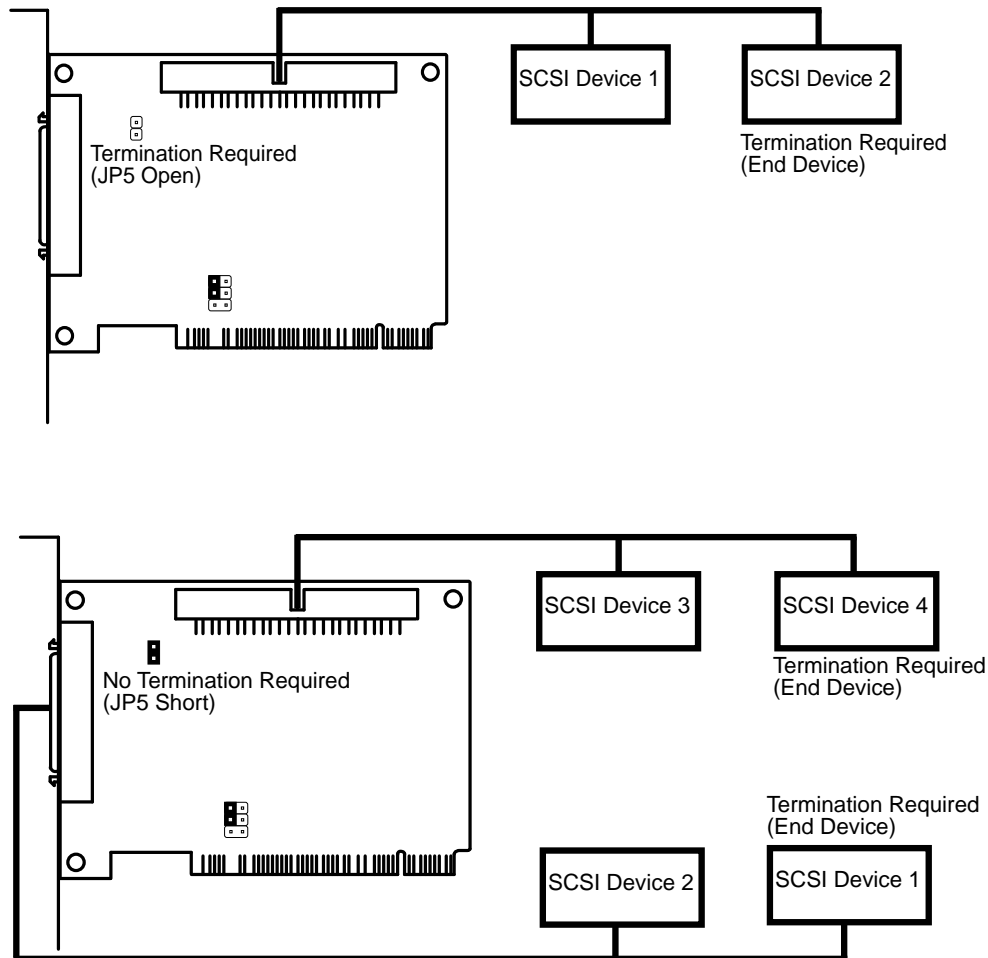

SCSI ID Numbers

All SCSI devices, including the PCI-SC200 interface card must have a SCSI identification number that is not in use by any other SCSI device. There are eight possible ID numbers, 0 through 7. The PCI-SC200 has a fixed SCSI ID of 7.

You can connect up to seven SCSI devices to the interface card. You must set a SCSI ID number for each device. SCSI devices vary in how they set the ID number. Some use jumpers, others have some kind of selector switch. Refer to the manual for any device you install for details on how to set its ID number.

VII. I-A16C Audio Card

The I-A16C 16-bit ISA audio card comes with certain motherboard packages and is not for sale separately.

I-A16C Audio Features

- Creative Labs ViBRA 16C PnP Audio Chip
- Full Duplex Supports
- 16/8 bit PCM 5KHz to 44.1KHz
- Wave Table Upgradeable
- Software Includes:
 - DOS and Window 3.1 Drivers
 - Windows 95 Driver
 - Wave Editor
 - Wave OLE
 - Quick CD
 - Mixer Control
 - Quick Player

Unpacking and Handling Precautions

CAUTION: Keep the I-A16C stored in its anti-static bag until you are ready to install it in your system. The I-A16C is easily damaged by static electricity. Observe the following precautions while unpacking and handling the board:

- Before handling the board, discharge static electricity from your body by touching an unpainted area of the system's metal chassis. While installing the board, ground yourself frequently to discharge any static electricity that may accumulate in your body.
- After removing the board from the anti-static bag, place it on a grounded surface with the components facing up.
- Check the board for damage. If any socketed component appears loose, press firmly but carefully to seat the chip in its socket. Otherwise, avoid touching the components on the board. Always handle the board by the edges.

VII. I-A16C Audio Card

Layout and Connectors

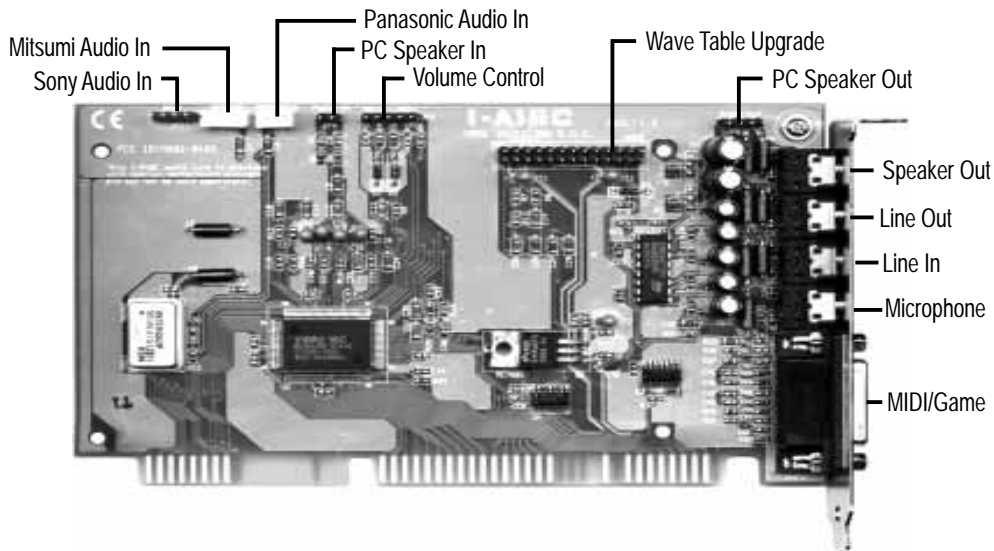

VII. I-A16C
(Layout / Connectors)

Connectors

The audio input connectors are used when you wish to control software mixer settings (bass, treble, volume, etc.) for audio CD's that are played with your CD-ROM. If the "Audio Out" from the CD-ROM is not connected to the "Audio In" on the card, you can only use the direct output located in the front panel of the CD-ROM and adjust volume level by the knob.

Sony Audio In:

<u>Pin</u>	<u>Definition</u>
1	Right Signal
2	Ground
3	Ground

Mitsumi Audio In:

<u>Pin</u>	<u>Definition</u>
1	Ground
2	Left Signal
3	Ground
4	Left Signal

Panasonic Audio In:

<u>Pin</u>	<u>Definition</u>
1	Left Signal
2	Ground
3	Right Signal
4	Right Signal

PC Speaker In:

<u>Pin</u>	<u>Definition</u>
1	Left Signal
2	Ground

PC Speaker Out:

<u>Pin</u>	<u>Definition</u>
1	Right Signal
2	Ground
3	Left Signal
4	Ground

Volume Control:

<u>Pin</u>	<u>Definition</u>
1,3,5	Ground
2	Volume Up
4	Volume Down

ASUS® P/I-P55SP4V

Pentium Motherboard

Video Software Manual



VIII. DOS UTILITY

DOS Utility

1. SVGAUTL.EXE

1.1 *General Description*

SVGAUTL.EXE is one of the utilities of SiS 5596. It supports three functions:

- (1) Video Mode Setting
- (2) Frame Rate Setting
- (3) Power Saving Setting

Since SiS 5596 supports many enhanced Text Mode and Graphic Mode, you can use SVGAUTL.EXE to select the desired video mode.

For 640x480, 800x600, 1024x768, and 1280x1024 resolutions, SiS 5596 supports multiple frame rates.

If your monitor could synchronize with these frame rates, you can use SVGAUTL.EXE to get advantage.

SiS 5596 also supports VESA DPMS Power Saving Modes.

SVGAUTL.EXE can help you to set the capability.

1.2 *How to Use?*

To use SVGAUTL.EXE:

1. Type SVGAUTL in the directory where it resides.
For example, **C:\>SVGAUTL <Enter>** (assuming SVGAUTL.EXE is in C:\)
2. The Main Menu would appear and direct you to configure SiS 5596.
3. When you complete configuration, you may save your preferences to "AUTOEXEC.BAT file and use it as your power-on (or hardware reset) default environment.

VIII. DOS UTILITY

1.3 What the Parameters Stand for?

The meaning of parameters used by SVGAUTL.EXE are explained below:

Syntax:

```
>SVGAUTL [/D:mode_no] [/F0:n0] [/F1:n1] [/F2:n2] [/F3:n3] [/PA:ta] [/PB:tb]
```

where

/D: Set the Video Mode to be mode_no which is a hex number.

For example: Set 1024x768 256 color graphic mode.

```
>SVGAUTL /D:38 <Enter>
```

/F0: For 640x480, set frame rate to be n0 Hz.

Three available frame rates are 60, 72, and 75 Hz.

For example : Set 640x480 graphic mode with 60Hz frame rate

```
>SVGAUTL /F0:60 <Enter>
```

/F1: For 800x600, set frame rate to be n1 Hz.

Four available frame rates are 56, 60, 72, and 75 Hz.

For example : Set 800x600 graphic mode with 72Hz frame rate.

```
>SVGAUTL /F1:72 <Enter>
```

/F2: For 1024x768, set frame rate to be n2 Hz.

Four available frame rates are 87 (Interlace), 60, 70, and 75 Hz.

For example : Set 1024x768 graphic mode with 60Hz frame rate.

```
>SVGAUTL /F2:60 <Enter>
```

/F3: For 1280x1024, set frame rate to be n3 Hz.

Two available frame rates are 87 (Interlace) and 60 Hz.

For example : Set 1280x1024 graphic mode with 60Hz frame rate.

```
>SVGAUTL /F3:60 <Enter>
```

/PA: Set Standby Timer to be ta minutes. (0 < ta < 15 min.)

For example : Set Standby Timer be 5 minutes.

```
>SVGAUTL /PA:5 <Enter>
```

/PB: Set Suspend Timer to be tb minutes. (0 < tb < 15 min.)

For example : Set Suspend Timer be 5 minutes.

```
>SVGAUTL /PB:5 <Enter>
```

- Note:**
1. Suspend Time would be “ta + tb”. (i.e. standby time + suspend time)
 2. The timers will not be very accurate and would just be around the time.

VIII. DOS UTILITY

2. Video Modes

2.1 Standard VGA Modes

Mode	Type	Display Size	Colors Shades	Alpha Format	Buffer Start	Box Size	Max. Pages
0	A/N	320x200	16	40x25	B800	8x8	8
0*	A/N	320x350	16	40x25	B800	8x14	8
0+	A/N	360x400	16	40x25	B800	9x16	8
1	A/N	320x200	16	40x25	B800	8x8	8
1*	A/N	320x350	16	40x25	B800	8x14	8
1+	A/N	360x400	16	40x25	B800	9x16	8
2	A/N	640x200	16	80x25	B800	8x8	8
2*	A/N	640x350	16	80x25	B800	8x14	8
2+	A/N	720x400	16	80x25	B800	9x16	8
3	A/N	640x200	16	80x25	B800	8x8	8
3*	A/N	640x350	16	80x25	B800	8x14	8
3+	A/N	720x400	16	80x25	B800	9x16	8
4	APA	320x200	4	40x 25	B800	8x8	1
5	APA	320x200	4	40x 25	B800	8x8	1
6	AP	640x200	2	80x25	B800	8x8	1
7	A/N	720x350	4	80x25	B000	9x14	8
7+	A/N	720x400	4	80x25	B000	9x16	8
0D	APA	320x200	16	40x25	A000	8x8	8
0E	AP	640x200	16	80x25	A000	8x8	4
0F	APA	640x350	2	80x25	B000	8x14	2
10	AP	640x350	16	80x25	A000	8x14	2
11	APA	640x480	2	80x30	A000	8x16	1
12	AP	640x480	16	80x30	A000	8x16	1
13	AP	320x200	256	40x25	A000	8x8	1

- Note:** 1. A/N: Alpha/Numeric
2. APA: All Point Addressable (Graphic)

VIII. DOS UTILITY

Mode	Display Size	Colors Shades	Frame Rate	H-Sync.	Video Freq.
0	320x200	16	70	31.5 K	25.1 M
0*	320x350	16	70	31.5 K	25.1 M
0+	360x400	16	70	31.5 K	28.3 M
1	320x200	16	70	31.5 K	25.1 M
1*	320x350	16	70	31.5 K	25.1 M
1+	360x400	16	70	31.5 K	28.3 M
2	640x200	16	70	31.5 K	25.1 M
2*	640x350	16	70	31.5 K	25.1 M
2+	720x400	16	70	31.5 K	28.3 M
3	640x200	16	70	31.5 K	25.1 M
3*	640x350	16	70	31.5 K	25.1 M
3+	720x400	16	70	31.5 K	28.3 M
4	320x200	4	70	31.5 K	25.1 M
5	320x200	4	70	31.5 K	25.1 M
6	640x200	2	70	31.5 K	25.1 M
7*	720x350	4	70	31.5 K	28.3 M
7+	720x400	4	70	31.5 K	28.3 M
0D	320x200	16	70	31.5 K	25.1 M
0E	640x200	16	70	31.5 K	25.1 M
0F	640x350	2	70	31.5 K	25.1 M
10	640x350	16	70	31.5 K	25.1 M
11	640x480	2	60	31.5 K	25.1 M
12	640x480	16	60	31.5 K	25.1 M
13	320x200	256	70	31.5 K	25.1 M

Note: i - interlaced mode
n - noninterlaced mode

VIII. DOS UTILITY

2.2 Enhanced Video Modes

Mode	Type	Display Size	Colors Shades	Alpha Format	Buffer Start	Box Size	Max. Pages
22	A/N	1056x352	16	132x44	B800	8x8	2
23	A/N	1056x350	16	132x25	B800	8x14	4
24	A/N	1056x364	16	132x28	B800	8x13	4
25	APA	640x480	16	80x60	A000	8x8	1
26	A/N	720x480	16	80x60	B800	9x8	3
29	APA	800x600	16	100x37	A000	8x16	1
2A	A/N	800x600	16	100x40	B800	8x15	4
2D	APA	640x350	256	80x25	A000	8x14	1
2E	APA	640x480	256	80x30	A000	8x16	1
2F	APA	640x400	256	80x25	A000	8x16	1
30	APA	800x600	256	100x37	A000	8x16	1
37	APA	1024x768	16	128x48	A000	8x16	1
38	APA	1024x768	256	128x48	A000	8x16	1
39	APA	1280x1024	16	160x64	A000	8x16	1
3A	APA	1280x1024	256	160x64	A000	8x16	1
40	APA	320x200	32K	40x25	A000	8x8	1
41	APA	320x200	64K	40x25	A000	8x8	1
42	APA	320x200	16.8M	40x25	A000	8x8	1
43	APA	640x480	32K	80x30	A000	8x16	1
44	APA	640x480	64K	80x30	A000	8x16	1
45	APA	640x480	16.8M	80x30	A000	8x16	1
46	APA	800x600	32K	100x37	A000	8x16	1
47	APA	800x600	64K	100x37	A000	8x16	1
48	APA	800x600	16.8M	100x37	A000	8x16	1
49	APA	1024x768	32K	128x48	A000	8x16	1
4A	APA	1024x768	64K	128x48	A000	8x16	1
4B	APA	1024x768	16.8M	128x48	A000	8x16	1
4C	APA	1280x1024	32K	160x64	A000	8x16	1
4D	APA	1280x1024	64K	160x64	A000	8x16	1

- Note:**
1. A/N: Alpha/Numeric
 2. APA: All Point Addressable (Graphic)

VIII. DOS UTILITY

Mode	Display Size	Colors Shades	Frame Rate	H-Sync.	Video Freq.
22	1056x352	16	70	30.5 K	40.0 M
23	1056x350	16	70	30. K	40.0 M
24	1056x364	16	70	30.5 K	40.0 M
25	640x480	16	60	31.5 K	25.1 M
26	720x480	16	60	31.5 K	25.1 M
29	800x600	16	56	35.1 K	30.0 M
29*	800x600	16	60	37.9 K	40.0 M
29+	800x600	16	72	48.0 K	50.0 M
29#	800x600	16	75	46.8 K	50.0 M
2A	800x600	16	56	35.1 K	36.0 M
2D	640x350	256	70	31.5 K	25.1 M
2E	640x480	256	60	31.5 K	25.1M
2E*	640x480	256	72	37.9 K	31.5 M
2E+	640x480	256	75	37.5 K	31.5 M
2F	640x400	256	70	31.5 K	25.1 M
30	800x600	256	56	35.1 K	36.0 M
30*	800x600	256	60	37.9 K	40.0 M
30+	800x600	256	72	48.0 K	50.0 M
30#	800x600	256	75	46.8 K	50.0 M
37i	1024x768	16	87	35.5 K	44.9 M
37n	1024x768	16	60	48.4 K	65.0 M
37n+	1024x768	16	70	56.5 K	75.0 M
37n#	1024x768	16	75	60.2 K	80.0 M
38i	1024x768	256	87	35.5 K	44.9 M
38n	1024x768	256	60	48.4 K	65.0 M
38n+	1024x768	256	70	56.5 K	75.0 M
38n#	1024x768	256	75	60.2 K	80.0 M
39i	1280x1024	16	89	48.8 K	80.0 M
39n	1280x1024	16	60	65.0 K	110.0 M
3Ai	1280x1024	256	89	48.8 K	80.0 M
3An	1280x1024	256	60	65.0 K	110.0 M

VIII. DOS UTILITY

Mode	Display Size	Colors Shades	Frame Rate	H-Sync.	Video Freq.
40	320x200	32K	70	31.5 K	25.1 M
41	320x200	64K	70	31.5 K	25.1 M
42	320x200	16.8M	70	31.5 K	25.1 M
43	640x480	32K	60	31.5 K	25.1 M
43*	640x480	32K	72	37.9 K	31.5 M
43+	640x480	32K	75	37.5 K	31.5 M
44	640x480	64K	60	31.5 K	25.1 M
44*	640x480	64K	72	37.9 K	31.5 M
44+	640x480	64K	75	37.5 K	31.5 M
45	640x480	16.8M	60	31.5 K	25.1 M
45*	640x480	16.8M	72	37.9 K	31.5 M
45+	640x480	16.8M	75	37.5 K	31.5 M
46	800x600	32K	56	35.1 K	36.0 M
46*	800x600	32K	60	37.9 K	40.0 M
46+	800x600	32K	72	48.0 K	50.0 M
46#	800x600	32K	75	46.8 K	50.0 M
47	800x600	64K	56	35.1 K	36.0 M
47*	800x600	64K	60	37.9 K	40.0 M
47+	800x600	64K	72	48.0 K	50.0 M
47#	800x600	64K	75	46.8 K	50.0 M
48	800x600	16.8M	56	35.1 K	36.0 M
48*	800x600	16.8M	60	37.9 K	40.0 M
48+	800x600	16.8M	72	48.0 K	50.0 M
48#	800x600	16.8M	75	46.8 K	50.0 M
49i	1024x768	32K	87	35.5 K	44.9 M
49n	1024x768	32K	60	48.4 K	65.0 M
49n+	1024x768	32K	70	56.5 K	75.0 M
49n#	1024x768	32K	75	60.2 K	80.0 M
4Ai	1024x768	64K	87	35.5 K	44.9 M
4An	1024x768	64K	60	48.4 K	65.0 M
4An+	1024x768	64K	70	56.5 K	75.0 M
4An#	1024x768	64K	75	60.2 K	80.0 M
4Bi	1024x768	16.8M	87	35.5 K	44.9 M
4Ci	1280x1024	32K	89	48.8 K	80.0 M
4Di	1280x1024	64K	89	48.8 K	80.0 M

Note: i - interlaced mode

n - noninterlaced mode

For the limitation of memory bandwidth in 1MB DRAM configuration, the following video modes is not supported in 1MB configuration: modes 45*, 45+, 46+, 46#, 47+, and 47#.

IX. SOFTWARE DRIVERS

Software Drivers

To make use of the advance features of SiS 5596, extended graphic and text modes are supported by software application drivers developed by SiS. The following applications are currently supported:

- 3D Studio Ver. 3.0
- AutoCAD/386 Release 11, 12
- Auto Shade/386 Ver. 2.0
- MicroSoft Windows 3.1
- MicroSoft Windows NT Ver. 3.1 & 3.5 & 3.51
- MicroSoft Windows 95
- OS/2 Presentation Manager 2.1 & 3.0

IX. SOFTWARE DRIVERS

1. Windows 3.1

1.0 Version Notes

The following description apply to “SiS 5596 Driver Release V1.03a” and maybe later release version but not guaranteed.

1.1 Driver Files

1. The enclosed SiS 5596 Windows 3.1 driver contains the following files (in compressed format) :

Setup Programs	A group of programs used to setup drivers.
VGA800.DR_	800x600 16-color driver
VGA1024.DR_	1024x768 16-color driver
VGA1280.DR_	1280x1024 16-color driver
VGA256.DR_	256-color driver (for all resolution)
VGA32K.DR_	32K-color driver (for all resolution)
VGA64K.DR_	64K-color driver (for all resolution)
VGA16M.DR_	16M-color driver (for all resolution)
VDDISIS.386	Graber file for all resoution and color
OEMSETUP.INF	OEMSETUP file for setup procedure
OEMISIS.INF	Same content as OEMSETUP.INF for setup
DCI Related Programs	DCI driver files
PC-Video Programs	PC Live Video related programs (option)
HW MPEG Programs	HW MPEG-I related programs (option)

IX. SOFTWARE DRIVERS

1.2 Installation

1.2.1 Unpack & Copy

To unpack and copy drivers to where they should reside, please follow the following procedures:

1. Boot up Windows using standard VGA mode.
2. In Windows Program Manager Screen, choose “File” item.
3. In “File Item List”, choose “Run” item.
4. In “Run” Screen, select your driver source. e.g. A:\setup
5. Follows the directions appeared on the screen to complete the unpack & copy procedures.
6. After unpack & copy complete, a “SiS Multimedia Vx.xx” program group would be created and shown on screen.
7. In the “SiS Multimedia Vx.xx” program group, there would be four icons:
 - (1) SiS Multimedia Package: To create a small “SiS Multimedia” icon on the corner of the screen.
 - (2) SVGA Setup: SiS VGA graphics configuration system
 - (3) SiS MMPlayer: To create a “SiS MMPlayer” VCP-like icon on the screen.
 - (4) Center Screen: An utility to adjust the position of display on the screen.

1.2.2 Graphics Setup

1. In “SiS Multimedia Vx.xx” program group, choose “SVGA Setup” icon to enter “SiS VGA Configuration System” screen.
2. In “SiS VGA Configuration System” Screen, choose which options you would like to use.
3. After completing your selections, choose “OK” to make all your selections effective.
4. Choose “Restart Windows” to re-boot Windows using new settings. Or, choose “Continue” to continue your current Windows processes. (But when you re-boot Windows, the new settings would take effect.)

IX. SOFTWARE DRIVERS

1.2.3 Power Saving Setup in Windows

1. In “SiS VGA Configuration System” screen, choose “power saver” item to enter “Power Saver” screen.
2. In “Power Saver” Screen, choose which options you would like to use.
3. After completing the selections, choose “OK” to make all your selections effective.
4. After complete setup, the power_saver would take effect as you request when time up and you may continue your normal process.

1.2.4 Zoom_Key Setup

In “SiS VGA Configuration System” screen, choose “zooming” item to define “hot keys” for zoom-in or zoom-out screen without entering setup program.

The operation principles of zoom-in and zoom-out are as follow:

- (1) The resolution change sequence for zoom-in is
1024x768 ==> 800x600 ==> 640x480 .
- (2) The resolution change sequence for zoom-out is
640x480 ==> 800x600 ==> 1024x768 .
- (3) But you must first be able to zoom-in before you may zoom-out, that means you can not get a resolution larger than that you setup.

To use this feature, please follow the following procedures.

1. In “SiS VGA Configuration System” screen, choose “zooming” item to enter “Zooming Hotkey” screen.
2. In “Zooming Hotkey” Screen, choose which “hot key” you would like to use and enable it.
3. After completing the selections, choose “OK” to make all your selections effective.
4. After complete setup, you may use your own defined hot key to zoom-in or zoom-out screen.

1.2.5 Notes

1. The power saver’s timer settings would be effective even exit Windows back to DOS.

IX. SOFTWARE DRIVERS

1.3 Video Operations

1.3.1 DCI Function

SiS 5596 supports DCI driver for software MPEG playback and other media player programs which could take advantage of DCI.

The SiS 5596 DCI driver is automatically loaded during “Windows Driver Unpack & Copy” process. Therefore it should be transparent to the end-user and any media players could take advantage of it.

1.3.2 SiS MMPlay (SW MPEG)

To make SW MPEG playback more friendly than original SW MPEG player supplier provided, SiS provide an MMPlayer application program to provide an VCP-like (Video Cassette Player) interface.

To take advantage of the SiS MMPlayer, you must first install “SW MPEG Player”. All the SiS provided is just an interface but not a SW MPEG Player at present. If the SW MPEG Player does not exist, the SiS MMPlayer will not work. (Xing or Mediamatics SW MPEG Player supported)

To use the SiS MMPlayer, you just follow the procedures below:

1. In “SiS Multimedia Vx.xx” program group, choose “SiS MMPlayer” icon and SiS MMPlayer VCP-like icon would appear.
2. Enjoy the SW MPEG playback as you like.

IX. SOFTWARE DRIVERS

5596 Support Mode for Direct Draw & DCI (1)

(2)Not Support (3)Insufficient Memory (4)Threshold Limitation

VGA Mem.	Resolution	Color	Frame Rate	VGA Mem.	Resolution	Color	Frame Rate
512KB	640x480	16 256	60 (2)	1MB	1024x768	16 256	85 (2)
			60 (3)				87 I (2)
			72 (3)				60
			75 (3)				70
			85 (3)				75
512KB	800x600	16 256	56 (2)	1MB	1280x1024	16	60 (2)
			60 (2)				75 (2)
			72 (2)				87 I (2)
			75 (2)				85 (4)
			85 (2)				87 (2)
512KB	1024x768	16	56 (3)	1.5MB	640x480	16 256	60 (2)
			60 (3)				60
			72 (3)				72
			75 (3)				75
			85 (3)				85
512KB	1024x768	16	60 (2)			32/64 K	60
			70 (2)				72
			75 (2)				75
			85 (2)				85
			87 I (2)				16.7 M
1 MB	640x480	16 256	60 (2)			16.7 M	60
			60				72
			72				75
			75				85
			85				85
1 MB	800x600	16 32/64 K 16.7 M	60 (3)	1.5 MB	800x600	16	56 (2)
			72 (3)				60 (2)
			75 (3)				72 (2)
			85 (3)				75 (2)
			60 (3)				85 (2)
1 MB	800x600	16 256	56			256	56
			60				60
			72				72
			75				75
			85				85
1 MB	1024x768	16	56 (3)			32/64 K	56
			60 (3)				60
			72 (3)				72
			75 (3)				75
			85 (3)				85
1 MB	1024x768	16	60 (2)			16.7 M	56 (3)
			70 (2)				60 (3)
			75 (2)				72 (3)
							75 (3)
							85 (3)
1 MB	1024x768	16	60 (2)	1.5 MB	1024x768	16	60 (2)
			75 (2)				70 (2)

IX. SOFTWARE DRIVERS

5596 Support Mode for Direct Draw & DCI (2)

(2)Not Supported











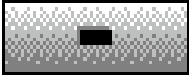



(3)Insufficient Memory

(4)Threshold Limitation

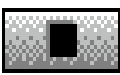
VGA Mem.	Resolution	Color	Frame Rate	VGA Mem.	Resolution	Color	Frame Rate	
1.5 MB	1024x768	16	75 (2)	2 MB	800x600	256	56	
			85 (2)				60	
			87 I (2)				72	
			60				75	
			70				85	
			75				32/64 K	56
		85 (4)	60					
		87 I (2)	72					
		60 (3)	75					
		70 (3)	85					
		75 (3)	16.7 M				56	
		85 (3)	60					
		87 I (2)	72					
		75	85					
1.5 MB	1280x1024	16	60 (2)	2 MB	1024x768	16	60 (2)	
			75 (2)				70 (2)	
			87 I (2)				75 (2)	
			60 (3)				85 (2)	
			75 (3)				87 I (2)	
			87 I (2)				87 I (2)	
2 MB	640x480	16	60 (2)	2 MB	1024x768	256	60	
			60				70	
			72				75	
			75				85	
			85				85 (4)	
			60				87 I (2)	
		72	32/64 K				60	
		75	70					
		85	75					
		60	85 (4)					
		72	87 I (2)					
		75	60 (2)					
		85	75 (2)					
		2 MB	800x600				16	56 (2)
60 (2)	75 (2)							
72 (2)	87 I (2)							
75 (2)	256			60 (3)				
85 (2)	75 (3)							
	87 I (2)							

IX. SOFTWARE DRIVERS

MMPLAY.EXE Button Description

-  : Power On/Off
-  : Open File & Type Control
-  : Minimize This Application
-  : Eject CD Title (Not implemented yet.)
-  : Fast Backward
-  : Fast Forward
-  : Mark in
-  : Mark out
-  : Pause
-  : Play
-  : Stop
-  : End
-  : Begin
-  : Volume increase (Not implemented yet.)
-  : Volume decrease (Not implemented yet.)

(This page was intentionally left blank)

IX. SOFTWARE DRIVERS

2. Windows 95

2.0 Version Note

The following description apply to “SiS 5596 Driver Release V1.02d” and maybe later release version but not guaranteed.

2.1 Driver Files

1. The enclosed SiS 5596 Windows 95 drivers files are:

SISMINI.VXD

SIS596.INF

SIS596.DRV

Other Files

2. All the 16-color, 256-color, 32K/64K-color, and 16M-color drivers are available.

2.2 Installation

1. Boot up Windows 95.
2. In Windows 95 “Booted” Screen, select “My Computer” icon.
3. In “My computer” Screen, select “Control Panel” icon.
4. In “Control Panel” Screen, select “Display” icon.
5. In “Display Properties” Screen, select “Settings” item.
6. In refreshed “Display Properties” Screen, select “Change Display_Type” item.
7. In “Change Display Type” Screen, select “Adapter Type ==> Change” item.
8. In “Select Device” Screen, select “Have Disk...” item.
9. In “Install From Disk” Screen, select your driver source.e.g. A:\WIN95
10. In new “Select Device” Screen, “SiS 5596” would appear and select “OK”. Then Windows 95 would perform driver installation.
11. After completing installation, Windows 95 would go back to “Change Display Type” Screen, select “Close” item.
12. Windows 95 would go back to “Display Properties” Screen, select “Close” or “Apply” item.
13. In “System Settings Change” Screen, select “Yes” item to restart your computer.
14. After restarting, Windows 95 will run on 640x480x256 color, 60NI.

IX. SOFTWARE DRIVERS

2.3 Using “Display Modes”

1. Go to “Display Properties” Screen and you will find that “Display Modes” item had been added.
2. First select “Display Modes” item and you may select desired resolution by changing “Desktop area” pointer, desired color by changing “Color palette” value, desired font size by changing “Font size”, and desired refresh rate by changing “Refresh rate”.
3. After completing selection, select “OK” or “Apply” to complete the whole installation.
4. In “SiS 5596 Settings” Screen, select “OK”.
5. Two cases happen :
 - a). You did not change “color” and/or “font size”.
 1. “SiS 5596 Settings” Screen appears again,
 2. Select “Yes” and you may work on your selected mode now.
 - b). You changed “color” and/or “font size”.
 1. System will reboot.
 2. You may work on your selected mode now.

IX. SOFTWARE DRIVERS

2.4 Utilities

2.4.1 Installation

1. From “Start Menu”, select “Run” item.
2. In “Run” Screen, select your source execution file.
e.g. A:\WIN95\INSTALL\SETUP
3. In “SiS Multimedia Setup Ver x.xx”, select “OK”.
4. A “SiS Multimedia Vx.xx” program group would be created and shown on screen, select “Restart Now”.
5. In the “SiS Multimedia Vx.xx” program group, there are three icons:
 - (1) SiS Multimedia Package: To create a small “SiS Multimedia” icon on the corner of the screen.
 - (2) SiS MMPlayer: To create a “SiS MMPlayer” VCP-like icon on the screen.
 - (3) Center Screen: An utility to adjust the position of display on the screen.
6. “SiS Multimedia V x.xx” program group has been created, select “Restart Now”.

2.4.2 Operation

1. For Video Operations (“SiS MMPlayer”), please refer to section 1.3.

IX. SOFTWARE DRIVERS

3. Windows NT 3.1

3.1 Driver Files

1. The enclosed SiS 5596 Windows NT 3.1 drivers are:

SISTAG	SISV.SYS	
SISV256.DLL	SISV.DLL	OEMSETUP.INF

2. All the 16-color, 256-color, 32K/64K-color, and 16M-color drivers are available.

3.2 Installation

1. Boot up Windows NT 3.1.
2. Run the following procedures:
 - 1) Windows NT 3.1 setup
 - 2) Options
 - 3) Change Systems Settings
 - 4) Display
 - 5) Other
 - 6) Then respond to installation prompts.

4. Windows NT 3.5, 3.51, & 4.0

4.1 Driver Files

1. The enclosed SiS 5596 Windows NT 3.5 & 3.51 drivers are:

SISTAG	SISV.SYS	
SISV256.DLL	SISV.DLL	OEMSETUP.INF

2. All the 16-color, 256-color, 32K/64K-color, and 16M-color drivers are available.

4.2 Installation

1. Boot up Windows NT 3.5 or 3.51.
2. Run the following procedures:
 - 1) Control Panel
 - 2) Display
 - 3) Change Display Type
 - 4) Change
 - 5) Other...
 - 6) Then respond to installation prompts.

IX. SOFTWARE DRIVERS

Windows NT 4.0

4.1 Driver Files

1. The enclosed SiS 5596 Windows NT 4.0 drivers are:

SISV.DLL	SISV256.DLL
SISV.SYS	SISV5596.INF

2. All the 16-color, 256-color, 32K/64K-color, and 16M-color drivers are available.

4.2 Installation

1. Boot up Windows NT 4.0
2. In Windows NT “Booted” Screen, select “My Computer” icon.
3. In “My computer” Screen, select “Control Panel” icon.
4. In “Control Panel” Screen, select “Display” icon.
5. In “Display Properties” Screen, select “Settings” item.
6. In refreshed “Display Properties” Screen, select “Change Display_Type” item.
7. In “Change Display Type” Screen, select “Adapter Type ==> Change” item.
8. In “Select Device” Screen, select “Have Disk...” item.
9. In “Install From Disk” Screen, select your driver source:
10. In “Change Display” screen, when “SiS 5596” appears, select “OK”.
11. In “Third-Party Drivers” screen, select “Yes”.
12. After completing installation, Windows NT would go back to “Change Display Type” Screen, select “Close” item.
13. Windows NT would go back to “Display Properties” Screen, select “Close” or “Apply” item.
14. In “System Settings Change” Screen, select “Yes” item to restart your computer.
15. After restarting, Windows NT 4.0 will run on 640x480x256 color, 60NI.

IX. SOFTWARE DRIVERS

5. Autodesk ADI 4.2 -Protected Mode

5.0 General Description

5.0.1 Driver Files

1. The enclosed SiS 5596 ADI driver contains the following file:
RCPSIS.EXP SiS ADI Driver (for all resolutions & colors)
Note: This version of ADI driver does not support 16-color operation.
2. This driver fits for a series of Autodesk Inc. products including:
 - (1) AutoCAD/386 R11
 - (2) AutoCAD/386 R12
 - (3) AutoShade/386 V2.0
 - (4) 3D Studio V3.0
3. Their installation procedures are different from one program to the others. But the first step of installation is the same for all these programs, that is “To unpack and copy drivers to where you would like them to reside.” Therefore, we will state this step below.
4. As to the real installation procedures for each program, we will give a detail description in Sec. 5.1 to Sec. 5.4.

5.0.2 Unpack & Copy

To unpack and copy drivers to where they should reside, please follow the following procedures:

1. Run “INSTDRV.EXE” where it resides.
2. In “SiS Super VGA Drivers Installation” menu, select “A. ADI 4.2” to unpack and copy drivers. (To select, type “A”)
3. In “Unpack & Copy ADI 4.2 Drivers” screen, **keyin the “drive:\directory” where these drivers would reside** (default C:\ADI42). Program would unpack & copy all related driver files to where you assign.
4. After “unpack and copy” completed, exit the INSTDRV.EXE program.
5. Refer to Sec. 5.1 to Sec. 5.4 for the real installation procedures for each program.

IX. SOFTWARE DRIVERS

5.1 *AutoCAD R11 Setup*

1. The following procedures assume that
 - (1) You have complete “unpack & copy” procedure.
 - (2) Your ADI 4.2 drivers are located in C:\ADI42.
2. Add the following setting to your own batch file for AutoCAD R11 (say ACADR11.BAT) or to your “AUTOEXEC.BAT” file:
SET DSPADI=\ADI42\RCPSIS.EXP <Enter>
3. Delete the configure file ACAD.CFG resides in \ACAD directory.
4. Type ACADR11 <Enter> to configure your AutoCAD R11 system.
5. In “Select Display Device:” item, choose “ADI P386 V4.0/4.1 display”
6. In “Select Display Resolution” screen, choose which display driver you want to use.
7. Go through the whole instructions, and the system would start with the desired display setting.

IX. SOFTWARE DRIVERS

5.2 AutoCAD R1.2 Setup

1. The following procedures assume that
 - (1) You have complete “unpack & copy” procedure.
 - (2) Your SiS ADI 4.2 drivers are located in C:\ADI42.
 - (3) Your AutoCAD R12 program is located in C:\ACADR12.
 - (4) Your AutoCAD R12 default drivers are located in C:\ACADR12\DRV.
 - (5) Your AutoCAD R12 configure file ACAD.CFG is located in C:\ACADR12.
2. Copy the following driver file to C:\ACADR12\DRV: RCPSIS.EXP
You may complete this step by COPY C:\ADI42\RCPSIS.EXP C:\ACADR12\DRV.
3. Delete your original ACAD.CFG file. You may complete this step by DEL C:\ACADR12\ACAD.CFG.
4. Restart your AutoCAD R12 program as usual.
5. AutoCAD R12 will ask you to complete the configuration procedures since it can't find the configure file ACAD.CFG.
6. Follow the instructions of AutoCAD R12 to proceed configuration.
7. In “Available Video Displays:” item, choose the “SiS Super VGA ADI v4.2 Display and Rendering driver” item.
8. In “Select Display Resolution” screen, choose which display driver you want to use.
9. Go through the whole instructions, and the system would start with the selected display setting.

IX. SOFTWARE DRIVERS

5.3 *AutoShade R2.0 Setup*

1. The following procedures assume that
 - (1) You have complete “unpack & copy” procedure.
 - (2) Your ADI 4.2 drivers are located in C:\ADI42.
2. Add the following settings to your batch file for AutoShade R2.0 (say SHADE2.BAT) or to your “AUTOEXEC.BAT” file.
 - (a) For display driver setting, SET DSPADI=\ADI42\RCPSIS.EXP.
 - (b) For rendering driver setting, SET RDPADI=\ADI42\RCPSIS.EXP.
3. Delete the configure file SHADE.CFG.
4. Type SHADE2 <Enter> to re-configure the AutoShade.
5. While prompting “Select display device:”, choose “P386 AutoDesk Device Interface display driver.”
6. While prompting “Select rendering display driver:”, choose “P386 AutoDesk Device Interface rendering driver.”
7. Go through all the instructions, the system would start with the desired display setting.

IX. SOFTWARE DRIVERS

5.4 3D Studio Version 3.0 Setup

1. The following procedures assume that
 - (1) You have complete “unpack & copy” procedure.
 - (2) Your ADI 4.2 drivers are located in C:\ADI42.
2. Create your own **3D Studio V3.0 batch file** (say **3DS3.BAT**) and add the following settings to it, or add the following settings to your “**AUTOEXEC.BAT**” file.
 - (1) **SET RCPADI=C:\ADI42\RCPSIS.EXP**
 - (2) **SET RDPADI=C:\ADI42\RCPSIS.EXP**
3. Execute the new 3DS batch file or reboot the computer using the new “**AUTOEXEC.BAT**” as to make the new settings effective.
4. Change your current working directory to \3DS3 (where your 3D Studio V3.0 usually resides).
5. Delete original configuration file “3DADI.CFG”.
6. Type **3DS VIBCGF** <Enter> to configure your display environment.
7. After the “Company Register Screen” appears, press <Enter> to continue.
8. The “Video Environment Configuration Screen” will appear.

Please follow the following procedures to configure your video display environment.

- (1) In “Main-Display” item,
 - (a) Press <Enter> The selection menu will appear.
 - (b) In selection menu, move cursor to “**RCPADI**”. Press <Enter> to select.
- (2) In “Material-Display” item,
 - (a) Press <Enter> The selection menu will appear.
 - (b) In selection menu, move cursor to “**RCPADI**”. Press <Enter> to select.
- (3) In “Render-Display” item,
 - (a) Press <Enter> The selection menu will appear.
 - (b) In selection menu, move cursor to “**RCPADI**” or “**RDPADI**”. Press <Enter> to select.
- (4) Complete the other selections and exit configuration.

IX. SOFTWARE DRIVERS

9. After exit configure, 3DS will boot automatically using the environment you just select.
10. If your previous configuration is OK, 3DS will ask you to make detail configuration for SiS 5596 drivers. If this didn't happen, please check your previous procedures or contact the technical support people.
11. In the detail configuration for SiS 5596 drivers, just follow the instructions appear on the screen and make your own choice. If you are confused in anything, contact the technical support people for solution.
12. After detail configuration, you will enter the 3DS main display screen and you may begin your 3D Studio work in the environment you make before.
13. Once completing the detail configuration, you may enter 3D Studio in the same configuration simply by type `\3DS\3DS <Enter>` next time.
14. If you want to change your video configuration, just follow the procedures mentioned before to re-configure.

IX. SOFTWARE DRIVERS

6. OS/2 V2.1

6.0 Driver Notes

1. The following description apply to “SiS 5596 Driver Release V1.02d” and maybe later release version but not guaranteed.

6.1 Driver Files

1. The enclosed SiS 5596 OS/2 2.1 driver contains the following files:

SISINST.CMD	SiS driver install program
SVGA.EXE	SiS PMI Generator
S768256.DL@	SiS IBMDEV32.DLL Display Driver
OTHERS	other files required during installation

6.2 Installation

Before install SiS 5596 OS/2 drivers, make sure:

1. Install your OS/2 system using “**VGA display**” option (i.e. standard VGA).
2. Start your OS/2 system.

Install SiS 5596 OS/2 2.1 drivers as following procedures:

1. Enter “OS/2 window” or “OS/2 full screen”.
2. Change directory to which holds the SiS 5596 OS/2 2.1 display drivers and type SISINST <Enter>.

For example, A:\OS2\SBCS.21>SISINST

3. All the Driver Files will be copied to a subdirectory C:\SISDRV and the “Select Screen parameters for SiS SVGA” menu appears and all the resolution (and color) and frame rate supported would be shown on the screen.
4. Choose which one you would like to use and click “OK”.
5. Then installation program would complete all installation process and create a “SiS Setup” for future change mode usage.
6. Shutdown and re-boot OS/2 to make your selection effectively.

IX. SOFTWARE DRIVERS

7. OS/2 V3.0 (Warp)

7.0 Driver & OS/2 Version Notes

1. The following description apply to “SiS 5596 Driver Release V1.03a” and maybe later release version but not guaranteed.
2. All the OS/2 Warp Versions up to SiS 5596 driver Rev. 1.03a would be installed as described in this section except for Double Bytes OS/2 Warp (i.e. Chinese, Japanese, Korea, etc.).
3. For Double Bytes OS/2 Warp installation, please refer to “Sec. 8 Double Bytes OS/2 Warp”.

7.1 Driver Files

The enclosed SiS 5596 OS/2 3.0 driver contains the following files:

SISINST.CMD	SiS driver install program
SVGA.EXE	SiS PMI Generator
S768256.DL@	SiS IBMDEV32.DLL Display Driver
OTHERS	other files required during installation

7.2 Installation

Before install SiS 5596 OS/2 drivers, make sure:

1. Install your OS/2 system using “**VGA display**” option (i.e. standard VGA).
2. Start your OS/2 system.

Install SiS 5596 OS/2 Warp drivers as following procedures:

1. Enter “OS/2 window” or “OS/2 full screen”.
2. Change directory to which holds the SiS 5596 OS/2 3.0 display drivers and type SISINST <Enter>. For example, A:\OS2\SBCS.30>SISINST
3. All the Driver Files will be copied to a subdirectory C:\SISDRV and the “Select Screen parameters for SiS SVGA” menu appears and all the resolution (and color) and frame rate supported would be shown on the screen.
4. Choose which one you would like to use and click “OK”.
5. Then installation program would complete all installation process and create a “SiS Setup” for future change mode usage.
6. Shutdown and re-boot OS/2 to make your selection effectively.

IX. SOFTWARE DRIVERS

8. Double Bytes OS/2 Warp

8.0 Driver & OS/2 Version Notes

1. The following description apply to “SiS 5596 Driver Release V1.02d” and maybe later release version but not guaranteed.
2. The following description apply to “Double Bytes OS/2 Warp” only. (i.e. Chinese, Japanese, Korea, etc.)

8.1 Driver Files

The enclosed SiS 5596 Double Byte OS/2 3.0 driver contains the following files:

SETUP.CMD	SiS driver install program
SVGA.EXE	SiS PMI Generator
S768256.DL@	SiS IBMDEV32.DLL Display Driver
OTHERS	other files required during installation

8.2 Installation

For Double Byte OS/2 Warp limitation, the installation process is a two phase installation and can't complete the whole installation in one-time-process.

1st phase: copy files, modify “config.sys”, create “SiS Install” icon then shutdown and re-boot OS/2.

2nd phase: double clicks “SiS Install” icon to complete the installation

Before install SiS 5596 OS/2 drivers, make sure:

1. Install your OS/2 system using “**VGA display**” option (i.e. standard VGA).
2. Start your OS/2 system.

Install SiS 5596 OS/2 Warp drivers as following procedures:

1st phase:

1. Enter “OS/2 window” or “OS/2 full screen”.
2. Change directory to which holds the SiS 5596 OS/2 3.0 display drivers and type `SETUP <Enter>`, For example, `A:\OS2\DBCS.30>SETUP`
3. All the Driver Files will be copied to a subdirectory `C:\SISDRV` and “SiS Install” icon would be created.
4. After completing “setup” program, shutdown and re-boot OS/2.

2nd phase:

5. After re-booting OS/2, double clicks “SiS Install” icon. Then the “SiS Install” icon would be executed automatically and “Select Screen parameters for SiS SVGA” screen would appeared on the screen.
6. Select the desired resolution (and color) and frame rate on this screen, then click “OK” to complete installation and “SiS Setup” icon would be created for future change modes and frame rate usage.
7. After completing installation, shutdown and re-boot OS/2 to make your selection effectively.