

**ASUS<sup>®</sup> ME-99B**

Socket 370 Baby AT Motherboard

**USER'S MANUAL**

# USER'S NOTICE

---

No part of this manual, including the products and software described in it, may be reproduced, transmitted, transcribed, stored in a retrieval system, or translated into any language in any form or by any means, except documentation kept by the purchaser for backup purposes, without the express written permission of ASUSTeK COMPUTER INC. ("ASUS").

ASUS PROVIDES THIS MANUAL "AS IS" WITHOUT WARRANTY OF ANY KIND, EITHER EXPRESS OR IMPLIED, INCLUDING BUT NOT LIMITED TO THE IMPLIED WARRANTIES OR CONDITIONS OF MERCHANTABILITY OR FITNESS FOR A PARTICULAR PURPOSE. IN NO EVENT SHALL ASUS, ITS DIRECTORS, OFFICERS, EMPLOYEES OR AGENTS BE LIABLE FOR ANY INDIRECT, SPECIAL, INCIDENTAL, OR CONSEQUENTIAL DAMAGES (INCLUDING DAMAGES FOR LOSS OF PROFITS, LOSS OF BUSINESS, LOSS OF USE OR DATA, INTERRUPTION OF BUSINESS AND THE LIKE), EVEN IF ASUS HAS BEEN ADVISED OF THE POSSIBILITY OF SUCH DAMAGES ARISING FROM ANY DEFECT OR ERROR IN THIS MANUAL OR PRODUCT.

Product warranty or service will not be extended if: (1) the product is repaired, modified or altered, unless such repair, modification or alteration is authorized in writing by ASUS; or (2) the serial number of the product is defaced or missing.

Products and corporate names appearing in this manual may or may not be registered trademarks or copyrights of their respective companies, and are used only for identification or explanation and to the owners' benefit, without intent to infringe.

- SiS is a trademark of Silicon Integrated Corporation.
- Intel, LANDesk, and Pentium are registered trademarks of Intel Corporation.
- Celeron is trademark of Intel Corporation.
- IBM and OS/2 are registered trademarks of International Business Machines.
- Symbios is a registered trademark of Symbios Logic Corporation.
- Windows and MS-DOS are registered trademarks of Microsoft Corporation.
- Adobe and Acrobat are registered trademarks of Adobe Systems Incorporated.

The product name and revision number are both printed on the product itself. Manual revisions are released for each product design represented by the digit before and after the period of the manual revision number. Manual updates are represented by the third digit in the manual revision number.

For previous or updated manuals, BIOS, drivers, or product release information, contact ASUS at <http://www.asus.com.tw> or through any of the means indicated on the following page.

SPECIFICATIONS AND INFORMATION CONTAINED IN THIS MANUAL ARE FURNISHED FOR INFORMATIONAL USE ONLY, AND ARE SUBJECT TO CHANGE AT ANY TIME WITHOUT NOTICE, AND SHOULD NOT BE CONSTRUED AS A COMMITMENT BY ASUS. ASUS ASSUMES NO RESPONSIBILITY OR LIABILITY FOR ANY ERRORS OR INACCURACIES THAT MAY APPEAR IN THIS MANUAL, INCLUDING THE PRODUCTS AND SOFTWARE DESCRIBED IN IT.

**Copyright © 1999 ASUSTeK COMPUTER INC. All Rights Reserved.**

Product Name: **ASUS ME-99B**

Manual Revision: **1.01 E403**

Release Date: **June 1999**

# ASUS CONTACT INFORMATION

---

## ASUSTeK COMPUTER INC. (Asia-Pacific)

### *Marketing*

Address: 150 Li-Te Road, Peitou, Taipei, Taiwan 112  
Telephone: +886-2-2894-3447  
Fax: +886-2-2894-3449  
Email: info@asus.com.tw

### *Technical Support*

Tel (English): +886-2-2894-3447 ext. 706  
Tel (Chinese): +886-2-2894-3447 ext. 111  
Fax: +886-2-2895-9254  
Email: tsd@asus.com.tw  
Newsgroup: news2.asus.com.tw  
WWW: www.asus.com.tw  
FTP: ftp.asus.com.tw/pub/ASUS

## ASUS COMPUTER INTERNATIONAL (America)

### *Marketing*

Address: 6737 Mowry Avenue, Mowry Business Center, Building 2  
Newark, CA 94560, USA  
Fax: +1-510-608-4555  
Email: info-usa@asus.com.tw

### *Technical Support*

Fax: +1-510-608-4555  
BBS: +1-510-739-3774  
Email: tsd-usa@asus.com.tw  
WWW: www.asus.com  
FTP: ftp.asus.com.tw/pub/ASUS

## ASUS COMPUTER GmbH (Europe)

### *Marketing*

Address: Harkort Str. 25, 40880 Ratingen, BRD, Germany  
Telephone: 49-2102-445011  
Fax: 49-2102-442066  
Email: sales@asuscom.de

### *Technical Support*

Hotline: 49-2102-499712  
BBS: 49-2102-448690  
Email: tsd@asuscom.de  
WWW: www.asuscom.de  
FTP: ftp.asuscom.de/pub/ASUSCOM

# CONTENTS

---

<b>1. INTRODUCTION .....</b>	<b>7</b>
1.1 How This Manual Is Organized .....	7
1.2 Item Checklist .....	7
<b>2. FEATURES .....</b>	<b>8</b>
2.1 The ASUS ME-99B Motherboard .....	8
2.1.1 Specifications .....	8
2.1.2 Performance .....	9
2.1.3 Intelligence .....	10
2.2 Parts of the ASUS ME-99B Motherboard .....	11
<b>3. HARDWARE SETUP .....</b>	<b>12</b>
3.1 Motherboard Layout .....	12
3.2 Layout Contents .....	13
3.3 Hardware Setup Procedure .....	15
3.4 Motherboard Settings .....	15
3.5 System Memory (DIMM) .....	22
3.5.1 VGA Shared Memory with DIMM .....	22
3.5.2 General DIMM Notes .....	22
3.5.3 DIMM Memory Installation .....	23
3.6 Central Processing Unit (CPU) .....	24
3.7 Expansion Cards .....	25
3.7.1 Expansion Card Installation Procedure .....	25
3.7.2 Assigning IRQs for Expansion Cards .....	25
3.7.3 Assigning DMA Channels for ISA Cards .....	26
3.7.4 ISA Cards and Hardware Monitor .....	26
3.8 External Connectors .....	27
3.9 Power Connection Procedures .....	39
<b>4. BIOS SETUP .....</b>	<b>40</b>
4.1 Flash Memory Writer Utility .....	40
4.1.1 Main Menu .....	40
4.1.2 Managing and Updating Your BIOS .....	42
4.2 BIOS Setup Program .....	43
4.2.1 BIOS Menu Bar .....	44
4.2.2 Legend Bar .....	44
4.3 Main Menu .....	46
4.3.1 Primary & Secondary Master/Slave .....	47

# CONTENTS

---

4.4	Advanced Menu .....	52
4.4.1	Chip Configuration .....	53
4.4.2	I/O Device Configuration .....	55
4.4.3	PCI Configuration .....	57
4.4.4	Shadow Configuration .....	60
4.5	Power Menu .....	61
4.5.1	Power Up Control .....	63
4.5.2	Hardware Monitor .....	64
4.6	Boot Menu .....	65
4.7	Exit Menu .....	67
<b>5.</b>	<b>SOFTWARE SETUP .....</b>	<b>69</b>
5.1	Operating Systems .....	69
5.1.1	Windows 98 First Time Installation .....	69
5.2	ME-99B Support CD .....	70
5.2.1	Installation Menu .....	70
5.3	Install ASUS PC Probe Vx.xx .....	71
5.4	Install Bus Master IDE Driver .....	72
5.5	Install VGA Driver .....	73
5.5.1	Making Monitor Adjustments .....	74
	Video Setting Page .....	74
	Display Modes Page .....	75
	Gamma Correction Page .....	76
5.6	Install Audio Driver (only with onboard audio option) .....	77
5.7	Install ESS AudioRack32 (only with onboard audio) .....	78
5.8	Install ESS Software Wave Table (only with onboard audio) ...	79
5.9	Install PC-Cillin 98 Vx.xx .....	80
5.10	Install ADOBE AcroBat Reader Vx.x .....	81
5.11	Uninstalling Programs .....	82
<b>6.</b>	<b>SOFTWARE REFERENCE .....</b>	<b>83</b>
6.1	ASUS PC Probe .....	83
6.2	AudioRack32 .....	89
6.3	Desktop Management Interface (DMI) .....	98
<b>7.</b>	<b>APPENDIX .....</b>	<b>101</b>
7.1	ASUS PCI-L101 Fast Ethernet Card .....	101

# FCC & DOC COMPLIANCE

---

## ***Federal Communications Commission Statement***

This device complies with FCC Rules Part 15. Operation is subject to the following two conditions:

- This device may not cause harmful interference, and
- This device must accept any interference received, including interference that may cause undesired operation.

This equipment has been tested and found to comply with the limits for a Class B digital device, pursuant to Part 15 of the FCC Rules. These limits are designed to provide reasonable protection against harmful interference in a residential installation. This equipment generates, uses and can radiate radio frequency energy and, if not installed and used in accordance with manufacturer's instructions, may cause harmful interference to radio communications. However, there is no guarantee that interference will not occur in a particular installation. If this equipment does cause harmful interference to radio or television reception, which can be determined by turning the equipment off and on, the user is encouraged to try to correct the interference by one or more of the following measures:

- Re-orient or relocate the receiving antenna.
- Increase the separation between the equipment and receiver.
- Connect the equipment to an outlet on a circuit different from that to which the receiver is connected.
- Consult the dealer or an experienced radio/TV technician for help.

**WARNING!** Any changes or modifications to this product not expressly approved by the manufacturer could void any assurances of safety or performance and could result in violation of Part 15 of the FCC Rules.

## ***Canadian Department of Communications Statement***

This digital apparatus does not exceed the Class B limits for radio noise emissions from digital apparatus set out in the Radio Interference Regulations of the Canadian Department of Communications.

**This Class B digital apparatus complies with Canadian ICES-003.**

**Cet appareil numérique de la classe B est conforme à la norme NMB-003 du Canada.**

# 1. INTRODUCTION

---

## 1.1 How This Manual Is Organized

This manual is divided into the following sections:

- |                       |  |
|-----------------------|--|
| 1) INTRODUCTION       | Manual information and checklist                 |
| 2) FEATURES           | Product information and specifications           |
| 3) HARDWARE SETUP     | Instructions on setting up the motherboard       |
| 4) BIOS SETUP         | Instructions on setting up the BIOS software     |
| 5) SOFTWARE SETUP     | Instructions on setting up the included software |
| 6) SOFTWARE REFERENCE | Reference material for the included software     |
| 7) APPENDIX           | Optional items and general reference             |

## 1.2 Item Checklist

Check that your package is complete. If you discover damaged or missing items, please contact your retailer.

- (1) ASUS Motherboard
- (1) Ribbon cable for master and slave UltraDMA/33 IDE drives
- (1) Ribbon cable for master and slave UltraDMA/33 & UltraDMA/66 IDE drives
- (1) Ribbon cable for (1) 5.25" and (2) 3.5" floppy disk drives
- (1) Ribbon cable for VGA with mounting bracket
- (1) Connector set for serial ports
- (1) Connector set for PS/2 mouse and parallel port
- (1) Bag of spare jumper caps
- (1) Support CD with drivers and utilities
- (1) This Motherboard User's Manual
  
- Connector set for TV Out (with TV Out chip onboard)
- Connector set for LCD (with LCD chip onboard)
- Connector set for audio input/output and game/MIDI port (with audio chip onboard)
- ASUS IrDA-compliant infrared module (optional)
- ASUS USB/MIR module (optional)
- ASUS PCI-L101 Wake-On-LAN 10/100 Fast Ethernet Card (optional)



## 2. FEATURES

---

### 2.1 The ASUS ME-99B Motherboard

The ASUS ME-99B motherboard is carefully designed for the demanding PC user who wants many intelligent features in a small package.

#### 2.1.1 Specifications

- **Intel Processor Support:** Supports Intel's Celeron processor designed for the Socket 370 and packaged in **Plastic Pin Grid Array (PPGA)**.
- **SiS AGPset:** SiS' 620 AGPset with a built-in 6326 AGP 2X graphics controller supports a 100MHz Front Side Bus (FSB) and UltraDMA/66, which allows burst mode data transfer rates of up to 66.6MBps.
- **Enhanced ACPI & Anti-Boot Virus BIOS:** Programmable BIOS (Flash EEPROM), offering enhanced ACPI for Windows 98 compatibility, built-in firmware-based virus protection, and autodetection of most devices for virtually automatic setup.
- **Versatile Memory:** Equipped with three DIMM sockets to support Intel PC100-compliant SDRAMs (up to 768MB).
- **Integrated Graphics:** Integrated AGP 2X graphics controller can use shared system memory or optional dedicated onboard VGA memory (up to 8MB SDRAM).
- **Onboard Audio (optional):** Features an ESS® Solo-1 PCI audio chipset with 3D surround and positioning capability and integrated audio CODEC.
- **Digital Flat Panel Interface (w/optional LCD chip):** A direct digital connection is provided for connecting a digital flat panel to your PC. This interface transmits sharp, bright images by eliminating digital-to-analog and analog-to-digital conversions, which can accumulate noise and degrade image quality.
- **TV Out (w/optional TV Out chip):** Supports optional onboard TV out function.
- **PCI & ISA Expansion:** Provides four 32-bit PCI and two 16-bit ISA expansion slots.
- **Wake-On-LAN Connector:** Supports Wake-On-LAN activity through an optional Ethernet card (see *7.1 ASUS PCI-L101 Fast Ethernet Card*).
- **Super Multi-I/O:** Provides two high-speed UART compatible serial ports and one parallel port with EPP and ECP capabilities.
- **Desktop Management Interface (DMI):** Supports DMI through BIOS, which allows hardware to communicate within a standard protocol creating a higher level of compatibility. (Requires DMI-enabled components.)
- **IrDA:** Supports an optional infrared port module for wireless interface.



## 2. FEATURES

---

### 2.1.2 Performance

- **UltraDMA/66 & UltraDMA/33:** Comes with an onboard PCI Bus Master IDE controller with two connectors that support four IDE devices on two channels. Supports UltraDMA/66, UltraDMA/33, PIO Modes 3 & 4 and Bus Master IDE DMA Mode 2, and Enhanced IDE devices, such as Tape Backup, CD-ROM, CD-R/RW, and LS-120 drives.
- **66/100MHz Asynchronous & 100/100MHz Synchronous Host/DRAM Clock Support:** CPU frequency can operate at 66MHz or 100MHz while system memory operates at 100MHz or 66MHz. This can optimize the VGA performance under shared memory configuration.
- **Double or Quadruple the IDE Transfer Speed:** IDE transfers using UltraDMA/33 Bus Master IDE can handle rates up to 33MB/s and up to 66MB/s using UltraDMA/66 technology. The best of all is that this new technology is compatible with existing ATA-2 IDE specifications so there is no need to upgrade current IDE devices.
- **Concurrent PCI:** Concurrent PCI allows multiple PCI transfers from PCI master buses to memory to CPU.
- **SDRAM Optimized Performance:** ASUS smart series motherboards support the new generation memory, Synchronous Dynamic Random Access Memory (SDRAM), which increases the data transfer rate to 800MB/s max using PC100-compliant SDRAM.
- **ACPI Ready:** ACPI (Advanced Configuration and Power Interface) is also implemented on all ASUS smart series motherboards. ACPI provides more Energy Saving Features for future operating systems (OS) supporting OS Direct Power Management (OSPM) functionality. With these features implemented in the OS, PCs can be ready around the clock, yet satisfy all the energy saving standards. To fully utilize the benefits of ACPI, an ACPI-supported OS, such as Windows 98, must be used.
- **PC'98 Compliant:** Both the BIOS and hardware levels of the motherboard meets PC'98 compliancy. The new PC'98 requirements for systems and components are based on the following high-level goals: Support for Plug and Play compatibility and power management for configuring and managing all system components, and 32-bit device drivers and installation procedures for Windows 95/98/NT.

## 2. FEATURES

---

### 2.1.3 Intelligence

- **Fan Status Monitoring and Alarm:** To prevent system overheat and system damage, the CPU, power supply, and system fans can be monitored for RPM and failure. All the fans are set for its normal RPM range and alarm thresholds.
- **Temperature Monitoring and Alert:** To prevent system overheat and system damage, this motherboard supports Socket 370 processor thermal sensing.
- **Voltage Monitoring and Alert:** System voltage levels are monitored to ensure stable current to critical motherboard components. Voltage specifications are more critical for future processors, so monitoring is necessary to ensure proper system configuration and management.
- **System Resources Alert:** Today's operating systems such as Windows 95/98/NT, and OS/2, require much more memory and hard drive space to present enormous user interfaces and run large applications. The system resource monitor will warn the user before the system resources are used up to prevent possible application crashes. Suggestions will give the user information on managing their limited resources more efficiently.
- **Auto Fan Off:** The system fans will power off automatically **even in sleep mode**. This function reduces both energy consumption and **system noise**, and is an important feature to implement silent PC systems.
- **Dual Function Power Button:** The system can be in one of two states, one is Sleep mode and the other is the Soft-Off mode. Pushing the power button for less than 4 seconds places the system into Sleep mode. When the power button is pressed for more than 4 seconds, it enters the Soft-Off mode.
- **Remote Ring On (requires modem):** This allows a computer to be turned on remotely through an internal or external modem. With this benefit on-hand, any user can access vital information from their computer from anywhere in the world!
- **Message LED (requires ACPI OS support):** Chassis LEDs now act as information providers. Through the way a particular LED illuminates, the user can determine the stage the computer is in. A simple glimpse provides useful information to the user.
- **Keyboard Wake Up:** Keyboard Wake Up can be enabled or disabled to allow the computer to be powered ON using your keyboard.

## 2. FEATURES

### 2.2 Parts of the ME-99B Motherboard

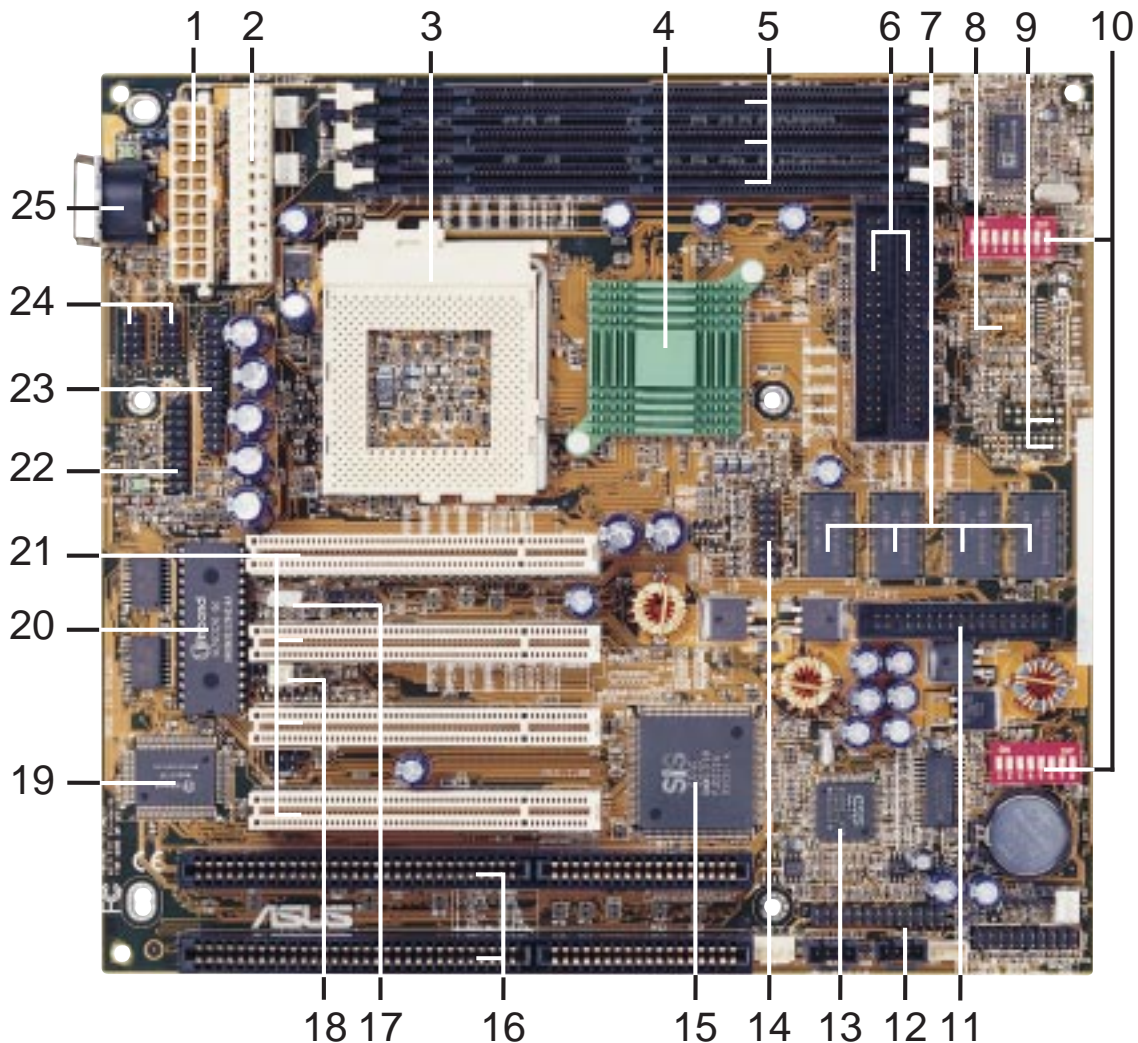

2. FEATURES  
Motherboard Parts

- |    |   |    |  |
|----|---|----|--|
| 1  | ATX Power Connector   | 14 | VGA Header   |
| 2  | AT Power Connector  | 15 | SiS South Bridge with Integrated Hardware Monitoring |
| 3  | CPU ZIF Socket 370  | 16 | 2 ISA Slots  |
| 4  | SiS Chipset with Heatsink   | 17 | Wake-On-LAN Connector                                |
| 5  | DIMM Sockets  | 18 | Wake-On-Ring Connector                               |
| 6  | IDE Connectors  | 19 | Multi I/O Chip                                       |
| 7  | Optional VGA Memory (up to 8MB)   | 20 | Programmable Flash EEPROM                            |
| 8  | LCD chip/TV Out chip (optional)   | 21 | 4 PCI Slots  |
| 9  | LCD Header (w/ LCD chip onboard)<br>TV Out Interface (w/ TV Out chip onboard) | 22 | PS/2 Mouse, USB, IR Connector                        |
| 10 | Function DIP Switches   | 23 | Parallel Port Connector                              |
| 11 | Floppy Disk Drive Connector   | 24 | Serial Port Headers                                  |
| 12 | Audio Connector (w/ onboard audio)  | 25 | Keyboard Connector                                   |
| 13 | ESS Solo-1 Audio Chip (on audio model only)                                   |    |  |

# 3. HARDWARE SETUP

## 3.1 Motherboard Layout

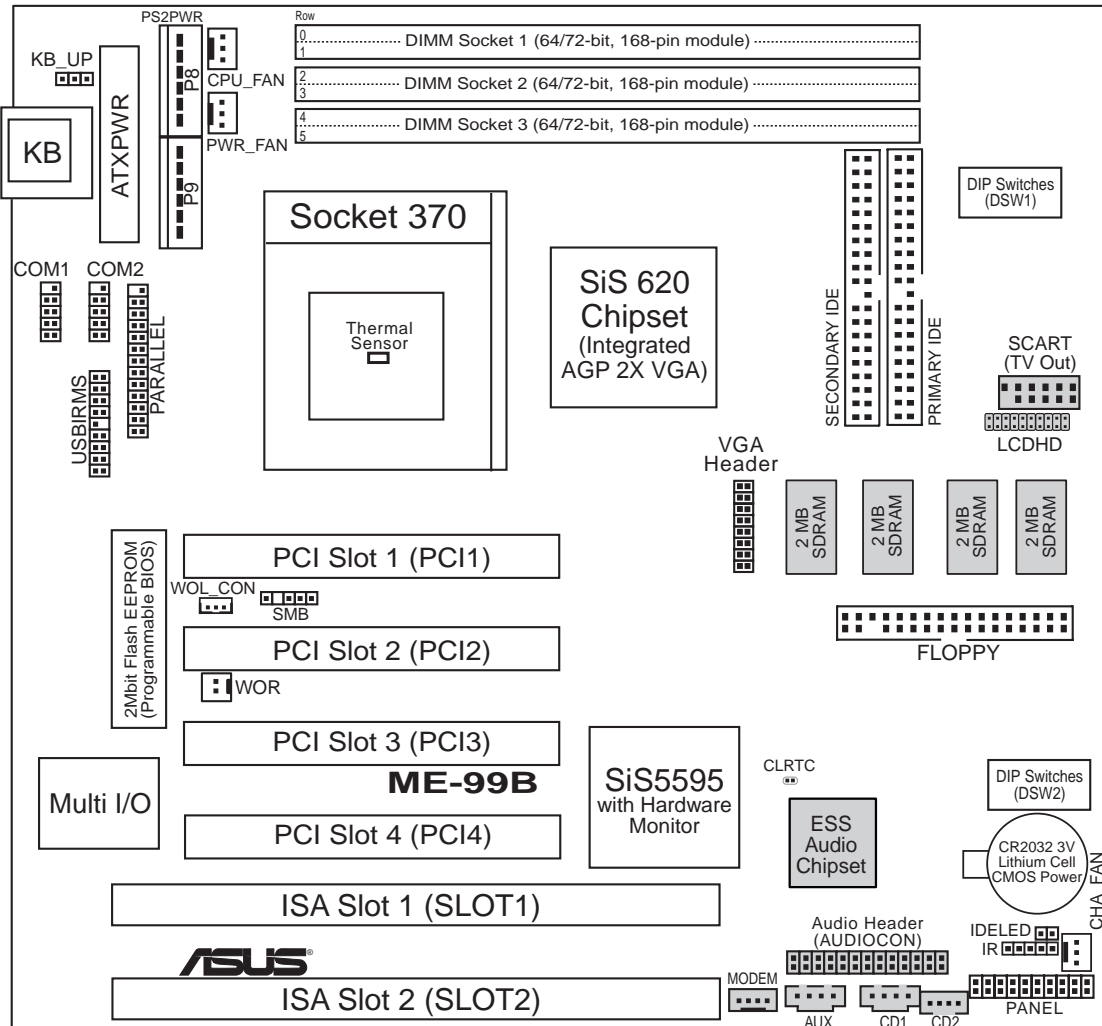

(The grayed items are optional at the time of purchase.)

3. HW/SETUP  
Motherboard Layout



# 3. HARDWARE SETUP

## 3.2 Layout Contents

### Motherboard Settings

- |                           |   |
|---------------------------|---|
| 1) KB_UP                  | p.15 Keyboard Power Up Setting (Enable/Disable)   |
| 2) SW1-6, SW1-7 (DSW1)    | p.16 I/O Voltage Setting (+0.1V/Normal)           |
| 3) SW1-8 (DSW1)           | p.17 CPU Vcore Voltage Setting (+0.1V/Normal)     |
| 4) SW2-5 (DSW2)           | p.17 Onboard VGA Setting (Disable/Enable)         |
| 5) SW2-6 (DSW2)           | p.18 VGA Frame Buffer Setting (UMA/Non-UMA)       |
| 6) SW2-7 (DSW2)           | p.18 LCD Setting (Enable/Disable)                 |
| 7) SW2-8 (DSW2)           | p.19 Onboard Audio Setting (Enable/Disable)       |
| 8) SW1-1, 2, 3, 4 (DSW1)  | p.20 CPU External Frequency Setting               |
| 9) SW1-5 (DSW1)           | p.20 Memory Transfer Mode Setting (SYNC/ASYNCR)   |
| 10) SW2-1, 2, 3, 4 (DSW2) | p.21 CPU Core:External Frequency Multiple Setting |

### Expansion Slots

- |                           |  |
|---------------------------|--|
| 1) DIMM1, DIMM2, DIMM3    | p. 22 168-Pin DIMM Memory Support          |
| 2) Socket 370             | p. 24 Central Processing Unit (CPU) Socket |
| 3) SLOT1, SLOT2           | p. 25 16-bit ISA Bus Expansion Slots*      |
| 4) PCI1, PCI2, PCI3, PCI4 | p. 25 32-bit PCI Bus Expansion Slots       |

### Connectors

- |                          |   |
|--------------------------|---|
| 1) KB                    | p. 27 Keyboard Port Connector (6-pin female)                |
| 2) FLOPPY                | p. 27 Floppy Disk Drive Connector (34-1 pins)               |
| 3) PARALLEL              | p. 28 Parallel Port Connector (25-pin female)               |
| 4) COM1, COM2            | p. 28 Serial Port Headers (9-pin male)                      |
| 5) PRIMARY/SECONDARY IDE | p. 29 Primary/Secondary IDE Connectors (Two 40-1 pins)      |
| 6) IDELED                | p. 29 IDE LED Activity Light (2 pins)                       |
| 7) CPU_,PWR_,CHA_FAN     | p. 30 CPU, Power, and Chassis Fan Connectors (Three 3 pins) |
| 8) WOL_CON               | p. 30 Wake-On-LAN Connector (3 pins)                        |
| 9) IR                    | p. 31 IrDA-Compliant Infrared Module Connector (5 pins)     |
| 10) USBIRMS              | p. 31 USB / IR/ PS/2 Mouse Module Header (18-1 pins)        |
| 11) VGA                  | p. 32 Monitor (VGA) Output Header (15-pin female)           |
| 12) LCDHD                | p. 32 LCD Output Header (20 pins)                           |
| 13) SCART                | p. 33 TV Out Header (12-1 pins)                             |
| 14) MODEM/AUX/CD1/CD2    | p. 33 Internal Audio Connectors (Four 4 pins)               |
| 15) AUDIOCON             | p. 34 Audio Header (26 pins)                                |
| 16) WOR                  | p. 34 Wake-On-Ring Connector (2 pins)                       |
| 17) SMB                  | p. 35 SMBus Connector (5-1 pins)                            |
| 18) PWRLED (PANEL)       | p. 36 System Power LED Lead (3-1 pins)                      |
| 19) KEYLOCK (PANEL)      | p. 36 Keyboard Lock Switch Lead (2 pins)                    |
| 20) SPEAKER (PANEL)      | p. 36 System Warning Speaker Connector (4 pins)             |
| 21) MSG.LED (PANEL)      | p. 36 System Message LED (2 pins)                           |
| 22) SMISW (PANEL)        | p. 36 System Management Interrupt Switch Lead (2 pins)      |
| 23) PWRSW (PANEL)        | p. 37 ATX Power / Soft-Off Switch Lead (2 pins)             |
| 24) RESET (PANEL)        | p. 37 Reset Switch Lead (2 pins)                            |
| 25) PS2PWR               | p. 37 AT Power Supply Connector (20 pins)                   |
| 26) ATXPWR               | p. 38 ATX Power Supply Connector (20 pins)                  |

\*The integrated hardware monitor uses the address 290H-297H so legacy ISA cards must not use this address; otherwise, conflicts will occur.

# 3. HARDWARE SETUP

---

(This page was intentionally left blank)

# 3. HARDWARE SETUP

## 3.3 Hardware Setup Procedure

Before using your computer, you must complete the following steps:

1. Check Motherboard Settings
2. Install Memory Modules
3. Install the Central Processing Unit (CPU)
4. Install Expansion Cards
5. Connect Ribbon Cables, Panel Wires, and Power Supply

## 3.4 Motherboard Settings

This section explains in detail how to change your motherboard's function settings through the use of switches and/or jumpers.

**WARNING!** Computer motherboards and expansion cards contain very delicate Integrated Circuit (IC) chips. To protect them against damage from static electricity, you should follow some precautions whenever you work on your computer.

1. Unplug your computer when working on the inside.
2. Use a grounded wrist strap before handling computer components. If you do not have one, touch both of your hands to a safely grounded object or to a metal object, such as the power supply case.
3. Hold components by the edges and try not to touch the IC chips, leads or connectors, or other components.
4. Place components on a grounded antistatic pad or on the bag that came with the component whenever the components are separated from the system.

### 1) Keyboard Power Up (3-pin KB\_UP)

This allows you to disable or enable the keyboard power up function. Set this jumper to *Enable* if you wish to use your keyboard (by pressing any key or the spacebar depending on your motherboard) to power up your computer. This feature requires an ATX power supply that can supply at least 300mA on the +5VSB lead. The default is set to *Disable* because not all computers have the appropriate ATX power supply. Your computer will not power ON if you set this to *Enable* and do not have the appropriate ATX power supply.

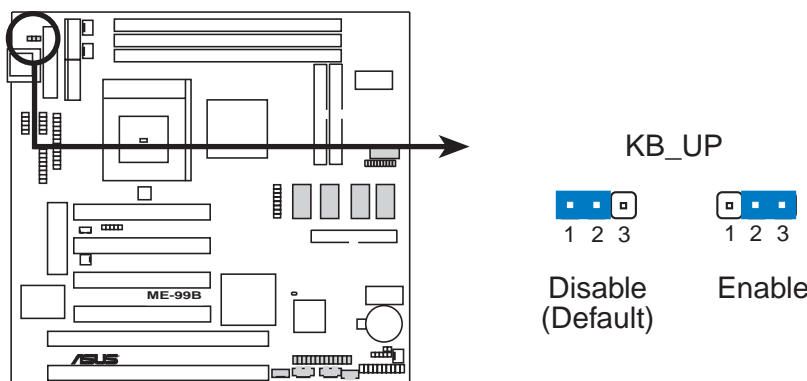

ME-99B Keyboard Power Up



# 3. HARDWARE SETUP

## Motherboard Feature Settings (DIP Switches–DSW1 & DSW2)

The motherboard's onboard functions are adjusted through the DIP switches. The white block represents the switch's position. The example below shows all the switches in the OFF position.

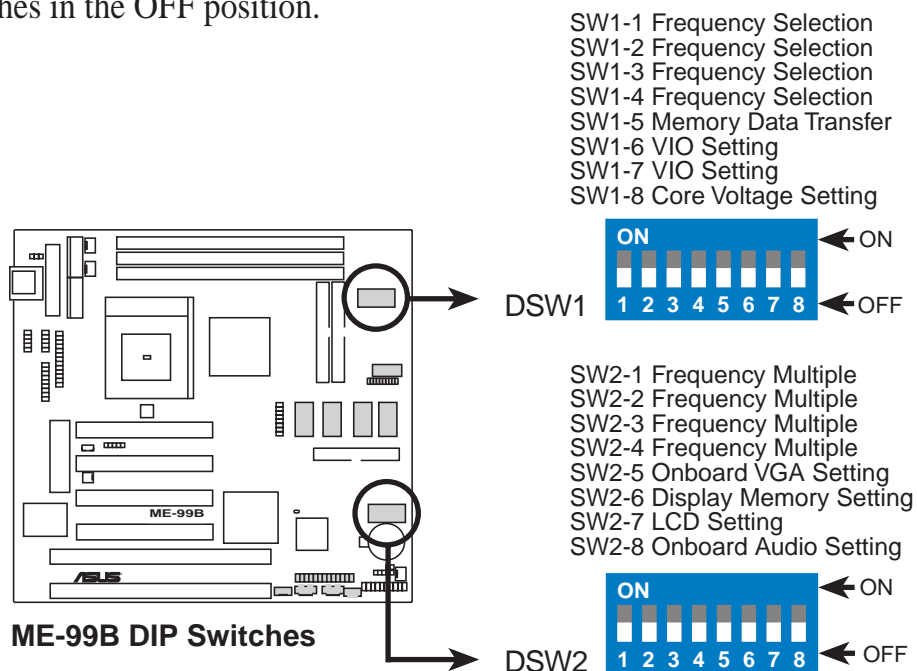

### 2) I/O Voltage Setting (SW1-6, SW1-7)

These switches allow you to select the voltage supplied to the DRAM, chipset, AGPset, and the CPU's I/O buffer. Setting both switches to [ON] increases the voltage supplied by 0.3V.

Setting	SW1-6	SW1-7
Normal	[OFF]	[OFF] (default)
+0.2V	[ON]	[OFF]
+0.3V	[ON]	[ON]

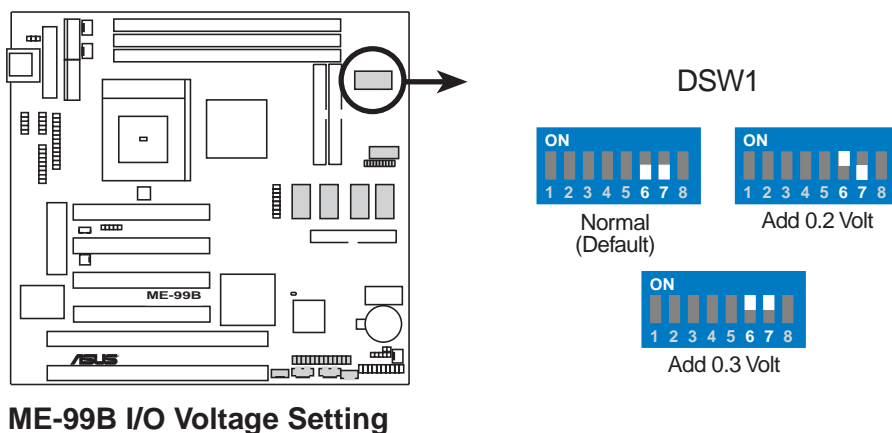

**WARNING!** Using higher voltages may help when overclocking but may result in the shortening of your computer component's life. It is strongly recommended that you leave SW1-6 and SW1-7 on their default settings.

# 3. HARDWARE SETUP

## 3) CPU Core Voltage (VCORE) Setting (SW1-8)

This switch allows you to select the voltage supplied to the CPU.

<b>Setting</b>	<b>SW1-8</b>
Normal	[OFF] (default)
+0.1V	[ON]

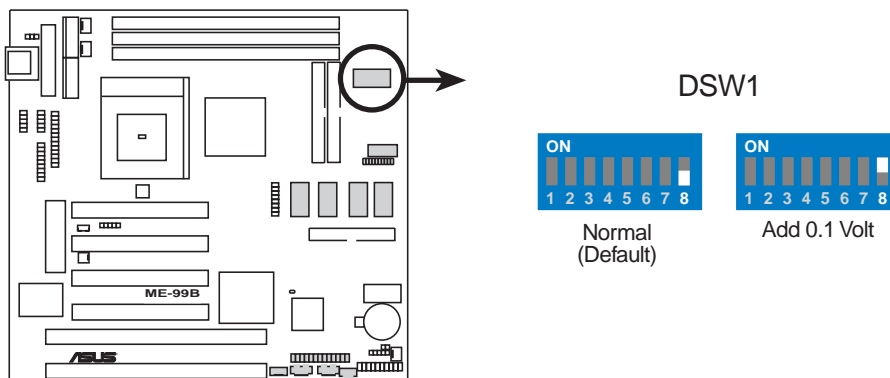

ME-99B CPU Core Voltage Setting

**WARNING!** Using a higher voltage may help when overclocking but may result in the shortening of your computer component's life. It is strongly recommended that you leave SW1-8 on its default setting.

## 4) Onboard VGA Setting (SW2-5)

The onboard AGP VGA may be enabled or disabled using this switch. Disable the onboard VGA if you are using a VGA card on the expansion slot.

<b>Setting</b>	<b>SW2-5</b>
Enable	[OFF] (default)
Disable	[ON]

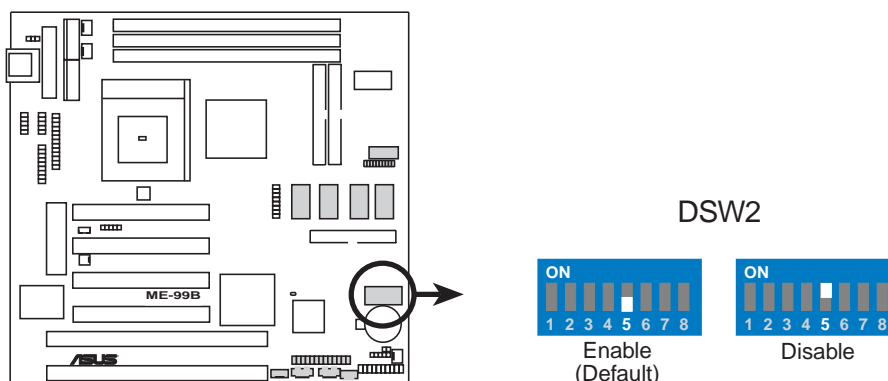

ME-99B Onboard VGA

# 3. HARDWARE SETUP

## 5) Display Memory Setting (SW2-6)

You can select the display memory allocation mode. When *UMA* is selected, the integrated graphics accelerator uses up to 8MB of system memory as display memory. In Non-UMA mode, display memory is shared with system memory. If you disable this, the display memory can be up to 8MB SDRAM.

**NOTE:** When this is set to *UMA*, be sure that there is a DIMM inserted into DIMM socket 1.

### Setting SW2-6

UMA [OFF] (default)

Non-UMA [ON]

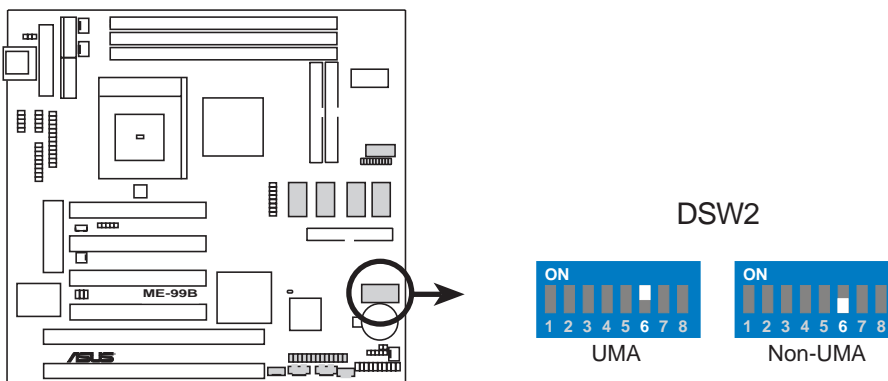

ME-99B Display Memory Setting

## 6) LCD Setting (SW2-7)

If you have an LCD monitor connected to your computer, you can enable it with this switch. **NOTE:** This setting is available only on motherboards with the optional **Digital Flat Panel (DFP)** support.

### Setting SW2-7

LCD DIS. [OFF] (default)

LCD EN. [ON]

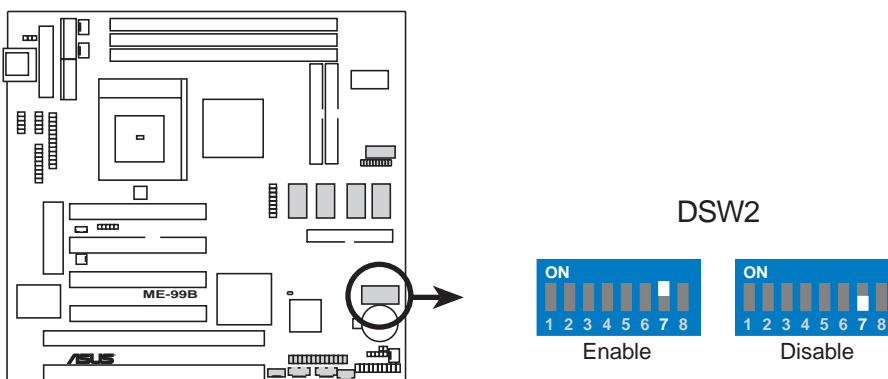

ME-99B LCD Setting

# 3. HARDWARE SETUP

## 7) Onboard Audio Setting (SW2-8)

The onboard 32-bit PCI audio may be enabled or disabled using this switch. Disable the onboard audio if you are using an audio card on the expansion slot.

**NOTE:** This setting is available only on motherboards with the onboard audio option.

<b>Setting</b>	<b>SW2-8</b>
Enable	[ON]
Disable	[OFF]

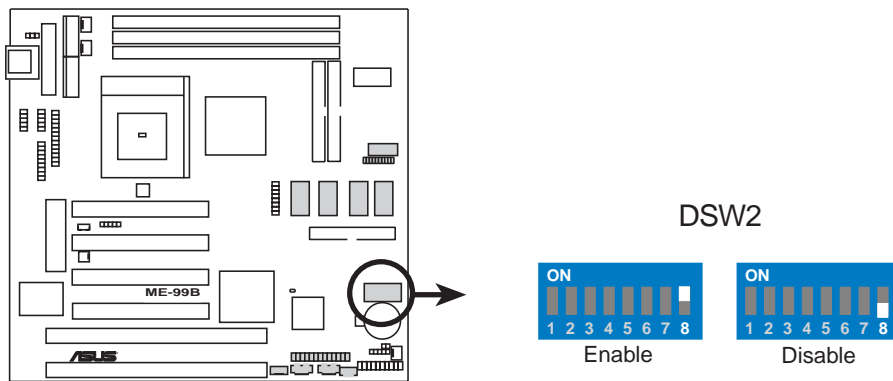

**ME-99B Onboard Audio Setting**

# 3. HARDWARE SETUP

## 8) CPU External Frequency Setting (SW1-1, SW1-2, SW1-3, SW1-4)

This option tells the clock generator what frequency to send to the CPU, DRAM, and the AGPset. This allows the selection of the CPU's *External* frequency. The CPU external frequency multiplied by the Frequency Multiple equals the CPU's *Internal* frequency (the advertised CPU speed). **NOTE:** You may set the memory speed independently from the CPU external frequency. Depending on your memory type PC66 (66MHz) or PC100 (100MHz), select the appropriate "RAM" speed along with the appropriate "CPU" speed.

## 9) Memory Transfer Mode Setting (SW1-5)

You can set the memory clock frequency to be in synchronous or asynchronous mode with respect to the CPU external frequency.

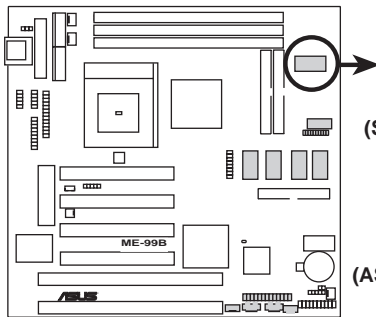

**ME-99B  
CPU External  
Frequency Settings**

(SYNC)				
CPU	66.82MHz	75.00MHz	90.00MHz	95.00MHz
DIMM	66.82MHz	75.00MHz	90.00MHz	95.00MHz
PCI	33.41MHz	37.50MHz	30.00MHz	31.66MHz
(SYNC)				
CPU	100.23MHz	105.00MHz	112.00MHz	115.00MHz
DIMM	100.23MHz	105.00MHz	112.00MHz	115.00MHz
PCI	33.41MHz	35.00MHz	37.33MHz	38.33MHz
(SYNC)				
CPU	120.00MHz	124.00MHz	130.00MHz	133.30MHz
DIMM	120.00MHz	124.00MHz	130.00MHz	133.30MHz
PCI	40.00MHz	31.00MHz	32.50MHz	33.33MHz
(SYNC)				
CPU	140.00MHz	144.97MHz	150.00MHz	155.00MHz
DIMM	140.00MHz	145.00MHz	150.00MHz	155.00MHz
PCI	35.00MHz	36.24MHz	37.50MHz	38.75MHz
(ASYNC)				
CPU	66.82MHz	75.00MHz	90.00MHz	95.00MHz
DIMM	100.23MHz	100.00MHz	60.00MHz	63.33MHz
PCI	33.41MHz	37.50MHz	30.00MHz	31.66MHz
(ASYNC)				
CPU	100.23MHz	105.00MHz	112.00MHz	115.00MHz
DIMM	66.82MHz	70.00MHz	74.66MHz	76.66MHz
PCI	33.41MHz	35.00MHz	37.33MHz	38.33MHz
(ASYNC)				
CPU	120.00MHz	124.00MHz	130.00MHz	133.30MHz
DIMM	80.00MHz	82.67MHz	86.67MHz	88.87MHz
PCI	40.00MHz	31.00MHz	32.50MHz	33.33MHz
(ASYNC)				
CPU	140.00MHz	144.97MHz	150.00MHz	155.00MHz
DIMM	93.33MHz	96.65MHz	100.00MHz	103.33MHz
PCI	35.00MHz	36.24MHz	37.50MHz	38.75MHz

# 3. HARDWARE SETUP

## 10) CPU Core:External Frequency Multiple Setting

(SW2-1, SW2-2, SW2-3, SW2-4)

This option sets the frequency multiple between the *Internal* frequency of the CPU and the CPU's *External* frequency. These must be set in conjunction with the *CPU External frequency*.

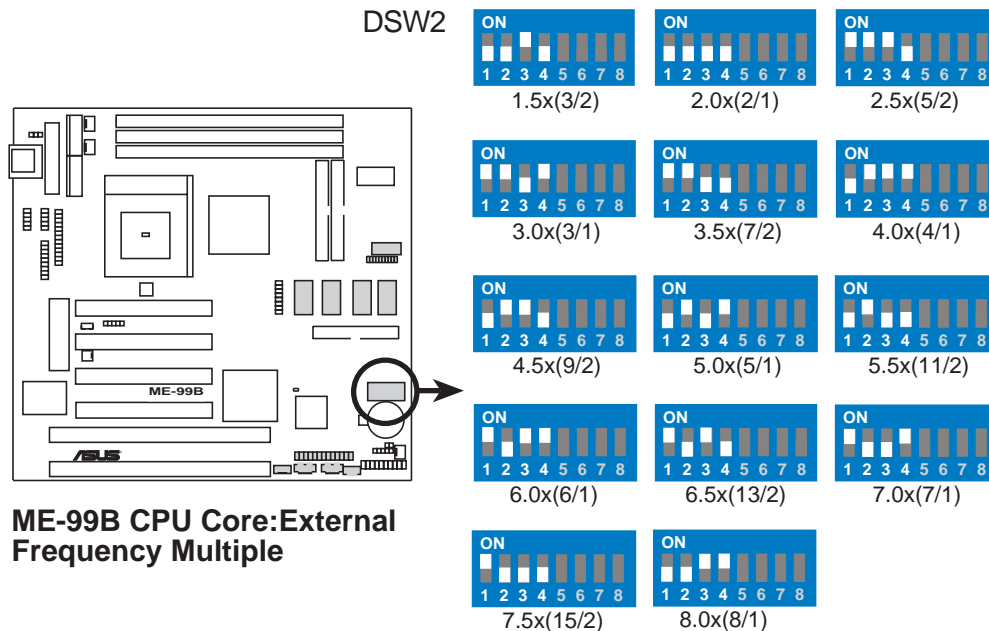

Set the DIP switches by the Internal speed of your processor as follows:

Intel CPU Model	Speed	Mult	Freq.	(CPU External Frequency)				(Frequency Multiple)			
				SW1-1	SW1-2	SW1-3	SW1-4	SW2-1	SW2-2	SW2-3	SW2-4
Celeron (PPGA)	500MHz	7.5x	66MHz	[ON]	[ON]	[ON]	[ON]	[ON]	[OFF]	[OFF]	[OFF]
Celeron (PPGA)	466MHz	7.0x	66MHz	[ON]	[ON]	[ON]	[ON]	[ON]	[OFF]	[OFF]	[ON]
Celeron (PPGA)	433MHz	6.5x	66MHz	[ON]	[ON]	[ON]	[ON]	[ON]	[OFF]	[ON]	[OFF]
Celeron (PPGA)	400MHz	6.0x	66MHz	[ON]	[ON]	[ON]	[ON]	[ON]	[OFF]	[ON]	[ON]
Celeron (PPGA)	366MHz	5.5x	66MHz	[ON]	[ON]	[ON]	[ON]	[OFF]	[ON]	[OFF]	[OFF]
Celeron (PPGA)	333MHz	5.0x	66MHz	[ON]	[ON]	[ON]	[ON]	[OFF]	[ON]	[OFF]	[ON]
Celeron (PPGA)	300MHz	4.5x	66MHz	[ON]	[ON]	[ON]	[ON]	[OFF]	[ON]	[ON]	[OFF]

**WARNING!** Frequencies above 100MHz exceed the specifications for the on-board chipset and are not guaranteed to be stable. PCI frequencies above 33MHz exceed the specifications for PCI cards and are not guaranteed to be stable.

## 3. HARDWARE SETUP

### 3.5 System Memory (DIMM)

**NOTE:** No hardware or BIOS setup is required after adding or removing memory. This motherboard uses only Dual Inline Memory Modules (DIMMs). Sockets are available for **3.3Volt** (power level) unbuffered Synchronous Dynamic Random Access Memory (SDRAM).

The SiS chipset does not support ECC. However, ECC memory modules may still be used, but the ECC function will not be available.

Memory speed setup is recommended through **SDRAM Configuration** in **4.4.1 Chip Configuration**.

*Install memory in any combination as follows:*

DIMM Location	168-pin DIMM		Total Memory
Socket 1 (Rows 0&1)	SDRAM 8, 16, 32, 64, 128, 256MB	x1	
Socket 2 (Rows 2&3)	SDRAM 8, 16, 32, 64, 128, 256MB	x1	
Socket 3 (Rows 4&5)	SDRAM 8, 16, 32, 64, 128, 256MB	x1	
	<b>Total System Memory (Max 768MB)</b>	=	

**NOTE:** At the time this User's Manual was written, 256MB DIMMs are only available as registered memory.

#### 3.5.1 VGA Shared Memory with DIMM

When using DIMM as shared memory for the onboard VGA, be sure that there is a DIMM inserted into DIMM socket 1.

#### 3.5.2 General DIMM Notes

- **For the system CPU bus to operate at 100MHz, use only PC100-compliant DIMMs.** When this motherboard operates at 100MHz, most system will not even boot if non-compliant modules are used because of the strict timing issues involved under this speed. If your DIMMs are not PC100-compliant, set the CPU external frequency to 66MHz RAM to ensure system stability. **NOTE:** If your motherboard supports asynchronous mode, set the memory clock frequency to 66MHz.
- ASUS motherboards support SPD (Serial Presence Detect) DIMMs. This is the memory of choice for best performance vs. stability.
- SDRAM chips are generally thinner with higher pin density than EDO (Extended Data Output) chips.
- BIOS shows SDRAM memory on bootup screen.



# 3. HARDWARE SETUP

## 3.5.3 DIMM Memory Installation

Insert the module(s) as shown. Because the number of pins are different on either side of the breaks, the module will only fit in the orientation as shown. DIMM modules are longer and have different pin contact on each side and therefore have a higher pin density. SIMM modules have the same pin contact on both sides.

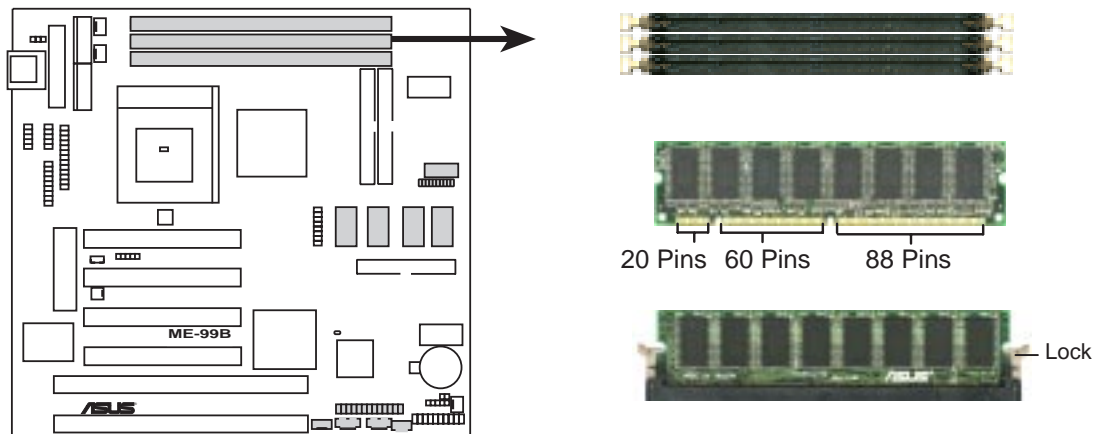

**ME-99B 168-Pin DIMM Memory Sockets**

The DIMMs must be **3.3V Unbuffered** for this motherboard. To determine the DIMM type, check the notches on the DIMMs (see figure below).

### 168-Pin DIMM Notch Key Definitions (3.3V)

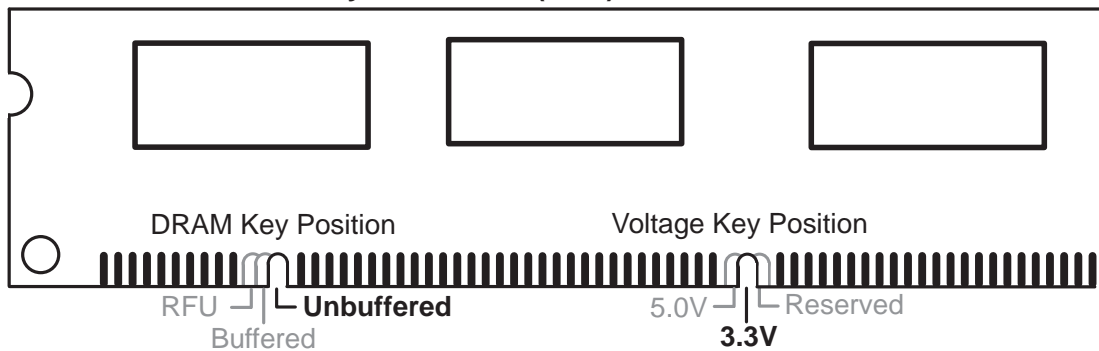

The notches on the DIMM module will shift between left, center, or right to identify the type and also to prevent the wrong type from being inserted into the DIMM slot on the motherboard. You must ask your retailer the correct DIMM type before purchasing. This motherboard supports four clock signals.

# 3. HARDWARE SETUP

## 3.6 Central Processing Unit (CPU)

This motherboard provides a ZIF (Zero Insertion Force) Socket 370. The CPU for your motherboard should have a fan attached to it to prevent overheating. If this is not the case, then purchase a fan before you turn on your system.

**WARNING!** Be sure that there is sufficient air circulation across the processor's heatsink by regularly checking that your CPU fan is working. Without sufficient circulation, the processor could overheat and damage both the processor and the motherboard. You may install an auxiliary fan, if necessary.

To install a CPU, first turn off your system and remove its cover. Locate the ZIF socket and open it by first pulling the lever sideways away from the socket then upwards to a 90-degree angle. Insert the CPU with the correct orientation as shown. The notched corner should point towards the end of the lever. Because the CPU has a corner pin for two of the four corners, the CPU will only fit in the orientation as shown. The picture below is for reference only; you should have a CPU fan that covers the face of the CPU. With the added weight of the CPU fan, no force is required to insert the CPU. Once completely inserted, push the socket's lever down while holding down the CPU.

**NOTE:** Do not forget to set the correct Bus Frequency and Multiple for your Socket 370 processor or else your system may start. Socket 370 processors provide internal thermal sensing so that a socket mounted thermal resistor is not needed.

**CAUTION:** Be careful not to scrape the motherboard when mounting a clamp-style processor fan or else damage may occur to the motherboard.

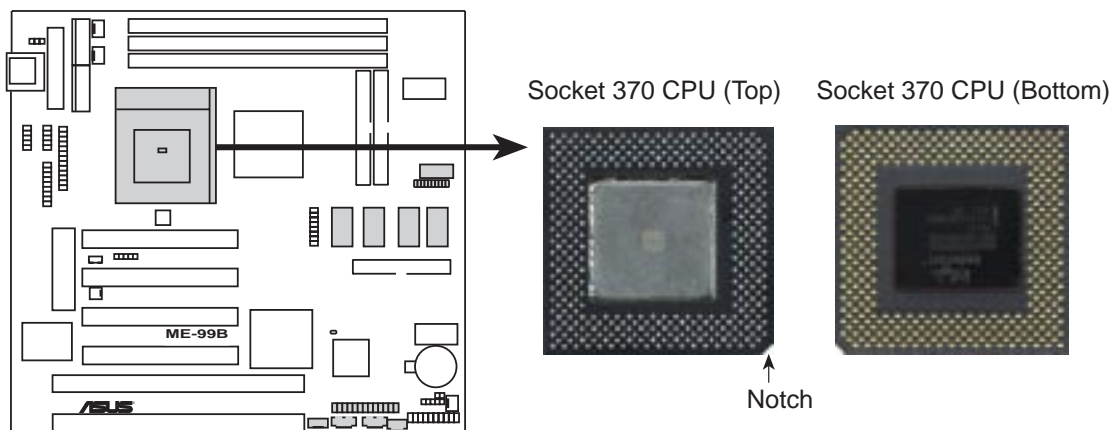

ME-99B Socket 370

## 3. HARDWARE SETUP

---

### 3.7 Expansion Cards

**WARNING!** Make sure that you unplug your power supply when adding or removing expansion cards or other system components. Failure to do so may cause severe damage to both your motherboard and expansion cards.

#### 3.7.1 Expansion Card Installation Procedure

1. Read the documentation for your expansion card and make any necessary hardware settings for your expansion card, such as jumpers or switches.
2. Remove your computer system's cover and the bracket plate on the slot you intend to use. Keep the bracket for possible future use.
3. Carefully align the card's connectors and press firmly.
4. Secure the card on the slot with the screw you removed above.
5. Replace the computer system's cover.
6. Set up the BIOS if necessary  
(such as *IRQ xx Used By ISA: Yes*)
7. Install the necessary software drivers for your expansion card.

#### 3.7.2 Assigning IRQs for Expansion Cards

Some expansion cards need to use an IRQ to operate. Generally, an IRQ must be exclusively assigned to one use. In a standard design, there are 16 IRQs available but most of them are already in use, leaving 6 IRQs free for expansion cards. If your motherboard has **PCI** audio onboard, an extra IRQ will be used, leaving 5 IRQs free. If your motherboard has **ISA** audio onboard, an extra 3 IRQs will be used, leaving 3 IRQs free.

Both ISA and PCI expansion cards may require IRQs. System IRQs are available to cards installed in the ISA expansion bus first, then any remaining IRQs are available to PCI cards. Currently, there are two types of ISA cards.

The original ISA expansion card design, now referred to as "Legacy" ISA cards, requires that you configure the card's jumpers manually and then install it in any available slot on the ISA bus. To see a map of your used and free IRQs in Windows 98, the Control Panel icon in My Computer, contains a System icon, which gives you a Device Manager tab. Double-clicking on a specific hardware device gives you the Resources tab which shows the Interrupt number and address. Make sure that no two devices use the same IRQ or your computer will experience problems when those two devices are in use at the same time.

## 3. HARDWARE SETUP

---

To simplify this process, this motherboard complies with the Plug and Play (PNP) specification, which was developed to allow automatic system configuration whenever a PNP-compliant card is added to the system. For PNP cards, IRQs are assigned automatically from those available.

If the system has both Legacy and PNP ISA cards installed, IRQs are assigned to PNP cards from those not used by Legacy cards. The PCI and PNP configuration of the BIOS setup utility can be used to indicate which IRQs are being used by Legacy cards. For older Legacy cards that do not work with the BIOS, you can contact your vendor for an ISA Configuration Utility.

An IRQ number is automatically assigned to PCI expansion cards after those used by Legacy and PNP ISA cards. In the PCI bus design, the BIOS automatically assigns an IRQ to a PCI slot that has a card in it that requires an IRQ. To install a PCI card, you need to set something called the INT (interrupt) assignment. Since all the PCI slots on this motherboard use an INTA #, be sure that the jumpers on your PCI cards are set to INT A.

### 3.7.3 Assigning DMA Channels for ISA Cards

Some ISA cards, both legacy and PnP, may also need to use a DMA (Direct Memory Access) channel. DMA assignments for this motherboard are handled the same way as the IRQ assignment process described earlier. To select a DMA channel, see **PCI/PNP ISA DMA Resource Exclusion** in *4.4.3 PCI Configuration*. **NOTE:** The on-board audio by default uses DMA1.

**IMPORTANT:** To avoid conflicts, reserve the necessary IRQs and DMAs for legacy ISA cards (see **PCI/PNP ISA IRQ Resource Exclusion** and **PCI/PNP DMA IRQ Resource Exclusion** in *4.4.3 PCI Configuration*). Choose *Yes* in **IRQ xx Used By ISA** and **DMA x Used By ISA** for those IRQs and DMAs you want to reserve).

### 3.7.4 ISA Cards and Hardware Monitor

The integrated hardware monitor uses the address 290H-297H, so legacy ISA cards must not use this address or else conflicts will occur.

# 3. HARDWARE SETUP

## 3.8 External Connectors

**WARNING!** Some pins are used for connectors or power sources. These are clearly distinguished from jumpers in *3.1 Motherboard Layout*. Placing jumper caps over these connector pins will cause damage to your motherboard.

**IMPORTANT:** Ribbon cables should always be connected with the red stripe on Pin 1 side of the connector. The four corners of the connectors are labeled on the motherboard. Pin 1 is the side closest to the power connector for hard drives and floppy drives. IDE ribbon cables must be less than 46 cm (18 in.), with the second drive connector no more than 15 cm (6 in.) from the first connector.

### 1) Keyboard Connector (5-pin KB)

This connector supports either a standard IBM-compatible, 101/102-key, or 104-key keyboard (Windows 95-compatible). Use a PS/2 keyboard adapter in order to connect a PS/2 keyboard to this AT connector.

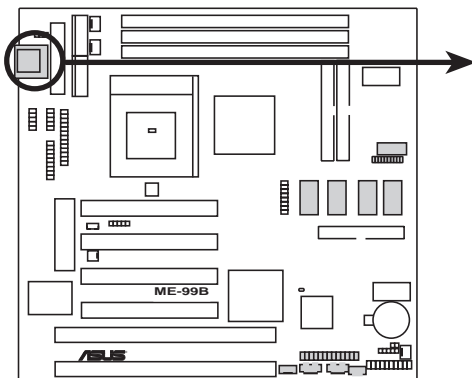

Keyboard Connector (5-pin female)



This motherboard accepts an AT Keyboard Connector Plug as shown here.

ME-99B Keyboard Connector

### 2) Floppy Disk Drive Connector (34-pin FLOPPY)

This connector supports the provided floppy drive ribbon cable. After connecting the single end to the board, connect the two plugs on the other end to the floppy drives. (**Pin 5 is removed to prevent inserting in the wrong orientation when using ribbon cables with pin 5 plugged**).

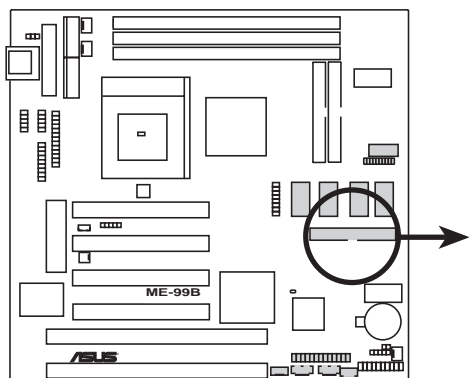

Floppy Disk Drive Connector



ME-99B Floppy Disk Drive Connector

# 3. HARDWARE SETUP

## 3) Parallel Printer Connector (26-1 pin PARALLEL)

This connector supports the included parallel and PS/2 mouse connector set. Connect the parallel ribbon cable to this connector and mount the bracket to the case on an open slot. A PS/2 mouse connector is included if the optional USB/MIR connector is not used. You can make available the parallel port and choose the IRQ through **Onboard Parallel Port** (see **4.4.2 I/O Device Configuration**). **(Pin 26 is removed to prevent inserting in the wrong orientation when using ribbon cables with pin 26 plugged).**

**NOTE:** Serial printers must be connected to the serial port.

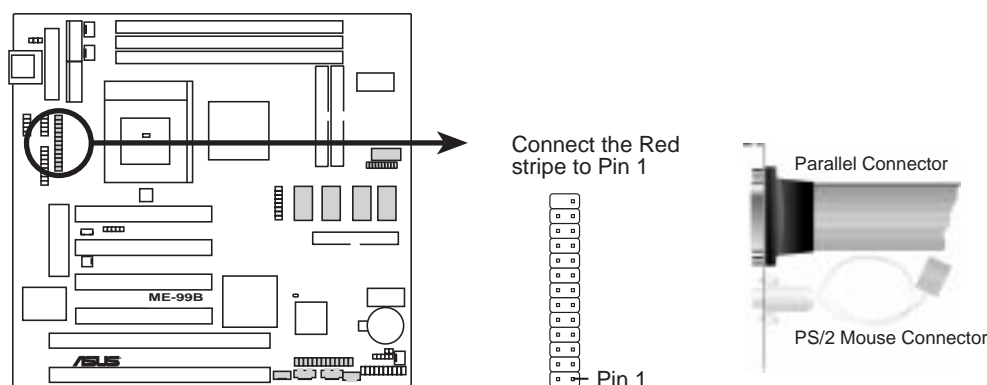

**ME-99B Parallel Connector**

## 4) Serial Port Headers (10-1 pin COM1/COM2)

These connectors support the provided serial port ribbon cables with mounting bracket. Connect the ribbon cables to these connectors and mount the bracket to the case on an open slot. You can make available the serial port and choose the IRQ through **Onboard Serial Port 1/2** in **4.4.2 I/O Device Configuration**. **(Pin 10 is removed to prevent inserting in the wrong orientation when using ribbon cables with pin 10 plugged).**

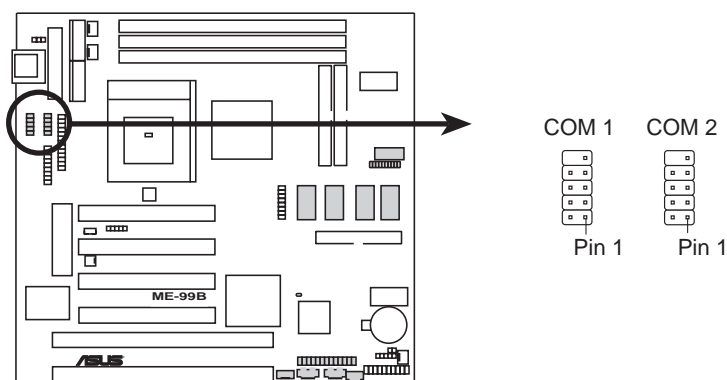

**ME-99B Serial Port Headers**

# 3. HARDWARE SETUP

## 5) Primary / Secondary IDE Connectors (Two 40-1pin IDE)

These connectors support the provided IDE hard disk ribbon cable. After connecting the single end to the board, connect the two plugs at the other end to your hard disk(s). If you install two hard disks, you must configure the second drive to Slave mode by setting its jumper accordingly. Please refer to the documentation of your hard disk for the jumper settings. BIOS now supports SCSI device or IDE CD-ROM bootup (see **Boot Sequence** in *4.6 Boot Menu*). (Pin 20 is removed to prevent inserting in the wrong orientation when using ribbon cables with pin 20 plugged).

**TIP:** You may configure two hard disks to be both Masters with two ribbon cables – one for the primary IDE connector and another for the secondary IDE connector. You may install one operating system on an IDE drive and another on a SCSI drive and select the boot disk through **Boot Sequence** in *4.6 Boot Menu*.

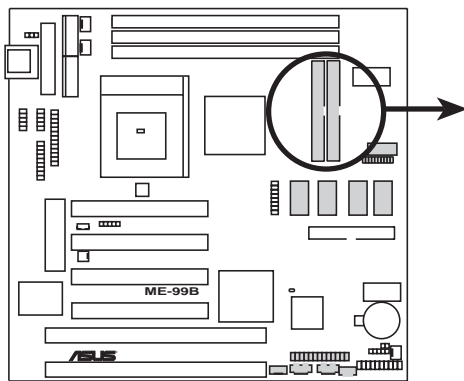

ME-99B IDE Connectors

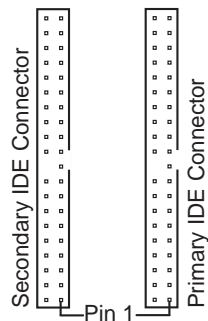

**NOTE:** Orient the red markings (usually zigzag) on the IDE ribbon cable to pin 1

3. HW SETUP  
Connectors

**IMPORTANT:** UltraDMA/66 IDE devices must use an 80-conductor IDE cable.

## 6) IDE activity LED (2-pin IDELED)

This connector supplies power to the cabinet's IDE activity LED. Read and write activity by devices connected to the Primary or Secondary IDE connectors will cause the LED to light up.

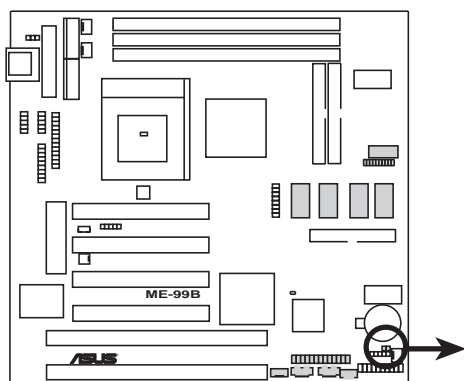

ME-99B IDE Activity LED

**TIP:** If the case-mounted LED does not light, try reversing the 2-pin plug.





# 3. HARDWARE SETUP

- 7) **Chassis, CPU, & Power Supply Fan Connectors (3-pin CHA\_, CPU\_, PWR\_FAN)**  
These connectors support cooling fans of 500mA (6 Watts) or less. Orientate the fans so that the heat sink fins allow airflow to go across the onboard heat sink(s) instead of the expansion slots. Depending on the fan manufacturer, the wiring and plug may be different. The red wire should be positive, while the black should be ground. Connect the fan's plug to the board taking into consideration the polarity of the this connector. **NOTE: The "Rotation" signal is to be used only by a specially designed fan with rotation signal.**

**WARNING!** The CPU and/or motherboard will overheat if there is no airflow across the CPU and onboard heatsinks. Damage may occur to the motherboard and/or the CPU fan if these pins are incorrectly used. **These are not jumpers, do not place jumper caps over these pins.**

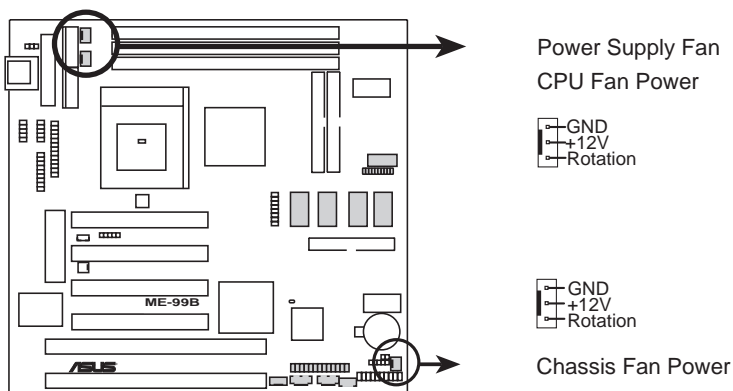

**ME-99B 12Volt Cooling Fan Power**

- 8) **Wake-On-LAN Connector (3-pin WOL\_CON)**  
This connector connects to a LAN card with a Wake-On-LAN output, such as the ASUS PCI-L101 Ethernet card (see **7.1 ASUS PCI-L101 Fast Ethernet Card**). The connector powers up the system when a wakeup packet or signal is received through the LAN card.

**IMPORTANT:** This feature requires that **Wake On LAN** is set to *Enabled* (see **4.5.1 Power Up Control**) and that your system has an ATX power supply with at least 720mA +5V standby power.

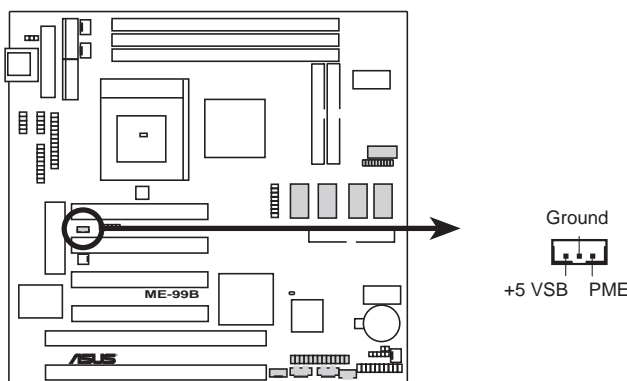

**ME-99B Wake-On-LAN Connector**

# 3. HARDWARE SETUP

## 9) IrDA-Compliant Infrared Module Connector (5-pin IR)

This connector supports the optional wireless transmitting and receiving infrared module. This module mounts to a small opening on system cases that support this feature. You must also configure the setting through **UART2 Use Infrared** (see **4.4.2 I/O Device Configuration**) to select whether UART2 is directed for use with COM2 or IrDA. Use the five pins as shown in Back View and connect a ribbon cable from the module to the motherboard according to the pin definitions.

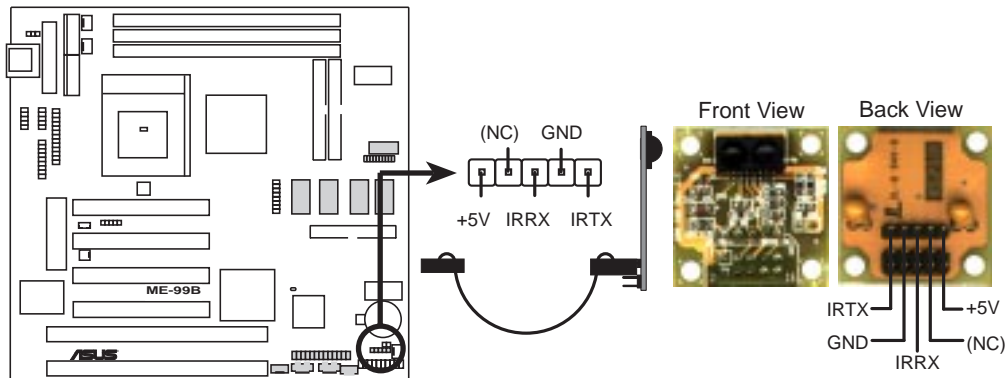

**ME-99B Infrared Module Connector**

## 10) USB, Infrared, PS/2 Mouse Module Connector (18-1 pin USBIRMS)

If you want to use USB or infrared (IrDA) devices, you need to purchase an external connector set. The external connector set, which also includes a PS/2 mouse connector, connects to the 18-pin block and mounts to an open slot on your computer's chassis. The system will direct IRQ12 to the PS/2 mouse if one is detected. If one is not detected, expansion cards can use IRQ12. See **PS/2 Mouse Function Control** in **4.4 Advanced Menu** and **USB Function** in **4.4.3 PCI Configuration**. See **IrDA-Compliant Infrared Module Connector** above for details on the infrared connector.

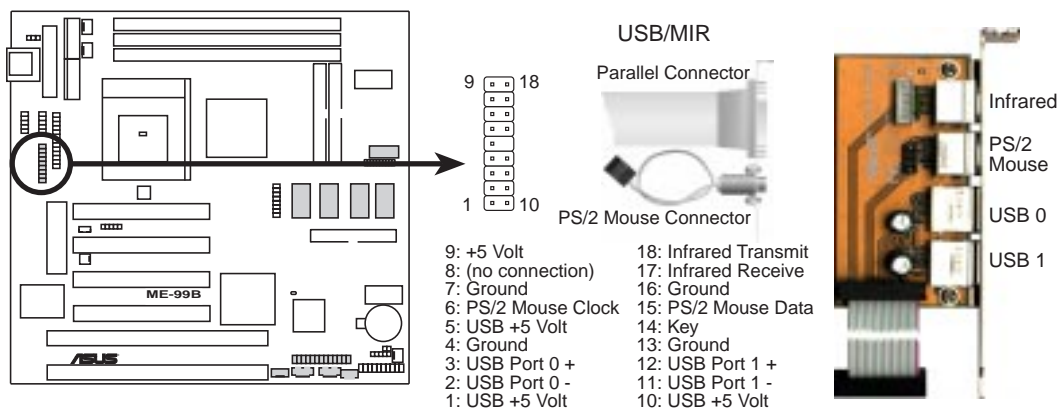

**ME-99B PS/2 Mouse, USB, IrDA Module Connector**

**Optional USB/MIR**

# 3. HARDWARE SETUP

## 11) VGA Header (16-pin VGA)

The VGA Header lets you use the onboard AGP VGA and connect a standard (CRT) monitor through the provided VGA cable with mounting bracket. Connect the cable to this header and mount the bracket to the case on a free expansion slot. **NOTE:** You can make available the monitor port by setting the SW2-5 switch (DSW2) to *ON*.

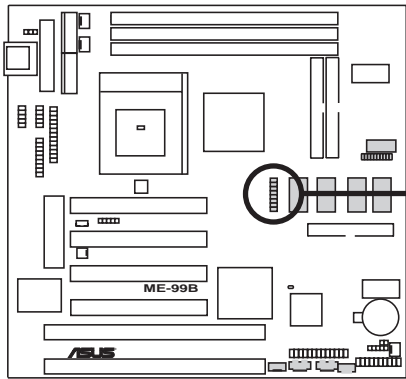

ME-99B VGA Header

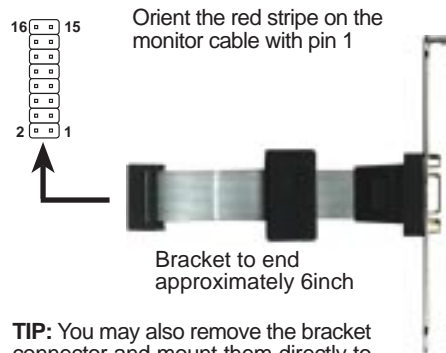

**TIP:** You may also remove the bracket connector and mount them directly to the case to save expansion slot space.

## 12) LCD Header (20-pin LCDHD)

This header supports the provided LCD cable with mounting bracket. Connect the cable to this header and mount the bracket to the case on a free expansion slot. You can make available the LCD port by setting the SW2-7 switch (DSW2) to *ON*. **NOTE:** This connector is available only on motherboards with optional Digital Flat Panel (DFP) interface support.

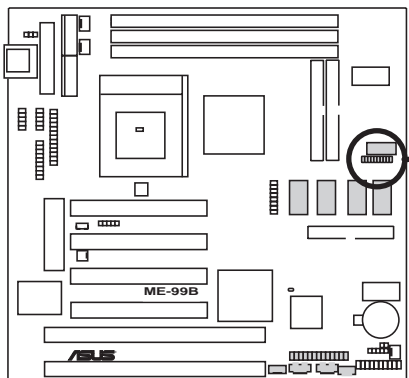

ME-99B LCD Header

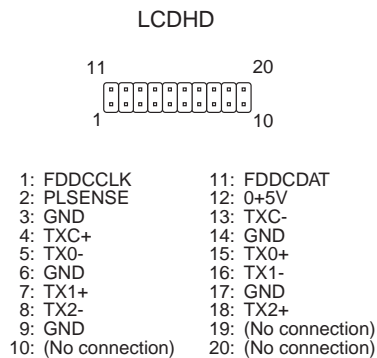

# 3. HARDWARE SETUP

## 13) TV Out Connector (12-1 pin SCART)

This connector allows you to connect your computer directly to the SCART socket at the back of your TV. **NOTE:** This connector is available only on motherboards with optional SCART interface support.

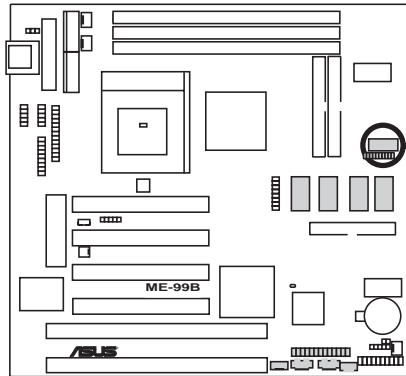

ME-99B TV Out Connector

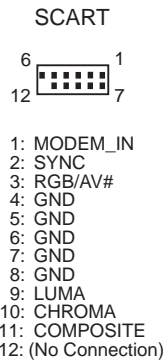

## 14) Internal Audio Connectors (4-pin MODEM /AUX / CD1 / CD2)

These connectors allow you to receive stereo audio input from such sound sources as a CD-ROM, TV tuner, or MPEG card. The MODEM connector allows the onboard audio to interface with a voice modem card with a similar connector. It also allows the sharing of microphone and speaker between the onboard audio and the voice modem card.

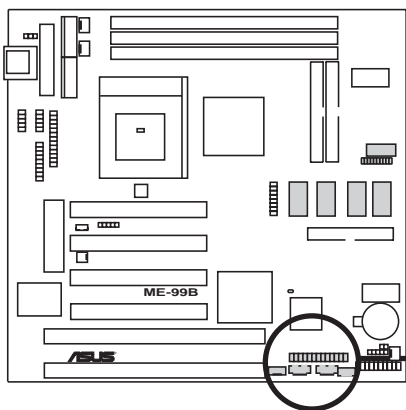

ME-99B Internal Audio Connectors

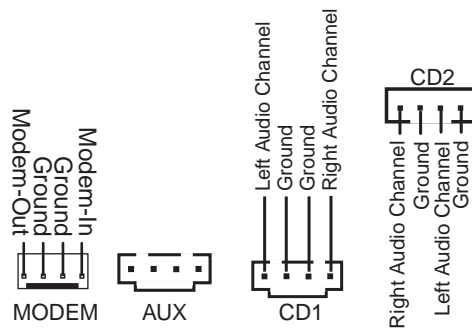

NOTE: AUX is the same as CD1

# 3. HARDWARE SETUP

## 15) Audio Jack Header (25-1 pin AUDIOCON)

This header is provided for audio input and output signals. Using a ribbon cable, you can connect this header to a back panel audio connector.

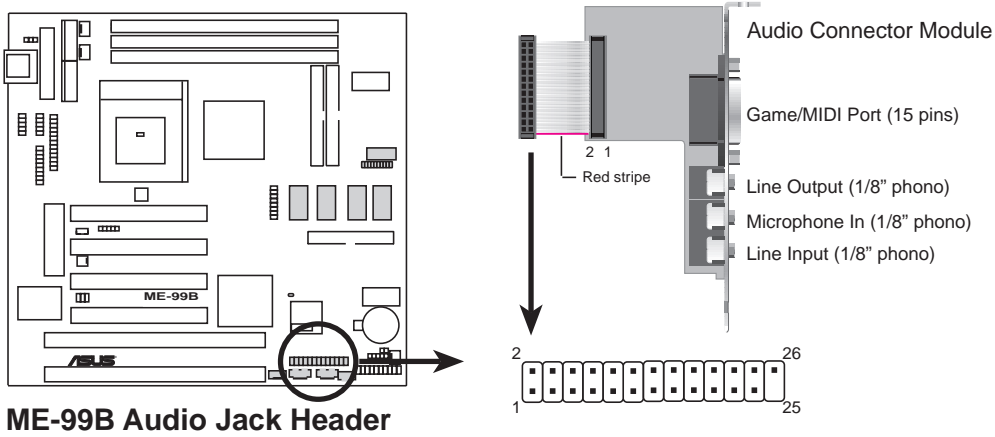

ME-99B Audio Jack Header

## 16) Wake-On-Ring Connector (2-pin WOR)

This connector connects to an internal modem card with a Wake-On-Ring output. The connector powers up the system when a ringup packet or signal is received through the internal modem card. **NOTE:** For external modems, Wake-On-Ring is detected through the COM port.

**IMPORTANT:** This feature requires that **PWR Up On Modem Act** is set to *Enabled* (see **4.5.1 Power Up Control**).

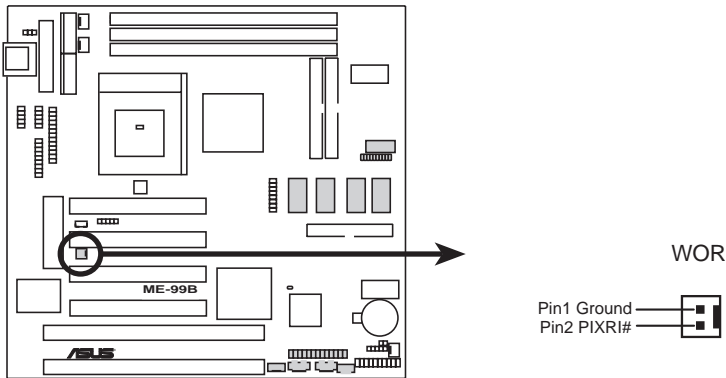

ME-99B Wake-On-Ring Connector

# 3. HARDWARE SETUP

## 17) SMBus Connector (5-1 pin SMB)

This connector allows you to connect SMBus (System Management Bus) devices. SMBus devices communicate by means of the SMBus with an SMBus host and/or other SMBus devices. SMBus is a specific implementation of an I<sup>2</sup>C bus, which is a multi-master bus; that is, multiple chips can be connected to the same bus and each one can act as a master by initiating data transfer.

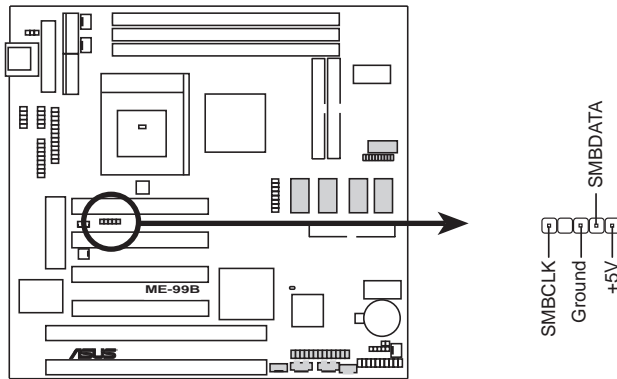

**ME-99B SMBus Connector**

# 3. HARDWARE SETUP

The following PANEL illustration is used for items 18-24

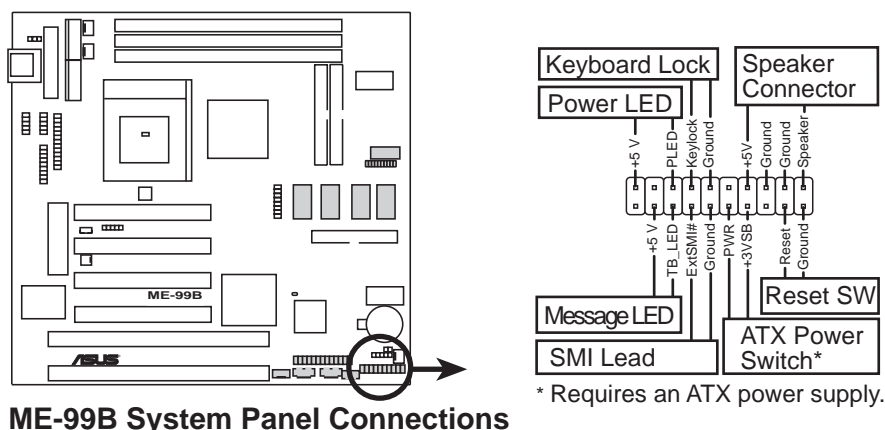

## 18) System Power LED (3-1 pin PWRLED)

This 3-1 pin connector connects the system power LED, which lights when the system is powered on and blinks when it is in sleep mode.

## 19) Keyboard Lock Switch Lead (2-pin KEYLOCK)

This 2-pin connector connects to the case-mounted key switch to allow keyboard locking.

## 20) System Warning Speaker Connector (4-pin SPEAKER)

This 4-pin connector connects to the case-mounted speaker. You may leave this disconnected if your motherboard has an onboard buzzer which can replace the chassis speaker. When connected, you will hear system warnings through both sources. **NOTE:** Some sound cards allow you to connect to the system speaker signal so that the warnings can be heard and adjusted through your multimedia system.

## 21) System Message LED Lead (2-pin MSG.LED)

This indicates whether a message has been received from a fax/modem. The LED will remain lit when there is no signal and blink when there is data transfer or waiting in the inbox. This function requires ACPI OS and driver support.

## 22) System Management Interrupt Switch Lead (2-pin SMISW)

This allows the user to manually place the system into a suspend mode or “Green” mode where system activity is decreased to save electricity and expand the life of certain components when the system is not in use. This 2-pin connector connects to the case-mounted suspend switch. If you do not have a switch for the connector, you may use the “Turbo Switch”. SMI is activated when it detects a *short to open* moment and therefore leaving it shorted will not cause any problems. This may require one or two presses depending on the position of the switch. Wake-up can be controlled by settings in the BIOS but the keyboard will always allow wake-up (the SMI lead cannot wake up the system).



# 3. HARDWARE SETUP

## 23) ATX Power Switch / Soft-Off Switch (2-pin PWRSW)

The system power is controlled by a momentary switch connected to this lead. Pressing the button once will switch the system between ON and SOFT OFF. Pushing the switch while in the ON mode for more than 4 seconds will turn the system off. The system power LED shows the status of the system's power.

## 24) Reset Switch Lead (2-pin RESET)

This 2-pin connector connects to the case-mounted reset switch for rebooting your computer without having to turn off your power switch. This is a preferred method of rebooting to prolong the life of the system's power supply.

## 25) AT Power Supply Connector (12-pin PS2PWR)

This connector connects to a standard 5 Volt power supply. To connect the leads from the power supply, ensure first that the power supply is not plugged. Most power supplies provide two plugs (P8 and P9), each containing six wires, two of which are black. Orient the connectors so that the black wires are together.

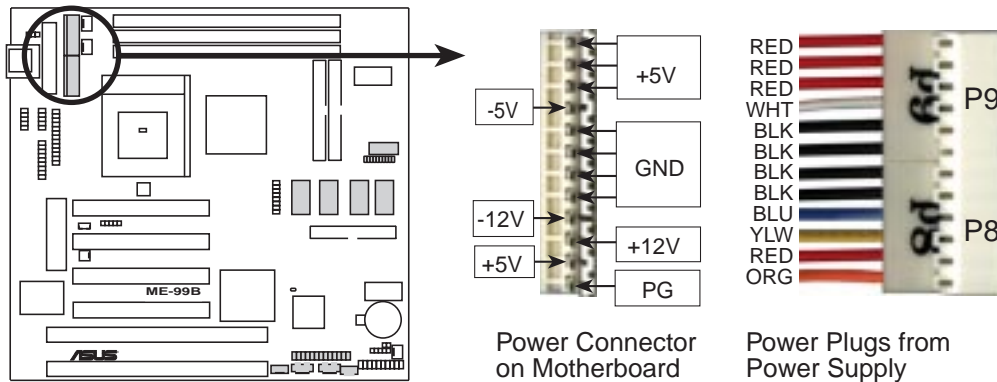

**ME-99B AT Power Connector**

Using a slight angle, align the plastic guide pins on the lead to their receptacles on the connector. Once aligned, press the lead onto the connector until the lead locks into place.

# 3. HARDWARE SETUP

## 26) ATX Power Supply Connector (20-pin block ATXPWR)

This connector connects to an ATX power supply. The plug from the power supply will only insert in one orientation because of the different hole sizes. Find the proper orientation and push down firmly making sure that the pins are aligned.

**IMPORTANT:** Make sure that your ATX power supply can supply at least 10mA on the +5-volt standby lead (+5VSB). You may experience difficulty in powering on your system if your power supply cannot support the load. For Wake-On-LAN support, your ATX power supply must supply at least 720mA +5VSB.

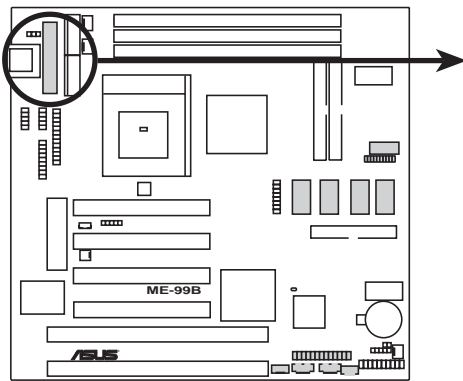

+12.0Volts	+5.0 Volts
+5V Standby	+5.0 Volts
Power Good	-5.0 Volts
Ground	Ground
+5.0 Volts	Ground
Ground	Ground
+5.0 Volts	Power Supply On
Ground	Ground
+3.3 Volts	-12.0Volts
+3.3 Volts	+3.3Volts

ME-99B ATX Power Connector

## 3. HARDWARE SETUP

---

### 3.9 Power Connection Procedures

1. After all connections are made, close the system case cover.
2. Be sure that all switches are off (in some systems, marked with ○).
3. Connect the power supply cord to the power supply located on the back of your system case according to your system user's manual.
4. Connect the power cord to a power outlet that is equipped with a surge protector.
5. You may then turn on your devices in the following order:
  - a. Your monitor
  - b. External SCSI devices (starting with the last device on the chain)
  - c. Your system power

For ATX power supplies, you need to switch ON the power supply if a switch is provided as well as press the ATX power switch on the front of the case.

6. The power LED on the front panel of the system case will light. For ATX power supplies, the system LED will light when the ATX power switch is pressed. The LED on the monitor may light up or switch between orange and green after the system's if it complies with "green" standards or if it has a power standby feature. The system will then run power-on tests. While the tests are running, additional messages will appear on the screen. If you do not see anything within 30 seconds from the time you turn on the power, the system may have failed a power-on test. Check your jumper settings and connections again or call your retailer for assistance.
  7. During power-on, hold down <Delete> to enter BIOS setup. Follow the instructions in **4. BIOS SETUP**.
- \* **Powering Off your computer:** You must first exit or shut down your operating system before switching off the power switch. For ATX power supplies, you can press the ATX power switch after exiting or shutting down your operating system. If you use Windows 95/98, click the **Start** button, click **Shut Down**, and then click **Shut down the computer?**. The power supply should turn off after Windows shuts down.

**NOTE:** The message "You can now safely turn off your computer" will not appear when shutting down with ATX power supplies.

# 4. BIOS SETUP

## 4.1 Flash Memory Writer Utility

**AFLASH.EXE:** This is the Flash Memory Writer utility that updates the BIOS by uploading a new BIOS file to the programmable flash ROM chip on the motherboard. To determine the BIOS version of your motherboard, check the last four numbers of the code displayed on the upper left-hand corner of your screen during bootup. Larger numbers represent a newer BIOS file. This file works only in DOS mode.

**NOTE:** The following screen displays are provided as examples only and may not reflect the screen contents displayed on your system.

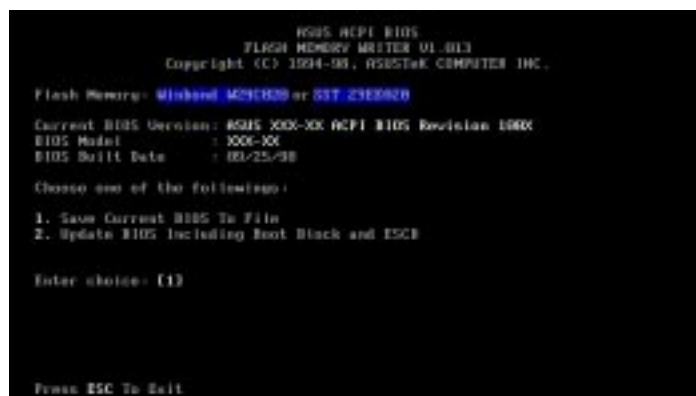

**IMPORTANT:** If “unknown” is displayed after **Flash Memory:**, the memory chip is either not programmable or is not supported by the ACPI BIOS and therefore, cannot be programmed by the Flash Memory Writer utility.

### 4.1.1 Main Menu

#### 1. Save Current BIOS To File

This option allows you to save a copy of the original motherboard BIOS in case you need to reinstall it. It is recommended that you save **AFLASH.EXE** and the BIOS file to a bootable floppy disk.

To save your current BIOS, type [1] at the **Main Menu** and then press <Enter>. The **Save Current BIOS To File** screen appears. Type a filename and the path, for example, **A:\XXX-XX.XXX** and then press <Enter>.

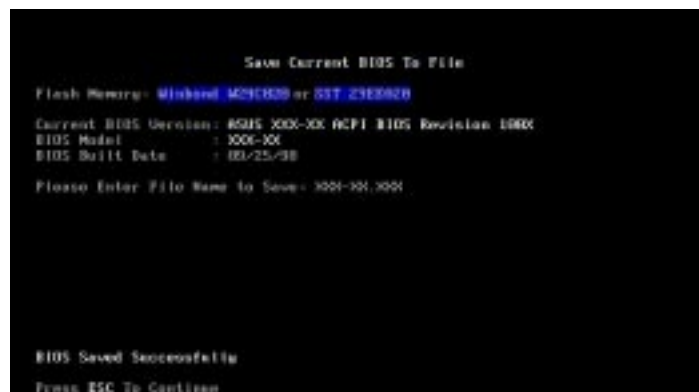

# 4. BIOS SETUP

## 2. Update BIOS Including Boot Block and ESCD

This option updates the boot block, the baseboard BIOS, and the ACPI extended system configuration data (ESCD) parameter block from a new BIOS file. See the next page for procedures on downloading an updated BIOS file.

To update your current BIOS, type [2] at the **Main Menu** and then press <Enter>. The **Update BIOS Including Boot Block and ESCD** screen appears. Type the filename of your new BIOS and the path, for example, **A:\XXX-XX.XXX**, and then press <Enter>.

When prompted to confirm the BIOS update, press **Y** to start the update.

The utility starts to program the new BIOS information into the flash ROM. When the programming is finished, **Flashed Successfully** will be displayed.

Follow the onscreen instructions to continue.

```
Update BIOS Including Boot Block and ESCD
Flash Memory: Winbond W29C020 or SST 29E020
Current BIOS Version: ASUS XXX-XX ACPI BIOS Revision 1000
BIOS Model          : XXX-XX
BIOS Build Date     : 00/25/98
Please Enter File Name for NEW BIOS: A:\XXX-XX.XXX
```

```
Update BIOS Including Boot Block and ESCD
Flash Memory: Winbond W29C020 or SST 29E020
BIOS Version
CURRENT 3 ASUS XXX-XX ACPI BIOS Revision 1000
Flash.umd3 ASUS XXX-XX ACPI BIOS Revision 1000
BIOS Model
CURRENT 3 XXX-XX
Flash.umd3 XXX-XX
Date of BIOS Build
CURRENT 3 00/25/98
D0000,00013 00/25/98
Check sum of XXXX.XXXX is C370.
Are you sure (Y/N) ? Y
Press ESC To Return to Main Menu
```

```
Update BIOS Including Boot Block and ESCD
Flash Memory: Winbond W29C020 or SST 29E020
BIOS Version
CURRENT 3 ASUS XXX-XX ACPI BIOS Revision 1000
Flash.umd3 ASUS XXX-XX ACPI BIOS Revision 1000
BIOS Model
CURRENT 3 XXX-XX
Flash.umd3 XXX-XX
Date of BIOS Build
CURRENT 3 00/25/98
D0000,00013 00/25/98
Check sum of XXXX.XXXX is C370.
Are you sure (Y/N) ? Y
Programming -- 3FFF
Flashed Successfully
Press ESC To Return to Main Menu
```

```
ASUS ACPI BIOS
FLASH MEMORY WRITER V1.013
Copyright (C) 1994-98, ASUSTEK COMPUTER INC.
Flash Memory: Winbond W29C020 or SST 29E020
Current BIOS Version: ASUS XXX-XX ACPI BIOS Revision 1000
BIOS Model          : XXX-XX
BIOS Build Date     : 00/25/98
Choose one of the following:
1. Save Current BIOS To File
2. Update BIOS Including Boot Block and ESCD
Enter choice: [2]
You have flashed the EPROM! It is recommended that you turn off
the power, enter SETUP and Load Setup Defaults to have CMOS
updated with new BIOS when exits.
Press ESC To Exit
```

## 4. BIOS SETUP

---

### 4.1.2 Managing and Updating Your BIOS

#### Upon First Use of the Computer System

1. Create a bootable system floppy disk by typing [FORMAT A:/S] from the DOS prompt.
2. Copy AFLASH.EXE to the just created boot disk.
3. Run AFLASH.EXE from this new disk and select option **1. Save Current BIOS to File**. See **1. Save Current BIOS To File** on the previous page for more details and the rest of the steps.

#### Updating BIOS Procedures (only when necessary)

1. Download an updated ASUS BIOS file from the Internet (WWW or FTP) or a BBS (Bulletin Board Service) (see ASUS CONTACT INFORMATION on page 3 for details) and save to the disk you created earlier.
2. Boot from the disk you created earlier.
3. At the "A:\>" prompt, type **AFLASH** and then press <Enter>.
4. At the **Main Menu**, type **2** and then press <Enter>. See **2. Update BIOS Including Boot Block and ESCD** on the previous page for more details and the rest of the steps.

**WARNING!** If you encounter problems while updating the new BIOS, DO NOT turn off your system since this might prevent your system from booting up. Just repeat the process, and if the problem still persists, update the original BIOS file you saved to disk above. If the Flash Memory Writer utility was not able to successfully update a complete BIOS file, your system may not be able to boot up. If this happens, your system will need service.

# 4. BIOS SETUP

---

## 4.2 BIOS Setup Program

This motherboard supports a programmable EEPROM that can be updated using the provided utility as described in *4.1 Flash Memory Writer Utility*.

The utility is used if you are installing a motherboard, reconfiguring your system, or prompted to “**Run Setup**”. This section describes how to configure your system using this utility.

Even if you are not prompted to use the Setup program, at some time in the future you may want to change the configuration of your computer. For example, you may want to enable the Security Password Feature or make changes to the power management settings. It will then be necessary to reconfigure your system using the BIOS Setup program so that the computer can recognize these changes and record them in the CMOS RAM of the EEPROM.

The EEPROM on the motherboard stores the Setup utility. When you turn on the computer, the system provides you with the opportunity to run this program. This appears during the Power-On Self Test (POST). Press <Delete> to call up the Setup utility. If you are a little bit late pressing the mentioned key(s), POST will continue with its test routines, thus preventing you from calling up Setup. If you still need to call Setup, reset the system by pressing <Ctrl> + <Alt> + <Delete>, or by pressing the Reset button on the system chassis. You can also restart by turning the system off and then back on again. But do so only if the first two methods fail.

The Setup program has been designed to make it as easy to use as possible. It is a menu driven program, which means you can scroll through the various sub-menus and make your selections among the various predetermined choices. If you accidentally change a setting and do not know which one to switch back to, the Setup program has a hot key that allows you to return to the previous value. The hot keys are discussed in more detail later in this Section.

**To access the BIOS Setup program, press the <Delete> key after the computer has booted through its POST.**

**NOTE:** Because the BIOS software is constantly being updated, the following BIOS screens and descriptions are for reference purposes only and may not exactly reflect your BIOS screens.



# 4. BIOS SETUP

## 4.2.1 BIOS Menu Bar

The top of the screen has a menu bar with the following selections:

- MAIN** Use this menu to make changes to the basic system configuration.
- ADVANCED** Use this menu to enable and make changes to the advanced features.
- POWER** Use this menu to configure and enable Power Management features.
- BOOT** Use this menu to configure the default system device used to locate and load the Operating System.
- EXIT** Use this menu to exit the current menu or specify how to exit the Setup program.

To access the menu bar items, press the right or left arrow key on the keyboard until the desired item is highlighted.

## 4.2.2 Legend Bar

At the bottom of the Setup screen you will notice a legend bar. The keys in the legend bar allow you to navigate through the various setup menus. The following table lists the keys found in the legend bar with their corresponding alternates and functions.

Navigation Key(s)	Function Description
<F1> or <Alt + H>	Displays the General Help screen from anywhere in the BIOS Setup
<Esc> or <Alt + X>	Jumps to the Exit menu or returns to the main menu from a sub-menu
← or → (keypad arrow)	Selects the menu item to the left or right
↑ or ↓ (keypad arrows)	Moves the cursor up or down between fields
- (minus key)	Scrolls backward through the values for the highlighted field
+ (plus key) or spacebar	Scrolls forward through the values for the highlighted field
<Enter>	Brings up a selection menu for the highlighted field
<Home> or <PgUp>	Moves the cursor to the first field
<End> or <PgDn>	Moves the cursor to the last field
<F5>	Resets the current screen to its Setup Defaults
<F10>	Saves changes and exits Setup

# 4. BIOS SETUP

---

## General Help

In addition to the Item Specific Help window, the BIOS setup program also provides a General Help screen. This screen can be called up from any menu by simply pressing <F1> or the <Alt> + <H> combination. The General Help screen lists the legend keys with their corresponding alternates and functions.

## Saving Changes and Exiting the Setup Program

See *4.7 Exit Menu* for detailed information on saving changes and exiting the setup program.

## Scroll Bar

When a scroll bar appears to the right of a help window, this indicates that there is more information to be displayed that will not fit in the window. Use the <PgUp> and <PgDn> keys or the up and down arrow keys to scroll through the entire help document. Press the <Home> key to display the first page, press <End> to go to the last page. To exit the help window, press the <Enter> or the <Esc> key.

## Sub-Menu

Note that a right pointer symbol appears to the left of certain fields. This pointer indicates that a sub-menu can be launched from this field. A sub-menu contains additional options for a field parameter. To call up a sub-menu, simply move the cursor to highlight the field and press <Enter>. The sub-menu will then immediately appear. Use the legend keys to enter values and move from field to field within a sub-menu just as you would within a menu. Use the <Esc> key to return to the main menu.

Take some time to familiarize yourself with each of the legend keys and their corresponding functions. Practice navigating through the various menus and sub-menus. If you accidentally make unwanted changes to any of the fields, use the set default hot key. While moving around through the Setup program, note that explanations appear in the Item Specific Help window located to the right of each menu. This window displays the help text for the currently highlighted field.

**NOTE:** The item heading in square brackets represents the default setting for that field.

# 4. BIOS SETUP

## 4.3 Main Menu

When the Setup program is accessed, the following screen appears:

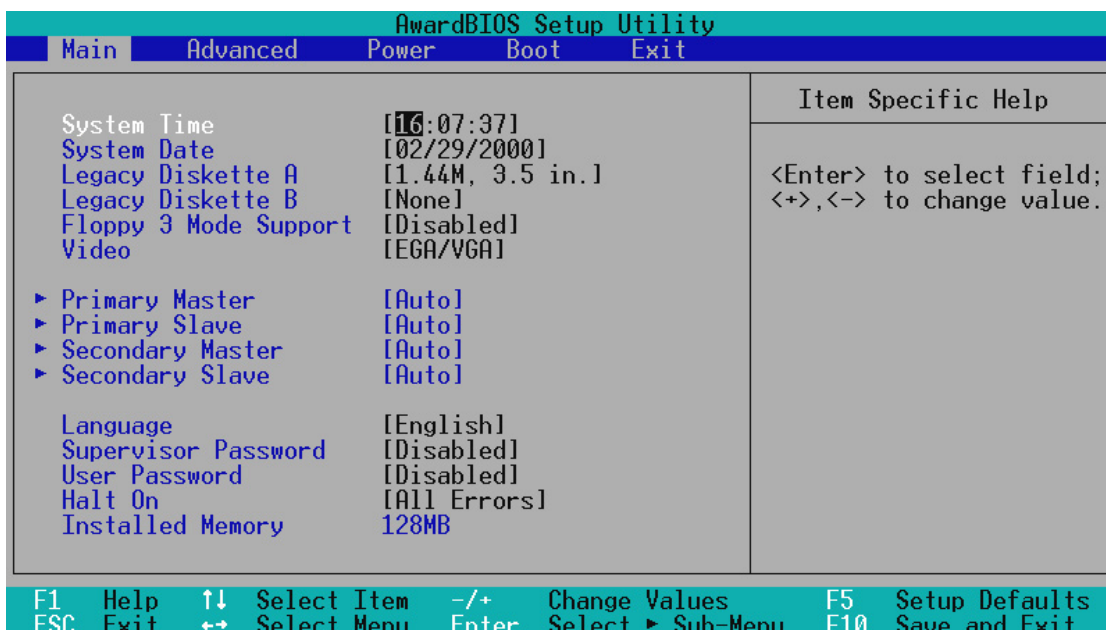

### System Time [XX:XX:XX]

Sets your system to the time that you specify (usually the current time). The format is hour, minute, second. Follow the hour, minute and second format. Valid values for hour, minute and second are **Hour: (00 to 23)**, **Minute: (00 to 59)**, **Second: (00 to 59)**. Use the <Tab> or <Shift> + <Tab> keys to move between the hour, minute, and second fields.

### System Date [XX/XX/XXXX]

Sets your system to the date that you specify (usually the current date). The format is month, day, year. Follow the month, day and year format. Valid values for month, day and year are **Month: (1 to 12)**, **Day: (1 to 31)**, **Year: (100 year range)**. Use the <Tab> or <Shift> + <Tab> keys to move between the month, day, and year fields.

### Legacy Diskette A [1.44M, 3.5 in.]

Sets the type of floppy drive installed. Configuration options: [None] [360K, 5.25 in.] [1.2M, 5.25 in.] [720K, 3.5 in.] [1.44M, 3.5 in.] [2.88M, 3.5 in.]

### Floppy 3 Mode Support [Disabled]

This is required to support older Japanese floppy drives. Floppy 3 Mode support will allow reading and writing of 1.2MB (opposed to 1.44MB) in a 3.5-inch diskette. Configuration options: [Disabled] [Drive A] [Drive B] [Both]

### Video [EGA/VGA]

This field allows setting of display type. Use [MONO] for black and white monitors; otherwise, use the [EGA/VGA] setting. Configuration options: [EGA/VGA] [MONO]

# 4. BIOS SETUP

## 4.3.1 Primary & Secondary Master/Slave

These fields are used to configure IDE devices. The arrow head icon indicates that this field contains a sub-menu. Move the cursor to highlight the field representing the appropriate channel you wish to setup and press the <Enter> key to enter the sub-menu.

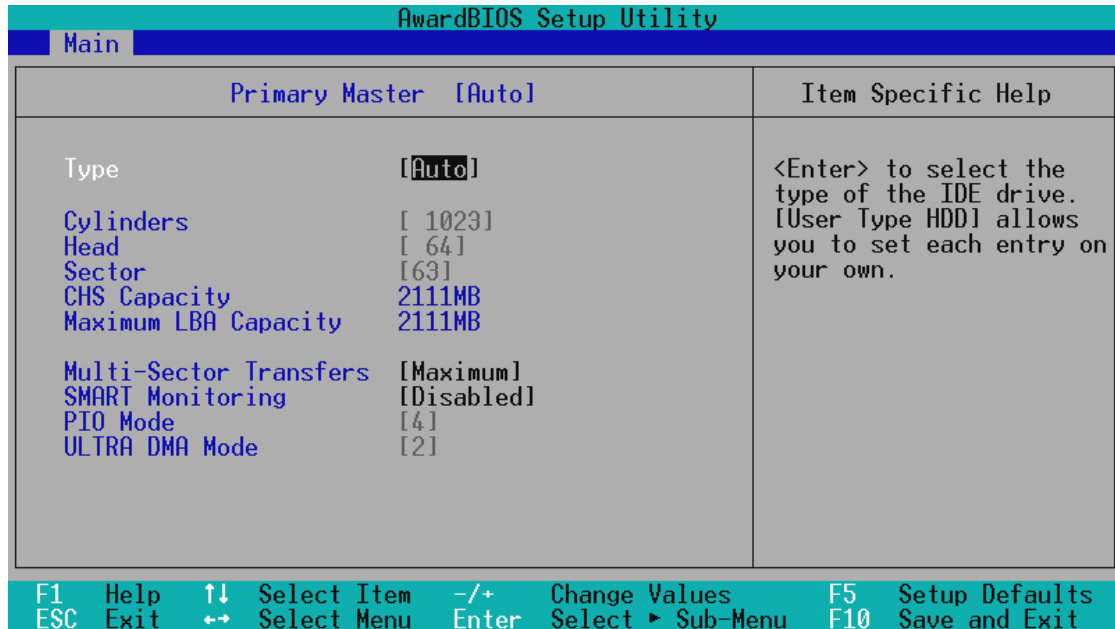

**NOTE:** Before attempting to configure a hard disk drive, make sure you have the configuration information supplied by the manufacturer of the drive. Incorrect settings may cause your system to not recognize the installed hard disk. To allow the BIOS to detect the drive type automatically, select [Auto].

### Type [Auto]

Select [Auto] to automatically detect an IDE hard disk drive. If automatic detection is successful, the correct values will be filled in for the remaining fields on this sub-menu. If automatic detection fails, your hard disk drive may be too old or too new. You can try updating your BIOS or enter the IDE hard disk drive parameters manually. Other options are:

### [None] - to disable IDE devices

**NOTE:** After the IDE hard disk drive information has been entered into BIOS, new IDE hard disk drives must be partitioned (such as with FDISK) and then formatted before data can be read from and write on. Primary IDE hard disk drives must have its partition set to *active* (also possible with FDISK).

# 4. BIOS SETUP

**IMPORTANT:** If your hard disk was already formatted on an older previous system, incorrect parameters may be detected. You will need to enter the correct parameters manually or use low-level format if you do not need the data stored on the hard disk. If the parameters listed differ from the ones used when the disk was formatted, the disk will not be readable. If the auto-detected parameters do not match the ones that should be used for your disk, you should enter the correct ones manually by setting [User Type HDD].

## [User Type HDD]

AwardBIOS Setup Utility		
Main		
Primary Master [User Type HDD]	Item Specific Help	
Type	[User Type HDD]	<Enter> to select the type of the IDE drive. [User Type HDD] allows you to set each entry on your own.
Translation Method	[LBA]	
Cylinders	[ 1023]	
Head	[ 64]	
Sector	[63]	
CHS Capacity	2111MB	
Maximum LBA Capacity	2111MB	
Multi-Sector Transfers	[Maximum]	
SMART Monitoring	[Disabled]	
PIO Mode	[4]	
ULTRA DMA Mode	[2]	
F1 Help ↑↓ Select Item -/+ Change Values F5 Setup Defaults ESC Exit ↔ Select Menu Enter Select ► Sub-Menu F10 Save and Exit		

Manually enter the number of cylinders, heads and sectors per track for your drive. Refer to your drive documentation or look on the drive for this information. If no drive is installed or if you are removing a drive and not replacing it, select [None].

### Translation Method [LBA]

Select the hard disk drive type in this field. When Logical Block Addressing is enabled, 28-bit addressing of the hard drive is used without regard for cylinders, heads, or sectors. Note that Logical Block Access may decrease the access speed of the hard disk. However, LBA Mode is necessary for drives with greater than 504MB in storage capacity. Configuration options: [LBA] [LARGE] [Normal] [Match Partition Table] [Manual]

### Cylinders

This field configures the number of cylinders. Refer to your drive documentation to determine the correct value to enter into this field. **NOTE:** To make changes to this field, the **Type** field must be set to [User Type HDD] and the **Translation Method** field must be set to [Manual].

# 4. BIOS SETUP

---

## Head

This field configures the number of read/write heads. Refer to your drive documentation to determine the correct value to enter into this field. **NOTE:** To make changes to this field, the **Type** field must be set to [User Type HDD] and the **Translation Method** field must be set to [Manual].

## Sector

This field configures the number of sectors per track. Refer to your drive documentation to determine the correct value to enter into this field. **NOTE:** To make changes to this field, the **Type** field must be set to [User Type HDD] and the **Translation Method** field must be set to [Manual].

## CHS Capacity

This field shows the drive's maximum CHS capacity calculated automatically by the BIOS from the drive information you entered.

## Maximum LBA Capacity

This field shows the drive's maximum LBA capacity calculated automatically by the BIOS from the drive information you entered.

## Multi-Sector Transfers [Maximum]

This option automatically sets the number of sectors per block to the highest number supported by the drive. This field can also be configured manually. Note that when this field is automatically configured, the set value may not always be the fastest value for the drive. Refer to the documentation that came with your hard drive to determine the optimal value and set it manually. **NOTE:** To make changes to this field, the **Type** field must be set to [User Type HDD]. Configuration options: [Disabled] [2 Sectors] [4 Sectors] [8 Sectors] [16 Sectors] [32 Sectors] [Maximum]

## SMART Monitoring [Disabled]

This allows the enabling or disabling of the S.M.A.R.T. (Self-Monitoring, Analysis and Reporting Technology) system which utilizes internal hard disk drive monitoring technology. This feature is normally disabled because system resources used in this feature may decrease system performance. Configuration options: [Disabled] [Enabled]

## PIO Mode [4]

This option lets you set a PIO (Programmed Input/Output) mode for the IDE device. Modes 0 through 4 provide successively increased performance. Configuration options: [0] [1] [2] [3] [4]

## Ultra DMA Mode [Disabled]

Ultra DMA capability allows improved transfer speeds and data integrity for compatible IDE devices. Set to [Disabled] to suppress Ultra DMA capability. **NOTE:** To make changes to this field, the **Type** field must be set to [User Type HDD]. Configuration options: [0] [1] [2] [3] [4] [Disabled]



## 4. BIOS SETUP

---

**Other options for “Type:” are:**

**[CD-ROM]** - for IDE CD-ROM drives

**[LS-120]** - for LS-120 compatible floppy disk drives

**[ZIP-100]** - for ZIP-100 compatible disk drives

**[MO]** - for IDE magneto optical disk drives

**[Other ATAPI Device]** - for IDE devices not listed here

After using the legend keys to make your selections on this sub-menu, press the <Esc> key to exit back to the Main menu. When the Main menu appears, you will notice that the drive size appear in the field for the hard disk drive that you just configured.

---

### **Language [English]**

This allows selection of the BIOS' displayed language. Currently only English is available.

### **Supervisor Password: [Disabled] / User Password [Disabled]**

This field allows you to set the password. To set the password, highlight the appropriate field and press <Enter>.

Type in a password and press <Enter>. You can type up to eight alphanumeric characters. Symbols and other keys are ignored. To confirm the password, type the password again and press the <Enter>. The password is now set to [Enabled]. This password allows full access to the BIOS Setup menus.

To clear the password, highlight this field and press <Enter>. The same dialog box as above will appear. Press <Enter> and the password will be set to [Disabled].

### **A Note about Passwords**

The BIOS Setup program allows you to specify passwords in the Main menu. The passwords control access to the BIOS and certain Security menu options during system startup. The passwords are not case sensitive. In other words, it makes no difference whether you enter a password using upper or lowercase letters.

The BIOS Setup program allows you to specify two separate passwords: a Supervisor password and a User password. When disabled, anyone may access all BIOS Setup program functions. When enabled, the Supervisor password is required for entering the BIOS Setup program and having full access to all Security menu options.



# 4. BIOS SETUP

## Forgot the password?

If you forgot the password, you can clear the password by erasing the CMOS Real Time Clock (RTC) RAM. The RAM data containing the password information is powered by the onboard button cell battery. To erase the RTC RAM: (1) Unplug your computer, (2) Short the solder points, (3) Turn ON your computer, (4) Hold down <Delete> during bootup and enter BIOS setup to re-enter user preferences.

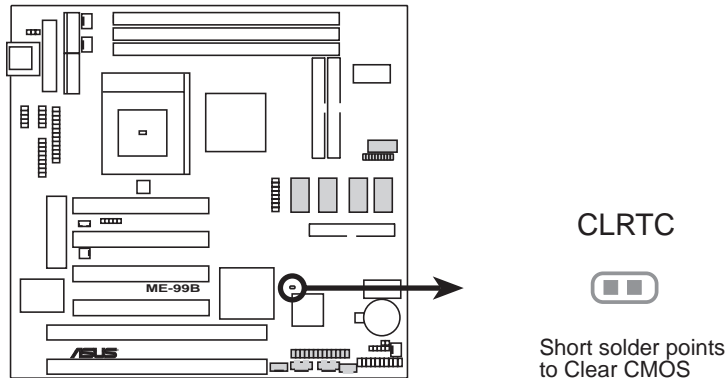

**ME-99B Clear RTC RAM**

## Halt On [All Errors]

This field determines which types of errors will cause the system to halt. Configuration options: [All Errors] [No Errors] [All,But Keyboard] [All,But Diskette] [All,But Disk/Key]

## Installed Memory [XXX MB]

This field displays the amount of conventional memory detected by the system during bootup. You do not need to make changes to this field. This is a display only field.

# 4. BIOS SETUP

## 4.4 Advanced Menu

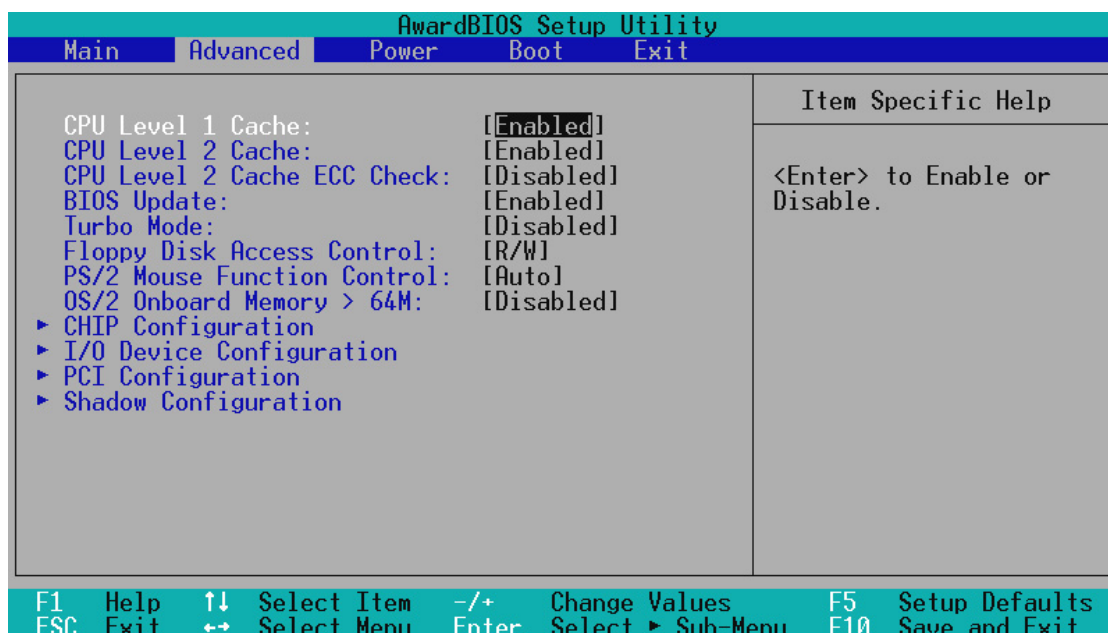

### CPU Level 1 Cache, CPU Level 2 Cache [Enabled]

These fields allow you to choose from the default of [Enabled] or choose [Disabled] to turn on or off the CPU's Level 1 and Level 2 built-in cache.

### CPU Level 2 Cache ECC Check [Disabled]

This function controls the ECC capability in the CPU level 2 cache.

### BIOS Update [Enabled]

This functions as an update loader integrated into the BIOS to supply the processor with the required data. The BIOS will load the update on all processors during system bootup in the default position of [Enabled].

### Turbo Mode [Disabled]

Leave on default setting.

### Floppy Disk Access Control [R/W]

When set to [Read Only], this field protects files from being copied to floppy disks by allowing reads from the floppy disk drive but not writes. The setup default [R/W] allows both reads and writes.

### PS/2 Mouse Function Control [Auto]

The default of [Auto] allows the system to detect a PS/2 mouse on bootup. If detected, IRQ12 will be used for the PS/2 mouse. IRQ12 will be reserved for expansion cards if a PS/2 mouse is not detected. [Enabled] will always reserve IRQ12, whether on bootup a PS/2 mouse is detected or not.

### OS/2 Onboard Memory > 64M [Disabled]

When using OS/2 operating systems with installed DRAM of greater than 64MB, you need to set this option to [Enabled]; otherwise, leave this on [Disabled].

# 4. BIOS SETUP

## 4.4.1 Chip Configuration

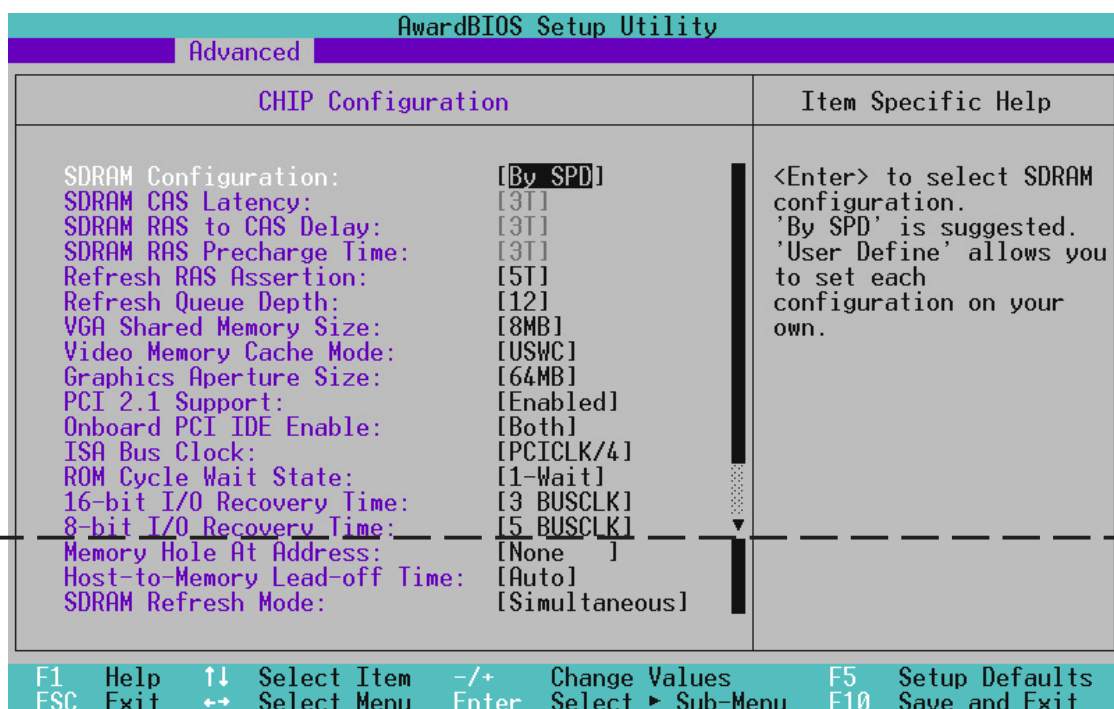

(scroll down to see more items, as shown here)

### SDRAM Configuration [By SPD]

This sets the optimal timings of settings for items 2–4, depending on the memory modules that you are using. Default setting is [By SPD], which configures items 2–4 by reading the contents in the SPD (Serial Presence Detect) device. The EEPROM on the memory module stores critical parameter information about the module, such as memory type, size, speed, voltage interface, and module banks. Configuration options: [User Define] [7ns (143MHz)] [8ns (125MHz)] [By SPD]

### SDRAM CAS Latency

This controls the latency between SDRAM read command and the time that the data actually becomes available. **NOTE:** To make changes to this field, the **SDRAM Configuration** field must be set to [User Define].

### SDRAM RAS to CAS Delay

This controls the latency between SDRAM active command and the read/write command. **NOTE:** To make changes to this field, the **SDRAM Configuration** field must be set to [User Define].

### SDRAM RAS Precharge Time

This controls the idle clocks after issuing a precharge command to SDRAM. **NOTE:** To make changes to this field, the **SDRAM Configuration** field must be set to [User Define].

### Refresh RAS Assertion [5T]

Leave on default setting.

## 4. BIOS SETUP

---

### **Refresh Queue Depth [12]**

Configuration options: [0] [4] [8] [12]

### **VGA Shared Memory Size [8MB]**

You can choose the amount of user-installed DIMM memory to allocate to the onboard VGA. This option is relevant only to motherboards with onboard VGA but no VGA memory onboard. Configuration options: [2MB] [4MB] [8MB]

### **Video Memory Cache Mode [USWC]**

USWC (uncacheable, speculative write combining) is a new cache technology for the video memory of the processor. It can greatly improve the display speed by caching the display data. You must set this to UC (uncacheable) if your display card cannot support this feature, otherwise your system may not boot. Configuration options: [UC] [USWC]

### **Graphics Aperture Size [64MB]**

Memory-mapped, graphics data structures can reside in a Graphics Aperture.

### **PCI 2.1 Support [Enabled]**

This function allows you to enable or disable PCI 2.1 features including passive release and delayed transaction. Configuration options: [Disabled] [Enabled]

### **Onboard PCI IDE Enable [Both]**

You can select to enable the primary IDE channel, secondary IDE channel, both, or disable both channels. Configuration options: [Both] [Primary] [Secondary] [Disabled]

### **ISA Bus Clock: [PCICLK/4]**

Leave on default setting.

### **ROM Cycle Wait State [1-Wait]**

Leave on default setting.

### **8-bit, 16-bit I/O Recovery Time**

Leave on default setting.

### **Memory Hole At Address [None]**

This field allows you to reserve an address space for ISA expansion cards that require it. Configuration options: [None] [15M-16M] [14M-16M] [12M-16M]

### **Host-to-Memory Lead-off Time [Auto]**

Leave on default setting.

### **SDRAM Refresh Mode [Simultaneous]**

Leave on default setting.

# 4. BIOS SETUP

## 4.4.2 I/O Device Configuration

AwardBIOS Setup Utility	
Advanced	
I/O Device Configuration	Item Specific Help
Onboard FDC Controller: [Enabled] Onboard FDC Swap A & B: [No Swap]  Onboard Serial Port 1: [3F8H/IRQ4] Onboard Serial Port 2: [2F8H/IRQ3] UART2 Use Infrared: [Disabled]  Onboard Parallel Port: [378H/IRQ7] Parallel Port Mode: [ECP+EPP] ECP DMA Select: [3]	<Enter> to Enable or Disable the onboard floppy disk controller.
F1 Help ↑↓ Select Item -/+ Change Values F5 Setup Defaults ESC Exit ↔ Select Menu Enter Select ▶ Sub-Menu F10 Save and Exit	

### Onboard FDC Controller [Enabled]

When [Enabled], this field allows you to connect your floppy disk drives to the onboard floppy disk drive connector instead of a separate controller card. If you want to use a different controller card to connect the floppy disk drives, set this field to [Disabled]. Configuration options: [Disabled] [Enabled]

### Onboard FDC Swap A & B [No Swap]

This field allows you to reverse the hardware drive letter assignments of your floppy disk drives. Configuration options: [No Swap] [Swap AB]

### Onboard Serial Port 1 [3F8H/IRQ4]

This allows you to set the address for the onboard serial connector. Serial Port 1 and Serial Port 2 must have different addresses. Configuration options: [3F8H/IRQ4] [2F8H/IRQ3] [3E8H/IRQ4] [2E8H/IRQ10] [Disabled]

### Onboard Serial Port 2 [2F8H/IRQ3]

This allows you to set the address for the onboard serial connector. Serial Port 1 and Serial Port 2 must have different addresses. Configuration options: [3E8H/IRQ4] [2F8H/IRQ3] [3F8H/IRQ4] [2E8H/IRQ10] [Disabled]

## 4. BIOS SETUP

---

### **UART2 Use Infrared [Disabled]**

When enabled, this field activates the onboard infrared feature and sets the second serial UART to support the infrared module connector on the motherboard. If your system already has a second serial port connected to the onboard COM2 connector, it will no longer work if you enable the infrared feature. [Disabled] leaves the second serial port UART to support the COM2 serial port connector. See **IrDA-Compliant Infrared Module Connector** in **3.8 External Connectors**. Configuration options: [Disabled] [Enabled]

### **Onboard Parallel Port [378H/IRQ7]**

This field sets the address of the onboard parallel port connector. If you install an I/O card with a parallel port, ensure that there is no conflict in the address assignments. The PC can support up to three parallel ports as long as there are no conflicts for each port. Configuration options: [Disabled] [3BCH/IRQ7] [378H/IRQ7] [278H/IRQ5]

### **Parallel Port Mode [ECP+EPP]**

This field allows you to set the operation mode of the parallel port. The setting [Normal], allows normal-speed operation but in one direction only; [EPP] allows bidirectional parallel port operation at maximum speed; [ECP] allows the parallel port to operate in bidirectional mode and at a speed faster than the maximum unidirectional data transfer rate; [ECP+EPP] allows normal speed operation in a two-way mode. Configuration options: [Normal] [EPP] [ECP] [ECP+EPP]

### **ECP DMA Select [3]**

This field allows you to configure the parallel port DMA channel for the selected **ECP** mode. This selection is available only if you select [ECP] or [ECP+EPP] in **Parallel Port Mode** above. Configuration options: [1] [3] [Disabled]



# 4. BIOS SETUP

## 4.4.3 PCI Configuration

AwardBIOS Setup Utility	
Advanced	
PCI Configuration	Item Specific Help
Slot 1 IRQ: [Auto]	<Enter> to select an IRQ.
Slot 2 IRQ: [Auto]	
Slot 3 IRQ: [Auto]	
Slot 4/Audio IRQ: [Auto]	
PCI/VGA Palette Snoop: [Disabled]	
PCI Latency Timer: [ 32]	
SYMBIOS SCSI BIOS: [Auto]	
USB Function: [Disabled]	
USB IRQ: [Auto]	
ONB VGA BIOS First: [No]	
▶ PCI/PNP ISA IRQ Resource Exclusion	
▶ PCI/PNP ISA DMA Resource Exclusion	
▶ PCI/PNP ISA UMB Resource Exclusion	

F1 Help ↑↓ Select Item -/+ Change Values F5 Setup Defaults  
ESC Exit ↔ Select Menu Enter Select ▶ Sub-Menu F10 Save and Exit

### Slot 1, Slot 2, Slot 3, Slot 4/Audio IRQ [Auto]

Your motherboard may have between 2 and 5 PCI slots depending on the chipset. Each PCI must have a unique IRQ number to operate. Make sure you do not choose an IRQ number used by another device. Configuration options: [Auto] [NA] [3] [4] [5] [7] [9] [10] [11] [12] [14] [15]

### PCI/VGA Palette Snoop [Disabled]

Some display cards that are nonstandard VGA such as graphics accelerators or MPEG Video Cards may not show colors properly. The setting [Enabled] should correct this problem. Otherwise, leave this on the setup default setting of [Disabled]. Configuration options: [Disabled] [Enabled]

### PCI Latency Timer [32]

Leave on default setting for best performance vs. stability.

### Symbios SCSI BIOS [Auto]

[Auto] allows the BIOS to detect whether you have a Symbios SCSI card. If detected, the onboard Symbios BIOS will be enabled; if not, it will be disabled and the external Symbios SCSI card's own BIOS can be used instead. **NOTE:** If your Symbios SCSI card does not have a BIOS, the Symbios SCSI card will not function. Configuration options: [Auto] [Disabled]

### USB Function [Disabled]

The USB ports can be activated or deactivated using this field. Configuration options: [Disabled] [Enabled]



# 4. BIOS SETUP

## USB IRQ [Enabled]

[Auto] reserved an IRQ# for the USB to work. [NA] does not allow the USB to have an IRQ# and therefore prevents the USB from functioning. If you are not using any USB devices, you may set this feature to [NA] to save an extra IRQ# for expansion cards. Configuration options: [Auto] [NA] [3] [4] [5] [7] [9] [10] [11] [12] [14] [15]

## ONB VGA BIOS First [No]

This field, when set to [Yes], gives priority to the onboard VGA BIOS over other VGA controllers. Configuration options: [No] [Yes]

## PCI/PNP ISA IRQ Resource Exclusion

The screenshot shows the 'AwardBIOS Setup Utility' interface. At the top, it says 'Advanced'. Below that, the title is 'PCI/PNP ISA IRQ Resource Exclusion'. The table below lists IRQs 3 through 15, each with a 'Used By ISA' field set to '[No/ICU]'. To the right of the table is a help box that says: 'Select 'Yes' if this IRQ is required by a legacy ISA card and you are not using ICU, else select 'No/ICU'. At the bottom of the screen, there is a legend for navigation keys: F1 Help, ESC Exit, ↑↓ Select Item, ↔ Select Menu, -/+ Change Values, Enter Select Sub-Menu, F5 Setup Defaults, and F10 Save and Exit.

AwardBIOS Setup Utility	
Advanced	
PCI/PNP ISA IRQ Resource Exclusion	Item Specific Help
IRQ 3 Used By ISA: [No/ICU]	Select 'Yes' if this IRQ is required by a legacy ISA card and you are not using ICU, else select 'No/ICU'.
IRQ 4 Used By ISA: [No/ICU]	
IRQ 5 Used By ISA: [No/ICU]	
IRQ 7 Used By ISA: [No/ICU]	
IRQ 9 Used By ISA: [No/ICU]	
IRQ 10 Used By ISA: [No/ICU]	
IRQ 11 Used By ISA: [No/ICU]	
IRQ 12 Used By ISA: [No/ICU]	
IRQ 14 Used By ISA: [No/ICU]	
IRQ 15 Used By ISA: [No/ICU]	

F1 Help   ↑↓ Select Item   -/+ Change Values   F5 Setup Defaults  
ESC Exit   ↔ Select Menu   Enter Select Sub-Menu   F10 Save and Exit

## IRQ XX Used By ISA [No/ICU]

These fields indicate whether or not the displayed IRQ for each field is being used by a legacy (non-PnP) ISA card. The default value indicates either that the displayed IRQ is not used or an ISA Configuration Utility (ICU) is being used to determine if an ISA card is using that IRQ. If you install a legacy ISA card that requires a unique IRQ, and you are not using an ICU, you must set the field for that IRQ to [Yes]. For example: If you install a legacy ISA card that requires IRQ 10, then set **IRQ10 Used By ISA** to [Yes]. Configuration options: [No/ICU] [Yes]

# 4. BIOS SETUP

## PCI/PNP ISA DMA Resource Exclusion

AwardBIOS Setup Utility	
Advanced	
PCI/PNP ISA DMA Resource Exclusion	Item Specific Help
DMA 1 Used By ISA: [No/ICU] DMA 3 Used By ISA: [No/ICU] DMA 5 Used By ISA: [No/ICU]	Select 'Yes' if this DMA is required by a legacy ISA card and you are not using ICU, else select 'No/ICU'.

F1 Help ↑↓ Select Item -/+ Change Values F5 Setup Defaults  
ESC Exit ↔ Select Menu Enter Select ► Sub-Menu F10 Save and Exit

### DMA x Used By ISA [No/ICU]

These fields indicate whether or not the displayed DMA channel for each field is being used by a legacy (non-PnP) ISA card. The default setting indicates either that the displayed DMA channel is not used or an ICU is being used to determine if an ISA card is using that channel. If you install a legacy ISA card that requires a unique DMA channel, and you are not using an ICU, you must set the field for that channel to [Yes]. Configuration options: [No/ICU] [Yes]

## PCI/PNP ISA UMB Resource Exclusion

AwardBIOS Setup Utility	
Advanced	
PCI/PNP ISA UMB Resource Exclusion	Item Specific Help
ISA MEM Block BASE: [No/ICU]	This is for some ISA Add-on cards whose UMB can't be auto-detected.

F1 Help ↑↓ Select Item -/+ Change Values F5 Setup Defaults  
ESC Exit ↔ Select Menu Enter Select ► Sub-Menu F10 Save and Exit

## 4. BIOS SETUP

### ISA MEM Block BASE [No/ICU]

This field allows you to set the base address and block size of a legacy ISA card that uses any memory segment within the C800 and DC00 address range. If you have such a card, and you are not using an ICU to specify its address range, select a base address from the six available options; the **ISA MEM Block SIZE** field will then appear for selecting the block size. If you have more than one legacy ISA card in your system that requires to use this address range, you can increase the block size to either 8K, 16K, 32K, or 64K. If you are using an ICU to accomplish this task, leave **ISA MEM Block BASE** to its default setting of [No/ICU]. Configuration options: [No/ICU] [C800] [CC00] [D000] [D400] [D800] [DC00]

### 4.4.4 Shadow Configuration

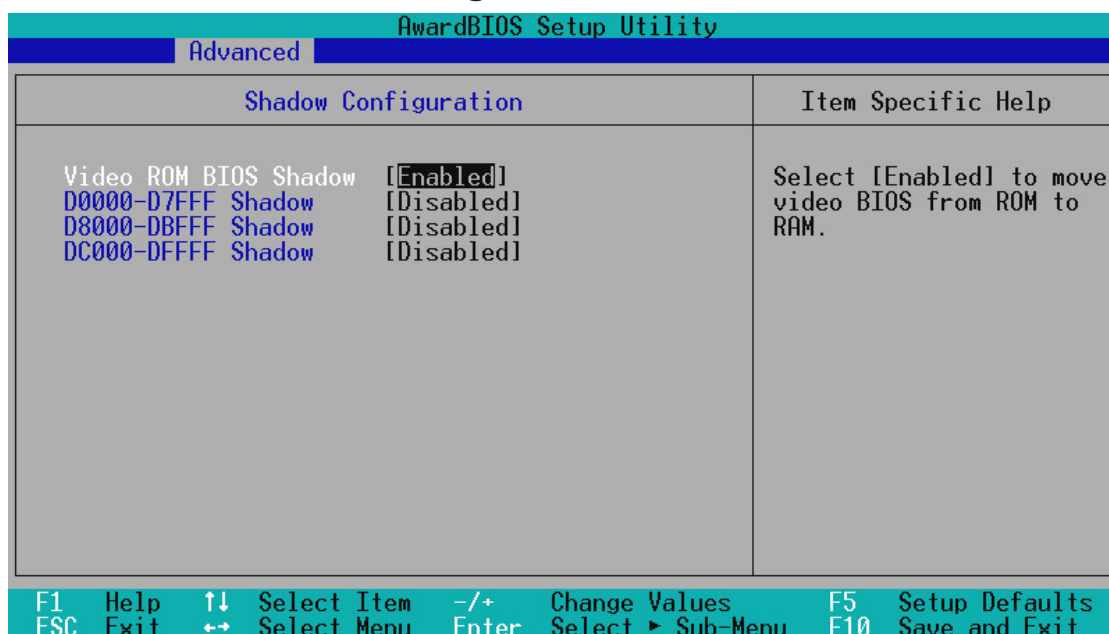

#### Video ROM BIOS Shadow [Enabled]

This field allows you to change the video BIOS location from ROM to RAM. Relocating to RAM enhances system performance, as information access is faster than the ROM. Configuration options: [Disabled] [Enabled]

#### C8000-DFFFF Shadow [Disabled]

These fields are used for shadowing other expansion card ROMs. If you install other expansion cards with ROMs on them, you will need to know which addresses the ROMs use to shadow them specifically. Shadowing a ROM reduces the memory available between 640K and 1024K by the amount used for this purpose. Configuration options: [Disabled] [Enabled]

# 4. BIOS SETUP

## 4.5 Power Menu

The Power menu allows you to reduce power consumption. This feature turns off the video display and shuts down the hard disk after a period of inactivity.

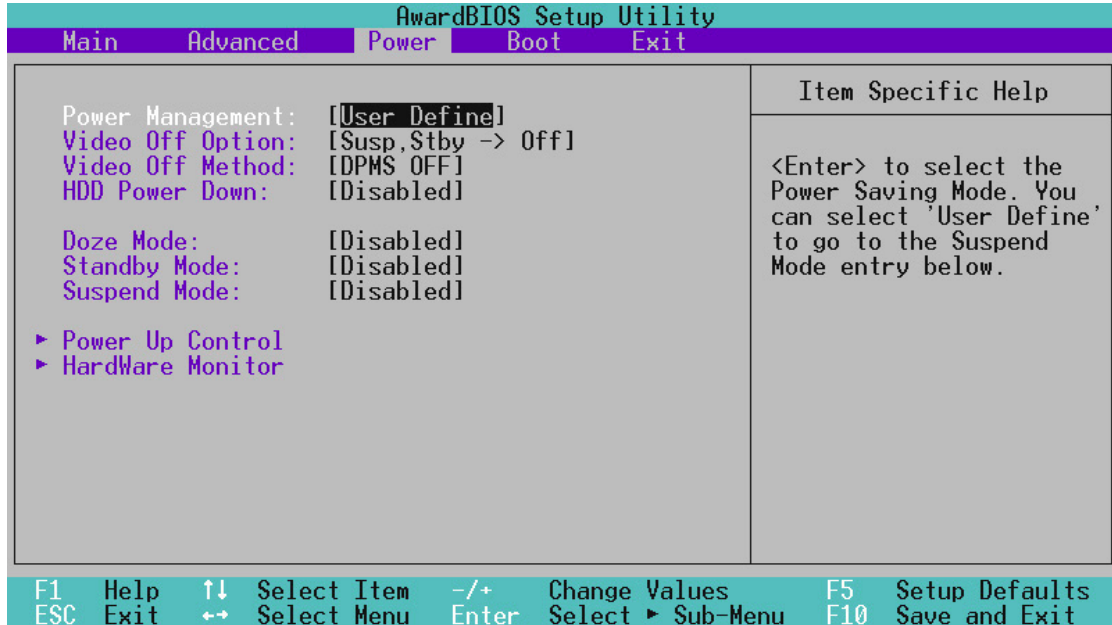

### Power Management [User Define]

This option must be enabled to use any of the automatic power saving features. If this menu item is set to [Disabled], power management features will not function regardless of other field settings on this menu. The [User Define] option allows you to make your own selections in the Power menu. When set to [Max Saving], system power will be conserved to its greatest amount. The **Doze Mode**, **Standby Mode**, and **Suspend Mode** fields will then be set to predefined values that ensure maximum power savings.

This field acts as the master control for the power management modes. [Max Saving] puts the system into power saving mode after a brief period of system inactivity; [Min Saving] is almost the same as [Max Saving] except that this time the system inactivity period is longer; [Disabled] disables the power saving features; [User Define] allows you to set power saving options according to your preference. Configuration options: [User Define] [Disabled] [Min Saving] [Max Saving]

**IMPORTANT:** Advanced Power Management (APM) should be installed to keep the system time updated when the computer enters suspend mode activated by the BIOS Power Management. For DOS environments, you need to add the statement, DEVICE=C:\DOS\POWER.EXE, in you CONFIG.SYS. For Windows 3.x and Windows 95, you need to install Windows with the APM feature. For Windows 98 and later, APM is automatically installed. A battery and power cord icon labeled "Power" will appear in the "Control Panel." Choose "Advanced" in the Power Management Field.

## 4. BIOS SETUP

---

### **Video Off Option [Suspend -> Off ]**

This field determines when to activate the video off feature for monitor power management. Configuration options: [Always On] [Suspend -> Off]

### **Video Off Method [DPMS OFF]**

This field defines the video off features. The DPMS (Display Power Management System) feature allows the BIOS to control the video display card if it supports the DPMS feature. [Blank Screen] only blanks the screen (use this for monitors without power management or “green” features. If set up in your system, your screen saver will not display with [Blank Screen] selected). [V/H SYNC+Blank] blanks the screen and turns off vertical and horizontal scanning. Configuration options: [Blank Screen] [V/H SYNC+Blank] [DPMS Standby] [DPMS Suspend] [DPMS OFF] [DPMS Reduce ON]

### **HDD Power Down [Disabled]**

Shuts down any IDE hard disk drives in the system after a period of inactivity as set in this user-configurable field. This feature does not affect SCSI hard drives. Configuration options: [Disabled] [1 Min] [2 Min] [3 Min]...[15 Min]

### **Doze Mode: [Disabled]**

Sets the time period for the system to go into doze (or sleep) mode. Configuration options: [Disabled] [20 Sec] [1 Min] [5 Min] [10 Min] [15 Min]...[40 Min]

### **Standby Mode: [Disabled]**

Sets the time period for the system to go into standby mode. Configuration options: [Disabled] [20 Sec] [1 Min] [5 Min] [10 Min] [15 Min]...[40 Min]

### **Suspend Mode [Disabled]**

Sets the time period for the system to go into suspend mode. Configuration options: [Disabled] [20 Sec] [1 Min] [5 Min] [10 Min] [15 Min]...[40 Min]

# 4. BIOS SETUP

## 4.5.1 Power Up Control

AwardBIOS Setup Utility	
Power	
Power Up Control	Item Specific Help
AC PWR Loss Restart [Disabled]	<Enter> to select whether or not to restart the system after AC power loss.
PWR Up On Modem Act [Enabled]	
Wake On LAN [Disabled]	
Automatic Power Up [Disabled]	

F1 Help ↑↓ Select Item -/+ Change Values F5 Setup Defaults  
ESC Exit ↔ Select Menu Enter Select ► Sub-Menu F10 Save and Exit

### AC PWR Loss Restart [Disabled]

This allows you to set whether you want your system to boot up after the power has been interrupted. [Disabled] leaves your system off and [Enabled] boots up your system. Configuration options: [Disabled] [Enabled]

### PWR Up On Modem Act [Enabled]

This allows either settings of [Enabled] or [Disabled] for powering up the computer when the modem receives a call while the computer is in Soft-off mode. **NOTE:** The computer cannot receive or transmit data until the computer and applications are fully running, thus connection cannot be made on the first try. Turning an external modem off and then back on while the computer is off causes an initialization string that will also cause the system to power on. Configuration options: [Disabled] [Enabled]

### Wake On LAN [Disabled]

Wake-On-LAN allows your computer to be booted from another computer via a network by sending a wake-up frame or signal. With this feature, network administrators can remotely boot an entire network of computer systems during off-peak hours for software updating or maintenance. Configuration options: [Disabled] [Enabled]

**IMPORTANT:** This feature requires an optional network interface with Wake-On-LAN and an ATX power supply with at least 720mA +5V standby power.

### Automatic Power Up [Disabled]

This allows an unattended or automatic system power up. Configuration options: [Disabled] [Enabled]



# 4. BIOS SETUP

## 4.5.2 Hardware Monitor

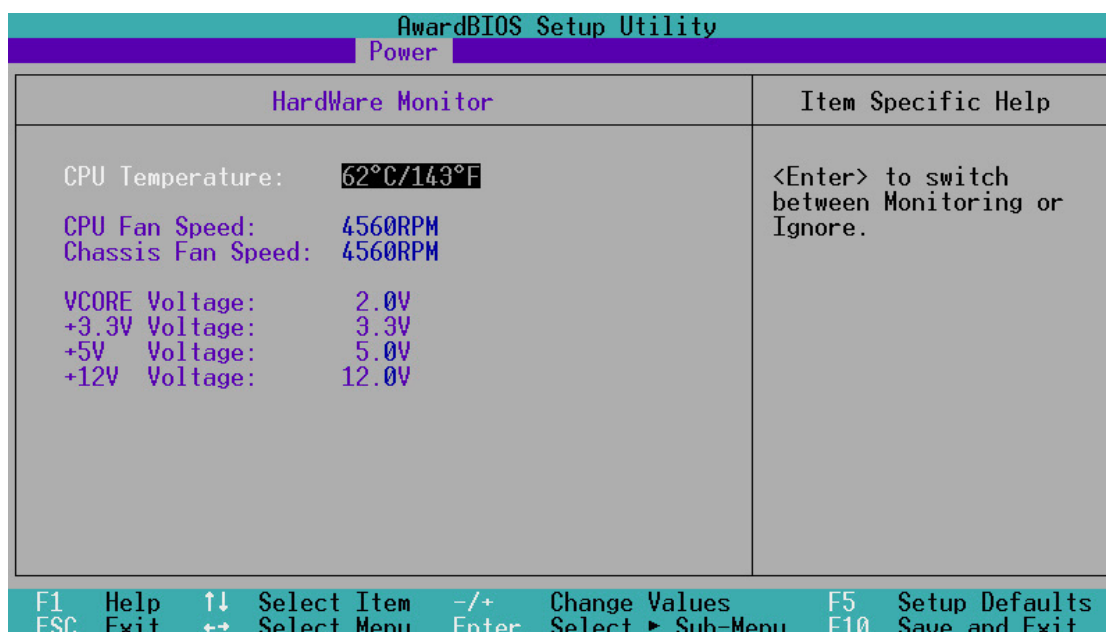

### CPU Temperature [xxxC/xxxF]

The onboard hardware monitor is able to detect the CPU temperature. Set to [Ignore] only if necessary.

### CPU Fan, Chassis Fan Speed [xxxxRPM]

The onboard hardware monitor is able to detect the CPU fan speed and the chassis fan speed in rotations per minute (RPM). The presence of the fans is automatically detected. Set to [Ignore] only if necessary.

### VCORE Voltage, +3.3V Voltage, +5V Voltage, +12V Voltage, [xx.xV]

The onboard hardware monitor is able to detect the voltage output by the onboard voltage regulators. Set to [Ignore] only if necessary.

**NOTE:** If any of the monitored items is out of range, an error message will appear: “Hardware Monitor found an error. Enter Power setup menu for details”. You will then be prompted to “Press **F1** to continue, **DEL** to enter SETUP”.



# 4. BIOS SETUP

## 4.6 Boot Menu

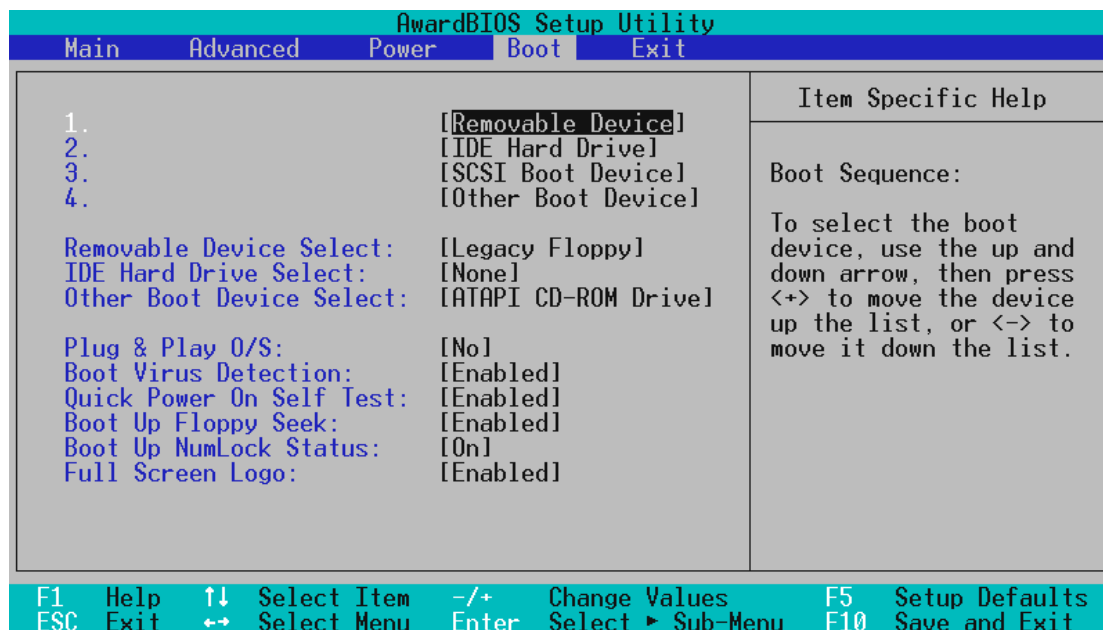

### Boot Sequence

The Boot menu allows you to select among the three possible boot devices listed using the up and down arrow keys. By using the <+> or <Space> key, you can promote devices and by using the <-> key, you can demote devices. Promotion or demotion of devices alters the priority which the system uses to search for a boot device on system power up. Configuration options: [Removable Devices] [IDE Hard Drive] [SCSI Boot Device] [Other Boot Device]

### Removable Device Select [Legacy Floppy]

Configuration options: [Legacy Floppy] [LS120] [ZIP-100] [ATAPI MO]

### IDE Hard Drive Select

This field allows you to select the IDE hard disk drive included in the boot sequence. Pressing [Enter] will show the product IDs of all your connected IDE hard disk drives.

### Other Boot Device Select [ATAPI CD-ROM Drive]

Configuration options: [ATAPI CD-ROM Drive] [Network]

### Plug & Play O/S [No]

This field allows you to use a Plug-and-Play (PnP) operating system to configure the PCI bus slots instead of using the BIOS. Thus interrupts may be reassigned by the OS when [Yes] is selected. When a non-PnP OS is installed or to prevent reassigning of interrupt settings, select the default setting of [No]. Configuration options: [No] [Yes]

## 4. BIOS SETUP

---

### **Boot Virus Detection [Enabled]**

Configuration options: [Disabled] [Enabled]

### **Quick Power On Self Test [Enabled]**

Configuration options: [Disabled] [Enabled]

### **Boot Up Floppy Seek [Enabled]**

Configuration options: [Disabled] [Enabled]

### **Boot Up NumLock Status [On]**

Configuration options: [Off] [On]

### **Full Screen Logo [Enabled]**

Configuration options: [Disabled] [Enabled]

# 4. BIOS SETUP

## 4.7 Exit Menu

Once you have made all of your selections from the various menus in the Setup program, you should save your changes and exit Setup. Select **Exit** from the menu bar to display the following menu:

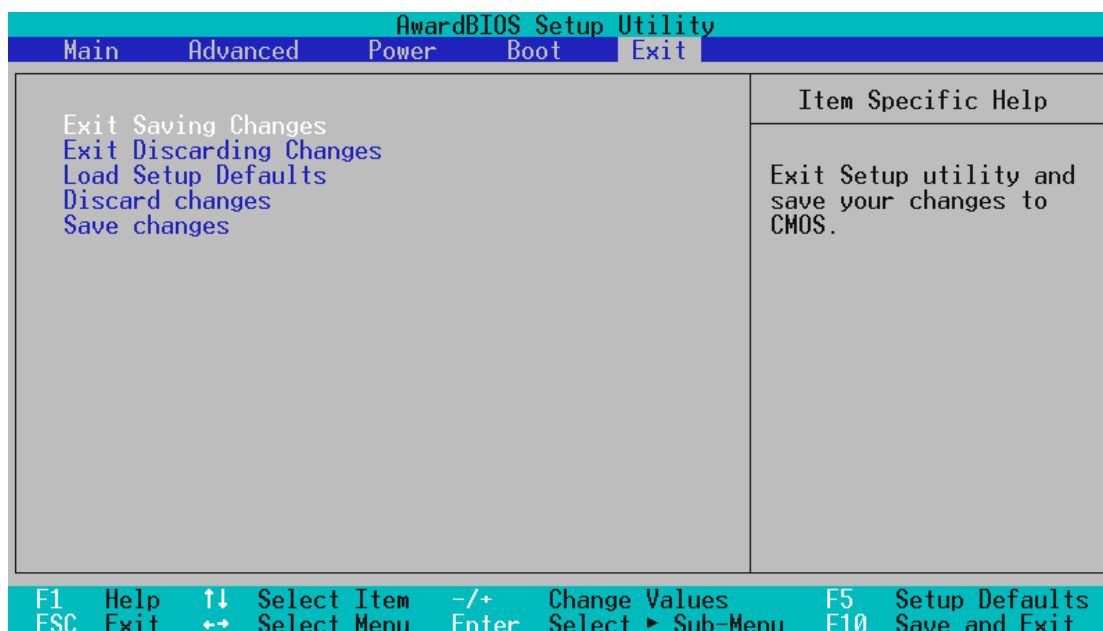

**NOTE:** Pressing the <Esc> key does not exit this menu. You must select one of the options from this menu or a menu bar item to exit this menu.

### Exit Saving Changes

Once you are finished making your selections, choose this option from the Exit menu to ensure the values you selected are saved to the CMOS RAM. The CMOS RAM is sustained by an onboard backup battery and stays on even when the PC is turned off. Once this option is selected, a confirmation is asked. Select [Yes] to save changes and exit.

**NOTE:** If you attempt to exit the Setup program without saving your changes, the program will prompt you with a message asking if you want to save your changes before exiting. Pressing the <Enter> key will then save changes while exiting.

### Exit Discarding Changes

This option should only be used if you do not want to save the changes you have made to the Setup program. If you have made changes to the fields other than system date, system time and password, the system will ask for confirmation before exiting.

## 4. BIOS SETUP

---

### **Load Setup Defaults**

This option allows you to load the default values for each of the parameters on the Setup menus. When this option is selected or if <F5> is pressed, a confirmation is requested. Select [Yes] to load default values. You can now select **Exit Saving Changes** or make other changes before saving the values to the non-volatile RAM.

### **Discard Changes**

This option allows you to discard the selections you made and restore the values you previously saved. After selecting this option, all selections are updated and a confirmation is requested. Select [Yes] to discard any changes and load the previously saved values.

### **Save Changes**

This option saves your selections without exiting the Setup program. You can then return to other menus and make changes. After selecting this option, all selections are saved and a confirmation is requested. Select [Yes] to save any changes to the non-volatile RAM.

# 5. SOFTWARE SETUP

---

## 5.1 Operating Systems

You should always use the latest operating system and updates when using new hardware to ensure full compliancy. For Windows 95, you must use OSR 2.0 or later. For Windows NT 4.0, you must use Service Pack 3.0 or later.

### 5.1.1 Windows 98 First Time Installation

When you start Windows for the first time after the installation of your motherboard, Windows 98 will detect the onboard audio and video chips and may attempt to install a driver from its system registry. When prompted to restart, select **No** and then follow the normal setup procedures later in this section.

**IMPORTANT:** Selecting **No** for the initial restart prompt is a necessary step because Windows may load an older display driver that is incompatible with the onboard VGA chip. Always use the driver available on the ASUS Support CD or an applicable driver update from your ASUS vendor or from the ASUS web site.

**NOTE:** The screen displays in this and the following section may not reflect exactly the screen contents displayed on your screen.

# 5. SOFTWARE SETUP

## 5.2 ME-99B Support CD

**NOTE:** The support CD contents are subject to change at any time without notice.

To begin using your support CD disc, just insert it into your CD-ROM drive and the support CD installation menu should appear. If the menu does not appear, double-click or run **D:\ASSETUP.EXE** (assuming that your CD-ROM drive is drive **D:**).

### 5.2.1 Installation Menu



- **Install ASUS PC Probe Vx.xx:** Installs a simple utility to monitor your computer's fan, temperature, and voltages.
- **Install Bus Master IDE Driver:** Installs SiS5595 Bus Master IDE Driver V1.53C.
- **Install VGA Driver:** Installs the necessary VGA drivers and utilities to access the features of the integrated VGA controller.
- **Install Audio Driver (Optional):** Installs the necessary audio drivers and utilities to access the features of the built-in PCI audio chipset.
- **Install ESS AudioRack32 (Optional):** Installs the ESS AudioRack utilities. Refer to the online help for more information.
- **Install ESS Software Wave Table (Optional):** Expands the audio sound card capability for increased sound effects.
- **Install PCCillin 98 Vx.xx:** Installs the PC-cillin virus protection software. View the online help for more information.
- **Install ADOBE Acrobat Reader Vx.x:** Installs the Adobe Acrobat Reader software necessary to view user's manuals saved in PDF format. Updated or other language versions of this motherboard's manual is available in PDF format at any of our web sites.
- **Show Motherboard Information:** Allows you to view information about your motherboard, such as product name, BIOS version, and CPU.
- **Browse Support CD:** Allows you to view the contents of the CD.
- **ReadMe:** Displays the filelist for the included support software.
- **Exit:** Exits the CD installation menu. (Click **RIGHT ARROW** on the lower-right corner of the main menu.)

**Additional CD Contents:** DMI Configuration Utility in the **DMI** folder, Flash BIOS writer in the **AFLASH** folder, IDE Bus Master driver for improved performance under Windows NT in the **BUSMASTR** folder, USB patch to fix problems when using the USB driver under Windows 95 OSR 2.1 in the **USBPATCH** folder.



# 5. SOFTWARE SETUP

## 5.3 Install ASUS PC Probe Vx.xx

Insert the Support CD that came with your motherboard into your CD-ROM drive or double-click the CD drive icon in **My Computer** to bring up the setup screen.

**NOTE:** ASUS PC Probe will not run if another hardware monitoring utility is installed. To uninstall any program, see *5.11 Uninstalling Programs*.

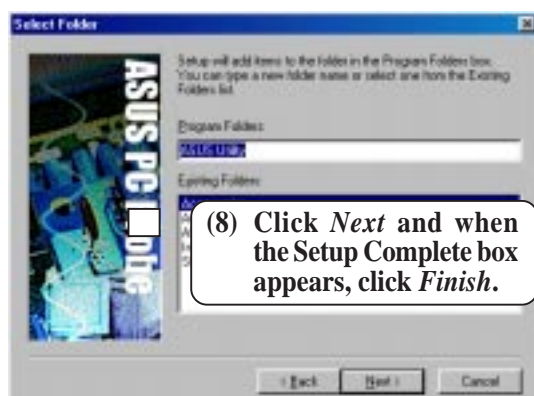
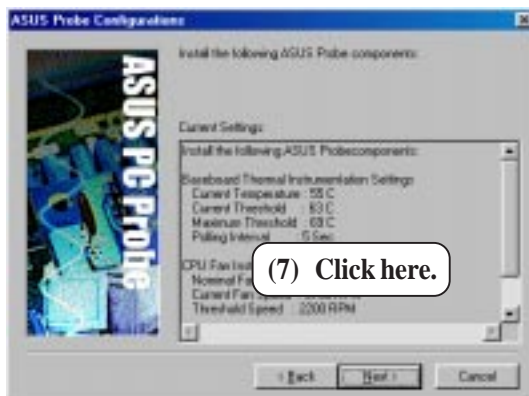
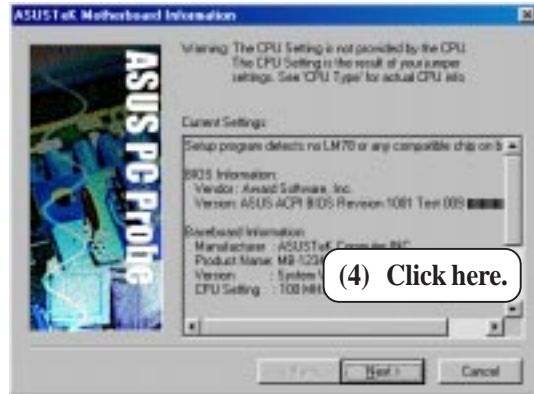
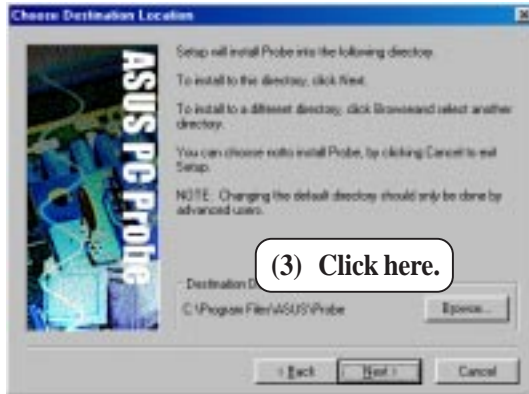





# 5. SOFTWARE SETUP

## 5.5 Install VGA Driver

Insert the Support CD that came with your motherboard into your CD-ROM drive or double-click the CD drive icon in **My Computer** to bring up the setup screen.

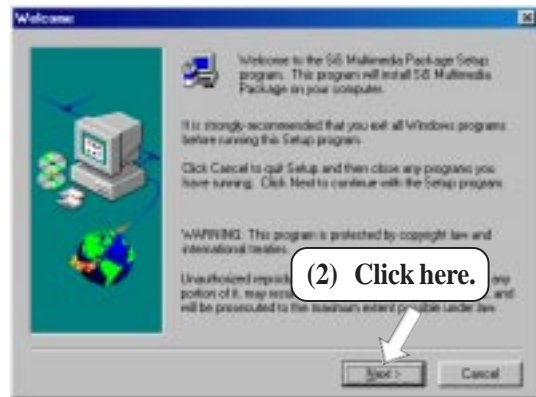

# 5. SOFTWARE SETUP

## 5.5.1 Making Monitor Adjustments

After you have installed the video driver and restarted your computer, you can make monitor adjustments by right-clicking on the Windows desktop and choosing **Properties**, clicking the *Settings* tab, and then the **Advanced** button.

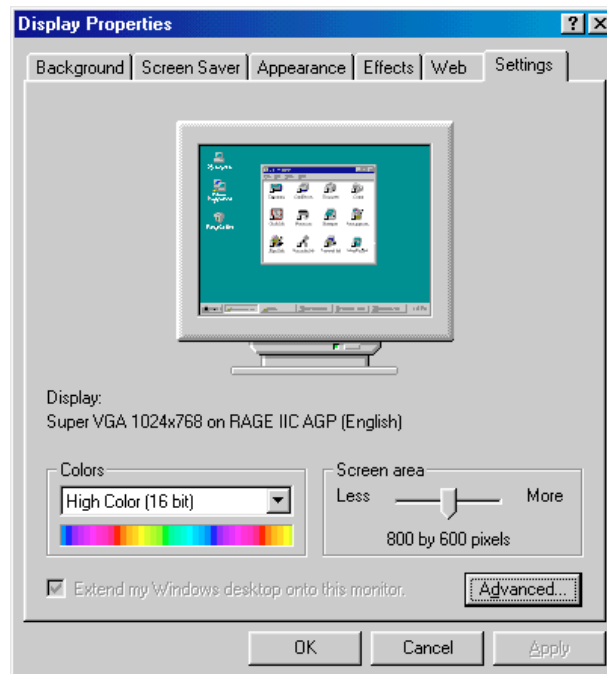

### *Video Setting Page*

This page allows you to adjust the brightness and contrast of the screen output. This function is available only in 16-bit color (high color, 65K-color) and 32-bit (true color plus 8 bits for an alpha channel, 16.7M-color) color depths.



# 5. SOFTWARE SETUP

## Display Modes Page

You can adjust the position and size of your screen as well as manipulate the screen refresh rate, frequencies, and synchronization from the **Adjustment** page.

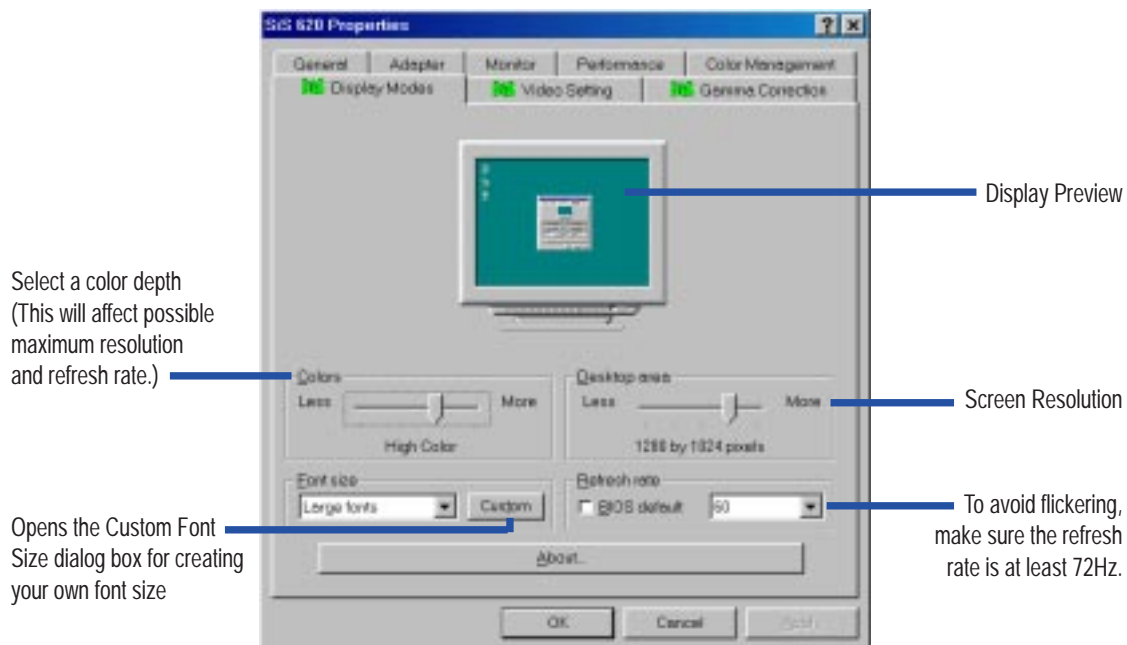

When you have finished making adjustments, click **OK**. You will see the following confirmation.

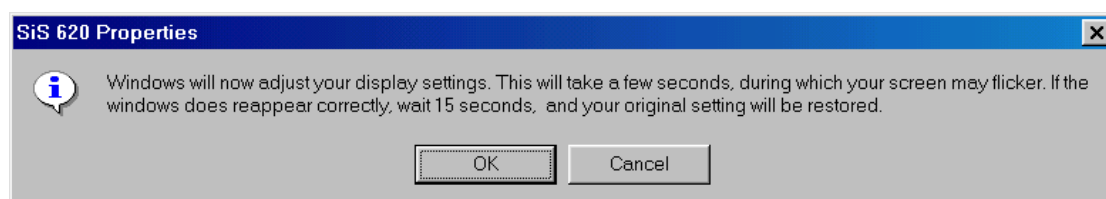

If your screen is unreadable and you are not able to answer the question within 15 seconds, your original settings will be restored. You may also press <ESC> to abort the settings changes. **NOTE:** Some settings require you to restart the computer for the settings to take effect.

# 5. SOFTWARE SETUP

## Gamma Correction Page

You can adjust the brightness, tint, and gamma values to correct color tone differences between real color values and the way your monitor or flat panel displays them from this page. Gamma correction is available only in 16-bit color and 24-bit color (true color, 16.7M-color) modes. In 16-color and 256-color modes, gamma correction is not supported. Sets the preferred tint of your display

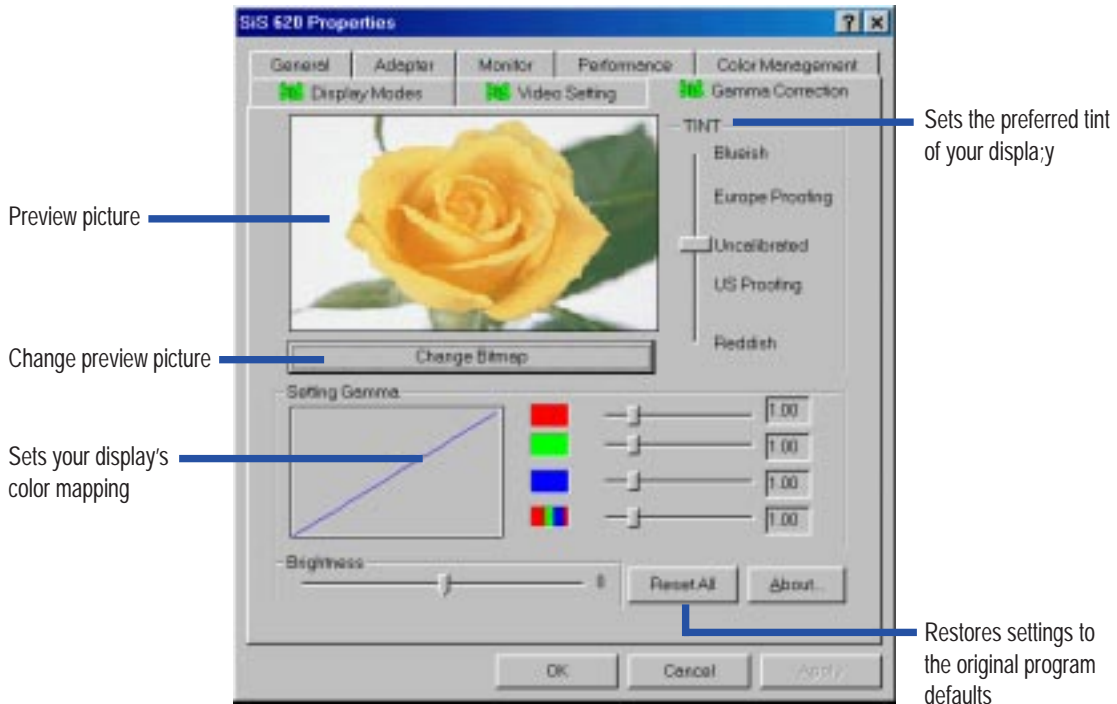

# 5. SOFTWARE SETUP

## 5.6 Install Audio Driver (only with onboard audio option)

Insert the Support CD that came with your motherboard into your CD-ROM drive or double-click the CD drive icon in **My Computer** to bring up the setup screen.

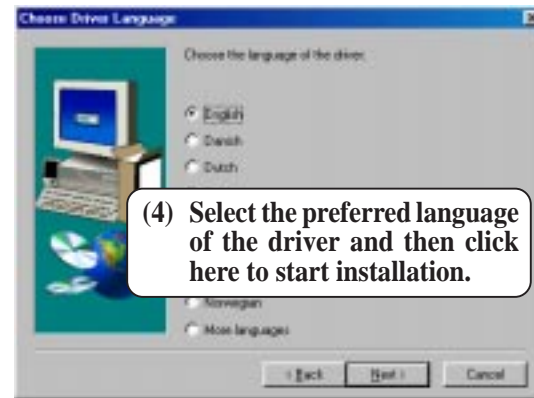
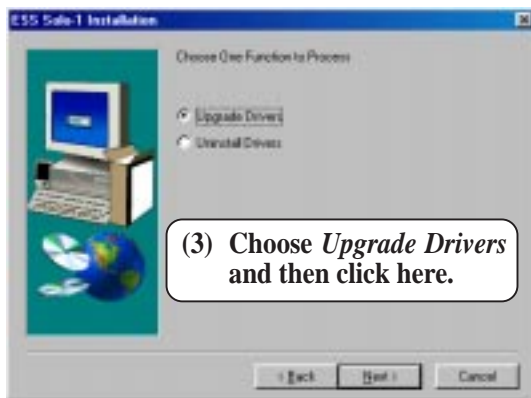



# 5. SOFTWARE SETUP

## 5.7 Install ESS AudioRack32 (only with onboard audio)

Insert the Support CD that came with your motherboard into your CD-ROM drive or double-click the CD drive icon in **My Computer** to bring up the setup screen.

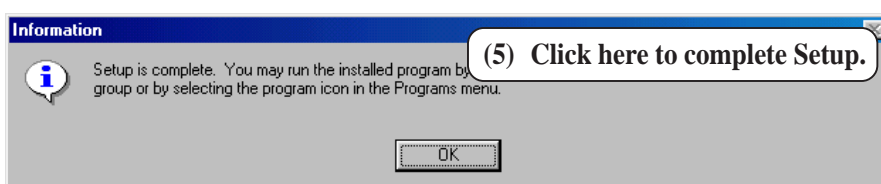
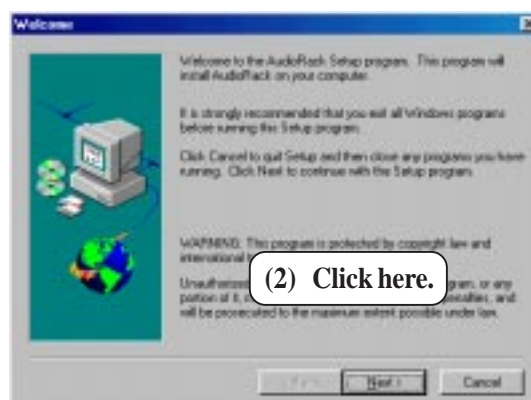





# 5. SOFTWARE SETUP

## 5.9 Install PC-Cillin 98 Vx.xx

Insert the Support CD that came with your motherboard into your CD-ROM drive or double-click the CD drive icon in **My Computer** to bring up the setup screen.

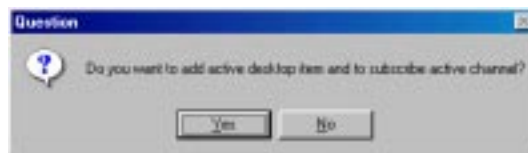

(6) & (7) Select the preferred features by clicking the appropriate buttons.

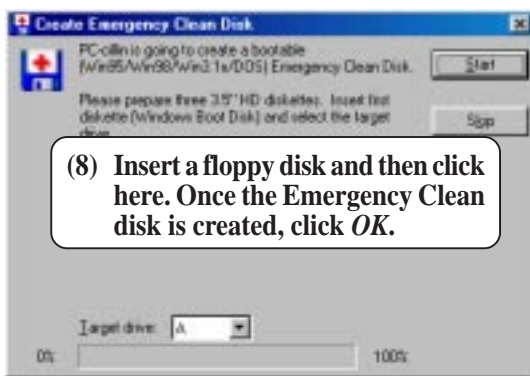

# 5. SOFTWARE SETUP

## 5.10 Install ADOBE Acrobat Reader Vx.x

Insert the Support CD that came with your motherboard into your CD-ROM drive or double-click the CD drive icon in **My Computer** to bring up the setup screen.

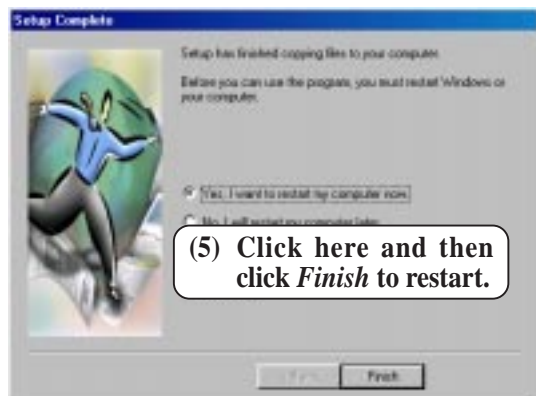
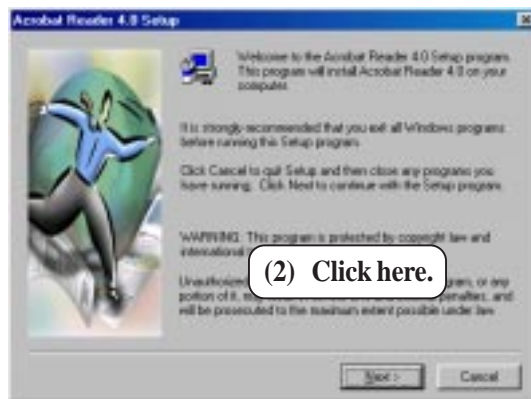

# 5. SOFTWARE SETUP

## 5.11 Uninstalling Programs

Add/Remove Programs is a basic component within Windows. You may use this function if a program does not provide its own uninstallation program.

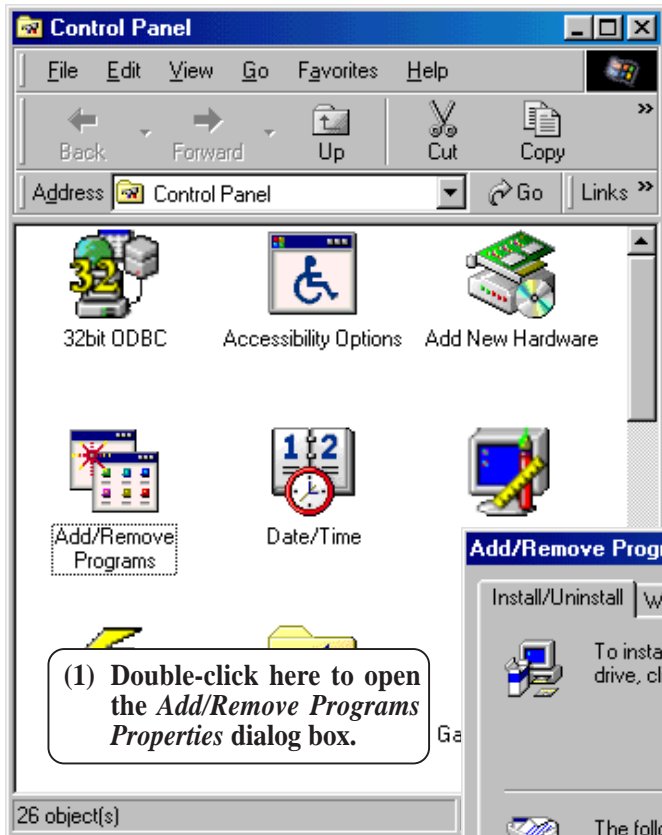

**(1) Double-click here to open the Add/Remove Programs Properties dialog box.**

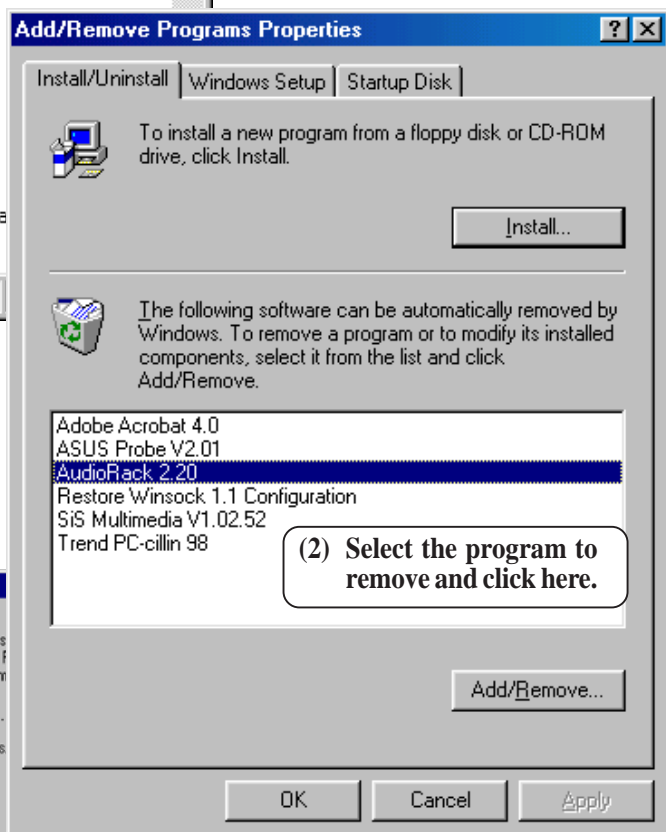

**(2) Select the program to remove and click here.**

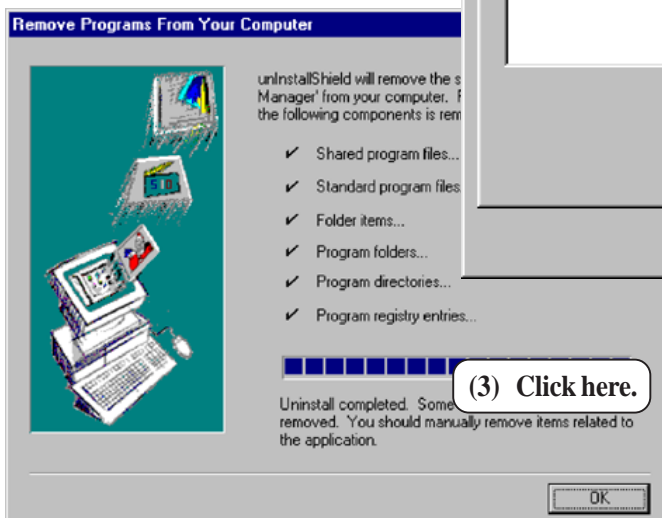

**(3) Click here.**

**5. SW/SETUP**  
**Windows 98**

## 6. SOFTWARE REFERENCE

### 6.1 ASUS PC Probe

ASUS PC Probe is a convenient utility to continuously monitor your computer system's vital components, such as fan rotations, voltages, and temperatures. It also has a utility that lets you review useful information about your computer, such as hard disk space, memory usage, and CPU type, CPU speed, and internal/external frequencies through the DMI Explorer.

#### 6.1.1 Starting ASUS PC Probe

When ASUS PC Probe starts, a splash screen appears allowing you to select whether to show the screen again when you open PC Probe or not. To bypass this startup screen, clear the **Show up in next execution** check box.



To open **ASUS PC Probe**, click the Windows **Start** button, point to **Programs**, and then **ASUS Utility**, and then click **Probe Vx.xx**.

The PC Probe icon  will appear on the taskbar's system tray indicating that ASUS PC Probe is running. Clicking the icon will allow you to see the status of your PC.

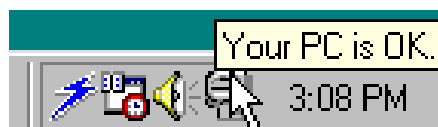



# 6. SOFTWARE REFERENCE

## 6.1.2 Using ASUS PC Probe

### Monitoring

#### Monitor Summary

Shows a summary of the items being monitored.



#### Temperature Monitor

Shows the PC's temperature.

Temperature Warning threshold adjustment  
(Move the slider up to increase the threshold level or down to decrease the threshold level)

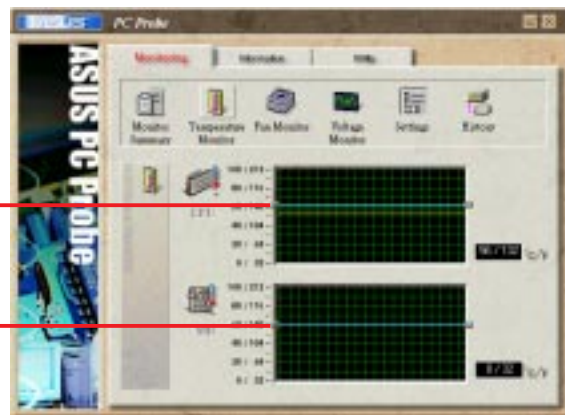

#### Fan Monitor

Shows the PC's fan rotation.

Fan Warning threshold adjustment  
(Move the slider up to increase the threshold level or down to decrease the threshold level)

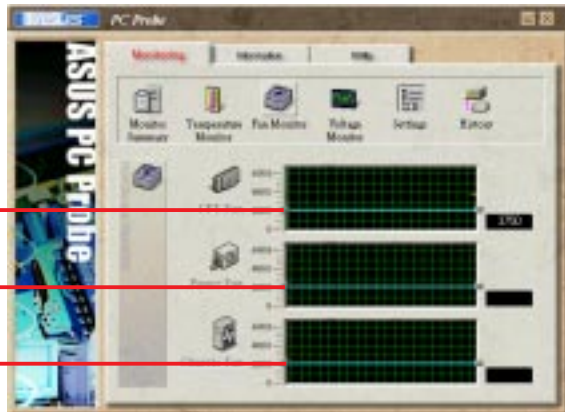

#### Voltage Monitor

Shows the PC's voltages.

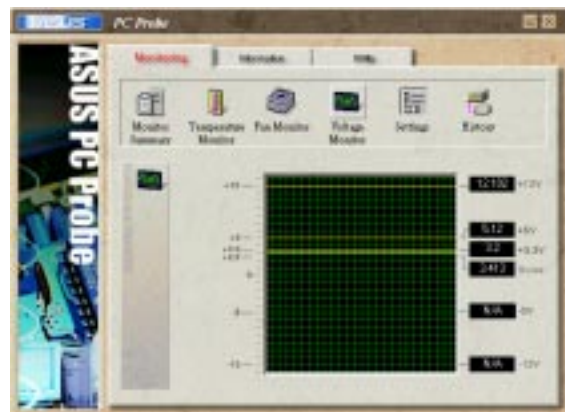

# 6. SOFTWARE REFERENCE

## Settings

Lets you set threshold levels and polling intervals or refresh times of the PC's temperature, fan rotation, and voltages.



## History

Lets you record the monitoring activity of a certain component of your PC by date, time, and target history.



## Information

### Hard Drives

Shows the used and free space of the PC's hard disk drives and the file allocation table or file system used.



### Memory

Shows the PC's memory load, memory usage, and paging file usage.





# 6. SOFTWARE REFERENCE

## Device Summary

Shows a summary of devices in your PC.



## DMI Explorer

Shows information pertinent to the PC, such as CPU type, CPU speed, and internal/external frequencies, and memory size.



## Utility

Lets you run programs outside of the ASUS Probe modules. To run a program, click **Execute Program**.



## 6. SOFTWARE REFERENCE

### 6.1.3 ASUS PC Probe Task Bar Icon

Right clicking the PC Probe icon will bring up a menu to open or exit ASUS PC Probe and pause or resume all system monitoring.



When the ASUS PC Probe senses a problem with your PC, portions of the ASUS PC Probe icon changes to red, the PC speaker beeps, and the ASUS PC Probe monitor is displayed.

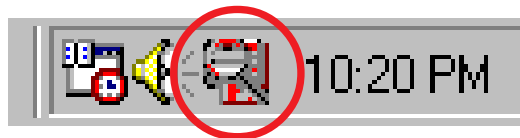

## 6. SOFTWARE REFERENCE

---

(This page was intentionally left blank)

# 6. SOFTWARE REFERENCE

## 6.2 AudioRack32

The **AudioRack32** enables you to take advantage of your computer's audio capabilities with all of the controls conveniently in one compact space. You can play audio CDs, wave files (in WAV and .AUD formats), and MIDI files (in .MID and .RMI formats). With the multisource Audio Mixer, you can blend these sources with line-in and microphone sources any way you choose. You can then record your creations as wave files and edit them with the Audio Recorder.

The **AudioRack32** has six main parts:

- Command Center—customizes the appearance of the **AudioRack32**.
- 3-D/Tone Controller—gives your computer ambient 3D sound, transmitting any sound played through the **AudioRack32** into a wider arc.
- Audio Mixer—controls the volume and balance of the **AudioRack32** devices.
- Digital Audio Player—plays and records files in the .WAV format.
- MIDI Player—enables you to play MIDI files.
- Compact Disk Player—enables you to play audio CDs on a CD-ROM drive.

In addition, the **AudioRack32** has a miniature mode enabling you to control the **AudioRack32** while using minimal screen space.

The Audio Recorder is a separate application from the **AudioRack32**. It can be used to add effects and edit files recorded with the Digital Audio Player or by the Audio Recorder itself. The Audio Recorder can be launched from the **AudioRack32**'s Digital Audio Player or on its own.



# 6. SOFTWARE REFERENCE

## 6.2.1 The Command Center

The Command Center controls which parts of the *AudioRack32* are displayed. You can display or hide any part of the *AudioRack32* you choose, customizing its appearance to suit your needs or desires. It also displays information on the status of the different audio components.

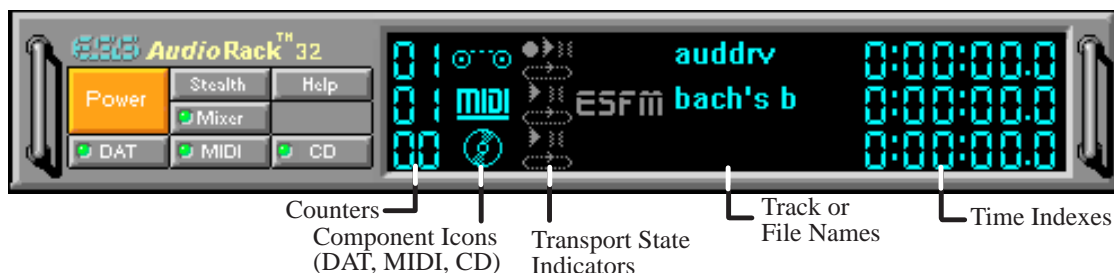

### The Command Center Controls

- Power** closes the *AudioRack32* window.
- Stealth** enables the Miniature mode, minimizing the *AudioRack32* display.
- DAT** displays/hides the Digital Audio Player.
- Help** accesses On-line Help.
- CD** displays/hides the Compact Disk Player.
- Mixer** displays/hides the Audio Mixer.
- MIDI** displays/hides the MIDI Player.

### The Command Center Display

**Counter:** shows you which track or file in the playlist the component is playing.

**Component Icon:** is displayed when the associated component is shown and is not displayed when the component is hidden.

**Transport State Indicator:** shows the state of a component. It indicates when the component is playing, paused, has the Auto Repeat enabled, or in the case of the Digital Audio Player, is recording.

**Track or File Name:** shows the name of the current track or file in the playlist.

**Time Index:** displays the amount of time elapsed for the track or file in hours, minutes, seconds, and tenths of a second.

## 6. SOFTWARE REFERENCE

### 6.2.2 The 3-D/Tone Controller

The 3-D/Tone Controller lets you create an atmosphere of a resonant sound environment rather than an audio issuing from a 2D plane. See online help for more information.



#### *The 3-D/Tone Controller Controls*

The Spatial Control has four settings:

**Max:** provides the greatest effect, works best with games.

**Mid:** works best with most audio CDs and music (default setting).

**Min:** works best with some audio CDs.

**Off:** no spatialization, normal stereo.

**NOTE:** You should have Spatializer hardware in your audio setup to be able to make full use of the controller functions in *AudioRack*. If you do not have, you may still see the controller, but it will have no effect on your PC's audio.

### 6.2.3 The Miniature Mode

The Miniature mode is designed to give you full control of the *AudioRack32* while using a minimum of space. You are able to effectively use the *AudioRack32* and still have enough room on your desktop to run other applications. In the Miniature mode, you can play, pause, stop, and control the master volume of the *AudioRack32*.

plays currently loaded tracks or files of active components

stops currently playing tracks or files of active components

pauses currently playing tracks or files of active components



controls the master volume

calls up a popup menu where you can restore the *AudioRack32*, invoke the **Always on Top** command, select active components (DAT, MIDI, or CD), or exit the *AudioRack32*. The Stop, Pause, and Play buttons affect components that are currently active

## 6. SOFTWARE REFERENCE

### 6.2.4 The Audio Mixer

The Audio Mixer has two modes: Playback mode and Record mode. You can use these two modes to fully control which of your audio sources you are listening to or recording, how loud each of those sources are and how they are balanced. Each audio source has its own module with mute, balance and volume controls.

In addition, the Audio Mixer provides special effects controls for chorus, reverb, treble, bass, and 3-D effects.



#### *The Audio Mixer Controls*

The two Playback and Record toggle buttons are used to switch between Playback mode and Record mode.

The Effects toggle button switches the display to the effects panel where you can use the buttons to enable and disable effects and the sliders to control the amount of the effect.

There are a number of audio source modules displayed on the Audio Mixer. The exact number displayed depends on the capabilities of your hardware. Each module has three controls:



a slider to adjust the balance

a slider to adjust the volume

a button for muting

Modules that your hardware may provide for are: Master, Line, Wave, Mic, CD, MIDI, and Aux B.

















# 6. SOFTWARE REFERENCE

## 6.2.5 The Digital Audio Player

The Digital Audio Player enables you to play, record, and compress sound as .WAV files. In addition, you can play .AUD files. The .WAV files use PCM, which is the Windows' audio file format. The .AUD format uses ESPCM' compression to produce an audio file. Files are written directly to your hard disk as you record, enabling you to record very large files. Your only limitation is the amount of free space on your hard disk. The voice activation feature is useful for recording any kind of intermittent audio. The Digital Audio Player provides a choice of linear PCM (8 or 16 bit) recording. Note that you have additional options using the Audio Recorder, which is invoked by the **Edit** button.



### *The Digital Audio Player Controls*

-  starts recording to your hard disk.
-  goes to the end of the wave file or to the next file in the current playlist.
-  plays the wave file currently loaded.
-  enables or disables the Auto Repeat.
-  activates or deactivates the Pause
-  opens the Audio Recorder window.
-  stops the file currently playing.
-  opens the Set Playlist dialog box.
-  goes back one second in the wave file.
-  starts a new file by opening the New Options dialog box.
-  goes forward one second in the wave file.
-  brings up the Open file dialog box in order to load a file into the Digital Audio Player.
-  goes to the beginning of the wave file or to the previous file in the current playlist.
-  saves an audio file.

### *The Digital Audio Player Display*

 The Level Meter displays the output from the left (top) and right (bottom) channels when a wave file is played.

 By clicking on the image of the tape deck, you can display information about the file currently loaded in the Digital Audio Player. The display tells you the file name, size, number of bits per sample, sample rate, and whether the file was recorded in stereo or mono. Click again to return to the image of the tape deck.

audrv.wav  
47 Kbytes  
16 bit 22 kHz  
Mono









## 6. SOFTWARE REFERENCE

### 6.2.6 The MIDI Player

The MIDI Player enables you to play MIDI files with the .MID or .RMI file extensions. These MIDI (Musical Instrument Digital Interface) files can be produced by sequencer programs and then played back using the MIDI Player. You can also mix MIDI files with other audio sources. Or you can compile MIDI files in a playlist and play them back in any order you choose.



#### *The MIDI Player Controls*

-  plays the MIDI file currently loaded.
-  goes back one file in the playlist.
-  activates/deactivates Pause
-  goes forward one file in the playlist.
-  stops the file currently playing.
-  enables/disables the Auto Repeat.
-  goes back one second in the MIDI file.
-  opens the Set Playlist dialog box.
-  goes forward one second in the MIDI file.

#### *The MIDI Player Display*

By clicking on the image of the floppy drive, you can display the length and name of the current MIDI file in the playlist. Click the display to return to the image of the floppy drive.

 The MIDI Player has an indicator to show when you are listening to ESFM. When the ESFM light to the left of the playlist button is lit, the MIDI Player is using ESFM synthesis. ESFM performs superior-quality music synthesis compared to that of traditional FM, producing richer timbre and greater depth of instrument voices. **FM synthesis is a lower quality technology compared with Wave table synthesis. This card supports Wave table synthesis therefore ESFM is not supported on this card.**











## 6. SOFTWARE REFERENCE

### 6.2.7 The Compact Disk Player

If you have a CD-ROM drive, you can play audio CDs. Check your hardware manual about setting up CD audio hardware and drivers. The Compact Disk Player uses intelligent CD playlist management: The Compact Disk Player maintains a record of each CD you play. It remembers the last playlist you used with each CD and loads that playlist automatically whenever you insert that CD.



#### *The Compact Disk Player Controls*

-  plays the MIDI file currently loaded.
-  goes back one file in the playlist.
-  activates or deactivates the Pause
-  goes forward one file in the playlist.
-  stops the file currently playing.
-  enables or disables the Auto Repeat.
-  goes back one second in the MIDI file.
-  opens the Set Playlist dialog box.
-  goes forward one second in the MIDI file.
-  ejects the CD from the CD-ROM drive.

## 6. SOFTWARE REFERENCE







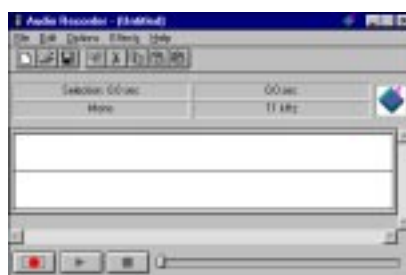





### 6.2.8 The Audio Recorder

The Audio Recorder enables you to record, compress, store, and play back voice, music, and other sound. It provides settings for sound attributes such as mono/stereo, compression level, and sampling rate. You can use it to embed sound objects in documents created in applications that support object linking and embedding (OLE).

The Audio Recorder's edit, record, and playback capabilities are compatible with the Windows Sound Recorder and other recorders that record and play back in the PCM format. Like the Digital Audio Player, the Audio Recorder can record and play back .WAV and .AUD files. The Audio Recorder allows a choice of compression from low, medium, and high ESPCM and ADPCM.



#### *The Audio Recorder Controls*

-  starts a new audio file.
-  inserts the Clipboard audio at the cursor or replaces the selected portion.
-  opens an audio file.
-  mixes the Clipboard audio with the audio beginning at the cursor.
-  saves an audio file.
-  starts recording.
-  reverses the last change you made to the current audio file.
-  plays the currently loaded audio file.
-  removes the selected portion of the audio file and stores it on the Clipboard.
-  stops the file currently playing or recording.
-  copies the selected audio portion to the Clipboard without removing it.
-  determines the cursor position on the waveform.

#### *The Audio Recorder Display*



The four text boxes under the tool bar display the length in seconds of the selected part of the currently loaded file, the total length in seconds of the current file, whether the file is in stereo or mono, and the sampling rate in kilohertz.

To the right of the text boxes is a box displaying the icon associated with the particular file. If a file has no icon associated with it, it is given a default icon.

# 6. SOFTWARE REFERENCE

---

## 6.2.9 Release Notes

This information is provided for convenience only. Information here is subject to change without prior notice. View the installation CD for any updated information in Readme text files. The AudioRack also provides detailed online help (click the **Help** button on the “Command Center”)

### *Disable Eject Button on the CD Player*

Under the Windows directory in the file “auddrive.ini”, there is a string “DisableEjectButton=0” under the [cdplayer] section. If you would like to disable EJECT button on the CD player, you can change the value from 0 to 1. You need to close AudioRack and launch it again to make the new settings take effect.

### *Using AudioRack CD Player as Default CD Player*

During installation, you will be asked if you want to use AudioRack CD player as the default CD player. Normally Windows 95 CD player is the default and will automatically run when an audio CD is inserted into the CD-ROM. If you answer “Yes”, the installation program will overwrite the value of the key [HKEY\_CLASSES\_ROOT]\AudioCD\shell\play\command in the registry. You may switch back to Windows 95 CD player by resetting this key value.

### *Configuring Playback Mixer*

The PCI audio chip offers eight inputs for the playback mixer, including “Line”, “Wave”, “CD”, “Synth”, “Aux A”, “Aux B”, “Mic”, and “Mono In”. AudioRack can only display six of them at a time. You may configure the settings by modifying the file “auddrive.ini” in the Windows directory. Under the section [MixerRak], you can enable or disable the display of each input by setting its corresponding binary value to 1 (enable) or 0 (disable).

## 6. SOFTWARE REFERENCE

### 6.3 Desktop Management Interface (DMI)

#### 6.3.1 Introducing the ASUS DMI Configuration Utility

This motherboard supports DMI within the BIOS level and provides a DMI Configuration Utility to maintain the Management Information Format Database (MIFD). DMI is able to auto-detect and record information pertinent to a computer's system such as the CPU type, CPU speed, and internal/external frequencies, and memory size. The onboard BIOS will detect as many system information as possible and store those collected information in a 4KB block in the motherboard's Flash EPROM and allow the DMI to retrieve data from this database. Unlike other BIOS software, the BIOS on this motherboard uses the same technology implemented for Plug and Play to allow dynamic real-time updating of DMI information versus creating a new BIOS image file and requiring the user to update the whole BIOS. This DMI Configuration Utility also allows the system integrator or end user to add additional information into the MIFD such as serial numbers, housing configurations, and vendor information. Those information not detected by the motherboard BIOS and has to be manually entered through the DMI Configuration Utility and updated into the MIFD. This DMI Configuration Utility provides the same reliability as PnP updating and will prevent the refreshing failures associated with updating the entire BIOS.

#### 6.3.2 Starting the ASUS DMI Configuration Utility

The DMI Configuration Utility (DMICFG2.EXE) must be used in real mode in order for the program to run, the base memory must be at least 180K. Memory managers like HIMEM.SYS (required by windows) must not be installed. You can boot up from a system diskette without AUTOEXEC.BAT and CONFIG.SYS files, "REM" HIMEM.SYS in the CONFIG.SYS, or press <Shift>+<F5> during bootup to bypass your AUTOEXEC.BAT and CONFIG.SYS files.

1. In Windows, copy DMICFG2.EXE to your hard disk drive.
2. Restart your computer and press <Shift>+<F5> during bootup to enter safe mode command prompt.
3. Go to the directory containing DMICFG2.EXE.
4. Type **DMICFG2** and press <Enter> to run.



# 6. SOFTWARE REFERENCE

## 6.3.3 Using the ASUS DMI Configuration Utility

**NOTE:** The following screen displays are provided as examples only and may not reflect the screen contents on your system.

### Edit DMI (or delete)



Use the ←→ (left-right) cursors to move the top menu items and the ↑↓ (up-down) cursor to move between the left hand menu items. The bottom of the screen will show the available keys for each screen. Press enter at the menu item to enter the right hand screen for editing. “Edit component” appears on top. The reversed color field is the current cursor position and the blue text are available for editing. The orange text shows auto-detected information and are not available for editing. The blue text “Press [ENTER] for detail” contains a second pop-up menu is available, use the + - (plus-minus) keys to change the settings. Enter to exit *and save*, ESC to exit *and not save*.

If the user has made changes, ESC will prompt you to answer Y or N. Enter Y to go back to the left-hand screen *and save*, enter N to go back to left-hand screen and *not save*. If editing has not been made, ESC will send you back to the left hand menu without any messages.

### Notes

A heading, \*\*\* BIOS Auto Detect \*\*\*, appears on the right for each menu item on the left side that has been auto detected by the system BIOS.

A heading, \*\*\* User Modified \*\*\*, will appear on the right for menu items that have been modified by the user.





## 6. SOFTWARE REFERENCE

### Save MIFD



You can save the MIFD (normally only saved to flash ROM) to a file by entering the drive and path here. If you want to cancel save, you may press ESC and a message “Bad File Name” appears here to show it was not saved.

### Load MIFD



You can load the disk file to memory by entering a drive and path and file name here.

### Load BIOS Defaults



You can load the BIOS defaults from a MIFD file and can clear all user modified and added data. You must reboot your computer in order for the defaults to be saved back into the Flash BIOS.

# 7. APPENDIX

## 7.1 ASUS PCI-L101 Fast Ethernet Card

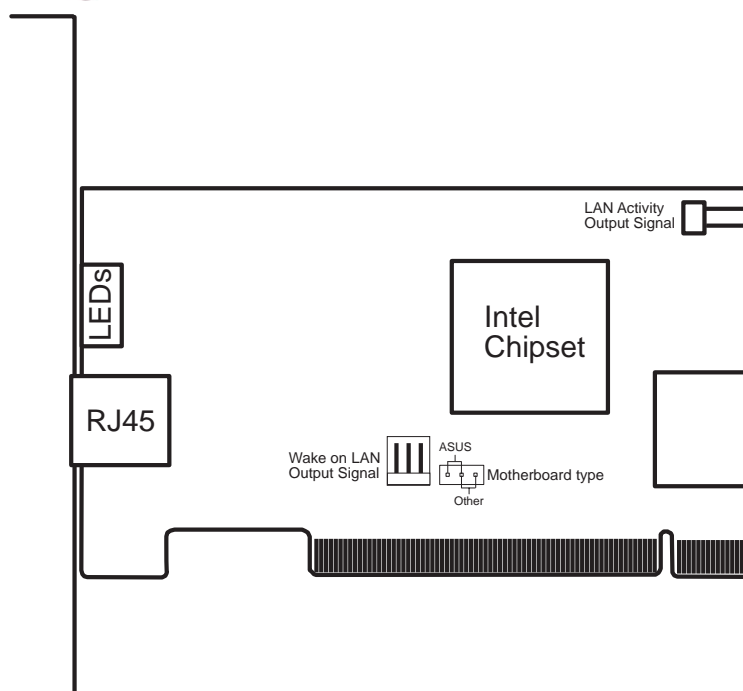
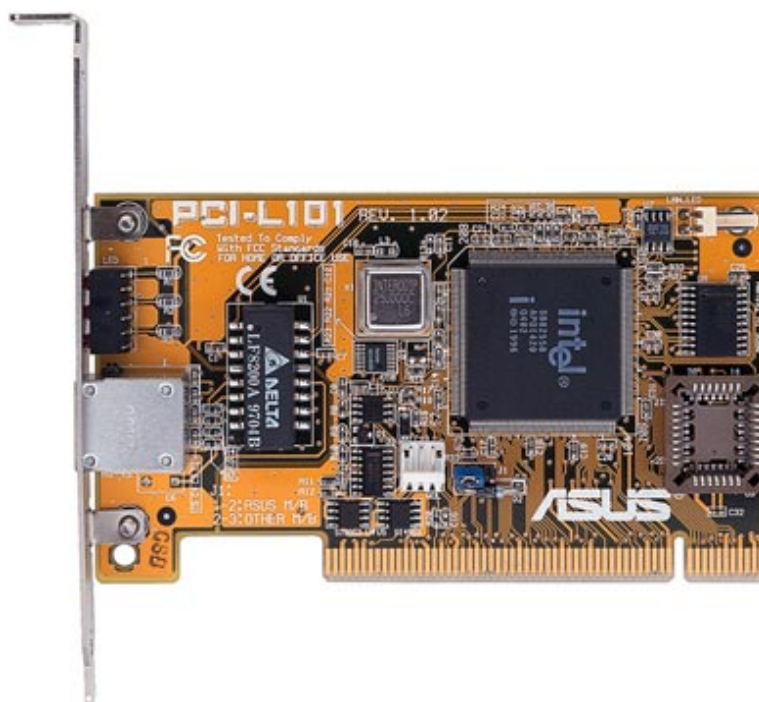

If you are using the ASUS PCI-L101 on an ASUS motherboard, leave the jumper on its default setting of “ASUS.” If you are using another brand of motherboard, set the jumper to “Other.” Connect the Wake on LAN (WOL) output signal to the motherboard’s WOL\_CON in order to utilize the Wake-On-LAN feature of the motherboard. Connect the LAN activity output signal (LAN\_LED) to the system cabinet’s front panel LAN\_LED in order to display LAN data activity.

# 7. APPENDIX

---

## 7.1.1 Features

- Intel 82558 Ethernet LAN Controller (Fully integrated 10BASE-T/100BASE-TX)
- Wake-On-LAN Remote Control Function Supported
- PCI Bus Master Complies with PCI Local Bus Rev. 2.1 specifications
- Consists of MAC & PHY (10/100Mbps) interfaces
- Complies with IEEE 802.3 10BASE-T and IEEE 802.3u 100BASE-TX interfaces
- Fully supports 10BASE-T & 100BASE-TX operations through a single RJ45 port
- Supports 32-bit Bus Master Technology / PCI Rev. 2.1
- Enhancements on ACPI & APM
- Adheres to PCI Bus Power Management Interface Rev. 1.0, ACPI Rev. 1.0, and Device Class Power Management Rev. 1.0
- IEEE 802.3u auto-negotiation for 10Mbps/100Mbps Network Data Transfer Rates.
- Provides LED indicators for monitoring network conditions
- Plug and Play

## 7.1.2 Software Driver Support

- **NetWare ODI Drivers** - Novell Netware 3.x, 4.x, DOS, OS/2 Client
- **NDIS 2.01 Drivers** - Microsoft LAN Manager, Microsoft Windows 3.11, IBM LAN Server
- **NDIS 3.0 Drivers** - Microsoft Windows NT, Microsoft Windows 95, Microsoft Windows 3.11

## 7.1.3 Question and Answer

Q: What is Wake-On-LAN?

A: The Wake-On-LAN feature provides the capability to remotely power on systems supporting Wake-On-LAN by simply sending a wake-up frame. With this feature, remotely uploading/downloading data to/from systems during off-peak hours will be feasible.

Q: What can Wake-On-LAN do for you?

A: Wake-On-LAN is a remote management tool with advantages that can reduce system management workload, provide flexibility to the system administrator's job, and then of course save you time-consuming efforts and costs.

Q: What components are required for Wake-On-LAN to function?

A: To enable Wake-On-LAN function, your system requires an Ethernet LAN adapter card that can activate Wake-On-LAN function, a client with Wake-On-LAN capability, and software such as LDCM Rev. 3.10 or up that can trigger wake-up frame.

---

(This page was intentionally left blank)

---

(This page was intentionally left blank)