

**ASUS<sup>®</sup> CUSL2**  
Intel<sup>®</sup> 815E ATX Motherboard

# USER'S MANUAL

# USER'S NOTICE

---

No part of this manual, including the products and software described in it, may be reproduced, transmitted, transcribed, stored in a retrieval system, or translated into any language in any form or by any means, except documentation kept by the purchaser for backup purposes, without the express written permission of ASUSTeK COMPUTER INC. ("ASUS").

ASUS PROVIDES THIS MANUAL "AS IS" WITHOUT WARRANTY OF ANY KIND, EITHER EXPRESS OR IMPLIED, INCLUDING BUT NOT LIMITED TO THE IMPLIED WARRANTIES OR CONDITIONS OF MERCHANTABILITY OR FITNESS FOR A PARTICULAR PURPOSE. IN NO EVENT SHALL ASUS, ITS DIRECTORS, OFFICERS, EMPLOYEES OR AGENTS BE LIABLE FOR ANY INDIRECT, SPECIAL, INCIDENTAL, OR CONSEQUENTIAL DAMAGES (INCLUDING DAMAGES FOR LOSS OF PROFITS, LOSS OF BUSINESS, LOSS OF USE OR DATA, INTERRUPTION OF BUSINESS AND THE LIKE), EVEN IF ASUS HAS BEEN ADVISED OF THE POSSIBILITY OF SUCH DAMAGES ARISING FROM ANY DEFECT OR ERROR IN THIS MANUAL OR PRODUCT.

Product warranty or service will not be extended if: (1) the product is repaired, modified or altered, unless such repair, modification or alteration is authorized in writing by ASUS; or (2) the serial number of the product is defaced or missing.

Products and corporate names appearing in this manual may or may not be registered trademarks or copyrights of their respective companies, and are used only for identification or explanation and to the owners' benefit, without intent to infringe.

- Adobe and Acrobat are registered trademarks of Adobe Systems Incorporated.
- Intel, LANDesk, and Pentium are registered trademarks of Intel Corporation.
- Cyrix is a registered trademark of VIA Technologies, Inc.
- Trend and ChipAwayVirus are trademarks of Trend Micro, Inc.
- Windows and MS-DOS are registered trademarks of Microsoft Corporation.

The product name and revision number are both printed on the product itself. Manual revisions are released for each product design represented by the digit before and after the period of the manual revision number. Manual updates are represented by the third digit in the manual revision number.

For previous or updated manuals, BIOS, drivers, or product release information, contact ASUS at <http://www.asus.com.tw> or through any of the means indicated on the following page.

SPECIFICATIONS AND INFORMATION CONTAINED IN THIS MANUAL ARE FURNISHED FOR INFORMATIONAL USE ONLY, AND ARE SUBJECT TO CHANGE AT ANY TIME WITHOUT NOTICE, AND SHOULD NOT BE CONSTRUED AS A COMMITMENT BY ASUS. ASUS ASSUMES NO RESPONSIBILITY OR LIABILITY FOR ANY ERRORS OR INACCURACIES THAT MAY APPEAR IN THIS MANUAL, INCLUDING THE PRODUCTS AND SOFTWARE DESCRIBED IN IT.

**Copyright © 2000 ASUSTeK COMPUTER INC. All Rights Reserved.**

Product Name: **ASUS CUSL2**  
Manual Revision: **1.01 E574**  
Release Date: **June 2000**

# ASUS CONTACT INFORMATION

---

## ASUSTeK COMPUTER INC. (Asia-Pacific)

### *Marketing*

Address: 150 Li-Te Road, Peitou, Taipei, Taiwan 112  
Telephone: +886-2-2894-3447  
Fax: +886-2-2894-3449  
Email: info@asus.com.tw

### *Technical Support*

MB/Others (Tel): +886-2-2890-7121 (English)  
Notebook (Tel): +886-2-2890-7122 (English)  
Desktop/Server (Tel): +886-2-2890-7123 (English)  
Fax: +886-2-2895-9254  
Email: tsd@asus.com.tw  
WWW: www.asus.com.tw  
FTP: ftp.asus.com.tw/pub/ASUS

## ASUS COMPUTER INTERNATIONAL (America)

### *Marketing*

Address: 6737 Mowry Avenue, Mowry Business Center, Building 2  
Newark, CA 94560, USA  
Fax: +1-510-608-4555  
Email: tmd1@asus.com

### *Technical Support*

Fax: +1-510-608-4555  
Email: tsd@asus.com  
WWW: www.asus.com  
FTP: ftp.asus.com/Pub/ASUS

## ASUS COMPUTER GmbH (Europe)

### *Marketing*

Address: Harkortstr. 25, 40880 Ratingen, BRD, Germany  
Fax: +49-2102-442066  
Email: sales@asuscom.de (for marketing requests only)

### *Technical Support*

Hotline: MB/Others: +49-2102-9599-0 Notebook: +49-2102-9599-10  
Fax: +49-2102-9599-11  
Support (Email): www.asuscom.de/de/support (for online support)  
WWW: www.asuscom.de  
FTP: ftp.asuscom.de/pub/ASUSCOM

# CONTENTS

---

<b>1. INTRODUCTION .....</b>	<b>7</b>
1.1 How This Manual Is Organized .....	7
1.2 Item Checklist .....	7
<b>2. FEATURES .....</b>	<b>8</b>
2.1 The ASUS CUSL2 .....	8
2.2 CUSL2 Motherboard Components .....	12
<b>3. HARDWARE SETUP .....</b>	<b>14</b>
3.1 CUSL2 Motherboard Layout .....	14
3.2 Layout Contents .....	15
3.3 Hardware Setup Procedure .....	17
3.4 Motherboard Settings .....	17
3.5 System Memory (DIMM) .....	24
3.5.1 General DIMM Notes .....	24
3.5.2 Memory Installation .....	25
3.6 Central Processing Unit (CPU) .....	26
3.7 Expansion Cards .....	27
3.7.1 Expansion Card Installation Procedure .....	27
3.7.2 Assigning IRQs for Expansion Cards .....	27
3.7.3 Communication and Networking Riser (CNR) Slots ....	28
3.7.4 Accelerated Graphics Port (AGP) Pro Slot .....	29
3.8 External Connectors .....	30
3.9 Starting Up the First Time .....	43
<b>4. BIOS SETUP .....</b>	<b>45</b>
4.1 Managing and Updating Your BIOS .....	45
4.1.1 Upon First Use of the Computer System .....	45
4.1.2 Updating BIOS Procedures .....	46
4.2 BIOS Setup Program .....	49
4.2.1 BIOS Menu Bar .....	50
4.2.2 Legend Bar .....	50
4.3 Main Menu .....	52
4.3.1 Primary & Secondary Master/Slave .....	53
4.3.2 Keyboard Features .....	56
4.4 Advanced Menu .....	58
4.4.1 Chip Configuration .....	61
4.4.2 I/O Device Configuration .....	64
4.4.3 PCI Configuration .....	66
4.4.4 Shadow Configuration .....	68

# CONTENTS

---

4.5	Power Menu .....	69
4.5.1	Power Up Control .....	71
4.5.2	Hardware Monitor .....	73
4.6	Boot Menu .....	74
4.7	Exit Menu .....	76
<b>5.</b>	<b>SOFTWARE SETUP .....</b>	<b>79</b>
5.1	Install Operating System .....	79
5.2	Start Windows .....	79
5.3	CUSL2 Motherboard Support CD .....	80
5.4	INF Update Utility for Intel 815 Chipset .....	82
5.5	Intel 815 Chipset Graphic Control Driver .....	83
5.6	Intel LDCM Administrator Setup .....	85
5.7	Intel LDCM Client Setup .....	87
5.8	ASUS BIOS Flash Utility for LDCM 6.0 .....	88
5.9	ASUS PC Probe Vx.xx .....	89
5.10	Install ASUS Update Vx.xx .....	90
5.11	Microsoft DirectX 6.0 Driver .....	91
5.12	YAMAHA SoftSynthesizer S-YXG50 .....	93
5.13	PC-Cillin 98 Vx.xx .....	93
5.14	Adobe Acrobat Reader Vx.x .....	94
5.15	Cyberlink Video and Audio Applications .....	95
5.16	Uninstalling Programs .....	96
<b>6.</b>	<b>SOFTWARE REFERENCE .....</b>	<b>99</b>
6.1	Display Properties .....	99
6.2	ASUS PC Probe .....	102
6.3	ASUS LiveUpdate .....	107
6.4	YAMAHA XGPlayer .....	108
6.5	Cyberlink PowerPlayer SE .....	109
6.6	CyberLink PowerDVD .....	110
6.7	CyberLink VideoLive Mail .....	111
<b>7.</b>	<b>APPENDIX .....</b>	<b>113</b>
7.1	PCI-L101 Fast Ethernet Card .....	113
7.2	Glossary .....	115
	<b>INDEX .....</b>	<b>119</b>

# FCC & DOC COMPLIANCE

---

## ***Federal Communications Commission Statement***

This device complies with FCC Rules Part 15. Operation is subject to the following two conditions:

- This device may not cause harmful interference, and
- This device must accept any interference received, including interference that may cause undesired operation.

This equipment has been tested and found to comply with the limits for a Class B digital device, pursuant to Part 15 of the FCC Rules. These limits are designed to provide reasonable protection against harmful interference in a residential installation. This equipment generates, uses and can radiate radio frequency energy and, if not installed and used in accordance with manufacturer's instructions, may cause harmful interference to radio communications. However, there is no guarantee that interference will not occur in a particular installation. If this equipment does cause harmful interference to radio or television reception, which can be determined by turning the equipment off and on, the user is encouraged to try to correct the interference by one or more of the following measures:

- Re-orient or relocate the receiving antenna.
- Increase the separation between the equipment and receiver.
- Connect the equipment to an outlet on a circuit different from that to which the receiver is connected.
- Consult the dealer or an experienced radio/TV technician for help.

**WARNING!** Any changes or modifications to this product not expressly approved by the manufacturer could void any assurances of safety or performance and could result in violation of Part 15 of the FCC Rules.

Reprinted from the Code of Federal Regulations #47, part 15.193, 1993. Washington DC: Office of the Federal Register, National Archives and Records Administration, U.S. Government Printing Office.

## ***Canadian Department of Communications Statement***

This digital apparatus does not exceed the Class B limits for radio noise emissions from digital apparatus set out in the Radio Interference Regulations of the Canadian Department of Communications.

**This Class B digital apparatus complies with Canadian ICES-003.**

**Cet appareil numérique de la classe B est conforme à la norme NMB-003 du Canada.**

# 1. INTRODUCTION

## 1.1 How This Manual Is Organized

This manual is divided into the following sections:

<b>1. INTRODUCTION</b>	Manual information and checklist
<b>2. FEATURES</b>	Production information and specifications
<b>3. HARDWARE SETUP</b>	Intructions on setting up the motherboard.
<b>4. BIOS SETUP</b>	Intructions on setting up the BIOS
<b>5. SOFTWARE SETUP</b>	Intructions on setting up the included software
<b>6. SOFTWARE REFERENCE</b>	Reference material for the included software
<b>7. APPENDIX</b>	Optional items and general reference

## 1.2 Item Checklist

Check that your package is complete. If you discover damaged or missing items, contact your retailer.

### Package Contents

- (1) ASUS Motherboard
- (1) 40-pin 80-conductor ribbon cable for internal UltraDMA100/66/33 IDE drives
- (1) Ribbon cable for master and slave IDE drives
- (1) Ribbon cable for (1) 5.25" and (2) 3.5" floppy disk drives
- (1) Bag of spare jumpers
- (1) Support drivers and utilities
- (1) This Motherboard User's Manual
- (1) ASUS 3-port USB connector set with bracket

### Optional Items

- USB Hub CNR card
- LAN/Home PNA CNR card
- AIMM card
- LCD controller module
- TVOUT controller module
- ASUS iPanel
- ASUS consumer infrared set
- ASUS IrDA-compliant infrared module

## 2. FEATURES

---

### 2.1 The ASUS CUSL2

The ASUS CUSL2 motherboard is carefully designed for the demanding PC user who wants advanced features processed by the fastest processors.

#### 2.1.1 Specifications

- **Latest Intel Processor Support**

Pentium® III	100/133MHz FSB	FC-PGA
Celeron™	66MHz FSB	FC-PGA
- **North Bridge System Chipset:** The Intel® 815E chipset supports a 66/100/133 Front Side Bus (FSB), up to 512MB of PC100/PC133 SDRAM, and AGP Pro/4X mode, which can transport twice the amount of data compared to the current AGP standard.
- **South Bridge System Chipset:** The Intel I/O Controller Hub 2 (ICH2) features support for UltraDMA/100, which allows burst mode data transfer rates of up to 100MB/sec; two USB controllers for a total of 4 USB ports; and six channel AC97 CODEC support.
- **Intel® Accelerated Hub Architecture:** Features a dedicated high speed hub link between the ICH2 and GMCH with a bandwidth of 266MB/sec – twice the maximum bandwidth of the PCI bus.
- **PC100/PC133 Memory Support:** Equipped with three Dual Inline Memory Module (DIMM) sockets to support PC100/PC133-compliant SDRAMs (available in 64, 128, 256, 512MB densities) up to 512MB.
- **Integrated Graphics!** The 24-bit 230MHz RAMDAC graphics controller supports 3D hyper pipelined architecture, parallel data processing and compression, precise pixel interpolation, full 2D hardware acceleration, and motion video acceleration. This integrated graphics controller can be disabled to support an external AGP or PCI graphics card.
- **AGP Pro Slot:** Comes with an Accelerated Graphics Port Pro slot that supports AGP cards for high performance, component level interconnect targeted at 3D graphical applications using a 1X, 2X, or 4X mode bus. Backward compatible to support AGP 4X and AGP 2X. This slot can also support an AGP Inline Memory Module (AIMM) for up to 4MB of 133MHz SDRAM display cache.
- **UltraDMA33/66/100 Support:** Comes with an onboard PCI Bus Master IDE controller with two connectors that support four IDE devices on two channels. Supports UltraDMA/100, UltraDMA/66, UltraDMA/33, PIO Modes 3 & 4 and Bus Master IDE DMA Mode 2, and Enhanced IDE devices, such as DVD-ROM, CD-ROM, CD-R/RW, LS-120, and Tape Backup drives.
- **Wake-Up Support:** Supports Wake-On-LAN and Wake-On-Ring, Keyboard Wake-Up, and BIOS Wake-Up.
- **JumperFree™ Mode:** Allows processor settings and easy overclocking of frequency and Vcore voltage all through BIOS setup when JumperFree™ mode is enabled. Easy-to-use DIP switches instead of jumpers are included to allow manual adjustment of the processor's external frequency.



## 2. FEATURES

---

- **Around-the-Clock Intrusion Detection:** Chassis intrusion circuitry can log chassis open events into LDCM. The onboard battery supports detection even when normal power is removed and through a new design, battery drain is even lower than the RTC used for keeping time!
- **Firmware Hub:** Provides security-enhancements in computer platforms by supporting Random Number Generator (RNG).
- **PC Health Monitoring:** Provides an easy way to examine and manage system status information, such as CPU and system voltages, temperatures, and fan status through the onboard hardware ASUS ASIC and the bundled ASUS PC Probe or Intel LDCM software.
- **CNR Support:** Two Communication and Networking Riser (CNR) slots provide interfaces to support very affordable multichannel audio, V.90 analog modem, Home PNA, 10/100 Ethernet networking, USB hub, as well as future technologies such as xDSL.
- **PCI Expansion Slots:** Provides six 32-bit PCI (PCI 2.2 compliant) expansion slots. All PCI slots can support Bus Master PCI cards, such as SCSI or LAN cards. (PCI supports up to 133MB/s maximum throughput.)
- **Low Pin Count (LPC) Multi-I/O:** Provides two high-speed UART compatible serial ports and one parallel port with EPP and ECP capabilities. UART2 can also be directed from COM2 to the Infrared Module for wireless connections.
- **Enhanced ACPI & Anti-Boot Virus Protection:** Programmable BIOS (Flash EEPROM), offering enhanced ACPI for Windows 98 compatibility, built-in firmware-based virus protection, and autodetection of most devices for virtually automatic setup.
- **Smart BIOS:** 4Mbit firmware gives a new easy-to-use interface which provides more control and protection over the motherboard. Provides Vcore and CPU/SDRAM frequency adjustments, boot block write protection, and HD/SCSI/MO/ZIP/CD/Floppy boot selection. Hardware random number generator supports new security software for data protection and secured Internet transactions.
- **Concurrent PCI:** Concurrent PCI allows multiple PCI transfers from PCI master busses to the memory and processor.
- **Onboard LED:** The onboard LED will light up when there is standby power to the motherboard. This acts as a reminder to the user to turn OFF the power before plugging and unplugging devices so as not to damage the motherboard, peripherals, and/or components.
- **One Touch Management:** Supports an optional ASUS iPanel, an easy to access box with system information LED display, front I/O ports, and space reserved for a hard disk drive. With an ASUS iPanel, you can monitor your computer system's vital components.
- **LCD/TV Output:** The LCD/TV interface can support either an optional LCD module for LCD output or a TV-out module for TV output.
- **SMBus:** Features the System Management Bus interface, which is used to physically transport commands and information between SMBus devices.

## 2. FEATURES

---

### 2.1.2 Specifications—Optional Components

The following onboard components are optional at the time of purchase:

- **Onboard Audio:** AC97 V2.1 compliant Audio Codec with 3D sound circuitry and sample rate conversion from 7kHz to 48kHz.

### 2.1.3 Performance

- **UltraPerformance:** Onboard IDE Bus Master controller with two connectors that support four IDE devices in two channels. Supports UltraDMA/100, UltraDMA/66, UltraDMA/33 (IDE DMA Mode 2), PIO Modes 3 & 4, and supports Enhanced IDE devices, such as DVD-ROM, CD-ROM, CD-R/RW, LS-120, and Tape Backup drives.
- **High-Speed Data Transfer Interface:** IDE transfers using UltraDMA/66 Bus Master IDE can handle rates up to 66.6MB/s. This motherboard with its chipset and support for UltraDMA/100 increases the data transfer rate to 100MB/s. UltraDMA/100 is backward compatible with DMA/66, DMA/33, and DMA and with existing DMA devices and systems so there is no need to upgrade current EIDE/IDE drives and host systems. (UltraDMA/66/100 requires a 40-pin 80-conductor cable to be enabled.)
- **Concurrent PCI:** Concurrent PCI allows multiple PCI transfers from PCI master buses to memory and processor.
- **SDRAM Optimized Performance:** This motherboard supports PC133-compliant Synchronous Dynamic Random Access Memory (SDRAM), which increases the data transfer rate to 1066MB/s max.
- **ACPI Ready:** ACPI (Advanced Configuration and Power Interface) is also implemented on all ASUS smart series motherboards. ACPI provides more Energy Saving Features for future operating systems (OS) supporting OS Direct Power Management (OSPM) functionality. With these features implemented in the OS, PCs can be ready around the clock, yet satisfy all the energy saving standards. To fully utilize the benefits of ACPI, an ACPI-supported OS, such as Windows 98, must be used.
- **Suspend and Go:** Suspend-to-RAM (STR) provides maximum power savings as an alternative to leaving the computer ON and QuickStart™ so that you do not have to wait for a long time for system bootup.
- **New Compliant:** Both the BIOS and hardware levels of the motherboard meet the stringent requirements for PC 99 certification. The new PC 99 requirements for systems and components are based on the following high-level goals: support for Plug and Play compatibility and power management for configuring and managing all system components, and 32-bit device drivers and installation procedures for Windows 95/98/NT. Color-coded connectors and descriptive icons make identification easy as required by PC 99.

## 2. FEATURES

---

### 2.1.4 Intelligence

- **Fan Status Monitoring and Alarm:** To prevent system overheat and system damage, the CPU, power supply, and system fans can be monitored for RPM and failure. All the fans are set for its normal RPM range and alarm thresholds.
- **Temperature Monitoring and Alert:** To prevent system overheat and system damage, this motherboard supports processor thermal sensing and auto-protection.
- **Voltage Monitoring and Alert:** System voltage levels are monitored to ensure stable current to critical motherboard components. Voltage specifications are more critical for future processors, so monitoring is necessary to ensure proper system configuration and management.
- **System Resources Alert:** Today's operating systems, such as Windows 98, Windows NT, and OS/2, require much more memory and hard drive space to present enormous user interfaces and run large applications. The onboard hardware ASUS ASIC in conjunction with either the bundled ASUS PC Probe or Intel LDCM will warn the user before the system resources are used up to prevent possible application crashes. Suggestions will give the user information on managing their limited resources more efficiently.
- **Dual Function Power Button:** Through BIOS, the power button can be defined as the "Stand by" (a.k.a. Suspend or Sleep) button or as the Soft-Off (see **ATX Power / Soft-Off Switch Lead** in **3.8 Connectors** for more information) button. Regardless of the setting, pushing the power button for more than 4 seconds will enter the Soft-Off mode.
- **Remote Ring On (requires modem):** This allows a computer to be turned on remotely through an internal or external modem. With this benefit on-hand, users can access any information from their computers from anywhere in the world.
- **Message LED (requires ACPI OS support):** Message LEDs now act as information providers. Through the way a particular LED illuminates, the user can determine if a message has been received from a fax/modem. A simple glimpse provides useful information to the user. This function requires ACPI OS and driver support.
- **Peripheral Power Up:** Keyboard or Mouse power up can be enabled or disabled through BIOS setup to allow the computer to be powered ON using your keyboard or mouse click.

# 2. FEATURES

## 2.2 CUSL2 Motherboard Components

See opposite page for locations.

	<b>Location</b>
<b>Processor Support</b>	Socket 370 for Pentium III/Celeron (FC-PGA) Processors ..... 1
	Feature Setting DIP Switches ..... 5
<b>Chipsets</b>	Intel 815E Graphics Memory Controller Hub (GMCH) ..... 2
	Intel I/O Controller Hub 2 (ICH2) ..... 10
	4Mbit Firmware Hub (FWH) ..... 12
	Low Pin Count (LPC) Multi-I/O Chipset ..... 11
<b>Main Memory</b>	3 DIMM Sockets (maximum 512MB support) ..... 3
	PC133 SDRAM support
<b>Expansion Slots</b>	6 PCI Slots ..... 18
	1 Accelerated Graphics Port (AGP) Pro Slot ..... 19
	1 or 2 CNR Slots ..... 15
<b>System I/O</b>	USB Headers ..... 14
	1 Floppy Disk Drive Connector ..... 6
	2 IDE Connectors (UltraDMA/100 Support) ..... 4
	1 Serial COM2 Header ..... 7
	1 ASUS iPanel Connector ..... 8
	1 Parallel Port Connector ..... (Top) 23
	1 Serial COM1 Port Connector ..... (Bottom) 24
	2 USB Port Connectors ..... 25
	1 PS/2 Mouse Connector ..... (Top) 26
	1 PS/2 Keyboard Connector ..... (Bottom) 26
<b>3D Graphics</b>	Graphics and Memory Controller Hub
	1 VGA Monitor Output Connector ..... 22
	TV-Out/Digital LCD Module Headers ..... 20
<b>Audio</b>	AC'97 V2.1 Audio Codec (optional)
	1 Game/MIDI Connector (on audio model only)
	1 Line Out Connector (on audio model only)
	1 Line In Connector (on audio model only)
	1 Microphone Connector (on audio model only)
<b>Network Features</b>	Wake-On-LAN Connector ..... 17
	Wake-On-Ring Connector ..... 9
<b>Hardware Monitoring</b>	System Voltage Monitoring (integrated in ASUS ASIC) ..... 13
	3 Fan Power and Speed Monitoring Connectors
<b>Power</b>	ATX Power Supply Connector ..... 21
<b>Special Feature</b>	Onboard LED ..... 16
<b>Form Factor</b>	ATX

# 2. FEATURES

## 2.2.1 Component Locations

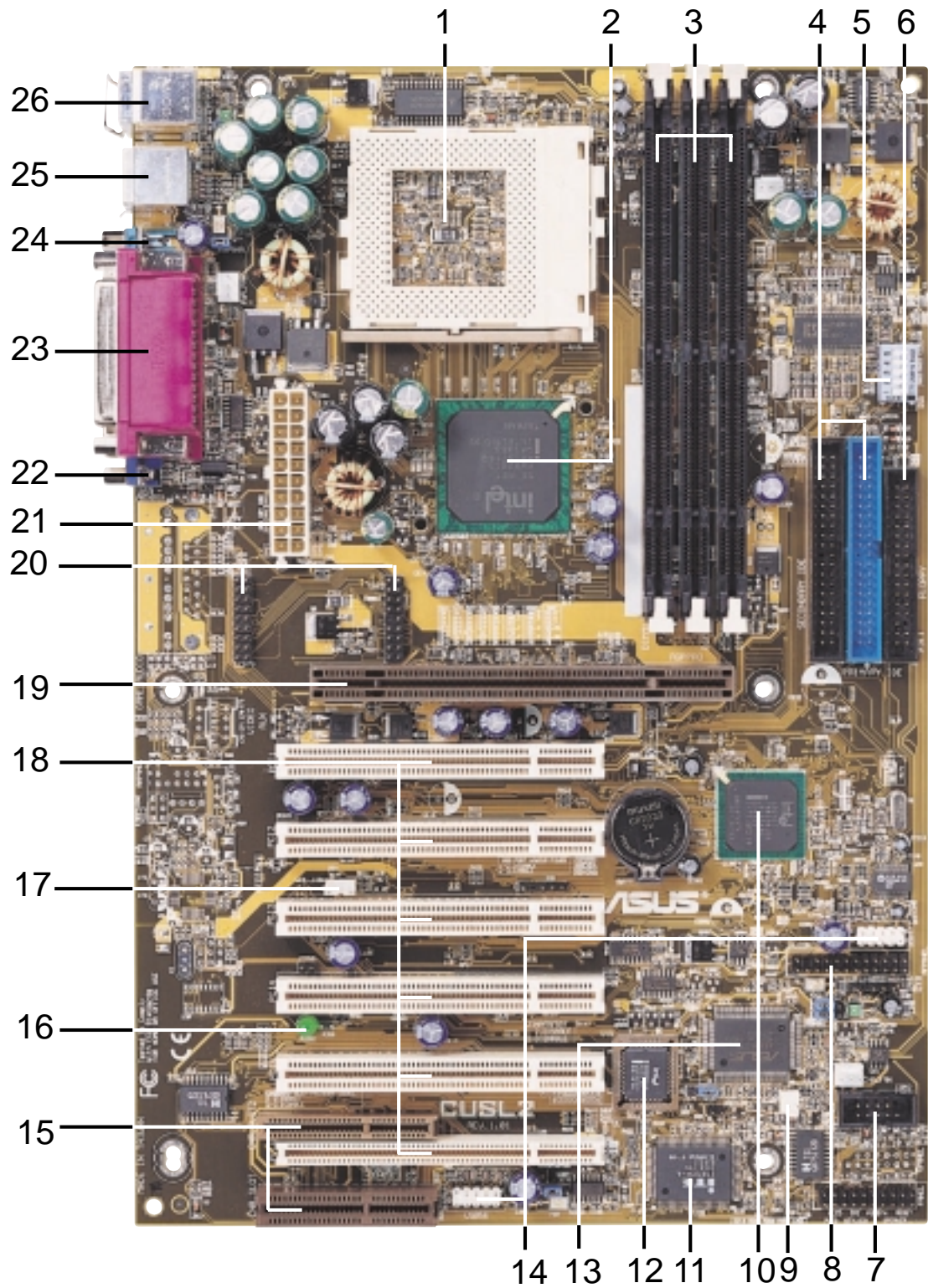

**2. FEATURES**  
Component Location

# 3. HARDWARE SETUP

## 3.1 CUSL2 Motherboard Layout

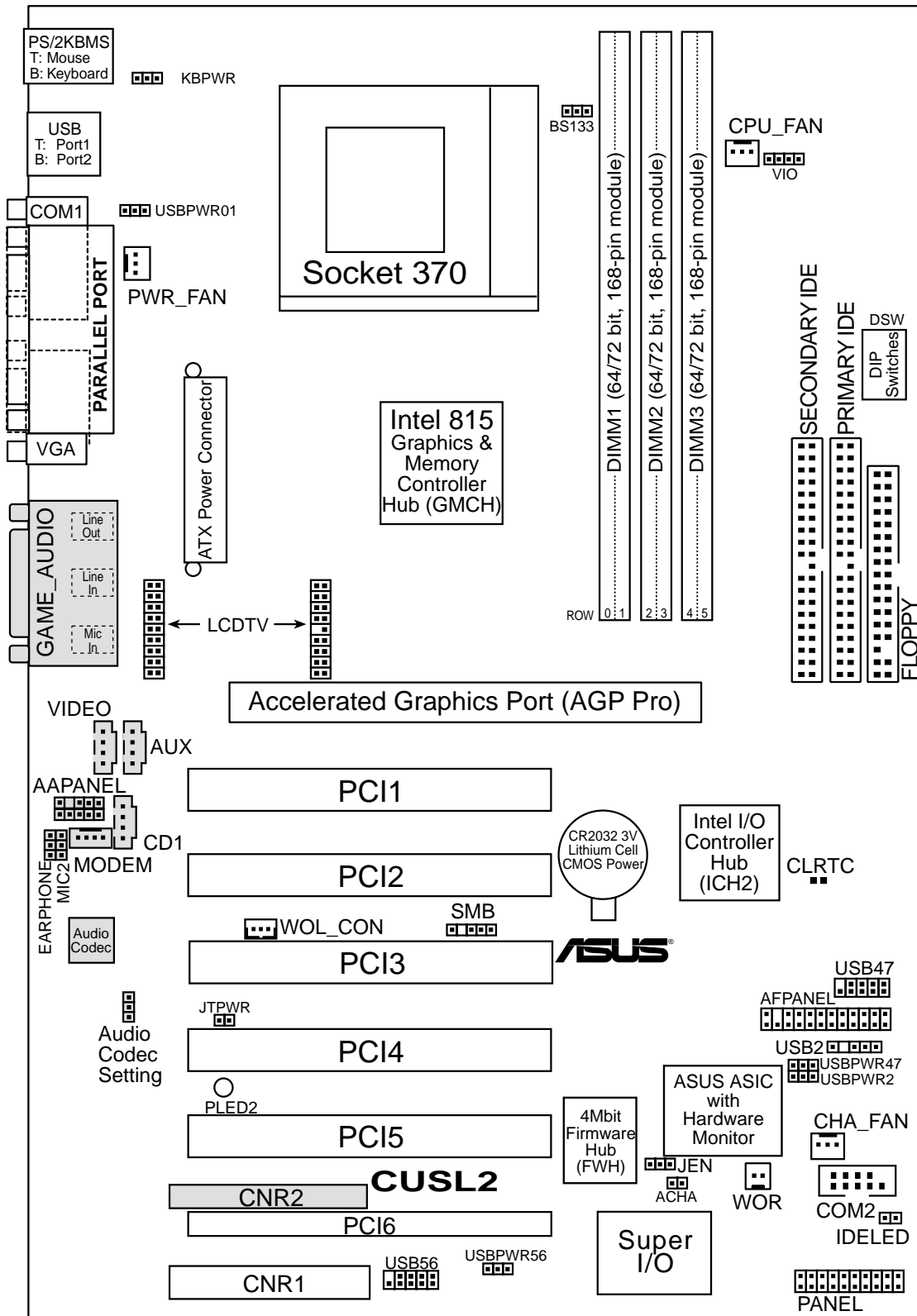

Grayed components are optional at the time of purchase.

3. HW SETUP  
Motherboard Layout

# 3. HARDWARE SETUP

## 3.2 Layout Contents

### Motherboard Settings

- |  |   |
|--|---|
| 1) JEN   | p.18 JumperFree™ Mode (Enable/Disable)      |
| 2) USBPWR01<br>USBPWR2<br>USBPWR47<br>USBPWR56 | p.19 USB Device Wake Up (Enable/Disable)    |
| 3) ADN#  | p.20 Onboard Audio CODEC (Enable/Disable)   |
| 4) KBPWR                                       | p.20 Keyboard Power Up (Enable/Disable)     |
| 5) VIO   | p.21 Voltage I/O Setting (3.3V/3.40V/3.60V) |
| 6) DSW   | p.22 CPU External Frequency Setting         |

### Expansion Slots

- |                   |   |
|-------------------|---|
| 1) DIMM1/2/3      | p.24 168-Pin System Memory Support            |
| 2) CPU            | p.26 Central Processing Unit (CPU)6           |
| 3) PCI1/2/3/4/5/6 | p.27 32-bit PCI Bus Expansion Slots           |
| 4) CNR1, CNR2     | p.28 Communication and Network Riser Slots    |
| 5) AGPPRO         | p.29 Accelerated Graphics Port (AGP Pro) Slot |

### Connectors

- |                                 |  |
|---------------------------------|--|
| 1) PS2KBMS                      | p.30 PS/2 Mouse Connector (6-pin female)                     |
| 2) PS2KBMS                      | p.30 PS/2 Keyboard Connector (6-pin female)                  |
| 3) USB                          | p.31 Universal Serial Bus Ports (Two 4-pin female)           |
| 4) PRINTER                      | p.31 Parallel Port Connector (25-pin female)                 |
| 5) COM1/COM2                    | p.32 Serial Port Connectors (9-pin male, 10-1 pin)           |
| 6) VGA                          | p.32 Monitor Output Connector (15-pin female)                |
| 7) GAME_AUDIO                   | p.33 Game/MIDI Connector (15-pin female) (optional)          |
| 8) GAME_AUDIO                   | p.33 Audio Port Connectors (Three 1/8" female) (optional)    |
| 9) FLOPPY                       | p.33 Floppy Disk Drive Connector (34-1pins)                  |
| 10) PRIMARY/SECONDARYIDE        | p.34 Primary/Secondary IDE Connectors (Two 40-1pins)         |
| 11) IDELED                      | p.35 IDE Activity LED (2 pins)                               |
| 12) CPU_FAN, PWR_FAN<br>CHA_FAN | p.35 CPU, Power Supply, Chassis Fan Connectors (Three 3-pin) |
| 13) CD1, AUX,<br>VIDEO, MODEM   | p.36 Internal Audio Connectors (Four 4-pins) (optional)      |
| 14) EARPHONE                    | p.36 Headphone True-Level Line Out Header (3 pins)           |
| 15) MIC2                        | p.37 Internal Microphone Connector (3 pins)                  |
| 16) AFPANEL/IR_CON              | p.37 ASUS iPanel Connector (12-1 pins)                       |
| 17) AAPANEL                     | p.37 ASUS iPanel Audio Connector (12-1 pins)                 |
| 18) SMB                         | p.38 SMBus Connector (5-1 pins)                              |

# 3. HARDWARE SETUP

---

19) ACHA	p.38 Chassis Intrusion Connector (2 pins)
20) WOL_CON	p.39 Wake-On-LAN Connector (3 pins)
21) WOR_CON	p.39 Wake-On-Ring Connector (2 pins)
22) LCDTV	p.40 LCD-TV Headers (18-1 pins/18 pins)
23) USB2, USB47, USB56	p.40 USB Headers (5-1 pins, Two 10-1 pins)
24) ATXPWR	p.41 ATX Power Supply Connector (20 pins)
25) JTPWR	p.41 Power Supply Thermal Sensor Connector (2 pins)
26) PWRLLED (PANEL)	p.42 System Power LED Lead (3-1 pins)
27) KEYLOCK (PANEL)	p.42 Keyboard Lock Switch Lead (2 pins)
28) SPEAKER (PANEL)	p.42 System Warning Speaker Connector (4 pins)
29) MSG.LED (PANEL)	p.42 System Message LED (2 pins)
30) SMI (PANEL)	p.42 System Management Interrupt Switch Lead (2 pins)
31) PWRSW (PANEL)	p.42 ATX Power / Soft-Off Switch Lead (2 pins)
32) RESET (PANEL)	p.42 Reset Switch Lead (2 pins)



# 3. HARDWARE SETUP

## 3.3 Hardware Setup Procedure

Before using your computer, you must complete the following steps:

- Check Motherboard Settings
- Install Memory Modules
- Install the Central Processing Unit (CPU)
- Install Expansion Cards
- Connect Ribbon Cables, Panel Wires, and Power Supply

## 3.4 Motherboard Settings

**WARNING!** Computer motherboards and expansion cards contain very delicate Integrated Circuit (IC) chips. To protect them against damage from static electricity, you should follow some precautions whenever you work on your computer.

1. Unplug your computer when working on the inside.
2. Use a grounded wrist strap before handling computer components. If you do not have one, touch both of your hands to a safely grounded object or to a metal object, such as the power supply case.
3. Hold components by the edges and try not to touch the IC chips, leads or connectors, or other components.
4. Place components on a grounded antistatic pad or on the bag that came with the component whenever the components are separated from the system.
5. Ensure that the ATX power supply is switched off before you plug in or remove the ATX power connector on the motherboard.

**WARNING!** Make sure that you unplug your power supply when adding or removing system components. Failure to do so may cause severe damage to your motherboard, peripherals, and/or components. The onboard LED when lit acts as a reminder that the system is in suspend or soft-off mode and not powered OFF.

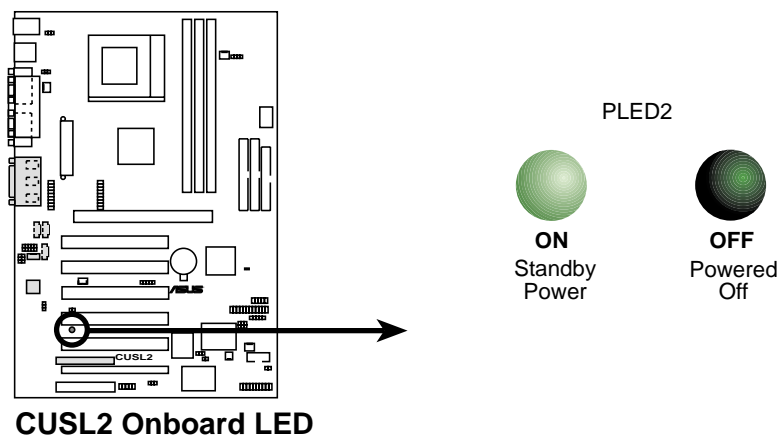

# 3. HARDWARE SETUP

## Motherboard Feature Settings

The motherboard's onboard functions are either adjusted through jumpers or DIP switches. When using DIP switches, the white block represents the switch's position. The example below shows all the switches in the OFF position.

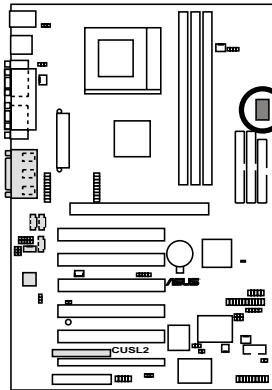

CUSL2 DIP Switches

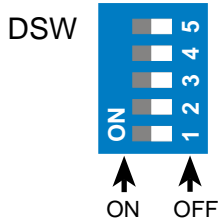

1. Frequency Selection
2. Frequency Selection
3. Frequency Selection
4. Frequency Selection
5. Frequency Selection.

### 1) JumperFree™ Mode (JEN)

This jumper allows you to enable or disable the JumperFree™ mode. The JumperFree™ mode allows processor settings to be made through the BIOS setup (see *4.4 Advanced Menu*).

**NOTE:** In JumperFree™ mode, all dip switches must be set to OFF.

<u>Setting</u>	<u>JEN</u>
Disable (Jumper)	[1-2]
Enable (JumperFree)	[2-3] (default)

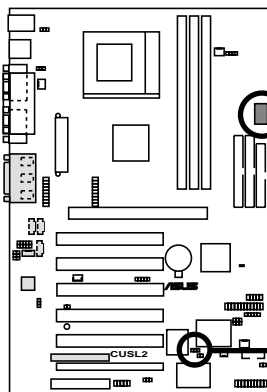

CUSL2 JumperFree™ Mode Setting

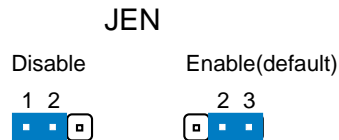
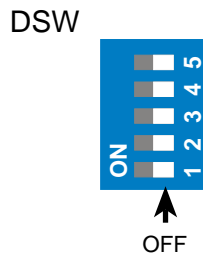

# 3. HARDWARE SETUP

- 2) **USB Device Wake Up (USBPWR01,USBPWR2, USBPWR47, USBPWR56)**  
These allow you to disable or enable the USB device wake up function. Set these jumpers to *Enable* if you wish to use your USB devices to wake up your computer. This feature requires an ATX power supply that can supply at least 2A on the +5VSB lead. The default is set to *Disable* because not all computers have the appropriate ATX power supply. Your computer will not power ON if you set this to *Enable* and do not have the appropriate ATX power supply. **NOTE:** This jumper must be set in conjunction with **Wake On USB for STR State** in **4.5.1 Power Up Control**.

### NOTES

1. For suspend to RAM function, these jumpers must be set to *Enable*.
2. The total current consumed must NOT exceed the power supply capability (+5VSB) whether under normal working conditions or in the sleep mode.

<u>Setting</u>	<u>USBPWR01, USBPWR2, USBPWR47, USBPWR56</u>
Disable	[1-2] (default)
Enable	[2-3]

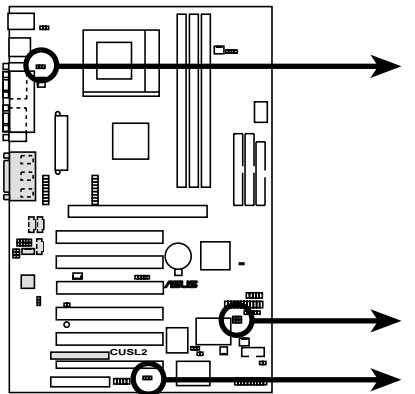

CUSL2 USB Device Wake Up

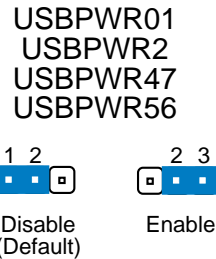

# 3. HARDWARE SETUP

## 3) Onboard Audio CODEC Setting (ADN#)

(available on audio model only)

The onboard audio CODEC may be enabled or disabled using all of these jumpers. Disable the onboard audio CODEC if you are using an ISA or PCI audio card on any of the expansion slots or a primary audio/modem CNR on a CNR slot (see CNR Slot later in this section). If using a PCI audio expansion card, **Onboard AC97 Audio Controller** in *4.4.2 I/O Device Configuration* must also be disabled.

<u>Setting</u>	<u>ADN#</u>
Enable	[1-2] (default)
Disable	[2-3]

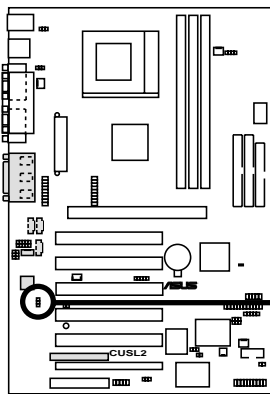

CUSL2 Audio Codec Setting

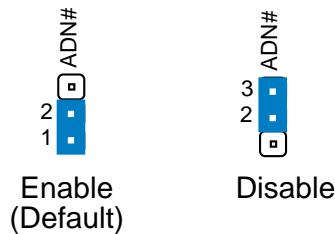

## 4) Keyboard Power Up (KBPWR)

This allows you to disable or enable the keyboard power up function. Set this jumper to *Enable* if you wish to use your keyboard (by pressing <Spacebar>) to power up your computer. This feature requires an ATX power supply that can supply at least 300mA on the +5VSB lead. The default is set to *Disable* because not all computers have the appropriate ATX power supply. Your computer will not power ON if you set this to *Enable* but do not have the appropriate ATX power supply. **NOTE:** This jumper must be set in conjunction with **Wake On PS2 KB/PS2 Mouse/CIR** in *4.5.1 Power Up Control*.

<u>Setting</u>	<u>KBPWR</u>
Enable	[1-2] (default)
Disable	[2-3]

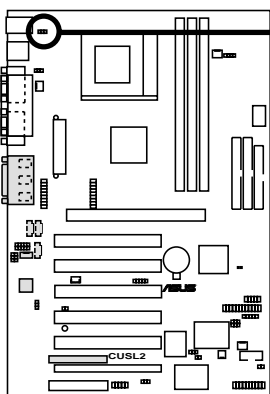

CUSL2 Keyboard Power Setting

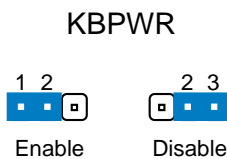

# 3. HARDWARE SETUP

## 5) Voltage I/O Setting (VIO)

This jumper allows you to select the voltage supplied to the DRAM, chipset, AGP, and PCI. The default setting of 3.40V should be used unless processor overclocking requires a higher voltage.

<u>Setting</u>	<u>VIO</u>
3.30 V	[1-2]
3.40 V	[2-3] (default)
3.60 V	[3-4]

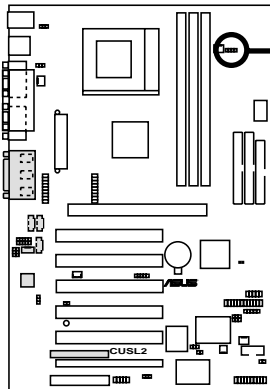

CUSL2 VIO Setting

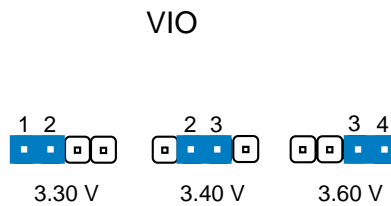

**WARNING!** Using a higher voltage may help when overclocking but may result in the shortening of your computer component's life. It is highly recommended that you leave this setting on its default.

# 3. HARDWARE SETUP

## 6) CPU External Frequency Setting (DSW)

This option tells the clock generator what frequency to send to the CPU, DRAM, AGP, and the PCI bus. This allows the selection of the CPU's *External* frequency.

### IMPORTANT:

1. In JumperFree mode, all dip switches must be set to OFF.
2. When JumperFree mode is enabled, use BIOS setup in place of these switches (see **CPU Speed** in *Advanced Menu* in BIOS Setup).

**NOTE:** Only selected switches are illustrated. For a complete frequency listing, see next page.

DSW

CPU	66.8MHz	100.3MHz	103.0MHz	133.70MHz
DRAM	100.2MHz	100.3MHz	103.0MHz	100.30MHz
AGP	66.8MHz	66.8MHz	68.7MHz	66.85MHz

CPU	140MHz	133.70MHz	140MHz	(JumperFree Mode)
DRAM	105MHz	133.70MHz	140MHz	
AGP	70MHz	66.85MHz	70MHz	

**CUSL2 CPU External Clock (BUS) Frequency Selection**

**NOTE:** If your processor does not have a locked Frequency Multiple, you must use **CPU Core:Bus Freq. Multiple** in *4.4 Advanced Menu* to set the Frequency Multiple. If the Frequency Multiple is locked, setting the Frequency Multiple in BIOS setup will have no effect.

# 3. HARDWARE SETUP

## External Frequency Table

The following table is for use by experienced motherboard installers only. Overclocking can result in system instability or even shortening the life of the processor.

CPU:DRAM Ratio	CPU (MHz)	SDRAM (MHz)	Frequency Selection Switches				
			1	2	3	4	5
66:100	64.4	99.6	[ON]	[ON]	[ON]	[ON]	[ON]
66:100	60.0	90.0	[ON]	[ON]	[ON]	[ON]	[OFF]
<b>66:100</b>	<b>66.0</b>	<b>100.0</b>	<b>[ON]</b>	<b>[ON]</b>	<b>[ON]</b>	<b>[OFF]</b>	<b>[ON]</b>
66:100	68.3	102.5	[ON]	[ON]	[ON]	[OFF]	[OFF]
66:100	70.0	105.0	[ON]	[ON]	[OFF]	[ON]	[ON]
66:100	75.0	112.5	[ON]	[ON]	[OFF]	[ON]	[OFF]
66:100	80.0	120.0	[ON]	[ON]	[OFF]	[OFF]	[ON]
66:100	83.0	124.5	[ON]	[ON]	[OFF]	[OFF]	[OFF]
100:100	99.6	99.6	[ON]	[OFF]	[ON]	[ON]	[ON]
100:100	90.0	90.0	[ON]	[OFF]	[ON]	[ON]	[OFF]
<b>100:100</b>	<b>100.0</b>	<b>100.0</b>	<b>[ON]</b>	<b>[OFF]</b>	<b>[ON]</b>	<b>[OFF]</b>	<b>[ON]</b>
<b>100:100</b>	<b>103.0</b>	<b>103.0</b>	<b>[ON]</b>	<b>[OFF]</b>	<b>[ON]</b>	<b>[OFF]</b>	<b>[OFF]</b>
100:100	105.0	105.0	[ON]	[OFF]	[OFF]	[ON]	[ON]
100:100	110.0	110.0	[ON]	[OFF]	[OFF]	[ON]	[OFF]
100:100	115.0	115.0	[ON]	[OFF]	[OFF]	[OFF]	[ON]
100:100	200.0	200.0	[ON]	[OFF]	[OFF]	[OFF]	[OFF]
133:133	132.8	132.8	[OFF]	[ON]	[ON]	[ON]	[ON]
133:133	166.6	166.6	[OFF]	[ON]	[ON]	[ON]	[OFF]
<b>133:133</b>	<b>133.0</b>	<b>133.0</b>	<b>[OFF]</b>	<b>[ON]</b>	<b>[ON]</b>	<b>[OFF]</b>	<b>[ON]</b>
133:133	137.0	137.0	[OFF]	[ON]	[ON]	[OFF]	[OFF]
<b>133:133</b>	<b>140.0</b>	<b>140.0</b>	<b>[OFF]</b>	<b>[ON]</b>	<b>[OFF]</b>	<b>[ON]</b>	<b>[ON]</b>
133:133	145.0	145.0	[OFF]	[ON]	[OFF]	[ON]	[OFF]
133:133	150.0	150.0	[OFF]	[ON]	[OFF]	[OFF]	[ON]
133:133	160.0	160.0	[OFF]	[ON]	[OFF]	[OFF]	[OFF]
133:100	132.8	99.6	[OFF]	[OFF]	[ON]	[ON]	[ON]
133:100	166.6	125.0	[OFF]	[OFF]	[ON]	[ON]	[OFF]
<b>133:100</b>	<b>133.0</b>	<b>100.0</b>	<b>[OFF]</b>	<b>[OFF]</b>	<b>[ON]</b>	<b>[OFF]</b>	<b>[ON]</b>
133:100	137.0	102.8	[OFF]	[OFF]	[ON]	[OFF]	[OFF]
<b>133:100</b>	<b>140.0</b>	<b>105.0</b>	<b>[OFF]</b>	<b>[OFF]</b>	<b>[OFF]</b>	<b>[ON]</b>	<b>[ON]</b>
133:100	145.0	108.8	[OFF]	[OFF]	[OFF]	[ON]	[OFF]
133:100	150.0	112.5	[OFF]	[OFF]	[OFF]	[OFF]	[ON]
133:100	160.0	120.0	[OFF]	[OFF]	[OFF]	[OFF]	[OFF]

For updated processor settings, visit ASUS's web site (see ASUS CONTACT INFORMATION)

# 3. HARDWARE SETUP

## 3.5 System Memory (DIMM)

**NOTE:** No hardware or BIOS setup is required after adding or removing memory.

This motherboard uses only Dual Inline Memory Modules (DIMMs). Sockets are available for **3.3Volt** (power level) unbuffered Synchronous Dynamic Random Access Memory (SDRAM). One side (with memory chips) of the DIMM takes up one row on the motherboard.

Memory speed setup is recommended through **SDRAM Configuration** in *4.4.1 Chip Configuration*.

*Install memory in any combination as follows:*

DIMM Location	168-pin DIMM		Total Memory
Socket 1 (Rows 0&1)	SDRAM 8, 16, 32, 64, 128, 256, 512MB	x1	
Socket 2 (Rows 2&3)	SDRAM 8, 16, 32, 64, 128, 256, 512MB	x1	
Socket 3 (Rows 4&5)	SDRAM 8, 16, 32, 64, 128, 256, 512MB	x1	
<b>Total System Memory (Max 512MB)</b>		=	

**NOTE:** Make sure the total installed memory does not exceeds 512MB. Otherwise, the system may hang during startup.

### 3.5.1 General DIMM Notes

- **For the system CPU bus to operate at 133MHz, use only PC133-compliant DIMMs.** When this motherboard operates at 133MHz, most system will not even boot if non-compliant modules are used because of the strict timing issues involved under this speed. If your DIMMs are not PC133-compliant, set the CPU bus frequency to 100MHz RAM to ensure system stability.
- ASUS motherboards support SPD (Serial Presence Detect) DIMMs. This is the memory of choice for best performance vs. stability.
- BIOS shows SDRAM memory on bootup screen.
- Single-sided DIMMs come in 16, 32, 64,128, 256MB; double-sided come in 32, 64, 128, 256, 512MB.



# 3. HARDWARE SETUP

## 3.5.2 Memory Installation

**WARNING!** Make sure that you unplug your power supply when adding or removing memory modules or other system components. Failure to do so may cause severe damage to both your motherboard and expansion cards (see 3.3 *Hardware Setup Procedure* for more information).

Insert the module(s) as shown. Because the number of pins are different on either side of the breaks, the module will only fit in the orientation shown. DRAM SIMM modules have the same pin contacts on both sides. SDRAM DIMMs have different pin contacts on each side and therefore have a higher pin density.

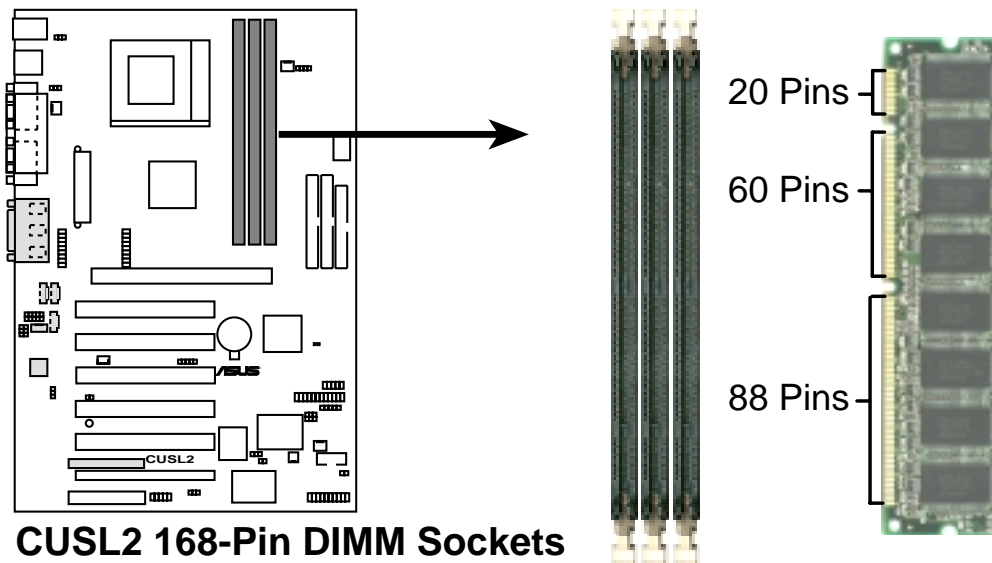

**CUSL2 168-Pin DIMM Sockets**

The DIMMs must be 3.3Volt unbuffered SDRAMs. To determine the DIMM type, check the notches on the DIMMs (see figure below).

**168-Pin DIMM Notch Key Definitions (3.3V)**

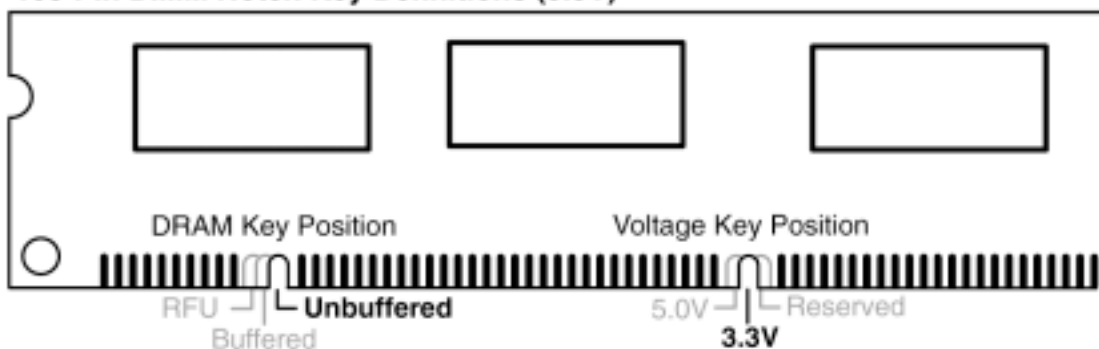

The notches on the DIMM will shift between left, center, or right to identify the type and also to prevent the wrong type from being inserted into the DIMM slot on the motherboard. You must tell your retailer the correct DIMM type before purchasing. This motherboard supports four clock signals per DIMM.

# 3. HARDWARE SETUP

## 3.6 Central Processing Unit (CPU)

The motherboard provides a ZIF Socket 370. The CPU that came with the motherboard should have a fan attached to it to prevent overheating. If this is not the case, then purchase a fan before you turn on your system.

**WARNING!** Be sure that there is sufficient air circulation across the processor's heatsink by regularly checking that your CPU fan is working. Without sufficient circulation, the processor could overheat and damage both the processor and the motherboard. You may install an auxiliary fan, if necessary.

To install a CPU, first turn off your system and remove its cover. Locate the ZIF socket and open it by first pulling the lever sideways away from the socket then upwards to a 90-degree angle. Insert the CPU with the correct orientation as shown. The notched corner should point towards the end of the lever. Because the CPU has a corner pin for two of the four corners, the CPU will only fit in the orientation as shown. The picture is for reference only; you should have a CPU fan that covers the face of the CPU. With the added weight of the CPU fan, no force is required to insert the CPU. Once completely inserted, close the socket's lever while holding down the CPU. After the CPU is installed, install an Intel recommended fan heatsink. Locate the CPU fan connector (see *3.1 Motherboard Layout* or *3.8 Connectors*) and connect the CPU fan cable to it.

**NOTE:** Do not forget to set the correct Bus Frequency and Multiple (frequency multiple setting is available only on unlocked processors) for your Socket 370 processor or else boot-up may not be possible. Socket 370 processors provide internal thermal sensing so that a socket mounted thermal resistor is not needed.

**CAUTION!** Be careful not to scrape the motherboard when mounting a clamp-style processor fan or else damage may occur to the motherboard.

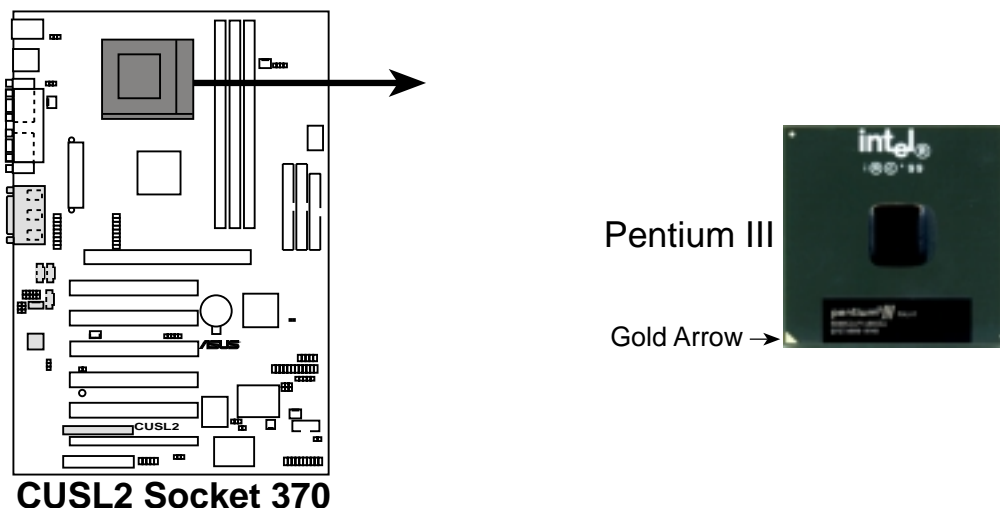

# 3. HARDWARE SETUP

## 3.7 Expansion Cards

**WARNING!** Unplug your power supply when adding or removing expansion cards or other system components. Failure to do so may cause severe damage to both your motherboard and expansion cards (see **3.3 Hardware Setup Procedure** for more information).

### 3.7.1 Expansion Card Installation Procedure

1. Read the documentation for your expansion card and make any necessary hardware or software settings for your expansion card, such as jumpers.
2. Remove your computer system's cover and the bracket plate on the slot you intend to use. Keep the bracket for possible future use.
3. Carefully align the card's connectors and press firmly.
4. Secure the card on the slot with the screw you removed above.
5. Replace the computer system's cover.
6. Set up the BIOS if necessary  
(such as *IRQ xx Used By ISA: Yes* in PNP AND PCI SETUP)
7. Install the necessary software drivers for your expansion card.

### 3.7.2 Assigning IRQs for Expansion Cards

Some expansion cards need an IRQ to operate. Generally, an IRQ must be exclusively assigned to one use. In a standard design, there are 16 IRQs available but most of them are already in use, leaving 6 IRQs free for expansion cards. If your motherboard has **PCI** audio onboard, an additional IRQ will be used. If your motherboard also has **MIDI** enabled, another IRQ will be used, leaving 4 IRQs free.

#### *Standard Interrupt Assignments*

IRQ	Priority	Standard Function
0	1	System Timer
1	2	Keyboard Controller
2	N/A	Programmable Interrupt
3*	11	Communications Port (COM2)
4*	12	Communications Port (COM1)
5*	13	Sound Card (sometimes LPT2)
6	14	Floppy Disk Controller
7*	15	Printer Port (LPT1)
8	3	System CMOS/Real Time Clock
9*	4	ACPI Mode when enabled
10*	5	IRQ Holder for PCI Steering
11*	6	IRQ Holder for PCI Steering
12*	7	PS/2 Compatible Mouse Port
13	8	Numeric Data Processor
14*	9	Primary IDE Channel
15*	10	Secondary IDE Channel

\*These IRQs are usually available for ISA or PCI devices.

# 3. HARDWARE SETUP

## Interrupt Request Table for this Motherboard

Interrupt requests are shared as shown by the following table:

	A	B	C	D	E	F	G	H
PCI slot 1	—	—	—	—	—	shared	—	—
PCI slot 2	—	—	—	—	—	—	not shared	—
PCI slot 3	—	—	—	—	—	—	—	shared
PCI slot 4	—	—	—	—	shared	—	—	—
PCI slot 5	—	—	—	—	—	shared	—	—
PCI slot 6	—	—	shared	—	—	—	—	—
Onboard VGA	shared	—	—	—	—	—	—	—
Onboard USB controller HC0	—	—	—	not shared	—	—	—	—
Onboard USB controller HC1	—	—	—	—	—	—	—	shared
AGP Pro	shared	—	—	—	—	—	—	—
CNR LAN	—	—	—	—	shared	—	—	—
CNR Audio/Modem	—	not shared	—	—	—	—	—	—

**IMPORTANT:** If using PCI cards on shared slots, make sure that the drivers support “Share IRQ” or that the cards do not need IRQ assignments. Conflicts will arise between the two PCI groups that will make the system unstable or cards inoperable.

### 3.7.3 Communication and Networking Riser (CNR) Slots

These connectors support specially designed network, audio, or modem riser cards. Main processing is done through software and controlled by the motherboard’s system chipset. This provides upgradeable network, audio, and/or modem solutions at an incredibly low cost.

**NOTE:** CNRs are not included with this motherboard.

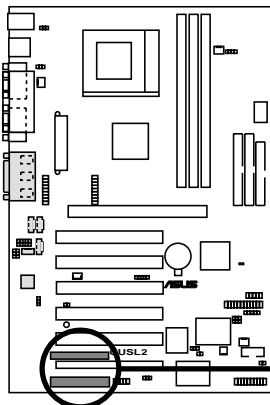

**CUSL2 Communication & Networking Riser Connectors**

#### CNR Restrictions:

1. Only one audio CNR can be used, and it must be primary and inserted into CNR slot 1.
2. If both an audio CNR and modem CNR are used, the modem CNR must be secondary.
3. The modem CNR must be primary if no audio CNR is used.
4. Only one LAN CNR can be supported.
5. When a USB hub CNR card is used, USB ports 5 and 6 will not function.

# 3. HARDWARE SETUP

## 3.7.4 Accelerated Graphics Port (AGP) Pro Slot

This motherboard provides an accelerated graphics port (AGP) pro slot to support a new generation of AGP graphics cards with ultra-high memory bandwidth. This slot can also support an **AGP Inline Memory Module (AIMM)** for up to 4MB of 133MHz SDRAM display cache to work with the integrated graphics controller to deliver high quality video graphics.

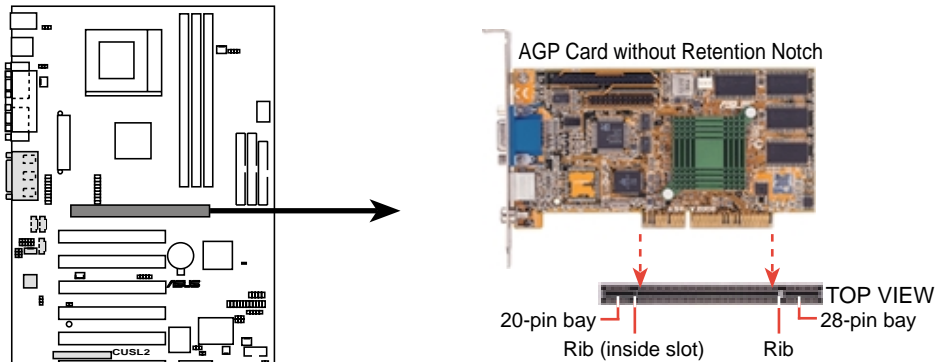

**CUSL2 Accelerated Graphics Port (AGP PRO)**

**NOTE:** Disable the integrated graphics controller (see **Onboard VGA** in **4.4.1 Chip Configuration**) when using an add-on graphics card.

**CAUTION!** The AGP Pro slot is shipped with a warning label over the 20-pin bay. **DO NOT** remove this label and the safety tab underneath it if you will be using an AGP card *without* a retention notch. Removing may cause the card to shift and may cause damage to your card, slot, and motherboard. Remove **ONLY** when you will be using an **AGP Pro** card. Use a rigid tip, such as a pen tip, to dislodge and remove the tab from the bay.

Removing the tab

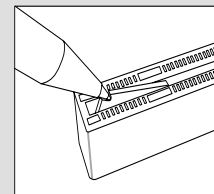

# 3. HARDWARE SETUP

## 3.8 External Connectors

**WARNING!** Some pins are used for connectors or power sources. These are clearly distinguished from jumpers in the Motherboard Layout. Placing jumper caps over these connector pins will cause damage to your motherboard.

**IMPORTANT:** Ribbon cables should always be connected with the red stripe to Pin 1 on the connectors. Pin 1 is usually on the side closest to the power connector on hard drives and CD-ROM drives, but may be on the opposite side on floppy disk drives. Check the connectors before installation because there may be exceptions. IDE ribbon cable must be less than 46 cm (18 in.), with the second drive connector no more than 15 cm (6 in.) from the first connector.

### 1) PS/2 Mouse Connector (Green 6-pin PS2KBMS)

The system will direct IRQ12 to the PS/2 mouse if one is detected. If one is not detected, expansion cards can use IRQ12. See **PS/2 Mouse Function Control** in *4.4 Advanced Menu*.

PS/2 Mouse (6-pin female)

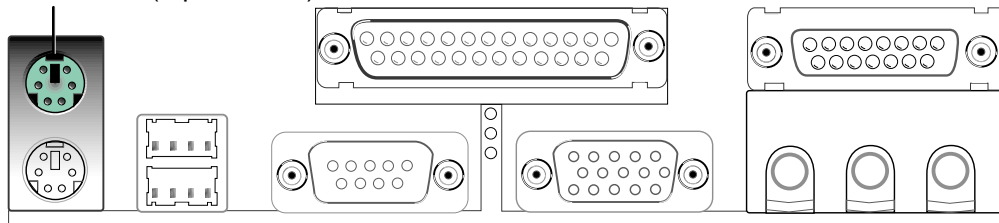

### 2) PS/2 Keyboard Connector (Purple 6-pin PS2KBMS)

This connection is for a standard keyboard using an PS/2 plug (mini DIN). **This connector will not allow standard AT size (large DIN) keyboard plugs. You may use a DIN to mini DIN adapter on standard AT keyboards.**

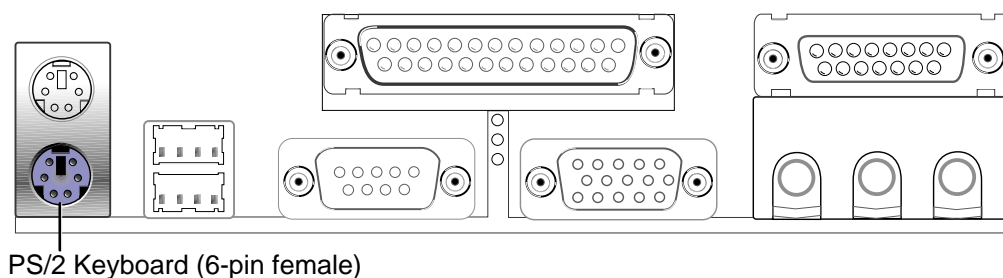

# 3. HARDWARE SETUP

## 3) Universal Serial BUS Ports 0 & 1 (Black two 4-pin USB)

Two USB ports are available for connecting USB devices. For additional USB ports, you can use the USB headers (see **USB Headers** later in this section) and mount it to the chassis.

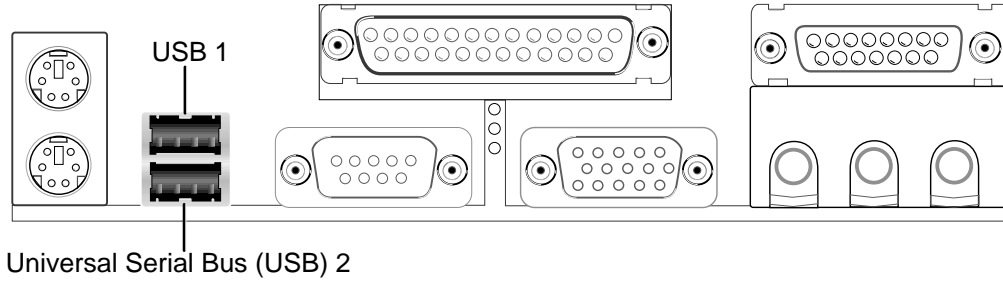

## 4) Parallel Port Connector (Burgundy 25-pin PRINTER)

You can enable the parallel port and choose the IRQ through **Onboard Parallel Port** (see **4.4.2 I/O Device Configuration**).

**NOTE:** Serial printers must be connected to the serial port.

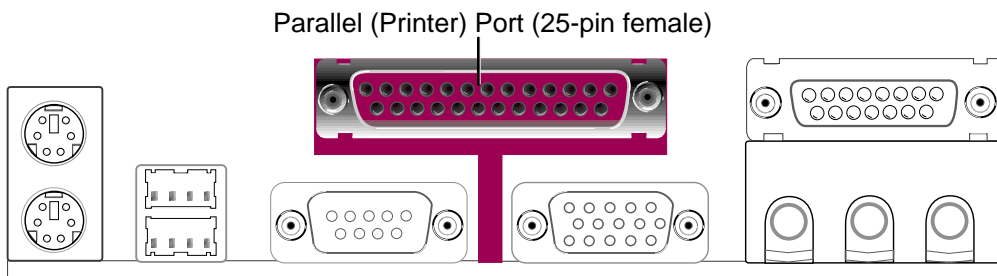

# 3. HARDWARE SETUP

## 5) Serial Port Connectors (Teal/Turquoise 9-pin COM1, 10-1 pin COM2)

One serial port is ready for a mouse or other serial devices. A second serial port is available using a serial port bracket connected from the motherboard to an expansion slot opening. See **Onboard Serial Port 1/2** in **4.4.2 I/O Device Configuration** for settings.

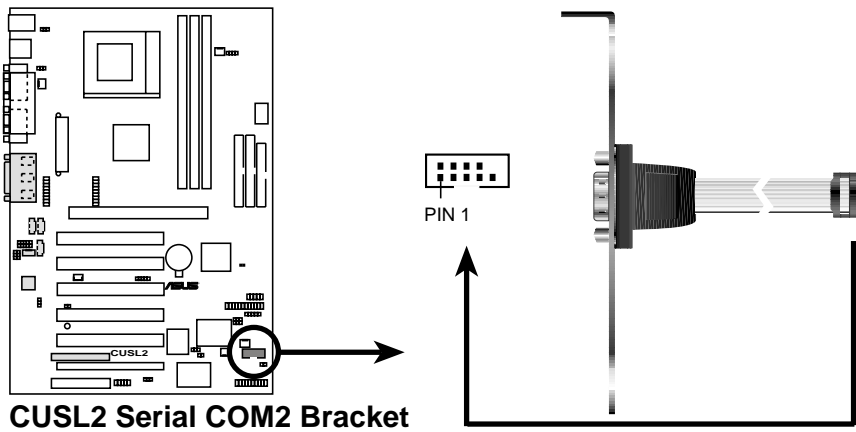
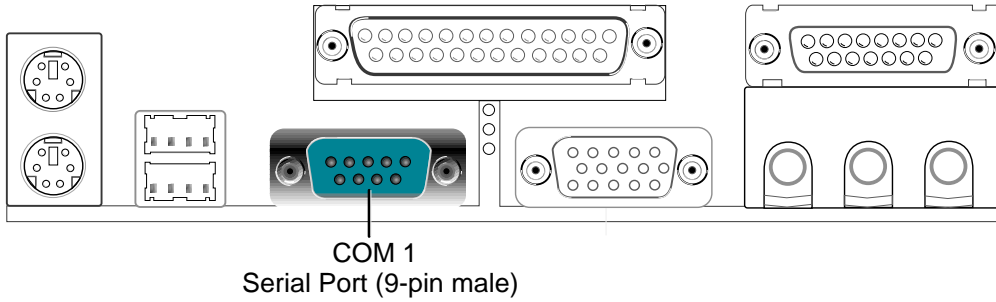

## 6) Monitor Output Connector (Blue 15-pin VGA)

This connector is for output to a VGA-compatible device.

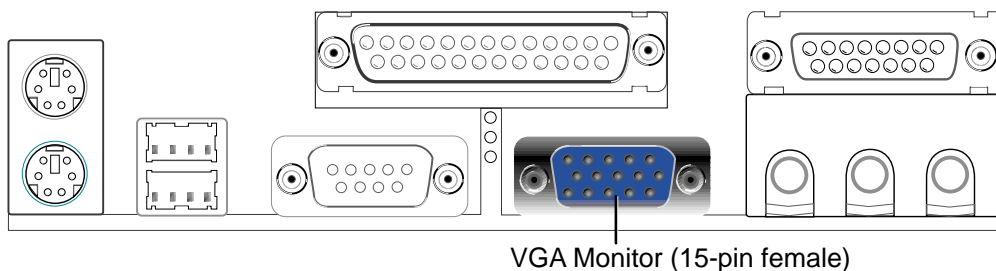



# 3. HARDWARE SETUP

## 7) Game/MIDI Connector (Gold 15-pin GAME\_AUDIO) (optional)

You may connect game joysticks or game pads to this connector for playing games. Connect MIDI devices for playing or editing professional audio.

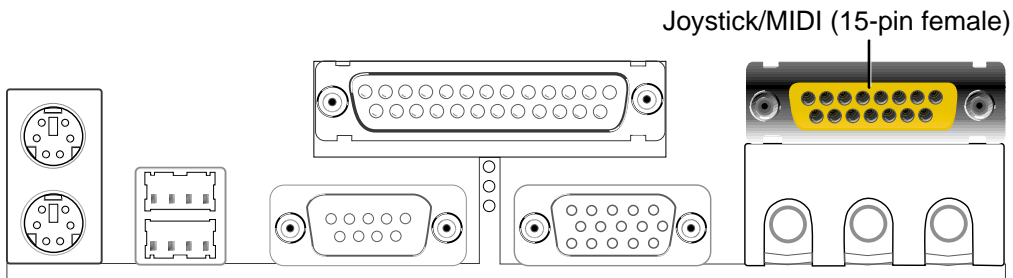

## 8) Audio Port Connectors (Three 1/8" GAME\_AUDIO) (optional)

**Line Out** (lime) can be connected to headphones or preferably powered speakers. **Line In** (light blue) allows tape players or other audio sources to be recorded by your computer or played through the **Line Out** (lime). **Mic** (pink) allows microphones to be connected for inputting voice.

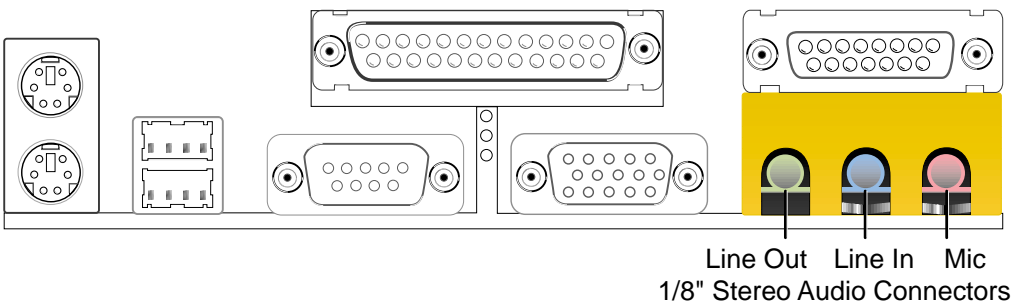

## 9) Floppy Disk Drive Connector (34-pin FLOPPY)

This connector supports the provided floppy drive ribbon cable. After connecting the single end to the board, connect the two plugs on the other end to the floppy drives. (**Pin 5 is removed to prevent inserting in the wrong orientation when using ribbon cables with pin 5 plugged**).

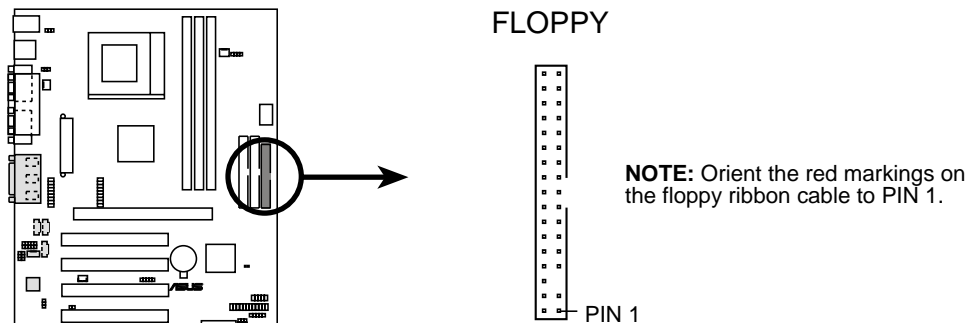

CUSL2 Floppy Disk Drive Connector

# 3. HARDWARE SETUP

## 10) Primary (Blue) / Secondary IDE Connectors (Two 40-pin IDE)

These connectors support the provided IDE hard disk ribbon cable. Connect the cable's blue connector to the motherboard's primary (recommended) or secondary IDE connector, and then connect the gray connector to your UltraDMA/100 slave device (hard disk drive) and the black connector to your UltraDMA/100 master device. It is recommended that non-UltraDMA/100 devices be connected to the secondary IDE connector. If you install two hard disks, you must configure the second drive to Slave mode by setting its jumper accordingly. Please refer to your hard disk documentation for the jumper settings. BIOS now supports specific device bootup (see **4.4.1 Advanced CMOS Setup**). **(Pin 20 is removed to prevent inserting in the wrong orientation when using ribbon cables with pin 20 plugged).**

**TIP:** You may configure two hard disks to be both Masters with two ribbon cables – one for the primary IDE connector and another for the secondary IDE connector. You may install one operating system on an IDE drive and another on a SCSI drive and select the boot disk through **4.4.1 Advanced CMOS Setup**.

**IMPORTANT:** UltraDMA/100 IDE devices must use a 40-pin 80-conductor IDE cable for 100MByte/sec transfer rates.

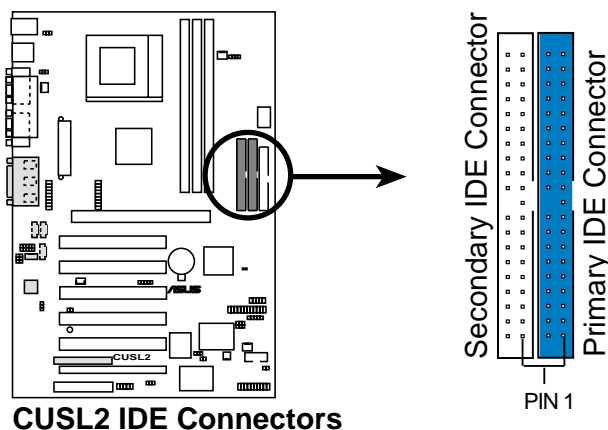

**NOTE:** Orient the red markings (usually zigzag) on the IDE ribbon cable to PIN 1.

# 3. HARDWARE SETUP

## 11) IDE Activity LED (2-pin IDELED)

This connector supplies power to the cabinet's IDE activity LED. Read and write activity by devices connected to the Primary or Secondary IDE connectors will cause the LED to light up.

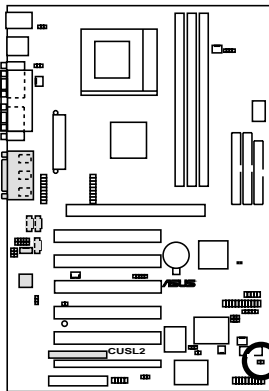

CUSL2 IDE Activity LED

**TIP:** If the case-mounted LED does not light, try reversing the 2-pin plug.

IDELED



## 12) Power Supply (PWR\_FAN), CPU (CPU\_FAN), Chassis (CHA\_FAN) Fan Connectors (3 pins)

These connectors support cooling fans of 350mA (4.2 Watts) or less. Orientate the fans so that the heat sink fins allow airflow to go across the onboard heat sink(s) instead of the expansion slots. Depending on the fan manufacturer, the wiring and plug may be different. The red wire should be positive, while the black should be ground. Connect the fan's plug to the board taking into consideration the polarity of the connector.

**NOTE:** The "Rotation" signal is to be used only by a specially designed fan with rotation signal. The Rotations per Minute (RPM) can be read directly from the ASUS iPanel or monitored using a utility such as ASUS PC Probe or Intel LDCM.

**WARNING!** The CPU and/or motherboard will overheat if there is no airflow across the CPU and onboard heatsinks. Damage may occur to the motherboard and/or the CPU fan if these pins are incorrectly used. **These are not jumpers, do not place jumper caps over these pins.**

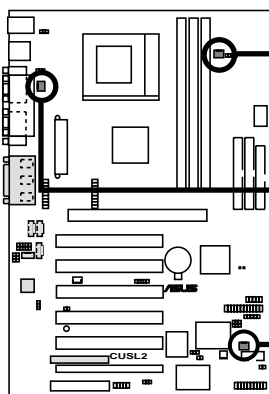

CUSL2 12-Volt Cooling Fan Power

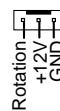

CPU\_FAN

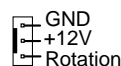

PWR\_FAN

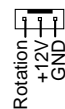

CHA\_FAN

# 3. HARDWARE SETUP

## 13) Internal Audio Connectors (4-pin CD1, AUX, VIDEO, MODEM)

These connectors allow you to receive stereo audio input from such sound sources as a CD-ROM, TV tuner, or MPEG card. The MODEM connector allows the onboard audio to interface with a voice modem card with a similar connector.

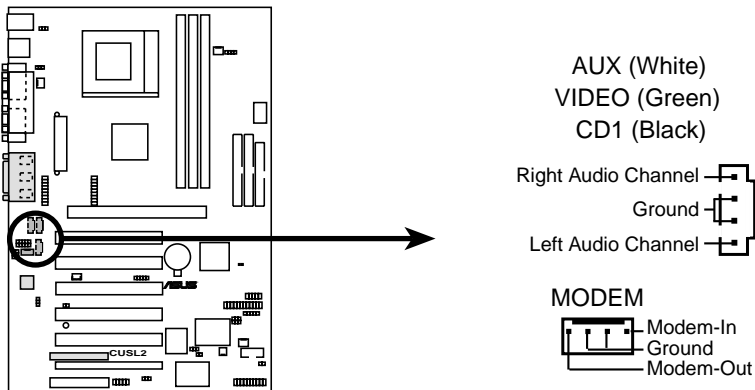

**CUSL2 Internal Audio Connectors**

## 14) Headphone True-Level Line Out Header (3-pin EARPHONE)

This connector allows you to connect chassis mounted headphone to the motherboard instead of having to attach an external headphone onto the ATX connectors.

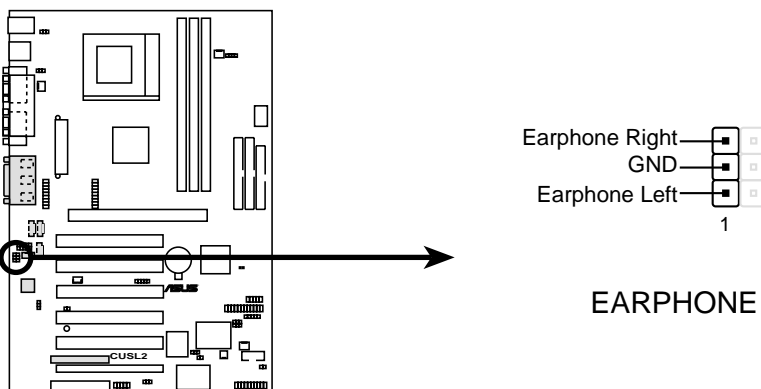

**CUSL2 True-Level Line Out Header**

## 15) Internal Microphone Connector (3-pin MIC2)

This connector allows you to connect chassis mounted microphone to the motherboard instead of having to attach an external microphone onto the ATX connectors.

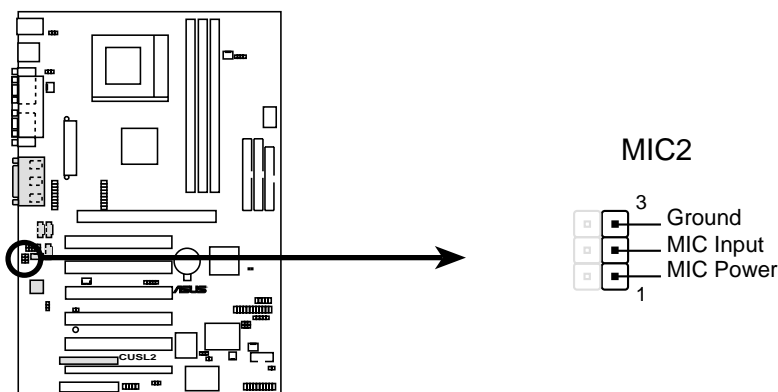

**CUSL2 Internal Microphone Connector**

# 3. HARDWARE SETUP

## 16) ASUS iPanel Connector (12-1 pin AFPANEL)

This connector allows you to connect an optional ASUS iPanel, an easy to access drive bay with front I/O ports, status LEDs, and space reserved for a hard disk drive. If you are not using an ASUS iPanel, you can connect an optional wireless transmitting and receiving infrared module to the SIR connector or an optional consumer infrared connector set to the CIR and SIR connectors for both wireless transmitting and remote control functions through one external infrared module.

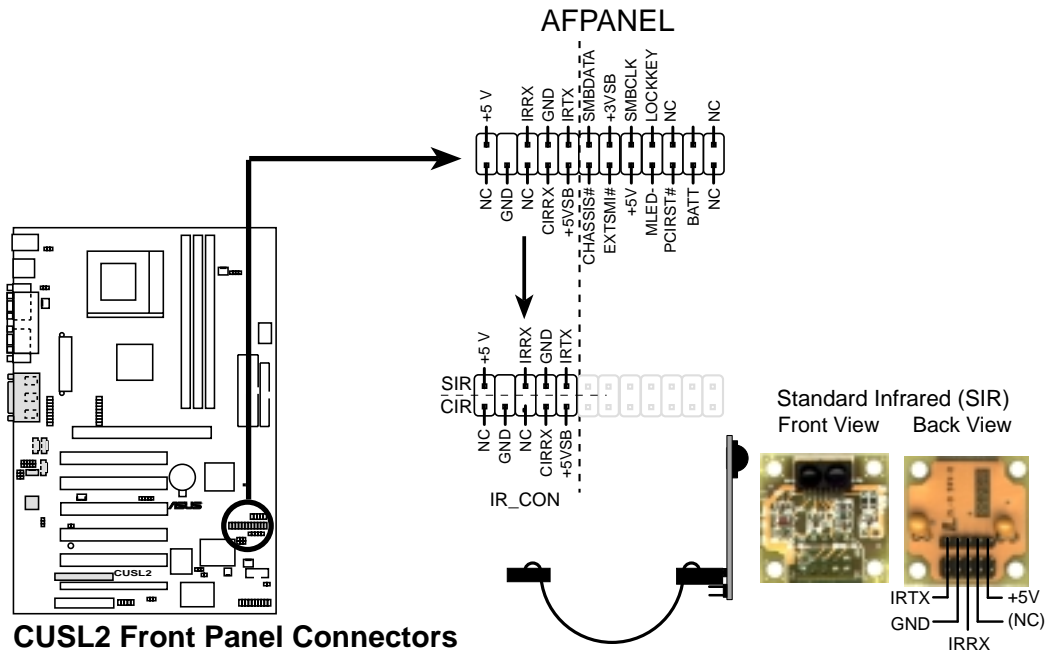

3. HW SETUP  
Connectors

## 17) ASUS iPanel Audio Connector (12-1 pin AAPANEL)

Connect the audio cable from the optional ASUS iPanel to this for front panel audio control.

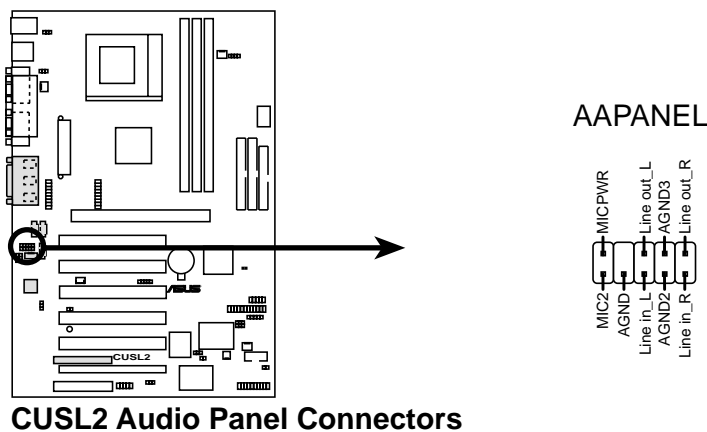

# 3. HARDWARE SETUP

## 18) SMB Connector (5-1 pin SMB)

This connector allows you to connect SMBus (System Management Bus) devices. SMBus devices communicate by means of the SMBus with an SMBus host and/or other SMBus devices. SMBus is a specific implementation of an I2C bus, which is a multi-device bus; that is, multiple chips can be connected to the same bus and each one can act as a master by initiating data transfer.

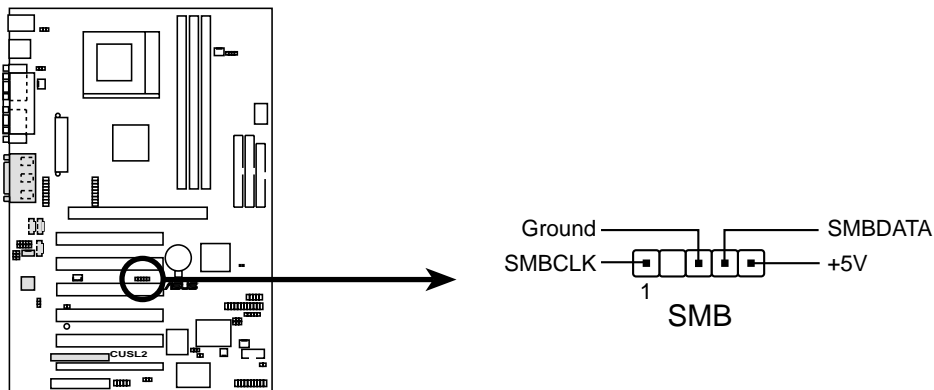

**CUSL2 SMBus Connector**

## 19) Chassis Intrusion Lead (2-pin ACHA)

This lead is for a chassis designed for chassis intrusion detection. After-market toggle switches may also be installed to the chassis panel or on any removable components. Two wires should be available from the chassis to connect to this lead. When any chassis component is removed, the contact should open and the motherboard will record a chassis intrusion event. The event can then be processed by software such as LDCM. If the chassis intrusion lead is not used, a jumper cap must be placed over the pins to close the circuit.

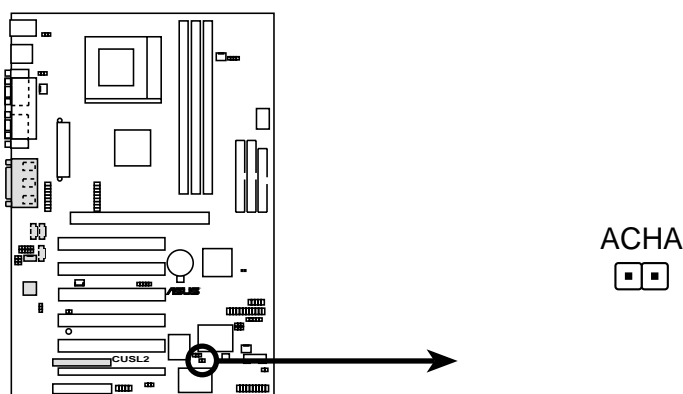

**CUSL2 Chassis Open Alarm Lead**

# 3. HARDWARE SETUP

## 20) Wake-On-LAN Connector (3-pin WOL\_CON)

This connector connects to a LAN card with a Wake-On-LAN output, such as the ASUS PCI-L101 Ethernet card (see 7. *Appendix*). The connector powers up the system when a wakeup packet or signal is received through the LAN card.

**IMPORTANT:** This feature requires that **Wake On LAN or PCI Modem** is enabled (see 4.5.1 *Power Up Control*) and that your system has an ATX power supply with at least 720mA +5V standby power.

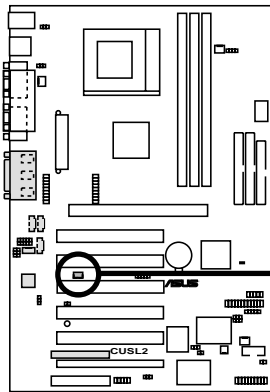

CUSL2 Wake-On-LAN Connector

**IMPORTANT:** Requires an ATX power supply with at least 720mA +5 volt standby power

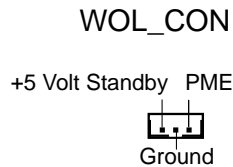

## 21) Wake-On-Ring Connector (2-pin WOR\_CON)

This connector connects to internal modem cards with a Wake-On-Ring output. The connector powers up the system when a ringup packet or signal is received through the internal modem card. **NOTE:** For external modems, Wake-On-Ring is detected through the COM port.

**IMPORTANT:** This feature requires that **Wake On LAN or PCI Modem** is enabled (see 4.5.1 *Power Up Control*) and that your system has an ATX power supply with at least 720mA +5V standby power.

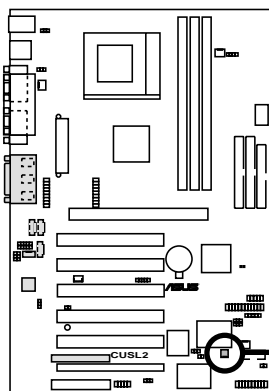

CUSL2 Wake-On-Ring Connector

WOR\_CON

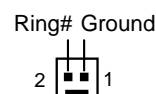

# 3. HARDWARE SETUP

## 22) LCD-TV Headers (18-pin, 18-1 pin LCDTV)

These headers require an optional LCD module for LCD output or a TV-out module for TV output.

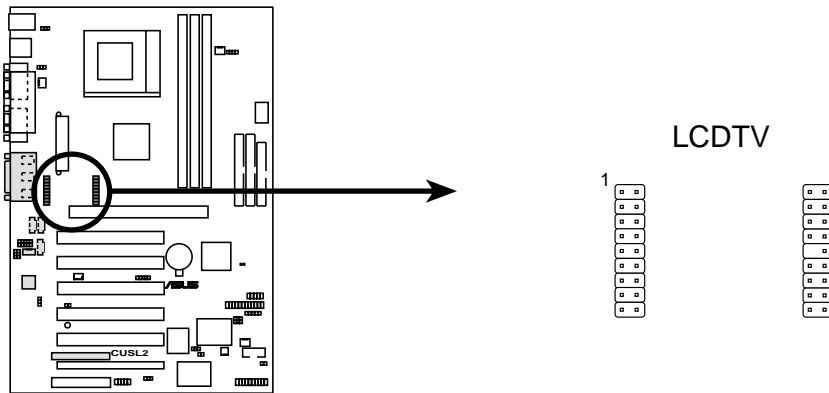

**CUSL2 LCD-TV Headers**

## 23) USB Headers (5-pin USB2, 10-1 pin USB47, 10-1 pin USB56)

If the USB Ports on the back panels are inadequate, three USB headers are available for five additional USB ports. Connect the 5-pin ribbon cable from the provided 3-port USB connector set to the midboard 5-pin USB header and the 10-1 pin ribbon cable to one of the two midboard 10-1 pin USB headers and mount the USB connector set to an open slot on your chassis.

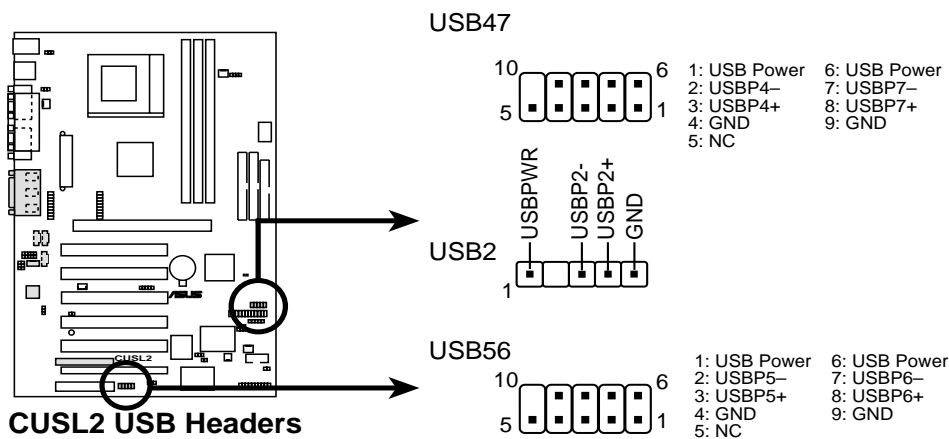

**CUSL2 USB Headers**



# 3. HARDWARE SETUP

## 24) ATX Power Supply Connector (20-pin block ATXPWR)

This connector connects to an ATX power supply. The plug from the power supply will only insert in one orientation because of the different hole sizes. Find the proper orientation and push down firmly making sure that the pins are aligned.

**IMPORTANT:** Make sure that your ATX power supply (minimum recommended wattage: 200 watts; 235W for a fully-configured system) can supply at least 20 amperes on the +5-volt lead and at least 10mA (750mA recommended) on the +5-volt standby lead (+5VSB). Your system may become unstable/unreliable and may experience difficulty in powering up if your power supply is inadequate. For Wake-On-LAN support, your ATX power supply must supply at least 750mA +5VSB.

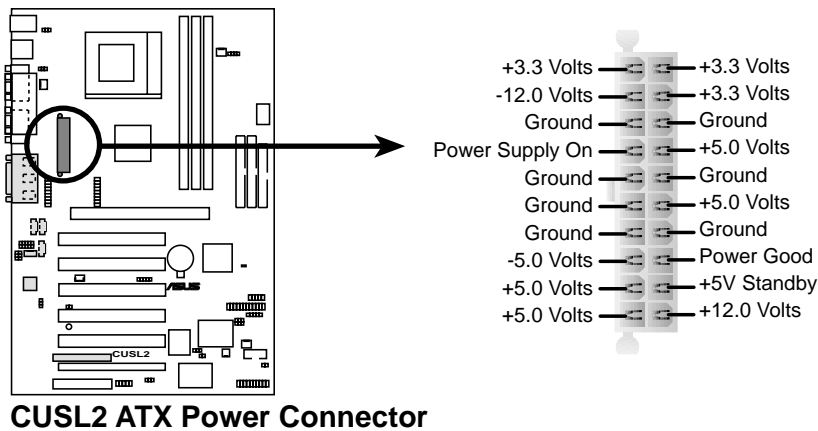

CUSL2 ATX Power Connector

## 25) Power Supply Thermal Sensor Connector (2-pin JTPWR)

If you have a power supply with thermal monitoring, connect its thermal sensor cable to this connector.

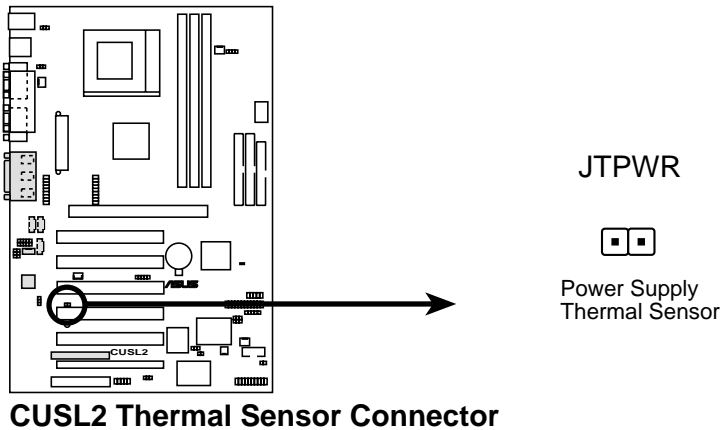

CUSL2 Thermal Sensor Connector

# 3. HARDWARE SETUP

The following is for items 26–32

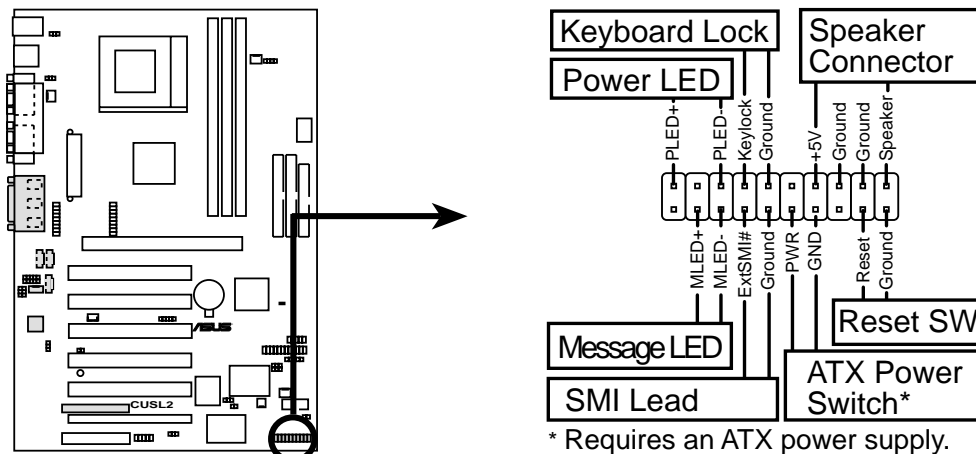

**CUSL2 System Panel Connectors**

## 26) System Power LED Lead (3-1 pin PWRLED)

This 3-1 pin connector connects the system power LED, which lights when the system is powered on and blinks when it is in sleep mode.

## 27) Keyboard Lock Switch Lead (2-pin KEYLOCK)

This 2-pin connector connects to the case-mounted key switch to allow keyboard locking.

## 28) System Warning Speaker Connector (4-pin SPEAKER)

This 4-pin connector connects to the case-mounted speaker. Two sources (LINE\_OUT and SPEAKER) will allow you to hear system beeps and warnings. Only SPEAKER will allow you to hear system beeps before the integrated audio has been properly initialized.

## 29) System Message LED Lead (2-pin MSG.LED)

This indicates whether a message has been received from a fax/modem. The LED will remain lit when there is no signal and blink when there is data received. This function requires an ACPI OS and driver support.

## 30) System Management Interrupt Lead (2-pin SMI)

This allows the user to manually place the system into a suspend mode or “Green” mode, where system activity is decreased to save electricity and expand the life of certain components when the system is not in use. This 2-pin connector connects to the case-mounted suspend switch.

## 31) ATX Power Switch Lead (2-pin PWRSW)

The system power is controlled by a momentary switch connected to this lead. Pressing the button once will switch the system between ON and SOFT OFF. Pushing the switch while in the ON mode for more than 4 seconds will turn the system off. The system power LED shows the status of the system’s power.

## 32) Reset Switch Lead (2-pin RESET)

This 2-pin connector connects to the case-mounted reset switch for rebooting your computer without having to turn off your power switch. This is a preferred method of rebooting to prolong the life of the system’s power supply.

# 3. HARDWARE SETUP

---

## 3.9 Starting Up the First Time

1. After all connections are made, close the system case cover.
2. Be sure that all switches are off (in some systems, marked with ○), and the power input voltage is set to comply with the standard used in your country (220V-240V or 110-120V).
3. Connect the power supply cord into the power supply located on the back of your system case according to your system user's manual.
4. Connect the power cord into a power outlet that is equipped with a surge protector.
5. You may then turn on your devices in the following order:
  - a. Your monitor
  - b. External SCSI devices (starting with the last device on the chain)
  - c. Your system power. For ATX power supplies, you need to switch on the power supply as well as press the ATX power switch on the front of the case.
6. The power LED on the front panel of the system case will light. For ATX power supplies, the system LED will light when the ATX power switch is pressed. The LED on the monitor may light up or switch between orange and green after the system's if it complies with "green" standards or if it has a power standby feature. The system will then run power-on tests. While the tests are running, the BIOS will alarm beeps or additional messages will appear on the screen. If you do not see anything within 30 seconds from the time you turn on the power, the system may have failed a power-on test. Recheck your jumper settings and connections or call your retailer for assistance.

### Award BIOS Beep Codes

Beep	Meaning
One short beep when displaying logo	No error during POST
Long beeps in an endless loop	No DRAM installed or detected
One long beep followed by three short beeps	Video card not found or video card memory bad
High frequency beeps when system is working	CPU overheated System running at a lower frequency

## 3. HARDWARE SETUP

---

7. During power-on, hold down <Delete> to enter BIOS setup. Follow the instructions in **4. BIOS SETUP**.

\* **Powering Off your computer:** You must first exit or shut down your operating system before switching off the power switch. For ATX power supplies, you can press the ATX power switch after exiting or shutting down your operating system. If you use Windows 9X, click the **Start** button, click **Shut Down**, and then click **Shut down the computer?** The power supply should turn off after Windows shuts down.

**NOTE:** The message “You can now safely turn off your computer” will not appear when shutting down with ATX power supplies.

# 4. BIOS SETUP

## 4.1 Managing and Updating Your BIOS

### 4.1.1 Upon First Use of the Computer System

It is recommended that you save a copy of the original motherboard BIOS along with a Flash Memory Writer utility (AFLASH.EXE) to a bootable floppy disk in case you need to reinstall the BIOS later. **AFLASH.EXE** is a Flash Memory Writer utility that updates the BIOS by uploading a new BIOS file to the programmable flash ROM on the motherboard. This file works only in DOS mode. To determine the BIOS version of your motherboard, check the last four numbers of the code displayed on the upper left-hand corner of your screen during bootup. Larger numbers represent a newer BIOS file.

1. Type **FORMAT A:/S** at the DOS prompt to create a bootable system floppy disk. **DO NOT** copy AUTOEXEC.BAT & CONFIG.SYS to the disk.
2. Type **COPY D:\AFLASH\AFLASH.EXE A:\** (assuming D is your CD-ROM drive) to copy AFLASH.EXE to the just created boot disk.

**NOTE:** AFLASH works only in DOS mode. It will not work with DOS prompt in Windows and will not work with certain memory drivers that may be loaded when you boot from your hard drive. It is recommended that you reboot using a floppy.

3. Reboot your computer from the floppy disk. **NOTE:** BIOS setup must specify “Floppy” as the first item in the boot sequence.
4. In DOS mode, type **A:\AFLASH <Enter>** to run AFLASH.

```
ASUS ACPI BIOS
FLASH MEMORY WRITER V1.24
Copyright (C) 1994-99, ASUSTek COMPUTER INC.

Flash Memory: Winbond W29C020 or SST 29EE020 or Intel I29020B

Current BIOS Version: ASUS XXX-XX ACPI BIOS Revision 100C
BIOS Model          : XXX-XX
BIOS Built Date     : 99/25/98

Choose one of the followings:

1. Save Current BIOS To File
2. Update BIOS Including Boot Block and ESCD

Enter choice: [1]

Press ESC To Exit
```

**IMPORTANT!** If “unknown” is displayed after **Flash Memory:**, the memory chip is either not programmable or is not supported by the ACPI BIOS and therefore, cannot be programmed by the Flash Memory Writer utility.

## 4. BIOS SETUP

5. Select **1. Save Current BIOS to File** from the Main menu and press <Enter>. The **Save Current BIOS To File** screen appears.

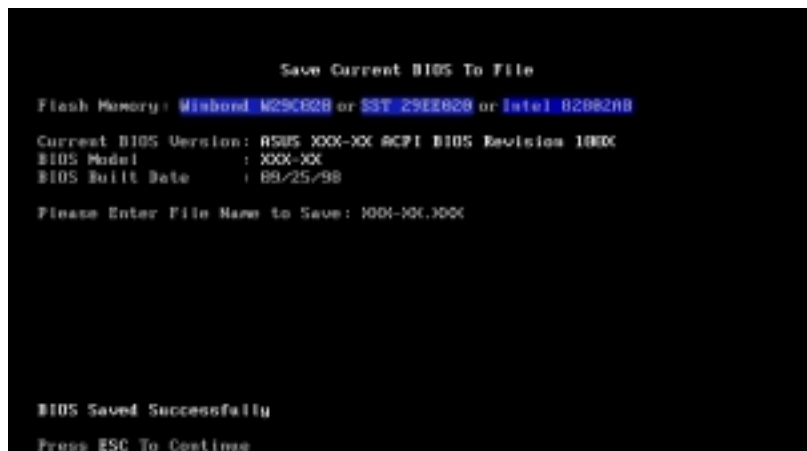

6. Type a filename and the path, for example, **A:\XXX-XX.XXX** and then press <Enter>.

### 4.1.2 Updating BIOS Procedures

**WARNING!** Only update your BIOS if you have problems with your motherboard and you know that the new BIOS revision will solve your problems. Careless updating can result in your motherboard having more problems!

1. Download an updated ASUS BIOS file from the Internet (WWW or FTP) (see **ASUS CONTACT INFORMATION** on page 3 for details) and save to the disk you created earlier.
2. Boot from the disk you created earlier.
3. At the “A:\” prompt, type **AFLASH** and then press <Enter>.
4. At the **Main Menu**, type **2** and then press <Enter>. The **Update BIOS Including Boot Block and ESCD** screen appears.
5. Type the filename of your new BIOS and the path, for example, **A:\XXX-XX.XXX**, and then press <Enter>.

**NOTE:** To cancel this operation, press <Enter>.



# 4. BIOS SETUP

- When prompted to confirm the BIOS update, press **Y** to start the update.

```
Update BIOS Including Boot Block and ESCD
Flash Memory: Winbond W25Q020 or SST 29EX000 or Intel B240240

BIOS Version
[Current] ASUS 1004-304 ACPI BIOS Revision 180K
[Last used] ASUS 1004-304 ACPI BIOS Revision 180K

BIOS Model
[Current] 3004-304
[Last used] 3004-304

Date of BIOS Built
[Current] 08/25/18
[Date] 08/25/18

Notice: Boot Block is different. Check sum of 1001.810 is F25E.
Are you sure (Y/N) Y [Y]

Press ESC To Return to Main Menu
```

- The utility starts to program the new BIOS information into the flash ROM. The boot block will be updated automatically only when necessary. This will minimize the chance that a failed update will prevent your system from booting up. When the programming is finished, *Flashed Successfully* will be displayed.

```
Update BIOS Including Boot Block and ESCD
Flash Memory: Winbond W25Q020 or SST 29EX000 or Intel B240240

BIOS Version
[Current] ASUS 1004-304 ACPI BIOS Revision 180K
[Last used] ASUS 1004-304 ACPI BIOS Revision 180K

BIOS Model
[Current] 3004-304
[Last used] 3004-304

Date of BIOS Built
[Current] 08/25/18
[Date] 08/25/18

Notice: Boot Block is different. Check sum of 1001.810 is F25E.
Are you sure (Y/N) Y [Y]
Block Erasing -- Done
Programming -- 3FFF
Flashed Successfully

Press ESC To Continue
```



**NOTE:** When you see the message “Boot Block is different”, you may still press <Y> to update the BIOS. Yet if the update fails, your system will run a greater risk of boot failure depending on whether the boot block is damaged or not.

## 4. BIOS SETUP

---

8. Follow the onscreen instructions to continue.

```
ASUS ACPI BIOS
FLASH MEMORY WRITER V1.20
Copyright (C) 1994-99, ASUSTeK COMPUTER INC.

Flash Memory: Winbond W25Q008 or SST 25E008 or Intel 0216208

Current BIOS Version: ASUS XXX-XX ACPI BIOS Revision 100X
BIOS Model          : XXX-XX
BIOS Build Date     : 05/23/99

Choose one of the followings:

1. Save Current BIOS To File
2. Update BIOS Including Boot Block and ESCD

Enter choice: 11

You have flashed the EPROM. It is recommended that you turn off
the power, enter SETUP and Load Setup Defaults to have CMOS
updated with new BIOS when exits.

Press ESC To Exit
```

**WARNING!** If you encounter problems while updating the new BIOS, DO NOT turn off your system since this might prevent your system from booting up. Just repeat the process, and if the problem still persists, update the original BIOS file you saved to disk above. If the Flash Memory Writer utility was not able to successfully update a complete BIOS file, your system may not be able to boot up. If this happens, your system will need servicing.



# 4. BIOS SETUP

---

## 4.2 BIOS Setup Program

This motherboard supports a programmable EEPROM that can be updated using the provided utility as described in *4.1 Managing and Updating Your BIOS*.

The utility is used if you are installing a motherboard, reconfiguring your system, or prompted to “**Run Setup**”. This section describes how to configure your system using this utility.

Even if you are not prompted to use the Setup program, at some time in the future you may want to change the configuration of your computer. For example, you may want to enable the Security Password Feature or make changes to the power management settings. It will then be necessary to reconfigure your system using the BIOS Setup program so that the computer can recognize these changes and record them in the CMOS RAM of the EEPROM.

The EEPROM on the motherboard stores the Setup utility. When you start up the computer, the system provides you with the opportunity to run this program. This appears during the Power-On Self Test (POST). Press <Delete> to call up the Setup utility. If you are a little bit late in pressing the mentioned key, POST will continue with its test routines, thus preventing you from calling up Setup. If you still need to call Setup, restart the system by pressing <Ctrl> + <Alt> + <Delete>, or by pressing the Reset button on the system chassis. You can also restart by turning the system off and then back on again. But do so only if the first two methods fail.

The Setup program has been designed to make it as easy to use as possible. It is a menu-driven program, which means you can scroll through the various sub-menus and make your selections among the predetermined choices.

**To access the BIOS Setup program, press the <Delete> key after the computer has run through its POST.**

**NOTE:** Because the BIOS software is constantly being updated, the following BIOS screens and descriptions are for reference purposes only and may not reflect your BIOS screens exactly.

# 4. BIOS SETUP

## 4.2.1 BIOS Menu Bar

The top of the screen has a menu bar with the following selections:

- MAIN** Use this menu to make changes to the basic system configuration.
- ADVANCED** Use this menu to enable and make changes to the advanced features.
- POWER** Use this menu to configure and enable Power Management features.
- BOOT** Use this menu to configure the default system device used to locate and load the Operating System.
- EXIT** Use this menu to exit the current menu or specify how to exit the Setup program.

To access the menu bar items, press the right or left arrow key on the keyboard until the desired item is highlighted.

## 4.2.2 Legend Bar

At the bottom of the Setup screen you will notice a legend bar. The keys in the legend bar allow you to navigate through the various setup menus. The following table lists the keys found in the legend bar with their corresponding alternates and functions.

<b>Navigation Key(s)</b>	<b>Function Description</b>
<F1> or <Alt + H>	Displays the General Help screen from anywhere in the BIOS Setup
<Esc>	Jumps to the Exit menu or returns to the main menu from a sub-menu
← or → (keypad arrow)	Selects the menu item to the left or right
↑ or ↓ (keypad arrow)	Moves the highlight up or down between fields
- (minus key)	Scrolls backward through the values for the highlighted field
+ (plus key) or spacebar	Scrolls forward through the values for the highlighted field
<Enter>	Brings up a selection menu for the highlighted field
<Home> or <PgUp>	Moves the cursor to the first field
<End> or <PgDn>	Moves the cursor to the last field
<F5>	Resets the current screen to its Setup Defaults
<F10>	Saves changes and exits Setup

# 4. BIOS SETUP

---

## General Help

In addition to the Item Specific Help window, the BIOS setup program also provides a General Help screen. This screen can be called up from any menu by simply pressing <F1> or the <Alt> + <H> combination. The General Help screen lists the legend keys with their corresponding alternates and functions.

## Saving Changes and Exiting the Setup Program

See *4.7 Exit Menu* for detailed information on saving changes and exiting the setup program.

## Scroll Bar

When a scroll bar appears to the right of a help window, it indicates that there is more information to be displayed that will not fit in the window. Use <PgUp> and <PgDn> or the up and down arrow keys to scroll through the entire help document. Press <Home> to display the first page, press <End> to go to the last page. To exit the help window, press <Enter> or <Esc>.

## Sub-Menu

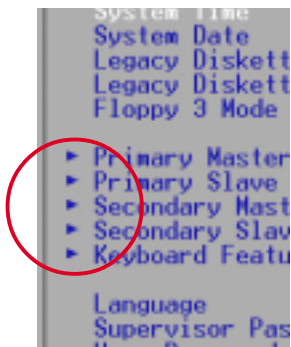

Note that a right pointer symbol (as shown in the left view) appears to the left of certain fields. This pointer indicates that a sub-menu can be launched from this field. A sub-menu contains additional options for a field parameter. To call up a sub-menu, simply move the highlight to the field and press <Enter>. The sub-menu will then immediately appear. Use the legend keys to enter values and move from field to field within a sub-menu just as you would within a menu. Use the <Esc> key to return to the main menu.

Take some time to familiarize yourself with each of the legend keys and their corresponding functions. Practice navigating through the various menus and sub-menus. If you accidentally make unwanted changes to any of the fields, use the set default hot key <F5>. While moving around through the Setup program, note that explanations appear in the Item Specific Help window located to the right of each menu. This window displays the help text for the currently highlighted field.

**NOTE:** The item heading in square brackets represents the default setting for that field.

# 4. BIOS SETUP

## 4.3 Main Menu

When the Setup program is accessed, the following screen appears:

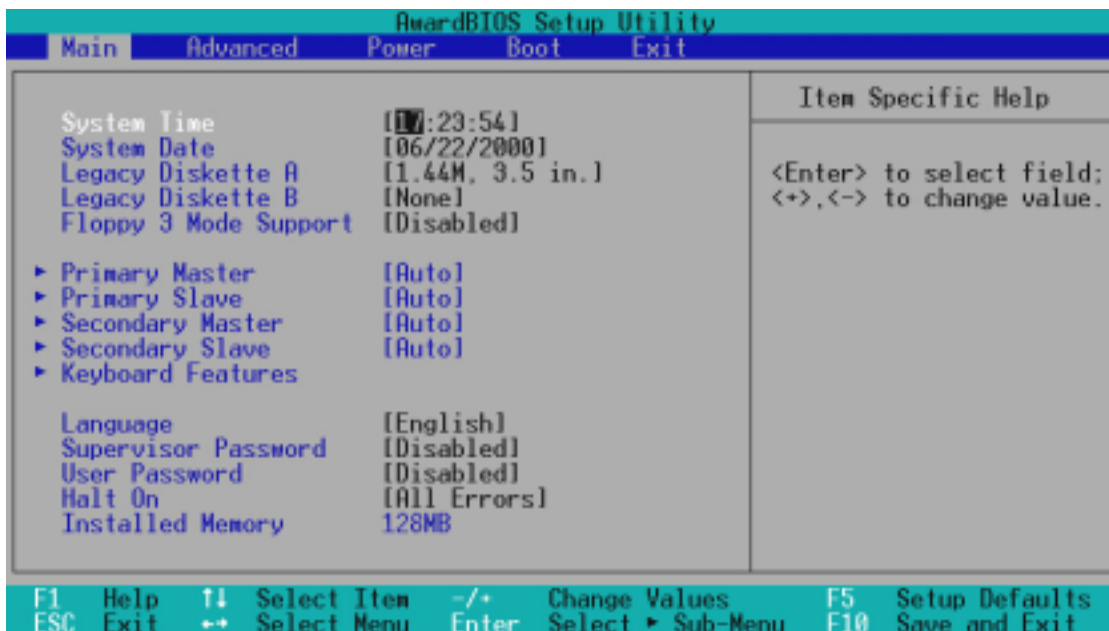

### System Time [XX:XX:XX]

Sets your system to the time that you specify (usually the current time). The format is hour, minute, second. Valid values for hour, minute and second are **Hour: (00 to 23)**, **Minute: (00 to 59)**, **Second: (00 to 59)**. Use the **<Tab>** or **<Shift> + <Tab>** keys to move between the hour, minute, and second fields.

### System Date [XX/XX/XXXX]

Sets your system to the date that you specify (usually the current date). The format is month, day, year. Valid values for month, day, and year are **Month: (1 to 12)**, **Day: (1 to 31)**, **Year: (100 year range)**. Use the **<Tab>** or **<Shift> + <Tab>** keys to move between the month, day, and year fields.

### Legacy Diskette A [1.44M, 3.5 in.], Legacy Diskette B [None]

Sets the type of floppy drives installed. Configuration options: [None] [360K, 5.25 in.] [1.2M, 5.25 in.] [720K, 3.5 in.] [1.44M, 3.5 in.] [2.88M, 3.5 in.]

### Floppy 3 Mode Support [Disabled]

This is required to support older Japanese floppy drives. Floppy 3 Mode support will allow reading and writing of 1.2MB (as opposed to 1.44MB) on a 3.5-inch diskette. Configuration options: [Disabled] [Drive A] [Drive B] [Both]

# 4. BIOS SETUP

## 4.3.1 Primary & Secondary Master/Slave

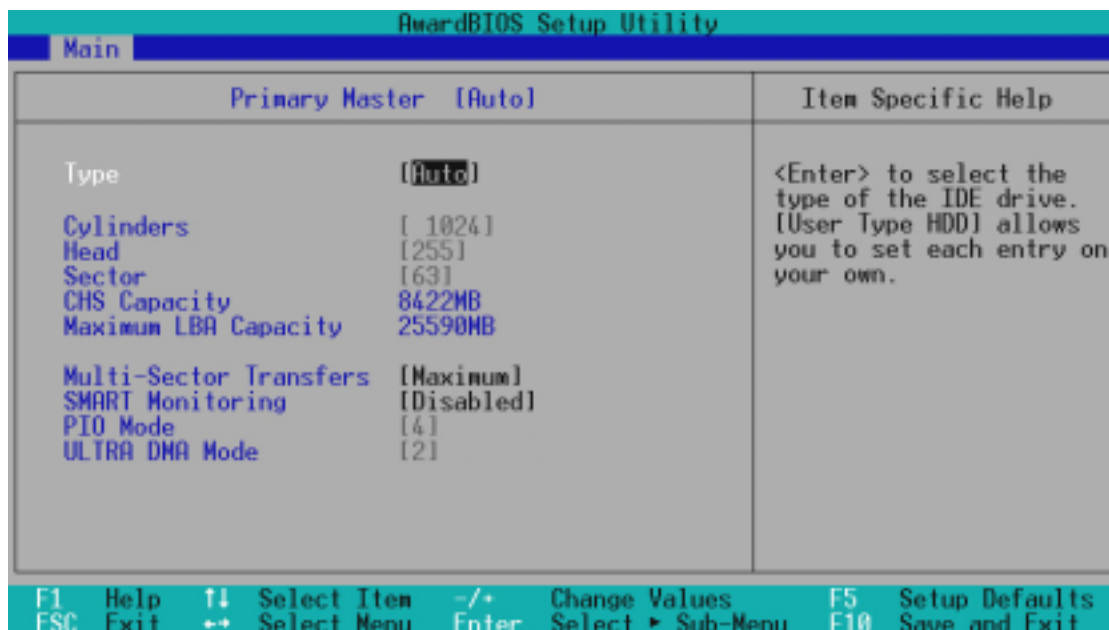

**NOTE:** Before attempting to configure a hard disk drive, make sure you have the configuration information supplied by the manufacturer of the drive. Incorrect settings may cause your system to not recognize the installed hard disk. To allow the BIOS to detect the drive type automatically, select [Auto].

### Type [Auto]

Select [Auto] to automatically detect an IDE hard disk drive. If automatic detection is successful, the correct values will be filled in for the remaining fields on this sub-menu. If automatic detection fails, your hard disk drive may be too old or too new. You can try updating your BIOS or enter the IDE hard disk drive parameters manually.

**NOTE:** After the IDE hard disk drive information has been entered into BIOS, new IDE hard disk drives must be partitioned (such as with FDISK) and then formatted before data can be read from and write on. Primary IDE hard disk drives must have its partition set to *active* (also possible with FDISK).

Other options for the **Type** field are:

-----  
**[None]** - to disable IDE devices

# 4. BIOS SETUP

**IMPORTANT:** If your hard disk was already formatted on an older previous system, incorrect parameters may be detected. You will need to enter the correct parameters manually or use low-level format if you do not need the data stored on the hard disk. If the parameters listed differ from the ones used when the disk was formatted, the disk will not be readable. If the auto-detected parameters do not match the ones that should be used for your disk, you should enter the correct ones manually by setting [User Type HDD].

## [User Type HDD]

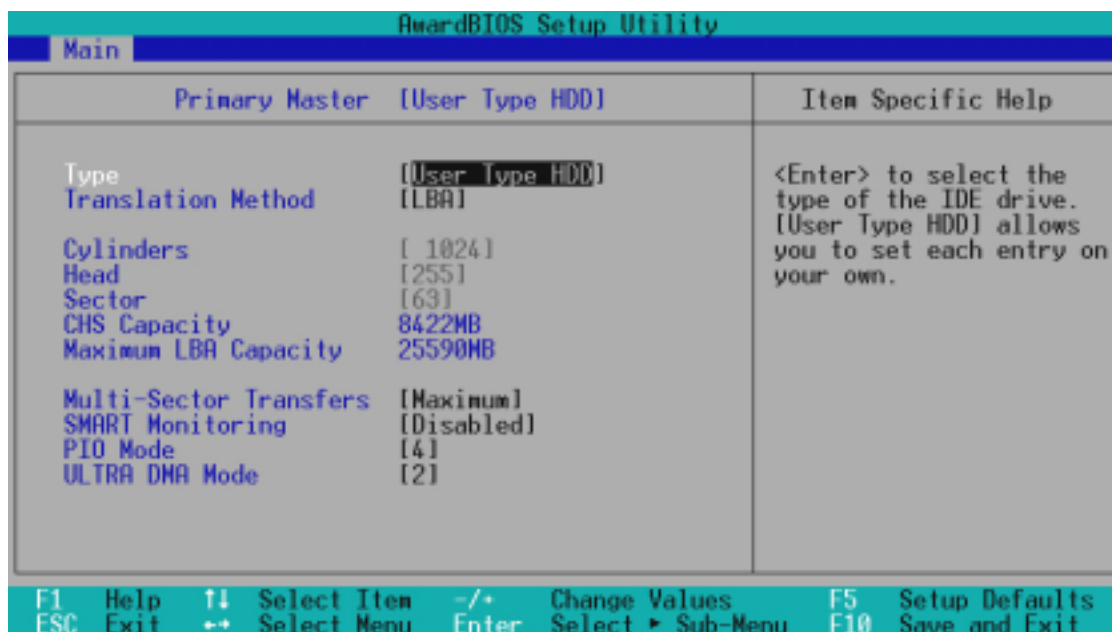

Manually enter the number of cylinders, heads and sectors per track for your drive. Refer to your drive documentation or look on the drive for this information. If no drive is installed or if you are removing a drive and not replacing it, select [None].

### Translation Method [LBA]

Select the hard disk drive type in this field. When Logical Block Addressing is enabled, 28-bit addressing of the hard drive is used without regard for cylinders, heads, or sectors. Note that LBA Mode is necessary for drives with greater than 504MB in storage capacity. Configuration options: [LBA] [LARGE] [Normal] [Match Partition Table] [Manual]

### Cylinders

This field configures the number of cylinders. Refer to your drive documentation to determine the correct value to enter into this field. **NOTE:** To make changes to this field, the **Type** field must be set to [User Type HDD] and the **Translation Method** field must be set to [Manual].

## 4. BIOS SETUP

---

### Head

This field configures the number of read/write heads. Refer to your drive documentation to determine the correct value to enter into this field. **NOTE:** To make changes to this field, the **Type** field must be set to [User Type HDD] and the **Translation Method** field must be set to [Manual].

### Sector

This field configures the number of sectors per track. Refer to your drive documentation to determine the correct value to enter into this field. **NOTE:** To make changes to this field, the **Type** field must be set to [User Type HDD] and the **Translation Method** field must be set to [Manual].

### CHS Capacity

This field shows the drive's maximum CHS capacity calculated automatically by the BIOS from the drive information you entered.

### Maximum LBA Capacity

This field shows the drive's maximum LBA capacity calculated automatically by the BIOS from the drive information you entered.

### Multi-Sector Transfers [Maximum]

This option automatically sets the number of sectors per block to the highest number supported by the drive. This field can also be configured manually. Note that when this field is automatically configured, the set value may not always be the fastest value for the drive. Refer to the documentation that came with your hard drive to determine the optimal value and set it manually. **NOTE:** To make changes to this field, the **Type** field must be set to [User Type HDD]. Configuration options: [Disabled] [2 Sectors] [4 Sectors] [8 Sectors] [16 Sectors] [32 Sectors] [Maximum]

### SMART Monitoring [Disabled]

This allows the enabling or disabling of the S.M.A.R.T. (Self-Monitoring, Analysis and Reporting Technology) system which utilizes internal hard disk drive monitoring technology. This feature is normally disabled because system resources used in this feature may decrease system performance. Configuration options: [Disabled] [Enabled]

### PIO Mode [4]

This option lets you set a PIO (Programmed Input/Output) mode for the IDE device. Modes 0 through 4 provide successively increased performance. Configuration options: [0] [1] [2] [3] [4]

### Ultra DMA Mode [Disabled]

Ultra DMA capability allows improved transfer speeds and data integrity for compatible IDE devices. Set to [Disabled] to suppress Ultra DMA capability. **NOTE:** To make changes to this field, the **Type** field must be set to [User Type HDD]. Configuration options: [0] [1] [2] [3] [4] [Disabled]

# 4. BIOS SETUP

Other options for “Type:” are:

**[CD-ROM]** - for IDE CD-ROM drives

**[LS-120]** - for LS-120 compatible floppy disk drives

**[ZIP-100]** - for ZIP-100 compatible disk drives

**[MO]** - for IDE magneto optical disk drives

**[Other ATAPI Device]** - for IDE devices not listed here

After using the legend keys to make your selections on this sub-menu, press the <Esc> key to exit back to the Main menu. When the Main menu appears, you will notice that the drive size appear in the field for the hard disk drive that you just configured.

## 4.3.2 Keyboard Features

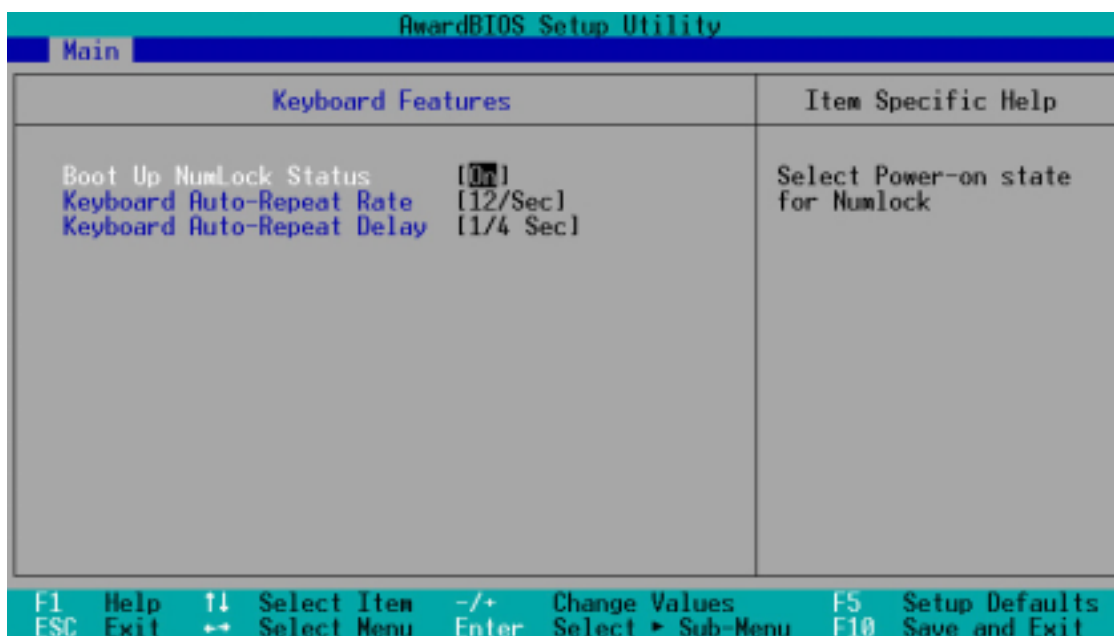

### Boot Up NumLock Status [On]

This field enables users to activate the Number Lock function upon system boot. Configuration options: [Off] [On]

### Keyboard Auto-Repeat Rate [12/Sec]

This controls the speed at which the system registers repeated keystrokes. Options range from 6 to 30 characters per second. Configuration options: [6/Sec] [8/Sec] [10/Sec] [12/Sec] [15/Sec] [20/Sec] [24/Sec] [30/Sec]

### Keyboard Auto-Repeat Delay [1/4 Sec]

This field sets the time interval for displaying the first and second characters. Configuration options: [1/4 Sec] [1/2 Sec] [3/4 Sec] [1 Sec]



# 4. BIOS SETUP

## Language [English]

This allows selection of the BIOS' displayed language. Currently only English is available.

## Supervisor Password [Disabled] / User Password [Disabled]

These fields allow you to set the passwords. To set the password, highlight the appropriate field and press <Enter>. Type in a password and press <Enter>. You can type up to eight alphanumeric characters. Symbols and other keys are ignored. To confirm the password, type the password again and press the <Enter>. The password is now set to [Enabled]. This password allows full access to the BIOS Setup menus. To clear the password, highlight this field and press <Enter>. The same dialog box as above will appear. Press <Enter> and the password will be set to [Disabled].

### A Note about Passwords

The BIOS Setup program allows you to specify passwords in the Main menu. The passwords control access to the BIOS during system startup. The passwords are not case sensitive. In other words, it makes no difference whether you enter a password using upper or lowercase letters. The BIOS Setup program allows you to specify two separate passwords: a Supervisor password and a User password. When disabled, anyone may access all BIOS Setup program functions. When enabled, the Supervisor password is required for entering the BIOS Setup program and having full access to all configuration fields.

### Forgot the Password?

If you forgot the password, you can clear the password by erasing the CMOS Real Time Clock (RTC) RAM. The RAM data containing the password information is powered by the onboard button cell battery. To erase the RTC RAM: (1) Unplug your computer, (2) Short the solder points, (3) Turn ON your computer, (4) Hold down <Delete> during bootup and enter BIOS setup to re-enter user preferences.

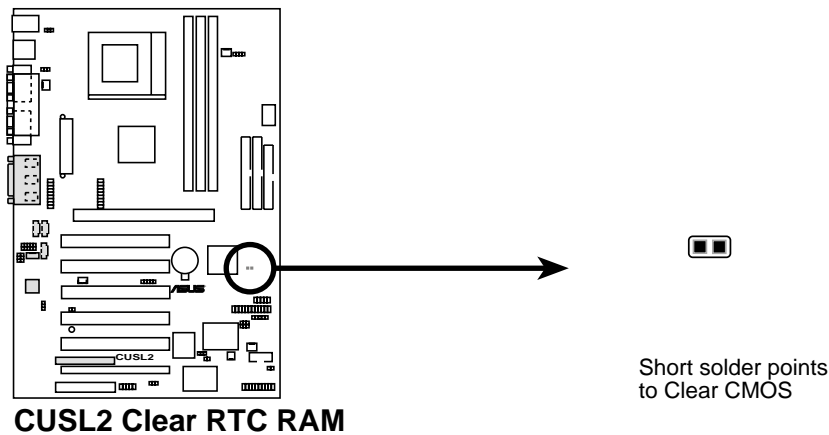

## Halt On [All Errors]

This field determines which types of errors will cause the system to halt. Configuration options: [All Errors] [No Error] [All but Keyboard] [All but Disk] [All but Disk/Keyboard]

## Installed Memory [XXX MB]

This display-only field displays the amount of conventional memory detected by the system during bootup. You do not need to make changes to this field.

# 4. BIOS SETUP

## 4.4 Advanced Menu

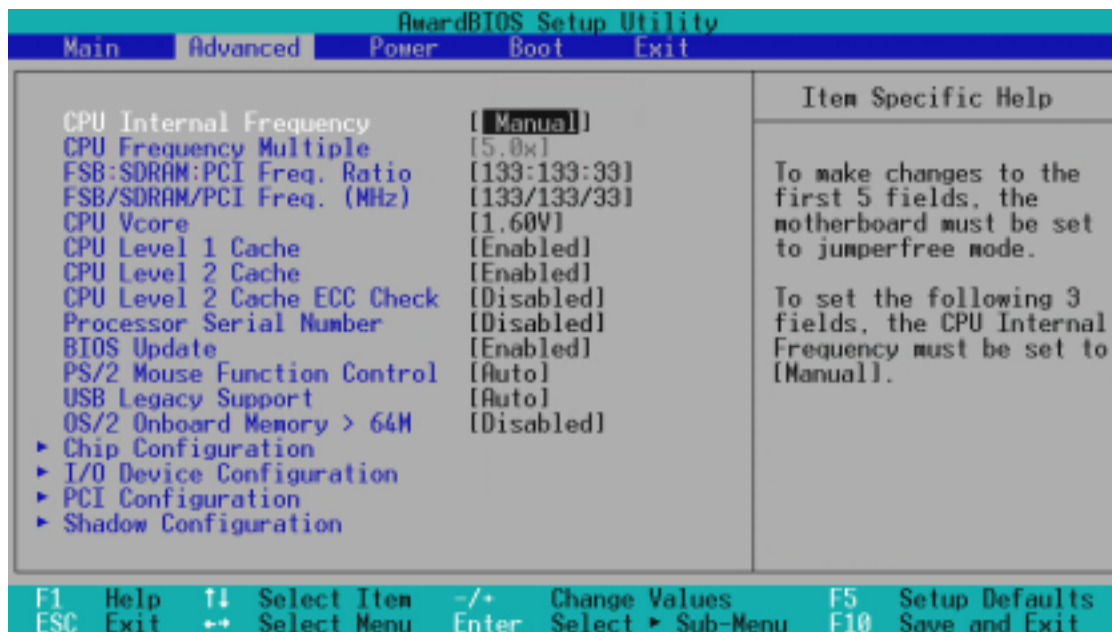

### CPU Internal Frequency

In JumperFree™ Mode, this field allows you to select the internal frequency of your CPU. Select [Manual] if you want to make changes to the subsequent 2 fields. Note that selecting a frequency higher than the CPU manufacturer recommends may cause the system to hang or crash. See *System Hangup* on page 60.

### CPU Frequency Multiple (When CPU Internal Frequency is set to [Manual])

This field sets the frequency multiple between the CPU's *internal* frequency and *external* frequency. In JumperFree™ Mode, when **CPU Internal Frequency** is set to [Manual], this must be set in conjunction with **FSB/SDRAM Freq. (MHz)** to match the internal frequency of your CPU. Configuration options vary according to the external frequency of your CPU.

### FSB:SDRAM:PCI Freq. Ratio (When CPU Internal Frequency is set to [Manual])

This field determines the frequency ratio among the Front Side Bus, SDRAM, and PCI bus. You may set the memory clock frequency in synchronous or asynchronous mode with respect to the Front Side Bus frequency. Configuration options: [66:100:33] [100:100:33] [133:133:33] [133:100:33]

### FSB/SDRAM/PCI Freq. (MHz)

(When CPU Internal Frequency is set to [Manual])

According to the previous setup field **FSB:SDRAM:PCI Freq. Ratio**, this field offers 32 sets of Front Side Bus, SDRAM, and PCI bus frequencies for you to choose.

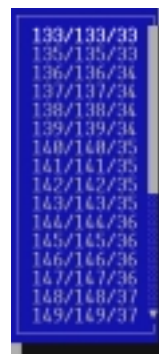

Available options  
when FSB:SDRAM:PCI Freq. Ratio  
is set to [133:133:33]

## 4. BIOS SETUP

---

### **CPU Vcore**

In JumperFree mode, this field displays the core voltage supplied to the CPU. If you want to set it manually, always refer to the CPU documentation. The picture shown here provides only an example of possible Vcore ranges.

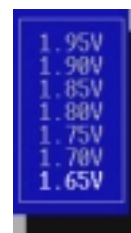

### **CPU Level 1 Cache, CPU Level 2 Cache [Enabled]**

These fields allow you to choose from the default of [Enabled] or choose [Disabled] to turn on or off the CPU's Level 1 and Level 2 built-in cache. Configuration options: [Disabled] [Enabled]

### **CPU Level 2 Cache ECC Check [Disabled]**

This function controls the ECC capability in the CPU level 2 cache. Configuration options: [Disabled] [Enabled]

### **Processor Serial Number [Disabled]**

The Processor Serial Number is a unique number that is added to every Pentium III processor to help verify the identity of the user across the Internet. Set this field to [Enabled] when you need increased security for doing business online or e-commerce. Otherwise, leave it to its default setting of [Disabled] for greater anonymity when surfing the Internet. **NOTE:** This field is available only when a Pentium III processor is installed in your system.

### **BIOS Update [Enabled]**

This functions as an update loader integrated into the BIOS to supply the processor with the required data. In the default position of [Enabled], the BIOS will load the update on all processors during system bootup. Configuration options: [Disabled] [Enabled]

### **PS/2 Mouse Function Control [Auto]**

The default of [Auto] allows the system to detect a PS/2 mouse on startup. If detected, IRQ12 will be used for the PS/2 mouse. IRQ12 will be reserved for expansion cards only if a PS/2 mouse is not detected. [Enabled] will always reserve IRQ12, whether on startup a PS/2 mouse is detected or not. Configuration options: [Enabled] [Auto]

### **USB Legacy Support [Auto]**

This motherboard supports Universal Serial Bus (USB) devices. The default of [Auto] allows the system to detect a USB device on startup. If detected, USB controller legacy mode will be enabled. If not detected, USB controller legacy mode will be disabled. When this field is set to [Disabled], USB controller legacy mode is disabled no matter whether you are using a USB device or not. Configuration options: [Disabled] [Enabled] [Auto]

### **OS/2 Onboard Memory > 64M [Disabled]**

When using OS/2 operating systems with installed DRAM of greater than 64MB, you need to set this option to [Enabled]; otherwise, leave this on [Disabled]. Configuration options: [Disabled] [Enabled]

# 4. BIOS SETUP

## Notes for JumperFree Mode

### CPU Upgrade/Reinstallation

To ensure that your system can enter BIOS setup after the processor has been changed or reinstalled, your system will start up running at a bus speed of 66MHz and a fail-safe CPU internal frequency (4x66MHz). It will then automatically take you to the Advanced menu with a popup menu of all the officially possible CPU internal frequencies.

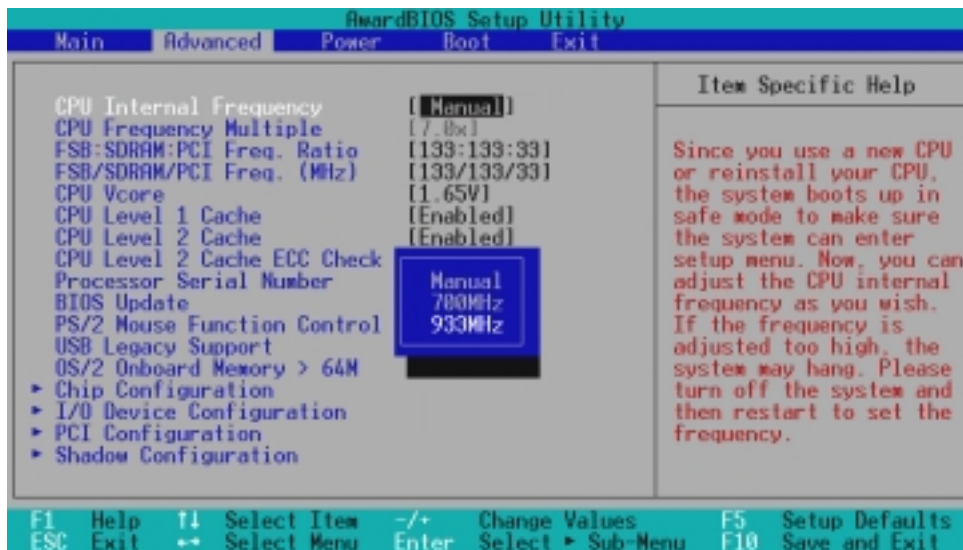

### System Hangup

If your system crashes or hangs due to improper frequency settings, power OFF your system and restart. The system will start up in safe mode running at a bus speed of 66MHz and enter BIOS setup.

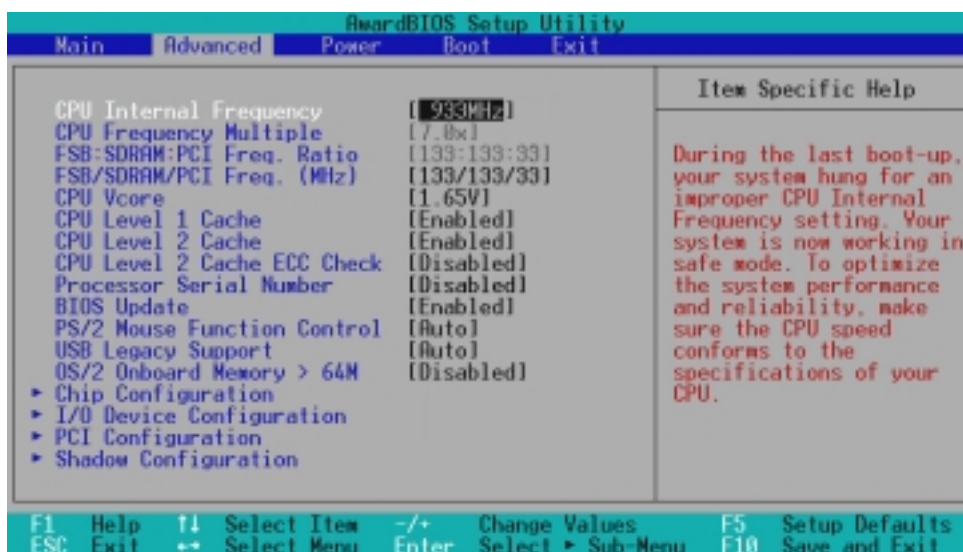

# 4. BIOS SETUP

## 4.4.1 Chip Configuration

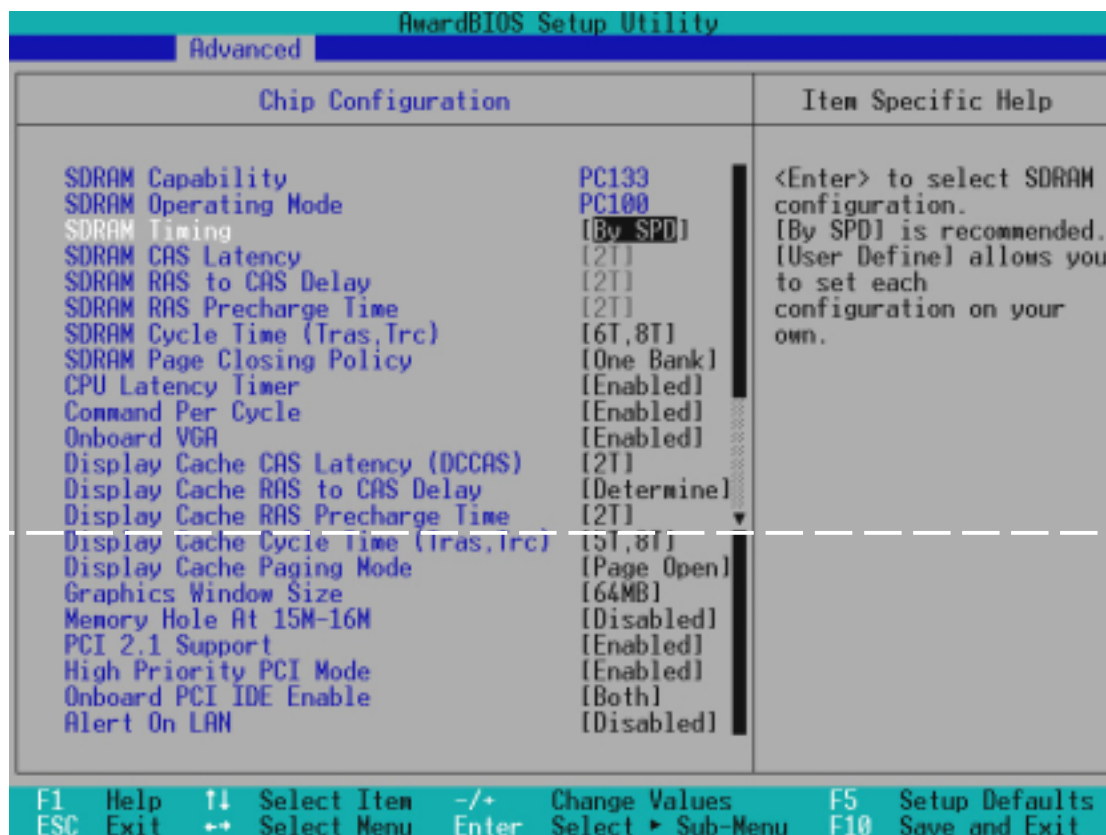

(Scroll down to see more items as shown.)

### SDRAM Capability

This field displays the capability of the memory modules that you are using—either PC100 or PC133.

### SDRAM Operating Mode

This field displays the current SDRAM operating mode (PC100 or PC133) according to the SDRAM frequency you configure in the **Advanced** menu.

### SDRAM Timing [By SPD]

This sets the optimal timings for items 4-7, depending on the memory modules that you are using. The default setting [By SPD] configures items 4-7 by reading the contents in the SPD (Serial Presence Detect) device. The EEPROM on the memory module stores critical parameter information about the module, such as memory type, size, speed, voltage interface, and module banks. Configuration options: [User Define] [By SPD]

**NOTE:** The following 3 fields will only be adjustable when **SDRAM Configuration** is set to [User Define].

### SDRAM CAS Latency

This controls the latency between the SDRAM read command and the time that the data actually becomes available.

# 4. BIOS SETUP

---

## **SDRAM RAS to CAS Delay**

This controls the latency between the SDRAM active command and the read/write command.

## **SDRAM RAS Precharge Time**

This controls the idle clocks after issuing a precharge command to the SDRAM.

## **SDRAM Cycle Time (Tras, Trc) [6T, 8T]**

This feature controls the number of SDRAM clocks used for SDRAM parameters Tras and Trc. Tras specifies the minimum clocks required between active command and precharge command. Trc specifies the minimum clocks required between active command and re-active command. Configuration options: [5T, 7T] [6T, 8T]

## **SDRAM Page Closing Policy [One Bank]**

This feature controls that after a page miss whether the Graphics and Memory Controller Hub (GMCH) will issue “precharge only the bank” or “precharge all” command to a specific opened SDRAM bank. Configuration options: [One Bank] [All Banks]

## **CPU Latency Timer [Enabled]**

This controls the GMCH’s response to CPU deferrable cycles. Configuration options: [Disabled] [Enabled]

## **Command Per Cycle [Enabled]**

When onboard VGA is used, CPU can help to gain graphics performance by increasing proper SDRAM cycles combinations. Configuration options: [Enabled] [Disabled]

## **Onboard VGA [Enabled]**

Leave on default setting if you want to use the onboard VGA. Select [Disabled] if you want to use an add-on AGP or PCI VGA card. Configuration options: [Disabled] [Enabled]

**NOTE:** The following 6 fields will only be displayed when the AGP Inline Memory Module (AIMM) is used and **Onboard VGA** is set to [Enabled].

## **Display Cache [Enabled]**

This field must be enabled to see the other **Display Cache** related configuration fields. Configuration options: [Enabled] [Disabled]

## **Display Cache CAS Latency (DCCAS) [2T]**

Configuration options: [2T] [3T]

## 4. BIOS SETUP

---

### **Display Cache RAS to CAS Delay [Determined by DCCAS]**

With the default setting [Determined by DCCAS], this field has the same configuration as **Display Cache CAS Latency (DCCAS)**. Configuration options: [Determined by DCCAS] [2T]

### **Display Cache RAS Precharge Time [2T]**

Configuration options: [2T] [3T]

### **Display Cache Cycle Time (Tras, Trc) [5T, 8T]**

Configuration options: [5T, 8T] [7T, 10T]

### **Display Cache Paging Mode [Page Open Mode]**

Configuration options: [Page Open Mode] [Page Close Mode]

### **Graphics Window Size [64MB]**

This feature allows you to select the size of mapped memory for AGP graphic data. Configuration options: [64MB] [32MB]

### **Memory Hole At 15M-16M [Disabled]**

This field allows you to reserve an address space for ISA devices that require it. Configuration options: [Disabled] [Enabled]

### **PCI 2.1 Support [Enabled]**

This function allows you to enable or disable PCI 2.1 features including passive release and delayed transaction. Configuration options: [Disabled] [Enabled]

### **High Priority PCI Mode [Enabled]**

This field allows you to give PCI slot 1 a higher priority. You may want to leave on the default setting if you are using an IEEE-1394 PCI card. Configuration options: [Disabled] [Enabled]

### **Onboard PCI IDE Enable [Both]**

You can select to enable the primary IDE channel, secondary IDE channel, both, or disable both channels. Configuration options: [Both] [Disabled]

### **Alert On LAN [Disabled]**

When you are connecting to a network through a Communication Networking Riser (CNR) card, this field allows you to enable or disable the Alert-On-LAN function. Configuration options: [Disabled] [Enabled]

# 4. BIOS SETUP

## 4.4.2 I/O Device Configuration

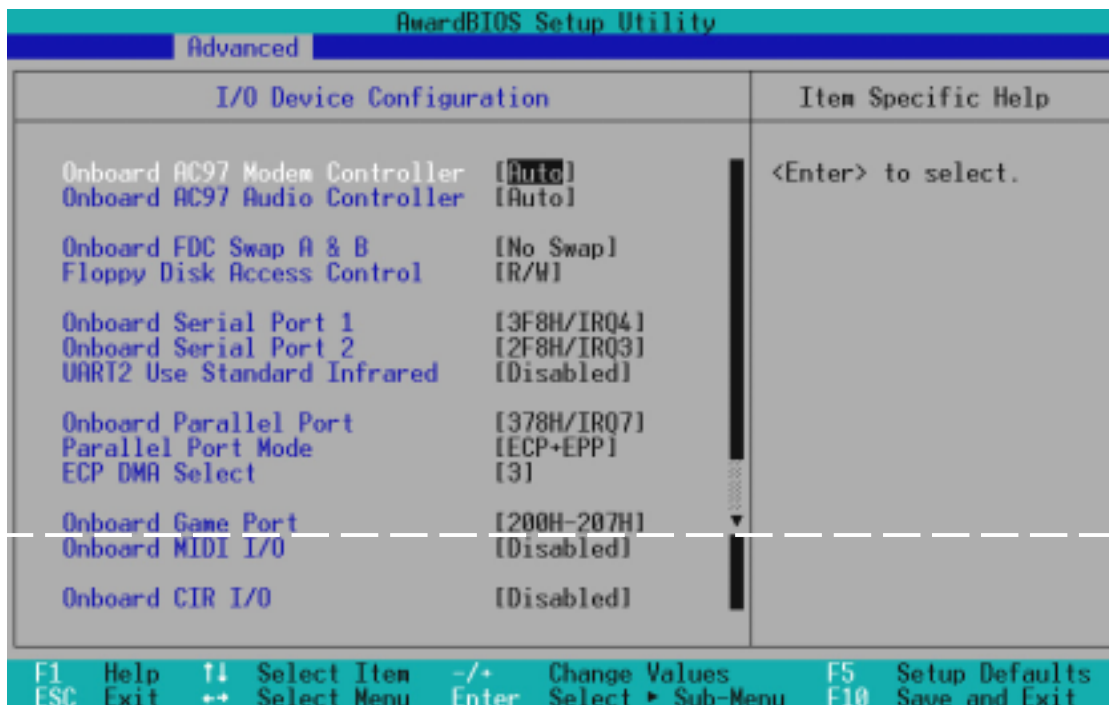

(Scroll down to see more items as shown.)

### Onboard AC97 Modem Controller [Auto]

### Onboard AC97 Audio Controller [Auto]

[Auto] allows the motherboard's BIOS to detect whether you are using any modem/audio device. If a modem/audio device is detected, the onboard modem/audio controller will be enabled; if no modem/audio device is detected, the onboard modem/audio controller will be disabled. If you have conflicts with the onboard controller, you may set the appropriate field to [Disabled]. Configuration options: [Disabled] [Auto]

### Onboard FDC Swap A & B [No Swap]

This field allows you to reverse the hardware drive letter assignments of your floppy disk drives. Configuration options: [No Swap] [Swap AB]

### Floppy Disk Access Control [R/W]

When set to [Read Only], this field protects files from being copied to floppy disks by allowing reads from the floppy disk drive but not writes. The setup default [R/W] allows both reads and writes. Configuration options: [R/W] [Read Only]

### Onboard Serial Port 1 [3F8H/IRQ4]

### Onboard Serial Port 2 [2F8H/IRQ3]

These fields allow you to set the addresses for the onboard serial connectors. Serial Port 1 and Serial Port 2 must have different addresses. Configuration options: [3F8H/IRQ4] [2F8H/IRQ3] [3E8H/IRQ4] [2E8H/IRQ10] [Disabled]



## 4. BIOS SETUP

---

### **UART2 Use Standard Infrared [Disabled]**

When enabled, this field activates the onboard standard infrared feature and sets the second serial UART to support the infrared module connector on the motherboard. If your system already has a second serial port connected to the onboard COM2 connector, it will no longer work if you enable the infrared feature. Configuration options: [Disabled] [Enabled]

### **Onboard Parallel Port [378H/IRQ7]**

This field sets the address of the onboard parallel port connector. If you disable this feature, **Parallel Port Mode** and **ECP DMA Select** configurations will not be available. Configuration options: [Disabled] [378H/IRQ7] [278H/IRQ5]

### **Parallel Port Mode [ECP+EPP]**

This field allows you to set the operation mode of the parallel port. [Normal] allows normal-speed operation but in one direction only; [EPP] allows bidirectional parallel port operation; [ECP] allows the parallel port to operate in bidirectional DMA mode; [ECP+EPP] allows normal speed operation in a two-way mode. Configuration options: [Normal] [EPP] [ECP] [ECP+EPP]

### **ECP DMA Select [3]**

This field allows you to configure the parallel port DMA channel for the selected **ECP** mode. This selection is available only if you select [ECP] or [ECP+EPP] in **Parallel Port Mode** above. Configuration options: [1] [3]

### **Onboard Game Port [200H-207H]**

This field sets the address of the onboard game port connector. Configuration options: [Disabled] [200H-207H] [208H-20FH]

### **Onboard MIDI I/O [Disabled]**

This field sets the address of the onboard MIDI connector. Configuration options: [Disabled] [330H-331H] [300H-301H]

### **Onboard MIDI IRQ [xx]**

This field is not available if you select [Disabled] for the **Onboard MIDI I/O** field. Configuration options: [3] [4] [5] [7] [9] [10] [11] [12] [14] [15]

### **Onboard CIR I/O [Disabled]**

This field sets the address of the onboard Consumer IR connector. Configuration options: [Disabled] [2E0-2E8H] [3E0-3E8H]

### **Onboard CIR IRQ [xx]**

This field is not available if you select [Disabled] for the **Onboard CIR I/O** field. Configuration options: [3] [4] [5] [7] [9] [10] [11] [12] [14] [15]

# 4. BIOS SETUP

## 4.4.3 PCI Configuration

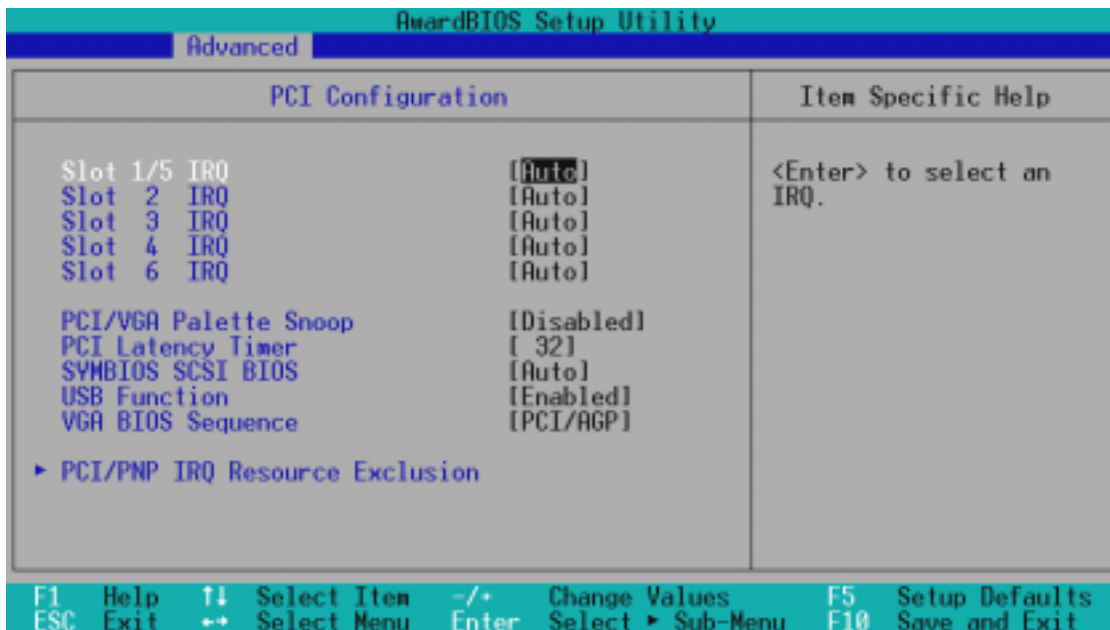

### Slot 1/5, Slot 2, Slot 3, Slot 4, Slot 6 IRQ [Auto]

These fields set how IRQ use is determined for each PCI slot. The default setting for each field is [Auto], which utilizes auto-routing to determine IRQ use. Configuration options: [Auto] [NA] [3] [4] [5] [7] [9] [10] [11] [12] [14] [15]

### PCI/VGA Palette Snoop [Disabled]

Some nonstandard VGA cards, such as graphics accelerators or MPEG video cards, may not show colors properly. The setting [Enabled] should correct this problem. Otherwise, leave this on the default setting of [Disabled]. Configuration options: [Disabled] [Enabled]

### PCI Latency Timer [32]

Leave on default setting for best performance vs. stability.

### SYMBIOS SCSI BIOS [Auto]

[Auto] allows the motherboard's BIOS to detect whether you have a Symbios SCSI controller. If the Symbios SCSI controller is detected, the motherboard's Symbios BIOS will be enabled; if no Symbios SCSI controller is detected, the onboard Symbios SCSI BIOS will be disabled.

[Disabled] will disable the motherboard's Symbios SCSI BIOS so that the BIOS on an add-on Symbios SCSI card can be used. If your Symbios SCSI card does not have a BIOS, the Symbios SCSI card will not function. Configuration options: [Auto] [Disabled]

# 4. BIOS SETUP

## USB Function [Enabled]

This motherboard supports Universal Serial Bus (USB) devices. Set to [Enabled] if you want to use USB devices. Configuration options: [Disabled] [Enabled]

## VGA BIOS Sequence [PCI/AGP]

If your computer has both PCI and AGP VGA controllers, this field allows you to select which of the controllers will act as your primary graphics controller. The default, [PCI/AGP], allows your PCI controller to take precedent when detected. [AGP/PCI] uses the AGP controller as your primary controller. Configuration options: [PCI/AGP] [AGP/PCI]

## PCI/PNP IRQ Resource Exclusion

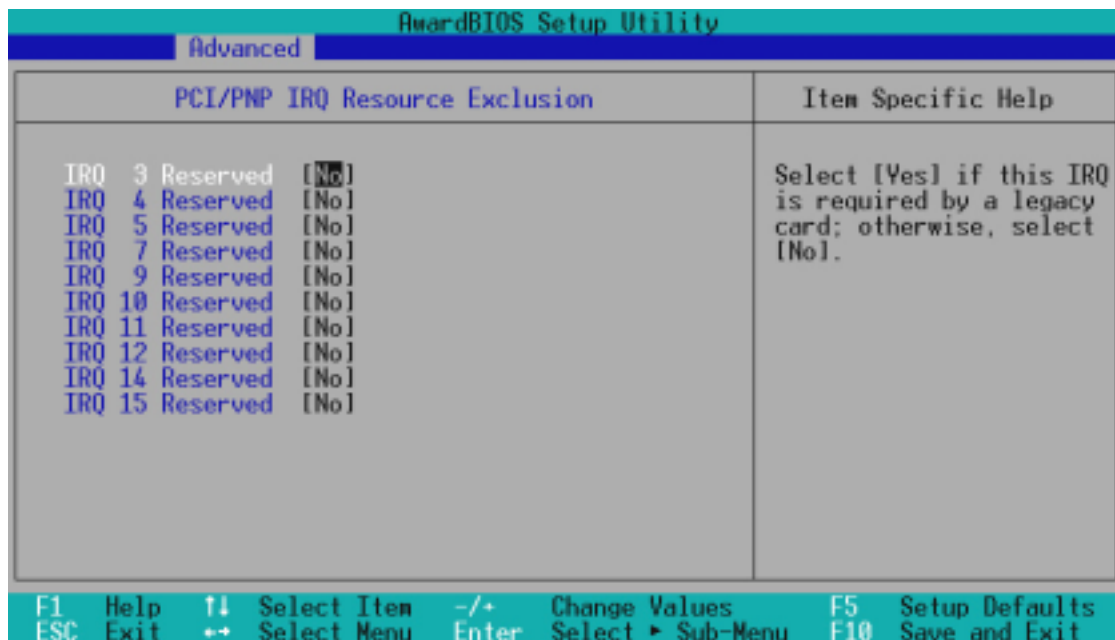

## IRQ XX Reserved [No]

These fields indicate whether or not the displayed IRQ for each field is being used by a specified device. The default value indicates that the displayed IRQ is not used. Configuration options: [No] [Yes]

# 4. BIOS SETUP

## 4.4.4 Shadow Configuration

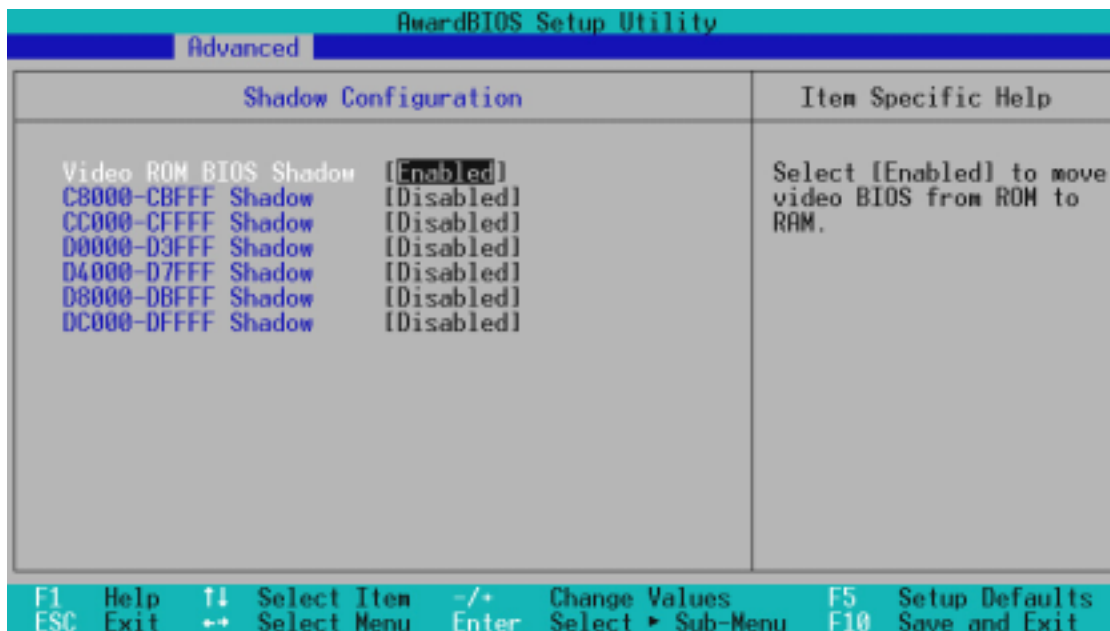

### Video ROM BIOS Shadow [Enabled]

This field allows you to change the video BIOS location from ROM to RAM. Relocating to RAM enhances system performance, as information access is faster than the ROM. Configuration options: [Disabled] [Enabled]

### C8000-DFFFF Shadow [Disabled]

These fields are used for shadowing other expansion card ROMs. If you install other expansion cards with ROMs on them, you will need to know which addresses the ROMs use to shadow them specifically. Shadowing a ROM reduces the memory available between 640K and 1024K by the amount used for this purpose. Configuration options: [Disabled] [Enabled]

## 4. BIOS SETUP

### 4.5 Power Menu

The Power menu allows you to reduce power consumption. This feature turns off the video display and shuts down the hard disk after a period of inactivity.

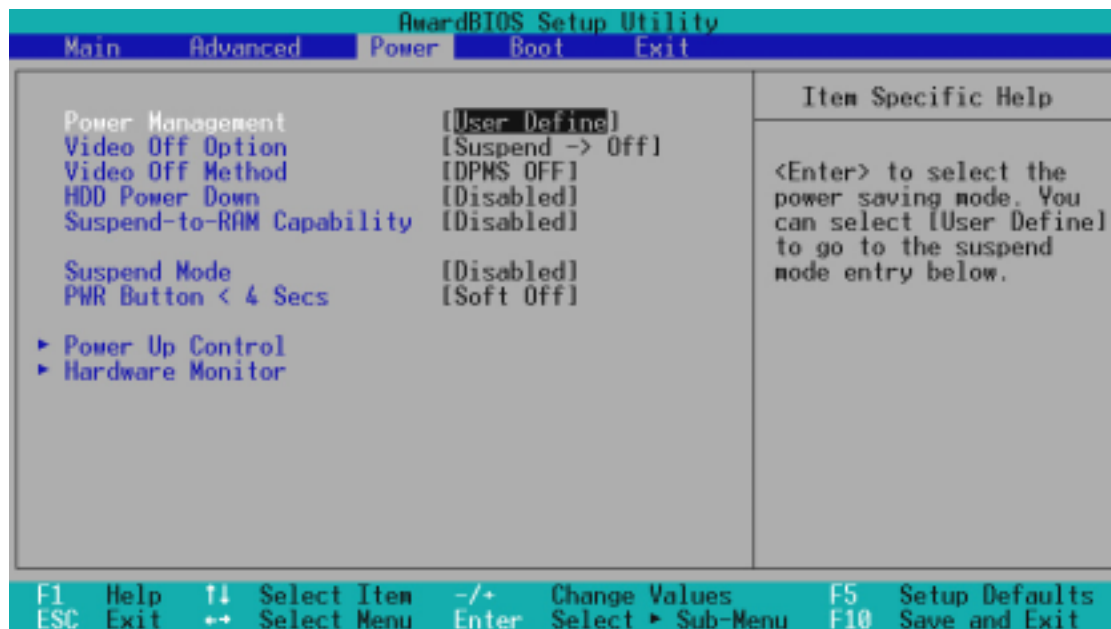

#### Power Management [User Define]

This option must be enabled to use any of the automatic power saving features. If this menu item is set to [Disabled], power management features will not function regardless of other field settings on this menu. The [User Define] option allows you to make your own selections in the Power menu. When set to [Max Saving], system power will be conserved to its greatest amount. The **Suspend Mode** field will then be set to predefined value that ensures maximum power savings.

This field acts as the master control for the power management modes. [Max Saving] puts the system into power saving mode after a brief period of system inactivity; [Min Saving] is almost the same as [Max Saving] except that the system inactivity period is longer; [Disabled] disables the power saving features; [User Define] allows you to set power saving options according to your preference. Configuration options: [User Define] [Disabled] [Min Saving] [Max Saving]

**IMPORTANT:** Advanced Power Management (APM) should be installed to keep the system time updated when the computer enters suspend mode activated by the BIOS Power Management. For DOS environments, you need to add the statement, `DEVICE=C:\DOS\POWER.EXE`, to your `CONFIG.SYS` file. For Windows 3.x and Windows 95, you need to install Windows with the APM feature. For Windows 98 and later, APM is automatically installed. A battery and power cord icon labeled “Power Management” will appear in the “Control Panel.” Choose “Advanced” in the Power Management Properties dialog box.

# 4. BIOS SETUP

---

## **Video Off Option [Suspend -> Off ]**

This field determines when to activate the video off feature for monitor power management. Configuration options: [Always On] [Suspend -> Off]

## **Video Off Method [DPMS OFF]**

This field defines the video off features. The DPMS (Display Power Management System) feature allows the BIOS to control the video display card if it supports the DPMS feature. [Blank Screen] only blanks the screen (use this for monitors without power management or “green” features. If set up in your system, your screen saver will not display with [Blank Screen] selected). [V/H SYNC+Blank] blanks the screen and turns off vertical and horizontal scanning. Configuration options: [Blank Screen] [V/H SYNC+Blank] [DPMS Standby] [DPMS Suspend] [DPMS OFF] [DPMS Reduce ON]

## **HDD Power Down [Disabled]**

This feature shuts down any IDE hard disk drives in the system after a period of inactivity as set in this user-configurable field. This feature does not affect SCSI hard drives. Configuration options: [Disabled] [1 Min] [2 Min] [3 Min]...[15 Min]

## **Suspend-to-RAM Capability [Disabled]**

Suspend-to-RAM (STR) is an energy-saving feature. In Suspend-to-RAM state, all devices on the computer are turned off, except for the system RAM. Thus, the PC consumes less than 5 Watts of power. Select [Enabled] if your power supply can supply at least 720mA on the +5VSB lead to support the STR function. If the expansion cards you use on the motherboard do not support the STR function, you must leave this field on the default setting [Disabled]. **NOTE:** This field is only effective for Windows 98. Configuration options: [Disabled] [Enabled]

## **Suspend Mode [Disabled]**

Sets the time period before the system goes into suspend mode. **NOTE:** This field is effective for DOS, Windows 9x, and Windows NT 4.0 environments. Configuration options: [Disabled] [1~2 Min] [2~3 Min]...[1 Hour]

## **PWR Button < 4 Secs [Soft Off]**

When set to [Soft off], the ATX switch can be used as a normal system power-off button when pressed for less than 4 seconds. [Suspend] allows the button to have a dual function where pressing less than 4 seconds will place the system in sleep mode. Regardless of the setting, holding the ATX switch for more than 4 seconds will power off the system. Configuration options: [Soft off] [Suspend]

# 4. BIOS SETUP

## 4.5.1 Power Up Control

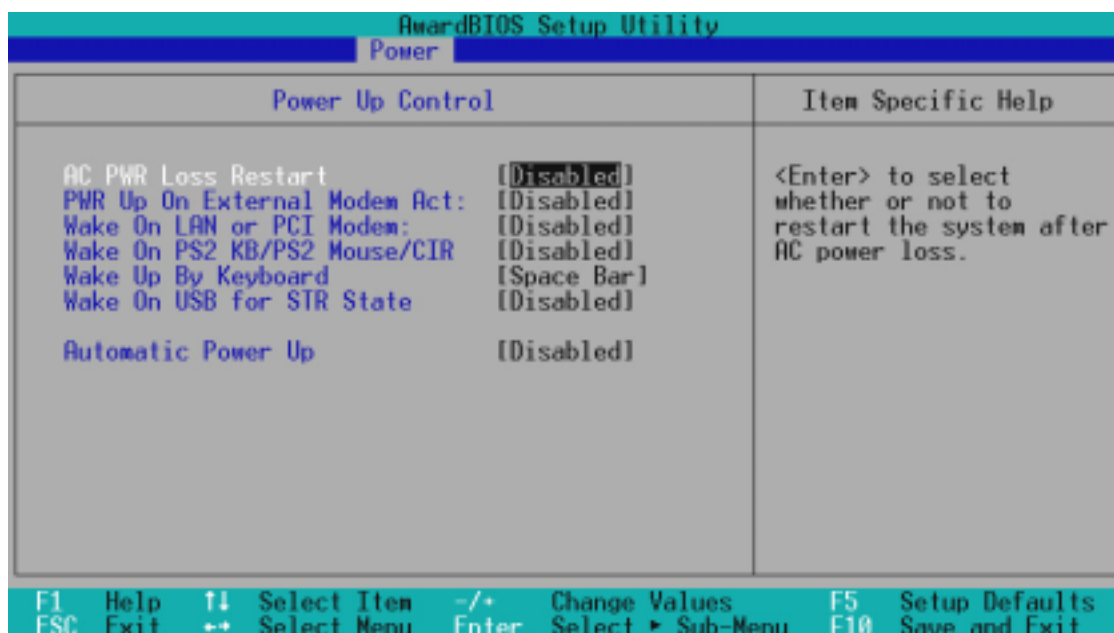

### AC PWR Loss Restart [Disabled]

This allows you to set whether you want your system to reboot after the power has been interrupted. [Disabled] leaves your system off and [Enabled] reboots your system. [Previous State] sets your system back to the state it is before the power interruption. Configuration options: [Disabled] [Enabled] [Previous State]

### PWR Up On External Modem Act [Disabled]

This allows either settings of [Enabled] or [Disabled] for powering up the computer when the external modem receives a call while the computer is in Soft-off mode. **NOTE:** The computer cannot receive or transmit data until the computer and applications are fully running. Thus connection cannot be made on the first try. Turning an external modem off and then back on while the computer is off causes an initialization string that will also cause the system to power on. Configuration options: [Disabled] [Enabled]

### Wake On LAN or PCI Modem [Disabled]

Wake-On-LAN/PCI Modem allows your computer to be booted from another computer via a network by sending a wake-up frame or signal. Configuration options: [Disabled] [Enabled]

**IMPORTANT:** This feature requires an optional network interface card with Wake-On-LAN and an ATX power supply with at least 720mA +5V standby power.

# 4. BIOS SETUP

---

## **Wake On PS2 KB/PS2 Mouse/CIR [Disabled]**

Set this field to [Enabled] if you wish to use your PS2 keyboard, PS2 mouse, or consumer IR device to power up your computer. This feature requires an ATX power supply that can supply at least 300mA on the +5VSB lead. The default is set to [Disabled] because not all computers have the appropriate ATX power supply. Your computer will not power ON if you set this to [Enabled] and do not have the appropriate ATX power supply. Configuration options: [Disabled] [Enabled]

## **Wake Up By Keyboard [Space Bar]**

When the previous setup item **Wake On PS2 KB/PS2 Mouse/CIR** is enabled, you may specify the key(s) to press to power up the computer. Configuration options: [Space Bar] [Ctrl-Esc] [Power Key]

## **Wake On USB for STR State [Disabled]**

This field allows you to use your USB device/s, if any, to power up the computer from Suspend-to-RAM mode. This feature requires an ATX power supply that can supply at least 2A on the +5VSB lead. The default is set to [Disabled] because not all computers have the appropriate ATX power supply. Your computer will not power on if you set this to [Enabled] and do not have the appropriate ATX power supply. **NOTE:** This feature must be set in conjunction with *USB Device Wake Up* in *3.4 Motherboard Settings*. Configuration options: [Disabled] [Enabled]

## **Automatic Power Up [Disabled]**

This allows an unattended or automatic system power up. You may configure your system to power up at a certain time of the day by selecting [Everyday] or at a certain time and day by selecting [By Date]. **NOTE:** *Automatic Power Up* will not work if the system is powered down by operating systems, such as Windows 98, which have ACPI support enabled. Configuration options: [Disabled] [Everyday] [By Date]



# 4. BIOS SETUP

## 4.5.2 Hardware Monitor

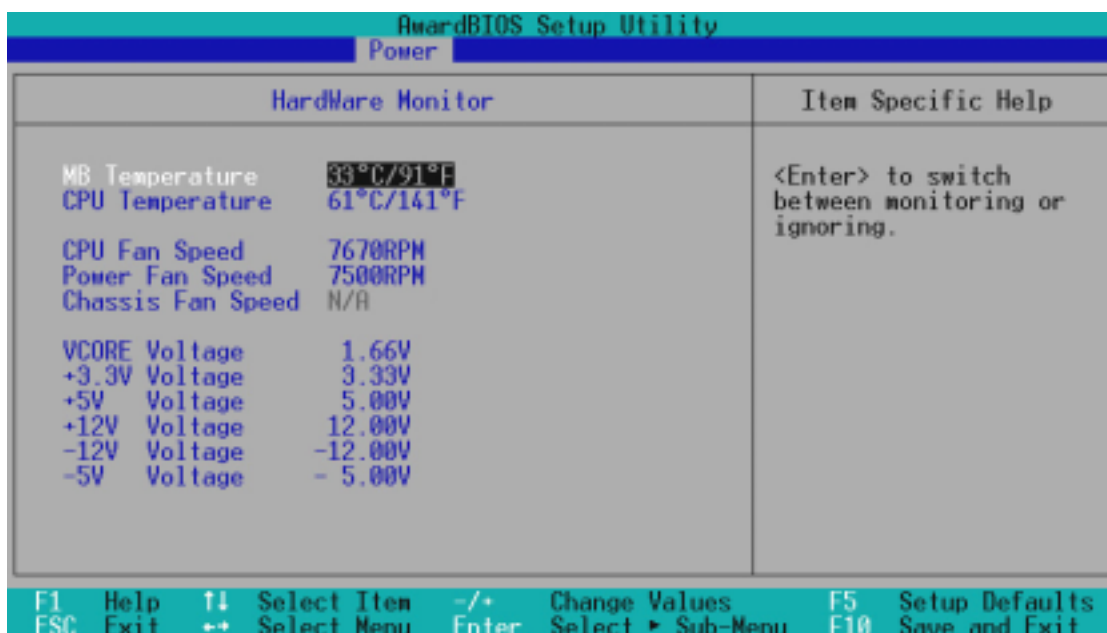

### MB Temperature [xxxC/xxxF]

### CPU Temperature [xxxC/xxxF]

The onboard hardware monitor is able to detect the MB (motherboard) and CPU temperatures. Set to [Ignore] only if necessary.

### CPU Fan Speed [xxxxRPM]

### Power Fan Speed [xxxxRPM]

### Chassis Fan Speed [xxxxRPM]

The onboard hardware monitor is able to detect the CPU, power supply, and chassis fan speeds in rotations per minute (RPM). The presence of the fans is automatically detected. Set to [Ignore] only if necessary.

### VCORE1 Voltage, +3.3V Voltage, +5V Voltage, +12V Voltage, -12V Voltage, -5V Voltage [xx.xV]

The onboard hardware monitor is able to detect the voltage output by the onboard voltage regulators. Set to [Ignore] only if necessary.

**NOTE:** If any of the monitored items is out of range, an error message will appear: “Hardware Monitor found an error. Enter Power setup menu for details”. You will then be prompted to “Press **F1** to continue, **DEL** to enter SETUP”.

# 4. BIOS SETUP

## 4.6 Boot Menu

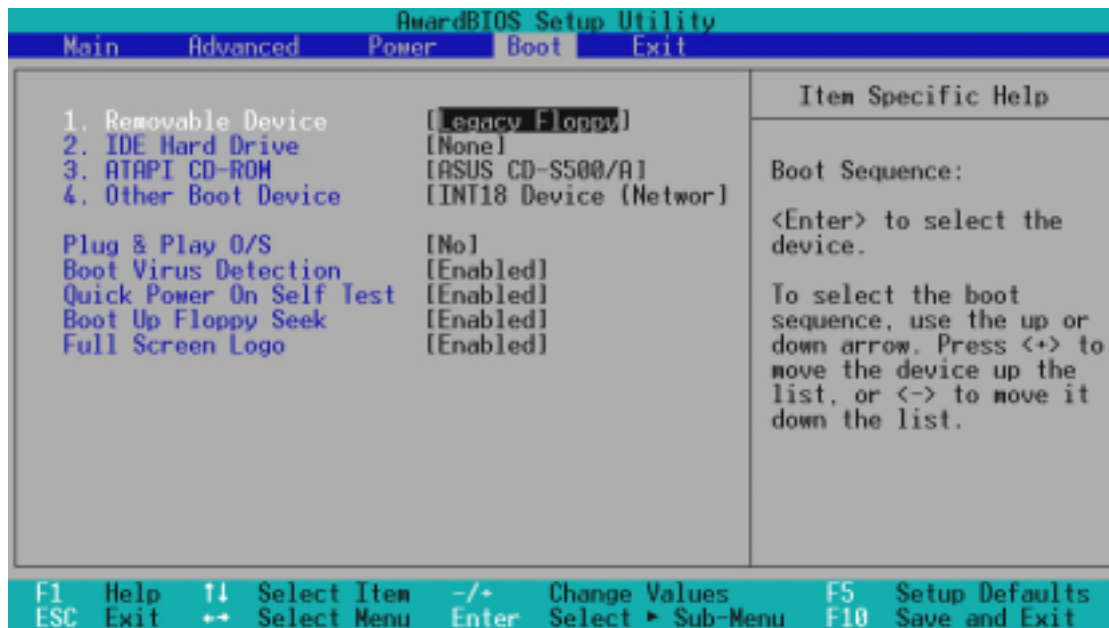

### Boot Sequence

The Boot menu allows you to select among the four possible types of boot devices listed using the up and down arrow keys. By using the <+> or <Space> key, you can promote devices and by using the <-> key, you can demote devices. Promotion or demotion of devices alters the priority which the system uses to search for a boot device on system power up. Configuration fields include **Removable Devices**, **IDE Hard Drive**, **ATAPI CD-ROM**, and **Other Boot Device**.

#### Removable Device [Legacy Floppy]

Configuration options: [Disabled] [Legacy Floppy] [LS120] [ZIP-100] [ATAPI MO]

#### IDE Hard Drive

This field allows you to select which IDE hard disk drive to use in the boot sequence. Pressing [Enter] will show the product IDs of all connected IDE hard disk drives.

#### ATAPI CD-ROM

This field allows you to select which ATAPI CD-ROM drive to use in the boot sequence. Pressing [Enter] will show the product IDs of all your connected ATAPI CD-ROM drives.

#### Other Boot Device Select [INT18 Device (Network)]

Configuration options: [Disabled] [SCSI Boot Device] [INT18 Device (Network)] [LANDesk (R) Service Agent]

## 4. BIOS SETUP

---

### **Plug & Play O/S [No]**

This field allows you to use a Plug-and-Play (PnP) operating system to configure the PCI bus slots instead of using the BIOS. When [Yes] is selected, interrupts may be reassigned by the OS. When a non-PnP OS is installed or you want to prevent reassigning of interrupt settings, select the default setting of [No]. Configuration options: [No] [Yes]

### **Boot Virus Detection [Enabled]**

This field allows you to set boot virus detection, ensuring a virus-free boot sector. The system halts and displays a warning message when it detects a virus. If this occurs, you can either allow the operation to continue or use a virus-free bootable floppy disk to restart and investigate your system. Configuration options: [Disabled] [Enabled]

### **Quick Power On Self Test [Enabled]**

This field speeds up the Power-On-Self Test (POST) routine by skipping retesting a second, third, and fourth time. Configuration options: [Disabled] [Enabled]

### **Boot Up Floppy Seek [Enabled]**

When enabled, the BIOS will seek the floppy disk drive to determine whether the drive has 40 or 80 tracks. Configuration options: [Disabled] [Enabled]

### **Full Screen Logo [Enabled]**

Configuration options: [Disabled] [Enabled]

# 4. BIOS SETUP

## 4.7 Exit Menu

Once you have made all of your selections from the various menus in the Setup program, you should save your changes and exit Setup. Select **Exit** from the menu bar to display the following menu:

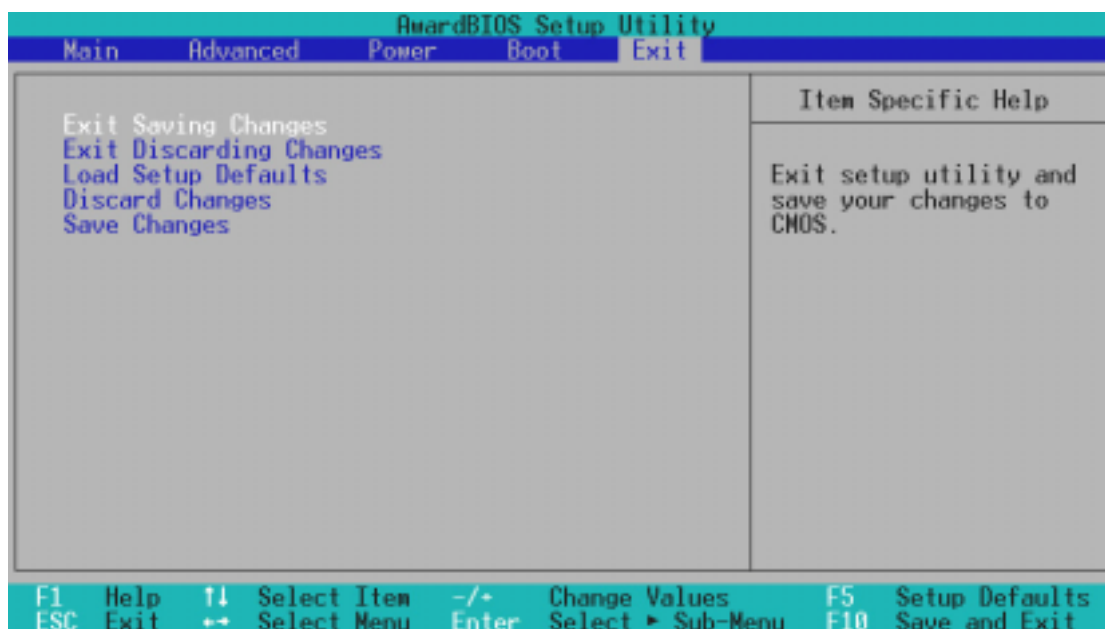

**NOTE:** Pressing <Esc> does not exit this menu. You must select one of the options from this menu or <F10> from the legend bar to exit this menu.

### Exit Saving Changes

Once you are finished making your selections, choose this option from the Exit menu to ensure the values you selected are saved to the CMOS RAM. The CMOS RAM is sustained by an onboard backup battery and stays on even when the PC is turned off. Once this option is selected, a confirmation is asked. Select [Yes] to save changes and exit.

**NOTE:** If you attempt to exit the Setup program without saving your changes, the program will prompt you with a message asking if you want to save your changes before exiting. Pressing <Enter> will then save changes while exiting.

### Exit Discarding Changes

This option should only be used if you do not want to save the changes you have made to the Setup program. If you have made changes to fields other than system date, system time, and password, the system will ask for confirmation before exiting.

# 4. BIOS SETUP

---

## **Load Setup Defaults**

This option allows you to load the default values for each of the parameters on the Setup menus. When this option is selected or if <F5> is pressed, a confirmation is requested. Select [Yes] to load default values. You can now select **Exit Saving Changes** or make other changes before saving the values to the non-volatile RAM.

## **Discard Changes**

This option allows you to discard the selections you made and restore the values you previously saved. After selecting this option, a confirmation is requested. Select [Yes] to discard any changes and load the previously saved values.

## **Save Changes**

This option saves your selections without exiting the Setup program. You can then return to other menus and make changes. After selecting this option, all selections are saved and a confirmation is requested. Select [Yes] to save any changes to the non-volatile RAM.

# 4. BIOS SETUP

---

(This page was intentionally left blank.)

# 5. SOFTWARE SETUP

---

## 5.1 Install Operating System

You should always use the latest operating system and updates when using new hardware to ensure full compliancy. You may use any version of Windows 98/2000/Millennium, but for Windows 95, you must use OSR 2.0 or later. For Windows NT 4.0, you must use Service Pack 3.0 or later.

## 5.2 Start Windows

When you start Windows 98 for the first time after installing your motherboard, Windows will detect all plug-and-play devices. Follow the Add New Hardware Wizard to install all necessary device drivers. When prompted to restart, select **No** and then follow the setup procedures in this section.

**NOTE:** Because there are various motherboard settings, options, and expansion cards, the following can only be used as a general reference and may not be an exact reflection of your system.

# 5. SOFTWARE SETUP

## 5.3 CUSL2 Motherboard Support CD

**NOTE:** The support CD contents are subject to change at any time without notice.

To begin using your support CD disc, just insert it into your CD-ROM drive and the support CD installation menu should appear. If the menu does not appear, double-click or run **E:\ASSETUP.EXE** (assuming that your CD-ROM drive is drive **E:**).

### 5.3.1 Installation Menu



- **INF Update Utility for Intel 815 Chipset:** Installs INF files in Windows for the following items: System and Graphics, LPC Interface, SM Bus, PCI Bridge, Bus Master IDE, USB Host, and Controllers.
- **Intel 815 Chipset Graphic Control Driver:** Installs Intel's 815 System and Graphics Controller Driver.
- **Intel LDCM Administrator Setup:** Installs software to monitor PC systems on the network within the same bridge address with the Client software installed. The administrator should install both Administrator and Client software.
- **Intel LDCM Client Setup:** Installs software to monitor the Client system. The LANdesk Client Manager must be installed to use the hardware manager features.
- **ASUS BIOS Flash Utility for LDCM:** Installs a utility that can remotely flash a client PC's BIOS when used in conjunction with Intel LDCM Administrator.
- **Install Intel Ultra ATA Storage Driver:** Installs Intel's Ultra ATA storage driver.
- **Install ASUS PC Probe Vx.xx:** Installs a utility to monitor your computer's fan, temperature, and voltages.
- **Install ASUS Update Vx.xx:** Installs a program to help you update your BIOS or download a BIOS image file.
- **Microsoft DirectX Driver:** Installs Microsoft DirectX driver.
- **YAMAHA SoftSynthesizer S-YXG50:** Installs the Yamaha SoftSynthesizer for playing MIDI files through software. Refer to the online help for more information.
- **PC-cillin 98 Vx.xx:** Installs the PC-cillin virus protection software. View the online help for more information.



# 5. SOFTWARE SETUP

---

(TO SEE THE FOLLOWING ITEMS, CLICK RIGHT ARROW ON THE LOWER-RIGHT CORNER OF THE MAIN MENU)

- **Adobe Acrobat Reader Vx.x:** Installs the Adobe Acrobat Reader software necessary to view user's manuals saved in PDF format. Updated or other language versions of this motherboard's manual is available in PDF format at any of our web sites.
- **Cyberlink Video and Audio Applications:** Installs Cyberlink PowerPlayer SE, PowerDVD Trial, and Cyberlink VideoLive Mail.
- **Show Motherboard Information:** Allows you to view information about your motherboard, such as product name, BIOS version, and CPU.
- **Browse Support CD:** Allows you to view the contents of the CD.
- **ReadMe:** Allows you to view the support CD file list and contact information.
- **Exit:** Exits the CD installation menu.

(TO RETURN TO THE MAIN MENU, CLICK LEFT ARROW ON THE LOWER-RIGHT CORNER OF THE SECONDARY MENU)

# 5. SOFTWARE SETUP

## 5.4 INF Update Utility for Intel 815 Chipset

Insert the Support CD that came with your motherboard into your CD-ROM drive or double-click the CD drive icon in **My Computer** to bring up the setup screen.

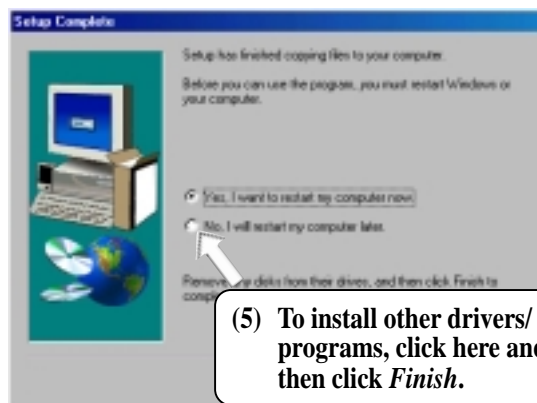
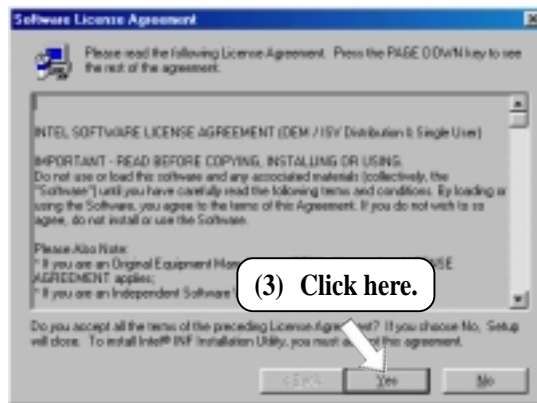

# 5. SOFTWARE SETUP

## 5.5 Intel 815 Chipset Graphic Control Driver

Insert the Support CD that came with your motherboard into your CD-ROM drive or double-click the CD drive icon in **My Computer** to bring up the setup screen.



# 5. SOFTWARE SETUP

## 5.6 Intel LDCM Administrator Setup

### System Requirements

- Intel® Pentium® microprocessor or higher.
- Operating system: Microsoft Windows 95 (can be OEM Service Release 2), or Windows 98, or Windows NT 4.0 (Service Pack 4 or later).
- Microsoft Internet Explorer 4.01 or higher.
- Memory: 16 MB of RAM for Windows 95/98; 24 MB of RAM for Windows NT (32 MB recommended).
- Disk storage space: 100 MB of available hard disk space to install; 40-100 MB of available hard disk space to run (depending on cluster size).
- Hardware system: DM or SM BIOS is required for full LDCM functionality.
- Protocols: IP (Winsock-enabled) communication protocol loaded on the client. An IP stack is required on the client, regardless of whether the client accesses the network.
- Monitor resolution of 600x800, 256 colors or greater.

Insert the Support CD that came with your motherboard into your CD-ROM drive or double-click the CD drive icon in **My Computer** to bring up the setup screen.

**NOTE:** LDCM will not run if another hardware monitoring utility, such as ASUS PC Probe, is installed. To uninstall any program, see **5.16 Uninstalling Programs**.

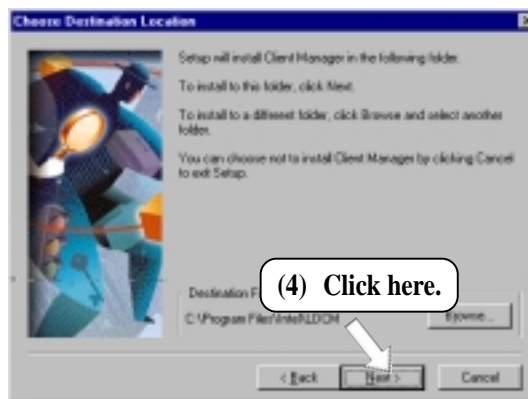
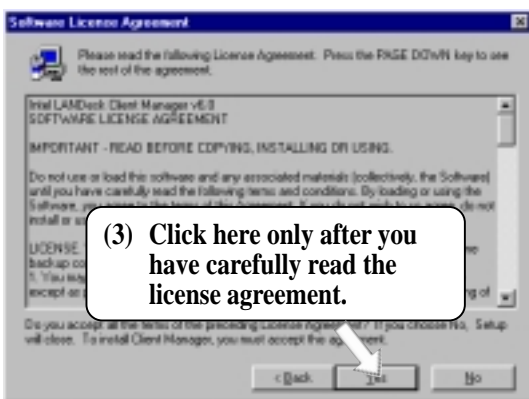
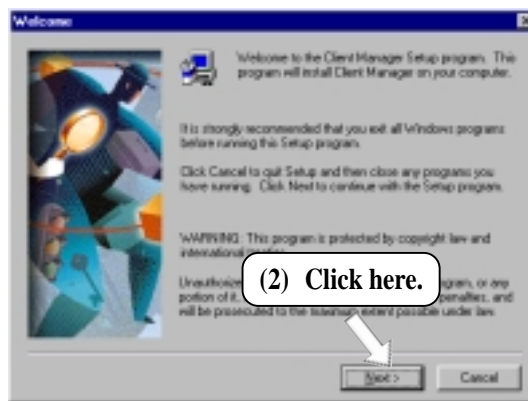

# 5. SOFTWARE SETUP

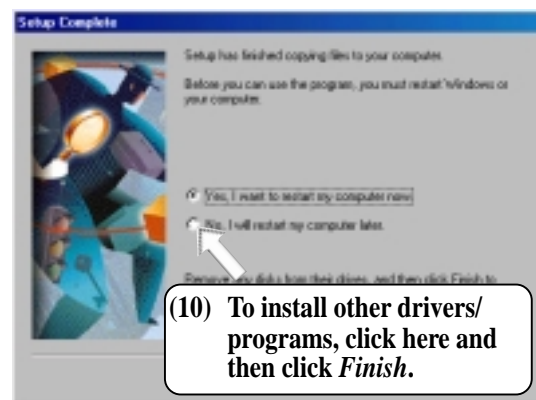
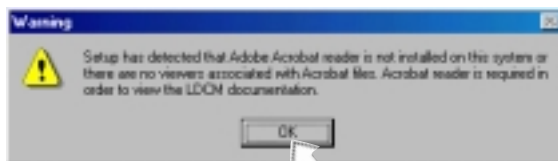
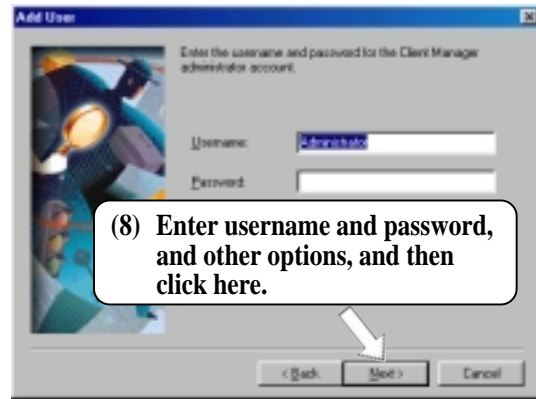
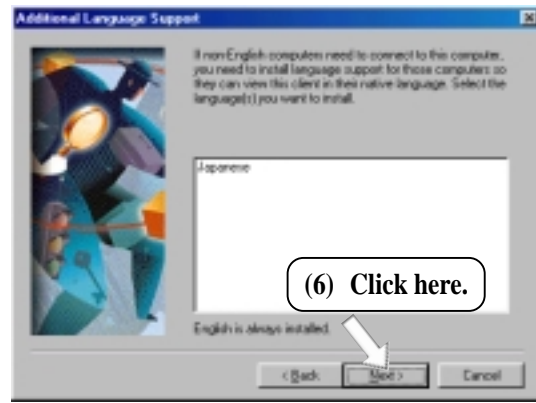
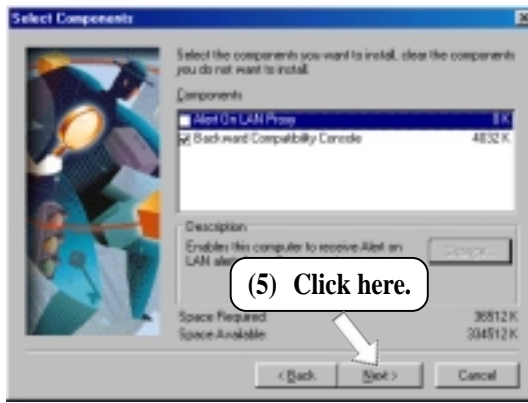

**NOTE:** This warning appears only if you don't have the Acrobat Reader installed. See [5.14 Adobe Acrobat Reader Vx.x](#) on how to install the Acrobat Reader.

# 5. SOFTWARE SETUP

## 5.7 Intel LDCM Client Setup

### System Requirements

- Intel® Pentium® microprocessor or higher.
- Operating system: Microsoft Windows 95 (can be OEM Service Release 2), or Windows 98, or Windows NT 4.0 (Service Pack 4 or later).
- Microsoft Internet Explorer 4.01 or higher.
- Memory: 16 MB of RAM for Windows 95/98; 24 MB of RAM for Windows NT (32 MB recommended).
- Disk storage space: 100 MB of available hard disk space to install; 40-100 MB of available hard disk space to run (depending on cluster size).
- Hardware system: DM or SM BIOS is required for full LDCM functionality.
- Protocols: IP (Winsock-enabled) communication protocol loaded on the client. An IP stack is required on the client, regardless of whether the client accesses the network.
- Monitor resolution of 600x800, 256 colors or greater.

Insert the Support CD that came with your motherboard into your CD-ROM drive or double-click the CD drive icon in **My Computer** to bring up the setup screen.

**NOTE:** LDCM will not run if another hardware monitoring utility, such as ASUS PC Probe, is installed. To uninstall any program, see *5.16 Uninstalling Programs*.

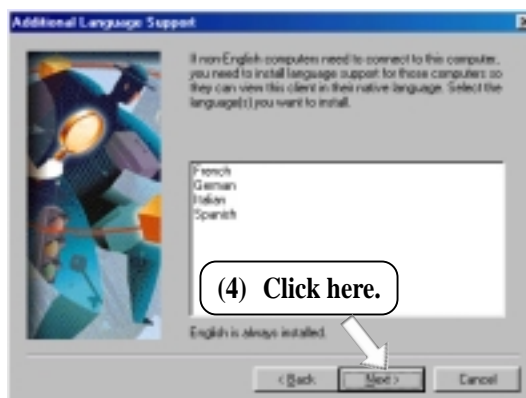
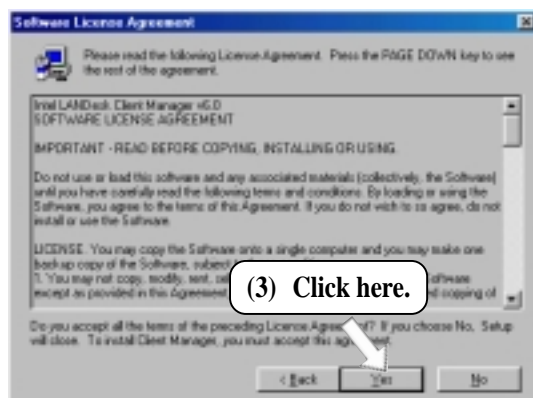
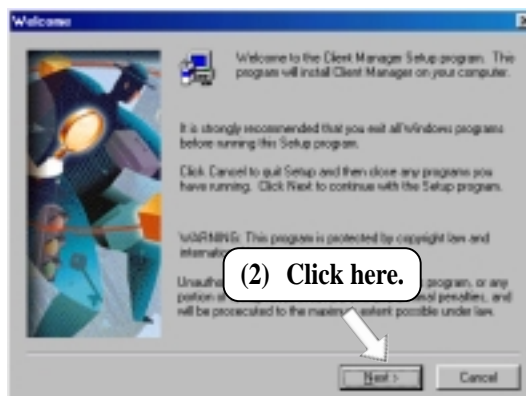

# 5. SOFTWARE SETUP

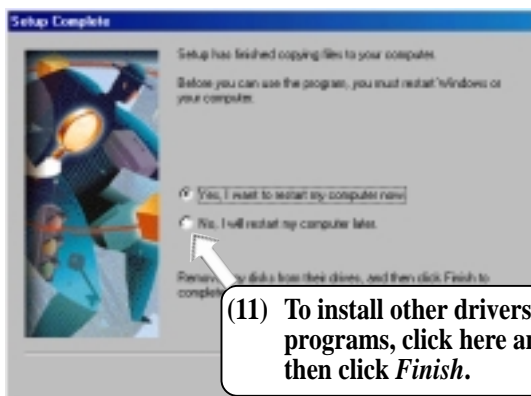
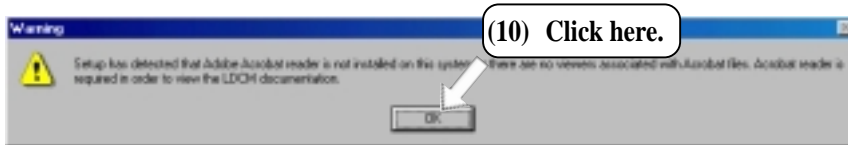
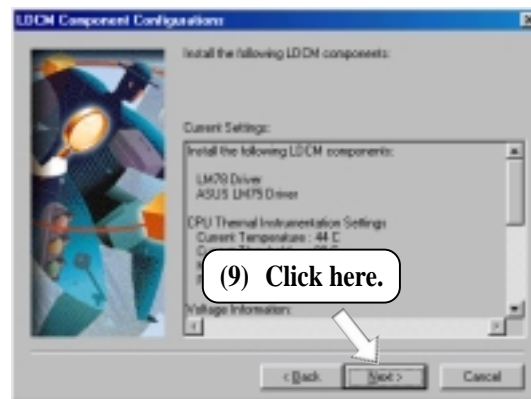
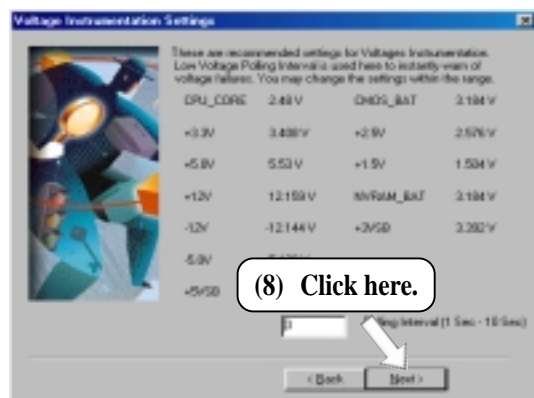
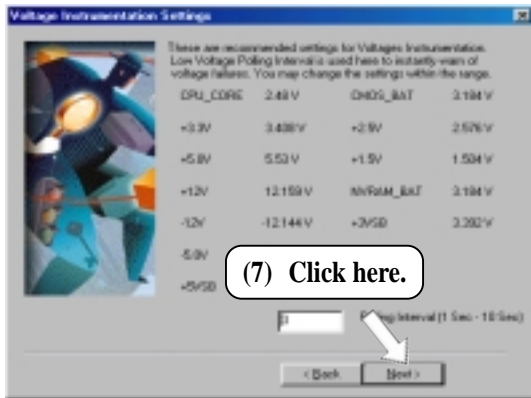
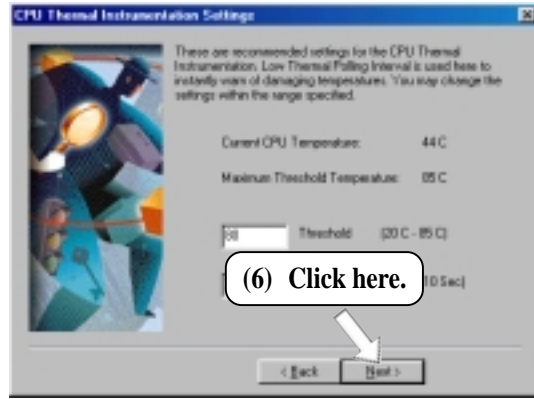
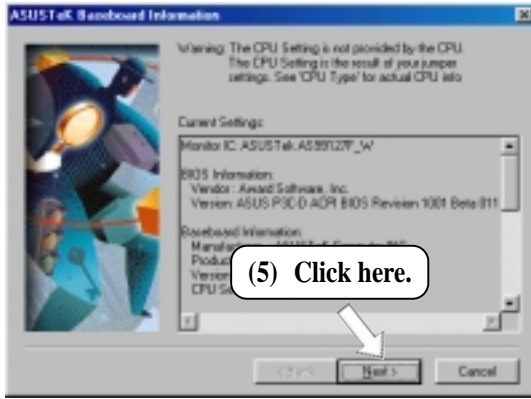

**NOTE:** This warning appears only if you don't have the Acrobat Reader installed. See 5.14 *Adobe Acrobat Reader Vx.x* on how to install the Acrobat Reader.

# 5. SOFTWARE SETUP

## 5.8 ASUS BIOS Flash Utility for LDCM 6.0

Insert the Support CD that came with your motherboard into your CD-ROM drive or double-click the CD drive icon in **My Computer** to bring up the setup screen.

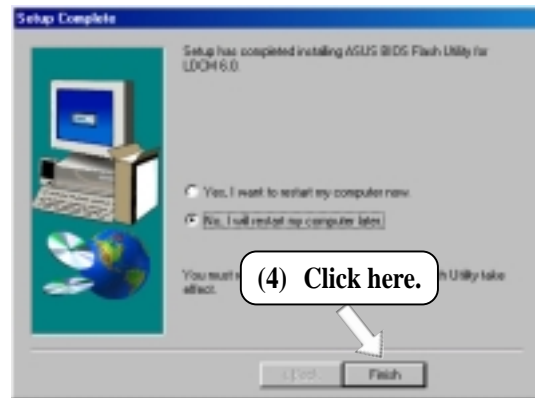
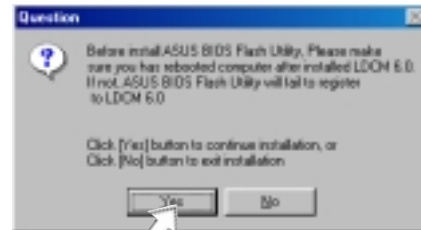



# 5. SOFTWARE SETUP

## 5.9 ASUS PC Probe Vx.xx

Insert the Support CD that came with your motherboard into your CD-ROM drive or double-click the CD drive icon in **My Computer** to bring up the setup screen.

**NOTE:** ASUS PC Probe will not run if another hardware monitoring utility is installed. To uninstall any program, see *5.16 Uninstalling Programs*.

(1) Click here.

(2) Click here.

(3) Click here.

(4) Click here.

(5) Click here.

(6) Click here.

(7) Click here.

(8) Click *Next* and when the *Setup Complete* box appears, click *Finish* to complete setup.

5. SW SETUP  
Windows 98

# 5. SOFTWARE SETUP

## 5.10 Install ASUS Update Vx.xx

Insert the Support CD that came with your motherboard into your CD-ROM drive or double-click the CD drive icon in **My Computer** to bring up the setup screen.

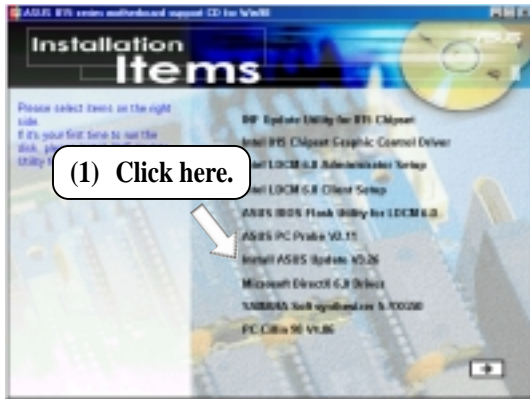

# 5. SOFTWARE SETUP

## 5.11 Microsoft DirectX 6.0 Driver

Insert the Support CD that came with your motherboard into your CD-ROM drive or double-click the CD drive icon in **My Computer** to bring up the setup screen.

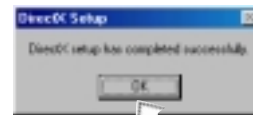
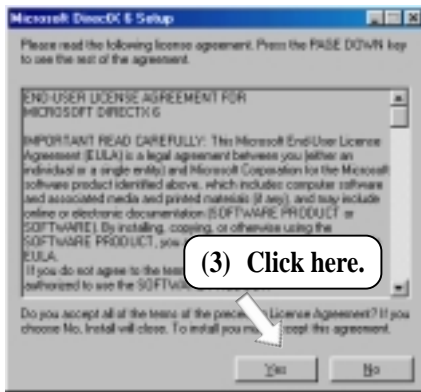

# 5. SOFTWARE SETUP

## 5.12 YAMAHA SoftSynthesizer S-YXG50

Insert the Support CD that came with your motherboard into your CD-ROM drive or double-click the CD drive icon in **My Computer** to bring up the setup screen.

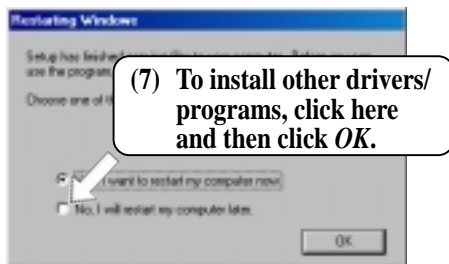
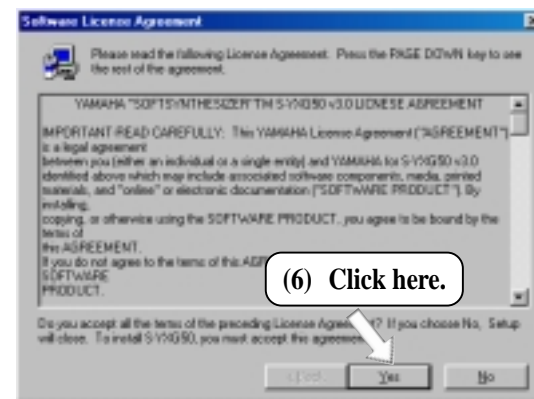
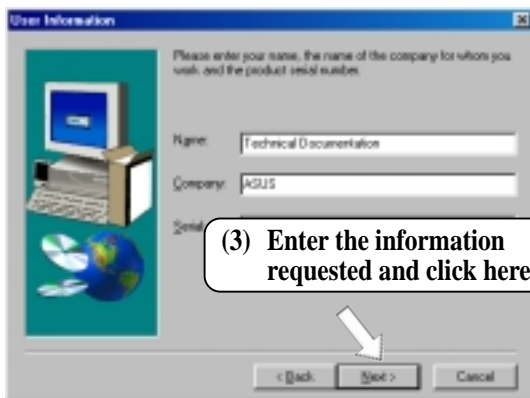

# 5. SOFTWARE SETUP

## 5.13 PC-Cillin 98 Vx.xx

Insert the Support CD that came with your motherboard into your CD-ROM drive or double-click the CD drive icon in **My Computer** to bring up the setup screen.

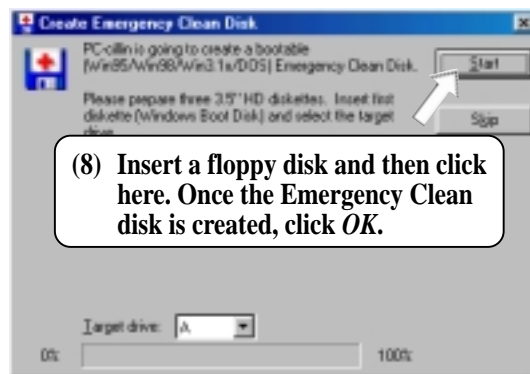
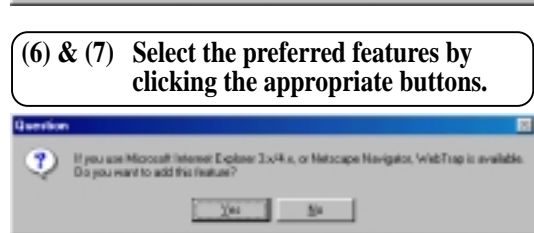
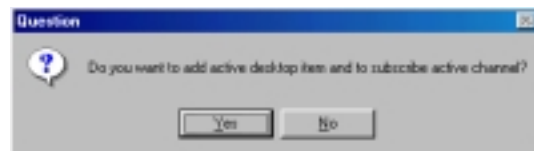
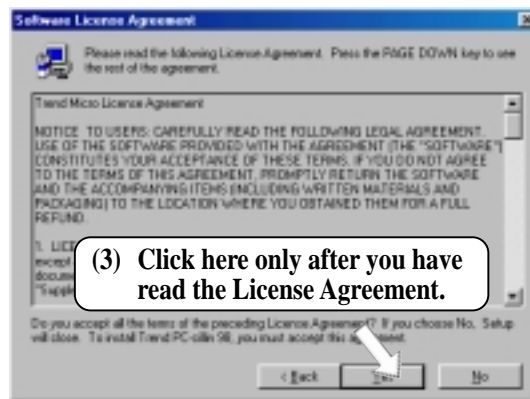

5. SW SETUP  
Windows 98

# 5. SOFTWARE SETUP

## 5.14 Adobe Acrobat Reader Vx.x

Insert the Support CD that came with your motherboard into your CD-ROM drive or double-click the CD drive icon in **My Computer** to bring up the setup screen.

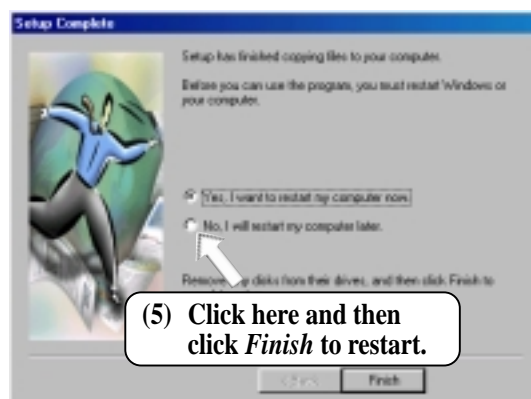
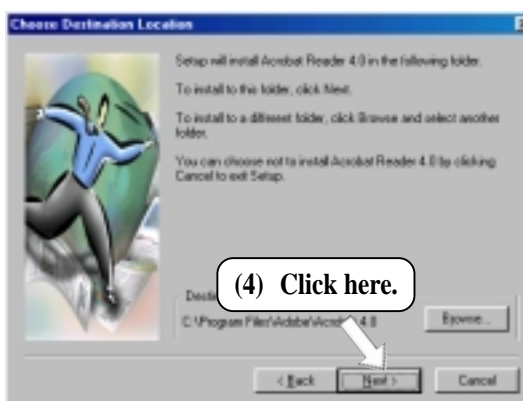
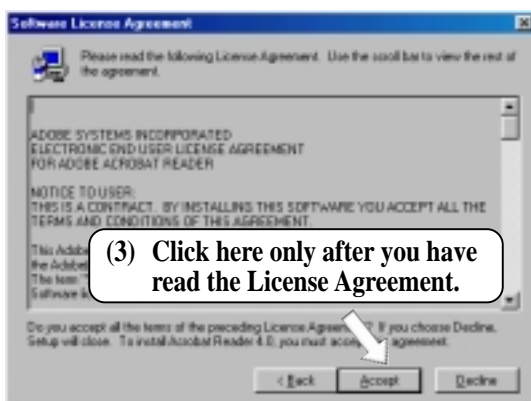

# 5. SOFTWARE SETUP

## 5.15 Cyberlink Video and Audio Applications

### 5.15.1 System Requirements

- Pentium-100MHz PC compatible
- Microsoft Windows 95/98/NT/2000
- Hard disk drive with at least 10MB of free space
- 4x speed or above CD-ROM drive
- Sound card with a Windows wave audio driver
- 256 (or above) color VGA card is required. A VGA card with DirectDraw support
- 8MB system memory

### 5.15.2 Cyberlink Contact Information



The image shows a software installation screen for CyberLink. At the top, it says "Your Gateway to Video & Audio Software Applications". On the left, there is a graphic of a window with a glowing blue swirl. The right side of the screen lists contact information for CyberLink Corp., CyberLink USA, and CyberLink Japan. At the bottom left is the website "www.cyberlink.com.tw" with a globe icon. At the bottom right are two buttons: "MainMenu" and "Exit".

**Your Gateway to Video & Audio Software Applications**

**CyberLink Corp.**  
Phone: 886-2-8667-1298  
Fax: 886-2-8667-1300  
E-Mail: [service@cyberlink.com.tw](mailto:service@cyberlink.com.tw)  
WWW: <http://www.cyberlink.com.tw>

**CyberLink USA**  
Phone: 510-668-0118  
Fax: 510-668-0121  
WWW: <http://www.cyberlink-usa.com>

**CyberLink Japan**  
Phone: +84-3-3662-8005  
Fax: +81-3-3662-8009  
WWW: <http://www.cli.co.jp>

[www.cyberlink.com.tw](http://www.cyberlink.com.tw)

# 5. SOFTWARE SETUP

## 5.15.3 Installation Procedures

Insert the Support CD that came with your motherboard into your CD-ROM drive or double-click the CD drive icon in **My Computer** to bring up the setup screen.

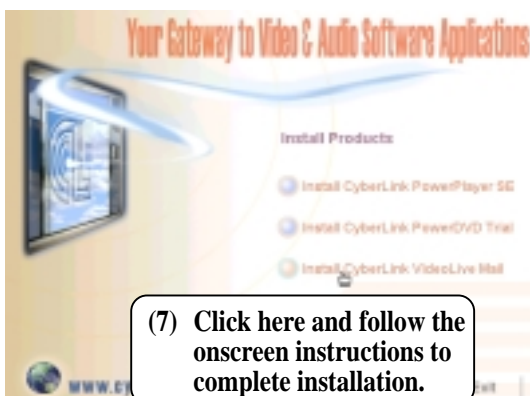
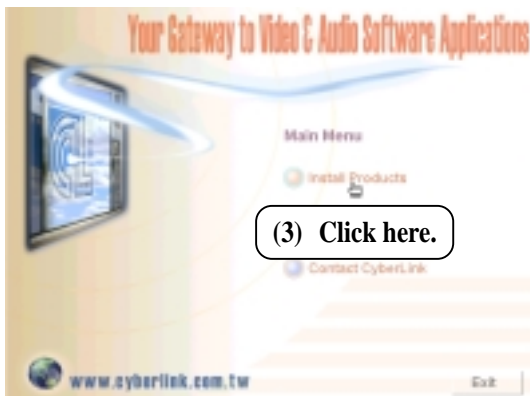



# 5. SOFTWARE SETUP

## 5.16 Uninstalling Programs

Add/Remove Programs is a basic component within Windows. You may use this function if a program does not provide its own uninstallation program.

**(1) Double-click here to open the Add/Remove Programs Properties dialog box.**

**(2) Select the program to remove and click Add/Remove.**

**(3) Click here.**

**5. SW SETUP**  
Windows 98

# 5. SOFTWARE SETUP

---

(This page was intentionally left blank.)

# 6. SOFTWARE REFERENCE

## 6.1 Display Properties

The motherboard's built-in 2D/3D AGP VGA supports professional graphics design, gaming, learning, and business applications.

**NOTE:** Depending on your system configuration, components, and options, your system may not show all of the settings displayed in the following pictures.

To open the Properties dialog box, right-click the desktop and select **Properties**, the **Settings** tab, and then the **Advanced** button.

### General

The **Display** box displays the current font size of the selected monitor. To use a different font size, click the arrow, and then click the font size you want.

The **Compatibility** box allows you to specify when to apply changes to system color settings. **NOTE:** Some programs might not display colors correctly without being restarted after you make changes. To avoid this problem, close the program, change the color settings, and then open the program again.

### Adapter

Shows what type of display adapter you are currently using. To install the software for a new display adapter, click **Change**.

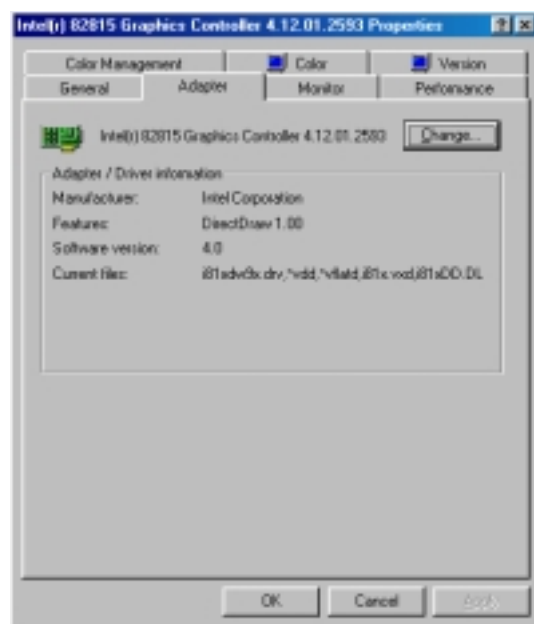
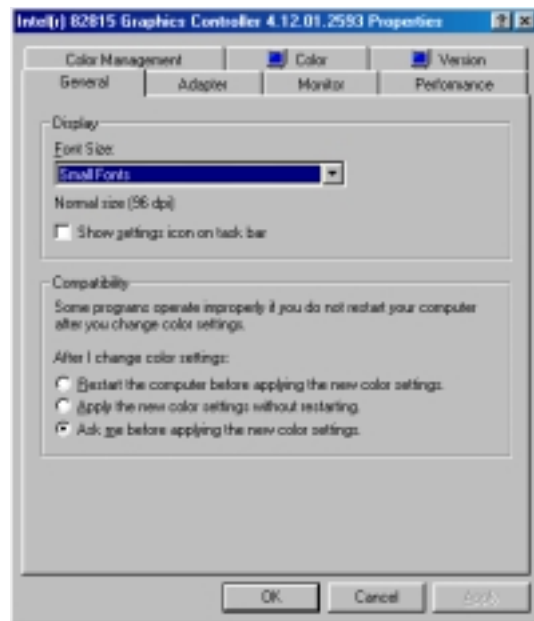

# 6. SOFTWARE REFERENCE

## Monitor

Shows what type of monitor you are currently using. To install the software for a new monitor, click **Change**.

## Performance

Specifies the degree of acceleration you want for your graphics hardware. Full acceleration is the fastest and is recommended for most computers. If your computer is having problems and you suspect graphics acceleration to be the cause, use the highest setting at which you do not have problems.

## Color Management

Lists all the color profile currently associated with your monitor. Click a profile to make it the active profile. Otherwise, the default profile is the active profile.

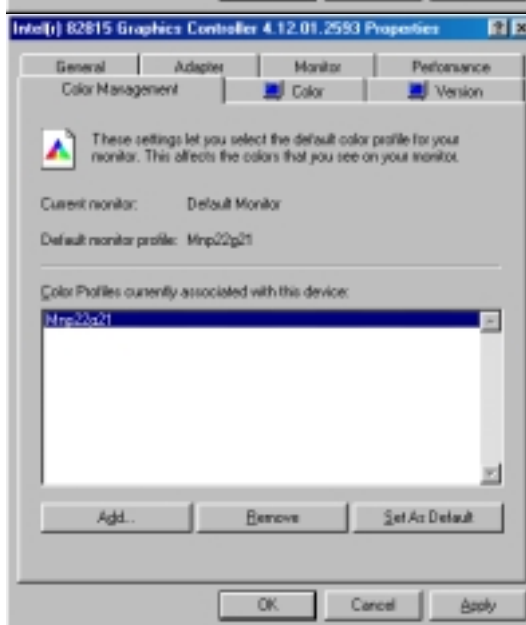
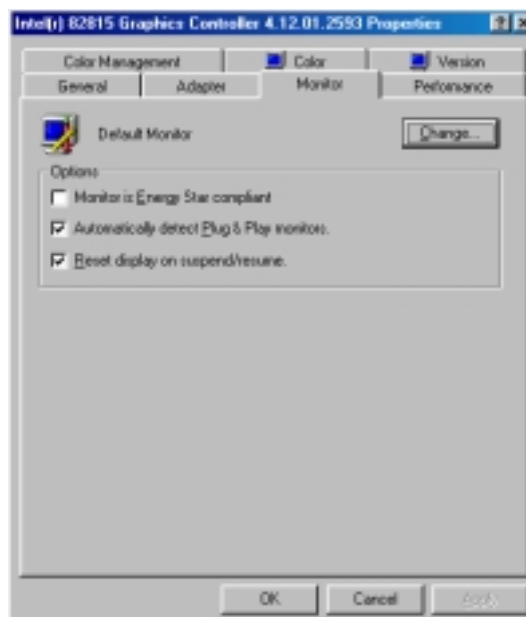

## 6. SOFTWARE REFERENCE

### *Color*

Allows you to adjust the quality of your display according to your preference. Gamma correction is available only in 16-bit color and 24-bit color (true color, 16.7M-color) modes. In 16-color and 8-bit color (standard color, 256-color) modes, the gamma correction function is not supported.

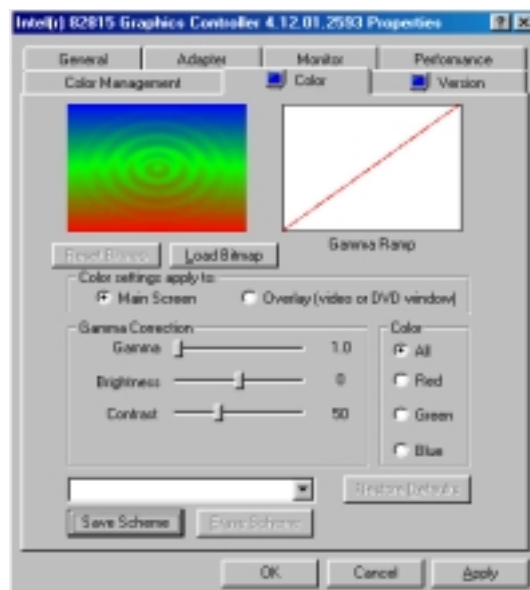

### *Version*

Gives information on your graphics device such as chipset, memory, BIOS, and drivers. Internet links are also available for easy access to the ASUS Web page for new updated drivers and notices.



## 6. SOFTWARE REFERENCE

### 6.2 ASUS PC Probe

ASUS PC Probe is a convenient utility to continuously monitor your computer system's vital components, such as fan rotations, Voltages, and temperatures. It also has a utility that lets you review useful information about your computer, such as hard disk space, memory usage, and CPU type, CPU speed, and internal/external frequencies through the DMI Explorer.

#### 6.2.1 Starting ASUS PC Probe

When ASUS PC Probe starts, a splash screen appears allowing you to select whether or not to show the screen the next time you open PC Probe. To bypass this startup screen, clear the **Show up in next execution** check box.

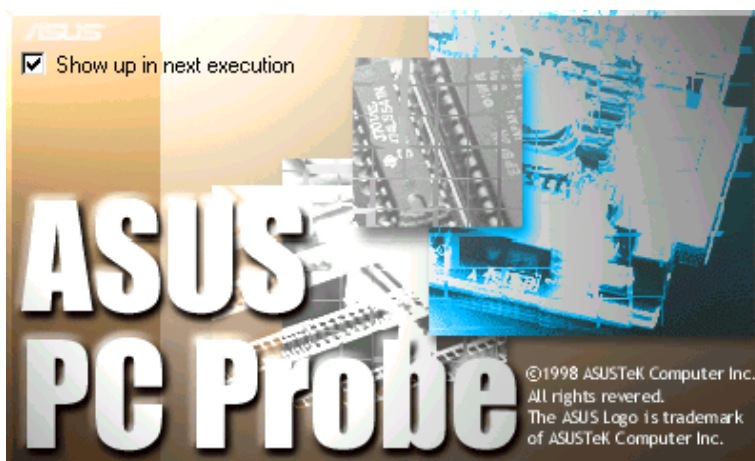

To start **ASUS PC Probe**, click the Windows **Start** button, point to **Programs**, and then **ASUS Utility**, and then click **Probe Vx.xx**.

The PC Probe icon  will appear on the taskbar's system tray indicating that ASUS PC Probe is running. Clicking the icon will allow you to see the status of your PC.



# 6. SOFTWARE REFERENCE

## 6.2.2 Using ASUS PC Probe

### Monitoring

#### Monitor Summary

Shows a summary of the items being monitored.



#### Temperature Monitor

Shows the PC's temperature.

Temperature Warning threshold adjustment  
(Move the slider up to increase the threshold level or down to decrease the threshold level)



#### Fan Monitor

Shows the PC's fan rotation.

Fan Warning threshold adjustment  
(Move the slider up to increase the threshold level or down to decrease the threshold level)

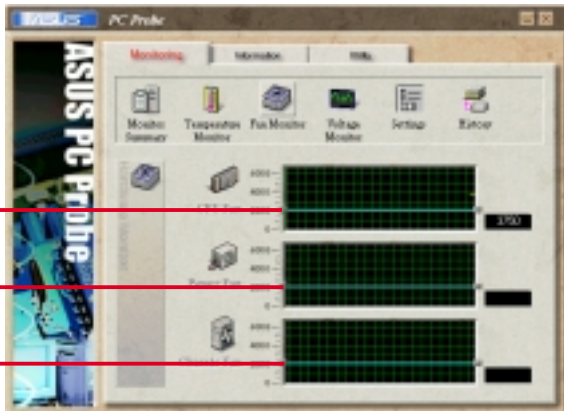

#### Voltage Monitor

Shows the PC's voltages.



# 6. SOFTWARE REFERENCE

## Settings

Lets you set threshold levels and polling intervals or refresh times of the PC's temperature, fan rotation, and voltages.



## CPU Cooling System Setup

Lets you select when to enable software CPU cooling. When **When CPU Overheated** is selected, the CPU cooling system is enabled whenever the CPU temperature reaches the threshold value.



## History

Lets you record the current monitoring activity of a certain component of your PC for future reference.



## Information

### Hard Drives

Shows the used and free space of the PC's hard disk drives and the file allocation table or file system used.





# 6. SOFTWARE REFERENCE

## Memory

Shows the PC's memory load, memory usage, and paging file usage.



## Device Summary

Shows a summary of devices in your PC.



## DMI Explorer

Shows information pertinent to the PC, such as CPU type, CPU speed, and internal/external frequencies, and memory size.



## Utility

Lets you run programs outside of the ASUS Probe modules. To run a program, click **Execute Program**.



## 6. SOFTWARE REFERENCE

---

### 6.2.3 ASUS PC Probe Task Bar Icon

Right-clicking the PC Probe icon will bring up a menu to open or exit ASUS PC Probe and pause or resume all system monitoring.



When the ASUS PC Probe senses a problem with your PC, portions of the ASUS PC Probe icon changes to red, the PC speaker beeps, and the ASUS PC Probe monitor is displayed.

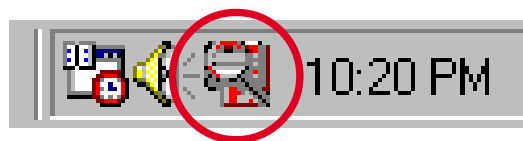

# 6. SOFTWARE REFERENCE

## 6.3 ASUS LiveUpdate

ASUS LiveUpdate is a utility that allows you to update your motherboard's BIOS and drivers. The use of this utility requires that you are properly connected to the Internet through an Internet Service Provider (ISP).

### 1. Start ASUS Update.

Launch the utility from **Start | Programs | ASUS Utility | ASUS LiveUpdate**.

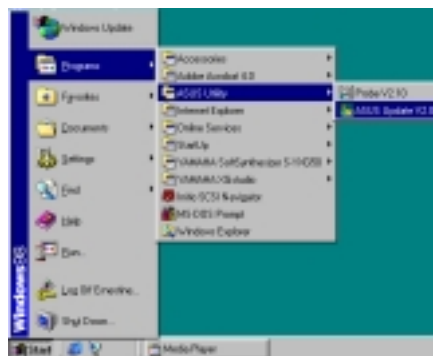

### 2. Select an update method.



### 3. If you selected updating/downloading from the Internet, you will need to select an Internet site. Choose the site that is closest to you or click **Auto Select**.



If you selected **Update from a file**, you will be prompted to locate the file.



# 6. SOFTWARE REFERENCE

## 6.4 YAMAHA XGPlayer

The XGplayer is an application that is used to playback multimedia files. The XGplayer allows playback of MIDI files (.mid, .rmi), audio files (.wav, .mp3), movie files (.avi, .mpg) and audio CDs all from a single application. With MIDI files, you can mix, arrange (change voices/effects) and attach MIDI files to e-mails. Also, its links to various Internet services allows you to listen to music on web sites or purchase music easily.

### 6.4.1 Using YAMAHA XGPlayer

To start the YAMAHA XGPlayer, click **Start**, point to **Programs**, point to **YAMAHA SoftSynthesizer S-YXG50**, and then click **XGPlayer**. You may also right-click the XGPlayer icon on the taskbar to start YAMAHA XGPlayer.

### 6.4.2 YAMAHA XGstudio Player Control Panel

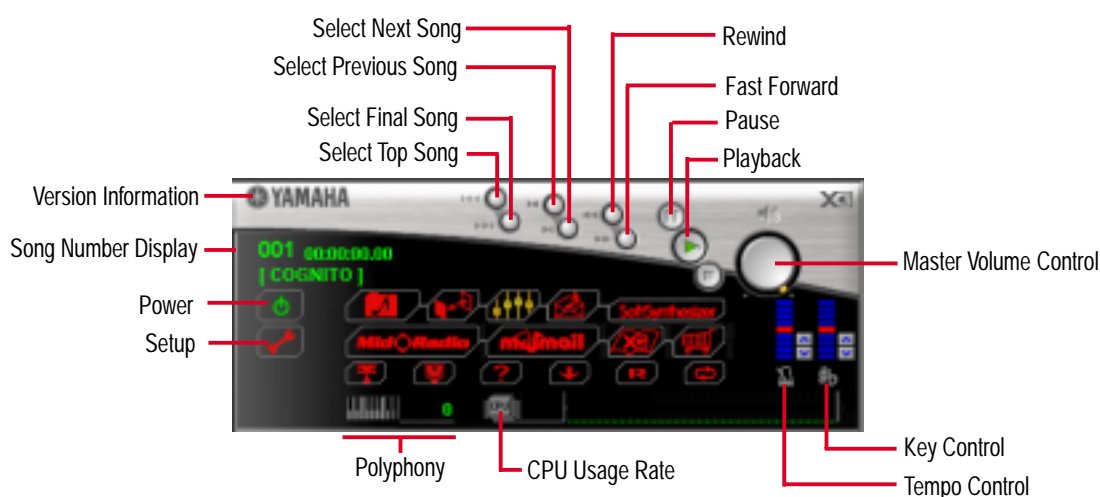

### 6.4.3 YAMAHA XGstudio Mixer Control Panel

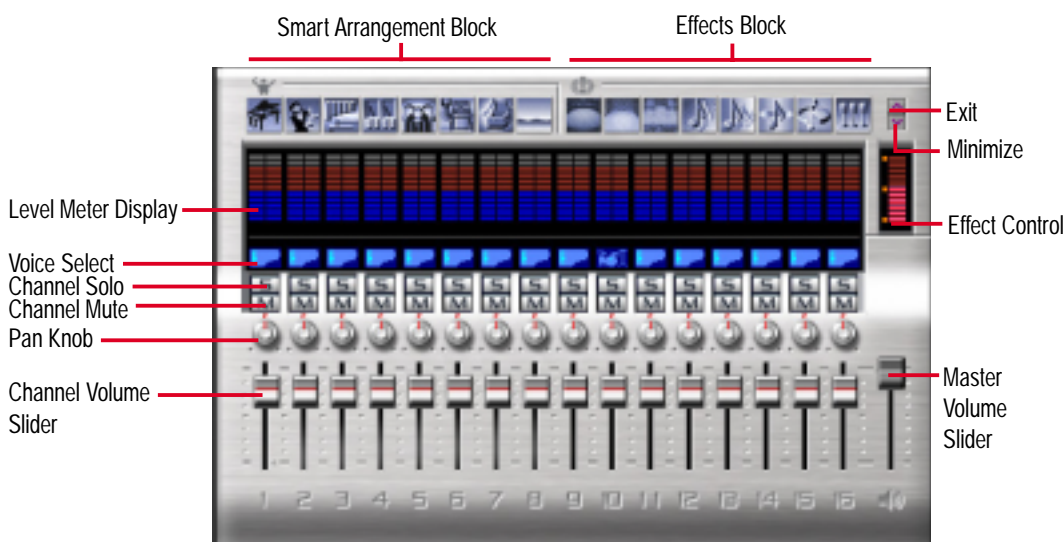

# 6. SOFTWARE REFERENCE

## 6.5 CyberLink PowerPlayer SE

CyberLink PowerPlayer SE is an intelligent software player that can automatically detect and playback all kinds of video/audio files, CD and MP3 files as well. This is the only software you need for all types of video and audio files. No need to waste time identifying your file types.

### 6.5.1 Starting CyberLink PowerPlayer SE

To start **CyberLink Power Player**, click the Windows **Start** button, point to **Programs**, and then **CyberLink PowerPlayer SE**, and then click **PowerPlayer**.

### 6.5.2 CyberLink PowerPlayer Control Panel

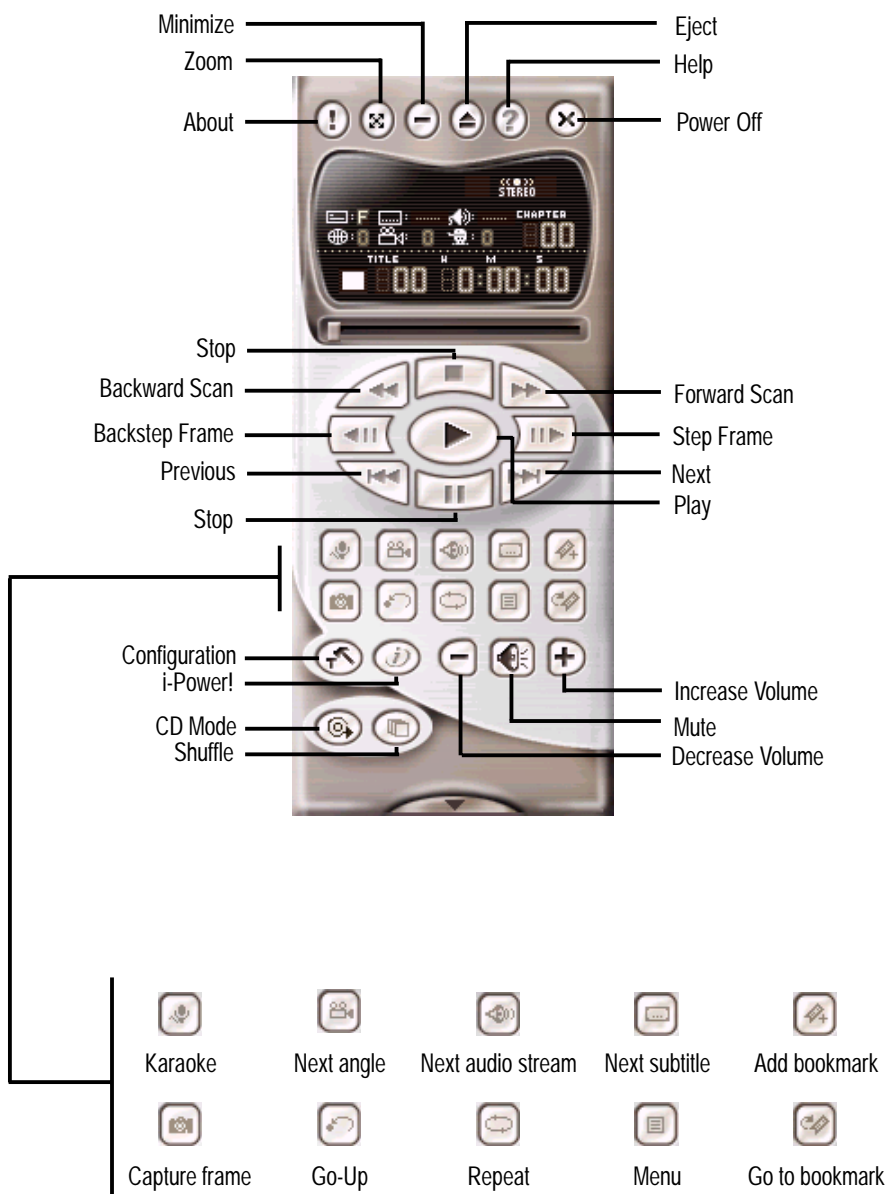

## 6. SOFTWARE REFERENCE

### 6.6 CyberLink PowerDVD

CyberLink PowerDVD is the flagship of CyberLink's complete range of video and audio software products. It features unrivaled functions allowing users to view high quality video and media-rich DVD contents on the personal computer. With the i-Power Internet Enabling feature, PowerDVD opens DVD enthusiasts to on-line DVD resources via the PowerDVD Desktop Portal Page.

#### 6.6.1 Starting CyberLink PowerDVD

To start **CyberLink PowerDVD**, click the Windows **Start** button, point to **Programs**, and then **CyberLink PowerDVD**, and then click **PowerDVD**.

#### 6.6.2 CyberLink PowerDVD User Interface

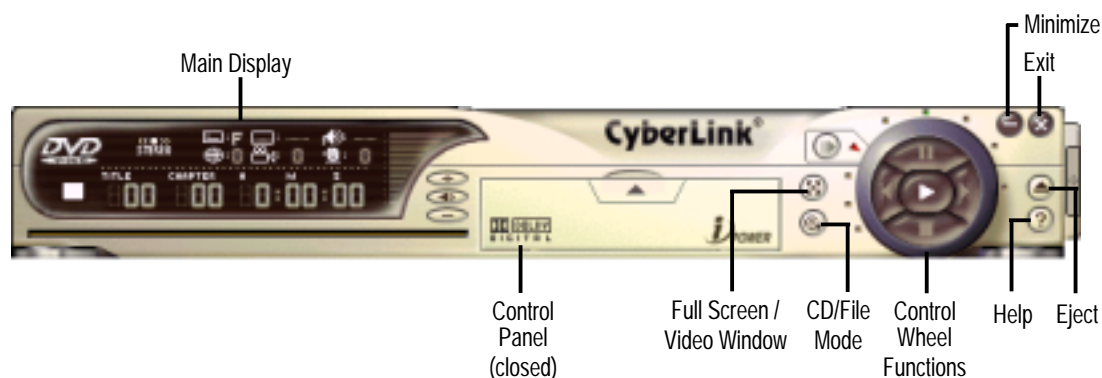

## 6. SOFTWARE REFERENCE

---

### 6.7 CyberLink VideoLive Mail

CyberLink's VideoLive Mail Plus Ver 3.0 (a.k.a. VLM 3) is a convenient and excellent way to create professional quality video mails from PC video/audio input devices and to send the mails to any recipients via VLM 3's built-in e-mail system through the Internet. VLM 3's mails comprise video, sound, or snapshot information; and thus may convey the most profound information to target audiences. It is very convenient for mail recipients who do not need to install additional software component in order to view VLM 3 mails.

VLM 3 works as a very applicant sales tool. It efficiently delivers profound and live product information to your target customers without costing a fortune. VLM 3 also helps corporate managers easily give vivid speeches and broadcast through corporate E-mail system. For personal or home users, VLM 3 easily records live video clips allowing users to send them to friends or family members across the Internet.

VLM 3 loads video messages from PC cameras, digital camcorders, analog camcorder via video capture cards, or from an existing AVI video clips, and captures audio messages from PC microphones. Video and audio messages are encoded at a very high compressed rate in a real-time mode. From data input, data conversion, to sending video mails via Internet, or saving data to disks, the whole procedure is done in an easy and continuous process.

VLM 3's video clip compression rate is up to 1:900, and its playback rate is up to 30 frame per second. VLM 3 provides CIF (352 x 288 pixel) display resolution, and support true color configuration. A one-minute video mail with QCIF (176 x 144) resolution takes up less than 500KB of memory, making it easy to transmit and save mail. Users may always adjust resolution and recording parameters for different purpose.

VLM 3 supports all the hardware devices that are compliant with Video for Windows standard. Video for Windows is a well-accepted and well-tested standard. Thus, users do not have to worry about compatibility issues.

## 6. SOFTWARE REFERENCE

### 6.7.1 Starting VideoLive Mail

To start **VideoLive Mail**, click the Windows **Start** button, point to **Programs**, and then **CyberLink VideoLive Mail**, and then click **VideoLive Mail x.x**. VLM 3's Setup Wizard will start and guide you through configuring the video and audio input peripherals and to setup the e-mail environment.

1. Setup Wizard first will prompt a dialog to confirm that you want to configure the hardware and E-mail setting. Click **Yes** to continue the system parameter configuration.
2. The e-mail configuration screen appears. You will need to enter your name and the e-mail address. Click **Next** to continue.
3. The Internet e-mail configuration screen appears. You may choose to use the VLM 3 built-in E-mail functionality (SMTP mail), or use MAPI compliant e-mail system. Consult your ISP or MIS staff for the E-mail server IP address if you are not sure. Click **Next** to continue.
4. Then the Video Configuration screen shows up. You may have to specify the video driver for VLM 3, if there are several video-input devices installed. Then configure the number of video frames to be captured per second. Note that the more frames you choose, the bigger the file size will be. Click **Next** to continue.
5. Then the Setup Wizard will then search for the GSM CODECS module for audio compression, and prompt you with the result. Click **Next** to continue.
6. Setup Wizard then tests the audio volume during playing and recording. Click **Next** when ready.
7. Configuration done. Click **Finish** to complete the environmental setting procedure.

### 6.7.2 CyberLink VideoLive Mail User Interface





# 7. APPENDIX

## 7.1 PCI-L101 Fast Ethernet Card

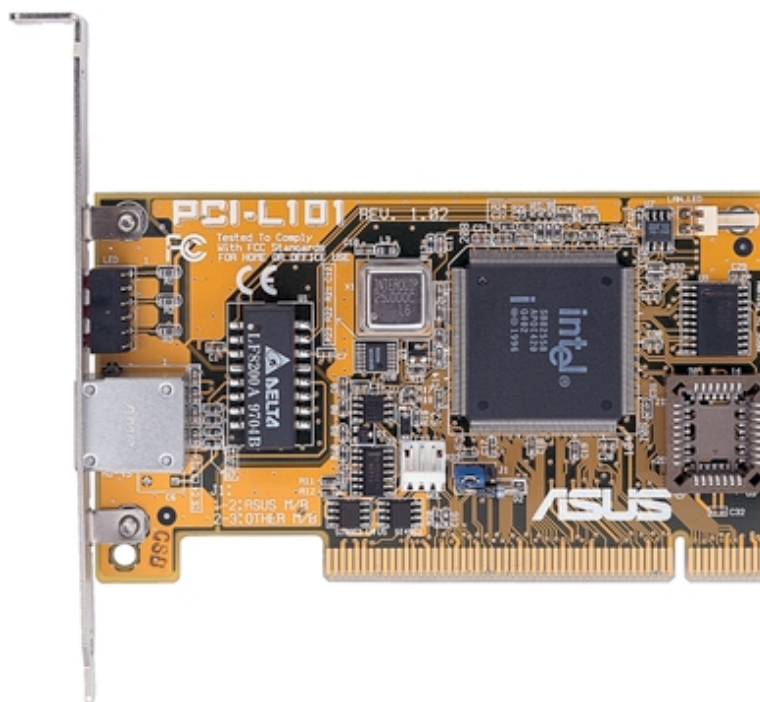

7. APPENDIX  
ASUS LAN Card

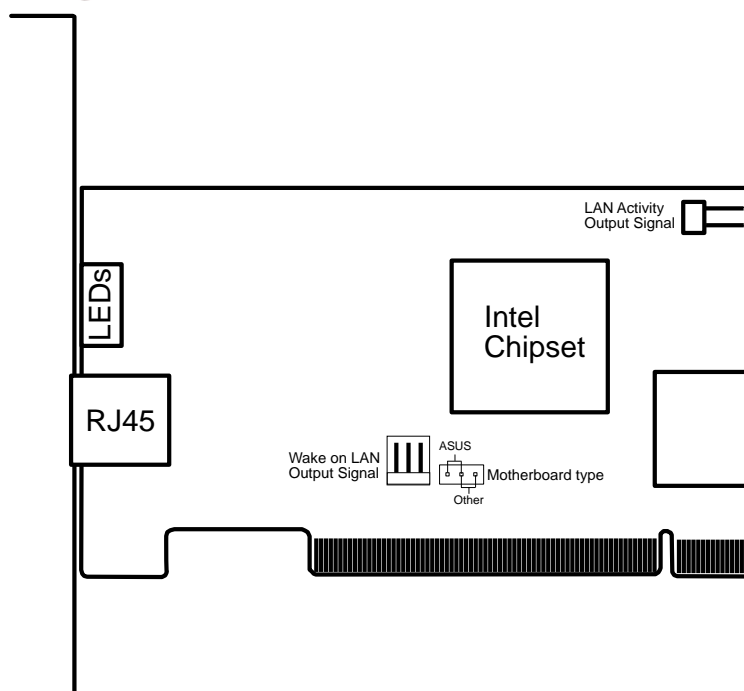

If you are using the ASUS PCI-L101 on an ASUS motherboard, leave the jumper on its default setting of “ASUS.” If you are using another brand of motherboard, set the jumper to “Other.” Connect the Wake on LAN (WOL) output signal to the motherboard’s WOL\_CON in order to utilize the wake on LAN feature of the motherboard. Connect the LAN activity output signal (LAN\_LED) to the system cabinet’s front panel LAN\_LED in order to display the LAN data activity.

# 7. APPENDIX

---

## 7.1.1 Features

- Intel 82558 Ethernet LAN Controller (Fully integrated 10BASE-T/100BASE-TX)
- Wake-On-LAN Remote Control Function Supported
- PCI Bus Master Complies to PCI Local Bus Rev. 2.1 specifications
- Consists of MAC & PHY (10/100Mbps) interfaces
- Complies to IEEE 802.3 10BASE-T and IEEE 802.3u 100BASE-TX interfaces
- Fully supports 10BASE-T & 100BASE-TX operations through a single RJ45 port
- Supports 32-bit Bus Master Technology / PCI Rev. 2.1
- Enhancements on ACPI & APM
- Adheres to PCI Bus Power Management Interface Rev. 1.0, ACPI Rev. 1.0, and Device Class Power Management Rev. 1.0
- IEEE 802.3u auto-negotiation for 10Mbps/100Mbps Network Data Transfer Rates.
- Provides LED indicators for monitoring network conditions
- Plug and Play

## 7.1.2 Software Driver Support

- **NetWare ODI Drivers** - Novell Netware 3.x, 4.x, DOS, OS/2 Client
- **NDIS 2.01 Drivers** - Microsoft LAN Manager, Microsoft Windows 3.11, IBM LAN Server
- **NDIS 3.0 Drivers** - Microsoft Windows NT, Microsoft Windows 95, Microsoft Windows 3.11

## 7.1.3 Question and Answer

Q: What is Wake-On-LAN ?

A: The Wake-On-LAN feature provides the capability to remotely power on systems supporting Wake-On-LAN by simply sending a wake-up frame. With this feature, remotely uploading/downloading data to/from systems during off-peak hours will be feasible.

Q: What can Wake-On-LAN do for you ?

A: Wake-On-LAN is a remote management tool with advantages that can reduce system management workload, provide flexibility to the system administrator's job, and then of course save you time-consuming efforts and costs.

Q: What components does Wake-On-LAN require to be enable?

A: To enable Wake-On-LAN function, your system requires Ethernet LAN adapter card that can activate Wake-On-LAN function, a client with Wake-On-LAN capability, and software such as LDCM Rev. 3.10 or up that can trigger wake-up frame.

# 7. APPENDIX

## 7.2 Glossary

### 1394

1394 is the IEEE designation for the high performance serial bus at 12.5, 25 or 50MBytes/sec speeds. This serial bus defines both a back plane physical layer and a point-to-point cable-connected virtual bus. The primary application of the cable version is the integration of I/O connectivity at the back panel of personal computers using a low-cost, scalable, high-speed serial interface. The 1394 standard also provides new services such as live connect/disconnect capability for external devices including disk drives, printers and hand-held peripherals such as scanners and cameras. This is a new standard to complement the slower USB interface and to compete with the more expensive SCSI interface.

### AC97 (Audio Codec '97)

AC '97 is the next step in enabling PCs with audio quality comparable to consumer electronics devices. The specification defines new cost-effective options to help integrate the components necessary to support next-generation auto-intensive PC applications such as DVD, 3-D multiplayer gaming and interactive music. The specification also defines new extensions supporting modem and docking to help both desktop and mobile manufacturers adopt these new technologies more quickly and cost-effectively. This specification uses software emulation to compete with the PCI SoundBlaster specification.

### ACPI (Advanced Configuration and Power Interface)

The ACPI specification defines a cross-platform interface designed to support many operating systems. ACPI defines a flexible and abstract hardware interface that provides a standard way to integrate power management features throughout a PC system, including hardware, operating system and application software. This enables the system to automatically turn ON and OFF peripherals such as CD-ROMs, network cards, hard disk drives, and printers, as well as consumer devices connected to the PC such as VCRs, TVs, phones, and stereos. With this technology, peripherals will also be able to activate the PC. For example, inserting a tape into a VCR can turn on the PC, which could then activate a large-screen TV and high-fidelity sound system.

### AGP (Accelerated Graphics Port)

An interface specification that enables high-performance 3D graphics on mainstream PCs. AGP was designed to offer the necessary bandwidth and latency to perform texture mapping directly from system memory.

Bus	Bus Frequency	Bandwidth	Data Transfer Rate
PCI	33MHz	33MHz	133MByte/sec
AGP 1X	66MHz	66MHz	266MByte/sec
AGP 2X	66MHz	133MHz	512MByte/sec
AGP 4X	66MHz	266MHz	1024MByte/sec

### BIOS (Basic Input/Output System)

BIOS is a set of routines that affect how the computer transfers data between computer components, such as memory, disks, and the display adapter. The BIOS instructions are built into the computer's read-only memory. BIOS parameters can be configured by the user through the BIOS Setup program. The BIOS can be updated using the provided utility to copy a new BIOS file into the EEPROM.

### Bit (Binary Digit)

Represents the smallest unit of data used by the computer. A bit can have one of two values: 0 or 1.

# 7. APPENDIX

---

## **Boot**

Boot means to start the computer operating system by loading it into system memory. When the manual instructs you to “boot” your system (or computer), it means to turn ON your computer. “Reboot” means to restart your computer. When using Windows 95 or later, selecting “Restart” from “Start | Shut Down...” will reboot your computer.

## **Bus Master IDE**

PIO (Programmable I/O) IDE requires that the CPU be involved in IDE access and waiting for mechanical events. Bus master IDE transfers data to/from the memory without interrupting the CPU. Bus master IDE driver and bus master IDE hard disk drives are required to support bus master IDE mode.

## **Byte (Binary Term)**

One byte is a group of eight contiguous bits. A byte is used to represent a single alphanumeric character, punctuation mark, or other symbol.

## **COM Port**

COM is a logical device name used by to designate the computer serial ports. Pointing devices, modems, and infrared modules can be connected to COM ports. Each COM port is configured to use a different IRQ and address assignment.

## **Concurrent PCI**

Concurrent PCI maximizes system performance with simultaneous CPU, PCI and ISA bus activities. It includes multi-transaction timing, enhanced write performance, a passive release mechanism and support for PCI 2.1 compliant delayed transactions. Concurrent PCI provides increased bandwidth, reduced system latencies, improves video and audio performance, and improves processing of host based applications.

## **CPU (Central Processing Unit)**

The CPU, sometimes called “Processor,” actually functions as the “brain” of the computer. It interprets and executes program commands and processes data stored in memory. Currently, there are socket 370 (for Pentium III FC-PGA and Celeron-PPGA), socket 7 (for Pentium, AMD, Cyrix, IBM), slot 1 (for Pentium II and III), slot 2 (for Xeon), and slot A (for AMD) processors.

## **Device Driver**

A device driver is a special set of instructions that allows the computer’s operating system to communicate with devices such as VGA, audio, printer, or modem.

## **DOS (Disk Operating System)**

DOS is the foundation on which all other programs and software applications operate, including Windows. DOS is responsible for allocating system resources such as memory, CPU time, disk space, and access to peripheral devices. For this reason, DOS constitutes the basic interface between you and your computer.

## **DRAM (Dynamic Random Access Memory)**

There are several different types of DRAM such as, EDO DRAM (Extended Data Output DRAM), SDRAM (Synchronous DRAM), and RDRAM (Rambus DRAM).

## **Flash ROM**

The flash ROM is designed to be a resident program and can be updated by a specific programming method. Normally, the flash ROM is used for system BIOS which initiates hardware devices and sets up necessary parameters for the OS. Since the contents of flash ROM can be modified, users are able to update the BIOS by themselves.

## **IDE (Integrated Drive Electronics)**

IDE devices integrate the drive control circuitry directly on the drive itself, eliminating the need for a separate adapter card (in the case for SCSI devices). UltraDMA/33 IDE devices can achieve up to 33MB/Sec transfer.

# 7. APPENDIX

---

## **LPT Port (Line Printer Port)**

Logical device name reserved by DOS for the computer parallel ports. Each LPT port is configured to use a different IRQ and address assignment.

## **MMX**

A set of 57 new instructions based on a technique called Single Instruction, Multiple Data (SIMD), which is built into the new Intel Pentium PP/MT (P55C) and Pentium II (Klamath) CPU as well as other x86-compatible microprocessors. The MMX instructions are designed to accelerate multimedia and communications applications, such as 3D video, 3D sound, video conference.

## **OnNow**

The OnNow design initiative is a comprehensive, system-wide approach to system and device power control. OnNow is a term for PC that is always ON but appears OFF and responds immediately to user or other requests. The OnNow design initiative involves changes that will occur in the Microsoft Windows operating system, device drivers, hardware, and applications, and also relies on the changes defined in the Advanced Configuration and Power Interface (ACPI) specification.

## **PC100**

SDRAM is Intel's goal is to ensure that memory subsystems continue to support evolving platform requirements and to assure that memory does not become a bottleneck to system performance. It is especially important to ensure that the PC memory roadmap evolves together with the performance roadmaps for the processors, I/O and graphics.

## **PCI Bus (Peripheral Component Interconnect Local Bus)**

PCI bus is a specification that defines a 32-bit data bus interface. PCI is a standard widely used by expansion card manufacturers.

## **PCI Bus Master**

The PCI Bus Master can perform data transfer without local CPU help and furthermore, the CPU can be treated as one of the Bus Masters. PCI 2.1 supports concurrent PCI operation to allow the local CPU and bus master to work simultaneously.

## **Plug and Play BIOS**

The ISA bus architecture requires the allocation of memory and I/O address, DMA channels and interrupt levels among multiple ISA cards. However, configuration of ISA cards is typically done with jumpers that change the decode maps for memory and I/O space and steer the DMA and interrupt signals to different pins on the bus. Further, system configuration files may need to be updated to reflect these changes. Users typically resolve sharing conflicts by referring to documentation provided by each manufacturer. For the average user, this configuration process can be unreliable and frustrating. Plug and play (PnP) BIOS eliminates the ISA add-on card hardware conflict problem. The PnP BIOS uses a memory block to define and remember each card's configuration, which allows the user to change the card's IRQs and DMA in BIOS either automatically or manually.

## **POST (Power On Self Test)**

When you turn ON the computer, it will first run through the POST, a series of software-controlled diagnostic tests. The POST checks system memory, the motherboard circuitry, the display, the keyboard, the diskette drive, and other I/O devices.

## **PS/2 Port**

PS/2 ports are based on IBM Micro Channel Architecture. This type of architecture transfers data through a 16-bit or 32-bit bus. A PS/2 mouse and/or keyboard may be used on ATX motherboards.

## **RDRAM (Rambus DRAM)**

Developed by Rambus, Inc., this type of memory can deliver up to 1.6GB of data per second. RDRAM is the first interface standard that can be directly implemented on high performance VLSI components such as, CMOS DRAMs, memory controllers, and graphics/video ICs.

# 7. APPENDIX

---

## **ROM (Read Only Memory)**

ROM is nonvolatile memory used to store permanent programs (called firmware) used in certain computer components. Flash ROM (or EEPROM) can be reprogrammed with new programs (or BIOS).

## **SCSI (Small Computer System Interface)**

High speed multi-threaded I/O interface defined by the X3T9.2 committee of the American National Standards Institute (ANSI) for connecting many peripheral devices. The standard started from 10MBytes/sec to 160MBytes/sec available today.

## **SDRAM (Synchronous DRAM)**

The SDRAM features a fully synchronous operation referenced to a positive edge clock whereby all operations are synchronized at a clock input which enables the coexistence of high performance and a simple user interface. SDRAM takes memory access away from the CPU's control; internal registers in the chips accept the request, and let the CPU do something else while the data requested is assembled for the next time the CPU talks to the memory. As they work on their own clock cycle, the rest of the system can be clocked faster. There is a version optimized for video cards, and main memory for motherboards.

## **SPD for SDRAM module**

Serial Presence Detect (SPD) is most like an ID detect for SDRAM module, it using a EEPROM component on DIMM module for storing module configuration information inside. The Serial Presence Detect function is implemented using a 2048 bit EEPROM component. This nonvolatile storage device contains data programmed by the DIMM manufacturer that identifies the module type and various SDRAM organization and timing parameters.

## **SSE (Streaming SIMD Extensions)**

A set of new instructions added to existing architectures that enables a better visual experience with an accelerated 3D geometry pipeline and support for new applications, such as real-time video encoding and speech recognition.

## **System Disk**

A system disk contains the core file of an operating system and is used to boot up the operating system.

## **UltraDMA**

Ultra DMA/33 is a "synchronous DMA" protocol designed by Intel. This function is included into Intel's PIIX4 chipset. The traditional IDE transfer only uses one edge of the data stroke as the data transfer. Ultra DMA/33 uses both edges of data strobe when the data is transferred. Hence, the data transfer rate is double of the PIO mode 4 or DMA mode 2 (16.6MB/s x2 = 33MB/s) on ATA-2 devices.

Ultra ATA/66, also known as Ultra DMA/66, is an extension of current Ultra ATA/33 interface. This new high-speed interface has doubled the Ultra ATA/33 burst data transfer rate to 66.6 Mbytes/sec and maximized disk performance under current PCI local bus environment

## **USB (Universal Serial Bus)**

A 4-pin serial cable bus that allows up to 127 plug and play computer peripherals such as keyboard, mouse, joystick, scanner, printer, modem, and monitor to share a bandwidth through a host scheduled token based protocol. This allows attaching or detaching while the host and other peripherals are in operation. Supports synchronous and asynchronous transfer types over the same set of wires up to 12Mbit/sec. USB 2.0 provides twice the transfer rate compared to USB 1.0 and competes with the 1394 standard.

## **Wake-On-LAN**

Computer will automatically wake-up upon receiving a wake-up packet through a Network interface when it is under power soft-off, suspend or sleep mode.

# INDEX

---

## A

- AC PWR Loss Restart 71
- Accelerated Graphics Port 29
- Accessories
  - Fast Ethernet Card 113
- Adobe Acrobat Reader
  - Installing 94
- Adobe Acrobat Reader Setup 94
- AGP 29
- Alert On LAN 63
- ASUS BIOS Flash Utility
  - Installing 88
- ASUS PC Probe
  - Installing 89
  - Setup 89
  - Using 102
- ASUS Update
  - Installing 90
  - Setup 90
- ATAPI CD-ROM 74
- Automatic Power Up 72

## B

- BIOS
  - Beep Code 43
- BIOS Beep Codes 43
- Boot Sequence 74
- Boot Up Floppy Seek 75
- Boot Up NumLock Status 56
- Boot Virus Detection 75

## C

- Central Processing Unit 26
- CHS Capacity 55
- Command Per Cycle 62
- CPU Latency Timer 62
- CyberLink
  - Contact Information 95
  - PowerDVD 110
  - PowerPlayer SE 109
  - VideoLive Mail 111

- CyberLink Contact Information 95
- CyberLink PowerDVD
  - Installing 97
  - Using 110
- CyberLink PowerPlayer SE
  - Installing 97
  - Using 109
- CyberLink VideoLive Mail
  - Installing 97
  - Using 111
- Cylinders 54

## D

- Discard Changes 77
- Display Cache Cycle Time (Tras, Trc) 63
- Display Cache Paging Mode 63
- Display Cache RAS Precharge Time 63
- Display Cache RAS to CAS Delay 63

## E

- ECP DMA Select 65
- Ethernet Card 113
- Exit Discarding Changes 76
- Exit Saving Changes 76
- Expansion Cards
  - AGP Pro 29
  - Assigning IRQs 27

## F

- Floppy 3 Mode Support 52
- Floppy Disk Access Control 64

## G

- Graphic Control Driver
  - Installing 83
- Graphics Window Size 63

# INDEX

---

## H

- Halt On 57
- Hardware Setup
  - CPU Installation 26
  - Memory Installation 25
- HDD Power Down 70
- Head 55
- High Priority PCI Mode 63

## I

- IDE Hard Drive 74
- INF Update Utility 82, 83
  - Installing 82
- Installation
  - CPU 26
- Installed Memory 57
- Installing
  - Adobe Acrobat Reader 94
  - ASUS BIOS Flash Utility 88
  - ASUS PC Probe 89
  - ASUS Update 90
  - CyberLink PowerDVD 97
  - CyberLink PowerPlayer SE 97
  - Graphic Control Driver 83
  - INF Update Utility 82
  - Intel LDCM Administrator 85
  - Intel LDCM Client 87
  - Microsoft DirectX 6.0 Driver 91
  - PC-Cillin 98 93
  - VideoLive Mail 97
  - YAMAHA SoftSynthesizer 93
- Intel LDCM Admin
  - Setup 85
- Intel LDCM Administrator
  - Installing 85
- Intel LDCM Client
  - Installing 87
  - Setup 87
- Interrupts
  - Standard Assignments 27

## L

- Language 57
- LDCM Administrator Setup 85
- LDCM Client Setup 87
- Legacy Diskette A 52
- Legacy Diskette B 52
- LiveUpdate
  - Using 107
- Load Setup Defaults 77

## M

- Maximum LBA Capacity 55
- MB Temperature 73
- Memory Installation 25
- Microsoft DirectX 6.0 Driver
  - Installing 91
- Multi-Sector Transfers 55

## O

- Onboard AC97 Modem Controller 65
- Onboard CIR I/O 65
- Onboard CIR IRQ 65
- Onboard FDC Swap A & B 64
- Onboard MIDI I/O 65
- Onboard MIDI IRQ 65
- Onboard Parallel Port 65
- Onboard PCI IDE Enable 63
- Onboard Serial Port 1 64
- Onboard Serial Port 2 64
- Onboard VGA 62
- OS/2 Onboard Memory > 64M 59
- Other Boot Device Select 74

## P

- Parallel Port Mode 65
- PC Probe
  - Using 102
- PC-Cillin 98
  - Installing 93
  - Setup 93



# INDEX

---

PCI 2.1 Support 63  
PCI Latency Timer 66  
PCI/VGA Palette Snoop 66  
PIO Mode 55  
Plug & Play O/S 75  
Power Fan Speed 73  
Power Management 69  
PowerDVD 110  
    Using 110  
PowerPlayer SE  
    Using 109  
Procedure  
    CPU Installation 26  
Procedures  
    Updating BIOS 46  
Processor Serial Number 59  
PWR Button < 4 Secs 70  
PWR Up On Modem Act 71

## Q

Quick Power On Self Test 75

## R

Removable Device 74

## S

Save Changes 77  
SDRAM  
    Cycle Time 62  
    RAS Precharge Time 62  
SDRAM CAS Latency 61  
SDRAM Configuration 61  
SDRAM Cycle Time 62  
SDRAM Cycle Time (Tras, Trc) 62  
SDRAM Page Closing Policy 62  
Sector 55  
Settings  
    Onboard Audio 20  
SMART Monitoring 55

Software Setup  
    Adobe Acrobat Reader 94  
    ASUS PC Probe 89  
    ASUS Update 90  
    Intel LDCM Admin 85  
    Intel LDCM Client 87  
    LDCM Administrator 85  
    LDCM Client 87  
    PC-Cillin 98 93  
Starting Up 43  
Supervisor Password 57  
Suspend Mode 70  
Suspend-to-RAM Capability 70  
SYMBIOS SCSI BIOS 66  
System Date 52  
System Time 52

## T

Translation Method 54  
Type 53

## U

UART2 Use Standard Infrared 64  
Ultra DMA Mode 55  
Uninstalling Programs 96  
Updating Your BIOS 45  
USB Function 67  
USB Legacy Support 59  
Using  
    LiveUpdate 107  
    PC Probe 102  
    PowerPlayer SE 109

## V

VCORE Voltage 73  
VGA BIOS Sequence 67

# INDEX

---

Video Off Method 70  
Video Off Option 70  
Video ROM BIOS Shadow 68  
VideoLive Mail 111  
    Installing 97  
    Using 111  
Voltage  
    +12 73  
    +3.3 73  
    +5 73  
    -12 73  
    -5 73  
    VCORE 73

## W

Wake On LAN 71  
Wake On PS2 KB/PS2 Mouse/CIR 72  
Wake On USB for STR State 72  
Wake Up By Keyboard 72

## Y

YAMAHA SoftSynthesizer  
    Installing 93

# ASUS® Goes Mobile!



## L8400 Series

*Compact Professional Notebook PC*

- 14.1" TFT Color Display
- 450MHz to 700MHz+
- 64MB to 192MB Memory
- 2X AGP 3D w/8MB VRAM
- 100MHz Processor Side Bus

## M8300/8200 Series

*Thin & Light Convertible Notebook PC*

- 13.3" or 12.1" TFT Color Display
- 366MHz to 650MHz+
- 64MB to 192MB Memory
- Supports Two Hard Drives



## L7300/7200 Series

*All-in-One Compact Notebook PC*

- 13.3" or 12.1" TFT Color Display
- 366MHz to 650MHz+
- 64MB to 192MB Memory



See [www.asus.com](http://www.asus.com) for updated specifications

# ASUS® Barebone Servers

	Pentium® III Pentium® II Support	Maximum Memory (GB)	Ultra2 SCSI Onboard (Channels)	5.25" Fixed Storage Devices	Hot-Swap Trays
<b>AP100</b>	1 Slot1	1	1	3	0
<b>AP200</b>	2 Slot1	1	1	3	0
<b>AP2000</b>	2 Slot1	1	1	4	3 or 5*
<b>AP3000</b>	2 Xeon™	2	2	4	3 or 5*
New! <b>AP2300</b>	2 Socket370	4	2 Ultra3	4	3 or 5*
<b>AP6000</b>	2 Slot1	1	1	4	8**
<b>AP8000</b>	2 Xeon™	2	2	4	8**
New! <b>AP6300</b>	2 Socket370	4	2 Ultra3	4	8**

\* Three 1.6-inch or five 1-inch SCA-2 SCSI hard drives

\*\* Eight 1.6-inch or 1-inch SCSI hard drives

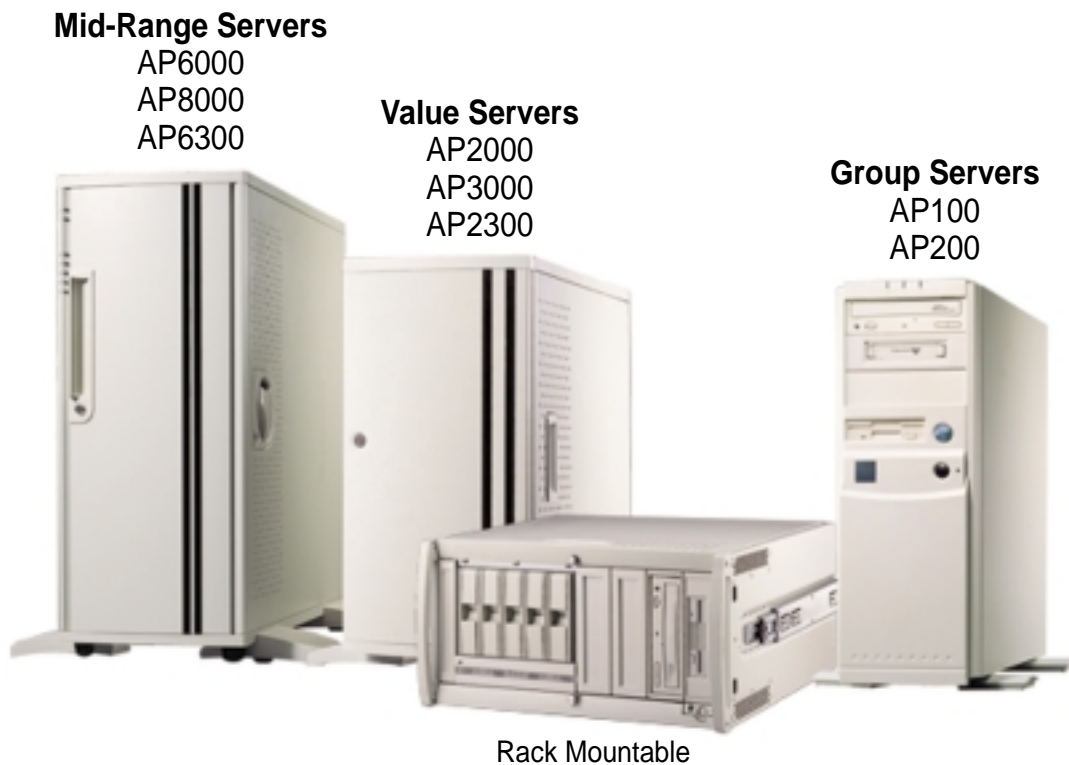

See [www.asus.com](http://www.asus.com) for updated specifications

## ASUS AR1000 RAID Sub-system with DA3000 SCSI-to-SCSI RAID Controller

- Supports 5x86 RAID processor and two 72-pin SIMM sockets for up to 128MB cache memory
- Supports three Ultra2 SCSI channels; up to 80MB/sec data transfer rate
- Supports multiple Host/Drive channel capacity
- Redundant controller capacity
- Supports non-RAID, RAID levels 0, 1, 0+1, 3, 5
- On-line failure drive rebuilding
- Automatic rebuilding — supports local/global spare drive
- On-line expansion capacity
- Supports SAF-TE (SCSI Accessed Fault-Tolerant Enclosure) feature
- Provides LCD panel and RS-232 port to configure RAID
- Ten 1.0" or six 1.6" Ultra2 SCSI SCA-2 hot-swappable drive bays
- 19" rack mountable (height: 5U)
- LED for hard disk power and working status
- Two 8cm system fans and four 6cm drive fans
- Aluminum disk arrays for easy heat dissipation
- 350W redundant power supply

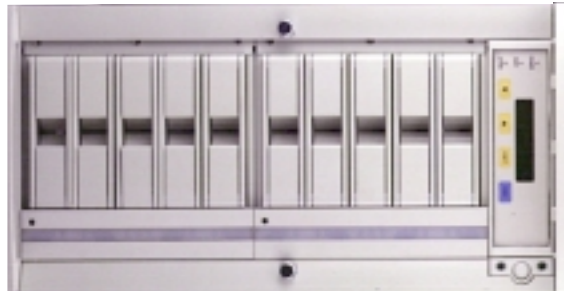

## ASUS PCI-DA2200 Series SCSI RAID Card

- PCI-DA2200 series support 5x86-133 processor
- One 72-pin SIMM socket supports up to 128MB cache memory
- RAID levels 0, 0+1, 3, 5, non-RAID
- PCI-DA2200A supports Ultra2 SCSI interface and single channel
- PCI-DA2200B supports Ultra2 SCSI interface and dual channels
- Up to 8 logical drives and 8 partitions per logical drive; number of drives for each logical drive has no limitation
- Supports both global and local spare drive operation
- Automatic bad sector reassignment
- Background rebuilding
- PCI rev. 2.1 compliant

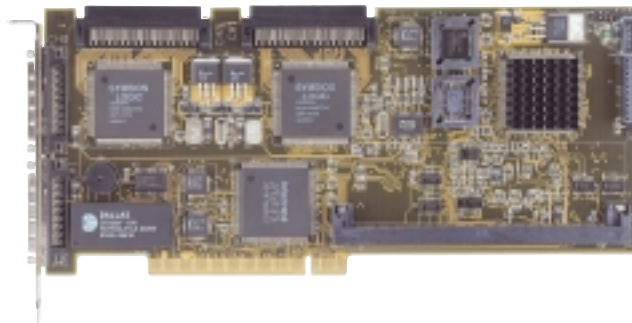

See [www.asus.com](http://www.asus.com) for updated specifications

# ASUS® 8x DVD-ROM Drive



- Industry-leading performance for even the most demanding applications
- Maximum transfer rate: 8X DVD-ROM / 40X CD-ROM
- High speed digital audio extraction
- Supports UltraDMA/33 transfer mode
- Complies with MPC3 standard
- Supports Multi-Read function

# ASUS® Ultra-Fast CD-ROM



- Supports high speed CD-Audio playback
- Supports high speed digital audio extraction
- Supports UltraDMA/33 transfer mode
- Compatible with all CD formats
- Supports multi-read function (CD-R/CD-RW)

See [www.asus.com](http://www.asus.com) for updated specifications

# AGP-V6800 Series

Span the Graphics Globe  
with DDR Intelligence



AGP 4x / 2x

Direct x 7



VR 3D Glasses

704x480

Video capture

MPEG2  
encoding

VideoSecurity

ASUS DVD  
Software player

3D Games  
Bundled

# GeForce<sup>256</sup> DDR

- Powered by the world's latest GeForce256<sup>™</sup> DDR GPU
- 300MHz DDR video memory – delivers extra performance at high resolutions with 32-bit color
- Optimized for D3D & OpenGL VR game playing and stereoscopic video/picture viewing
- Real-time 30 frames/sec 704x480 video capture
- VideoSecurity – auto-notification system to monitor environmental deviation
- Models available:
  1. AGP-V6800 : GeForce256<sup>™</sup> DDR, 32MB DDR SGRAM, VGA
  2. AGP-V6800 Deluxe : GeForce256<sup>™</sup> DDR, 32MB DDR SGRAM, VGA, TV-out, Video-in, VR 3D glasses



**ASUS**  
www.asus.com

**See [www.asus.com](http://www.asus.com) for updated specifications**