

**ASUS<sup>®</sup> CUV4X-D**

JumperFree™ PC133/VC133

133MHz FSB AGP Pro/4X

Dual Socket 370 Motherboard

**USER'S MANUAL**

# USER'S NOTICE

---

No part of this manual, including the products and software described in it, may be reproduced, transmitted, transcribed, stored in a retrieval system, or translated into any language in any form or by any means, except documentation kept by the purchaser for backup purposes, without the express written permission of ASUSTeK COMPUTER INC. ("ASUS").

ASUS PROVIDES THIS MANUAL "AS IS" WITHOUT WARRANTY OF ANY KIND, EITHER EXPRESS OR IMPLIED, INCLUDING BUT NOT LIMITED TO THE IMPLIED WARRANTIES OR CONDITIONS OF MERCHANTABILITY OR FITNESS FOR A PARTICULAR PURPOSE. IN NO EVENT SHALL ASUS, ITS DIRECTORS, OFFICERS, EMPLOYEES OR AGENTS BE LIABLE FOR ANY INDIRECT, SPECIAL, INCIDENTAL, OR CONSEQUENTIAL DAMAGES (INCLUDING DAMAGES FOR LOSS OF PROFITS, LOSS OF BUSINESS, LOSS OF USE OR DATA, INTERRUPTION OF BUSINESS AND THE LIKE), EVEN IF ASUS HAS BEEN ADVISED OF THE POSSIBILITY OF SUCH DAMAGES ARISING FROM ANY DEFECT OR ERROR IN THIS MANUAL OR PRODUCT.

Product warranty or service will not be extended if: (1) the product is repaired, modified or altered, unless such repair, modification or alteration is authorized in writing by ASUS; or (2) the serial number of the product is defaced or missing.

Products and corporate names appearing in this manual may or may not be registered trademarks or copyrights of their respective companies, and are used only for identification or explanation and to the owners' benefit, without intent to infringe.

- VIA and Apollo Pro133A are trademarks of VIA Technologies, Inc.
- Intel, LANDesk, Pentium, and Celeron are trademarks of Intel Corporation.
- IBM and OS/2 are registered trademarks of International Business Machines.
- Symbios is a registered trademark of Symbios Logic Corporation.
- Windows and MS-DOS are registered trademarks of Microsoft Corporation.
- Adobe and Acrobat are registered trademarks of Adobe Systems Incorporated.
- Trend and ChipAwayVirus are trademarks of Trend Micro, Inc.

The product name and revision number are both printed on the product itself. Manual revisions are released for each product design represented by the digit before and after the period of the manual revision number. Manual updates are represented by the third digit in the manual revision number.

For previous or updated manuals, BIOS, drivers, or product release information, contact ASUS at <http://www.asus.com.tw> or through any of the means indicated on the following page.

SPECIFICATIONS AND INFORMATION CONTAINED IN THIS MANUAL ARE FURNISHED FOR INFORMATIONAL USE ONLY, AND ARE SUBJECT TO CHANGE AT ANY TIME WITHOUT NOTICE, AND SHOULD NOT BE CONSTRUED AS A COMMITMENT BY ASUS. ASUS ASSUMES NO RESPONSIBILITY OR LIABILITY FOR ANY ERRORS OR INACCURACIES THAT MAY APPEAR IN THIS MANUAL, INCLUDING THE PRODUCTS AND SOFTWARE DESCRIBED IN IT.

**Copyright © 2000 ASUSTeK COMPUTER INC. All Rights Reserved.**

Product Name: **ASUS CUV4X-D**  
Manual Revision: **1.00 E663**  
Release Date: **December 2000**

# ASUS CONTACT INFORMATION

---

## ASUSTeK COMPUTER INC. (Asia-Pacific)

### *Marketing*

Address: 150 Li-Te Road, Peitou, Taipei, Taiwan 112  
Telephone: +886-2-2894-3447  
Fax: +886-2-2894-3449  
Email: info@asus.com.tw

### *Technical Support*

MB/Others (Tel): +886-2-2890-7121 (English)  
Notebook (Tel): +886-2-2890-7122 (English)  
Desktop/Server (Tel): +886-2-2890-7123 (English)  
Fax: +886-2-2893-7775  
Email: tsd@asus.com.tw  
WWW: www.asus.com.tw  
FTP: ftp.asus.com.tw/pub/ASUS

## ASUS COMPUTER INTERNATIONAL (America)

### *Marketing*

Address: 6737 Mowry Avenue, Mowry Business Center, Building 2  
Newark, CA 94560, USA  
Fax: +1-510-608-4555  
Email: tmd1@asus.com

### *Technical Support*

Fax: +1-510-608-4555  
Email: tsd@asus.com  
WWW: www.asus.com  
FTP: ftp.asus.com/Pub/ASUS

## ASUS COMPUTER GmbH (Europe)

### *Marketing*

Address: Harkortstr. 25, 40880 Ratingen, BRD, Germany  
Fax: +49-2102-442066  
Email: sales@asuscom.de (for marketing requests only)

### *Technical Support*

Hotline: MB/Others: +49-2102-9599-0 Notebook: +49-2102-9599-10  
Fax: +49-2102-9599-11  
Support (Email): www.asuscom.de/de/support (for online support)  
WWW: www.asuscom.de  
FTP: ftp.asuscom.de/pub/ASUSCOM

# CONTENTS

---

<b>1. INTRODUCTION .....</b>	<b>7</b>
1.1 How This Manual Is Organized .....	7
1.2 Item Checklist .....	7
<b>2. FEATURES .....</b>	<b>8</b>
2.1 ASUS CUV4X-D Motherboard .....	8
2.1.1 Specifications .....	8
2.1.2 Performance .....	10
2.1.4 Intelligence .....	11
2.2 Motherboard Components .....	12
2.2.1 Component Locations .....	13
<b>3. HARDWARE SETUP .....</b>	<b>14</b>
3.1 Motherboard Layout .....	14
3.2 Layout Contents .....	15
3.3 Hardware Setup Procedure .....	16
3.4 Motherboard Settings .....	16
3.5 System Memory .....	21
3.5.1 General DIMM Notes .....	21
3.5.2 Memory Installation .....	22
3.6 Central Processing Unit (CPU) .....	23
3.6.1 CPU Installation .....	24
3.7 Expansion Cards .....	25
3.7.1 Installing an Expansion Card .....	25
3.7.2 Assigning IRQs for Expansion Cards .....	26
3.7.3 Accelerated Graphics Port (AGP) Pro Slot .....	27
3.8 Connectors .....	29
3.8.1 External Connectors .....	29
3.8.2 Internal Connectors .....	31
3.9 Starting Up the First Time .....	39

# CONTENTS

---

<b>4. BIOS SETUP .....</b>	<b>41</b>
4.1 Managing and Updating Your BIOS .....	41
4.1.1 Upon First Use of the Computer System .....	41
4.1.2 Updating BIOS Procedures .....	43
4.2 BIOS Setup Program .....	45
4.2.1 BIOS Menu Bar .....	46
4.2.2 Legend Bar .....	46
4.3 Main Menu .....	48
4.3.1 Primary & Secondary Master/Slave .....	49
4.3.2 Keyboard Features .....	52
4.4 Advanced Menu .....	54
4.4.1 Chip Configuration .....	58
4.4.2 I/O Device Configuration .....	61
4.4.3 PCI Configuration .....	63
4.4.4 Shadow Configuration .....	66
4.5 Power Menu .....	67
4.5.1 Power Up Control .....	69
4.5.2 Hardware Monitor .....	70
4.6 Boot Menu .....	71
4.7 Exit Menu .....	73
<b>5. SOFTWARE SETUP .....</b>	<b>75</b>
5.1 Operating Systems .....	75
5.1.1 Windows 98 First Time Installation .....	75
5.2 CUV4X-D Motherboard Support CD .....	75
5.2.1 Installation Menu .....	75
<b>6. SOFTWARE REFERENCE .....</b>	<b>77</b>
6.1 ASUS PC Probe .....	77
<b>7. APPENDIX .....</b>	<b>83</b>
7.1 PCI-L101 Fast Ethernet Card .....	83
7.2 Glossary .....	85
<b>INDEX .....</b>	<b>89</b>

# FCC & DOC COMPLIANCE

---

## ***Federal Communications Commission Statement***

This device complies with FCC Rules Part 15. Operation is subject to the following two conditions:

- This device may not cause harmful interference, and
- This device must accept any interference received, including interference that may cause undesired operation.

This equipment has been tested and found to comply with the limits for a Class B digital device, pursuant to Part 15 of the FCC Rules. These limits are designed to provide reasonable protection against harmful interference in a residential installation. This equipment generates, uses and can radiate radio frequency energy and, if not installed and used in accordance with manufacturer's instructions, may cause harmful interference to radio communications. However, there is no guarantee that interference will not occur in a particular installation. If this equipment does cause harmful interference to radio or television reception, which can be determined by turning the equipment off and on, the user is encouraged to try to correct the interference by one or more of the following measures:

- Re-orient or relocate the receiving antenna.
- Increase the separation between the equipment and receiver.
- Connect the equipment to an outlet on a circuit different from that to which the receiver is connected.
- Consult the dealer or an experienced radio/TV technician for help.

**WARNING!** Any changes or modifications to this product not expressly approved by the manufacturer could void any assurances of safety or performance and could result in violation of Part 15 of the FCC Rules.

Reprinted from the Code of Federal Regulations #47, part 15.193, 1993. Washington DC: Office of the Federal Register, National Archives and Records Administration, U.S. Government Printing Office.

## ***Canadian Department of Communications Statement***

This digital apparatus does not exceed the Class B limits for radio noise emissions from digital apparatus set out in the Radio Interference Regulations of the Canadian Department of Communications.

**This Class B digital apparatus complies with Canadian ICES-003.**

**Cet appareil numérique de la classe B est conforme à la norme NMB-003 du Canada.**

# 1. INTRODUCTION

## 1.1 How This Manual Is Organized

This manual is divided into the following sections:

<b>1. INTRODUCTION</b>	Manual information and checklist
<b>2. FEATURES</b>	Production information and specifications
<b>3. HARDWARE SETUP</b>	Instructions on setting up the motherboard.
<b>4. BIOS SETUP</b>	Instructions on setting up the BIOS
<b>5. SOFTWARE SETUP</b>	Instructions on setting up the included software
<b>6. SOFTWARE REFERENCE</b>	Reference material for the included software
<b>7. APPENDIX</b>	Optional items and general reference

## 1.2 Item Checklist

Check that your package is complete. If you discover damaged or missing items, contact your retailer.

### Package Contents

- (1) ASUS Motherboard
- (1) 40-pin 80-conductor ribbon cable for internal UltraDMA/66 or UltraDMA/33 IDE drives
- (1) Ribbon cable for two 3.5" floppy disk drives
- (1) CPU terminator
- (1) ASUS Support CD with drivers and utilities
- (1) Bag of spare jumper caps
- (1) ASUS 2-port USB Connector Set
- (1) IDE cable
- (1) User's Manual

### Optional Items

- ASUS Modem MR
- ASUS IrDA-compliant infrared module
- ASUS PCI-L101 Wake-On-LAN 10/100 Ethernet Card

## 2. FEATURES

### 2.1 ASUS CUV4X-D Motherboard

The ASUS CUV4X-D motherboard is targeted diversely for home PCs and entry-level workstations. Powered by dual Intel® Pentium® III processors and bundled with advanced features to provide superlative performance, the CUV4X-D efficiently complies with today's demand for a flexible system.

#### 2.1.1 Specifications

- **Latest Processor Support**

Intel Pentium® III	133MHz FSB	Coppermine core	FC-PGA
Intel Pentium® III	100MHz FSB	Coppermine core	FC-PGA

- **North Bridge System Chipset:** Features the VIA VT82C694XDP system controller PCI-to-ISA bridge with support for AGP 4X/2X mode; 133/100MHz Front Side Bus (FSB); and 133MHz memory bus.
- **South Bridge System Chipset:** VIA VT82C686B PCIset with PCI Super I/O integrated peripheral controller supports UltraDMA/100/66 for burst mode data transfer rates of up to 100MB/sec, and USB controller with root hub for four USB ports.
- **PC133 SDRAM / VC133 VCM / HSDRAM Support:** Equipped with four Dual Inline Memory Module (DIMM) sockets to support up to 4GB of memory using Intel PC133/100-compliant or NEC's VC133-compliant Virtual Channel (VC) SDRAMs, and Enhanced Memory System's High-speed DRAMs (HSDRAMs). VC SDRAM and HSDRAM are new DRAM core architectures that dramatically improves the memory system's ability to service high multimedia requirements.
- **JumperFree™ Mode:** Allows processor settings and easy overclocking of frequency and Vcore voltage through BIOS setup when the JumperFree™ mode is enabled. Easy-to-use DIP switches come with the motherboard board to allow manual adjustment of the processor external/internal frequency.
- **UltraDMA/100 Support:** Comes with an onboard PCI Bus Master IDE controller with two connectors that support four IDE devices on two channels. Supports UltraDMA/100, UltraDMA/66, UltraDMA/33, PIO Modes 3 & 4, Bus Master IDE DMA Mode 2, and Enhanced IDE devices, such as DVD-ROM, CD-ROM, CD-R/RW, LS-120, and Tape Backup drives.
- **AGP Pro Slot:** Comes with an Accelerated Graphics Port (AGP) Pro slot that supports high performance AGP cards targeted at 3D graphical applications supporting 133MHz 4X mode. The slot is backward compatible with AGP 4X/2X cards.
- **Wake-On-LAN:** Supports Wake-On-LAN activity through a WOL connector or an optional ASUS PCI-L101 10/100 Fast Ethernet PCI card.



## 2. FEATURES

---

- **Wake-On-Ring:** Supports Wake-On-Ring activity through a PCI modem card that supports a WOR connector.
- **PC Health Monitoring:** Provides an easy way to examine and manage system status information, such as CPU and system voltages, temperatures, and fan status through the onboard hardware ASUS ASIC and the bundled ASUS PC Probe.
- **SMBus:** Features the System Management Bus interface used to physically transport commands and information between SMBus devices.
- **PCI Expansion Slots:** Provides five 32-bit PCI (Rev. 2.2) expansion slots that support Bus Master PCI cards, such as SCSI or LAN cards, with 133MB/s maximum throughput.
- **Super Multi-I/O:** Provides two high-speed UART compatible serial ports and one parallel port with EPP and ECP capabilities. UART2 can also be directed from COM2 to the Infrared Module for wireless connections.
- **Smart BIOS:** 2MB firmware provides Vcore and CPU/SDRAM frequency adjustments, boot block write protection, and HD/SCSI/MO/ZIP/CD/Floppy boot selection.
- **Enhanced ACPI and Anti-Boot Virus Protection:** Programmable BIOS (Flash EEPROM) that offers enhanced ACPI for Windows 98 compatibility, built-in firmware-based virus protection, and autodetection of most devices for a virtual automatic setup.
- **IrDA:** Supports an optional infrared port module for wireless interface.
- **Concurrent PCI:** Concurrent PCI allows multiple PCI transfers from PCI master busses to the memory and processor.
- **Desktop Management Interface (DMI):** Supports DMI through BIOS that allows hardware to communicate within a standard protocol and create a higher level of compatibility. (Requires DMI-enabled components.)
- **Onboard LED:** Comes with a power LED that lights up if there is any standby power on the motherboard. This LED acts as a reminder to turn off the system power before plugging or unplugging devices to prevent damage to the motherboard, peripherals, and other system components.

## 2. FEATURES

---

### 2.1.2 Performance

- **ACPI Ready:** Advanced Configuration Power Interface (ACPI) provides more Energy Saving Features for operating systems that support OS Direct Power Management (OSPM) functionality. With these features employed in the OS, PCs can be ready around the clock but comply with energy saving standards. To fully utilize the ACPI benefits, use an ACPI-supported OS such as Windows 98.
- **PC'99 Compliant:** Both the BIOS and hardware levels of ASUS smart series motherboards are PC'99 compliant. The new PC'99 requirements for systems and components are based on the following high-level goals: Support for Plug-n-Play compatibility and power management for configuring and managing all system components, and 32-bit device drivers and installation procedures for Windows 95/98/NT. Color-coded connectors and descriptive icons make identification easy as required by PC'99.
- **High-Speed Data Transfer Interface:** Support for UltraDMA/100 through the onboard IDE bus master controller. doubles the UltraDMA/33 burst transfer rate to 66.6MB/s. UltraDMA/100 is backward compatible with DMA/66, DMA/33, and other existing DMA devices to save the need to upgrade current EIDE/IDE drives. (UltraDMA/66 requires a 40-pin 80-conductor cable).
- **Concurrent PCI:** Concurrent PCI allows multiple PCI transfers from PCI master busses to the memory and processor.
- **VCM/SDRAM Optimized Performance:** This motherboard supports the new generation memory, NEC 64Mb Virtual Channel Memory (VCM) Synchronous Dynamic Random Access Memory (SDRAM), that is compatible to the industry standard SDRAM. The VCM core design provides up to 50% higher SDRAM speed at reduced power consumption of about 30%. This motherboard also supports the standard SDRAM for a the data transfer rate of up to 1.064GB/s using PC133-compliant SDRAMs and up to 800MB/s using PC100-compliant SDRAMs.

## 2. FEATURES

---

### 2.1.4 Intelligence

- **Auto Fan Off:** The system fans powers off automatically even in sleep mode. This function reduces both energy consumption and system noise, and is an important feature in implementing silent PC systems.
- **Dual Function Power Button:** Pushing the power button for less than 4 seconds when the system is in the working state places the system into one of two states: sleep mode or soft-off mode, depending on the BIOS or OS setting (see **PWR Button < 4 Secs** in *4.5 Power Menu*). When the power button is pressed for more than 4 seconds, the system enters the soft-off mode regardless of the BIOS setting.
- **Fan Status Monitoring and Alarm:** To prevent system overheat and system damage, the CPU and system fans can be monitored for RPM and failure. All fans are set for its normal RPM range and alarm thresholds.
- **Power LED (requires ACPI OS support):** The power LED indicates the system status.
- **Remote Ring-On (requires modem):** This allows a computer to be turned on remotely through an internal or external modem. With this benefit on-hand, users can access vital information from their computers anywhere.
- **System Resources Alert:** Today's operating systems such as Windows 95/98/2000/NT and OS/2, require much more memory and hard drive space to present enormous user interfaces and run large applications. The system resource monitor warns the user before the system resources are used up to prevent possible application crashes. Suggestions provide the user some information on managing their limited resources more efficiently.
- **Temperature Monitoring and Alert:** CPU temperature is monitored by the ASUS ASIC through the CPU's internal thermal diode (on Pentium III and Celeron) to prevent system overheat and system damage.
- **Voltage Monitoring and Alert:** System voltage levels are monitored to ensure stable voltage to critical motherboard components. Voltage specifications are more critical for future processors, so monitoring is necessary to ensure proper system configuration and management.

# 2. FEATURES

## 2.2 Motherboard Components

See opposite page for locations.

	<b>Location</b>
<b>Processor Support</b>	2 Socket 370 for Pentium III Coppermine Processors ..... 1
	Feature Setting DIP Switches ..... 9
<b>Chipsets</b>	VIA VT82C694XDP system controller ..... 18
	VIA VT82C686B PCIset ..... 11
	2Mbit Programmable Flash EEPROM ..... 14
<b>Main Memory</b>	Maximum 4GB support
	4 DIMM Sockets ..... 4
	PC133 SDRAM support
<b>Expansion Slots</b>	5 PCI Slots ..... 16
	1 Accelerated Graphics Port (AGP) Pro/4X Slot ..... 17
<b>System I/O</b>	1 Floppy Disk Drive Connector ..... 6
	2 IDE Connectors (UltraDMA/100 Support) ..... 8
	1 ASUS iPanel Connector ..... 5
	1 Parallel Port ..... <b>(Top)</b> 19
	2 Serial Ports (COM1/COM2) ..... <b>(Bottom)</b> 19
	USB Connectors (Port 0 & Port 1) ..... 20
	USB Connectors (Port 2 & Port 3) ..... 7
	1 PS/2 Mouse Connector ..... <b>(Top)</b> 21
	1 PS/2 Keyboard Connector ..... <b>(Bottom)</b> 21
<b>Hardware Monitoring</b>	System Voltage Monitoring (integrated in ASUS ASIC) ..... 10
	2 Fan Power and Speed Monitoring Connectors
<b>Special Features</b>	Onboard LED ..... 12
	Wake-on-Ring Connector ..... 13
	Wake-on-LAN Connector ..... 15
<b>Power</b>	Auxiliary Power connector ..... 2
	ATX Power Supply Connector ..... 3
<b>Form Factor</b>	ATX

# 2. FEATURES

## 2.2.1 Component Locations

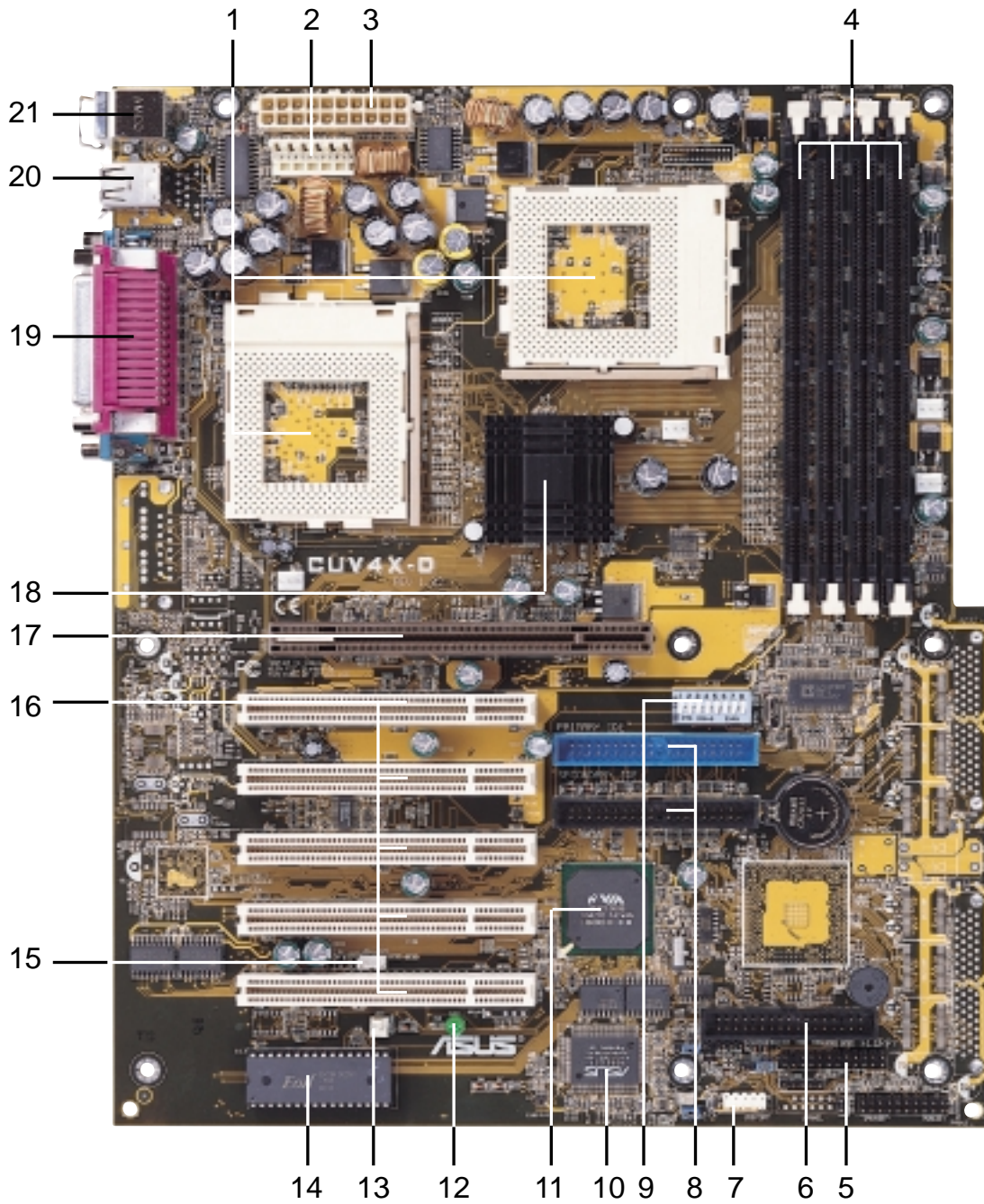

**2. FEATURES**  
Motherboard Parts

# 3. HARDWARE SETUP

## 3.1 Motherboard Layout

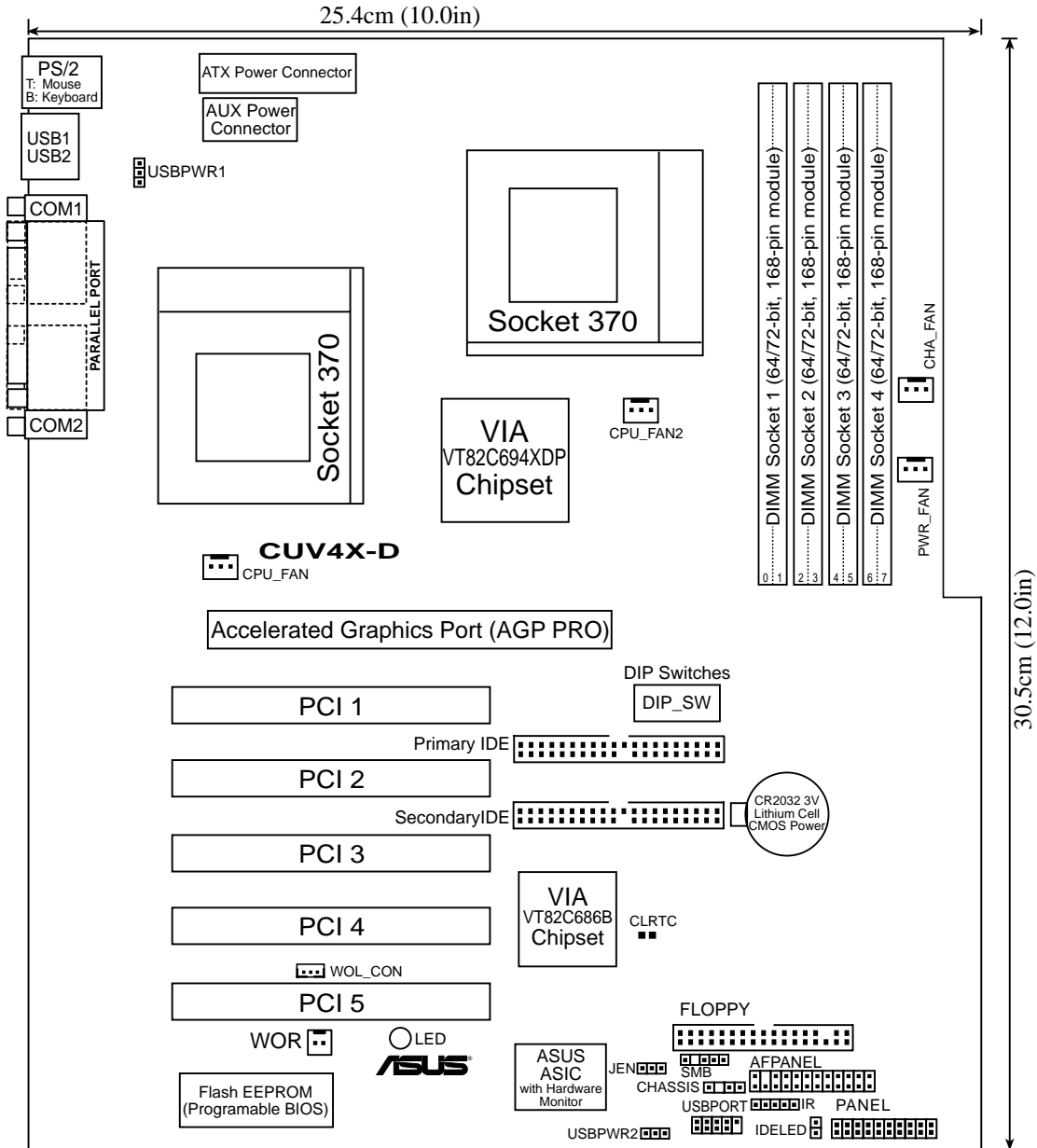

3. HW/SETUP  
Motherboard Layout

# 3. HARDWARE SETUP

## 3.2 Layout Contents

### Motherboard Settings

- 1) JEN p. 17 JumperFree Mode Setting (Disable/Enable)
- 2) DIP\_SW 5-8 p. 18 CPU External Frequency Selection
- 3) DIP\_SW 1-4 p. 19 CPU Core:BUS Frequency Multiple Selection
- 4) R153 p. 20 Clear RTC RAM
- 5) USBPWR1/2 p. 20 USB Wake-up Jumpers

### Expansion Slots/Sockets

- 1) DIMM 1/2/3/4 p. 21 System Memory Support
- 2) Socket 370 p. 23 CPU Support
- 3) PCI 1/2/3/4/5 p. 25 32-bit PCI Bus Expansion Slots
- 4) AGP Pro p. 27 Accelerated Graphics Port

### Connectors

- 1) PS2KBMS p. 29 PS/2 Mouse Port Connector (6-pin female)
- 2) PS2KBMS p. 29 PS/2 Keyboard Port Connector (6-pin female)
- 3) USB p. 30 Universal Serial Bus Connectors 1 & 2 (two 4-pin female)
- 4) PRINTER p. 30 Parallel Port Connector (25-pin female)
- 5) COM1/COM2 p. 30 Serial Port Connector (9-pin /10-1 pin male)
- 6) IDELED p. 31 IDE Activity LED (2-pin)
- 7) FLOPPY p. 31 Floppy Disk Drive Port Connector (34 pins)
- 8) PRIMARY IDE p. 32 IDE Connectors (Two 40-1 pins)  
SECONDARY IDE
- 9) WOL\_CON p. 33 Wake-On-LAN Connector (3-pin)
- 10) WOR p. 33 Wake-On-Ring Connector (2-pin)
- 11) CPU\_FAN, CHA\_FAN p. 34 Chassis and CPU Fan Connectors (four 3-pin)
- 12) USB2 p. 34 USB Header (10-1 pins)
- 13) IR p. 35 Infrared Module Connector (5-pin)
- 14) CHASSIS p. 35 Chassis Intrusion Lead (4-1 pins)
- 15) ATXPWR/EAUXPWR p. 36 ATX/Auxiliary Power Supply Connectors (20-pin/6-pin)
- 16) SMB p. 37 SMBus Connector (5-1 pins)
- 17) AFPANEL p. 37 ASUS iPanel Connector (12-1 pins)
- 18) PWR.LED (PANEL) p. 38 System Power LED Lead (3 pins)
- 19) SPEAKER (PANEL) p. 38 System Warning Speaker Connector (4 pins)
- 20) MSG.LED (PANEL) p. 38 System Message LED (2 pins)
- 21) SMI (PANEL) p. 38 System Management Interrupt Lead (2 pins)
- 22) PWR.SW (PANEL) p. 38 ATX / Soft-Off Switch Lead (2 pins)
- 23) RESET (PANEL) p. 38 Reset Switch Lead (2 pins)

# 3. HARDWARE SETUP

## 3.3 Hardware Setup Procedure

Before using your computer, you must complete the following steps:

1. Check motherboard settings
2. Install memory modules
3. Install the Central Processing Unit (CPU)
4. Install Expansion Cards
5. Connect Ribbon Cables, Panel Wires, and Power Supply
6. Setup the BIOS Software

## 3.4 Motherboard Settings

This section explains how to change your motherboard function settings through the switches and/or jumpers.

**WARNING!** Computer motherboards and expansion cards contain very delicate Integrated Circuit (IC) chips. To protect them against damage from static electricity, you should follow some precautions whenever you work on your computer.

1. Unplug your computer when working on the inside.
2. Use a grounded wrist strap before handling computer components. If you do not have one, touch both of your hands to a safely grounded object or to a metal object, such as the power supply case.
3. Hold components by the edges and try not to touch the IC chips or any other components.
4. Place components on a grounded antistatic pad or in the bag that came with the component whenever the components are separated from the system.
5. Ensure that the ATX power supply is switched off before you plug in or remove the ATX power connector on the motherboard.

**WARNING!** Make sure that you unplug the power supply when adding or removing system components. Failure to do so may cause severe damage to the motherboard, peripherals, and/or components. When lit, the onboard LED indicates that the system is in suspend or soft-off mode, not powered OFF.

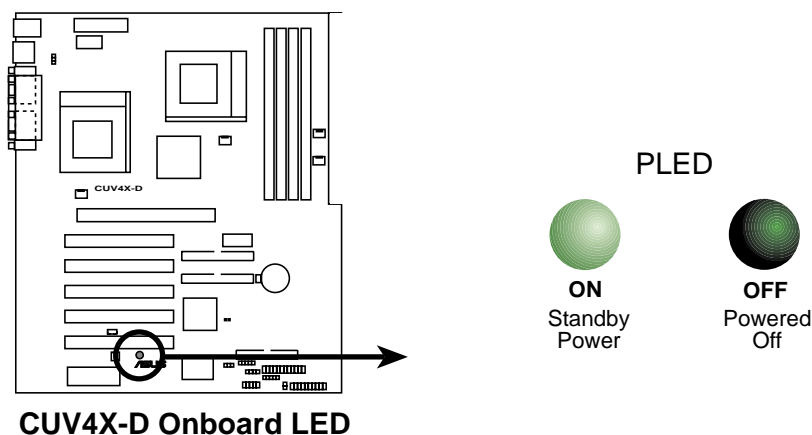



# 3. HARDWARE SETUP

## Motherboard Frequency Settings (DIP Switches)

The motherboard frequency is adjusted through the DIP switches. The white block represents the switch's position. The example below shows all the switches in the OFF position.

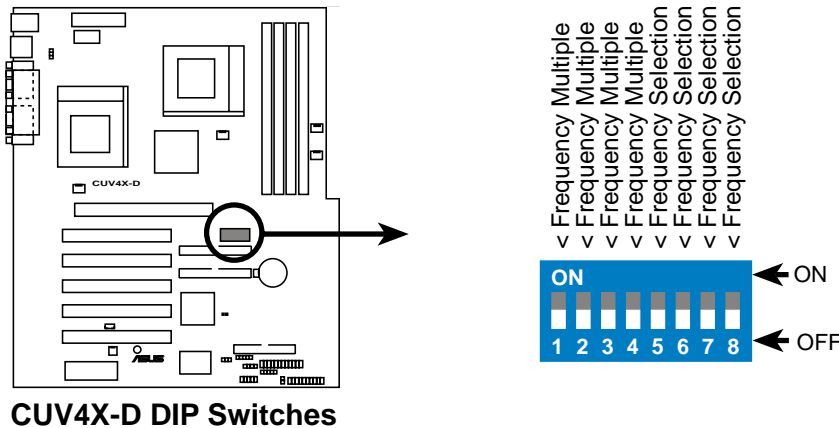

CUV4X-D DIP Switches

### 1) JumperFree™ Mode (JEN)

This jumper allows you to enable or disable the JumperFree™ mode. The JumperFree™ mode allows processor settings to be made through the BIOS setup (see *4.4 Advanced Menu*).

Setting	JEN
Enable (JumperFree)	[2-3] (default)
Disable (Jumper)	[1-2]

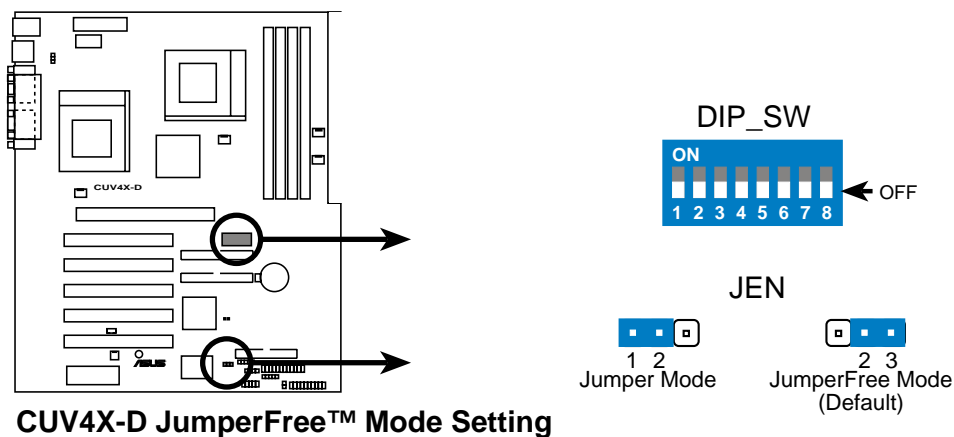

CUV4X-D JumperFree™ Mode Setting

**NOTE:** In JumperFree™ mode, set all DIP switches (DIP\_SW) to OFF.

# 3. HARDWARE SETUP

## 2) CPU External Frequency Selection (DIP\_SW Switches 5–8)

This option tells the clock generator what frequency to send to the CPU, DRAM, and the PCI bus. This allows the selection of the CPU's *External* frequency (or *BUS Clock*). The BUS Clock multiplied by the Frequency Multiple equals the CPU's *Internal* frequency (the advertised CPU speed).

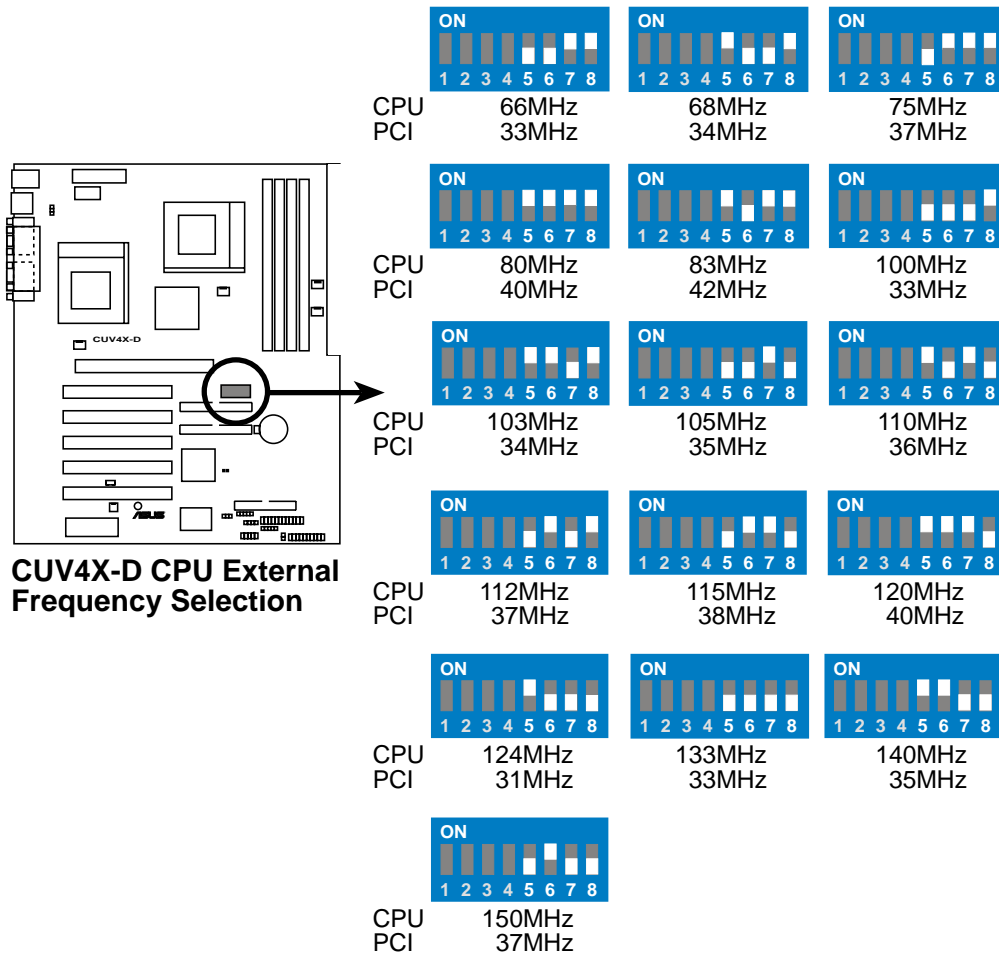

**NOTE:** Overclocking your processor is not recommended. It may result in a slower speed.

**WARNING!** Frequencies other than the recommended CPU bus frequencies are not guaranteed to be stable.

# 3. HARDWARE SETUP

## 3) CPU Core:BUS Frequency Multiple (DIP\_SW Switches 1–4)

This option sets the frequency multiple between the *Internal* frequency of the CPU and the CPU's *External* frequency. These must be set in conjunction with the *CPU Bus Frequency*.

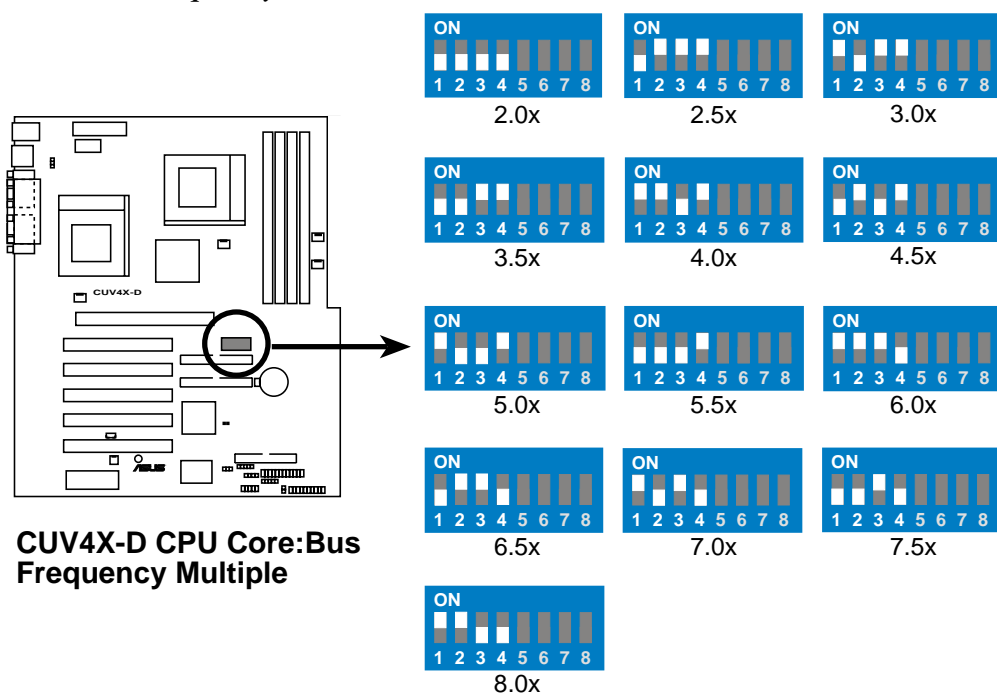

**CUV4X-D CPU Core:Bus Frequency Multiple**

### Manual CPU Settings

**NOTE:** Disable the JumperFree™ mode when you are manually setting the CPU frequency through the DIP switches.

*Set the DIP switches by the Internal speed of your processor as follows:*

Intel CPU Model	Freq.	Mult.	Bus F.	(CPU BUS Freq.)				(Freq. Multiple)			
				5	6	7	8	1	2	3	4
Pentium III	933MHz	7.0x	133MHz	[OFF]	[OFF]	[OFF]	[OFF]	[ON]	[OFF]	[ON]	[OFF]
Pentium III	866MHz	6.5x	133MHz	[OFF]	[OFF]	[OFF]	[OFF]	[OFF]	[ON]	[ON]	[OFF]
Pentium III	800MHz	6.0x	133MHz	[OFF]	[OFF]	[OFF]	[OFF]	[ON]	[ON]	[ON]	[OFF]
Pentium III	733MHz	5.5x	133MHz	[OFF]	[OFF]	[OFF]	[OFF]	[OFF]	[OFF]	[OFF]	[ON]
Pentium III	667MHz	5.0x	133MHz	[OFF]	[OFF]	[OFF]	[OFF]	[ON]	[OFF]	[OFF]	[ON]
Pentium III	600MHz	4.5x	133MHz	[OFF]	[OFF]	[OFF]	[OFF]	[OFF]	[ON]	[OFF]	[ON]
Pentium III	533MHz	4.0x	133MHz	[OFF]	[OFF]	[OFF]	[OFF]	[ON]	[ON]	[OFF]	[ON]
Pentium III	800MHz	8.0x	100MHz	[OFF]	[OFF]	[OFF]	[ON]	[ON]	[ON]	[OFF]	[OFF]
Pentium III	750MHz	7.5x	100MHz	[OFF]	[OFF]	[OFF]	[ON]	[OFF]	[OFF]	[ON]	[OFF]
Pentium III	700MHz	7.0x	100MHz	[OFF]	[OFF]	[OFF]	[ON]	[ON]	[OFF]	[ON]	[OFF]
Pentium III	650MHz	6.5x	100MHz	[OFF]	[OFF]	[OFF]	[ON]	[OFF]	[ON]	[ON]	[OFF]
Pentium III	600MHz	6.0x	100MHz	[OFF]	[OFF]	[OFF]	[ON]	[ON]	[ON]	[ON]	[OFF]
Pentium III	550MHz	5.5x	100MHz	[OFF]	[OFF]	[OFF]	[ON]	[OFF]	[OFF]	[OFF]	[ON]
Pentium III	500MHz	5.0x	100MHz	[OFF]	[OFF]	[OFF]	[ON]	[ON]	[OFF]	[OFF]	[ON]
Pentium III	450MHz	4.5x	100MHz	[OFF]	[OFF]	[OFF]	[ON]	[OFF]	[ON]	[OFF]	[ON]

For updated processor settings, visit the ASUS web site. See also ASUS CONTACT INFORMATION at the beginning of this manual.

# 3. HARDWARE SETUP

## 4) Clear RTC RAM

These two solder points allow you to clear the Real Time Clock (RTC) RAM in CMOS. You can clear the CMOS memory of date, time, and system setup parameters by erasing the CMOS RTC RAM data. The RAM data in CMOS, that include system setup information such as system passwords, is powered by the onboard button cell battery.

To erase the RTC RAM: (1) unplug the computer, (2) short the solder points, (3) turn ON the computer, (4) hold down the <Del> key during the boot process and enter BIOS setup to re-enter data.

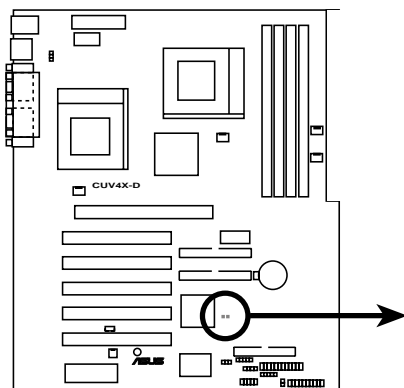

CUV4X-D Clear RTC RAM

R153



Short solder points to Clear CMOS

## 5) USB Device Wake-up Jumpers (3-pin USBPWR1, USBPWR2)

These jumpers allow you to enable or disable the USB feature on the motherboard. Set to Enable if you wish to use the USB devices to wake up the computer. This feature requires an ATX power supply that can supply at least 2A on the +5VSB lead. The default setting for both USBPWR1 and USBPWR2 is DISABLE.

### NOTES:

1. Before setting either of these jumpers to ENABLE, make sure that you have the appropriate power supply, otherwise the computer does not power up.
2. When using the Suspend-to-RAM feature, set these jumpers to ENABLE.
3. The total current consumed must NOT exceed the power supply capability (+5VSB) whether under normal working conditions or in sleep mode.

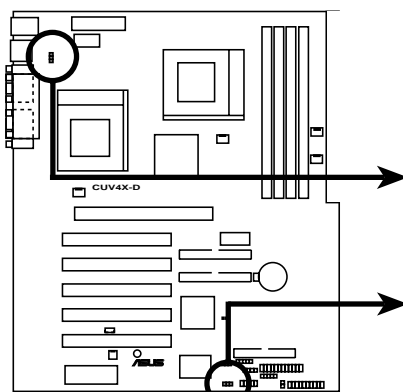

CUV4X-D USB Device Wake Up

USBPWR1

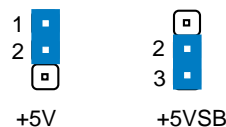

USBPWR2

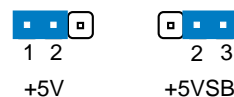

---

## 3.5 System Memory

This motherboard uses only Dual Inline Memory Modules (DIMMs). Four DIMM sockets are available for **3.3Volt** (power level) unbuffered Synchronous Dynamic Random Access Memory (SDRAM) of 16, 32, 64, 128, 256, 512MB, or 1GB densities for a system memory configuration of 32MB up to 4GB. One side (with memory chips) of the DIMM takes up one row on the motherboard. This motherboard also supports NEC's Virtual Channel SDRAMs and Enhanced Memory System's High-speed DRAMs.

Setup the memory speed in BIOS (see *4.4.1 Chip Configuration*).

**IMPORTANT** (see **General DIMM Notes** below for more)

- **SDRAMs used must be compatible with the current Intel PC133 SDRAM specifications.**
- **DO NOT attempt to mix registered SDRAMs with VCM SDRAMs.**

*Install memory in any combination as follows:*

DIMM Location	168-pin DIMM	Total Memory
Socket 1 (Rows 0&1)	SDRAM 16, 32, 64, 128, 256, 512MB, 1GB	x1
Socket 2 (Rows 2&3)	SDRAM 16, 32, 64, 128, 256, 512MB, 1GB	x1
Socket 3 (Rows 4&5)	SDRAM 16, 32, 64, 128, 256, 512MB, 1GB	x1
Socket 4 (Rows 6&7)	SDRAM 16, 32, 64, 128, 256, 512MB, 1GB	x1
<b>Total System Memory (Max. 4GB)</b>		<b>=</b>

### 3.5.1 General DIMM Notes

- **DIMMs that have more than 18 chips are not supported on this motherboard.**
- **For the system CPU bus to operate 100MHz/133MHz, use only PC100-/PC133-compliant DIMMs.**
- ASUS motherboards support Serial Presence Detect (SPD) DIMMs. This is the memory of choice for best performance vs. stability.
- SDRAM chips are generally thinner with higher pin density than EDO (Extended Data Output) chips.
- BIOS shows SDRAM memory on bootup screen.
- Single-sided DIMMs come in 16, 32, 64, 128, 256MB; double-sided come in 32, 64, 128, 256, 512MB.

**WARNING!** Make sure that the DIMM you use can handle the specified SDRAM speeds, otherwise the computer does not boot.

# 3. HARDWARE SETUP

## 3.5.2 Memory Installation

**WARNING!** Make sure that you unplug the power supply when adding or removing memory modules or other system components. Failure to do so may cause severe damage to both the motherboard and expansion cards (see **3.3 Hardware Setup Procedure** for more information).

Insert the module(s) into the DIMM sockets as shown. Because the number of pins are different on either side of the breaks, the module only fits in one direction. SDRAM DIMMs have different pin contacts on each side and have a higher pin density than DRAM SIMMs.

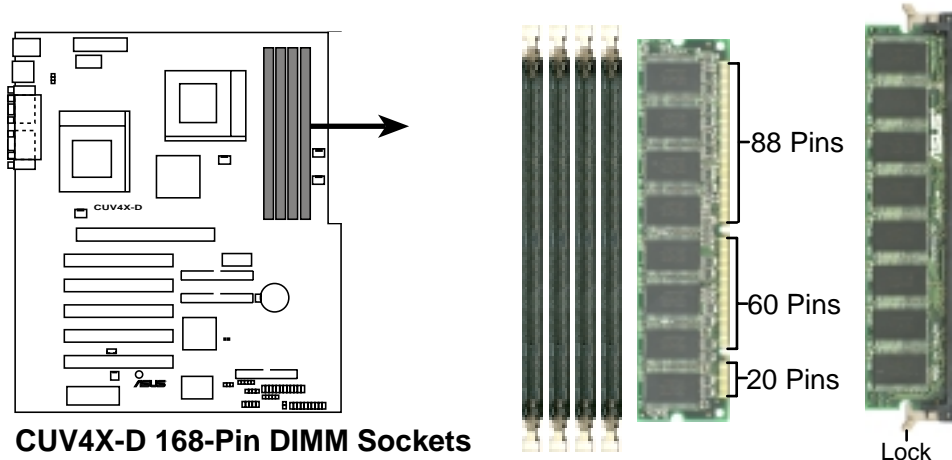

CUV4X-D 168-Pin DIMM Sockets

The DIMMs must be 3.3Volt unbuffered SDRAMs. To determine the DIMM type, check the notches on the DIMMs (see the figure below).

168-Pin DIMM Notch Key Definitions (3.3V)

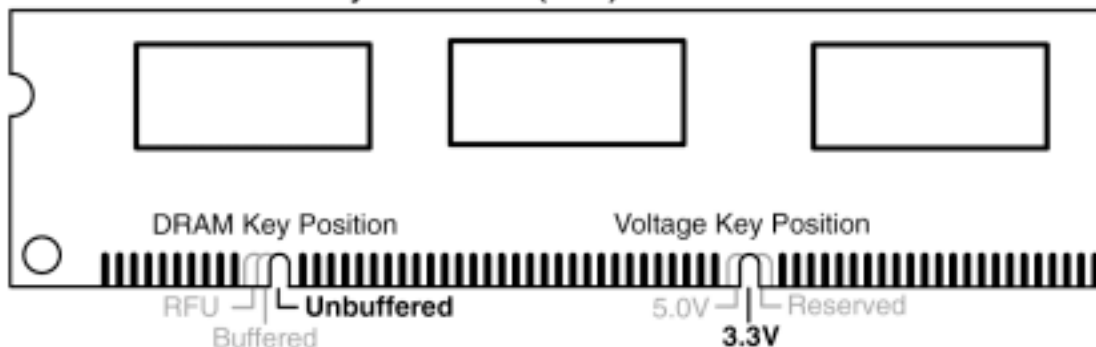

The notches on the DIMM shifts between left, center, or right to identify the type and also to prevent the wrong type from being inserted into the DIMM slot on the motherboard. You must tell your retailer the correct DIMM type before purchasing. This motherboard supports four clock signals per DIMM.

# 3. HARDWARE SETUP

## 3.6 Central Processing Unit (CPU)

The motherboard comes with a ZIF Socket for the supported CPUs listed in section 2.1.1 *Specifications*. The following illustration shows the CPU socket location on the motherboard and the correct CPU orientation.

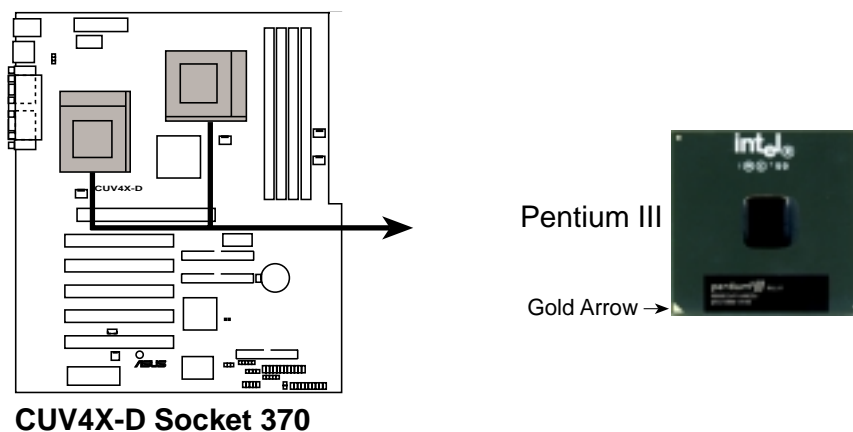

Note in the illustration that CPUs have marks (usually a notch or a gold mark on one corner) to help you identify the proper orientation and enable you to correctly install a CPU. It is important that you match the marked corner of the CPU with the corresponding corner on the socket so as not to damage the CPU pins.

The CPU picture above is for reference only. Usually, when you buy a CPU, the heatsink and fan are already attached to the CPU. If a heatsink and fan did not come with the package, make sure you obtain one before installing the CPU.

**WARNING!** You must install the proper heatsink and fan to the CPU. Failure to do so will cause the CPU to overheat and may damage both the CPU and the motherboard. Install an auxiliary fan, if necessary.

**CAUTION!** Be careful not to scrape the motherboard when mounting/unmounting a clamp-style processor fan to avoid damaging the motherboard.

Proceed to the next section for the steps on how to properly install a CPU.

# 3. HARDWARE SETUP

---

## 3.6.1 CPU Installation

Follow these steps to install a CPU.

1. Locate the ZIP socket on the motherboard.
2. Unlock the socket by pressing the lever sideways then lifting it up to a 90°-100° angle.
3. Position the CPU above the socket such that its notched or marked corner matches the socket corner near the end of the lever, while making sure that the CPU is parallel to the socket.
4. Carefully insert the CPU into the socket until it fits in place.

**CAUTION!** The CPU fits only in one orientation. Do not force the CPU into the socket to prevent bending the pins and damaging the CPU. If the CPU does not fit completely, check its orientation or check for bent pins.

5. Secure the CPU into the socket by pushing the socket lever all the way down. You will hear a click indicating that the lever is in place.
6. Attach the heatsink and fan to the CPU, if they were not pre-installed by the vendor. Refer to the installation instructions that came with the heatsink and fan.

**NOTE:** Do not forget to set the correct Bus Frequency and Multiple (frequency multiple setting is available only on unlocked processors) for the processor to avoid start-up problems.

**WARNING!** If you are using only one CPU on the motherboard, make sure to install a CPU terminator on the unused CPU socket. But **DO NOT** install heatsink and fan on the CPU terminator! Doing so will cause irreparable damage to the CPU and motherboard.



# 3. HARDWARE SETUP

## 3.7 Expansion Cards

In the future, you may need to install expansion cards. The motherboard has five PCI expansion slots to support these cards. Follow the steps in the next section when installing expansion cards.

**WARNING!** Unplug the system power cord when adding or removing expansion cards or other system components. Failure to do so may cause severe damage to both the motherboard and expansion cards.

### 3.7.1 Installing an Expansion Card

1. Read the documentation that comes with the expansion card and make any necessary hardware settings for the card before installing it.
2. Remove the system unit cover and the bracket plate on the slot you intend to use. Keep the screw for later use.
3. Align the card connectors with the slot and press firmly until the card fits in place.
4. Secure the card to the slot with the screw you removed earlier.
5. Replace the system cover.
6. Change the necessary BIOS settings, if any.  
(see section **4.4.3 PCI Configuration** to change the settings.)
7. Install the necessary software drivers for the expansion card.

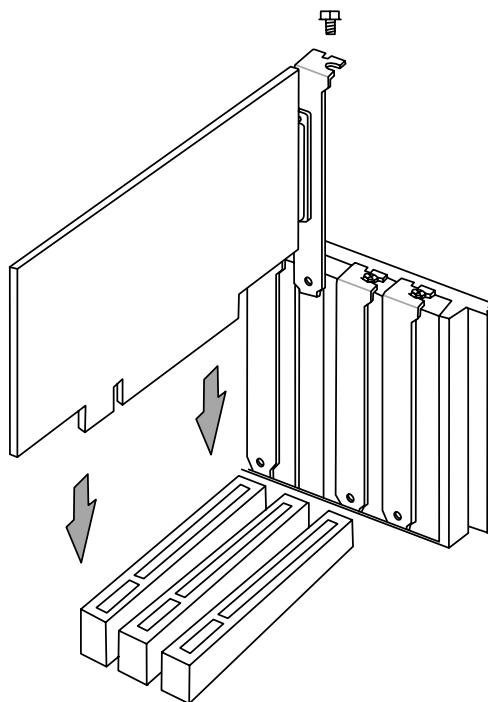

# 3. HARDWARE SETUP

## 3.7.2 Assigning IRQs for Expansion Cards

Some expansion cards need an IRQ to operate. Generally, an IRQ must be exclusively assigned to one use. In a standard design, there are 16 IRQs available but most of them are already in use, leaving 6 IRQs free for expansion cards.

**IMPORTANT:** If using PCI cards on shared slots, make sure that the drivers support “Share IRQ” or that the cards do not need IRQ assignments. Conflicts arise between the two PCI groups that makes the system unstable or cards inoperable.

The following table lists the default IRQ assignments for standard PC devices. Use this table when configuring your system and for resolving IRQ conflicts.

### *Standard Interrupt Assignments*

IRQ	Priority	Standard Function
0	1	System Timer
1	2	Keyboard Controller
2	N/A	Programmable Interrupt
3*	11	Communications Port (COM2)
4*	12	Communications Port (COM1)
5*	13	Sound Card (sometimes LPT2)
6	14	Floppy Disk Controller
7*	15	Printer Port (LPT1)
8	3	System CMOS/Real Time Clock
9*	4	ACPI Mode when used
10*	5	IRQ Holder for PCI Steering
11*	6	IRQ Holder for PCI Steering
12*	7	PS/2 Compatible Mouse Port
13	8	Numeric Data Processor
14*	9	Primary IDE Channel
15*	10	Secondary IDE Channel

\*These IRQs are usually available for ISA or PCI devices.

### *Interrupt Request Table for this Motherboard*

	INT-A	INT-B	INT-C	INT-D
PCI slot 1	shared	—	—	—
PCI slot 2	—	shared	—	—
PCI slot 3	—	—	shared	—
PCI slot 4	—	—	—	shared
PCI slot 5	—	—	—	shared
AGPPro slot	shared	shared	—	—
Onboard USB controller	—	—	—	shared

# 3. HARDWARE SETUP

## 3.7.3 Accelerated Graphics Port (AGP) Pro Slot

This motherboard has an Accelerated Graphics Port (AGP) Pro slot to support the new generation graphics cards with ultra-high memory bandwidth.

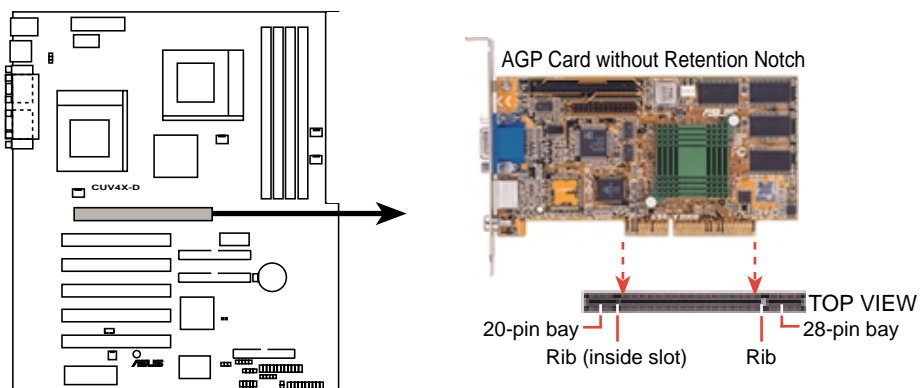

**CUV4X-D Accelerated Graphics Port (AGP PRO)**

**CAUTION!** The AGP Pro slot is shipped with a warning label over the 20-pin bay. DO NOT remove this label and the safety tab underneath it if you will be using an AGP card *without* a retention notch. Doing so may cause the card to shift and may cause damage to the card, slot, and motherboard. Remove the label and tab **ONLY** when you are using an *AGP Pro* card. Use a rigid tip, such as a pen tip, to dislodge and remove the tab from the bay.

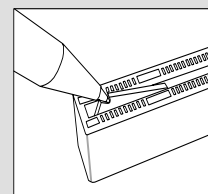

Removing the tab

# 3. HARDWARE SETUP

---

(This page was intentionally left blank.)

# 3. HARDWARE SETUP

## 3.8 Connectors

### 3.8.1 External Connectors

**WARNING!** Some pins are used for connectors or power sources. These are clearly distinguished from jumpers in the motherboard layout. Placing jumper caps over these connector pins will cause damage to the motherboard.

**IMPORTANT:** Connect ribbon cables such that the red stripe on the cable matches Pin 1 on the connectors. Pin 1 is usually on the side closest to the power connector on hard drives and CD-ROM drives, but may be on the opposite side on floppy disk drives. Carefully check the connectors before installation because there may be exceptions. IDE ribbon cable must be less than 46 cm (18 in.), with the second drive connector no more than 15 cm (6 in.) from the first connector.

#### 1) PS/2 Mouse Connector (Green 6-pin PS2KBMS)

The system automatically directs IRQ12 to the PS/2 mouse if one is detected. If no mouse is detected, IRQ12 become available to expansion cards. See **PS/2 Mouse Function Control** in *4.4 Advanced Menu*.

PS/2 Mouse (6-pin Female)

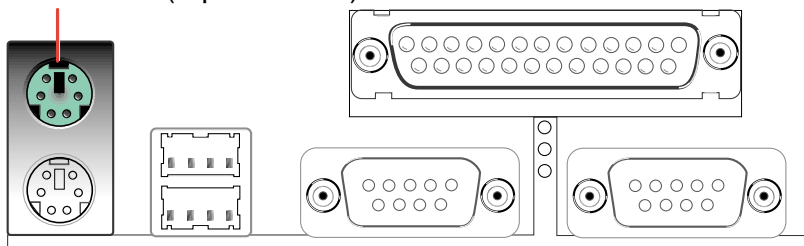

#### 2) PS/2 Keyboard Connector (Purple 6-pin PS2KBMS)

This connection is for a standard keyboard using an PS/2 plug (mini DIN). **This connector does not allow standard AT size (large DIN) keyboard plugs. You may use a DIN to mini DIN adapter on standard AT keyboards.**

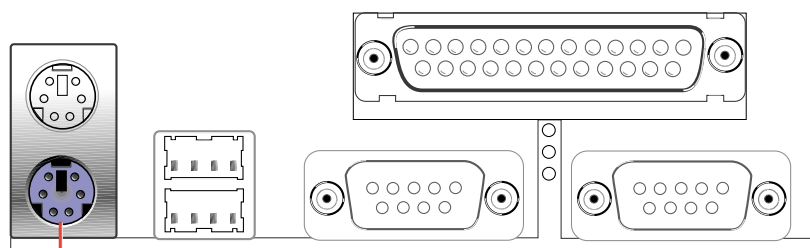

PS/2 Keyboard (6-pin Female)

# 3. HARDWARE SETUP

## 3) Universal Serial Bus Ports 1 & 2 (Black two 4-pin USB)

Two USB ports are available for connecting USB devices.

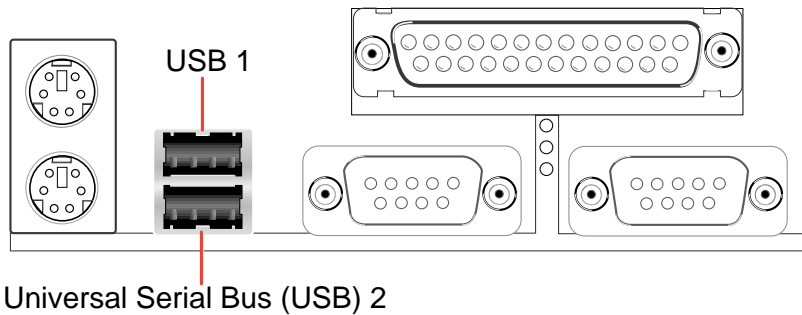

## 4) Parallel Port Connector (Burgundy 25-pin PRINTER)

You can enable the parallel port and choose the IRQ through **Onboard Parallel Port** (see **4.4.2 I/O Device Configuration**).

**NOTE:** Serial printers must be connected to the serial port.

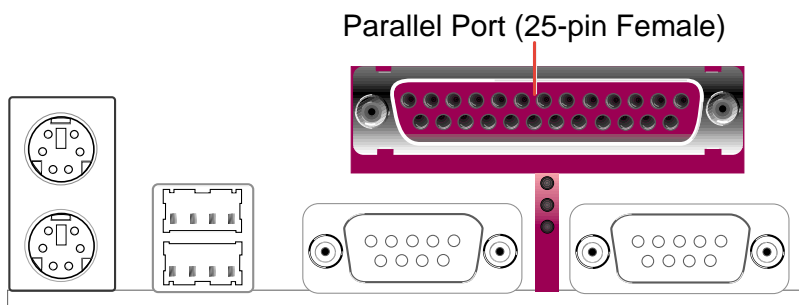

## 5) Serial Port Connectors (Teal/Turquoise 9-pin COM1 / 9-pin COM2)

Two serial ports can be used for pointing devices or other serial devices. To enable these ports, see **Onboard Serial Port 1 / Onboard Serial Port 2** in **4.4.2 I/O Device Configuration** for the settings.

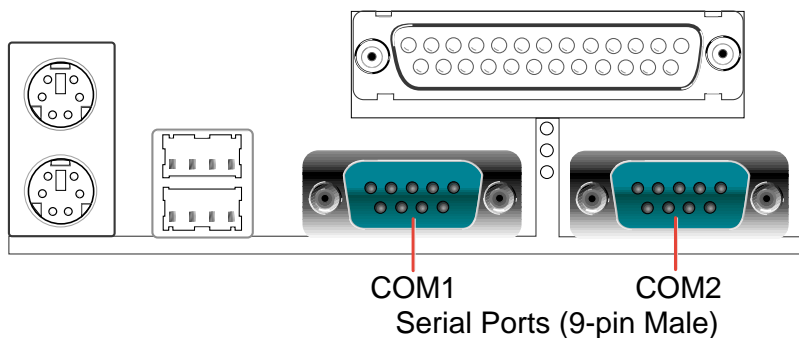

# 3. HARDWARE SETUP

## 3.8.2 Internal Connectors

### 1) IDE Activity LED (2-pin IDELED)

This connector supplies power to the cabinet's IDE activity LED. Read and write activity by devices connected to the Primary or Secondary IDE connectors cause the IDE LED to light up.

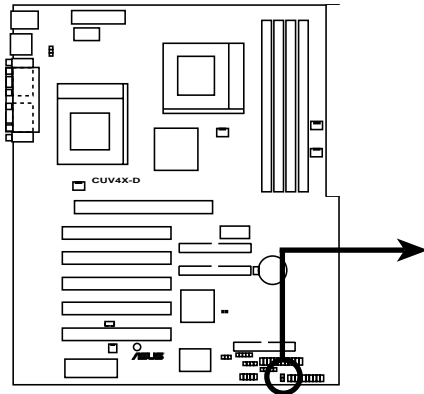

CUV4X-D IDE Activity LED



IDELED

**TIP:** If the case-mounted LED does not light, try reversing the 2-pin plug.

### 2) Floppy Disk Drive Connector (34-1 pin FLOPPY)

This connector supports the provided floppy drive ribbon cable. After connecting the single end to the board, connect the two plugs on the other end to the floppy drives. (**Pin 5 is removed to prevent inserting in the wrong orientation when using ribbon cables with pin 5 plugged**).

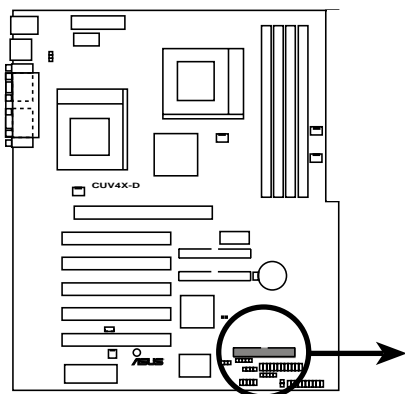

CUV4X-D Floppy Disk Drive Connector

**NOTE:** Orient the red markings on the floppy ribbon cable to PIN 1

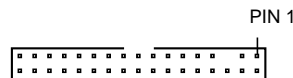

# 3. HARDWARE SETUP

## 3) Primary (Blue) / Secondary IDE Connectors (40-pin IDE1/IDE2)

These connectors support the provided UltraDMA/100/66 IDE hard disk ribbon cable. Connect the cable's blue connector to the primary (recommended) or secondary IDE connector, then connect the gray connector to the UltraDMA/100/66 slave device (hard disk drive) and the black connector to the UltraDMA/100/66 master device. It is recommended that non-UltraDMA/100/66 devices be connected to the secondary IDE connector. If you install two hard disks, you must configure the second drive as a slave device by setting its jumper accordingly. Refer to the hard disk documentation for the jumper settings. BIOS supports specific device bootup (see **4.6. Boot Menu**). If you have more than two UltraDMA/100/66 devices, purchase another UltraDMA/100/66 cable.

### NOTES:

1. Pin 20 on each IDE connector is removed to match the covered hole on the UltraDMA cable connector. This prevents incorrect orientation when you connect the cables.
2. The hole near the blue connector on the UltraDMA/100/66 cable is intentional.

**TIP:** You may configure two hard disks to be both Masters with two ribbon cables – one for the primary IDE connector and another for the secondary IDE connector. You may install one operating system on an IDE drive and another on a SCSI drive and select the boot disk in BIOS (see **4.6. Boot Menu**).

**IMPORTANT:** For UltraDMA/100/66 IDE devices, use a 40-pin 80-conductor IDE cable. The UltraDMA/66 cable included in the motherboard package also supports UltraDMA/100.

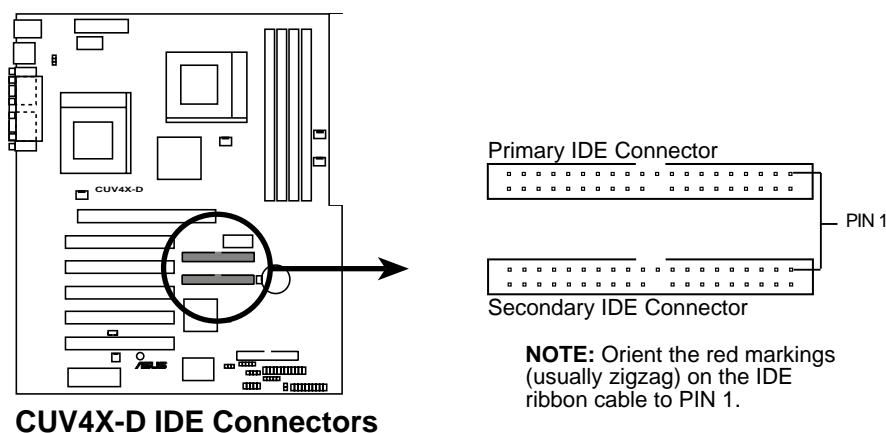



# 3. HARDWARE SETUP

## 4) Wake-On-LAN Connector (3-pin WOL\_CON)

This connector connects to a LAN card with a Wake-On-LAN output, such as the ASUS PCI-L101 Ethernet card (see 7. *Appendix*). The connector powers up the system when a wakeup packet or signal is received through the LAN card.

**IMPORTANT:** This feature requires that the **Wake-On-LAN** field is enabled (see 4.5.1 *Power Up Control*) and that the system has an ATX power supply with at least 720mA +5V standby power.

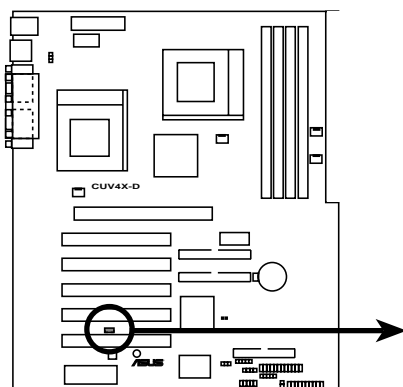

**CUV4X-D Wake-On-LAN Connector**

**IMPORTANT:** Requires an ATX power supply with at least 720mA +5 volt standby power.

WOL\_CON

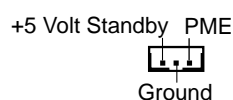

## 5) Wake-On-Ring Connector (2-pin WOR)

This connector connects to internal modem cards with a Wake-On-Ring output. The connector powers up the system when a ringup packet or signal is received through the internal modem card. **NOTE:** For external modems, Wake-On-Ring is detected through the COM port.

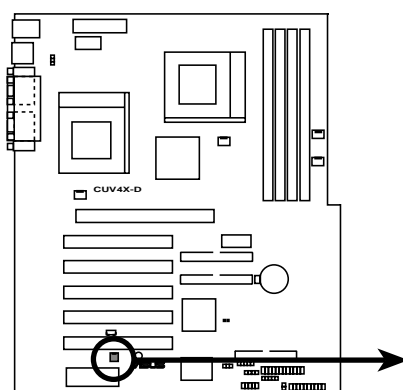

**CUV4X-D Wake-On-Ring Connector**

WOR

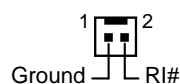

# 3. HARDWARE SETUP

## 6) CPU and Chassis Fan Connectors

The two 3-pin fan connectors (CPU\_FAN, CHA\_FAN) support cooling fans of 350mA (4.2 Watts) or less. Orient the fans so that the heat sink fins allow airflow to go across the onboard heat sink(s) instead of the expansion slots. The fan wiring and plug may vary depending on the fan manufacturer. The red wire should be positive while the black should be ground. Connect the fan plug to the board taking into consideration the polarity of the connector.

**NOTE:** Use the “Rotation” signal only with a specially designed fan with a rotation signal. The Rotations Per Minute (RPM) can be monitored using ASUS PC Probe (see 6. *SOFTWARE REFERENCE*).

**WARNING!** The CPU and/or motherboard will overheat if there is no airflow across the CPU and onboard heatsinks. Damage may occur to the motherboard and/or the CPU fan if these pins are incorrectly used. **These are not jumpers, do not place jumper caps over these pins.**

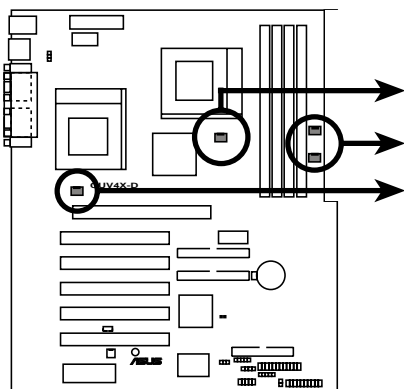

CPU\_FAN  
CPU\_FAN2  
CHA\_FAN  
PWR\_FAN

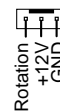

CUV4X-D 12-Volt Cooling Fan Power

## 7) USB Header (10-1 pin USBPORT)

If the USB port connectors on the back panel are inadequate, one USB header is available for two additional USB port connectors. Connect the USB header to a 2-port USB connector set and mount the bracket to an open slot in the chassis. (The USB connector set is optional and does not come with the motherboard package.)

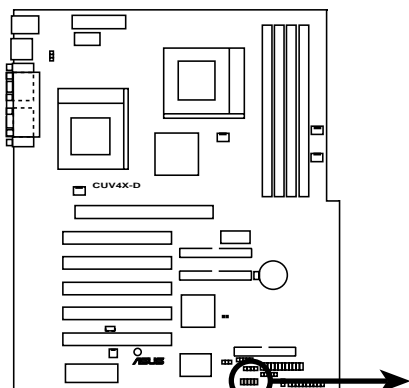

USBPORT

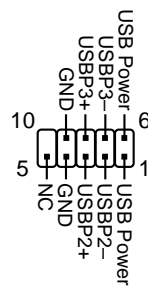

CUV4X-D Front Panel USB Header

# 3. HARDWARE SETUP

## 8) Standard Infrared Module Connector (5-pin IR)

This connector supports an optional wireless transmitting and receiving infrared module. This module mounts to a small opening on system cases that support this feature. You must also configure the setting through **UART2 Use Infrared** (see **4.4.2 I/O Device Configuration**) to select whether UART2 is directed for use with COM2 or IrDA. Use the five pins as shown in Back View and connect a ribbon cable from the module to the motherboard SIR connector according to the pin definitions.

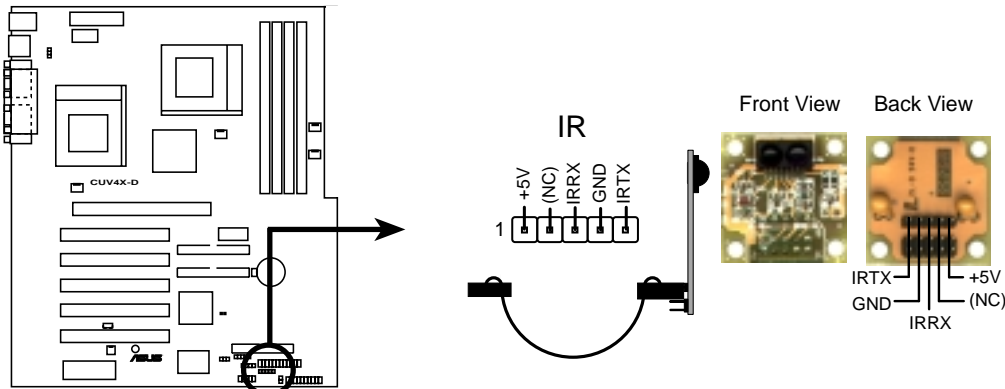

**CUV4X-D Infrared Module Connector**

## 9) Chassis Intrusion Lead (4-1 pin CHASSIS)

This lead is for a chassis designed for chassis intrusion detection. This requires an external detection mechanism such as a chassis intrusion monitor/sensor or microswitch. When any chassis component is removed, the sensor is triggered and a high-level signal is sent to this lead to record a chassis intrusion event. The event is then be processed by software such as LDCM. When not using the chassis intrusion lead, place a jumper cap over the pins to close the circuit.

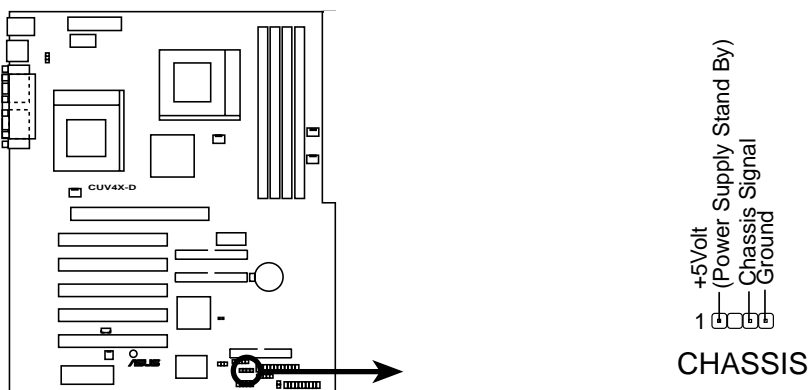

**CUV4X-D Chassis Open Alarm Lead**

# 3. HARDWARE SETUP

## 10) Power Supply Connectors (20-pin block ATXPWR, 6-pin EAUXPWR)

These connectors connect to an ATX 12V power supply. The plugs from the power supply fits in only one orientation because of the different hole sizes. Find the proper orientation and push down firmly making sure that the pins are aligned.

**IMPORTANT:** Make sure that the ATX 12V power supply (minimum recommended wattage: 230W) can supply at least 10mA on the +5-volt standby lead (+5VSB). The system may become unstable and may experience difficulty powering up if the power supply is inadequate. For Wake-On-LAN support, the ATX power supply must supply at least 720mA +5VSB.

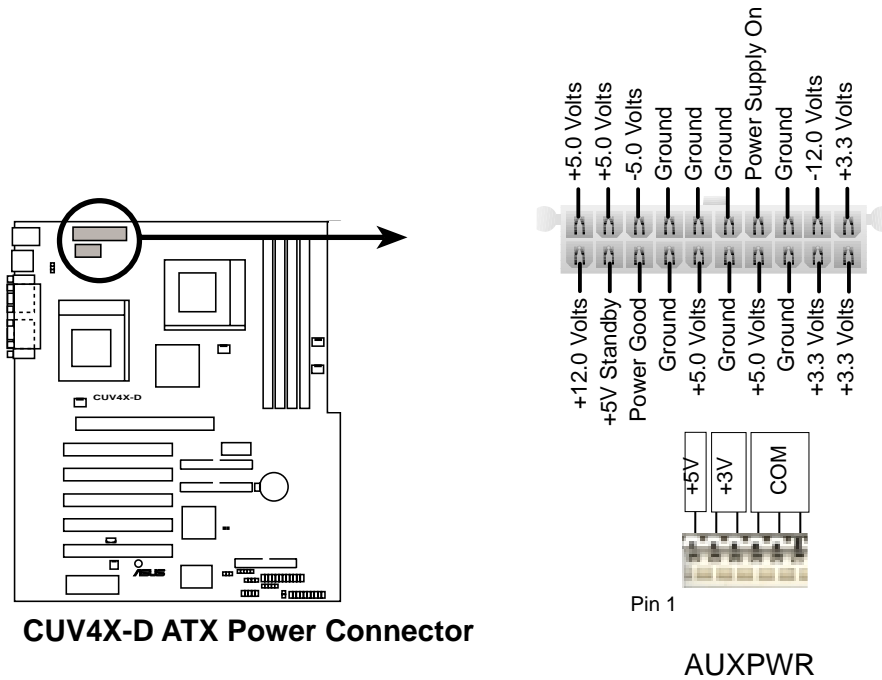

# 3. HARDWARE SETUP

## 11) SMBus Connector (5-1 pin SMB)

This connector allows you to connect SMBus (System Management Bus) devices. SMBus devices communicate by means of the SMBus with an SMBus host and/or other SMBus devices. SMBus is a specific implementation of an I<sup>2</sup>C bus, which is a multi-device bus; that is, multiple chips can be connected to the same bus and each one can act as a master by initiating data transfer.

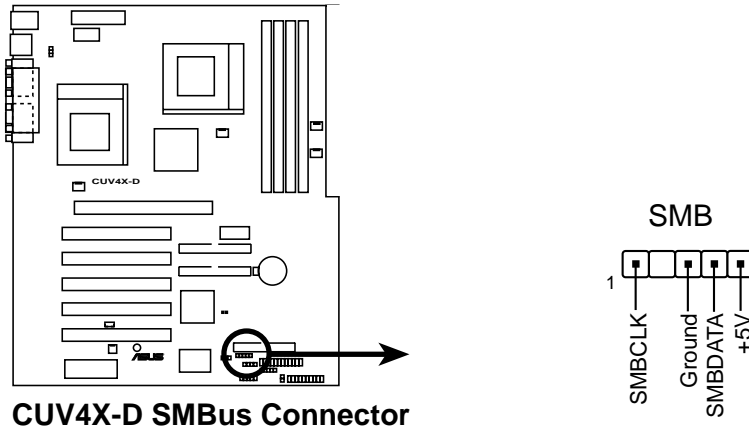

## 12) ASUS iPanel Connector (12-1 pin AFPANEL)

This connector allows you to connect an optional ASUS iPanel, an easy-to-access drive bay with front I/O ports, status LEDs, and space reserved for a hard disk drive. If you are not using an ASUS iPanel, you can connect an optional wireless transmitting and receiving infrared module to the SIR connector, or an optional consumer infrared connector set to the CIR or SIR connectors for both wireless transmitting and remote control functions through one external infrared module.

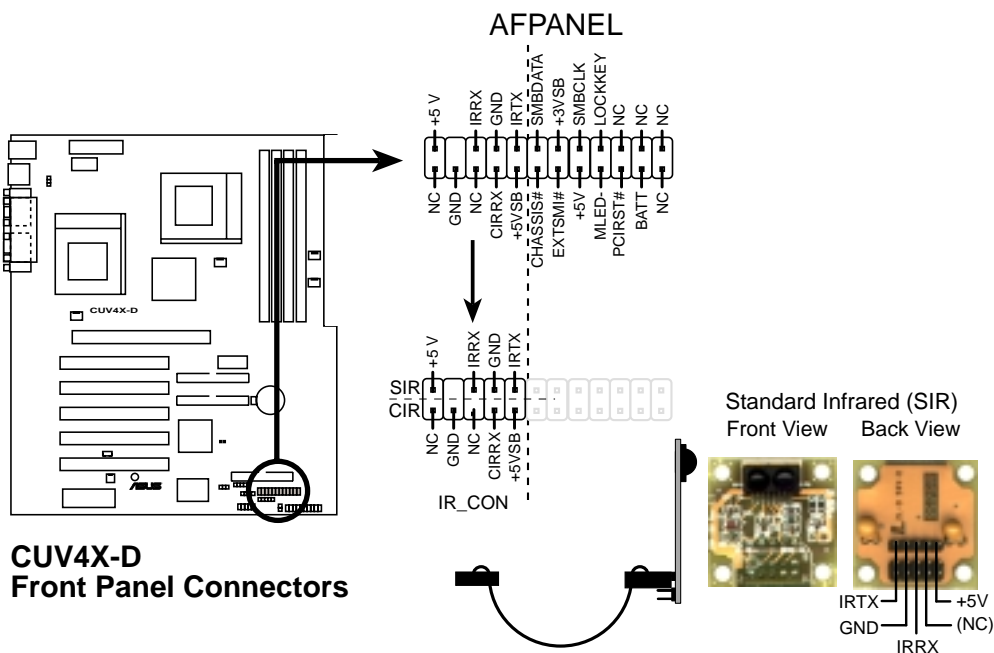

# 3. HARDWARE SETUP

The following 20-pin PANEL illustration is for items 13-18.

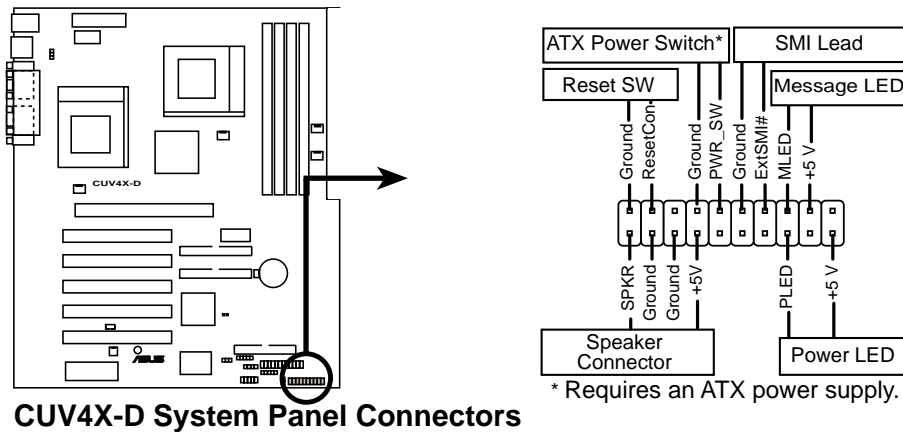

## 13) System Power LED Connector (3-1 pin PWR.LED)

This 3-1 pin connector connects to the system power LED. The LED lights up when you turn on the system power, and blinks when the system is in sleep or soft-off mode.

## 14) System Warning Speaker Connector (4-pin SPEAKER)

This 4-pin connector connects to the case-mounted speaker.

## 15) System Message LED Connector (2-pin MSG.LED)

This 2-pin connector is for the system message LED that indicates receipt of messages from a fax/modem. The normal status for this LED is ON, when there is no incoming data signal. The LED blinks when there is data received. The system message LED feature requires an ACPI OS and driver support.

## 16) System Management Interrupt Connector (2-pin SMI)

This 2-pin connector allows you to manually place the system into a suspend mode, or “Green” mode, where system activity is instantly decreased to save power and to expand the life of certain system components. Attach the case-mounted suspend switch this 2-pin connector.

## 17) ATX Power Switch / Soft-Off Switch Connector (2-pin PWR.SW)

The system power is controlled by a momentary switch attached to this connector. Pressing the button switches the system between ON and SLEEP, or ON and SOFT OFF, depending on the BIOS or OS settings. Pressing the button while in the ON mode for more than 4 seconds turns the system off.

## 18) Reset Switch Connector (2-pin RESET)

This 2-pin connector connects to the case-mounted reset switch for rebooting the system without turning off the power switch. This is a preferred method

# 3. HARDWARE SETUP

## 3.9 Starting Up the First Time

1. After making all the connections, replace the system case cover.
2. Be sure that all switches are off (in some systems, marked with ○).
3. Connect the power cord to the power supply located at the back of the system chassis.
4. Connect the power cord to a power outlet that is equipped with a surge protector.
5. Turn on the devices in the following order:
  - a. Monitor
  - b. External SCSI devices (starting with the last device on the chain)
  - c. System power (For ATX power supplies, you need to switch on the power supply as well as press the ATX power switch on the front of the chassis.)
6. The power LED on the front panel of the system case lights up. For ATX power supplies, the system LED lights up when you press the ATX power switch. If the monitor complies with “green” standards or if it has a power standby feature, the monitor LED may light up or switch between orange and green after the system LED does. The system then runs the power-on tests. While the tests are running, the BIOS beeps or additional messages appears on the screen. If you do not see anything within 30 seconds from the time you turn on the power, the system may have failed a power-on test. Recheck your jumper settings and connections or call your retailer for assistance.

### *Award BIOS Beep Codes*

<b>Beep</b>	<b>Meaning</b>
One short beep when displaying logo	No error during POST
Long beeps in an endless loop	No DRAM installed or detected
One long beep followed by three short beeps	Video card not found or video card memory bad
High frequency beeps when system is working	CPU overheated System running at a lower frequency

## 3. HARDWARE SETUP

---

7. At power on, hold down <Delete> to enter BIOS Setup. Follow the instructions in **4. BIOS SETUP**.

- \* **Powering Off your computer:** You must first exit or shut down your operating system before switching off the power switch. For ATX power supplies, you can press the ATX power switch after exiting or shutting down your operating system. If you use Windows 9X, click the **Start** button, click **Shut Down**, and then click **Shut down the computer?** The power supply should turn off after Windows shuts down.

**NOTE:** The message “You can now safely turn off your computer” does not appear when shutting down with ATX power supplies.



# 4. BIOS SETUP

## 4.1 Managing and Updating Your BIOS

### 4.1.1 Upon First Use of the Computer System

It is recommended that you save a copy of the original motherboard BIOS along with a Flash Memory Writer utility (AFLASH.EXE) to a bootable floppy disk in case you need to reinstall the BIOS later. **AFLASH.EXE** is a Flash Memory Writer utility that updates the BIOS by uploading a new BIOS file to the programmable flash ROM on the motherboard. This file works only in DOS mode. To determine the BIOS version of your motherboard, check the last four numbers of the code displayed on the upper left-hand corner of your screen during bootup. Larger numbers represent a newer BIOS file.

1. Type **FORMAT A:/S** at the DOS prompt to create a bootable system disk. **DO NOT** copy AUTOEXEC.BAT and CONFIG.SYS to the disk.
2. Type **COPY D:\AFLASH\AFLASH.EXE A:\** (assuming D is your CD-ROM drive) to copy AFLASH.EXE to the boot disk you created.  
**NOTE:** AFLASH works only in DOS mode. It does not work in the DOS prompt within Windows and does not work with certain memory drivers that may be loaded when you boot from the hard drive. It is recommended that you reboot using a floppy disk.
3. Reboot the computer from the floppy disk.

**NOTE:** BIOS setup must specify “Floppy” as the first item in the boot sequence.

4. In DOS mode, type **A:\AFLASH <Enter>** to run AFLASH.

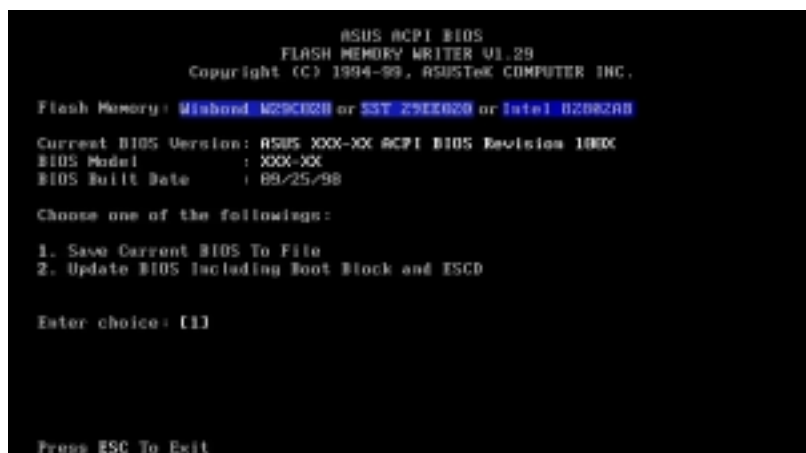

```
ASUS ACPI BIOS
FLASH MEMORY WRITER V1.29
Copyright (C) 1994-99, ASUS/tek COMPUTER INC.

Flash Memory: Winbond W29C020 or SST 29EX020 or Intel B20820B

Current BIOS Version: ASUS XXX-XX ACPI BIOS Revision 100X
BIOS Model          : XXX-XX
BIOS Built Date     : 99/25/98

Choose one of the following:
1. Save Current BIOS To File
2. Update BIOS Including Boot Block and ESCD

Enter choice: [1]

Press ESC To Exit
```

**IMPORTANT!** If the word “unknown” appears after **Flash Memory:**, the memory chip is either not programmable or is not supported by the ACPI BIOS and therefore, cannot be programmed by the Flash Memory Writer utility.

## 4. BIOS SETUP

---

5. Select **1. Save Current BIOS to File** from the Main menu and press <Enter>. The **Save Current BIOS To File** screen appears.

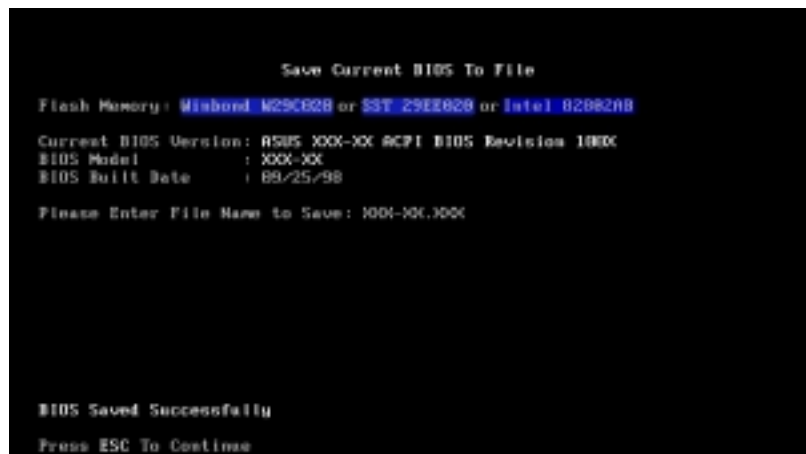

6. Type a filename and the path, for example, **A:\XXX-XX.XXX** and then press <Enter>.

# 4. BIOS SETUP

## 4.1.2 Updating BIOS Procedures

**WARNING!** Update the BIOS only if you have problems with the motherboard and you know that the new BIOS revision will solve your problems. Careless updating can result in your motherboard having more problems!

1. Download an updated ASUS BIOS file from the Internet (WWW or FTP) (see ASUS CONTACT INFORMATION on page 3 for details) and save to the boot floppy disk you created earlier.
2. Boot from the floppy disk.
3. At the “A:\” prompt, type **AFLASH** and then press <Enter>.
4. At the **Main Menu**, type **2** then press <Enter>. The **Update BIOS Including Boot Block and ESCD** screen appears.
5. Type the filename of your new BIOS and the path, for example, **A:\XXX-XX.XXX**, then press <Enter>.

**NOTE:** To cancel this operation, press <Enter>.

```
Update BIOS Including Boot Block and ESCD
Flash Memory: Winbond W29C02B or SST 29EE02B or Intel 82802AB
Current BIOS Version: ASUS XXX-XX ACPI BIOS Revision 180X
BIOS Model          : XXX-XX
BIOS Built Date     : 09/25/98
Please Enter File Name for NEW BIOS: a:\XXX-XX.XXX
```

6. When prompted to confirm the BIOS update, press **Y** to start the update.

```
Update BIOS Including Boot Block and ESCD
Flash Memory: Winbond W29C02B or SST 29EE02B or Intel 82802AB
BIOS Version
(CURRENT ) ASUS XXX-XX ACPI BIOS Revision 180X
(test.awd) ASUS XXX-XX ACPI BIOS Revision 180X
BIOS Model
(CURRENT ) XXX-XX
(test.awd) XXX-XX
Date of BIOS Built
(CURRENT ) 09/25/98
(test.awd) 05/29/98
Notice: Boot Block is different. Check sum of 1801.010 is F266.
Are you sure (Y/N) ? [Y]
Press ESC To Return to Main Menu
```

4. BIOS SETUP  
Updating BIOS

# 4. BIOS SETUP

- The utility starts to program the new BIOS information into the Flash ROM. The boot block is updated automatically only when necessary. This minimizes the possibilities of boot problems in case of update failures. When the programming is done, *Flashed Successfully* appears.

```
Update BIOS Including Boot Block and ESCD
Flash Memory: Winbond W29C020 or SST 29EE020 or Intel B28020B
BIOS Version
(CURRENT) ASUS XXX-XX ACPI BIOS Revision 100X
(Ftest.amd) ASUS XXX-XX ACPI BIOS Revision 100X
BIOS Model
(CURRENT) XXX-XX
(Ftest.amd) XXX-XX
Date of BIOS Built
(CURRENT) 05/25/98
(FH0001.X001) 05/29/98
Notice: Boot Block is different. Check sum of 1001.010 is F266.
Are you sure (Y/N) ? Y
Block Erasing -- Done
Programming -- 3FFFF
Flashed Successfully
Press ESC To Continue
```

- Follow the onscreen instructions to continue.

```
ASUS ACPI BIOS
FLASH MEMORY WRITER V1.20
Copyright (C) 1994-99, ASUSTeK COMPUTER INC.
Flash Memory: Winbond W29C020 or SST 29EE020 or Intel B28020B
Current BIOS Version: ASUS XXX-XX ACPI BIOS Revision 100X
BIOS Model : XXX-XX
BIOS Built Date : 05/29/98
Choose one of the following:
1. Save Current BIOS To File
2. Update BIOS Including Boot Block and ESCD
Enter choice: [1]
You have flashed the EPROM. It is recommended that you turn off
the power, enter SETUP and Load Setup Defaults to have CMOS
updated with new BIOS when exits.
Press ESC To Exit
```

**WARNING!** If you encounter problems while updating the new BIOS, DO NOT turn off the system because this may cause boot problems. Just repeat the process, and if the problem still persists, load the original BIOS file you saved to the boot disk. If the Flash Memory Writer utility is not able to successfully update a complete BIOS file, the system may not boot. If this happens, call the ASUS service center for support.

# 4. BIOS SETUP

---

## 4.2 BIOS Setup Program

This motherboard supports a programmable EEPROM that you can update using the provided utility described in *4.1 Managing and Updating Your BIOS*.

The utility is used if you are installing a motherboard, reconfiguring your system, or prompted to “**Run Setup**”. This section describes how to configure your system using this utility.

Even if you are not prompted to use the Setup program, at some time in the future you may want to change the configuration of your computer. For example, you may want to enable the Security Password Feature or make changes to the power management settings. It will then be necessary to reconfigure your system using the BIOS Setup program so that the computer can recognize these changes and record them in the CMOS RAM of the EEPROM.

The EEPROM on the motherboard stores the Setup utility. When you start up the computer, the system provides you with the opportunity to run this program. This appears during the Power-On Self Test (POST). Press <Delete> to call up the Setup utility. If you are a little bit late in pressing the mentioned key, POST will continue with its test routines, thus preventing you from calling up Setup. If you still need to call Setup, restart the system by pressing <Ctrl> + <Alt> + <Delete>, or by pressing the Reset button on the system chassis. You can also restart by turning the system off and then back on again. But do so only if the first two methods fail.

The Setup program has been designed to make it as easy to use as possible. It is a menu-driven program, which means you can scroll through the various sub-menus and make your selections among the predetermined choices.

**To access the BIOS Setup program, press the <Delete> key after the computer has run through its POST.**

**NOTE:** Because the BIOS software is constantly being updated, the following BIOS setup screens and descriptions are for reference purposes only, and may not exactly match what you see on your screen.

# 4. BIOS SETUP

---

## 4.2.1 BIOS Menu Bar

The top of the screen has a menu bar with the following selections:

- MAIN** Use this menu to make changes to the basic system configuration.
- ADVANCED** Use this menu to enable and make changes to the advanced features.
- POWER** Use this menu to configure and enable Power Management features.
- BOOT** Use this menu to configure the default system device used to locate and load the Operating System.
- EXIT** Use this menu to exit the current menu or specify how to exit the Setup program.

To access the menu bar items, press the right or left arrow key on the keyboard until the desired item is highlighted.

## 4.2.2 Legend Bar

At the bottom of the Setup screen is a legend bar. The keys in the legend bar allow you to navigate through the various setup menus. The following table lists the keys found in the legend bar with their corresponding functions.

Navigation Key(s)	Function Description
<F1> or <Alt + H>	Displays the General Help screen from anywhere in the BIOS Setup
<Esc>	Jumps to the Exit menu or returns to the main menu from a sub-menu
← or → (keypad arrow)	Selects the menu item to the left or right
↑ or ↓ (keypad arrow)	Moves the highlight up or down between fields
- (minus key)	Scrolls backward through the values for the highlighted field
+ (plus key) or spacebar	Scrolls forward through the values for the highlighted field
<Enter>	Brings up a selection menu for the highlighted field
<Home> or <PgUp>	Moves the cursor to the first field
<End> or <PgDn>	Moves the cursor to the last field
<F5>	Resets the current screen to its Setup Defaults
<F10>	Saves changes and exits Setup

# 4. BIOS SETUP

---

## General Help

In addition to the Item Specific Help window, the BIOS setup program also provides a General Help screen. You may launch this screen from any menu by simply pressing <F1> or the <Alt> + <H> combination. The General Help screen lists the legend keys with their corresponding functions.

## Saving Changes and Exiting the Setup Program

See *4.7 Exit Menu* for detailed information on saving changes and exiting the setup program.

## Scroll Bar

When a scroll bar appears to the right of a help window, it indicates that there is more information to be displayed that will not fit in the window. Use <PgUp> and <PgDn> or the up and down arrow keys to scroll through the entire help document. Press <Home> to display the first page, press <End> to go to the last page. To exit the help window, press <Enter> or <Esc>.

## Sub-Menu

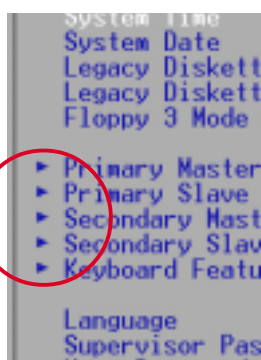

Note that a right pointer symbol (as shown in the left view) appears to the left of certain fields. This pointer indicates that you can display a sub-menu from this field. A sub-menu contains additional options for a field parameter. To display a sub-menu, move the highlight to the field and press <Enter>. The sub-menu appears. Use the legend keys to enter values and move from field to field within a sub-menu as you would within a menu. Use the <Esc> key to return to the main menu.

Take some time to familiarize yourself with the legend keys and their corresponding functions. Practice navigating through the various menus and sub-menus. If you accidentally make unwanted changes to any of the fields, use the set default hot key <F5> to load the Setup default values. While moving around through the Setup program, note that explanations appear in the Item Specific Help window located to the right of each menu. This window displays the help text for the currently highlighted field.

**NOTE:** The item heading in square brackets represents the default setting for that field.

# 4. BIOS SETUP

## 4.3 Main Menu

When you enter the Setup program, the following screen appears:

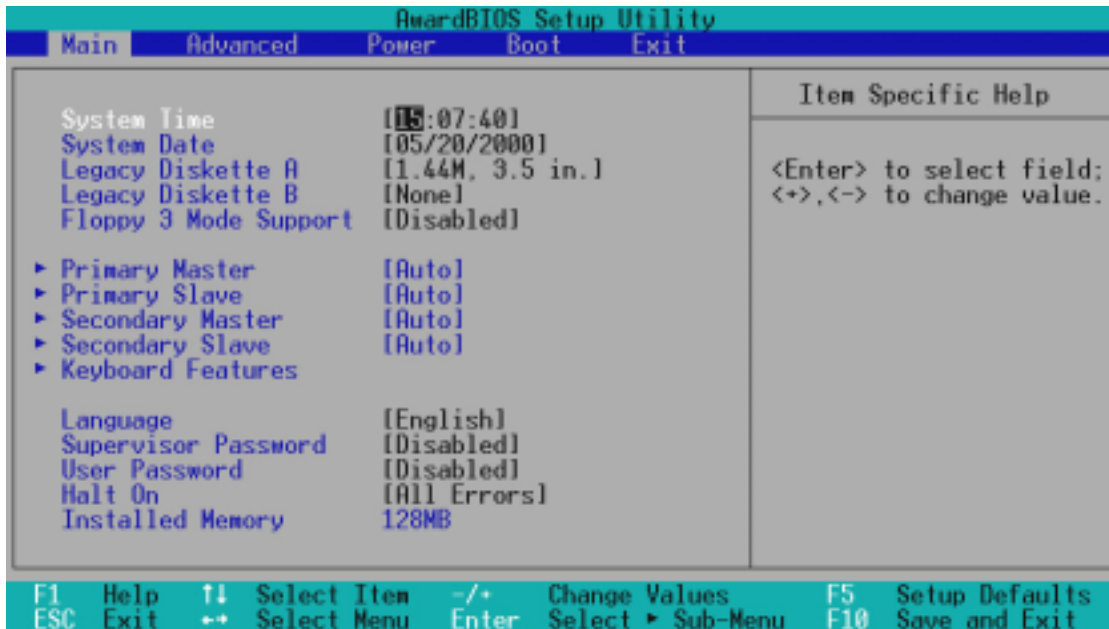

### System Time [XX:XX:XX]

Sets the system to the time that you specify (usually the current time). The format is hour, minute, second. Valid values for hour, minute and second are **Hour: (00 to 23)**, **Minute: (00 to 59)**, **Second: (00 to 59)**. Use the <Tab> or <Shift> + <Tab> keys to move between the hour, minute, and second fields.

### System Date [XX/XX/XXXX]

Sets the system to the date that you specify (usually the current date). The format is month, day, year. Valid values for month, day, and year are **Month: (1 to 12)**, **Day: (1 to 31)**, **Year: (100 year range)**. Use the <Tab> or <Shift> + <Tab> keys to move between the month, day, and year fields.

### Legacy Diskette A [1.44M, 3.5 in.], Legacy Diskette B [None]

Sets the type of floppy drives installed. Configuration options: [None] [360K, 5.25 in.] [1.2M, 5.25 in.] [720K, 3.5 in.] [1.44M, 3.5 in.] [2.88M, 3.5 in.]

### Floppy 3 Mode Support [Disabled]

This is required to support older Japanese floppy drives. The Floppy 3 Mode feature allows reading and writing of 1.2MB (as opposed to 1.44MB) on a 3.5-inch diskette. Configuration options: [Disabled] [Enabled]



# 4. BIOS SETUP

## 4.3.1 Primary & Secondary Master/Slave

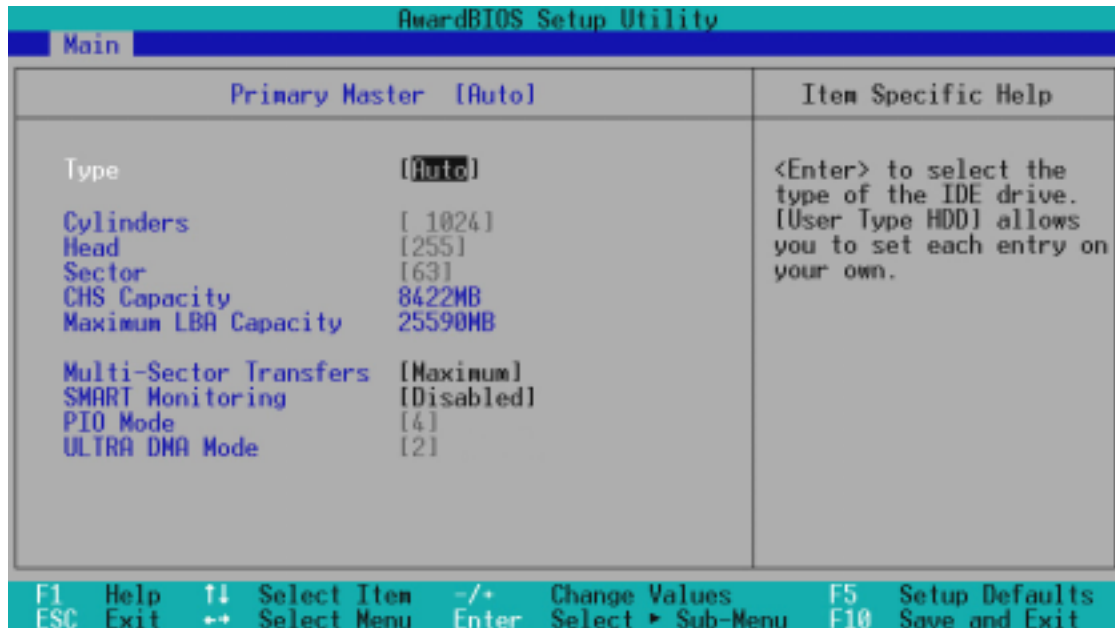

**NOTE:** Before attempting to configure a hard disk drive, make sure you have the configuration information supplied by the drive manufacturer. Incorrect settings may cause the system to fail to recognize the installed hard disk. To allow the BIOS to detect the drive type automatically, select [Auto].

### Type [Auto]

Select [Auto] to automatically detect an IDE hard disk drive. If automatic detection is successful, Setup automatically fills in the correct values for the remaining fields on this sub-menu. If automatic detection fails, this may be because the hard disk drive is too old or too new. Try updating the BIOS or manually entering the IDE hard disk drive parameters.

**NOTE:** After entering the IDE hard disk drive information into BIOS, use a disk utility, such as FDISK, to partition and format new IDE hard disk drives. This is necessary so that you can write or read data from the hard disk. Make sure to set the partition of the Primary IDE hard disk drives to active.

Other options for the **Type** field are:

-----  
**[None]** - to disable IDE devices

# 4. BIOS SETUP

**IMPORTANT:** If the hard disk was already formatted on an older system, Setup may detect incorrect parameters. You will need to enter the correct parameters manually, or use low-level format in case you do not need the data stored on the hard disk. If the parameters listed differ from the ones used when the disk was formatted, the disk will not be readable. If the auto-detected parameters do not match the ones that should be used for the disk, you should enter the correct ones manually by setting [User Type HDD].

## [User Type HDD]

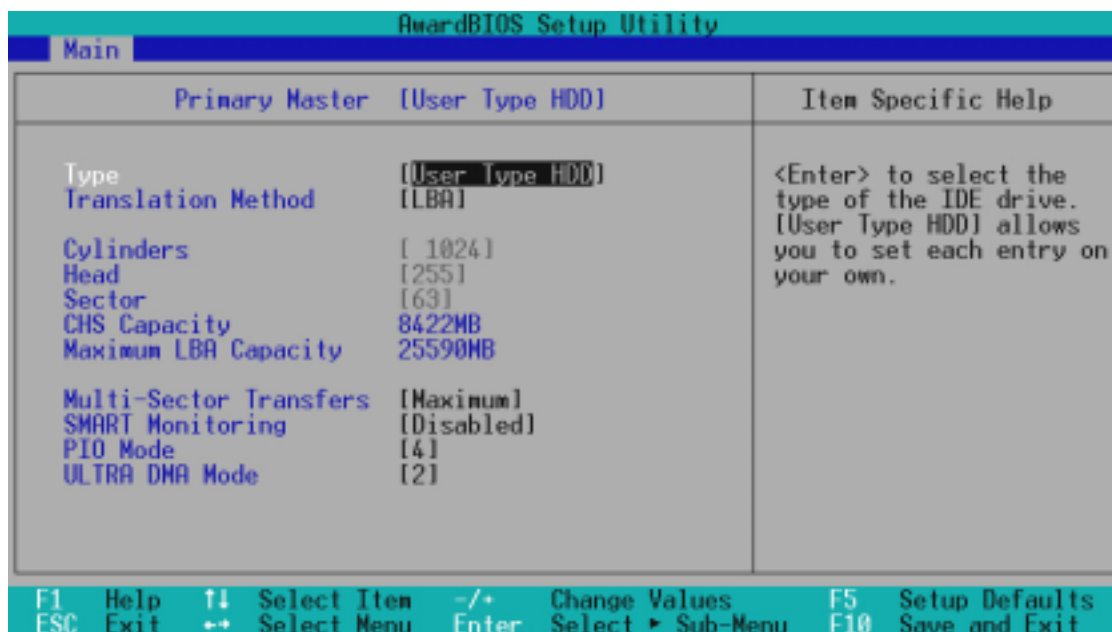

Manually enter the number of cylinders, heads and sectors per track for the drive. Refer to the drive documentation or on the drive label for this information. If no drive is installed or if you are removing a drive and not replacing it, select [None].

### Translation Method [LBA]

Select the hard disk drive type in this field. When Logical Block Addressing is enabled, 28-bit addressing of the hard drive disregarding cylinders, heads, or sectors. Note that LBA Mode is necessary for drives with more than 504MB storage capacity. Configuration options: [LBA] [LARGE] [Normal] [Match Partition Table] [Manual]

### Cylinders

This field configures the number of cylinders. Refer to the drive documentation to determine the correct value to enter into this field. **NOTE:** To make changes to this field, set the **Type** field to [User Type HDD] and the **Translation Method** field to [Manual].

## 4. BIOS SETUP

---

### **Head**

This field configures the number of read/write heads. Refer to the drive documentation to determine the correct value to enter into this field. **NOTE:** To make changes to this field, set the **Type** field to [User Type HDD] and the **Translation Method** field to [Manual].

### **Sector**

This field configures the number of sectors per track. Refer to the drive documentation to determine the correct value to enter into this field. **NOTE:** To make changes to this field, set the **Type** field to [User Type HDD] and the **Translation Method** field to [Manual].

### **CHS Capacity**

This field shows the drive's maximum CHS capacity as calculated by the BIOS based on the drive information you entered.

### **Maximum LBA Capacity**

This field shows the drive's maximum LBA capacity as calculated by the BIOS based on the drive information you entered.

### **Multi-Sector Transfers [Maximum]**

This option automatically sets the number of sectors per block to the highest number that the drive supports. Note that when this field is automatically configured, the set value may not always be the fastest value for the drive. You may also manually configure this field. Refer to the documentation that came with the hard drive to determine the optimum value and set it manually. **NOTE:** To make changes to this field, set the **Type** field to [User Type HDD]. Configuration options: [Disabled] [2 Sectors] [4 Sectors] [8 Sectors] [16 Sectors] [32 Sectors] [Maximum]

### **SMART Monitoring [Disabled]**

This field allows you to enable or disable the S.M.A.R.T. (Self-Monitoring, Analysis and Reporting Technology) system that utilizes internal hard disk drive monitoring technology. This parameter is normally disabled because the resources used in the SMART monitoring feature may decrease system performance. Configuration options: [Disabled] [Enabled]

### **PIO Mode [4]**

This option lets you set a PIO (Programmed Input/Output) mode for the IDE device. Modes 0 through 4 provide successively increased performance. Configuration options: [0] [1] [2] [3] [4]

### **Ultra DMA Mode [Disabled]**

Ultra DMA capability allows improved transfer speeds and data integrity for compatible IDE devices. Set to [Disabled] to suppress Ultra DMA capability. **NOTE:** To make changes to this field, set the **Type** field to [User Type HDD]. Configuration options: [0] [1] [2] [3] [4] [5] [Disabled]

# 4. BIOS SETUP

Other options for “Type:” are:

[CD-ROM] - for IDE CD-ROM drives

[LS-120] - for LS-120 compatible floppy disk drives

[ZIP-100] - for ZIP-100 compatible disk drives

[MO] - for IDE magneto optical disk drives

[Other ATAPI Device] - for IDE devices not listed here

After making your selections on this sub-menu, press the <Esc> key to return to the Main menu. When the Main menu appears, the hard disk drive field displays the size for the hard disk drive that you configured.

## 4.3.2 Keyboard Features

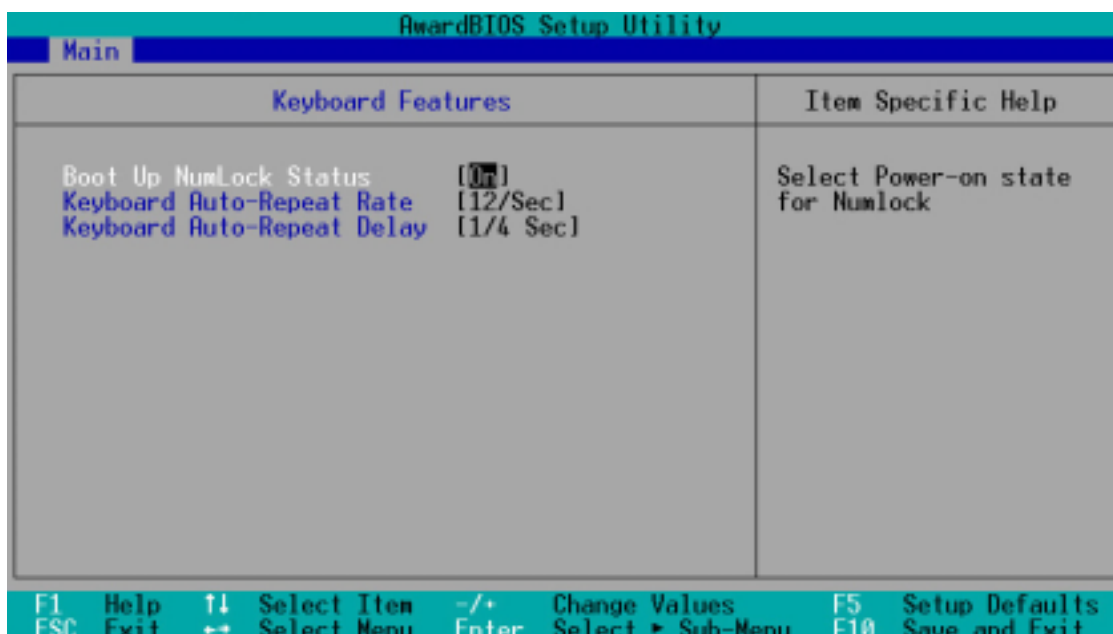

### Boot Up NumLock Status [On]

This field enables users to activate the Number Lock function upon system boot. Configuration options: [Off] [On]

### Keyboard Auto-Repeat Rate [12/Sec]

This controls the speed at which the system registers repeated keystrokes. Options range from 6 to 30 characters per second. Configuration options: [6/Sec] [8/Sec] [10/Sec] [12/Sec] [15/Sec] [20/Sec] [24/Sec] [30/Sec]

### Keyboard Auto-Repeat Delay [1/4 Sec]

This field sets the time interval for displaying the first and second characters. Configuration options: [1/4 Sec] [1/2 Sec] [3/4 Sec] [1 Sec]

# 4. BIOS SETUP

## Language [English]

This field displays the BIOS language version.

## Supervisor Password [Disabled] / User Password [Disabled]

These fields allow you to set passwords. To set a password, highlight the appropriate field and press <Enter>. Type in a password then press <Enter>. You can type up to eight alphanumeric characters. Symbols and other characters are ignored. To confirm the password, type the password again and press <Enter>. The password is now set to [Enabled]. This password allows full access to the BIOS Setup menus. To clear the password, highlight this field and press <Enter>. The same dialog box as above appears. Press <Enter>. The password is set to [Disabled].

### A Note about Passwords

The BIOS Setup program allows you to specify passwords in the Main menu. The passwords control access to the BIOS during system startup. Passwords are not case sensitive, meaning, it makes no difference whether you the password using uppercase or lowercase letters. The BIOS Setup program allows you to specify two different passwords: a Supervisor password and a User password. If you did not set a Supervisor password, anyone can access the BIOS Setup program. If you did, the Supervisor password is required to enter the BIOS Setup program and to gain full access to the configuration fields.

### Forgot the Password?

If you forget your password, you can clear it by erasing the CMOS Real Time Clock (RTC) RAM. The RAM data containing the password information is powered by the onboard button cell battery. To erase the RTC RAM: (1) Turn OFF and unplug the computer, (2) Short the solder points on the motherboard, (3) Turn ON the computer, (4) Hold down <Delete> during the boot process and enter BIOS Setup to re-enter user preferences.

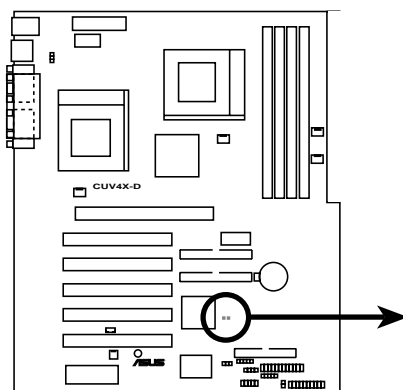

CUV4X-D Clear RTC RAM

R153



Short solder points  
to Clear CMOS

## Halt On [All Errors]

This field specifies the types of errors that will cause the system to halt. Configuration options: [All Errors] [No Error] [All but Keyboard] [All but Disk] [All but Disk/Keyboard]

## Installed Memory [XXX MB]

This field automatically displays the amount of conventional memory detected by the system during the boot process.

# 4. BIOS SETUP

## 4.4 Advanced Menu

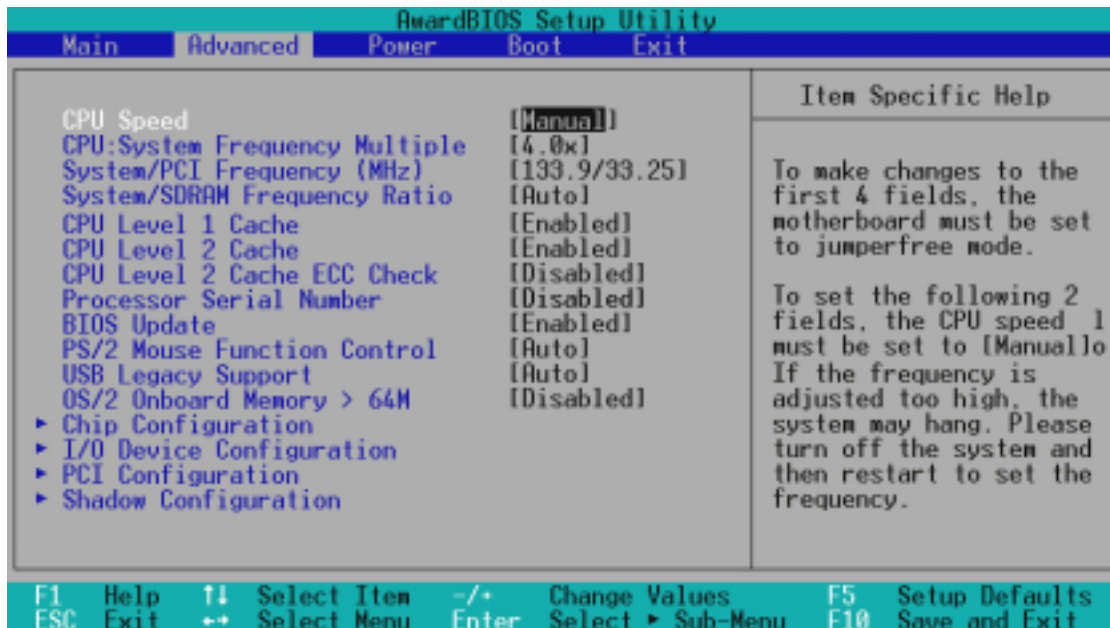

### CPU Speed [Manual]

When the motherboard is set to JumperFree™ mode, this field allows you to select the internal frequency of your CPU. Available options include multiples of 66, 100, and 133. Select [Manual] if you want to make changes to the two subsequent fields. Note that selecting a frequency higher than the CPU manufacturer recommends may cause the system to hang or crash.

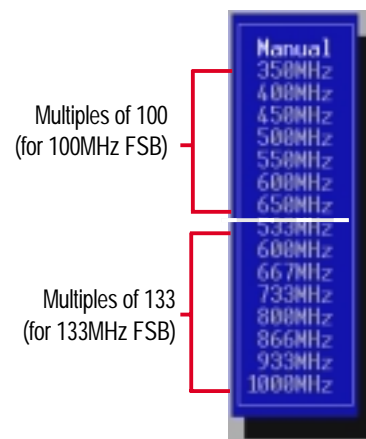

### CPU : System Frequency Multiple (when CPU Speed is set to [Manual])

This field is for unlocked processors only. If your processor frequency multiple is detected locked, you cannot access this field. This field sets the frequency multiple between the CPU's *internal* frequency (CPU speed) and *external* frequency. Set this field in conjunction with **System/PCI Frequency (MHz)** to match the speed of the CPU. Configuration options: [2.0x] [2.5x] [3.0x]...[7.0x] [7.5x] [8.0x]

### System/PCI Frequency (MHz) (when CPU Speed is set to [Manual])

This feature tells the clock generator what frequency to send to the system bus and PCI bus. The bus frequency (external frequency) multiplied by the bus multiple equals the **CPU speed**.

## 4. BIOS SETUP

---

### **System/SDRAM Frequency Ratio [Auto]**

This field determines whether the memory clock frequency is set to be in synchronous or asynchronous mode with respect to the system frequency. The options that appear in the popup menu vary according to the **System/PCI Frequency (MHz)**.

### **CPU Level 1 Cache, CPU Level 2 Cache [Enabled]**

These fields allow you to choose from the default of [Enabled] or choose [Disabled] to turn on or off the CPU Level 1 and Level 2 built-in cache. Configuration options: [Disabled] [Enabled]

### **CPU Level 2 Cache ECC Check [Disabled]**

This function controls the ECC capability in the CPU level 2 cache. Configuration options: [Disabled] [Enabled]

### **Processor Serial Number [Disabled]**

The Processor Serial Number is a unique number added to every Pentium III processor to help verify the identity of the user across the Internet. Set this field to [Enabled] when you need increased security for doing business online or e-commerce. Otherwise, leave it to its default setting [Disabled] for greater anonymity when surfing the Internet.

**NOTE:** This field is available only when a Pentium III processor is installed in the system.

### **BIOS Update [Enabled]**

This field functions as an update loader integrated into the BIOS to supply the processor with the required data. When set to [Enabled], the BIOS loads the update on all processors during system bootup. Configuration options: [Disabled] [Enabled]

### **PS/2 Mouse Function Control [Auto]**

The default setting [Auto] allows the system to detect a PS/2 mouse at startup. If a mouse is detected, the BIOS assigns IRQ12 to the PS/2 mouse. Otherwise, IRQ12 can be used for expansion cards. When you set this field to [Enabled], BIOS always reserves IRQ12, whether or not a PS/2 mouse is detected at startup. Configuration options: [Enabled] [Auto]



# 4. BIOS SETUP

## USB Legacy Support [Auto]

This motherboard supports Universal Serial Bus (USB) devices. The default of [Auto] allows the system to detect a USB device at startup. If detected, the USB controller is enabled. If not detected, the USB controller is disabled. When you set this field to [Disabled], the USB controller is disabled whether you are using a USB device or not. Configuration options: [Disabled] [Enabled] [Auto]

## OS/2 Onboard Memory > 64M [Disabled]

When using OS/2 operating systems with installed DRAM of greater than 64MB, you need to set this option to [Enabled]. Otherwise, leave to the default setting [Disabled]. Configuration options: [Disabled] [Enabled]

## Notes for JumperFree Mode

### CPU Upgrade/Reinstallation

To ensure that the system can enter BIOS Setup after changing the processor, the system starts up running at a bus speed of 66MHz and a fail-safe CPU internal frequency (4x66MHz for the Intel Coppermine processor or 2x66MHz for non-Coppermine processors). Then it automatically takes you to the Advanced menu with a popup menu of all the possible CPU internal frequencies.

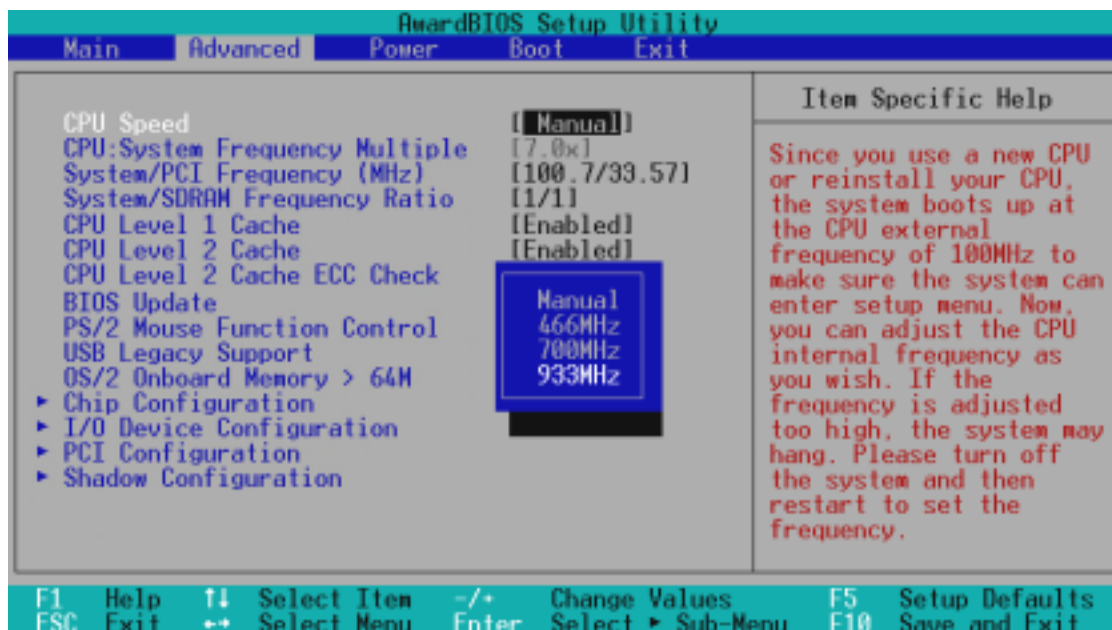

For processors with locked frequency multiplier



# 4. BIOS SETUP

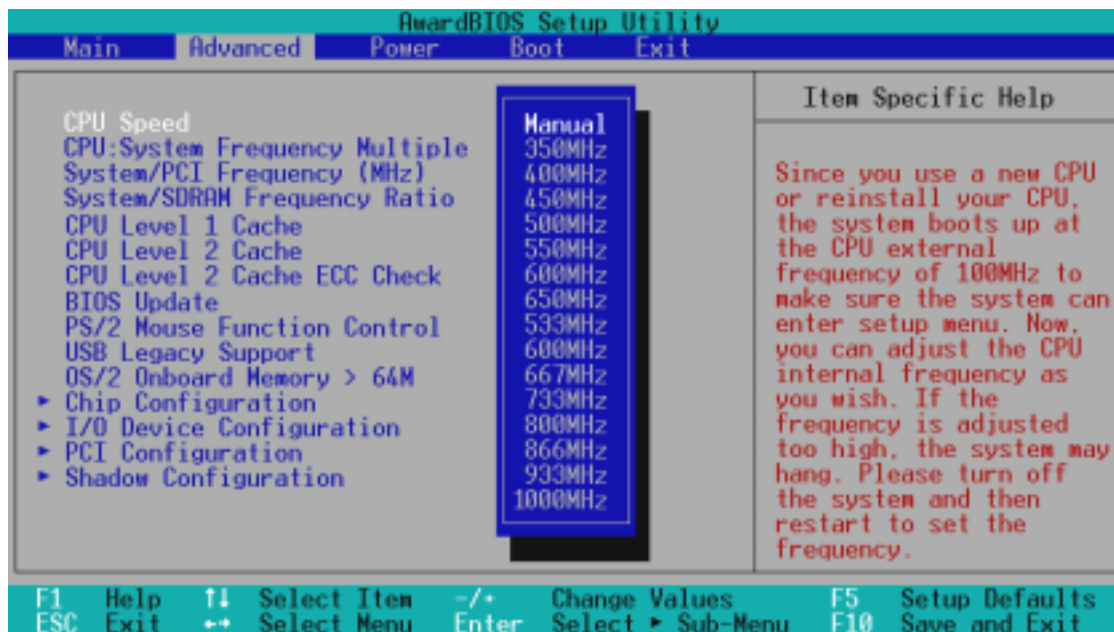

**For processors with unlocked frequency multiplier**

## System Hangup

If the system crashes or hangs due to improper frequency settings, power OFF the system and restart. The system starts up in safe mode running at a bus speed of 66MHz and enters the BIOS Setup.

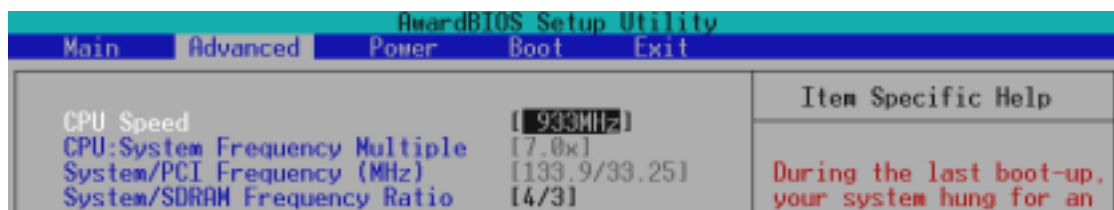

**Cause for Hangup: Improper CPU Speed**

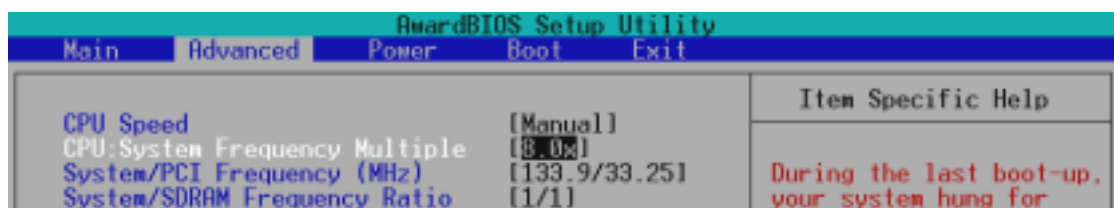

**Cause for Hangup: Improper CPU: System Frequency Multiple  
 (For processors with unlocked frequency multiplier only)**

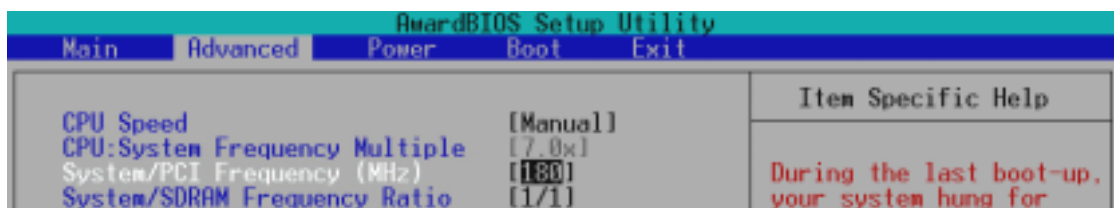

**Cause for Hangup: Improper System/SDRAM Frequency Ratio**

4. BIOS SETUP  
JumperFree Mode

# 4. BIOS SETUP

## 4.4.1 Chip Configuration

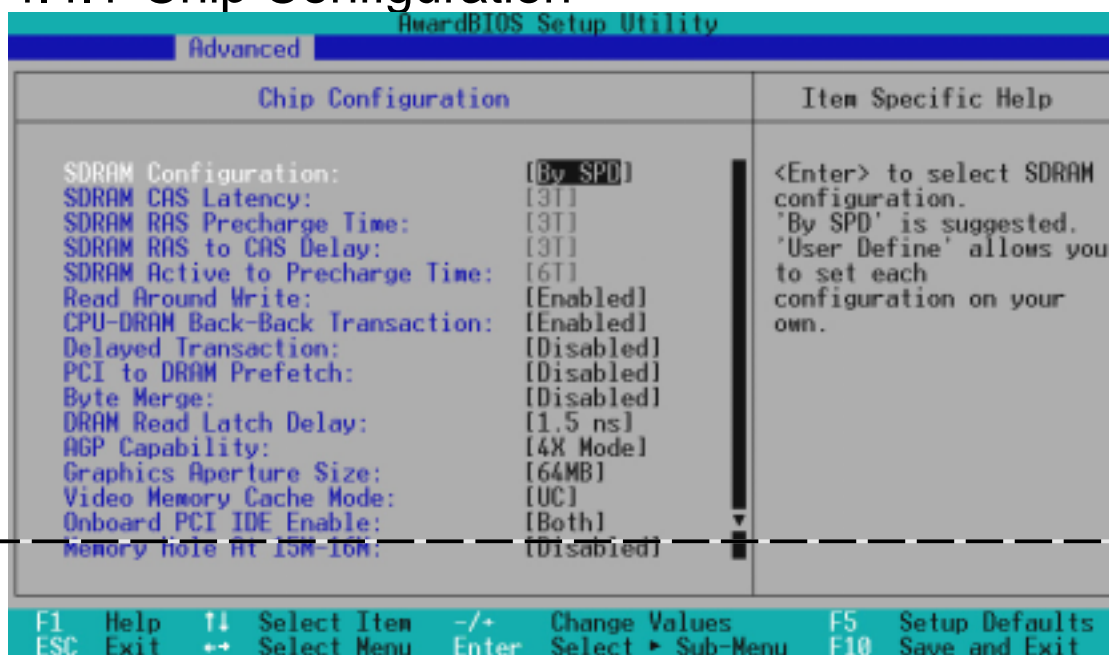

(Scroll down to see more items as shown here.)

### SDRAM Configuration [By SPD]

This sets the optimal timings for items 2–5, depending on the memory modules that you are using. The default setting is [By SPD], which configures items 2–5 by reading the contents in the SPD (Serial Presence Detect) device. The EEPROM on the memory module stores critical parameter information about the module, such as memory type, size, speed, voltage interface, and module banks. Configuration options: [User Define] [7ns (143MHz)] [8ns (125MHz)] [By SPD]

#### SDRAM CAS Latency

This controls the latency between the SDRAM read command and the time that the data actually becomes available. **NOTE:** This field appears only when you set the **SDRAM Configuration** to [User Defined].

#### SDRAM RAS Precharge Time

This controls the idle clocks after issuing a precharge command to the SDRAM. **NOTE:** This field appears only when you set the **SDRAM Configuration** to [User Defined].

#### SDRAM RAS to CAS Delay

This controls the latency between the SDRAM active command and the read/write command. **NOTE:** This field appears only when you set the **SDRAM Configuration** to [User Defined].

#### SDRAM Active to Precharge Time

To make changes to this field, set the SDRAM Configuration field to [User Defined].

# 4. BIOS SETUP

---

## **Read Around Write [Enabled]**

Setting this field to [Enabled] allows the memory controller to store write data in its buffer whenever the CPU issues a write command. The next time the CPU needs the data, it retrieves the data from the memory buffer without accessing the SDRAM. Configuration options: [Disabled] [Enabled]

## **CPU-DRAM Back-Back Transaction [Enabled]**

Configuration options: [Enabled] [Disabled]

## **Delayed Transaction [Disabled]**

When set to [Enabled], this feature frees the PCI bus when the CPU is accessing 8-bit ISA cards. This process normally consumes about 50-60 PCI Clocks without PCI delayed transaction. Set this field to [Disabled] when using ISA cards that are not PCI 2.1 compliant. Configuration options: [Enabled] [Disabled]

## **PCI to DRAM Prefetch [Disabled]**

Configuration options: [Disabled] [Enabled]

## **Byte Merge [Disabled]**

To optimize the data transfer on PCI, this feature combines a sequence of individual memory writes (bytes or words) into a single 32-bit block of data. However, byte merging may only be done when the bytes within a data phase are in a prefetchable address range. Configuration options: [Disabled] [Enabled]

## **DRAM Read Latch Delay [1 ns]**

Configuration options: [0.0 ns] [0.5 ns] [1.0 ns] [1.5 ns]

## **AGP Capability [4X Mode]**

This motherboard supports the AGP 4x interface that transfers video data at 1066MB/s. AGP 4x is backward-compatible, so you may leave the default [4X Mode] on even if you are using an AGP 1x or 2x video card. When set to [1X Mode], the AGP interface only provides a peak data throughput of 266MB/s even if you are using an AGP 2x/4x card. When set to [2X Mode], the AGP interface only provides a peak data throughput of 533MB/s even if you are using an AGP 4x card. Configuration options: [1X Mode] [2X Mode] [4X Mode]

## **Graphics Window Size [32MB]**

This feature allows you to select the size of mapped memory for AGP graphic data. Configuration options: [4MB] [8MB] [16MB] [32MB] [64MB] [128MB] [256MB]

## 4. BIOS SETUP

---

### **Video Memory Cache Mode [UC]**

USWC (uncacheable, speculative write combining) is a new cache technology for the video memory of the processor. It can greatly improve the display speed by caching the display data. You must set this to UC (uncacheable) if your display card does not support this feature, otherwise the system may not boot. Configuration options: [UC] [USWC]

### **Onboard PCI IDE Enable [Both]**

This field allows you to enable either the primary IDE channel or secondary IDE channel, or both. You can also set both channels to [Disabled]. Configuration options: [Both] [Primary] [Secondary] [Disabled]

### **Memory Hole At 15M-16M [Disabled]**

This field allows you to reserve an address space for ISA expansion cards. Setting the address space to a particular setting makes that memory space unavailable to other system components. Expansion cards can only access memory up to 16MB. Configuration options: [Disabled] [Enabled]

# 4. BIOS SETUP

## 4.4.2 I/O Device Configuration

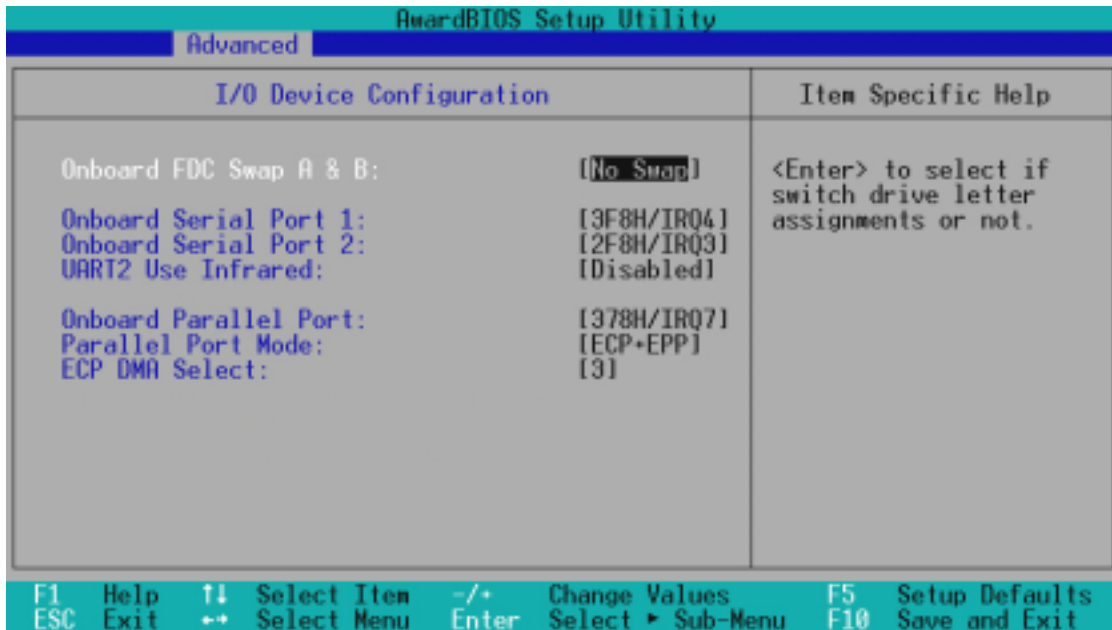

### Onboard FDC Swap A & B [No Swap]

This field allows you to reverse the hardware drive letter assignments of your floppy disk drives. Configuration options: [No Swap] [Swap AB]

### Onboard Serial Port 1 [3F8H/IRQ4]

### Onboard Serial Port 2 [2F8H/IRQ3]

These fields allow you to set the addresses for the onboard serial connectors. Serial Port 1 and Serial Port 2 must have different addresses. Configuration options: [3F8H/IRQ4] [2F8H/IRQ3] [3E8H/IRQ4] [2E8H/IRQ10] [Disabled]

### UART2 Use Standard Infrared [Disabled]

When enabled, this field activates the onboard standard infrared feature and sets the second serial UART to support the infrared module connector on the motherboard. If the system already has a second serial port connected to the onboard COM2 connector, it will no longer work if you enable the infrared feature. See **IrDA-Compliant Infrared Module Connector** in *3.8 Connectors*. Configuration options: [Disabled] [Enabled]

### Onboard Parallel Port [378H/IRQ7]

This field sets the address of the onboard parallel port connector. If you disable this field, the **Parallel Port Mode** and **ECP DMA Select** configurations are not available. Configuration options: [Disabled] [378H/IRQ7] [278H/IRQ5]

## 4. BIOS SETUP

---

### **Parallel Port Mode [ECP+EPP]**

This field allows you to set the operation mode of the parallel port. [Normal] allows normal-speed operation but in one direction only; [EPP] allows bidirectional parallel port operation; [ECP] allows the parallel port to operate in bidirectional DMA mode; [ECP+EPP] allows normal speed operation in a two-way mode. Configuration options: [Normal] [EPP] [ECP] [ECP+EPP]

### **ECP DMA Select [3]**

This field allows you to configure the parallel port DMA channel for the selected **ECP** mode. This selection is available only if you select [ECP] or [ECP+EPP] in **Parallel Port Mode** above. Configuration options: [1] [3] [Disabled]

# 4. BIOS SETUP

## 4.4.3 PCI Configuration

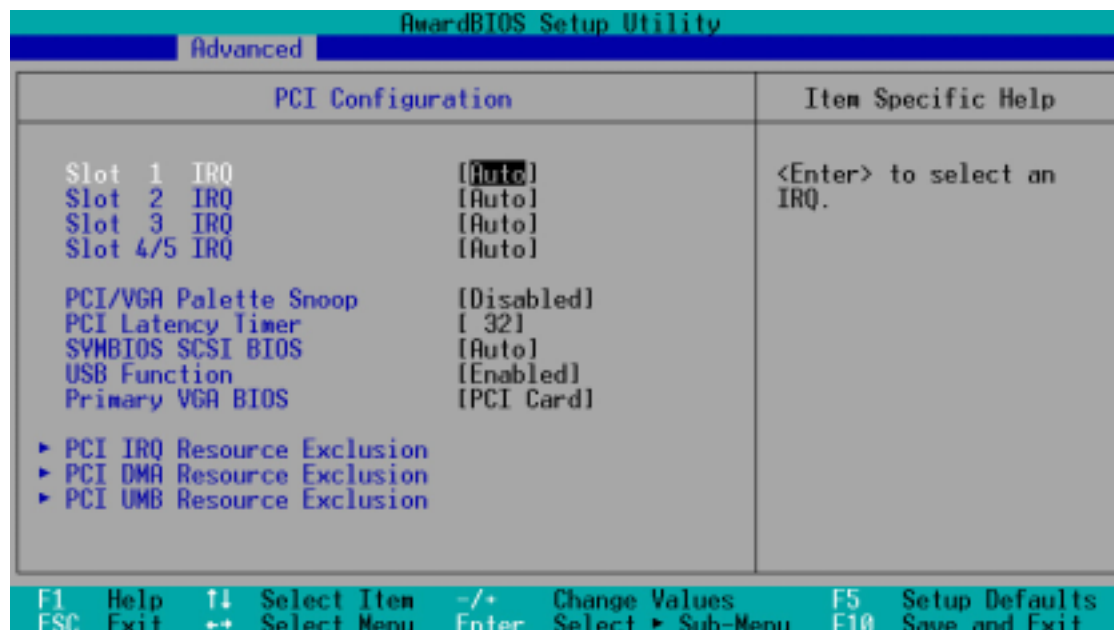

### Slot 1/5, Slot 2, Slot 3, Slot 4 IRQ [Auto]

These fields automatically assign the IRQ for each PCI slot. The default setting for each field is [Auto], which utilizes auto-routing to determine IRQ assignments. Configuration options: [Auto] [NA] [3] [4] [5] [7] [9] [10] [11] [12] [14] [15]

### PCI/VGA Palette Snoop [Disabled]

Some non-standard VGA cards, such as graphics accelerators or MPEG video cards, may not show colors properly. Setting this field to [Enabled] corrects this problem. If you are using standard VGA cards, leave this field to the default setting [Disabled]. Configuration options: [Disabled] [Enabled]

### PCI Latency Timer [32]

Leave this field to the default setting [32] for best performance and stability.

### SYMBIOS SCSI BIOS [Auto]

[Auto] allows the BIOS to detect whether you have a SYMBIOS SCSI card. If such card is detected, the SCSI BIOS is enabled. Otherwise, the onboard SCSI BIOS is disabled.

The setting [Disabled] disables the onboard SYMBIOS SCSI BIOS so that the BIOS on an add-on Symbios SCSI card can be used. If the SYMBIOS SCSI card does not have a BIOS, the Symbios SCSI card will not work. Configuration options: [Auto] [Disabled]

# 4. BIOS SETUP

## USB Function [Enabled]

Set this field to [Enabled] if you want to use Universal Serial Bus devices. Configuration options: [Disabled] [Enabled]

## Primary VGA BIOS [PCI Card]

This field allows you to select the primary graphics card. Configuration options: [PCI Card] [AGP Card]

## PCI IRQ Resource Exclusion

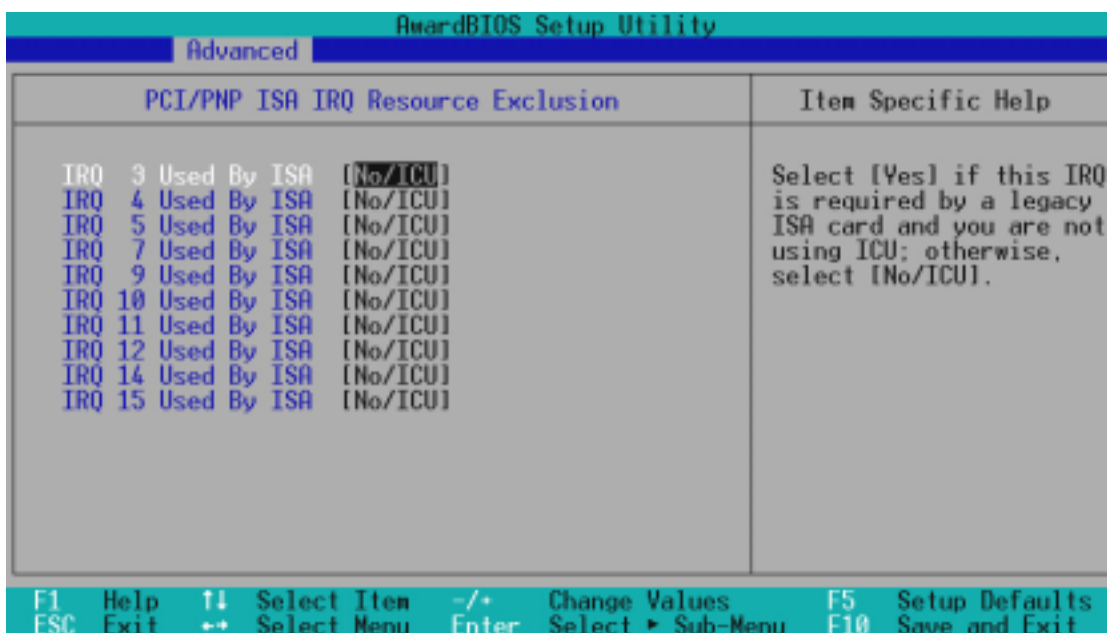

## IRQ XX Used By ISA [No/ICU]

These fields indicate whether or not the displayed IRQ for each field is being used by a legacy (non-PnP) ISA card. The setting [No/ICU] for an IRQ field indicates that you are using the ISA Configuration Utility (ICU), and that this particular IRQ is NOT required by a legacy ISA card. Set the IRQ field to [Yes] if you install a legacy ISA card that requires a unique IRQ and you are NOT using ICU. Configuration options: [No/ICU] [Yes]



# 4. BIOS SETUP

## PCI DMA Resource Exclusion

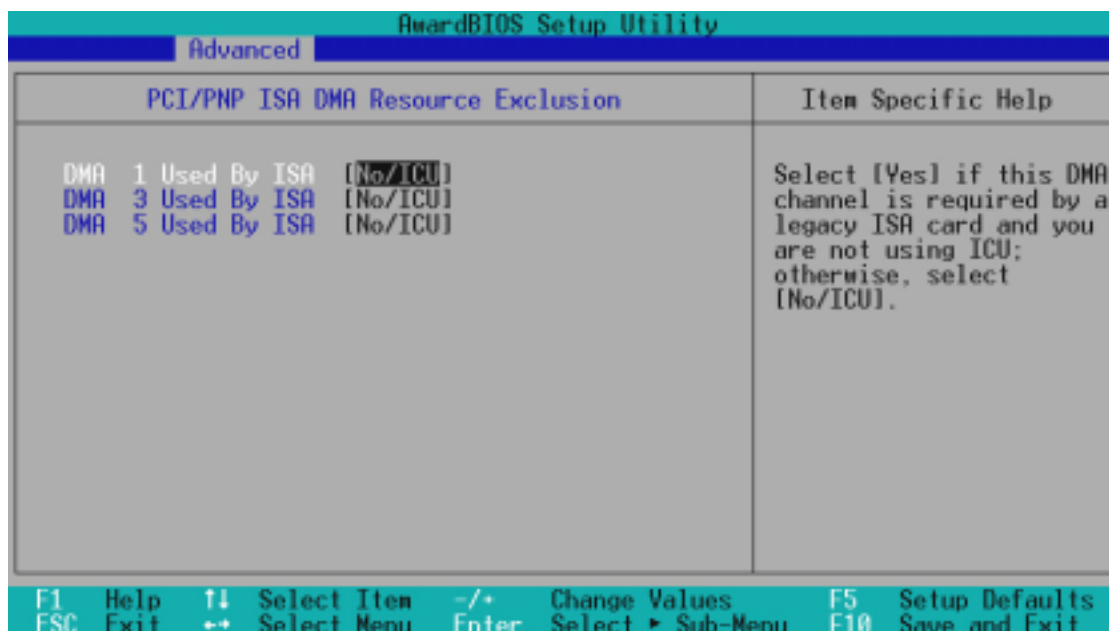

### DMA x Used By ISA [No/ICU]

These fields indicate whether or not the displayed DMA channel for each field is being used by a legacy (non-PnP) ISA card. The setting [No/ICU] for a DMA channel indicates that you are using the ISA Configuration Utility (ICU), and that this particular DMA channel is NOT required by a legacy ISA card. Set the DMA field to [Yes] if you install a legacy ISA card that requires a DMA channel and you are NOT using ICU. Configuration options: [No/ICU] [Yes]

## PCI UMB Resource Exclusion

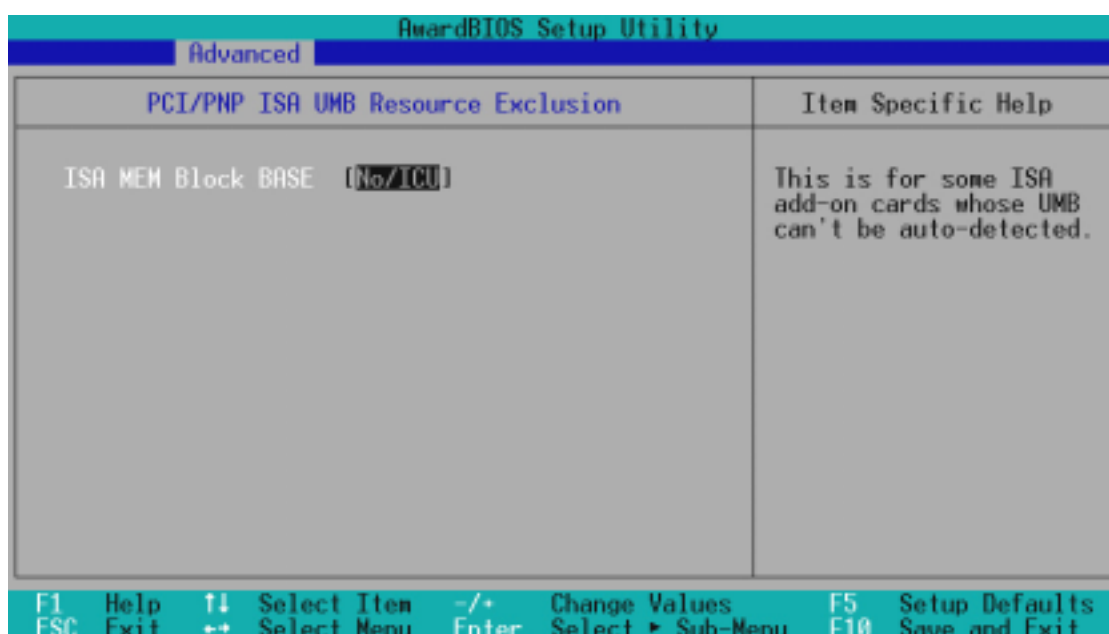

# 4. BIOS SETUP

## ISA MEM Block BASE [No/ICU]

This field allows you to set the base address and block size of a legacy ISA card that uses a memory segment within the C800 and DFFF address range. If you have such a card and you are not using ICU to specify its address range, select a base address from the six available options. When you select an option other than [No/ICU], the **ISA MEM Block SIZE** field appears for selecting the block size. If there is more than one legacy ISA card in the system that requires the use of this address range, you can increase the block size to 8K, 16K, 32K, or 64K. If you are using ICU to accomplish this task, leave **ISA MEM Block BASE** to its default setting [No/ICU]. Configuration options: [No/ICU] [C800] [CC00] [D000] [D400] [D800] [DC00]

## 4.4.4 Shadow Configuration

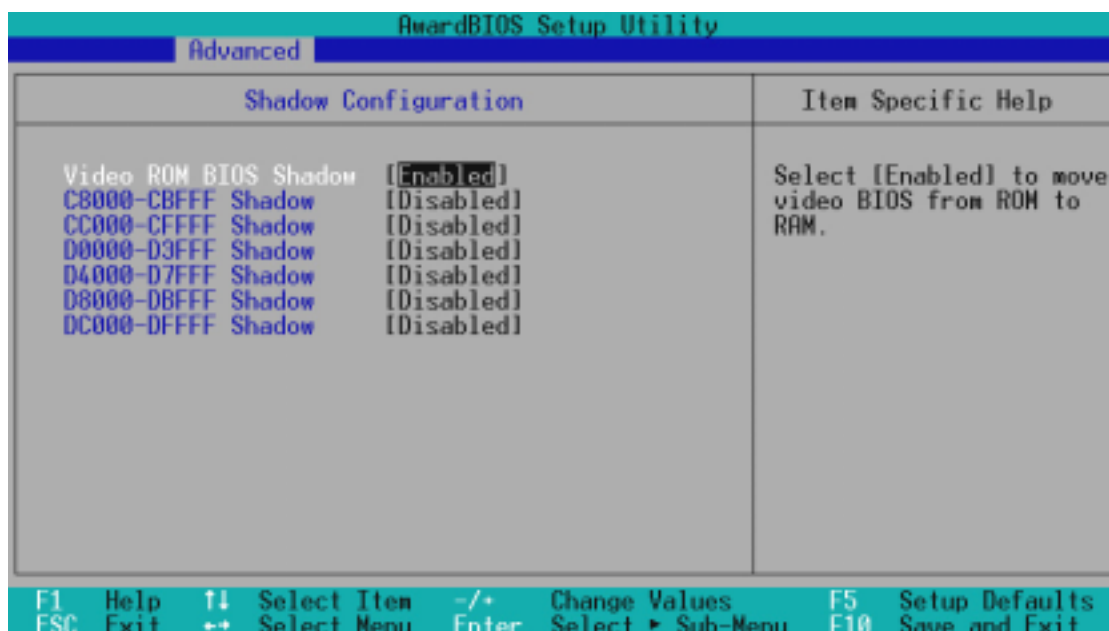

### Video ROM BIOS Shadow [Enabled]

When enabled, this field allows you to change the video BIOS location from ROM to RAM. Relocating the video BIOS to RAM enhances system performance because information access is faster than in ROM. Configuration options: [Disabled] [Enabled]

### C8000-DFFFF Shadow [Disabled]

These fields are used for shadowing other expansion card ROMs. If you install any expansion card with a built-in ROM, you need to know which addresses the ROM uses to specifically shadow them. Shadowing a ROM reduces the memory available between 640K and 1024K by the amount used for this purpose. Configuration options: [Disabled] [Enabled]

# 4. BIOS SETUP

## 4.5 Power Menu

The Power menu allows you to reduce power consumption. This feature turns off the video display and shuts down the hard disk after a period of inactivity.

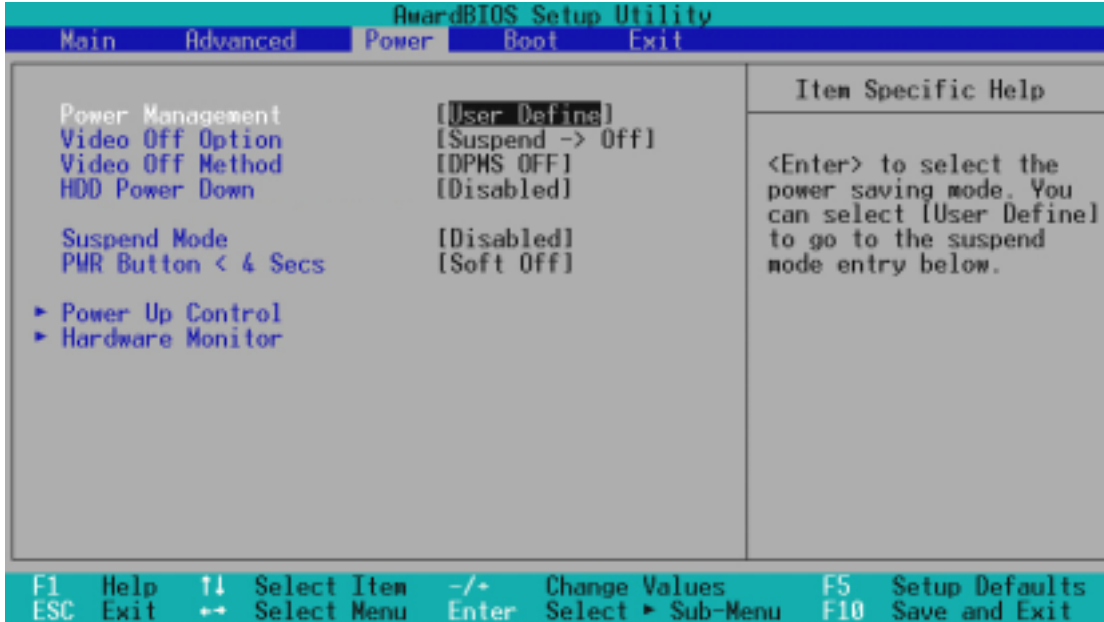

### Power Management [User Defined]

This field must be enabled to activate the automatic power saving features. When set to [Disabled], the power management features do not function regardless of the other settings on this menu. The [User Defined] option allows you to make your own selections in the Power menu. When set to [Max Saving], system power conserved to its greatest amount. The **Suspend Mode** field is then be set to a predefined value that ensures maximum power savings.

This field acts as the master control for the power management modes. [Max Saving] puts the system into power saving mode after a brief period of system inactivity. [Min Saving] is almost the same as [Max Saving] except that the system inactivity period is longer. [Disabled] deactivates the power saving features, [User Defined] allows you to set power saving options according to your preference. Configuration options: [User Define] [Disabled] [Min Saving] [Max Saving]

**IMPORTANT:** You should install the Advanced Power Management (APM) utility to keep the system time updated even when the computer enters suspend mode. In DOS environment, you need to add the statement, DEVICE=C:\DOS\POWER.EXE, to the CONFIG.SYS file. In Windows 3.x and Windows 95, you need to install Windows with the APM feature. In Windows 98 or later, APM is automatically installed as indicated by a battery and power cord icon labeled “Power Management” in the “Control Panel.” Select the item “Advanced” in the Power Management Properties dialog box.

# 4. BIOS SETUP

---

## **Video Off Option [Suspend -> Off ]**

This field determines when to activate the video off feature for monitor power management. Configuration options: [Always On] [Suspend -> Off]

## **Video Off Method [DPMS OFF]**

This field defines the video off features. The DPMS (Display Power Management System) feature allows the BIOS to control the video display card if it supports the DPMS feature. [Blank Screen] only blanks the screen (use this for monitors without power management or “green” features. If set up in your system, your screen saver will not display with [Blank Screen] selected). [V/H SYNC+Blank] blanks the screen and turns off vertical and horizontal scanning. Configuration options: [Blank Screen] [V/H SYNC+Blank] [DPMS Standby] [DPMS Suspend] [DPMS OFF] [DPMS Reduce ON]

## **HDD Power Down [Disabled]**

Shuts down any IDE hard disk drives in the system after a period of inactivity as set in this user-configurable field. This feature does not affect SCSI hard drives. Configuration options: [Disabled] [1 Min] [2 Min] [3 Min]...[15 Min]

## **Suspend Mode [Disabled]**

Sets the time period before the system goes into suspend mode. Configuration options: [Disabled] [30 Sec] [1 Min] [2 Min]...[1 Hour]

## **PWR Button < 4 Secs [Soft Off]**

When set to [Soft off], the ATX switch can be used as a normal system power-off button when pressed for less than 4 seconds. [Suspend] allows the button to have a dual function where pressing less than 4 seconds will place the system in sleep mode. Regardless of the setting, holding the ATX switch for more than 4 seconds will power off the system. Configuration options: [Soft off] [Suspend]

# 4. BIOS SETUP

## 4.5.1 Power Up Control

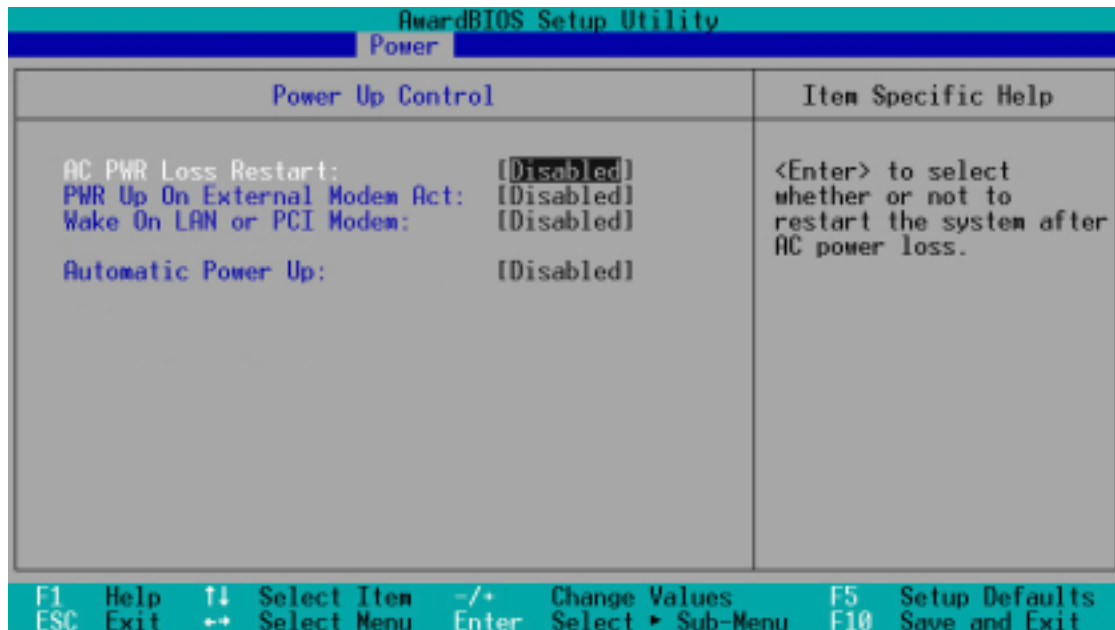

### AC PWR Loss Restart [Disabled]

This allows you to set whether you want your system to reboot after the power has been interrupted. [Disabled] leaves your system off and [Enabled] reboots your system. [Previous State] sets your system back to the state it is before the power interruption. Configuration options: [Disabled] [Enabled] [Previous State]

### PWR Up On External Modem Act [Disabled]

This allows either settings of [Enabled] or [Disabled] for powering up the computer when the external modem receives a call while the computer is in Soft-off mode. **NOTE:** The computer cannot receive or transmit data until the computer and applications are fully running. Thus connection cannot be made on the first try. Turning an external modem off and then back on while the computer is off causes an initialization string that will also cause the system to power on. Configuration options: [Disabled] [Enabled]

### Wake On LAN or PCI Modem [Enabled]

Wake-On-LAN/PCI Modem allows your computer to be booted from another computer via a network by sending a wake-up frame or signal. Configuration options: [Disabled] [Enabled]

**IMPORTANT:** This feature requires an optional network interface with Wake-On-LAN and an ATX power supply with at least 720mA +5V standby power.

# 4. BIOS SETUP

## Automatic Power Up [Disabled]

This allows an unattended or automatic system power up. You may configure your system to power up at a certain time of the day by selecting [Everyday] or at a certain time and day by selecting [By Date]. Configuration options: [Disabled] [Everyday] [By Date]

## 4.5.2 Hardware Monitor

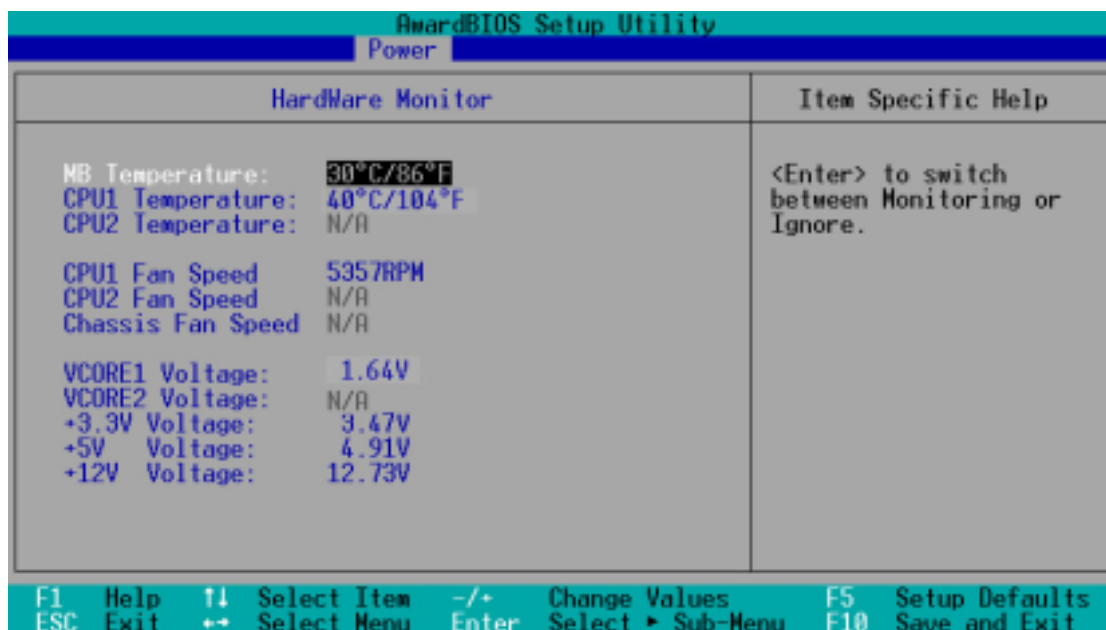

### MB Temperature [xxxC/xxxF]

### CPU1/CPU2 Temperature [xxxC/xxxF]

The onboard hardware monitor automatically detects the MB (motherboard) and CPU temperatures.

### CPU1/CPU2 Fan Speed [xxxxRPM]

### Chassis Fan Speed [N/A]

The onboard hardware monitor automatically detects the CPU and chassis fan speeds in rotations per minute (RPM).

### VCORE1/VCORE2 Voltage

### +3.3V Voltage, +5V Voltage, +12V Voltage

The onboard hardware monitor automatically detects the voltage output through the onboard voltage regulators.

**NOTE:** If any of the monitored items is out of range, the following error message appears: “Hardware Monitor found an error. Enter Power setup menu for details”. You will then be prompted to “Press **F1** to continue or **DEL** to enter SETUP”.

# 4. BIOS SETUP

## 4.6 Boot Menu

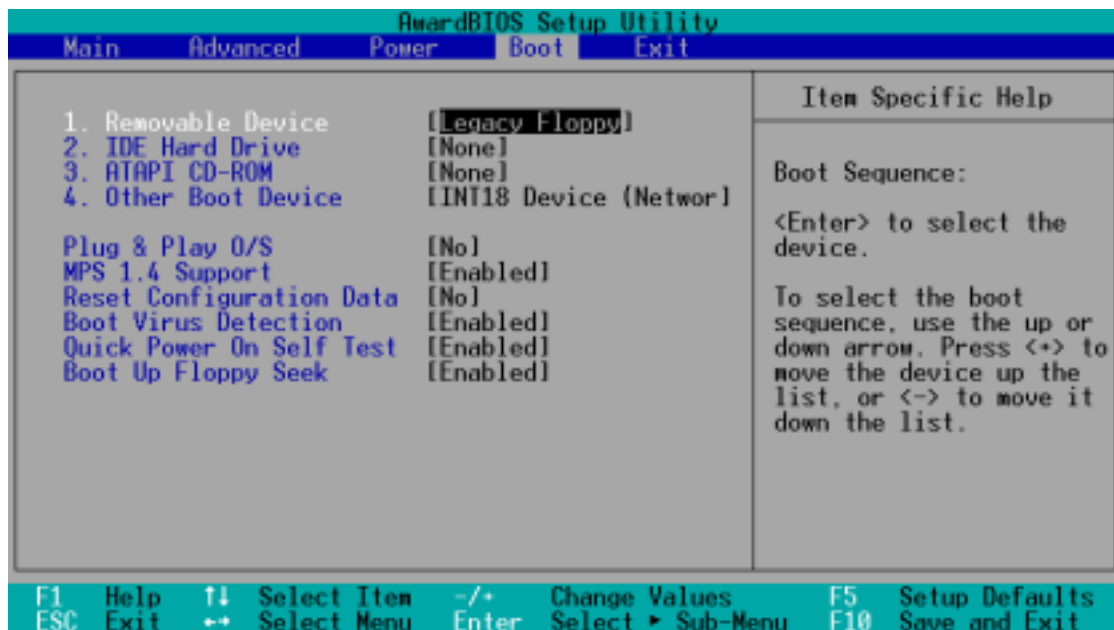

### Boot Sequence

The Boot menu allows you to select among the four possible types of boot devices listed using the up and down arrow keys. By using the <+> or <Space> key, you can promote devices and by using the <-> key, you can demote devices. Promotion or demotion of devices alters the priority which the system uses to search for a boot device on system power up. Configuration fields include **Removable Devices**, **IDE Hard Drive**, **ATAPI CD-ROM**, and **Other Boot Device**.

### Removable Device [Legacy Floppy]

Configuration options: [Disabled] [Legacy Floppy] [LS120] [ZIP-100] [ATAPI MO]

### IDE Hard Drive

This field allows you to select which IDE hard disk drive to use in the boot sequence. Pressing [Enter] will show the product IDs of all connected IDE hard disk drives.

### ATAPI CD-ROM

This field allows you to select which ATAPI CD-ROM drive to use in the boot sequence. Pressing [Enter] will show the product IDs of all your connected ATAPI CD-ROM drives.

### Other Boot Device Select [INT18 Device (Network)]

Configuration options: [Disabled] [SCSI Boot Device] [INT18 Device (Network)]

# 4. BIOS SETUP

---

## **Plug & Play O/S [No]**

This field allows you to use a Plug-and-Play (PnP) operating system to configure the PCI bus slots instead of using the BIOS. When [Yes] is selected, interrupts may be reassigned by the OS. When a non-PnP OS is installed or you want to prevent reassigning of interrupt settings, select the default setting of [No]. Configuration options: [No] [Yes]

## **MPS 1.4 Support [Enabled]**

This field allows you to enable or disable the MultiProcessor Specification 1.4 support. Configuration options [Enabled] [Disabled]

## **Reset Configuration Data [No]**

The Extended System Configuration Data (ESCD) contain information about non-PnP devices. It can also hold the complete record of how the system was configured the last time it was booted. Select [Yes] only if you want to clear these data during the Power-On Self Test (POST). Configuration options: [No] [Yes]

## **Boot Virus Detection [Enabled]**

This field allows you to set boot virus detection, ensuring a virus-free boot sector. The system halts and displays a warning message when it detects a virus. If this occurs, you can either allow the operation to continue or use a virus-free bootable floppy disk to restart and investigate your system. Configuration options: [Disabled] [Enabled]

## **Quick Power On Self Test [Enabled]**

This field speeds up the Power-On-Self Test (POST) routine by skipping retesting a second, third, and fourth time. Configuration options: [Disabled] [Enabled]

## **Boot Up Floppy Seek [Enabled]**

When enabled, the BIOS will seek the floppy disk drive to determine whether the drive has 40 or 80 tracks. Configuration options: [Disabled] [Enabled]



# 4. BIOS SETUP

## 4.7 Exit Menu

When you have made all of your selections from the various menus in the Setup program, save your changes and exit Setup. Select **Exit** from the menu bar to display the following menu:

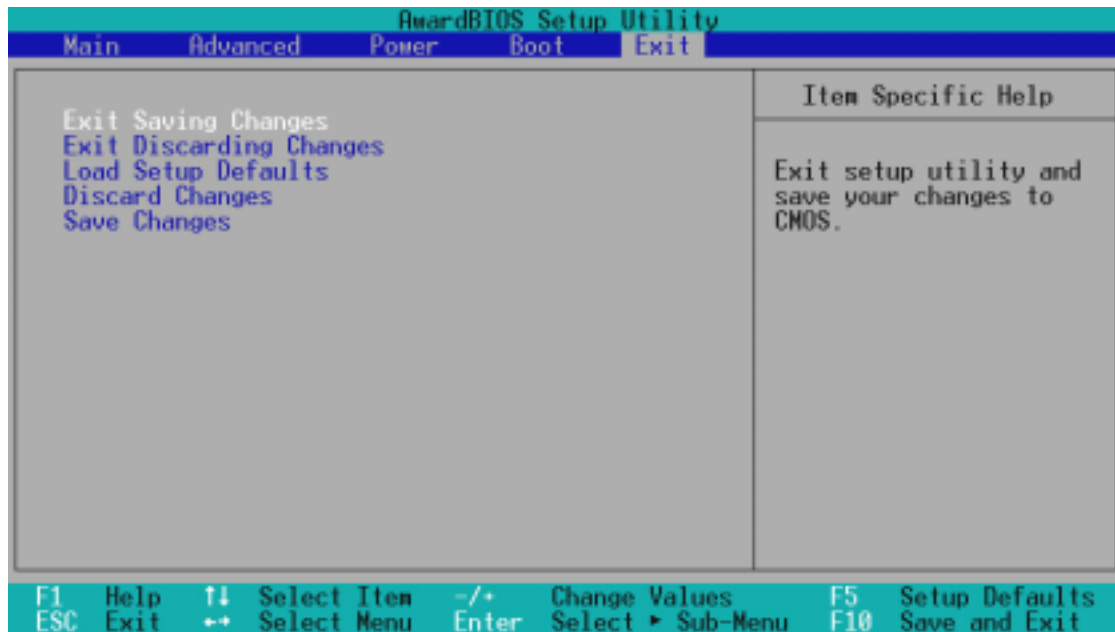

**NOTE:** Pressing <Esc> does not immediately exit this menu. Select one of the options from this menu or <F10> from the legend bar to exit this menu.

### Exit Saving Changes

Once you are finished making your selections, choose this option from the Exit menu to ensure the values you selected are saved to the CMOS RAM. The CMOS RAM is sustained by an onboard backup battery and stays on even when the PC is turned off. When you select this option, a confirmation window appears. Select [Yes] to save changes and exit.

**NOTE:** If you attempt to exit the Setup program without saving your changes, the program prompts you with a message asking if you want to save your changes before exiting. Pressing <Enter> saves the changes while exiting.

### Exit Discarding Changes

Select this option only if you do not want to save the changes that you made to the Setup program. If you made changes to fields other than system date, system time, and password, the BIOS asks for a confirmation before exiting.

# 4. BIOS SETUP

---

## **Load Setup Defaults**

This option allows you to load the default values for each of the parameters on the Setup menus. When you select this option or if you press <F5>, a confirmation window appears. Select [Yes] to load default values. Select **Exit Saving Changes** or make other changes before saving the values to the non-volatile RAM.

## **Discard Changes**

This option allows you to discard the selections you made and restore the previously saved values. After selecting this option, a confirmation appears. Select [Yes] to discard any changes and load the previously saved values.

## **Save Changes**

This option saves your selections without exiting the Setup program. You can then return to other menus and make further changes. After you select this option, a confirmation window appears. Select [Yes] to save any changes to the non-volatile RAM.

# 5. SOFTWARE SETUP

## 5.1 Operating Systems

You should always use the latest operating system and updates when using new hardware to ensure full compliance. You may use any version of Windows 98, but for Windows 95, you must use OSR 2.0 or later. For Windows NT 4.0, you must use Service Pack 3.0 or later.

### 5.1.1 Windows 98 First Time Installation

When you start Windows for the first time after the installation of the motherboard, Windows 98 detects the onboard audio and video chips and may attempt to install a driver from its system registry. When prompted to restart, select **No** and then follow the normal setup procedures on the screen.

## 5.2 CUV4X-D Motherboard Support CD

To begin using the support CD, insert it into the CD-ROM drive. The support installation menu should appear. If the menu does not appear, double-click or run **D:\ASSETUP.EXE** (assuming that your CD-ROM drive is drive D).

**NOTE:** The support CD contents are subject to change at any time without notice.

### 5.2.1 Installation Menu

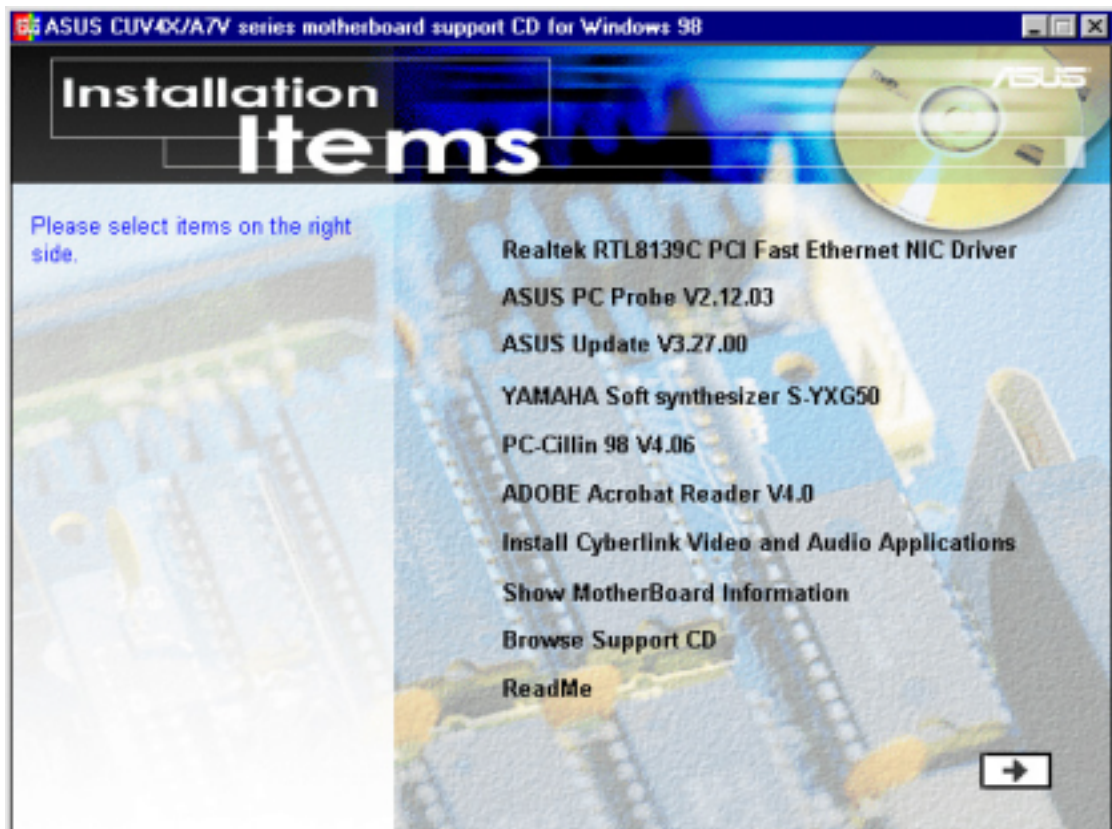

# 5. SOFTWARE SETUP

---

## 5.2.2 Applications

- **Realtek RTL8139C PCI Fast Ethernet NIC Driver:** Installs the Realtek RTL8139C PCI Fast Ethernet NIC Driver V5.376.0523.2000.
- **ASUS PC Probe Vx.xx:** Installs a smart utility that can monitor your computer fan, temperature, and voltages.
- **ASUS Update V3.27.00:** Installs the ASUS Update program. This program allows you download the latest version of Flash BIOS from the ASUS website. Before using ASUS Update, make sure that you have a network card and a TCP/IP network driver.
- **YAMAHA SoftSynthesizer S-YXG50:** Installs the YAMAHA SoftSynthesizer for playing MIDI files, audio files, movie files and audio CDs. Before installing this program, make sure that you have an audio driver installed in your computer. Refer to the online help for more information.
- **PC-Cillin 98 V4.06:** Installs the PC-cillin virus protection software. View the online help for more information.
- **ADOBE AcroBat Reader V4.0:** Installs the Adobe Acrobat Reader software necessary to view user's manuals in PDF format.
- **Install Cyberlink Video and Audio Applications:** Installs the Cyberlink PowerPlayer SE 5.0, Cyberlink PowerDVD Trial 2.55, and Cyberlink VideoLive Mail 3.10.
- **VIA 4 in 1 Drivers:** Installs Bus Master PCI IDE Driver, AGP VxD Driver, VIA chipset functions Registry, and IRQ Routing Miniport Driver.  
(NOTE: This item does not appear on the Installation Menu. To access these drivers, click on the Browse Support CD item, then on the VIA folder.)
- **Show Motherboard Information:** Allows you to view information about the motherboard, such as product name, BIOS version, and CPU.
- **Browse Support CD:** Allows you to view the contents of the support CD.
- **ReadMe:** Allows you to view a list of the files included in the support CD and ASUS contact information.
- **Exit:** Exits the CD installation menu.

**NOTE:** The Exit item is on the next menu screen. To see the item, click on the arrow (pointing to the right) on the lower right corner of the screen. To return to the first menu screen, click on the arrow (pointing to the left) on the lower right corner of the second screen.

## 6. SOFTWARE REFERENCE

### 6.1 ASUS PC Probe

ASUS PC Probe is a convenient utility to continuously monitor your computer system's vital components, such as fan rotations, voltages, and temperatures. It also has a utility that lets you review useful information about your computer, such as hard disk space, memory usage, and CPU type, CPU speed, and internal/external frequencies through the DMI Explorer.

#### 6.1.1 Starting ASUS PC Probe

When ASUS PC Probe starts, a splash screen appears allowing you to select whether to show the screen again when you open PC Probe or not. To bypass this startup screen, clear the **Show up in next execution** check box.

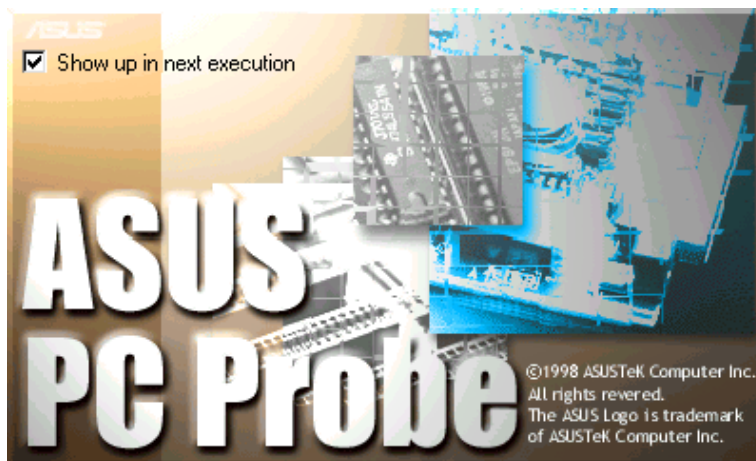

To open **ASUS PC Probe**, click the Windows **Start** button, point to **Programs**, and then **ASUS Utility**, and then click **Probe Vx.xx**.

The PC Probe icon  appears on the taskbar system tray indicating that ASUS PC Probe is running. Clicking the icon allows you to see the status of your PC.

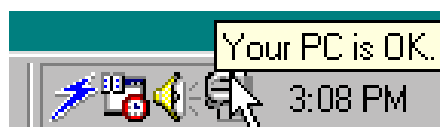

# 6. SOFTWARE REFERENCE

## 6.1.2 Using ASUS PC Probe

### Monitoring

#### Monitor Summary

Shows a summary of the items being monitored.



#### Temperature Monitor

Shows the PC temperature (for supported processors only).

Temperature Warning threshold adjustment  
(Move the slider up to increase the threshold level or down to decrease the threshold level)



#### Fan Monitor

Shows the PC fan rotation.

Fan Warning threshold adjustment  
(Move the slider up to increase the threshold level or down to decrease the threshold level)



#### Voltage Monitor

Shows the PC voltages.





# 6. SOFTWARE REFERENCE

## Settings

Lets you set threshold levels and polling intervals or refresh times of the PC's temperature, fan rotation, and voltages.

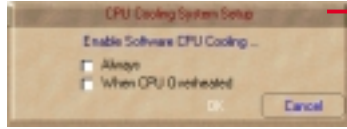

### CPU Cooling System Setup

Lets you select when to enable software CPU cooling. When **When CPU Overheated** is selected, the CPU cooling system is enabled whenever the CPU temperature reaches the threshold value.

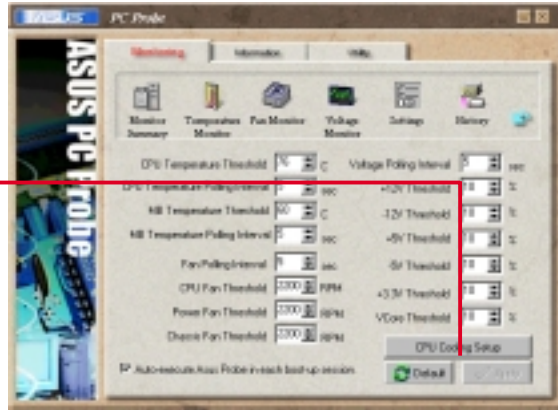

6. SW REFERENCE  
ASUS PC Probe

## History

Lets you record the monitoring activity of a certain component of your PC for future reference.

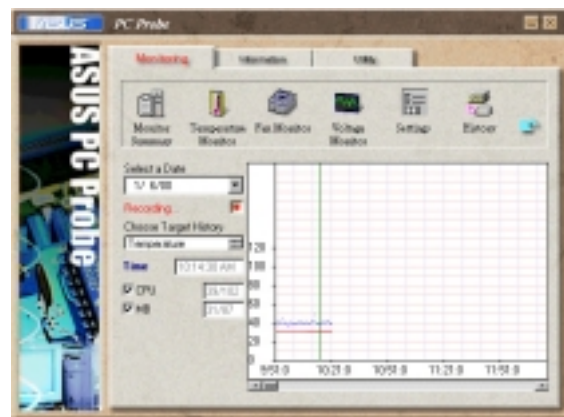

## Fan Control

Lets you enable/disable Smart Fan Control. Smart Fan Control adjusts the fan speed automatically based on the current CPU temperature and predefined threshold.



## Information

### Hard Drives

Shows the used and free space of the PC's hard disk drives and the file allocation table or file system used.



# 6. SOFTWARE REFERENCE

## Memory

Shows the PC memory load, memory usage, and paging file usage.



## Device Summary

Shows a summary of devices present in your PC.



## DMI Explorer

Shows information pertinent to the PC, such as CPU type, CPU speed, and internal/external frequencies, and memory size.

Property	Name	Value
BIOS	Award Software, Inc.	
System	Vendor	ASUS P50-F ACPI BIOS D5
Workstation	Version	F88E
Character	Starting Address	F88E
Processor	Release Date	08-10-1999
Cache	PCID Size	256K
Memory Controller	ISA	Supported
Cache	MCA	Not Supported
Port Connectors	EISA	Not Supported
System Status	PCI	Supported
BIOS Information	PCMCIA	Not Supported
System Configuration	PNP	Supported
BIOS Language	APM	Supported
	BIOS Upgradable	Supported
	BIOS Shadowing	Supported
	VLBI SU	Not Supported

## Utility

Lets you run programs outside of the ASUS Probe modules. To run a program, click **Execute Program**. **NOTE:** This feature is currently unavailable.





## 6. SOFTWARE REFERENCE

### 6.1.3 ASUS PC Probe Task Bar Icon

Right clicking the PC Probe icon brings up a menu to open or exit ASUS PC Probe and pause or resume all system monitoring.



When the ASUS PC Probe senses a problem with your PC, portions of the ASUS PC Probe icon changes to red, the PC speaker beeps, and the ASUS PC Probe monitor appears.

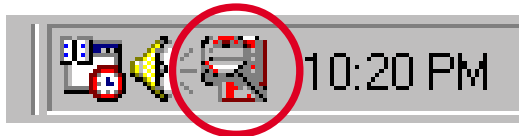

## 6. SOFTWARE REFERENCE

---

(This page was intentionally left blank.)

# 7. APPENDIX

## 7.1 PCI-L101 Fast Ethernet Card

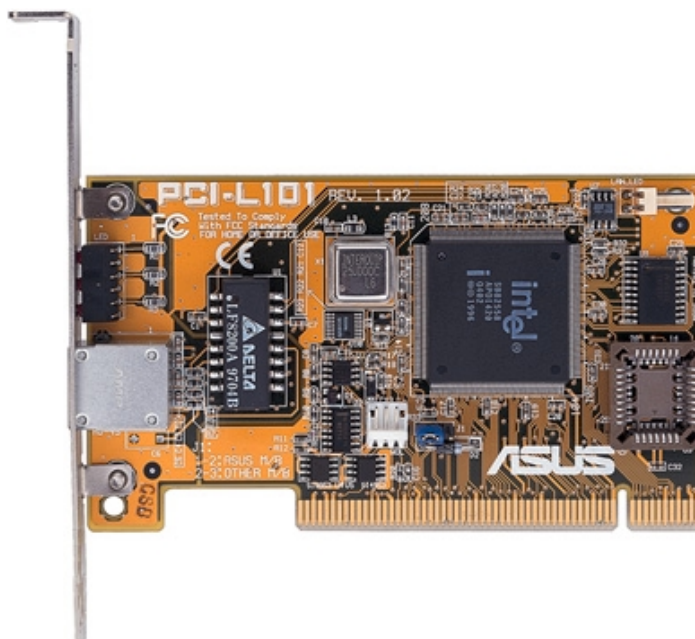

7. APPENDIX  
ASUS LAN Card

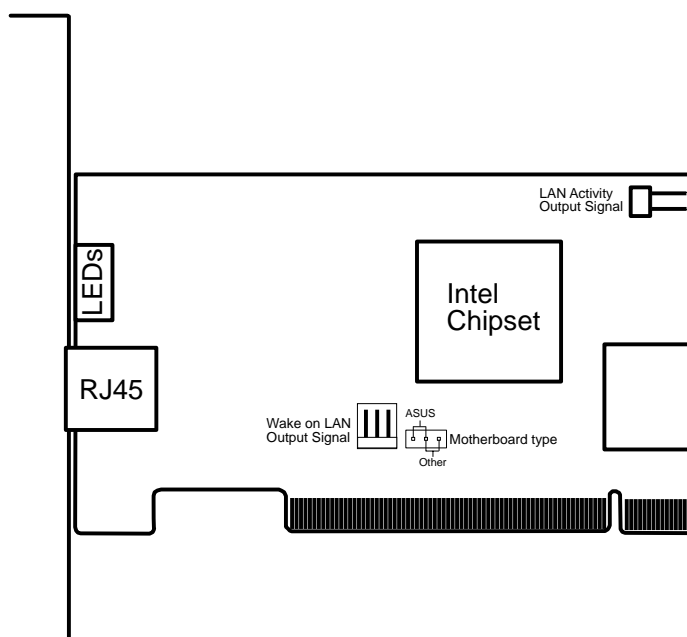

If you are using the ASUS PCI-L101 on an ASUS motherboard, leave the jumper on its default setting of “ASUS.” If you are using another brand of motherboard, set the jumper to “Other.” Connect the Wake on LAN (WOL) output signal to the motherboard’s WOL\_CON in order to utilize the wake on LAN feature of the motherboard. Connect the LAN activity output signal (LAN\_LED) to the system cabinet’s front panel LAN\_LED in order to display the LAN data activity.

# 7. APPENDIX

---

## 7.1.1 Features

- Intel 82558 Ethernet LAN Controller (Fully integrated 10BASE-T/100BASE-TX)
- Wake-On-LAN Remote Control Function Supported
- PCI Bus Master Complies to PCI Local Bus Rev. 2.1 specifications
- Consists of MAC & PHY (10/100Mbps) interfaces
- Complies to IEEE 802.3 10BASE-T and IEEE 802.3u 100BASE-TX interfaces
- Fully supports 10BASE-T & 100BASE-TX operations through a single RJ45 port
- Supports 32-bit Bus Master Technology / PCI Rev. 2.1
- Enhancements on ACPI & APM
- Adheres to PCI Bus Power Management Interface Rev. 1.0, ACPI Rev. 1.0, and Device Class Power Management Rev. 1.0
- IEEE 802.3u auto-negotiation for 10Mbps/100Mbps Network Data Transfer Rates.
- Provides LED indicators for monitoring network conditions
- Plug and Play

## 7.1.2 Software Driver Support

- **NetWare ODI Drivers** - Novell Netware 3.x, 4.x, DOS, OS/2 Client
- **NDIS 2.01 Drivers** - Microsoft LAN Manager, Microsoft Windows 3.11, IBM LAN Server
- **NDIS 3.0 Drivers** - Microsoft Windows NT, Microsoft Windows 95, Microsoft Windows 3.11

## 7.1.3 Question and Answer

Q: What is Wake-On-LAN ?

A: The Wake-On-LAN feature provides the capability to remotely power on systems supporting Wake-On-LAN by simply sending a wake-up frame. With this feature, remotely uploading/downloading data to/from systems during off-peak hours will be feasible.

Q: What can Wake-On-LAN do for you ?

A: Wake-On-LAN is a remote management tool with advantages that can reduce system management workload, provide flexibility to the system administrator's job, and then of course save you time-consuming efforts and costs.

Q: What components does Wake-On-LAN require to be enable?

A: To enable Wake-On-LAN function, your system requires Ethernet LAN adapter card that can activate Wake-On-LAN function, a client with Wake-On-LAN capability, and software such as LDCM Rev. 3.10 or up that can trigger wake-up frame.

# 7. APPENDIX

## 7.2 Glossary

### 1394

1394 is the IEEE designation for the high performance serial bus at 12.5, 25 or 50MBytes/sec speeds. This serial bus defines both a back plane physical layer and a point-to-point cable-connected virtual bus. The primary application of the cable version is the integration of I/O connectivity at the back panel of personal computers using a low-cost, scalable, high-speed serial interface. The 1394 standard also provides new services such as live connect/disconnect capability for external devices including disk drives, printers and hand-held peripherals such as scanners and cameras. This is a new standard to complement the slower USB interface and to compete with the more expensive SCSI interface.

### AC'97 (Audio Codec '97)

AC '97 is the next step in enabling PCs with audio quality comparable to consumer electronics devices. The specification defines new cost-effective options to help integrate the components necessary to support next-generation auto-intensive PC applications such as DVD, 3-D multiplayer gaming and interactive music. The specification also defines new extensions supporting modem and docking to help both desktop and mobile manufacturers adopt these new technologies more quickly and cost-effectively. This specification uses software emulation to compete with the PCI SoundBlaster specification.

### ACPI (Advanced Configuration and Power Interface)

The ACPI specification defines a cross-platform interface designed to support many operating systems. ACPI defines a flexible and abstract hardware interface that provides a standard way to integrate power management features throughout a PC system, including hardware, operating system and application software. This enables the system to automatically turn ON and OFF peripherals such as CD-ROMs, network cards, hard disk drives, and printers, as well as consumer devices connected to the PC such as VCRs, TVs, phones, and stereos. With this technology, peripherals will also be able to activate the PC. For example, inserting a tape into a VCR can turn on the PC, which could then activate a large-screen TV and high-fidelity sound system.

### AGP (Accelerated Graphics Port)

An interface specification that enables high-performance 3D graphics on mainstream PCs. AGP was designed to offer the necessary bandwidth and latency to perform texture mapping directly from system memory.

Bus	Bus Frequency	Bandwidth	Data Transfer Rate
PCI	33MHz	33MHz	133MByte/sec
AGP 1X	66MHz	66MHz	266MByte/sec
AGP 2X	66MHz	133MHz	512MByte/sec
AGP 4X	66MHz	266MHz	1024MByte/sec

### BIOS (Basic Input/Output System)

BIOS is a set of routines that affect how the computer transfers data between computer components, such as memory, disks, and the display adapter. The BIOS instructions are built into the computer's read-only memory. BIOS parameters can be configured by the user through the BIOS Setup program. The BIOS can be updated using the provided utility to copy a new BIOS file into the EEPROM.

### Bit (Binary Digit)

Represents the smallest unit of data used by the computer. A bit can have one of two values: 0 or 1.

# 7. APPENDIX

---

## **Boot**

Boot means to start the computer operating system by loading it into system memory. When the manual instructs you to “boot” your system (or computer), it means to turn ON your computer. “Reboot” means to restart your computer. When using Windows 95 or later, selecting “Restart” from “Start | Shut Down...” will reboot your computer.

## **Bus Master IDE**

PIO (Programmable I/O) IDE requires that the CPU be involved in IDE access and waiting for mechanical events. Bus master IDE transfers data to/from the memory without interrupting the CPU. Bus master IDE driver and bus master IDE hard disk drives are required to support bus master IDE mode.

## **Byte (Binary Term)**

One byte is a group of eight contiguous bits. A byte is used to represent a single alphanumeric character, punctuation mark, or other symbol.

## **COM Port**

COM is a logical device name used by to designate the computer serial ports. Pointing devices, modems, and infrared modules can be connected to COM ports. Each COM port is configured to use a different IRQ and address assignment.

## **Concurrent PCI**

Concurrent PCI maximizes system performance with simultaneous CPU, PCI and ISA bus activities. It includes multi-transaction timing, enhanced write performance, a passive release mechanism and support for PCI 2.1 compliant delayed transactions. Concurrent PCI provides increased bandwidth, reduced system latencies, improves video and audio performance, and improves processing of host based applications.

## **CPU (Central Processing Unit)**

The CPU, sometimes called “Processor,” actually functions as the “brain” of the computer. It interprets and executes program commands and processes data stored in memory. Currently, there are socket 370 (for Pentium III FC-PGA and Celeron-PPGA), socket 7 (for Pentium, AMD, Cyrix, IBM), slot 1 (for Pentium II and III), slot 2 (for Xeon), and slot A (for AMD) processors.

## **Device Driver**

A device driver is a special set of instructions that allows the computer’s operating system to communicate with devices such as VGA, audio, printer, or modem.

## **DOS (Disk Operating System)**

DOS is the foundation on which all other programs and software applications operate, including Windows. DOS is responsible for allocating system resources such as memory, CPU time, disk space, and access to peripheral devices. For this reason, DOS constitutes the basic interface between you and your computer.

## **DRAM (Dynamic Random Access Memory)**

There are several different types of DRAM such as, EDO DRAM (Extended Data Output DRAM), SDRAM (Synchronous DRAM), and RDRAM (Rambus DRAM).

## **Flash ROM**

The flash ROM is designed to be a resident program and can be updated by a specific programming method. Normally, the flash ROM is used for system BIOS which initiates hardware devices and sets up necessary parameters for the OS. Since the contents of flash ROM can be modified, users are able to update the BIOS by themselves.

## **IDE (Integrated Drive Electronics)**

IDE devices integrate the drive control circuitry directly on the drive itself, eliminating the need for a separate adapter card (in the case for SCSI devices). UltraDMA/33 IDE devices can achieve up to 33MB/Sec transfer.

# 7. APPENDIX

---

## **LPT Port (Line Printer Port)**

Logical device name reserved by DOS for the computer parallel ports. Each LPT port is configured to use a different IRQ and address assignment.

## **MMX**

A set of 57 new instructions based on a technique called Single Instruction, Multiple Data (SIMD), which is built into the new Intel Pentium PP/MT (P55C) and Pentium II (Klamath) CPU as well as other x86-compatible microprocessors. The MMX instructions are designed to accelerate multimedia and communications applications, such as 3D video, 3D sound, video conference.

## **OnNow**

The OnNow design initiative is a comprehensive, system-wide approach to system and device power control. OnNow is a term for PC that is always ON but appears OFF and responds immediately to user or other requests. The OnNow design initiative involves changes that will occur in the Microsoft Windows operating system, device drivers, hardware, and applications, and also relies on the changes defined in the Advanced Configuration and Power Interface (ACPI) specification.

## **PC100**

SDRAM is Intel's goal is to ensure that memory subsystems continue to support evolving platform requirements and to assure that memory does not become a bottleneck to system performance. It is especially important to ensure that the PC memory roadmap evolves together with the performance roadmaps for the processors, I/O and graphics.

## **PCI Bus (Peripheral Component Interconnect Local Bus)**

PCI bus is a specification that defines a 32-bit data bus interface. PCI is a standard widely used by expansion card manufacturers.

## **PCI Bus Master**

The PCI Bus Master can perform data transfer without local CPU help and furthermore, the CPU can be treated as one of the Bus Masters. PCI 2.1 supports concurrent PCI operation to allow the local CPU and bus master to work simultaneously.

## **Plug and Play BIOS**

The ISA bus architecture requires the allocation of memory and I/O address, DMA channels and interrupt levels among multiple ISA cards. However, configuration of ISA cards is typically done with jumpers that change the decode maps for memory and I/O space and steer the DMA and interrupt signals to different pins on the bus. Further, system configuration files may need to be updated to reflect these changes. Users typically resolve sharing conflicts by referring to documentation provided by each manufacturer. For the average user, this configuration process can be unreliable and frustrating. Plug and play (PnP) BIOS eliminates the ISA add-on card hardware conflict problem. The PnP BIOS uses a memory block to define and remember each card's configuration, which allows the user to change the card's IRQs and DMA in BIOS either automatically or manually.

## **POST (Power On Self Test)**

When you turn ON the computer, it will first run through the POST, a series of software-controlled diagnostic tests. The POST checks system memory, the motherboard circuitry, the display, the keyboard, the diskette drive, and other I/O devices.

## **PS/2 Port**

PS/2 ports are based on IBM Micro Channel Architecture. This type of architecture transfers data through a 16-bit or 32-bit bus. A PS/2 mouse and/or keyboard may be used on ATX motherboards.

## **RDRAM (Rambus DRAM)**

Developed by Rambus, Inc., this type of memory can deliver up to 1.6GB of data per second. RDRAM is the first interface standard that can be directly implemented on high performance VLSI components such as, CMOS DRAMs, memory controllers, and graphics/video ICs.

# 7. APPENDIX

---

## **ROM (Read Only Memory)**

ROM is nonvolatile memory used to store permanent programs (called firmware) used in certain computer components. Flash ROM (or EEPROM) can be reprogrammed with new programs (or BIOS).

## **SCSI (Small Computer System Interface)**

High speed multi-threaded I/O interface defined by the X3T9.2 committee of the American National Standards Institute (ANSI) for connecting many peripheral devices. The standard started from 10MBytes/sec to 160MBytes/sec available today.

## **SDRAM (Synchronous DRAM)**

The SDRAM features a fully synchronous operation referenced to a positive edge clock whereby all operations are synchronized at a clock input which enables the coexistence of high performance and a simple user interface. SDRAM takes memory access away from the CPU's control; internal registers in the chips accept the request, and let the CPU do something else while the data requested is assembled for the next time the CPU talks to the memory. As they work on their own clock cycle, the rest of the system can be clocked faster. There is a version optimized for video cards, and main memory for motherboards.

## **SPD for SDRAM module**

Serial Presence Detect (SPD) is most like an ID detect for SDRAM module, it using a EEPROM component on DIMM module for storing module configuration information inside. The Serial Presence Detect function is implemented using a 2048 bit EEPROM component. This nonvolatile storage device contains data programmed by the DIMM manufacturer that identifies the module type and various SDRAM organization and timing parameters.

## **SSE (Streaming SIMD Extensions)**

A set of new instructions added to existing architectures that enables a better visual experience with an accelerated 3D geometry pipeline and support for new applications, such as real-time video encoding and speech recognition.

## **System Disk**

A system disk contains the core file of an operating system and is used to boot up the operating system.

## **UltraDMA**

Ultra DMA/33 is a "synchronous DMA" protocol designed by Intel. This function is included into Intel's PIIX4 chipset. The traditional IDE transfer only uses one edge of the data stroke as the data transfer. Ultra DMA/33 uses both edges of data strobe when the data is transferred. Hence, the data transfer rate is double of the PIO mode 4 or DMA mode 2 (16.6MB/s x2 = 33MB/s) on ATA-2 devices.

Ultra ATA/66, also known as Ultra DMA/66, is an extension of current Ultra ATA/33 interface. This new high-speed interface has doubled the Ultra ATA/33 burst data transfer rate to 66.6 Mbytes/sec and maximized disk performance under current PCI local bus environment

## **USB (Universal Serial Bus)**

A 4-pin serial cable bus that allows up to 127 plug and play computer peripherals such as keyboard, mouse, joystick, scanner, printer, modem, and monitor to share a bandwidth through a host scheduled token based protocol. This allows attaching or detaching while the host and other peripherals are in operation. Supports synchronous and asynchronous transfer types over the same set of wires up to 12Mbit/sec. USB 2.0 provides twice the transfer rate compared to USB 1.0 and competes with the 1394 standard.

## **Wake-On-LAN**

The computer automatically wakes up upon receiving a wake-up packet through a Network interface when it is under power soft-off, suspend or sleep mode.



# INDEX

---

## A

- Accelerated Graphics Port 8
  - AGP Capability 59
  - AGP Pro Slot 27
- Accessories
  - Fast Ethernet Card 83
- AGP. *See* Accelerated Graphics Port
- ASUS PC Probe 77
  - Starting 77
  - Task Bar Icon 81
  - Using 77, 78
- ATAPI CD-ROM 71
- ATX Power Supply Connector 37
- Automatic Power Up 70

## B

- BIOS
  - Advanced Menu 54
  - Beep Codes 39
  - Boot Menu 71
  - Boot Sequence 71
  - Exit Menu 73
  - Language 53
  - Legend Bar 46
  - Main Menu 48
  - Menu Bar 46
  - Power Menu 67
  - Setup Defaults, loading 74
  - Setup Program 45
  - Smart BIOS 9
  - Sub-menu launching 47
  - Updating 41
- Boot Device
  - Selection 71
- Boot Up NumLock Status 52
- Boot Virus Detection 72

## C

- Central Processing Unit (CPU) 23
  - Core Bus Frequency Multiple 19
  - External Frequency 18
  - Installation 24

- Level 1/Level 2 Cache 55
- Manual Frequency Settings 19
- Serial Number 55
- Speed 54
- Upgrade/Reinstallation 56
- ZIF Socket 23

- Chassis Intrusion 35
- Chip Configuration 58
- Connectors
  - ATX Power Supply 37
  - Chassis Fan 34
  - CPU Fan 34
  - External 29
  - Floppy Disk Drive 31
  - IDE 32
  - Infrared Module 35
  - Internal 31
  - Panel 38
  - Parallel Port 30
  - Power Supply Thermal Sensor 38
  - PS/2 Keyboard 29
  - PS/2 Mouse 29
  - Serial Port 30
  - SMBus 34, 37
  - USB 30
  - Wake-On-LAN 33
  - Wake-On-Ring 33
- CPU. *See* Central Processing Unit

## D

- DIMMs. *See* Dual Inline Memory Modules
- DIP Switches 17
- Dual Inline Memory Modules 21
  - DIMM Sockets 22
  - Types of 21
  - Voltage 22

# INDEX

---

## E

- Ethernet Card 83
- Expansion Cards
  - Assigning IRQs 26
  - Installing 25
- Expansion Slots 9

## F

- Floppy 3 Mode 48
- Floppy Disk Drive Connector 31

## H

- Hard Disk Drives (HDDs)
  - CHS Capacity 51
  - Cylinders 50
  - Heads 51
  - LBA Capacity 51
  - Primary/Secondary Master 49
  - Primary/Secondary Slave 49
  - Sectors 51
  - Translation Method 50
  - Types 49
- Hardware Monitor 70
- Hardware Setup
  - Procedure 16
- Headers
  - USB 34

## I

- IDE Activity LED 31
- IDE Connectors 32
- IDE Hard Disks. *See* Hard Disk Drives (HDDs)
- Infrared Module Connector 35
- Interrupt Request (IRQ)
  - Standard Assignments 26

## J

- JumperFree Mode
  - Notes for 56
- JumperFree™ Mode 17

## K

- Keyboard
  - Auto-Repeat Delay 52
  - Auto-Repeat Rate 52
  - Connector 29
  - Features 52

## L

- Legacy Diskette 48

## M

- Memory Hole 60
- Motherboard
  - Components 12, 13
  - IRQ Table 26
  - Layout 14
  - Settings 16
  - Specifications 8
  - Support CD 75
- Mouse
  - Connector 29
- Multi-Sector Transfers 51

## O

- Operating Systems 75

## P

- Parallel Port 61
  - Modes 62
- Parallel Port Connector 30
- Password
  - If You Forget 53
  - Notes 53
  - Supervisor 53
  - User 53

# INDEX

---

PCI Configuration 63  
PCI Latency Timer 63  
PCI/VGA Palette Snoop 63  
PIO Mode 51  
Plug & Play O/S 72  
Ports. *See* Connectors  
Power Management 67  
Power On Self Test 72  
Processor 8  
Processor Serial Number 55  
PS/2 Keyboard 29  
PS/2 Mouse 29  
    Function Control 55

**R**

RTC RAM  
    Clearing 20

**S**

SCSI BIOS 63  
SDRAM  
    Active to Precharge Time 58  
    CAS Latency 58  
    Configuration 58  
    RAS Precharge Time 58  
    RAS to CAS Delay 58  
    Read Around Write 59  
Serial Ports 61  
    Connectors 30  
Shadow Configuration 66  
SMART Monitoring 51  
SMBus Connector 34, 37  
Support CD 75  
    Applications 76  
    Installation Menu 75  
Suspend Mode 68  
System Chipset 8  
System Date 48  
System Frequency Multiple 54  
System Hangup 57

System Memory  
    Byte Merge 59  
    DIMMs 21  
    Installation 22  
    SDRAM 21  
System Start Up 39  
System Time 48  
System/PCI Frequency 54

## T

Thermal Sensor Connector 35, 38

## U

UART2 61  
Ultra DMA Mode 51  
Universal Serial Bus (USB) 30  
    Headers 34  
    Ports 30  
USB  
    Wake-up Jumpers 20  
USB Legacy Support 56  
Using  
    ASUS PC Probe 77  
USWC 60

## V

Video Memory 60

## W

Wake-On-LAN  
    Connector 33  
Wake-On-Ring  
    Connector 33  
Windows 98  
    First Time Installation 75

## Z

ZIF Socket 23

# INDEX

---

(This page was intentionally left blank.)