

**ASUS® P2B-D2**  
Dual Pentium® II Motherboard

**USER'S MANUAL**

# USER'S NOTICE

---

No part of this manual, including the products and software described in it, may be reproduced, transmitted, transcribed, stored in a retrieval system, or translated into any language in any form or by any means, except documentation kept by the purchaser for backup purposes, without the express written permission of ASUSTeK COMPUTER INC. ("ASUS").

ASUS PROVIDES THIS MANUAL "AS IS" WITHOUT WARRANTY OF ANY KIND, EITHER EXPRESS OR IMPLIED, INCLUDING BUT NOT LIMITED TO THE IMPLIED WARRANTIES OR CONDITIONS OF MERCHANTABILITY OR FITNESS FOR A PARTICULAR PURPOSE. IN NO EVENT SHALL ASUS, ITS DIRECTORS, OFFICERS, EMPLOYEES OR AGENTS BE LIABLE FOR ANY INDIRECT, SPECIAL, INCIDENTAL, OR CONSEQUENTIAL DAMAGES (INCLUDING DAMAGES FOR LOSS OF PROFITS, LOSS OF BUSINESS, LOSS OF USE OR DATA, INTERRUPTION OF BUSINESS AND THE LIKE), EVEN IF ASUS HAS BEEN ADVISED OF THE POSSIBILITY OF SUCH DAMAGES ARISING FROM ANY DEFECT OR ERROR IN THIS MANUAL OR PRODUCT.

Product warranty or service will not be extended if: (1) the product is repaired, modified or altered, unless such repair, modification or alteration is authorized in writing by ASUS; or (2) the serial number of the product is defaced or missing.

Products and corporate names appearing in this manual may or may not be registered trademarks or copyrights of their respective companies, and are used only for identification or explanation and to the owners' benefit, without intent to infringe.

- Adobe and Acrobat are registered trademarks of Adobe Systems Incorporated.
- Adaptec, AHA, EZ-SCSI, and AIC is a registered trademark of Adaptec, Inc.
- Sound Blaster, SB16, AWE32, AWE64D and SB-LINK are trademarks of Creative Technology Ltd.
- Intel, LANDesk, and Pentium are registered trademarks of Intel Corporation.
- IBM and OS/2 are registered trademarks of International Business Machines.
- Windows and MS-DOS are registered trademarks of Microsoft Corporation.
- Trend and ChipAwayVirus are trademarks of Trend Micro, Inc.

The product name and revision number are both printed on the product itself. Manual revisions are released for each product design represented by the digit before and after the period of the manual revision number. Manual updates are represented by the third digit in the manual revision number.

For previous or updated manuals, BIOS, drivers, or product release information, contact ASUS at <http://www.asus.com.tw> or through any of the means indicated on the following page.

SPECIFICATIONS AND INFORMATION CONTAINED IN THIS MANUAL ARE FURNISHED FOR INFORMATIONAL USE ONLY, AND ARE SUBJECT TO CHANGE AT ANY TIME WITHOUT NOTICE, AND SHOULD NOT BE CONSTRUED AS A COMMITMENT BY ASUS. ASUS ASSUMES NO RESPONSIBILITY OR LIABILITY FOR ANY ERRORS OR INACCURACIES THAT MAY APPEAR IN THIS MANUAL, INCLUDING THE PRODUCTS AND SOFTWARE DESCRIBED IN IT.

**Copyright © 1998 ASUSTeK COMPUTER INC. All Rights Reserved.**

Product Name:	<b>ASUS P2B-D2</b>
Manual Revision:	<b>1.02 E275</b>
Release Date:	<b>September 1998</b>

# ASUS CONTACT INFORMATION

---

## ASUSTeK COMPUTER INC.

### *Marketing*

Address: 150 Li-Te Road, Peitou, Taipei, Taiwan 112  
Telephone: +886-2-2894-3447  
Fax: +886-2-2894-3449  
Email: info@asus.com.tw

### *Technical Support*

Fax: +886-2-2895-9254  
BBS: +886-2-2896-4667  
Email: tsd@asus.com.tw  
WWW: www.asus.com.tw  
FTP: ftp.asus.com.tw/pub/ASUS

## ASUS COMPUTER INTERNATIONAL

### *Marketing*

Address: 6737 Mowry Avenue, Mowry Business Center, Building 2  
Newark, CA 94560, USA  
Fax: +1-510-608-4555  
Email: info-usa@asus.com.tw

### *Technical Support*

Fax: +1-510-608-4555  
BBS: +1-510-739-3774  
Email: tsd-usa@asus.com.tw  
WWW: www.asus.com  
FTP: ftp.asus.com.tw/pub/ASUS

## ASUS COMPUTER GmbH

### *Marketing*

Address: Harkort Str. 25, 40880 Ratingen, BRD, Germany  
Telephone: 49-2102-445011  
Fax: 49-2102-442066  
Email: info-ger@asus.com.tw

### *Technical Support*

Hotline: 49-2102-499712  
BBS: 49-2102-448690  
Email: tsd-ger@asus.com.tw  
WWW: www.asuscom.de  
FTP: ftp.asuscom.de/pub/ASUSCOM

# CONTENTS

---

<b>I. INTRODUCTION</b> .....	<b>7</b>
How this Manual is Organized .....	7
Item Checklist .....	7
<b>II. FEATURES</b> .....	<b>8</b>
Features .....	8
The ASUS P2B-D2 Motherboard .....	9
<b>III. INSTALLATION</b> .....	<b>10</b>
The ASUS P2B-D2 Motherboard Layout .....	10
Installation Steps .....	12
1. Jumpers .....	12
Jumper Settings .....	13
2. System Memory .....	16
Main Memory (DIMM).....	16
DIMM Memory Installation Procedures .....	17
i960 Memory (SIMM).....	18
SIMM Installation .....	18
3. Central Processing Unit (CPU).....	19
Pentium II Processor .....	19
Recommended Heatsinks .....	23
AAVID Heatsink .....	23
Elan Vital Heatsink .....	23
4. Expansion Cards .....	24
Expansion Card Installation Procedure .....	24
Assigning IRQs for Expansion Cards.....	24
Assigning DMA Channels for ISA Cards.....	25
ISA Cards and Hardware Monitor .....	25
5. External Connectors .....	26
Power Connection Procedures .....	37
<b>IV. BIOS SOFTWARE</b> .....	<b>38</b>
Flash Memory Writer Utility .....	38
Main Menu .....	38
Managing and Updating Your Motherboard's BIOS .....	40
6. BIOS Setup .....	41
Load Defaults .....	42
Standard CMOS Setup .....	42
Details of Standard CMOS Setup:.....	42
BIOS Features Setup .....	45
Details of BIOS Features Setup .....	45

# CONTENTS

---

Chipset Features Setup .....	48
Details of Chipset Features Setup .....	48
Power Management Setup .....	51
Details of Power Management Setup .....	51
PNP and PCI Setup .....	54
Details of PNP and PCI Setup .....	54
Load BIOS Defaults .....	56
Load Setup Defaults .....	56
Supervisor Password and User Password .....	57
IDE HDD Auto Detection .....	58
Save & Exit Setup .....	59
Exit Without Saving .....	59
<b>V. Support CD .....</b>	<b>61</b>
Support CD Contents .....	61
<b>A. Video Driver .....</b>	<b>63</b>
Windows 95 .....	63
Windows NT 4.0 .....	67
<b>B. Network Interface .....</b>	<b>69</b>
<b>C. Adaptec SCSI Select .....</b>	<b>83</b>
<b>D. Adaptec EZ-SCSI .....</b>	<b>84</b>
<b>E. DMI Utility .....</b>	<b>92</b>
<b>F. ASUS LAN Card (Optional) .....</b>	<b>95</b>

# FCC & DOC COMPLIANCE

---

## ***Federal Communications Commission Statement***

This device complies with FCC Rules Part 15. Operation is subject to the following two conditions:

- This device may not cause harmful interference, and
- This device must accept any interference received, including interference that may cause undesired operation.

This equipment has been tested and found to comply with the limits for a Class B digital device, pursuant to Part 15 of the FCC Rules. These limits are designed to provide reasonable protection against harmful interference in a residential installation. This equipment generates, uses and can radiate radio frequency energy and, if not installed and used in accordance with manufacturer's instructions, may cause harmful interference to radio communications. However, there is no guarantee that interference will not occur in a particular installation. If this equipment does cause harmful interference to radio or television reception, which can be determined by turning the equipment off and on, the user is encouraged to try to correct the interference by one or more of the following measures:

- Re-orient or relocate the receiving antenna.
- Increase the separation between the equipment and receiver.
- Connect the equipment to an outlet on a circuit different from that to which the receiver is connected.
- Consult the dealer or an experienced radio/TV technician for help.

**WARNING!** The use of shielded cables for connection of the monitor to the graphics card is required to assure compliance with FCC regulations. Changes or modifications to this unit not expressly approved by the party responsible for compliance could void the user's authority to operate this equipment.

## ***Canadian Department of Communications Statement***

This digital apparatus does not exceed the Class B limits for radio noise emissions from digital apparatus set out in the Radio Interference Regulations of the Canadian Department of Communications.

# I. INTRODUCTION

## How this Manual is Organized

This manual is divided into the following sections:

<b>I. Introduction</b>	Manual information and checklist
<b>II. Features</b>	Information and specifications
<b>III. Installation</b>	Setting up the motherboard and jumpers
<b>IV. BIOS Software</b>	Setting up the BIOS software
<b>V. Support CD</b>	Information on the included support software

## Item Checklist

Check that your package is complete. If you discover damaged or missing items, contact your retailer.

- (1) ASUS Motherboard
- (2) Processor Retention Mechanisms
- (2) Attach mount bridges (factory installed)
- (1) IDE ribbon cable for master and slave drives
- (1) Floppy ribbon cable for (1) 5.25inch floppy and (2) 3.5inch floppies
- (1) Bag of spare jumpers
- (1) Support drivers and utilities
- (1) User's Manual
- (1) ASUS C-P2T PC100 CPU termination card
- (1) Adaptec 7800 Family Manager Set User's Manual
- (1) Serial COM2 external connector
- (1) 68-pin Ultra2 SCSI cable
- (1) 50-pin Narrow SCSI cable
- (1) Ultra2 SCSI terminator
- Infrared module (optional)
- ASUS PCI-L101 Wake-On-LAN 10/100 Ethernet Card (optional)

# II. FEATURES

---

## Features

The ASUS P2B-D2 motherboard is carefully designed for the demanding PC user who wants advanced features processed by the fastest CPU.

- **Multi-Speed:** Supports Dual Intel Pentium® II processors from 233MHz to 450MHz.
- **I2O:** Includes Intel's i960RD I/O processor with 32KB NVRAM, 4x512KB Flash EEPROM, and 2 SIMM slots for up to 256MB of memory.
- **Intel Chipset:** Features Intel's 440BX AGPset with I/O subsystems and front-side bus (FSB) platform, which boosts the traditional 66-MHz internal bus speed to 100MHz.
- **Enhanced ACPI and Anti-Boot Virus BIOS:** Features a programmable BIOS, offering enhanced ACPI for Windows 98 compatibility, built-in hardware-based virus protection through Trend ChipAwayVirus, and autodetection of most devices for virtually automatic setup.
- **PC100 Memory Support:** Equipped with four DIMM sockets to support Intel PC100-compliant SDRAMs (8, 16, 32, 64, 128, or 256MB) up to 1GB. These new SDRAMs are necessary to meet the enhanced 100MHz bus speed requirement.
- **Wake-On-LAN:** Supports Wake-On-LAN activity with the onboard network interface.
- **Network Interface:** Features the Intel 82558 Ethernet LAN Controller (fully integrated 10BASE-T/100BASE-TX).
- **Alert-On-LAN:** Supports Alert-On-LAN, which enables the host to send immediate alerts to the network administrators when there are hardware or operating system failures, or any evidence of tampering.
- **Adaptec SCSI Chipset:** Features Adaptec AIC-7890 Ultra2 SCSI chipset that supports a combination of 8-bit and 16-bit Ultra2, Ultra, and single-ended or standard SCSI devices and the AIC-3860 transceiver chipset that bridges the compatibility gap between these mixed environments without affecting system performance by taking advantage of the benefits of low-voltage differential (LVD) technology.
- **SB-Link™:** Features Creative's SB-Link™, allowing SB16 compatibility, using Intel's PC-PCI and serialized IRQ protocols, to AWE64D or compatible PCI audio cards.
- **SMBus:** Features the System Management Bus interface, which is used to physically transport commands and information between SMBus devices.
- **PCI & ISA Expansion Slots:** Provides one 16-bit ISA, three master 32-bit PCI, and three secondary 32-bit PCI slots.
- **Intelligence:** Supports Fan Status Monitoring and Alarm, Temperature Monitoring and Alert, Voltage Monitoring and Alert, System Resources Alert, and Virus Write Protection through the onboard Hardware Monitor, Intel LANDesk Client Manager (LDCM), and ASUS PC Probe software, and Alert-On-LAN function.
- **Super Multi-I/O:** Provides two high-speed UART compatible serial ports and one parallel port with EPP and ECP capabilities. UART2 can also be directed from COM2 to the Infrared Module for wireless connections.
- **Desktop Management Interface (DMI):** Supports DMI through BIOS, which allows hardware to communicate within a standard protocol creating a higher level of compatibility. (Requires DMI-enabled components.) (See section V)
- **Ultra DMA/33 Bus Master IDE/Floppy:** Comes with an onboard PCI Bus Master IDE controller with two connectors that supports four IDE devices in two channels, supports UltraDMA/33, PIO Modes 3 and 4 and Bus Master IDE DMA Mode 2, and supports Enhanced IDE devices. Two floppy drives of either 5.25inch or 3.5inch (1.44MB or 2.88MB) are also supported without an external card. Supports Japanese standard "Floppy 3 mode" (3.5-inch disk drive: 1.44MB, 1.2MB, 720KB) and LS-120 floppy disk drives (3.5-inch disk drive: 120 MB). BIOS supports IDE CD-ROM or SCSI device boot-up.
- **IrDA:** Supports an optional infrared port module for wireless interface.
- **Concurrent PCI:** Allows multiple PCI transfers from PCI master buses to memory to CPU.



# II. FEATURES

## The ASUS P2B-D2 Motherboard

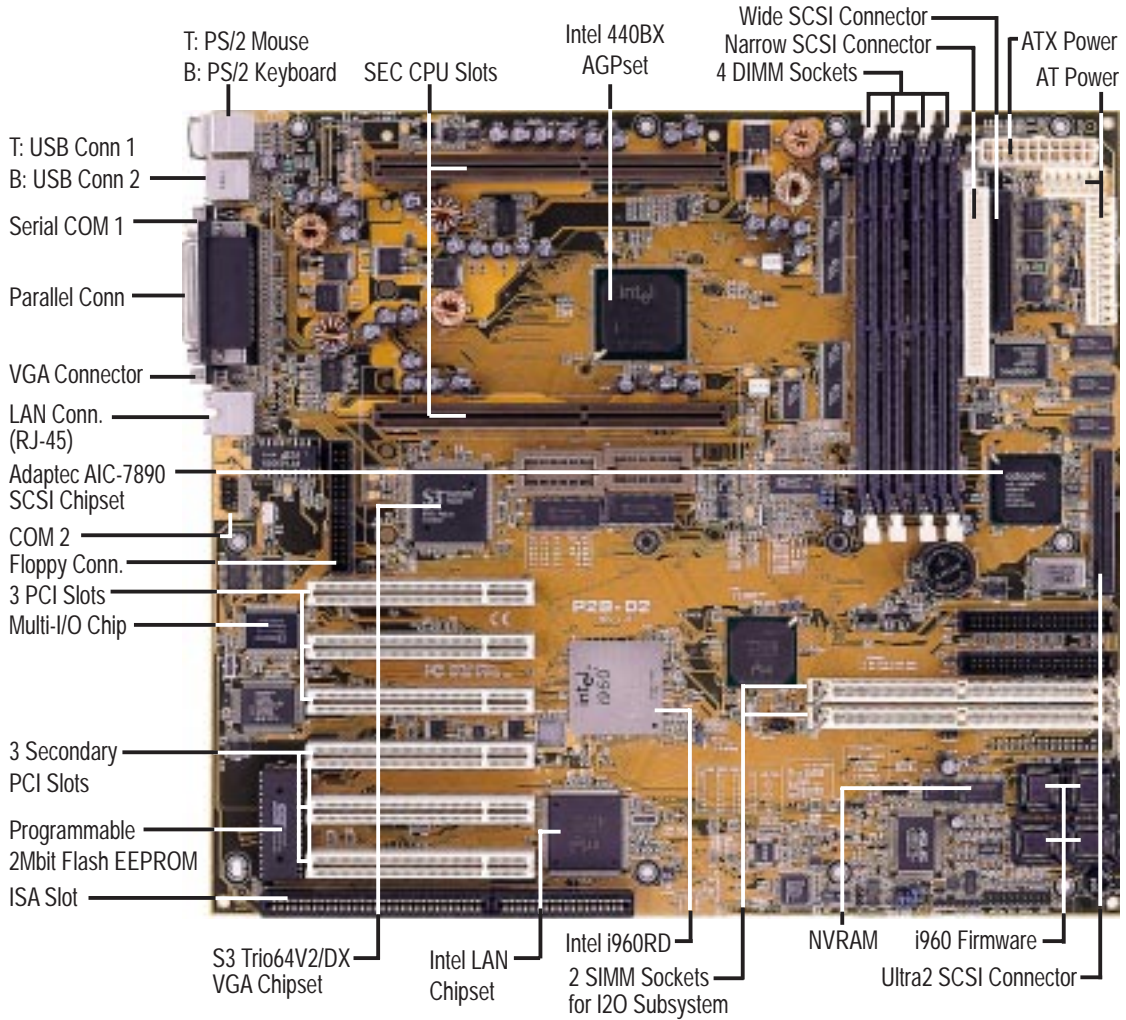

II. FEATURES  
Motherboard Parts

# III. INSTALLATION

## The ASUS P2B-D2 Motherboard Layout

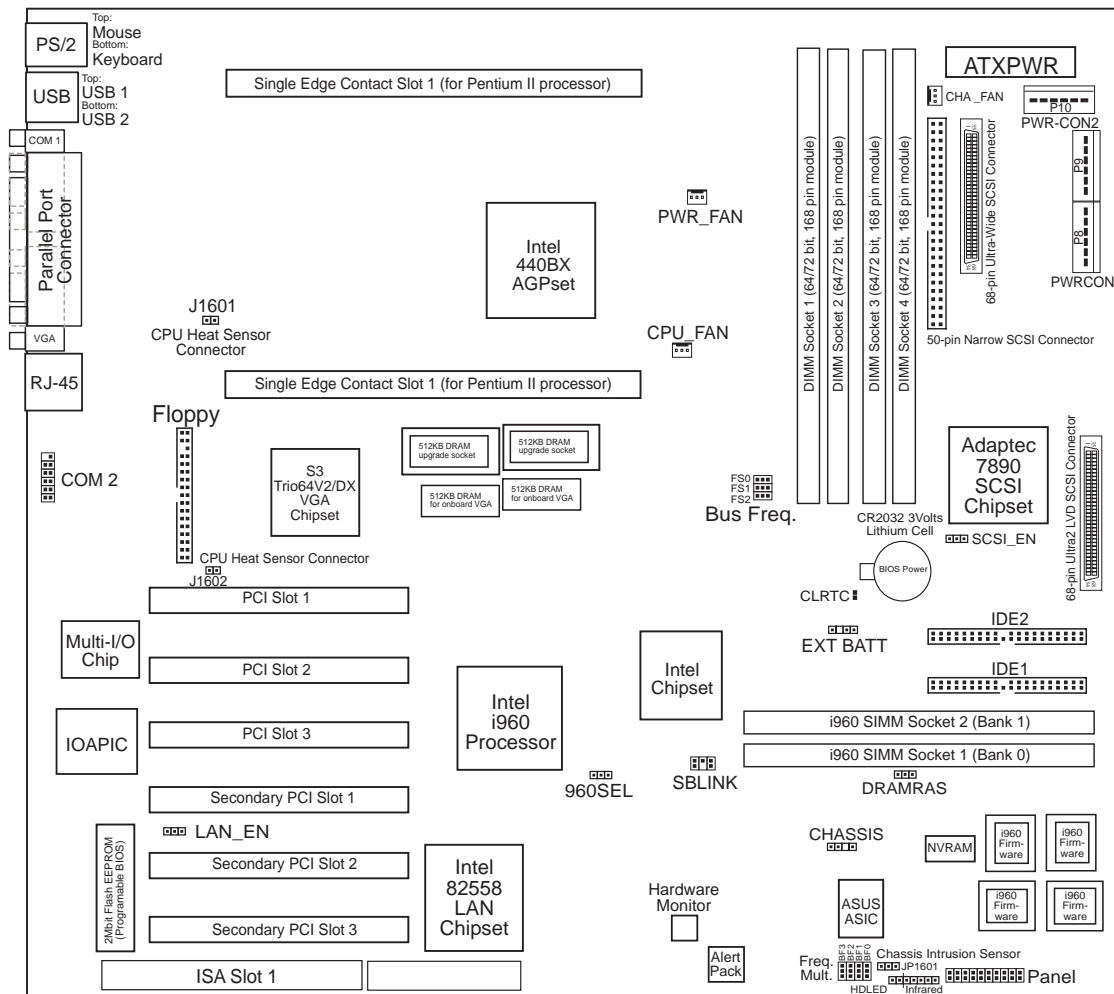

**III. INSTALLATION**  
 Board Layout

# III. INSTALLATION

## Jumpers

- |                       |   |
|-----------------------|---|
| 1) CLRTC              | p. 13 Clear Real Time Clock (RTC) RAM                   |
| 2) 960SEL             | p. 13 i960 Setting (I2O/Bridge)                         |
| 3) DRAMRAS            | p. 13 i960RD DRAM RAS Setting (Single/Double)           |
| 4) FS0, FS1, FS2      | p. 14 CPU Bus Frequency                                 |
| 5) BF0, BF1, BF2, BF3 | p. 14 CPU Core:Bus Frequency Multiple                   |
| 6) JP1601             | p. 15 Chassis Intrusion Sensor Setting (Enable/Disable) |
| 7) LAN_EN             | p. 15 LAN Setting (Enable/Disable)                      |
| 8) SCSI_EN            | p. 15 SCSI Setting (Enable/Disable)                     |

## Expansion Slots/Sockets

- |                           |  |
|---------------------------|--|
| 1) DIMM1-4                | p. 16 DIMM System Memory Sockets               |
| 2) I-SIMM1, I-SIMM2       | p. 18 SIMM i960 Memory Sockets                 |
| 3) SEC CPU Slots          | p. 19 Single Edge Contact CPU Support          |
| 4) SLOT1                  | p. 24 16-bit ISA Bus Expansion Slot*           |
| 5) S-PCI1, S-PCI2, S-PCI3 | p. 25 32-bit Secondary PCI Bus Expansion Slots |
| 6) PCI1, PCI2, PCI3       | p. 25 32-bit PCI Bus Expansion Slots           |

## Hardware Monitor

- |                 |                                 |
|-----------------|---------------------------------|
| 1) J1601, J1602 | p. 20 CPU Heat Sensor Connector |
|-----------------|---------------------------------|

## Connectors

- |                               |   |
|-------------------------------|---|
| 1) PS2KBMS                    | p. 26 PS/2 Keyboard Port Connector (6 pin female)             |
| 2) PS2MBMS                    | p. 26 PS/2 Mouse Port Connector (6 pin female)                |
| 3) PRINTER                    | p. 27 Parallel (Printer) Port Connector (25 pin female)       |
| 4) COM1                       | p. 27 Serial Port COM1 Port Connector (two 9 pin male)        |
| 5) VGA                        | p. 27 Monitor (VGA) Output Port Connector (15 pin female)     |
| 6) USB                        | p. 28 Universal Serial BUS Ports 1 & 2 (two 4 pin female)     |
| 7) RJ-45                      | p. 28 RJ-45 Port Connector (8 pin female)                     |
| 8) IDELED                     | p. 28 IDE/SCSI LED Activity Light (2 pins)                    |
| 9) IDE1, IDE2                 | p. 29 Primary/Secondary IDE Connector (40 pins)               |
| 10) CHASSIS                   | p. 29 Chassis Intrusion Sensor Lead (4-1 pins)                |
| 11) IR                        | p. 30 Infrared Port Module Connector (5 pins)                 |
| 12) CHA_/CPU_/PWR_FAN         | p. 30 Chassis/CPU/Power Supply Fan Connectors (3 pins)        |
| 13) PWRCON, PWR-CON2          | p. 31 AT Power Supply Connector (12 pins)                     |
| 14) ATXPWR                    | p. 31 ATX Motherboard Power Connector (20 pins)               |
| 15) MSG.LED (PANEL)           | p. 32 LED Lead (2 pins)                                       |
| 16) SMI (PANEL)               | p. 32 SMI Suspend Switch Lead (2 pins)                        |
| 17) PWR.SW (PANEL)            | p. 32 ATX Power Switch / Soft Power Switch (2 pins)           |
| 18) RESET (PANEL)             | p. 32 Reset Switch Lead (2 pins)                              |
| 19) PWR.LED (PANEL)           | p. 32 System Power LED (3 pins)                               |
| 20) KEY LOCK (PANEL)          | p. 32 Keyboard Lock Switch Lead (2 pins)                      |
| 21) SPEAKER (PANEL)           | p. 32 Speaker Connector (4 pins)                              |
| 22) SCSI-50/SCSI-68/ULTRA2-68 | p. 33 50 pin Narrow/68 pin Wide/68 pin Ultra2 SCSI Connectors |
| 23) SBLINK                    | p. 34 SB-LINK™ Port Connector (6-1 pins)                      |
| 24) FLOPPY                    | p. 34 Floppy Drive Port Connector (34-1 pins)                 |
| 25) COM2                      | p. 34 Serial Port Connector (COM2, 10-1 pins)                 |
| 26) VGA Memory                | p. 35 VGA Memory Expansion Sockets                            |

\*The onboard hardware monitor uses the address 290H-297H so legacy ISA cards must not use this address, otherwise conflicts will occur.





# III. INSTALLATION

## Installation Steps

Before using your computer, you must complete the following steps:

1. **Set Jumpers on the Motherboard**
2. **Install System Memory Modules**
3. **Install the Central Processing Unit (CPU)**
4. **Install Expansion Cards**
5. **Connect Ribbon Cables, Cabinet Wires, and Power Supply**
6. **Setup the BIOS Software**

## 1. Jumpers

Several hardware settings are made through the use of jumper caps to connect jumper pins (JP) on the motherboard. See motherboard layout for locations of jumpers. The jumper settings will be described numerically, such as [----], [1-2], [2-3] for no connection, connect pins 1&2, and connect pins 2&3, respectively. A “1” is written besides pin 1 on jumpers with three pins. The jumpers will also be shown graphically such as  to connect pins 1&2 and  to connect pins 2&3. Jumpers with two pins will be shown as  for Short (On) and  for Open (Off). For manufacturing simplicity, the jumpers may be sharing pins from other groups. Use the diagrams in this manual instead of following the pin layout on the board. Settings with two jumper numbers require that both jumpers be moved together. To connect the pins, simply place a plastic jumper cap over the two pins as diagrammed.

**WARNING!** Computer motherboards, baseboards and components, such as SCSI cards, contain very delicate Integrated Circuit (IC) chips. To protect them against damage from static electricity, you should follow some precautions whenever you work on your computer.

1. Unplug your computer when working on the inside.
2. Use a grounded wrist strap before handling computer components. If you do not have one, touch both of your hands to a safely grounded object or to a metal object, such as the power supply case.
3. Hold components by the edges and try not to touch the IC chips, leads or connectors, or other components.
4. Place components on a grounded antistatic pad or on the bag that came with the component whenever the components are separated from the system.

# III. INSTALLATION

## Jumper Settings

### 1. Clear Real Time Clock (RTC) RAM (CLRRTC)

The CMOS RAM is powered by the onboard button cell battery. To clear the RTC data: (1) Turn off your computer and unplug its AC power, (2) Short the two solder points labeled CLRRTC, (3) Turn on your computer, (4) Hold down <Delete> during bootup and enter BIOS setup to re-enter user preferences.

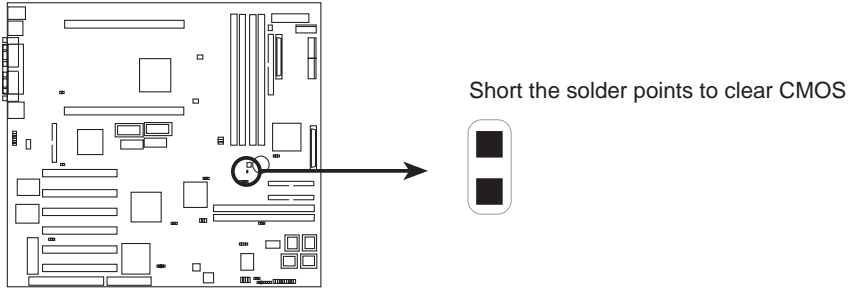

**P2B-D2 Real Time Clock RAM (CLRRTC)**

### 2. i960 Bridge Setting

The secondary PCI slots can function as standard PCI slots when the i960 is set to “Bridge” mode. When the i960 is set to “I2O” mode, the secondary PCI slots are controlled by the i960 and only intelligent I/O (I2O) cards can be used on the secondary PCI slots. An i960 memory module is required for the “I2O” mode.

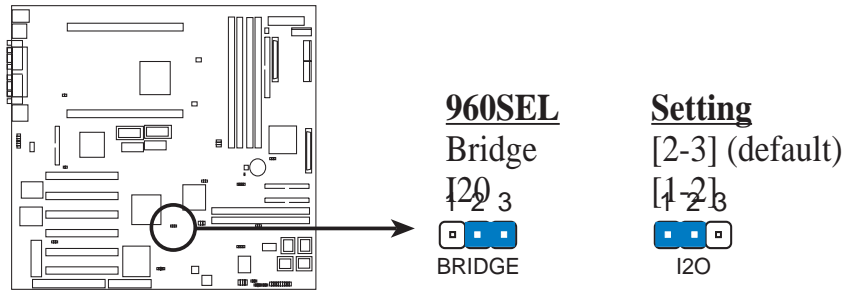

**P2B-D2 i960 Setting**

### 3. i960 Local DRAM RAS Setting

When the i960 is set to I2O mode, the i960 chip acts as a processor and at least one SIMM memory module is required. When using a single memory module, this jumper does not need setting but must be installed in i960 SIMM1. When using two memory modules, this jumper needs to be set according to the number of sides used by the chips mounted on the memory modules.

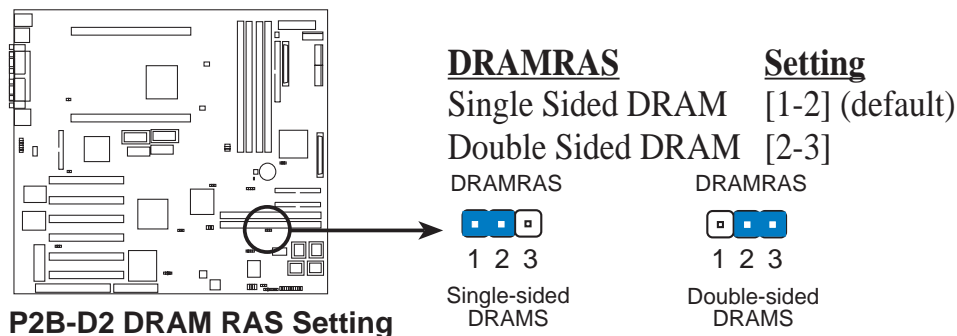

**P2B-D2 DRAM RAS Setting**

# III. INSTALLATION

## 4. CPU Bus Frequency (FS0, FS1, FS2)

This option tells the clock generator what frequency to send to the CPU, DRAM, and 440BX AGPset. This allows the selection of the CPU's *External* frequency (or *BUS Clock*). The BUS Clock multiplied by the BUS Ratio equals the CPU's *Internal* frequency (the advertised CPU speed).

## 5. CPU Core:BUS Frequency Multiple (BF0, BF1, BF2, BF3)

This option sets the frequency multiple between the *Internal* frequency of the CPU and the CPU's *External* frequency. These must be set in conjunction with the *CPU Bus Frequency*.

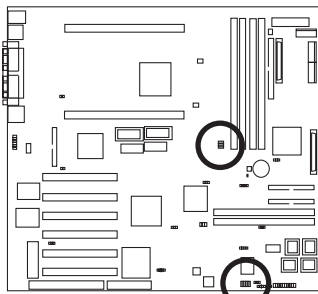

P2B-D2 CPU Settings

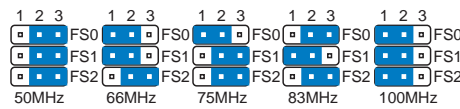

CPU Bus Frequency

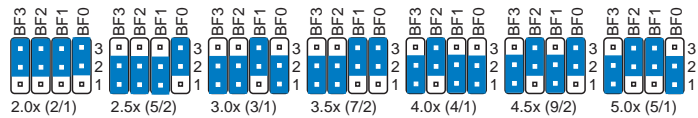

CPU Core:Bus Frequency Multiple

**WARNING!** Frequencies above 100MHz exceed the specifications for the on-board Intel Chipset and are not guaranteed to be stable.

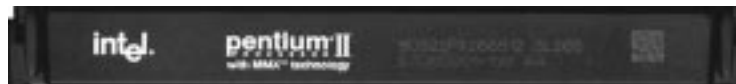

Intel Pentium II Processor in an SEC cartridge (233-450MHz)

Set the jumpers by the Internal speed of your processor as follows:

CPU Model	Freq.	Ratio	(BUS Freq.)				(Freq. Ratio)			
			BUS F.	FS2	FS1	FS0	BF3	BF2	BF1	BF0
Intel Pentium II	450MHz	4.5x	100MHz	[1-2]	[1-2]	[1-2]	[1-2]	[2-3]	[1-2]	[2-3]
Intel Pentium II	400MHz	4.0x	100MHz	[1-2]	[1-2]	[1-2]	[1-2]	[2-3]	[1-2]	[1-2]
Intel Pentium II	350MHz	3.5x	100MHz	[1-2]	[1-2]	[1-2]	[1-2]	[1-2]	[2-3]	[2-3]
Intel Pentium II	333MHz	5.0x	66MHz	[2-3]	[1-2]	[1-2]	[1-2]	[2-3]	[2-3]	[1-2]
Intel Pentium II	300MHz	4.5x	66MHz	[2-3]	[1-2]	[1-2]	[1-2]	[2-3]	[1-2]	[2-3]
Intel Pentium II	266MHz	4.0x	66MHz	[2-3]	[1-2]	[1-2]	[1-2]	[2-3]	[1-2]	[1-2]
Intel Pentium II	233MHz	3.5x	66MHz	[2-3]	[1-2]	[1-2]	[1-2]	[1-2]	[2-3]	[2-3]

**NOTES:** Overclocking your processor is not recommended. It may result in a slower speed. Voltage Regulator Output Selection (VID) is not needed for the Pentium II processor because it sends a VID signal directly to the onboard power controller.

# III. INSTALLATION

## 6. Chassis Intrusion Sensor Setting (JP1601)

This allows you to disable or enable the chassis intrusion sensor. Set to *Enable* if you want to use this function to monitor the opening of the chassis. The default is set to *Disable*.

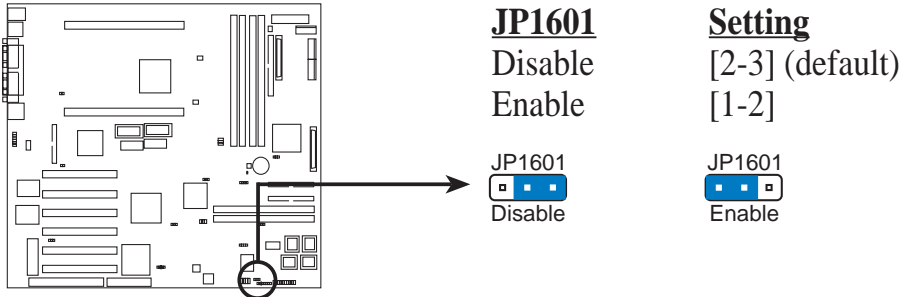

**P2B-D2 Chassis Intrusion Sensor Setting**

## 7. LAN Setting (LAN\_EN)

The onboard Intel 10/100 Fast Ethernet may be enabled or disabled using this jumper.

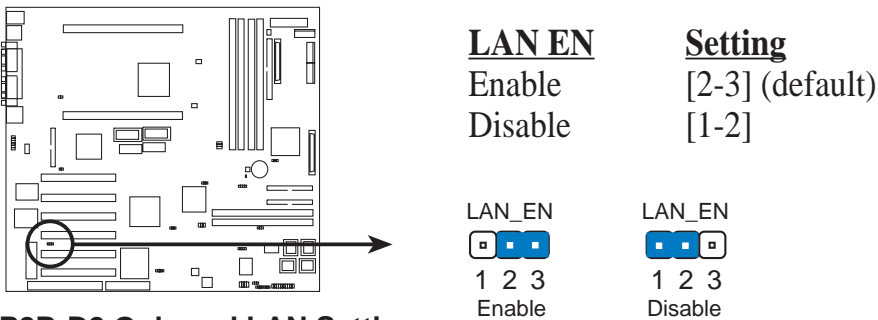

**P2B-D2 Onboard LAN Setting**

## 8. SCSI Setting (SCSI\_EN)

The onboard Adaptec Fast/Wide/Ultra2 SCSI may be enabled or disabled using this jumper.

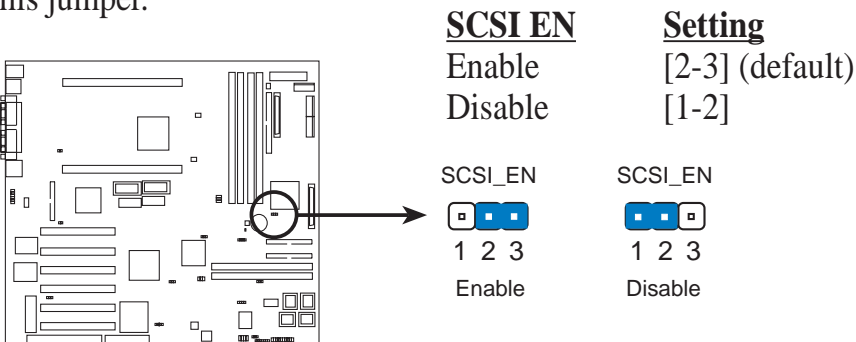

**P2B-D2 Onboard SCSI Setting**

# III. INSTALLATION

## 2. System Memory

### Main Memory (DIMM)

This motherboard supports Dual Inline Memory Modules (DIMMs). Sockets are available for **3.3Volt** (power level) unbuffered Synchronous Dynamic Random Access Memory (SDRAM). One side (with memory chips) of the DIMM takes up one row on the motherboard.

To utilize the chipset's Error Checking and Correction (ECC) feature, you must use a DIMM module with 9 chips per side (standard 8 chips/side + 1 ECC chip) and make the proper settings through "Chipset Features Setup" in **IV. BIOS SOFTWARE**.

Memory speed setup is recommended through *SDRAM Configuration* under "Chipset Features Setup".

**IMPORTANT** (see **General DIMM Notes** below)

- **SDRAMs used must be compatible with the current Intel PC100 SDRAM specification.**

*Install memory in any combination as follows:*

DIMM Location	168-pin DIMM Memory Modules		Total Memory
Socket 1 (Rows 0&1)	SDRAM 8, 16, 32, 64, 128, 256MB	x1	
Socket 2 (Rows 2&3)	SDRAM 8, 16, 32, 64, 128, 256MB	x1	
Socket 3 (Rows 4&5)	SDRAM 8, 16, 32, 64, 128, 256MB	x1	
Socket 4 (Rows 6&7)	SDRAM 8, 16, 32, 64, 128, 256MB	x1	
	<b>Total System Memory (Max 1GB)</b>	=	

### General DIMM Notes

- **Use only PC100-compliant DIMMs.** This motherboard operates at 100MHz, thus most systems will not even boot if non-compliant modules are used because of the strict timing issues involved under this speed.
- Two possible memory chips are supported: SDRAM with and without ECC.
- SDRAM chips are generally thinner with higher pin density than EDO (Extended Data Output) chips.
- BIOS shows SDRAM memory on bootup screen.
- 8 chips/side modules do not support ECC, only 9 chips/side modules support ECC.
- Single-sided DIMMs come in 16, 32, 64, 128MB; double-sided come in 32, 64, 128, 256MB.



# III. INSTALLATION

## *DIMM Memory Installation Procedures*

Insert the module(s) as shown. Because the number of pins is different on either side of the breaks, the module will only fit in the orientation as shown. DRAM SIMM modules have the same pin contacts on both sides. SDRAM DIMMs have different pin contacts on each side and therefore have a higher pin density.

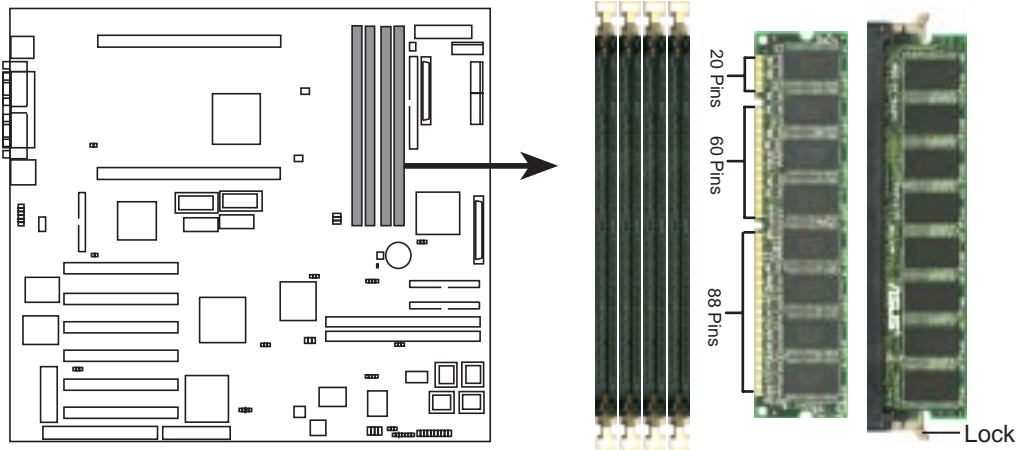

### **P2B-D2 168-Pin DIMM Memory Sockets**

The DIMMs must be 3.3Volt unbuffered SDRAMs. To determine the DIMM type, check the notches on the DIMMs (see figure below).

#### **168-Pin DIMM Notch Key Definitions (3.3V)**

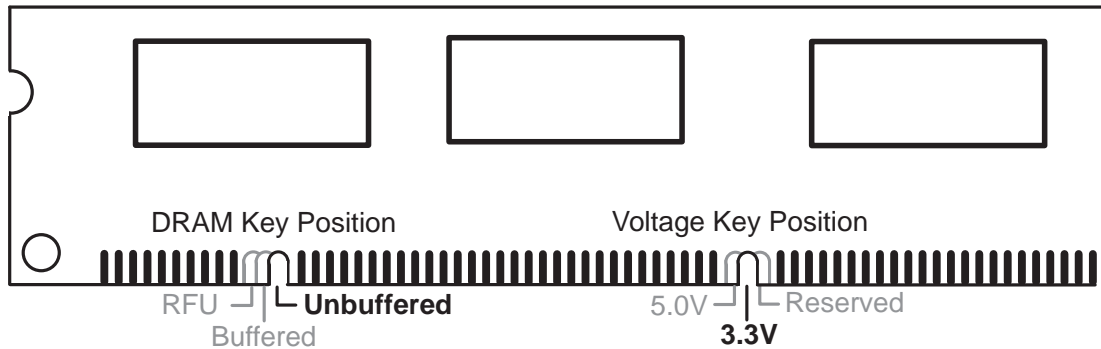

The notches on the DIMM will shift between left, center, or right to identify the type and also to prevent the wrong type from being inserted into the DIMM slot on the motherboard. You must tell your retailer the correct DIMM type before purchasing. This motherboard supports four clock signals.

# III. INSTALLATION

## i960 Memory (SIMM)

The i960 processor supports two 72-pin, 32-bit SIMMs (Single-Inline Memory Modules) of 4, 8, 16, 32, 64, or 128MB to form a memory size between 8MB to 256MB. Only Extended Data Output (EDO) DRAM, non-parity SIMMs can be supported by the i960 processor.

**IMPORTANT:** You must use i960 SIMM socket 1 when using only one module.

### *SIMM Installation*

1. The SIMM memory modules will fit in only one orientation as shown because the plastic safety tab on one end of the SIMM sockets requires the notched end of the SIMM memory modules.

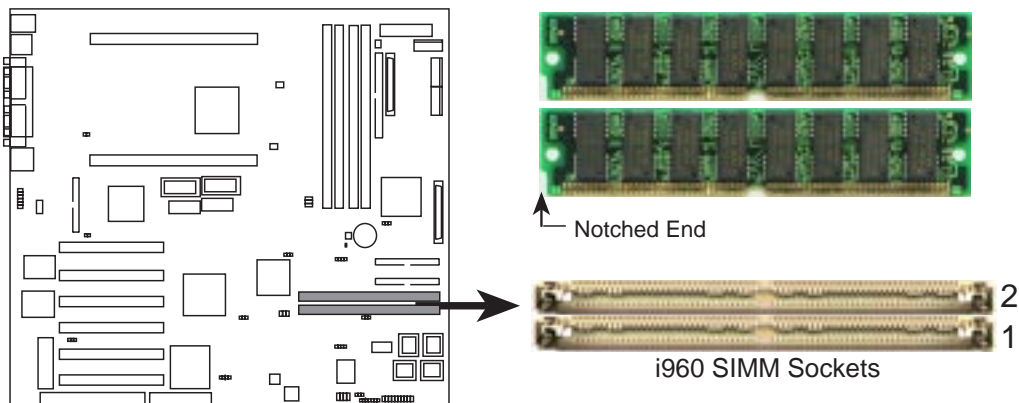

### **P2B-D2 72-Pin i960 SIMM Sockets**

2. Press the memory module firmly into place starting from a 45-degree angle, making sure that all the contacts are aligned with the socket.
3. With your fingertips, rock the memory module into a vertical position so that it clicks into place. The plastic guides should go through the two mounting holes and the clips should snap.

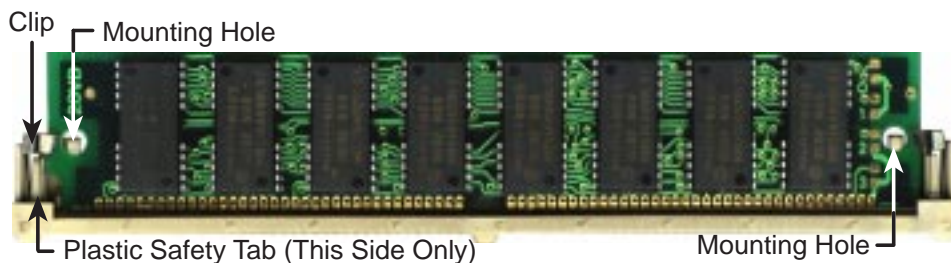

4. To release the memory module, push both clips outward and rock the module out of the clips.

# III. INSTALLATION

## 3. Central Processing Unit (CPU)

This motherboard provides two Single Edge Contact (SEC) slots for Pentium II processors packaged in SEC cartridges.

### *Pentium II Processor*

You should check to see that you have the following items:

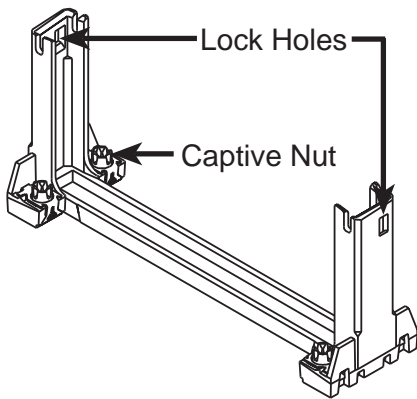

**Two Pentium II Retention Mechanisms**

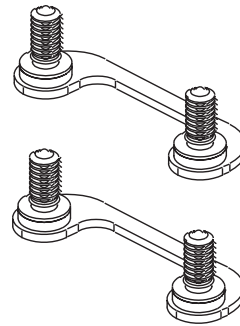

**Two Attach Mount Bridges**  
(factory installed)

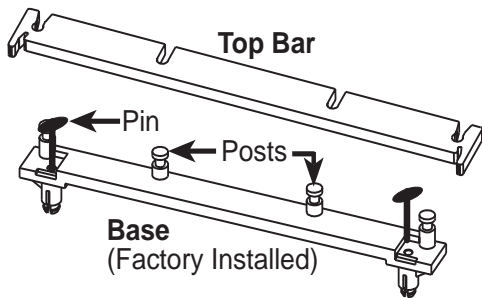

**Heatsink Support Base/Top Bar**

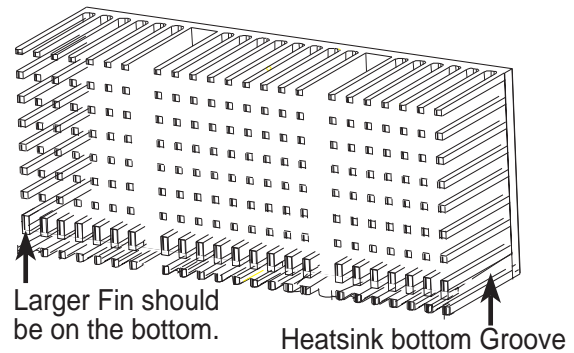

**Pentium II Processor Heatsink**

The recommended heatsinks (see section on recommended heatsinks for more information) for the Pentium II processor are those with three-pin fans that can be connected to the fan connectors on the motherboard.

# III. INSTALLATION

**WARNING!** Be sure that there is sufficient air circulation across the processor's heatsink by regularly checking that your CPU fan is working. Without sufficient circulation, the processor could overheat and damage both the processor and the motherboard. You may install an auxiliary fan, if necessary.

## Other Important Items



Intel Pentium II Processor in an SEC cartridge

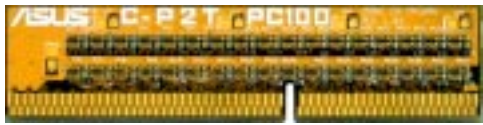

ASUS C-P2T PC100 CPU Termination Card

## Installing the Pentium II Processor

- 1. Mount the Processor Retention Mechanism(s):** The processor retention mechanisms are designed to fit into the SEC slots only one way.

Be sure to align the notches in the retention mechanisms with the small ribs on each side of the slots and that the mechanism is properly seated on the board. Then, screw the captive nuts in place.

**WARNING!** Do not overtighten the captive nuts. Doing so could damage your motherboard. Tighten captive nuts to no more than  $6\pm 1$  inch/pound.

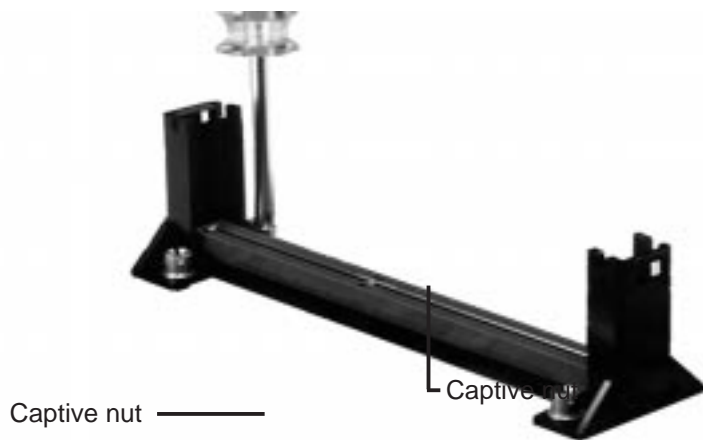

## III. INSTALLATION

- 2. Mount the Heatsink:** Place the SEC cartridge face down on a flat surface and lay the heatsink flush on the back (metal side) of the SEC cartridge. Be sure that the heatsink is firmly pressed against the SEC cartridge. When correctly installed, no light can be seen between the thermal pad of the heatsink and the SEC cartridge.

**IMPORTANT:** The heatsinks must not be more than 2.8 cm (1.1 inch) thick.

**WARNING!** If the heatsink is not mounted tightly against the SEC cartridge, the CPU will overheat. You may install an auxiliary fan to provide adequate circulation across the processor's passive heatsink.



- 3. Insert the SEC Cartridge:** Push the SEC cartridge's two locks inward until you hear a click (the preceding picture shows the locks in the outward position and inward in the picture below). With the heatsink facing the motherboard's chipset, press the cartridge gently but firmly until it is fully inserted. (**NOTE:** The procedures shown here are for installing the AAVID heatsink with fan.)

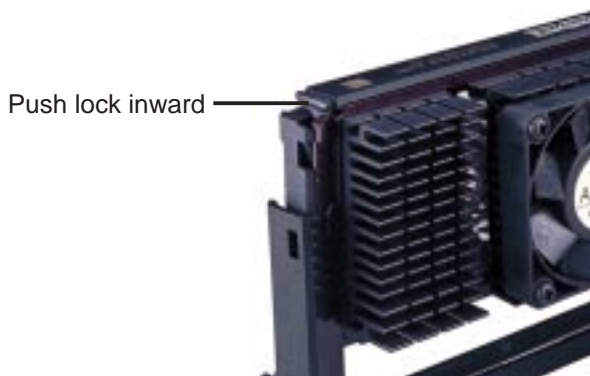

# III. INSTALLATION

**IMPORTANT:** If you are installing only one processor, you must terminate the empty slot with the ASUS C-P2T PC100 CPU termination card to maintain signal strength.



ASUS C-P2T PC100 CPU Termination Card

**IMPORTANT:** Use only the ASUS C-P2T PC100 CPU termination card (Rev. 1.02 or later) to terminate the empty slot.

- Secure the SEC Cartridge:** Secure the SEC cartridge in place by pushing the SEC cartridge locks outward so that the lock protrudes through the retention mechanism's lock holes.



Lock protrudes through hole when cartridge is secured

- Connect the Heat Sensor Cable to J1601/J1602:** If you purchased the specially designed Pentium II processor fan with thermal monitor, you may connect the heat sensor cables to the motherboard's CPU heat sensor connectors (J1601/J1602).

**NOTE:** If you are installing only one processor, you may use the free connector to connect a power supply with thermal monitoring.

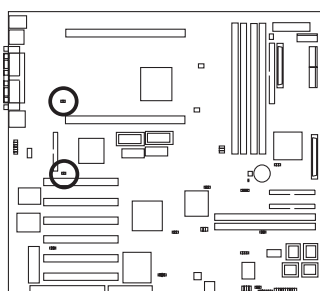

J1601



Heat Sensor Connector for CPU 1

J1602



Heat Sensor Connector for CPU 2

**P2B-D2 CPU Heat Sensor Connectors**

# III. INSTALLATION

## Recommended Heatsinks

The recommended heatsinks for the Pentium II processor are those with three-pin fans that can be connected to the CPU fan connector on the motherboard. These heatsinks have the added benefits of proper heat dissipation and with the LM78 hardware monitor, the ability to monitor the fan's RPM and use the alert function through monitoring programs such as LDCM and ASMM.

**IMPORTANT:** The heatsinks must not be more than 2.8 cm (1.1 inch) thick.



### *AAVID Heatsink*



### *Elan Vital Heatsink*



The procedures for installing the Elan Vital heatsink with fan is also similar to the steps for installing the Aavid heatsink. The Elan Vital heatsink, however, comes with a lever to clamp the heatsink into the SEC cartridge. Mount the heatsink in the orientation as shown then flip the lever from “Unlock” to “Lock.”

# III. INSTALLATION

## 4. Expansion Cards

**WARNING!** Unplug your power supply when adding or removing expansion cards or other system components. Failure to do so may cause severe damage to both your motherboard and expansion cards.

### *Expansion Card Installation Procedure*

1. Read the documentation for your expansion card and make any necessary hardware or software settings for your expansion card, such as jumpers.
2. Remove your computer system's cover and the bracket plate on the slot you intend to use. Keep the bracket for possible future use.
3. Carefully align the card's connectors and press firmly.
4. Secure the card on the slot with the screw you removed above.
5. Replace the computer system's cover.
6. Set up the BIOS if necessary  
(such as *IRQ xx Used By ISA: Yes* in PNP AND PCI SETUP)
7. Install the necessary software drivers for your expansion card.

### *Assigning IRQs for Expansion Cards*

**IMPORTANT:** Interrupt requests are shared as shown by the following table:

	INT-A	INT-B	INT-C	INT-D
PCI slot 1	shared	--	--	--
PCI slot 2	--	shared	--	--
PCI slot 3	--	--	shared	--
Onboard VGA	--	--	shared	--
7890 SCSI	--	shared	--	--
i960 processor	--	--	--	shared
2nd-PCI slot 1	--	--	--	shared
2nd-PCI slot 2	shared	--	--	--
2nd-PCI slot 3	--	shared	--	--
Onboard LAN	--	--	shared	--

If using PCI cards on shared slots, make sure that the drivers support "Share IRQ" or that the cards do not need IRQ assignments. Conflicts will arise between the two PCI groups that will make the system unstable or cards inoperable.

Some expansion cards need to use an IRQ to operate. Generally, an IRQ must be exclusively assigned to one use. In a standard design, there are 16 IRQs available but most of them are already in use, leaving 6 IRQs free for expansion cards. If your motherboard has audio onboard, an extra 3 IRQs will be used, leaving 3 IRQs free.



# III. INSTALLATION

---

Both ISA and PCI expansion cards may require to use IRQs. System IRQs are available to cards installed in the ISA expansion bus first, then any remaining IRQs are available to PCI cards. Currently, there are two types of ISA cards. The original ISA expansion card design, now referred to as legacy ISA cards, requires that you configure the card's jumpers manually and then install it in any available slot on the ISA bus. You may use the Microsoft Diagnostics (MSD.EXE) utility located in the Windows directory to see a map of your used and free IRQs. If you use Windows 95, the **Resources** tab under **Device Manager** displays the resource settings being used by a particular device (to gain access, double-click the **System** icon under the **Control Panel** program). Ensure that no two devices share the same IRQs or your computer will experience problems when those two devices are in use at the same time.

To simplify this process, this motherboard complies with the Plug and Play (PnP) specification, which was developed to allow automatic system configuration whenever a PnP-compliant card is added to the system. For PnP cards, IRQs are assigned automatically from those available.

If the system has both legacy and PnP ISA cards installed, IRQs are assigned to PnP cards from those not used by legacy cards. The PCI and PNP configuration section of the BIOS setup utility can be used to assign which IRQs are being used by legacy cards. For older legacy cards that do not work with the BIOS, you may contact your vendor for an ISA Configuration Utility.

An IRQ number is automatically assigned to PCI expansion cards after those used by legacy and PnP ISA cards. In the PCI bus design, the BIOS automatically assigns an IRQ to a PCI slot that contains a card requiring an IRQ. To install a PCI card, you need to set the INT (interrupt) assignment. Since all the PCI slots on this motherboard use an INTA #, set the jumpers on your PCI cards to INT A.

## *Assigning DMA Channels for ISA Cards*

Some ISA cards, both legacy and PnP, may also need to use a DMA (Direct Memory Access) channel. DMA assignments for this motherboard are handled the same way as the IRQ assignment process described earlier. You can select a DMA channel in the PCI and PnP configuration section of the BIOS Setup utility.

**IMPORTANT:** To avoid conflicts, reserve the necessary IRQs and DMAs for legacy ISA cards (under PNP AND PCI SETUP of the BIOS SOFTWARE, choose *Yes* in *IRQ xx Used By ISA* and *DMA x Used By ISA* for those IRQs and DMAs you want to reserve).

## *ISA Cards and Hardware Monitor*

The onboard hardware monitor uses the address 290H-297H so legacy ISA cards must not use this address or else conflicts will occur.

# III. INSTALLATION

## 5. External Connectors

**WARNING!** Some pins are used for connectors or power sources. Placing jumper caps over these will cause damage to your motherboard.

**IMPORTANT:** Ribbon cables should always be connected with the red stripe on the Pin 1 side of the connector. The four corners of the connectors are labeled on the motherboard. Pin 1 is the side closest to the power connector on hard drives and floppy drives. IDE ribbon cable must be less than 46cm (18in), with the second drive connector no more than 15cm (6in) from the first connector.

### 1. PS/2 Keyboard Connector (6 pin Female)

This connection is for a standard keyboard using an PS/2 plug (mini DIN). **This connector will not allow standard AT size (large DIN) keyboard plugs. You may use a DIN to mini DIN adapter on standard AT keyboards.**

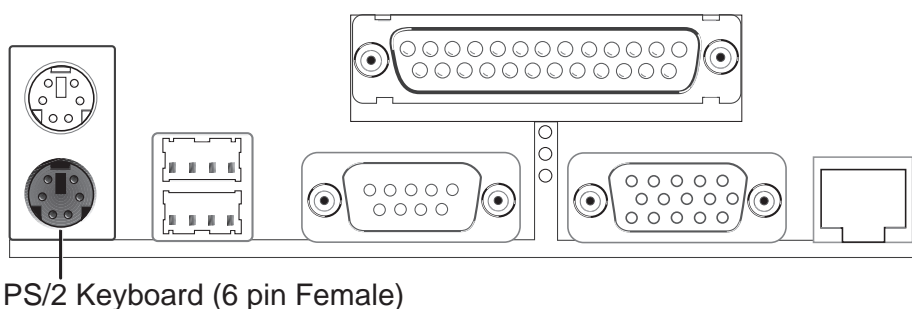

### 2. PS/2 Mouse Connector (6 pin Female)

The system will direct IRQ12 to the PS/2 mouse if one is detected. If not detected, expansion cards can use IRQ12. See “PS/2 Mouse Function Control” in BIOS Features Setup of the BIOS SOFTWARE.

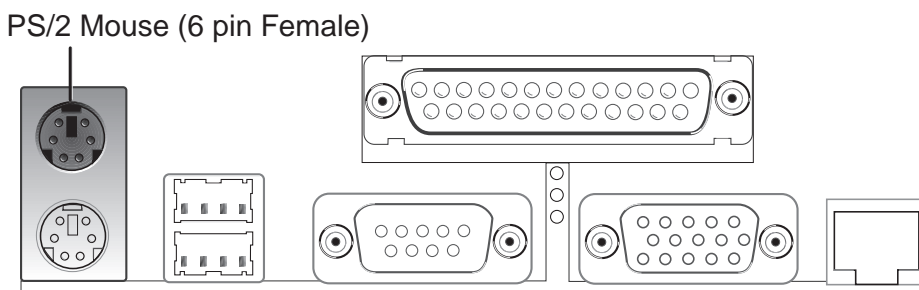

# III. INSTALLATION

## 3. Parallel Printer Connector (25 pin Female)

You can enable the parallel port and choose the IRQ through “Onboard Parallel Port” in Chipset Features Setup of the BIOS SOFTWARE. **NOTE:** Serial printers must be connected to the serial port.

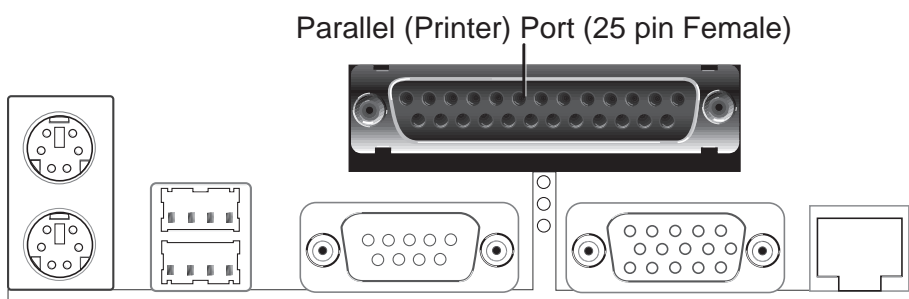

## 4. Serial Port COM1 Connector (9 pin Male)

One serial port is ready for a mouse or other serial devices. A second serial port is available using a serial port bracket connected from the motherboard to an expansion slot opening. See “Onboard Serial Port” in Chipset Features Setup of the BIOS SOFTWARE for settings.

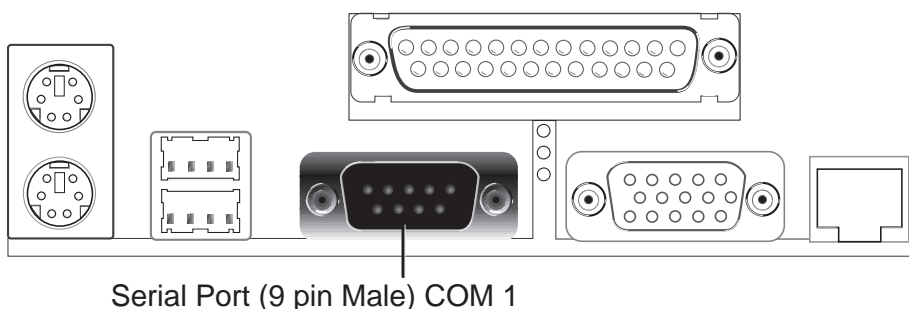

Serial Port (9 pin Male) COM 1

## 5. Monitor (VGA) Output Connector (15 pin Female)

This connector is for output to a VGA-compatible device.

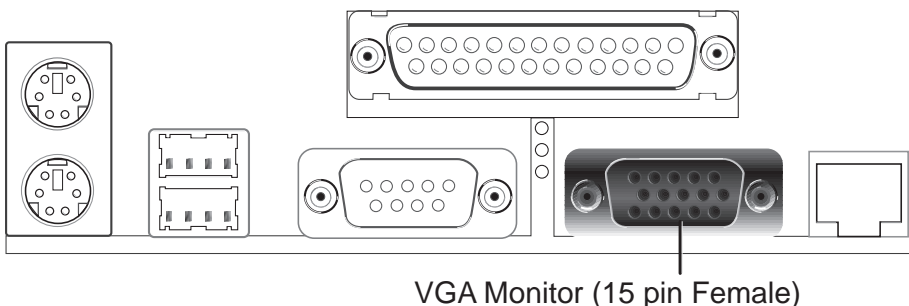

VGA Monitor (15 pin Female)

# III. INSTALLATION

## 6. Universal Serial BUS Connectors 1 & 2 (Two 4 pin Female)

Two USB ports are available for connecting USB devices.

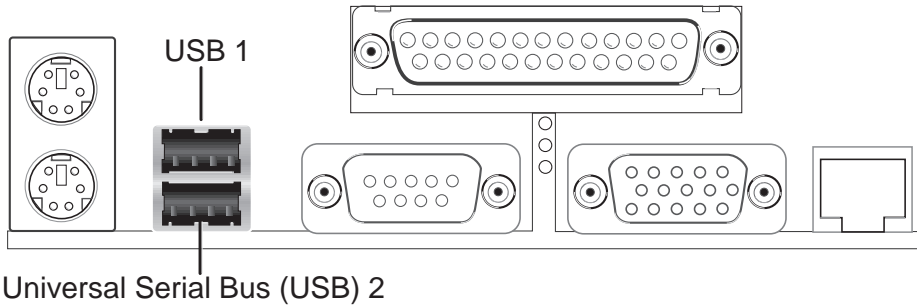

## 7. RJ-45 Connector (8 pin Female)

This connector can be used to connect the onboard 32-bit 10/100 Mbps Ethernet LAN Controller (optional) to a host or a hub.

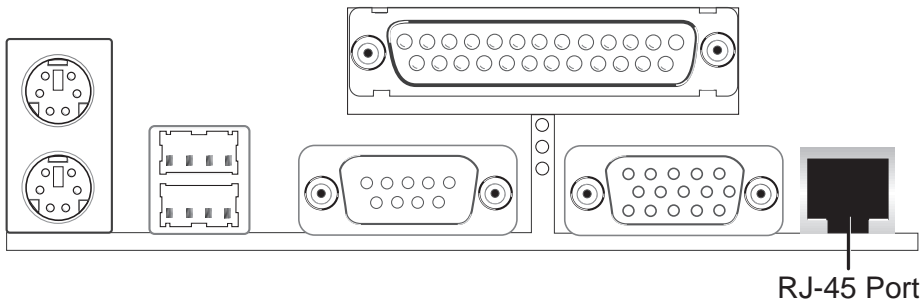

## 8. Hard Disk Activity LED (2 pin IDELED)

This connector supplies power to the cabinet's hard disk or IDE activity LED. Read and write activity by devices connected to the Primary or Secondary IDE connectors will cause the LED to light up.

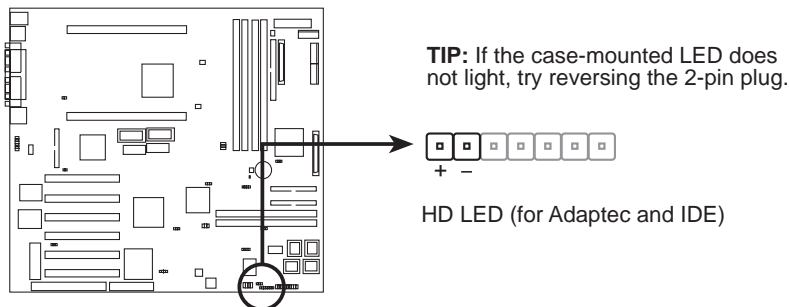

**P2B-D2 IDE Activity LED Lead**

# III. INSTALLATION

## 9. Primary / Secondary IDE Connectors (Two 40-1 pin IDE)

These connectors support the provided IDE hard disk ribbon cable. After connecting the single end to the board, connect the two plugs at the other end to your hard disk(s). If you install two hard disks, you must configure the second drive to Slave mode by setting its jumper accordingly. Please refer to the documentation of your hard disk for the jumper settings. BIOS now supports SCSI device or IDE CD-ROM bootup (see “HDD Sequence SCSI/IDE First” & “Boot Sequence” in the **BIOS Features Setup** of the BIOS SOFTWARE) (**Pin 20 is removed to prevent inserting in the wrong orientation when using ribbon cables with pin 20 plugged**).

**TIP:** You may configure two hard disks to be both Masters using one ribbon cable on the primary IDE connector and another ribbon cable on the secondary IDE connector. You may install one operating system on an IDE drive and another on a SCSI drive and select the boot disk through BIOS Features Setup.

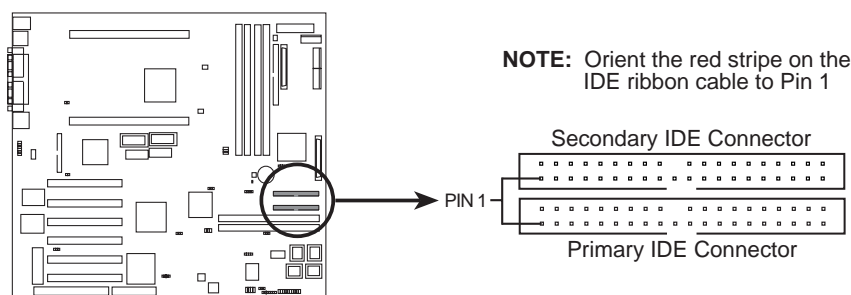

**P2B-D2 IDE Connectors**

## 10. Chassis Intrusion Sensor Lead (CHASSIS)

This lead is for a chassis intrusion monitor or sensor. The sensor is triggered when a high level signal is sent to the “chassis signal” lead. This occurs when a panel switch or light detector is triggered. This function requires optional trigger switches to be installed.

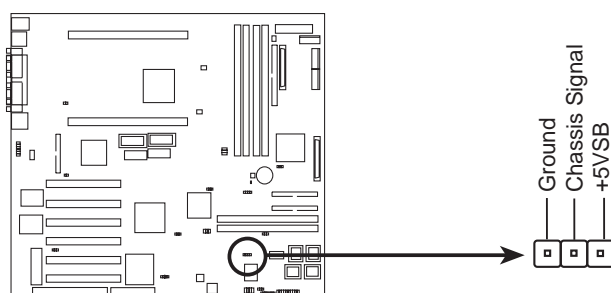

**P2B-D2 Chassis Open Alarm Lead**

# III. INSTALLATION

## 11. IrDA-Compliant infrared module connector (5 pin IR)

This connector supports the optional wireless transmitting and receiving infrared module. This module mounts to a small opening on system cases that support this feature. You must also configure the setting through “UART2 Use Infrared” in **Chipset Features Setup** to select whether UART2 is directed for use with COM2 or IrDA. Use the five pins as shown on the Back View and connect a ribbon cable from the module to the motherboard according to the pin definitions.

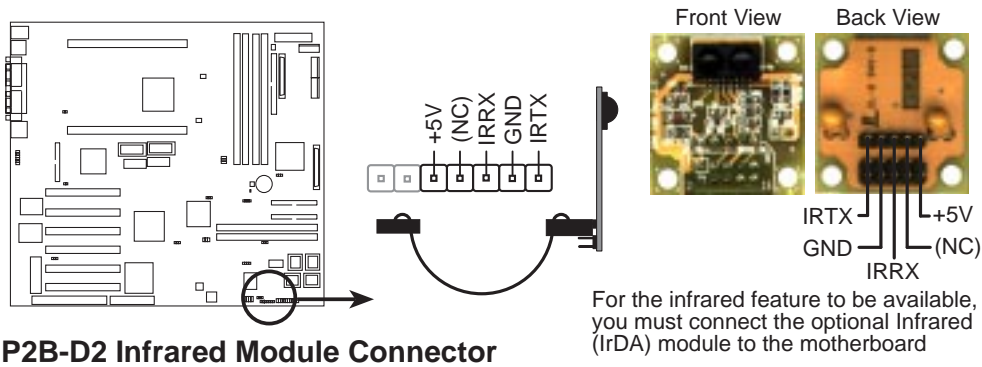

**P2B-D2 Infrared Module Connector**

## 12. Chassis, CPU, & Power Supply Fan Connectors (3 pin FAN)

These connectors support cooling fans of 500mA (6W) or less. Orientate the fans so that the heat sink fins allow airflow to go across the onboard heatsink(s) instead of the expansion slots. Depending on the fan manufacturer, the wiring and plug may be different. The red wire should be positive, while the black should be ground. Connect the fan’s plug to the board taking into consideration the polarity of the this connector.

**NOTE:** The “Rotation” signal must only be used with fans specially designed with rotation signal.

**WARNING!** The CPU and/or motherboard will overheat if there is no airflow across the CPU and onboard heatsinks. Damage may occur to the motherboard and/or the CPU fan if these pins are incorrectly used. **These are not jumpers, do not place jumper caps over these pins.**

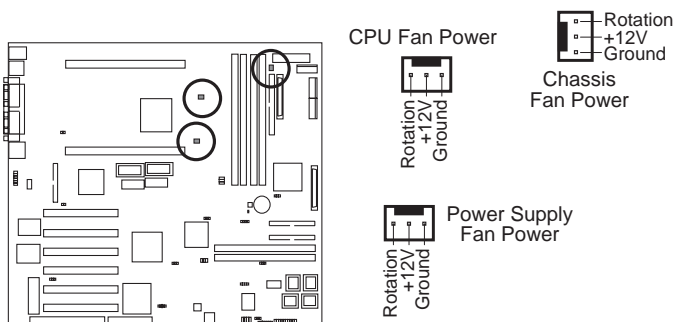

**P2B-D2 12Volt Cooling Fan Power**

**NOTE:** If you are installing two processors, you may connect the fan from the second heatsink to either the power supply or chassis fan connector.

# III. INSTALLATION

## 13. Main and Auxilliary AT Power Connectors (12 pin & 6 pin PWRCON)

This connector connects to a standard 5 Volt power supply. To connect the leads from the power supply, ensure first that the power supply is not plugged into an AC outlet. Most power supplies provide two plugs (P8 and P9), each containing six wires, two of which are black. An auxilliary connector (P10) is provided in case the power supplied through the main connectors are insufficient. Orient the main connectors so that the black wires are located in the middle.

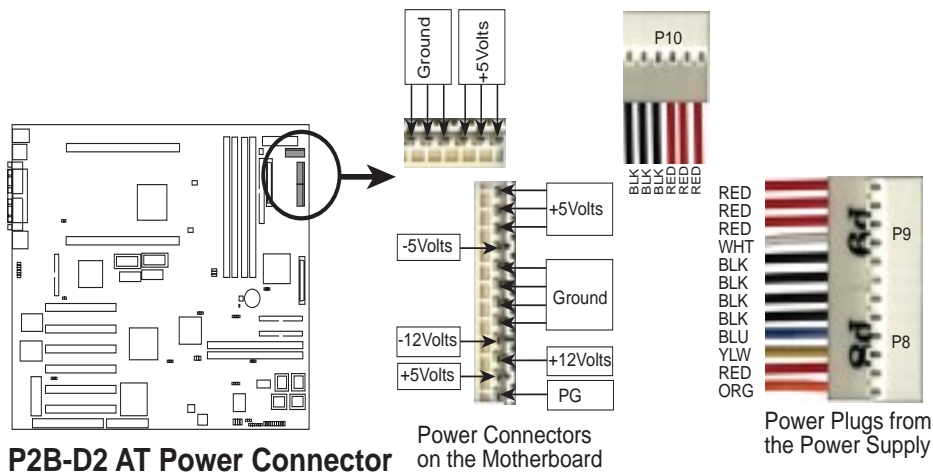

**P2B-D2 AT Power Connector**

Power Connectors on the Motherboard

Power Plugs from the Power Supply

Using a slight angle, align the plastic guide pins on the lead to their receptacles on the connector. Once aligned, press the lead onto the connector until the lead locks into place.

## 14. ATX Power Supply Connector (20 pin ATXPWR)

This connector connects to an ATX power supply. The plug from the power supply will only insert in one orientation because of the different hole sizes. Find the proper orientation and push down firmly but gently making sure that the pins are aligned.

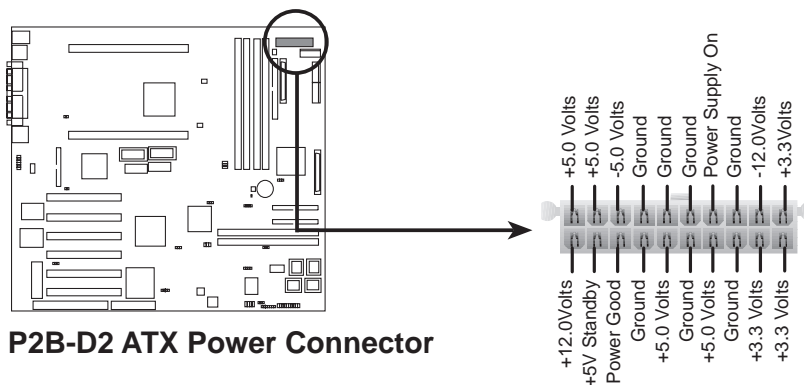

**P2B-D2 ATX Power Connector**

**IMPORTANT:** Make sure that your ATX power supply can supply at least 10mA on the 5-volt standby lead (+5VSB). You may experience difficulty in powering on your system if your power supply cannot support the load. For Wake on LAN support, your ATX power supply must supply at least 720mA.

# III. INSTALLATION

## 15. LED Lead (MSG.LED)

This indicates whether a message has been received from a fax/modem. The LED will remain lit when there is no signal and blink when there is data transfer or waiting in the inbox. This function requires ACPI OS and driver support.

## 16. System Management Interrupt Lead (SMI)

This allows the user to manually place the system into a suspend mode or “Green” mode where system activity is decreased to save electricity and expand the life of certain components when the system is not in use. This 2-pin connector connects to the case-mounted suspend switch. If you do not have a switch for the connector, you may use the “Turbo Switch”. SMI is activated when it detects a *short to open* moment and therefore leaving it shorted will not cause any problems. This may require one or two presses depending on the position of the switch. Wake-up can be controlled by settings in the BIOS but the keyboard will always allow wake-up (the SMI lead cannot wake up the system). If you want to use this connector, set “Suspend Mode” under the **Power Management Setup** of the BIOS SOFTWARE section to the preferred time after which the system must go into suspend mode when you press the switch.

## 17. ATX Power Switch / Soft Power Switch (PWR.SW)

The system power is controlled by a momentary switch connected to this lead. Pressing the button once will switch the system between ON and SLEEP or ON and SOFT OFF depending on the “PWR Button” setting under the **Power Management Setup** of the BIOS SOFTWARE section. Pressing the switch while in the ON mode for more than 4 seconds will turn the system off. The system power LED shows the status of the system’s power.

## 18. Reset Switch Lead (RESET)

This 2-pin connector connects to the case-mounted reset switch for rebooting your computer without having to turn off your power switch. This is a preferred method of rebooting to prolong the life of the system’s power supply.

## 19. System Power LED (PWR.LED)

This 3-pin connector connects the system power LED, which lights when the system is powered on and blinks when it is in sleep mode.

## 20. Keyboard Lock Switch Lead (KEY LOCK)

This 2-pin connector connects to the case-mounted key switch to allow keyboard locking.

## 21. Speaker Connector (SPEAKER)

This 4-pin connector connects to the case-mounted speaker.

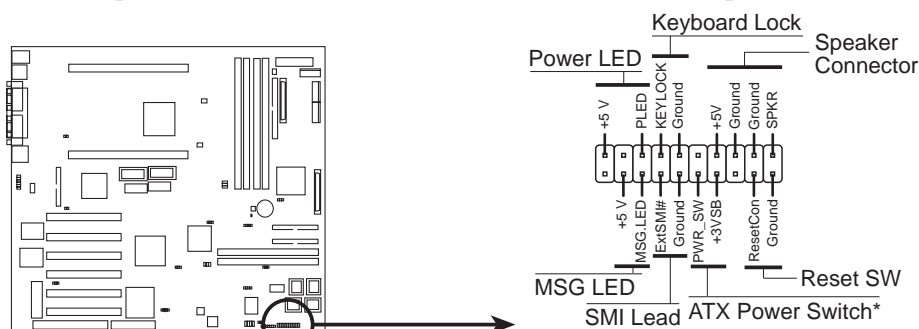

P2B-D2 System Panel Connections

\* Requires an ATX power supply.



# III. INSTALLATION

## 22. 50 pin Narrow/68 pin Wide/68 pin Ultra2 SCSI Connectors

This motherboard has onboard 50-Pin Narrow SCSI connector for 8-bit SCSI devices, 68-Pin Wide SCSI connector for 16-bit SCSI devices, and 68-Pin Ultra2 SCSI connector for 16-bit differential SCSI devices.

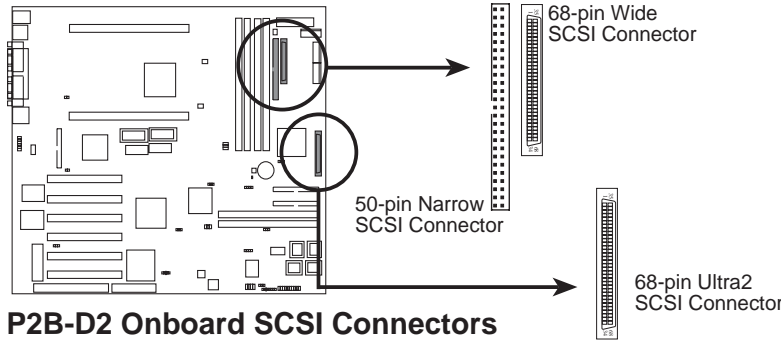

**NOTE:** A maximum of 15 devices can be connected using any combination of 50-pin Narrow SCSI, 68-pin Wide SCSI, and 68-pin Ultra2 SCSI devices.

The onboard Adaptec AIC-7890AB chipset incorporates an advanced multimode I/O cell that supports both single-ended (SE) and Ultra2 devices. With Ultra2 devices, the SCSI bus platform performs at full Ultra2 speeds (up to 40 MB/sec in 8-bit mode and up to 80 MB/sec in 16-bit mode) and extended cabling 12m (or 25m in a point-to-point configuration). When an SE device is attached, the bus defaults to an SE speed and cable length.

In mixed environments of Ultra2 and SE devices, the onboard host adapter can be coupled with the Adaptec AIC-3860 transceiver chipset to bridge the compatibility gap. By dividing the SCSI bus into independent SE and low voltage differential (LVD) segments, the transceiver chipset supports legacy devices without limiting performance and cable length on the LVD segment.

**IMPORTANT:** Connect SCSI devices as shown. Mixing SCSI devices will lower performance.

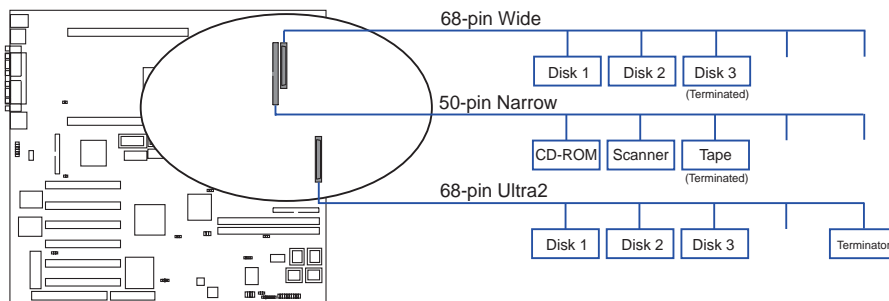

**P2B-D2 SCSI Connection**

**NOTE:** Ultra2 devices do not have termination jumpers and must use a separate terminator on the last connector.

# III. INSTALLATION

## 23. SB-Link™ Connector (6-1 pin SBLINK)

Using Intel's PC-PCI and serialized IRQ protocols found in this motherboard's AGPset, this connector allows Sound Blaster 16 compatibility to AWE64D (Digital) or other PCI audio cards, enabling users to play Real-mode DOS games and multimedia applications. SB-Link acts as a bridge between the motherboard and the PCI audio card by providing the DMA and IRQ signals present in the ISA bus but not available on the PCI bus.

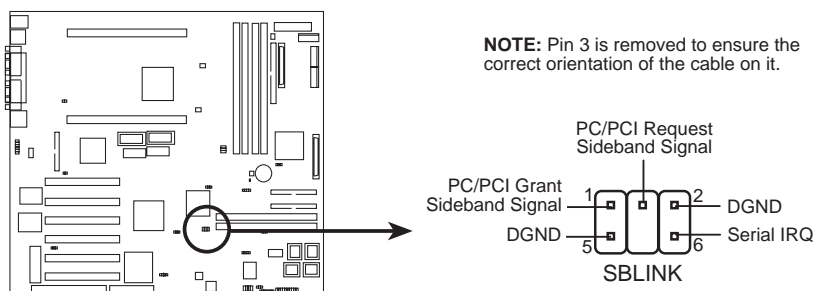

**NOTE:** Pin 3 is removed to ensure the correct orientation of the cable on it.

**P2B-D2 SB-Link™ Connector**

## 24. Floppy Disk Drive Connector (34-1pin FLOPPY)

This connector supports the provided floppy disk drive ribbon cable. After connecting the single end to the board, connect the two plugs on the other end to the floppy drives. **(Pin 5 is removed to prevent inserting in the wrong orientation when using ribbon cables with pin 5 plugged).**

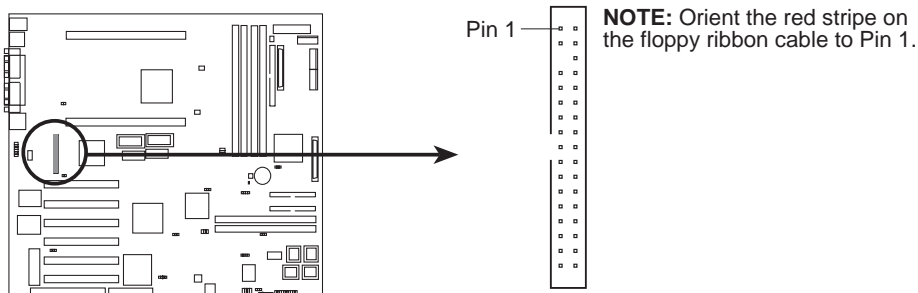

**NOTE:** Orient the red stripe on the floppy ribbon cable to Pin 1.

**P2B-D2 Floppy Disk Drive Connector**

## 25. Serial Port COM 2 (COM2, 10-1 pins)

The serial port bracket can be used to add an additional serial port for additional serial devices.

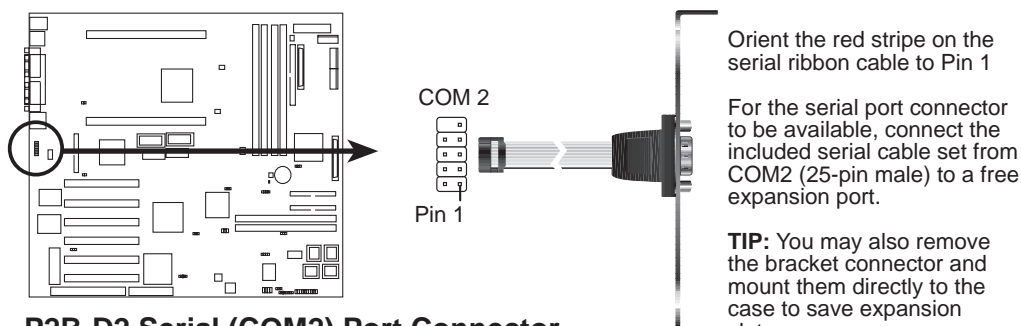

Orient the red stripe on the serial ribbon cable to Pin 1

For the serial port connector to be available, connect the included serial cable set from COM2 (25-pin male) to a free expansion port.

**TIP:** You may also remove the bracket connector and mount them directly to the case to save expansion slot space.

**P2B-D2 Serial (COM2) Port Connector**

# III. INSTALLATION

## 26. VGA Memory Upgrade Sockets

This motherboard comes with 1MB VGA memory onboard. Two sockets are provided to upgrade the VGA memory to 2MB by adding two EDO DRAMs.

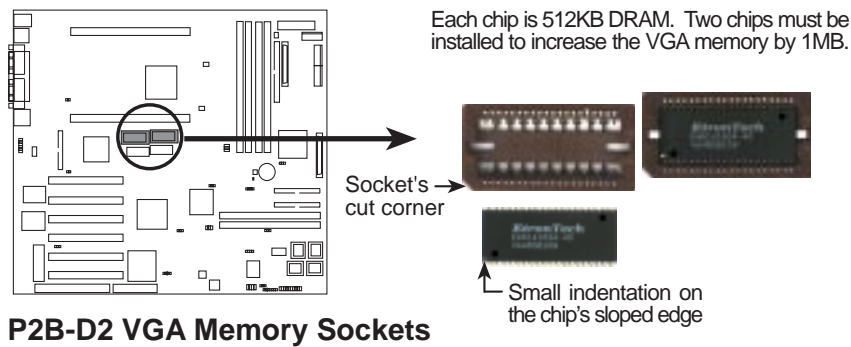

**NOTE:** The indentations are shown white for visibility, they are normally black.

Match the small indentation on the chip's sloped edge with the socket's cut corner. Place the chip flat and evenly into the socket and press firmly but carefully so that the chip enters evenly. When installed, the chip should be flush with the socket.

# III. INSTALLATION

---

(This page was intentionally left blank.)



# III. INSTALLATION

---

## Power Connection Procedures

1. After all connections are made, close the system case cover.
  2. Be sure that all switches are off (in some systems, marked with ○).
  3. Connect the power supply cord into the power supply located on the back of your system case according to your system user's manual.
  4. Connect the power cord into a power outlet that is equipped with a surge protector.
  5. You may then turn on your devices in the following order:
    - a. Your monitor
    - b. External SCSI devices (starting with the last device on the chain)
    - c. Your system power. For ATX power supplies, you need to switch on the power supply as well as press the ATX power switch on the front of the case.
  6. The power LED on the front panel of the system case will light. For ATX power supplies, the system LED will light when the ATX power switch is pressed. The monitor LED may light up after the system's if it complies with "green" standards or if it has a power standby feature. The system will then run power-on tests. While the tests are running, additional messages will appear on the screen. If you do not see anything within 30 seconds from the time you turn on the power, the system may have failed a power-on test. Recheck your jumper settings and connections or call your retailer for assistance.
  7. During power-on, hold down <Delete> to enter BIOS setup. Follow the instructions in the next section, BIOS SOFTWARE.
- \* **Powering Off your computer:** You must first exit or shut down your operating system before switching off the power switch. For ATX power supplies, you can press the ATX power switch after exiting or shutting down your operating system. If you use Windows 95, click the **Start** button, click **Shut Down**, and then click **Shut down the computer?**. The system will then power off after Windows shuts down.

**NOTE:** The message "You can now safely turn off your computer" will not appear when shutting down with ATX power supplies.

# IV. BIOS SOFTWARE

## Flash Memory Writer Utility

**AFLASH.EXE:** This is the Flash Memory Writer utility that updates the BIOS by uploading a new BIOS file to the programmable flash ROM chip on the motherboard. To determine the BIOS version of your motherboard, check the last four numbers of the code displayed on the upper left-hand corner of your screen during bootup. Larger numbers represent a newer BIOS file. This file works only in DOS mode.

**NOTE:** The following screen displays are provided as examples only and may not reflect the screen contents displayed on your system.

```
ASUS ACPI BIOS
FLASH MEMORY WRITER V1.0
Copyright (C) 1994-98, ASUSTek COMPUTER INC.

Flash Memory: ATMEL AT29CB100

Current BIOS Version: ASUS P2E-M ACPI BIOS Revision 1002
Chipset and Model   : I44BX-P2E-M
BIOS Built Date    : 04/21/98

Choose one of the followings:

1. Save Current BIOS To File
2. Update BIOS Including Boot Block and ESCD

Enter choice: [1]

Press ESC To Exit
```

**IMPORTANT!** If “unknown” is displayed after **Flash Memory:**, the memory chip is either not programmable or is not supported by the ACPI BIOS and therefore, cannot be programmed by the Flash Memory Writer utility.

### Main Menu

#### 1. Save Current BIOS To File

This option allows you to save a copy of the original motherboard BIOS in case you need to reinstall it. It is recommended that you save **AFLASH.EXE** and the BIOS file to a bootable floppy disk.

To save your current BIOS, type [1] at the **Main Menu** and then press <Enter>. The **Save Current BIOS To File** screen appears. Type a filename and the path, for example, **A:\XXXXX-X** and then press <Enter>.

```
Save Current BIOS To File

Flash Memory: ATMEL AT29CB100

Current BIOS Version: ASUS P2E-M ACPI BIOS Revision 1002
Chipset and Model   : I44BX-P2E-M
BIOS Built Date    : 04/21/98

Please Enter File Name to Save: A:\44BX-1
```

# IV. BIOS SOFTWARE

## 2. Update BIOS Including Boot Block and ESCD

This option updates the boot block, the baseboard BIOS, and the ACPI extended system configuration data (ESCD) parameter block from a new BIOS file. See the next page for procedures on downloading an updated BIOS file.

To update your current BIOS, type [2] at the **Main Menu** and then press <Enter>. The **Update BIOS Including Boot Block and ESCD** screen appears. Type the filename of your new BIOS and the path, for example, **A:\XXXXX.AWD**, and then press <Enter>.

When prompted to confirm the BIOS update, press **Y** to start the update.

The utility starts to program the new BIOS information into the flash ROM. When the programming is finished, *Flashed Successfully* will be displayed.

Follow the onscreen instructions to continue.

```
Update BIOS Including Boot Block and ESCD
Flash Memory: ATMEL AT29CB10A
Current BIOS Version: ASUS P2E-M ACPI BIOS Revision 18B2
Chipset and Model : I44BEX-P2E-M
BIOS Built Date : 04/21/98
Please Enter File Name for NEW BIOS: 18B2EM.886
```

```
Update BIOS Including Boot Block and ESCD
Flash Memory: ATMEL AT29CB10A
BIOS Version
[ CURRENT ] ASUS P2E-M ACPI BIOS Revision 18B2
[ 18B2EM.886 ] ASUS P2E-M ACPI BIOS Revision 18B2
Chipset and Model
[ CURRENT ] I44BEX-P2E-M
[ 18B2EM.886 ] I44BEX-P2E-M
Date of BIOS Built
[ CURRENT ] 04/21/98
[ 18B2EM.886 ] 04/27/98
Are you sure (Y/N) ? [Y]
Press ESC To Return to Main Menu
```

```
Update BIOS Including Boot Block and ESCD
Flash Memory: ATMEL AT29CB10A
BIOS Version
[ CURRENT ] ASUS P2E-M ACPI BIOS Revision 18B2
[ 18B2EM.886 ] ASUS P2E-M ACPI BIOS Revision 18B2
Chipset and Model
[ CURRENT ] I44BEX-P2E-M
[ 18B2EM.886 ] I44BEX-P2E-M
Date of BIOS Built
[ CURRENT ] 04/21/98
[ 18B2EM.886 ] 04/27/98
Programming -- 1FFFF
Flashed Successfully
Press ESC To Continue
```

```
ASUS ACPI BIOS
FLASH MEMORY WRITER V1.8
Copyright (C) 1994-98, ASUSTek COMPUTER INC.
Flash Memory: ATMEL AT29CB10A
Current BIOS Version: ASUS P2E-M ACPI BIOS Revision 18B2
Chipset and Model : I44BEX-P2E-M
BIOS Built Date : 04/21/98
Choose one of the followings:
1. Save Current BIOS To File
2. Update BIOS Including Boot Block and ESCD
Enter choice: [1]
You have flashed the EPROM:It is recommended that you turn off
the power, enter SETUP and LOAD Setup Defaults to have CMOS
updated with new BIOS when exits.
Press ESC To Exit
```

## IV. BIOS SOFTWARE

---

### Managing and Updating Your Motherboard's BIOS

#### Upon First Use of the Computer System

1. Create a bootable system floppy disk by typing [FORMAT A:/S] from the DOS prompt without creating "AUTOEXEC.BAT" and "CONFIG.SYS" files.
2. Copy AFLASH.EXE to the just created boot disk.
3. Run AFLASH.EXE from this new disk and select option **1. Save Current BIOS to File**. See **1. Save Current BIOS To File** on the previous page for more details and the rest of the steps.

#### Updating BIOS Procedures (only when necessary)

1. Download an updated ASUS BIOS file from the Internet (WWW or FTP) or a BBS (Bulletin Board Service) (see ASUS CONTACT INFORMATION on page 3 for details) and save to the disk you created earlier.
2. Boot from the disk you created earlier.
3. At the "A:\>" prompt, type **AFLASH** and then press <Enter>.
4. At the **Main Menu**, type **2** and then press <Enter>. See **2. Update BIOS Including Boot Block and ESCD** on the previous page for more details and the rest of the steps.

**WARNING!** If you encounter problems while updating the new BIOS, DO NOT turn off your system since this might prevent your system from booting up. Just repeat the process, and if the problem still persists, update the original BIOS file you saved to disk above. If the Flash Memory Writer utility was not able to successfully update a complete BIOS file, your system may not be able to boot up. If this happens, your system will need service.



# IV. BIOS SOFTWARE

## 6. BIOS Setup

The motherboard supports two programmable Flash ROM chips: 5-Volt and 12-Volt. Either of these memory chips can be updated when BIOS upgrades are released. Use the Flash Memory Writer utility to download the new BIOS file into the ROM chip as described in detail in this section.

All computer motherboards provide a Setup utility program for specifying the system configuration and settings. If your motherboard came in a computer system, the proper configuration entries may have already been made. If so, invoke the Setup utility, as described later, and take note of the configuration settings for future reference; in particular, the hard disk specifications.

If you are installing the motherboard, reconfiguring your system or you receive a Run Setup message, you will need to enter new setup information. This section describes how to configure your system using this utility.

The BIOS ROM of the system stores the Setup utility. When you turn on the computer, the system provides you with the opportunity to run this program. This appears during the Power-On Self Test (POST). Press <Delete> to call up the Setup utility. If you are a little bit late pressing the mentioned key(s), POST will continue with its test routines, thus preventing you from calling up Setup. If you still need to call Setup, reset the system by pressing <Ctrl> + <Alt> + <Delete>, or by pressing the Reset button on the system case. You can also restart by turning the system off and then back on again. But do so only if the first two methods fail.

When you invoke Setup, the CMOS SETUP UTILITY main program screen will appear with the following options:



# IV. BIOS SOFTWARE

## Load Defaults

The “Load BIOS Defaults” option loads the minimum settings for troubleshooting. “**Load Setup Defaults**”, on the other hand, is for loading optimized defaults for regular use. Choosing defaults at this level, will modify all applicable settings.

A section at the bottom of the above screen displays the control keys for this screen. Take note of these keys and their respective uses. Another section just below the control keys section displays information on the currently highlighted item in the list.

## Standard CMOS Setup

The “Standard CMOS Setup” option allows you to record some basic system hardware configuration and set the system clock and error handling. If the motherboard is already installed in a working system, you will not need to select this option anymore. However, if the configuration stored in the CMOS memory on the board gets lost or damaged, or if you change your system hardware configuration, you will need to respecify the configuration values. The configuration values usually get lost or corrupted when the power of the onboard CMOS battery weakens.



The preceding screen provides you with a list of options. At the bottom of this screen are the control keys for this screen. Take note of these keys and their respective uses.

User-configurable fields appear in a different color. If you need information on the selected field, press <F1>. The help menu will then appear to provide you with the information you need. The memory display at the lower right-hand side of the screen is read-only and automatically adjusts accordingly.

### Details of Standard CMOS Setup:

#### Date

To set the date, highlight the “Date” field and then press either <Page Up>/<Page Down> or <+>/<-> to set the current date. Follow the month, day and year format. Valid values for month, day and year are: **Month: (1 to 12), Day: (1 to 31), Year: (up to 2079)**

## IV. BIOS SOFTWARE

---

### Time

To set the time, highlight the “Time” field and then press either <Page Up>/<Page Down> or <+>/<-> to set the current time. Follow the hour, minute and second format. Valid values for hour, minute and second are: (**Hour: (00 to 23)**, **Minute: (00 to 59)**, **Second: (00 to 59)**).

**NOTE:** You can bypass the date and time prompts by creating an AUTOEXEC.BAT file. For information on how to create this file, please refer to the MS-DOS manual.

### Hard Disks

This field records the specifications for all non-SCSI hard disk drives installed in your system. The onboard PCI IDE connectors provide Primary and Secondary channels for connecting up to four IDE hard disks or other IDE devices. Each channel can support up to two hard disks; the first of which is the “master” and the second is the “slave”.

Specifications for SCSI hard disks need not to be entered here since they operate using device drivers and are not supported by the BIOS. If you install other SCSI controller cards, refer to their respective documentations on how to install the required SCSI drivers.

#### For IDE hard disk drive setup, you can:

- Use the *Auto* setting for detection during bootup.
- Use the IDE HDD AUTO DETECTION in the main menu to automatically enter the drive specifications.
- Enter the specifications yourself manually by using the “User” option.

The entries for specifying the hard disk type include **CYLS** (number of cylinders), **HEAD** (number of read/write heads), **PRECOMP** (write precompensation), **LANDZ** (landing zone), **SECTOR** (number of sectors) and **MODE**. The **SIZE** field automatically adjusts according to the configuration you specify. The documentation that comes with your hard disk should provide you with the information regarding the drive specifications.

The **MODE** entry is for IDE hard disks only, and can be ignored for MFM and ESDI drives. This entry provides three options: *Normal*, *Large*, *LBA*, or *Auto* (see below). Set **MODE** to the *Normal* for IDE hard disk drives smaller than 528MB; set it to *LBA* for drives over 528MB that support Logical Block Addressing (LBA) to allow larger IDE hard disks; set it to *Large* for drives over 528MB that do not support LBA. *Large* type of drive can only be used with MS-DOS and is very uncommon. Most IDE drives over 528MB support the *LBA* mode.

## IV. BIOS SOFTWARE

---

### **Auto detection of hard disks on bootup**

For each field: Primary Master, Primary Slave, Secondary Master, and Secondary Slave, you can select *Auto* under the TYPE and MODE fields. This will enable auto detection of your IDE hard disk during bootup. This will allow you to change your hard disks (with the power off) and then power on without having to reconfigure your hard disk type. If you use older hard disks that do not support this feature, then you must configure the hard disk in the standard method as described earlier by the “User” option.

**NOTE:** After the IDE hard disk drive information has been entered into BIOS, new IDE hard disk drives must be partitioned (such as with FDISK) and then formatted before data can be read from and write on. Primary IDE hard disk drives must have its partition set to *active* (also possible with FDISK).

**NOTE:** SETUP Defaults are noted in parenthesis next to each function heading.

### **Drive A / Drive B (None)**

These fields record the types of floppy disk drives installed in your system. The available options for drives A and B are: *360K, 5.25 in.; 1.2M, 5.25 in.; 720K, 3.5 in.; 1.44M, 3.5 in.; 2.88M, 3.5 in.; None*

To enter the configuration value for a particular drive, highlight its corresponding field and then select the drive type using the left- or right-arrow keys.

### **Floppy 3 Mode Support (Disabled)**

This is the Japanese standard floppy drive. The standard stores 1.2MB in a 3.5inch diskette. This is normally disabled but you may choose from either: *Drive A, Drive B, Both, and Disabled*

### **Video (EGA/VGA)**

Set this field to the type of video display card installed in your system. The options are *EGA/VGA, CGA 40, CGA 80, and MONO* (for Hercules or MDA).

If you are using a VGA or any higher resolution card, choose *EGA/VGA*.

### **Halt On (All Errors)**

This field determines which types of errors will cause the system to halt. Choose from *All Errors; No Errors; All,But Keyboard, All,But Diskette; and All,But Disk/Key*.

# IV. BIOS SOFTWARE

## BIOS Features Setup

The “BIOS Features Setup” option consists of configuration entries that allow you to improve your system performance, or let you set up some system features according to your preference. Some entries are required by the motherboard’s design to remain in their default settings.



A section at the lower right of the screen displays the control keys you can use. Take note of these keys and their respective uses. If you need information on a particular entry, highlight it and then press <F1>. A pop-up help menu will appear to provide you with the information you need. <F5> loads the last set values, <F6> and <F7> loads the BIOS default values and Setup default values, respectively.

**NOTE:** SETUP Defaults are noted in parenthesis next to each function heading.

### Details of BIOS Features Setup

#### CPU Internal Core Speed

This function is reserved for future use and is currently disabled.

#### Boot Virus Detection (Enabled)

This field allows you to set boot virus detection, ensuring a virus-free boot sector. This new antivirus solution is unlike native BIOS tools, which offer limited virus protection typically by write-protecting the partition table. With this new solution, your computer is protected against boot virus threats earlier in the boot cycle, that is, before they have a chance to load into your system. This ensures your computer boots to a clean operating system. The system halts and displays a warning message when it detects a virus. If this occurs, you can either allow the operation to continue or use a virus-free bootable floppy disk to restart and investigate your system. Because of conflicts with new operating systems, for example, during installation of new software, you may have to set this to *Disabled* to prevent write errors.

## IV. BIOS SOFTWARE

---

### **CPU Level 1 Cache / CPU Level 2 Cache (Enabled)**

These fields allow you to choose from the default of *Enabled* or choose *Disabled* to turn on or off the CPU's Level 1 and Level 2 built-in cache.

### **CPU Level 2 Cache ECC Check (Disabled)**

This function controls the ECC check capability in the CPU level 2 cache.

### **BIOS Update (Enabled)**

This functions as an update loader integrated into the BIOS to supply the processor with the required data. The BIOS will load the update on all processors during system bootup in the default position of *Enabled*.

### **Turbo Mode (Disabled)**

Leave on default setting for best performance.

### **Quick Power On Self Test (Enabled)**

This field speeds up the Power-On Self Test (POST) routine by skipping retesting a second, third, and fourth time. Setup default setting for this field is *Enabled*. A complete test of the system is done on each test.

### **HDD Sequence SCSI/IDE First (IDE)**

When using both SCSI and IDE hard disk drives, IDE is always the boot disk using drive letter C (default setting of *IDE*). This new feature allows a SCSI hard disk drive to be the boot disk when set to *SCSI*. This allows multiple operating systems to be used on both IDE and SCSI drives or the primary operating system to boot using a SCSI hard disk drive.

### **Boot Sequence (A,C)**

This field determines where the system looks first for an operating system. Options are *A,C; C,A; A,CDROM,C; CDROM,C,A; D,A; E,A; F,A; C only; LS/ZIP, C; LAN, A, C; and LAN, C, A*. The setup default setting, *A, C*, is to check first the floppy disk and then the hard disk drive.

### **Boot Up Floppy Seek (Disabled)**

When enabled, the BIOS will seek drive A once.

### **Floppy Disk Access Control (R/W)**

This allows protection of files from the computer system to be copied to floppy disks by allowing the setting of *Read Only* to only allow reads from the floppy disk drive but not writes. The setup default *R/W* allows both reads and writes.

### **IDE HDD Block Mode Sectors (HDD MAX)**

This field enhances hard disk performance by making multi-sector transfers instead of one sector per transfer. Most IDE drives, except older versions, can utilize this feature. Selections are *HDD MAX, Disabled, 2, 4, 8, 16, and 32*.

### **HDD S.M.A.R.T. capability (Disabled)**

This allows the enabling or disabling of the S.M.A.R.T. (Self-Monitoring, Analysis and Reporting Technology) system which utilizes internal hard disk drive monitoring technology. This feature is normally disabled because system resources used in this feature may decrease system performance.

## IV. BIOS SOFTWARE

---

### **PS/2 Mouse Function Control (Auto)**

The default of *Auto* allows the system to detect a PS/2 mouse on bootup. If detected, IRQ12 will be used for the PS/2 mouse. IRQ12 will be reserved for expansion cards if a PS/2 mouse is not detected. *Enabled* will always reserve IRQ12, whether on bootup a PS/2 mouse is detected or not.

### **OS/2 Onboard Memory > 64M (Disabled)**

When using OS/2 operating systems with installed DRAM of greater than 64MB, you need to set this option to *Enabled* otherwise leave this on *Disabled*.

### **MPS 1.4 Support (Disabled)**

Leave on default setting for best performance.

.....

### **PCI/VGA Palette Snoop (Disabled)**

Some display cards that are nonstandard VGA such as graphics accelerators or MPEG Video Cards may not show colors properly. The setting *Enabled* should correct this problem. Otherwise leave this on the setup default setting of *Disabled*.

### **Video ROM BIOS Shadow (Enabled)**

This field allows you to change the video BIOS location from ROM to RAM. Relocating to RAM enhances system performance, as information access is faster than the ROM.

### **C8000-CBFFF to DC000-DFFFF (Disabled)**

These fields are used for shadowing other expansion card ROMs. If you install other expansion cards with ROMs on them, you will need to know which addresses the ROMs use to shadow them specifically. Shadowing a ROM reduces the memory available between 640K and 1024K by the amount used for this purpose.

### **Boot Up NumLock Status (On)**

This field allows users to activate the Number Lock function upon system boot.

### **Typematic Rate Setting (Disabled)**

When enabled, you can set the two typematic controls listed next. Setup default setting is *Disabled*.

#### **Typematic Rate (Chars/Sec) (6)**

This field controls the speed at which the system registers repeated keystrokes. Options range from 6 to 30 characters per second. Setup default setting is **6**; other settings are 8, 10, 12, 15, 20, 24, and 30.

#### **Typematic Delay (Msec) (250)**

This field sets the time interval for displaying the first and second characters. Four delay rate options are available: 250, 500, 750, and 1000.

### **Security Option (System)**

When you specify a *Supervisor Password* and/or *User Password* (explained later in this section), the Security Option field determines when the system prompts for the password. *System* prompts for the User Password every time you start your system. *Setup* prompts for the Supervisor Password only when entering the BIOS Setup utility.

# IV. BIOS SOFTWARE

## Chipset Features Setup

The “Chipset Features Setup” option controls the configuration of the board’s chipset.



**NOTE:** SETUP Defaults are noted in parenthesis next to each function heading.

### Details of Chipset Features Setup

#### SDRAM Configuration (By SPD)

This sets the optimal timings of settings for items 2–5, depending on the memory modules that you are using. Default setting is *By SPD*, which configures items 2–5 by reading the contents in the SPD (Serial Presence Detect) device. This 8-pin serial EEPROM device stores critical parameter information about the module, such as memory type, size, speed, voltage interface, and module banks.

#### SDRAM CAS Latency

This controls the latency between SDRAM read command and the time that the data actually becomes available. Leave on default setting.

#### SDRAM RAS to CAS Delay

This controls the latency between SDRAM active command and the read/write command. Leave on default setting.

#### SDRAM RAS Precharge Time

This controls the idle clocks after issuing a precharge command to SDRAM. Leave on default setting.

#### DRAM Idle Timer

This controls the idle clocks before closing an opened SDRAM page. Leave on default setting.

#### SDRAM MA Wait State (Normal)

This controls the leadoff clocks for CPU read cycles. Leave on default setting.

#### Snoop Ahead (Enabled)

*Enabled* will allow PCI streaming. Leave on default setting.

#### Host Bus Fast Data Ready (Disabled)

Leave on default setting.



# IV. BIOS SOFTWARE

**16-bit I/O Recovery Time (1 BUSCLK) / 8-bit I/O Recovery Time (1 BUSCLK)**  
Timing for 16-bit and 8-bit ISA cards, respectively. Leave on default setting.

## Graphics Aperture Size (64MB)

Memory-mapped, graphics data structures can reside in a Graphics Aperture. Leave on default setting.

## Video Memory Cache Mode (UC)

USWC (uncacheable, speculative write combining) is a new cache technology for the video memory of the processor. It can greatly improve the display speed by caching the display data. You must leave this on the default setting of UC (uncacheable) if your display card cannot support this feature, otherwise your system may not boot.

## PCI 2.1 Support (Enabled)

This function allows you to enable or disable PCI 2.1 features including passive release and delayed transaction. Leave *Enabled* (default setting) for PCI 2.1 compliancy.

## Memory Hole At 15M–16M (Disabled)

Enabling this feature reserves 15MB to 16MB memory address space to ISA expansion cards that specifically require this setting. This makes the memory from 15MB and up unavailable to the system. Expansion cards can only access memory up to 16MB. The default is *Disabled*.

## DRAM are xx bits wide

If all your DIMMs have ECC (e.g., 8 chips + 1 ECC chip), they are considered 72bits and the following will be displayed:

```
DRIM are 72 bits wide      ESC - Quit          F1+- - Select Item
Data Integrity Mode      : ECC    F1 - Help          PU/PD/+/- - Modify
                               F5 - Old Values   (Shift)F2 - Color
                               F6 - Load BIOS  Defaults
                               F7 - Load Setup Defaults
```

If your DIMMs do not have ECC (e.g., 8 chips), they are considered 64 bits and the following will be displayed instead:

```
DRIM are 64 (Not 72) bits wide  ESC - Quit          F1+- - Select Item
Data Integrity Mode            : Non-ECC  F1 - Help          PU/PD/+/- - Modify
                               F5 - Old Values   (Shift)F2 - Color
                               F6 - Load BIOS  Defaults
                               F7 - Load Setup Defaults
```

## Data Integrity Mode (Non-ECC)

*Non-ECC* has byte-wise write capability but no provision for protecting data integrity in the memory module array. *EC-Only* data errors are detected but not corrected. *ECC* with hardware scrubbing allows a detection of single-bit and multiple-bit errors and recovery of single-bit errors. (See **2. System Memory**, section III for more information on memory modules.)

## Onboard FDC Controller (Enabled)

When *Enabled*, this field allows you to connect your floppy disk drives to the onboard floppy disk drive connector instead of a separate controller card. If you want to use a different controller card to connect the floppy disk drives, set this field to *Disabled*.

# IV. BIOS SOFTWARE

---

## **Onboard FDC Swap A & B (No Swap)**

This field allows you to reverse the hardware drive letter assignments of your floppy disk drives. Two options are available: *No Swap* and *Swap AB*. If you want to switch drive letter assignments through the onboard chipset, set this field to *Swap AB*.

## **Onboard Serial Port 1 (3F8H/IRQ4)**

Settings are *3F8H/IRQ4*, *2F8H/IRQ3*, *3E8H/IRQ4*, *2E8H/IRQ10*, and *Disabled* for the onboard serial connector.

## **Onboard Serial Port 2 (2F8H/IRQ3)**

Settings are *3F8H/IRQ4*, *2F8H/IRQ3*, *3E8H/IRQ4*, *2E8H/IRQ10*, and *Disabled* for the onboard serial connector.

## **Onboard Parallel Port (378H/IRQ7)**

This field sets the address of the onboard parallel port connector. You can select either: *3BCH/IRQ7*, *378H/IRQ7*, *278H/IRQ5*, *Disabled*. If you install an I/O card with a parallel port, ensure that there is no conflict in the address assignments. The PC can support up to three parallel ports as long as there are no conflicts for each port.

## **Parallel Port Mode (ECP+EPP)**

This field allows you to set the operation mode of the parallel port. The setting *Normal*, allows normal-speed operation but in one direction only; *EPP* allows bidirectional parallel port operation at maximum speed; *ECP* allows the parallel port to operate in bidirectional mode and at a speed faster than the maximum unidirectional data transfer rate; *ECP+EPP* allows normal speed operation in a two-way mode.

## **ECP DMA Select (3)**

This selection is available only if you select *ECP* or *ECP+EPP* in the **Parallel Port Mode**. Select either DMA Channel *1*, *3*, or *Disable*.

## **UART2 Use Infrared (Disabled)**

When enabled, this field activates the onboard infrared feature and sets the second serial UART to support the infrared module connector on the motherboard. If your system already has a second serial port connected to the onboard COM2 connector, it will no longer work if you enable the infrared feature. By default, this field is set to *Disabled*, which leaves the second serial port UART to support the COM2 serial port connector. See **IrDA-compliant infrared module connector** under section III.

## **Onboard PCI IDE Enable (Both)**

You can select to enable the *primary* IDE channel, *secondary* IDE channel, *both*, or *disable* both channels (for systems with only SCSI drives).

## **IDE Ultra DMA Mode (Auto)**

This field autodetects Ultra DMA capability (for improved transfer speeds and data integrity) for compatible IDE devices. Set to *Disable* to suppress Ultra DMA capability.

## **IDE 0 Master/Slave PIO/DMA Mode, IDE 1 Master/Slave PIO/DMA Mode (Auto)**

Each channel (0 and 1) has both a master and a slave making four IDE devices possible. Because each IDE device may have a different Mode timing (0, 1, 2, 3, 4), it is necessary for these to be independent. The default setting of *Auto* will allow autodetection to ensure optimal performance

# IV. BIOS SOFTWARE

## Power Management Setup

The “Power Management Setup” option allows you to reduce power consumption. This feature turns off the video display and shuts down the hard disk after a period of inactivity.



**NOTE:** SETUP Defaults are noted in parenthesis next to each function heading.

### Details of Power Management Setup

#### Power Management (User Define)

This field acts as the master control for the power management modes. *Max Saving* puts the system into power saving mode after a brief period of system inactivity; *Min Saving* is almost the same as *Max Saving* except that this time the system inactivity period is longer; *Disable* disables the power saving features; *User Define* allows you to set power saving options according to your preference.

**IMPORTANT:** Advanced Power Management (APM) should be installed to keep the system time updated when the computer enters suspend mode activated by the BIOS Power Management. For DOS environments, you need to add the statement, `DEVICE=C:\DOS\POWER.EXE`, in you `CONFIG.SYS`. For Windows 3.x and Windows 95, you need to install Windows with the APM feature. A battery and power cord icon labeled “Power” will appear in the “Control Panel.” Choose “Advanced” in the Power Management Field.

#### Video Off Option (Suspend -> Off )

This field determines when to activate the video off feature for monitor power management. The settings are *Always On* and *Suspend -> Off*.

## IV. BIOS SOFTWARE

---

### **Video Off Method (DPMS OFF)**

This field defines the video off features. The following options are available: *DPMS OFF*, *DPMS Reduce ON*, *Blank Screen*, *V/H SYNC+Blank*, *DPMS Standby*, and *DPMS Suspend*. The DPMS (Display Power Management System) features allow the BIOS to control the video display card if it supports the DPMS feature. *Blank Screen* only blanks the screen (use this for monitors without power management or “green” features. If set up in your system, your screen saver will not display with *Blank Screen* selected). *V/H SYNC+Blank* blanks the screen and turns off vertical and horizontal scanning.

.....

### ***PM Timers***

This section controls the time-out settings for the Power Management scheme. The fields included in this section are “HDD Power Down”, which places the hard disk into its lowest power consumption mode, and the “Suspend Mode” which suspends the CPU.

The system automatically “wakes up” from any power saving mode when there is system activity such as when a key is pressed from the keyboard, or when there is activity detected from the enabled IRQ channels.

### **HDD Power Down (Disable)**

Shuts down any IDE hard disk drives in the system after a period of inactivity. This time period is user-configurable to *1–15 Min* or *Disable*. This feature does not affect SCSI hard drives.

### **Suspend Mode (Disable)**

Sets the period of time after which each of these modes activate: *30 sec*, *1 Min*, *2 Min*, *4 Min*, *8 Min*, *20 Min*, *30 Min*, *40 Min*, *1 Hour*, and *Disable*.

.....

### ***Power Up Control***

This section determines the ways the system can be controlled when it is started or restarted, when modem activity is detected, or when power to the computer is interrupted and reapplied. The Soft-Off mode refers to powering off the system through a momentary button switch (ATX switch) or through the software as opposed to disconnecting the AC power by way of a rocker switch or other means.

### **PWR Button < 4 Secs (Soft Off)**

When set to *Soft Off*, the ATX switch can be used as a normal system power-off button when pressed for less than 4 seconds. *Suspend* allows the button to have a dual function where pressing less than 4 seconds will place the system in sleep mode. Regardless of the setting, holding the ATX switch for more than 4 seconds will power off the system.

# IV. BIOS SOFTWARE

---

## **PWR Up On Modem Act (Enabled)**

This allows either settings of *Enabled* or *Disabled* for powering up the computer (turns the ATX power supply on) when the modem receives a call while the computer is Soft-off.

**NOTE:** The computer cannot receive or transmit data until the computer and applications are fully running, thus connection cannot be made on the first try. Turning an external modem off and then back on while the computer is off causes an initialization string that will also cause the system to power on.

## **AC PWR Loss Restart (Disabled)**

This allows you to set whether you want your system to boot up after the power has been interrupted. *Disabled* leaves your system off after reapplying power and *Enabled* boots up your system after reapplying power.

## **Wake On LAN (Enabled)**

This allows you to remotely power up your system through your network by sending a wake-up frame or signal. With this feature, you can remotely upload/download data to/from systems during off-peak hours. *Enabled* sets this feature.

**IMPORTANT:** This feature requires the optional network interface (see **VII. Network Interface**) and an ATX power supply with at least 720mA +5V standby power.

## **Automatic Power Up (Disabled)**

This allows you to have an unattended or automatic power up of your system. You may configure your system to power up at a certain time of the day by selecting *Everyday*, which will allow you to set the time or at a certain time and day by selecting *By Date*.

.....

## **Fan Monitor (xxxxRPM)**

The onboard hardware monitor is able to detect the Chassis Fan Speed, CPU Fan Speed, and the Power Supply Fan Speed in Rotations Per Minute (RPM). These values refresh upon any key entries in the BIOS setup screen. Set to *Ignore* if one of these are not used so that error messages will not be given.

.....

## **Thermal Monitor (xxxC/xxxF)**

The onboard hardware monitor is able to detect the CPU and MB (motherboard) temperatures. These values refresh upon key entries. Set to *Ignore* only if necessary.

.....

## **Voltage Monitor (xx.xV)**

The onboard hardware monitor is able to detect the voltages put out by the voltage regulators. These values refresh upon key entries. Set to *Ignore* only if necessary.

**NOTE:** If any of the monitored items are out of range, an error message will appear: "Hardware Monitor found an error, enter POWER MANAGEMENT SETUP for details". You will then be prompted to "Press **F1** to continue, **DEL** to enter SETUP".

# IV. BIOS SOFTWARE

## PNP and PCI Setup

The “PNP and PCI Setup” option configures the PCI bus slots. All PCI bus slots on the system use INTA#, thus all installed PCI cards must be set to this value.



**NOTE:** SETUP Defaults are noted in parenthesis next to each function heading.

### Details of PNP and PCI Setup

#### PNP OS Installed (No)

This field allows you to use a Plug-and-Play (PnP) operating system to configure the PCI bus slots instead of using the BIOS. Thus interrupts may be reassigned by the OS when *Yes* is selected. When a non-PnP OS is installed or to prevent reassigning of interrupt settings, select the default setting of *No*.

#### Slot 1 IRQ to Slot 3 IRQ (Auto)

These fields set how IRQ use is determined for each PCI slot. The default setting for each field is *Auto*, which uses auto-routing to determine IRQ use. The other options are manual settings of *NA*, *5*, *7*, *9*, *10*, *11*, *12*, *14* or *15* for each slot.

#### PCI Latency Timer (32 PCI Clock)

The default setting of *32 PCI Clock* enables maximum PCI performance for this motherboard.

#### IRQ xx Used By ISA (No/ICU)

These fields indicate whether or not the displayed IRQ for each field is being used by a legacy (non-PnP) ISA card. Two options are available: *No/ICU* and *Yes*. The first option, the default value, indicates either that the displayed IRQ is not used or an ISA Configuration Utility (ICU) is being used to determine if an ISA card is using that IRQ. If you install a legacy ISA card that requires a unique IRQ, and you are not using an ICU, you must set the field for that IRQ to *Yes*. For example: If you install a legacy ISA card that requires IRQ 10, then set **IRQ10 Used By ISA** to *Yes*.

.....

## IV. BIOS SOFTWARE

---

### **DMA x Used By ISA (No/ICU)**

These fields indicate whether or not the displayed DMA channel for each field is being used by a legacy (non-PnP) ISA card. Available options include: *No/ICU* and *Yes*. The first option, the default setting, indicates either that the displayed DMA channel is not used or an ICU is being used to determine if an ISA card is using that channel. If you install a legacy ISA card that requires a unique DMA channel, and you are not using an ICU, you must set the field for that channel to *Yes*.

### **ISA MEM Block BASE (No/ICU)**

This field allows you to set the base address and block size of a legacy ISA card that uses any memory segment within the C800H and DFFFH address range. If you have such a card, and you are not using an ICU to specify its address range, select a base address from the six available options; the **ISA MEM Block SIZE** field will then appear for selecting the block size. If you have more than one legacy ISA card in your system that requires to use this address range, you can increase the block size to either 8K, 16K, 36K, or 64K. If you are using an ICU to accomplish this task, leave **ISA MEM Block BASE** to its default setting of *No/ICU*.

### **Onboard AHA BIOS (Auto)**

The default uses *Auto* settings for the onboard Adaptec 7890 SCSI BIOS. If you do not want to use the onboard Adaptec 7890 SCSI BIOS, choose *Disabled*.

### **ONB AHA BIOS First (No)**

This field allows giving priority to the onboard SCSI BIOS for SCSI functions over other add-on SCSI controllers. The default is *No*.

### **ONB SCSI SE Term. (Enabled)**

This allows you to enable or disable the onboard termination for single-ended (SE) devices, such as scanners, CD-ROMs, or tape drives. The default is *Enabled*.

### **ONB SCSI LVD Term. (Enabled)**

This allows you to enable or disable the onboard termination for Ultra2 devices, such as disk drives, using low voltage differential (LVD) technology. The default for this field is *Enabled*.

### **USB IRQ (Enabled)**

*Enabled* reserves an IRQ# for the USB to work, *Disabled* does not allow the USB to have an IRQ# and therefore prevents the USB from functioning. If you are not using any USB devices, you may set this feature to *Disabled* to save an extra IRQ# for expansion cards.

### **VGA BIOS Sequence (PCI/AGP)**

You can select the search order for your VGA card(s). *PCI/AGP* will detect PCI VGA cards before AGP, and *AGP/PCI* will detect AGP cards before PCI VGA.

# IV. BIOS SOFTWARE

## Load BIOS Defaults

The “Load BIOS Defaults” option allows you to load the troubleshooting default values permanently stored in the BIOS ROM. These default settings are non-optimal and disable all high performance features. To load these default settings, highlight “Load BIOS Defaults” on the main screen and then press <Enter>. The system displays a confirmation message on the screen. Press <Y> and then <Enter> to confirm. Press <N> and then <Enter> to abort. This feature does not affect the fields on the Standard CMOS Setup screen.

## Load Setup Defaults

The “Load Setup Defaults” option allows you to load the default values to the system configuration fields. These default values are the optimized configuration settings for the system. To load these default values, highlight “Load Setup Defaults” on the main screen and then press <Enter>. The system displays a confirmation message on the screen. Press <Y> and then <Enter> to confirm. Press <N> and then <Enter> to abort. This feature does not affect the fields on the Standard CMOS Setup screen.





## IV. BIOS SOFTWARE

### Supervisor Password and User Password

These two options set the system passwords. “Supervisor Password” sets a password that will be used to protect the system and the Setup utility; “User Password” sets a password that will be used exclusively on the system. By default, the system comes without any passwords. To specify a password, highlight the type you want and then press <Enter>. A password prompt appears on the screen. Taking note that the password is case sensitive, and can be up to 8 alphanumeric characters long, type in your password and then press <Enter>. The system confirms your password by asking you to type it again. After setting a password, the screen automatically reverts to the main screen.



To implement password protection, specify in the “Security Option” field of the BIOS Features Setup screen when the system will prompt for the password. If you want to disable either password, press <Enter> instead of entering a new password when the “Enter Password” prompt appears. A message confirms the password has been disabled.

**NOTE:** If you forget the password, see **Clear Time Clock (Jumpers)** in section III for procedures on clearing the CMOS.

# IV. BIOS SOFTWARE

## IDE HDD Auto Detection

The “IDE HDD Auto Detection” option detects the parameters of an IDE hard disk drive, and automatically enters them into the Standard CMOS Setup screen.

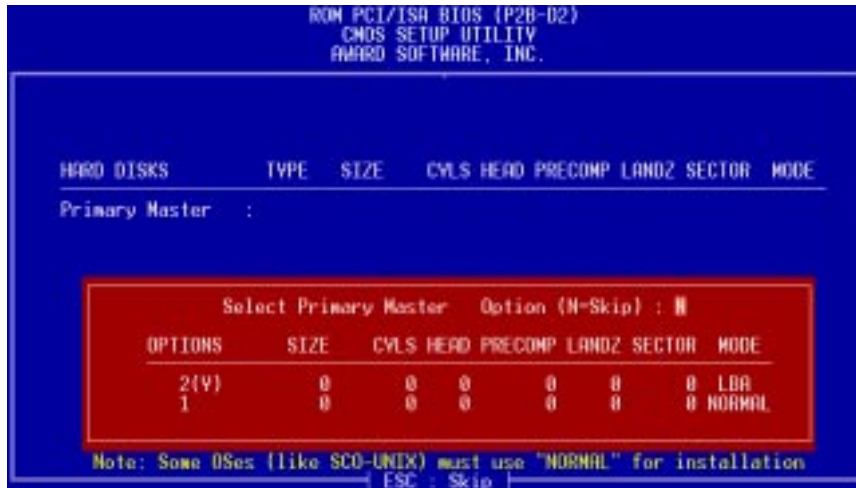

Up to four IDE drives can be detected, with parameters for each listed inside the box. To accept the optimal entries, press <Y> or else select from the numbers displayed under the OPTIONS field (2, 1, 3 in this case); to skip to the next drive, press <N>. If you accept the values, the parameters will appear listed beside the drive letter on the screen. The process then proceeds to the next drive letter. Pressing <N> to skip rather than to accept a set of parameters causes the program to enter zeros after that drive letter.

Remember that if you are using another IDE controller that does not feature Enhanced IDE support for four devices, you can only install two IDE hard disk drives. Your IDE controller must support the Enhanced IDE features in order to use Drive E and Drive F. The onboard PCI IDE controller supports Enhanced IDE, with two connectors for connecting up to four IDE devices. If you want to use another controller that supports four drives, you must disable the onboard IDE controller in the Chipset Features Setup screen.

When auto-detection is completed, the program automatically enters all entries you accepted on the field for that drive in the Standard CMOS Setup screen. Skipped entries are ignored and are not entered in the screen.

If you are auto-detecting a hard disk that supports the LBA mode, three lines will appear in the parameter box. Choose the line that lists LBA for an LBA drive. Do not select Large or Normal.

The auto-detection feature can only detect one set of parameters for a particular IDE hard drive. Some IDE drives can use more than one set. This is not a problem if the drive is new and empty.

## IV. BIOS SOFTWARE

---

**IMPORTANT:** If your hard disk was already formatted on an older previous system, incorrect parameters may be detected. You will need to enter the correct parameters manually or use low-level format if you do not need the data stored on the hard disk.

If the parameters listed differ from the ones used when the disk was formatted, the disk will not be readable. If the auto-detected parameters do not match the ones that should be used for your disk, do not accept them. Press <N> to reject the presented settings and enter the correct ones manually from the Standard CMOS Setup screen.

### Save & Exit Setup

Select this option to save into the CMOS memory all modifications you specified during the current session. To save the configuration changes, highlight the “Save & Exit Setup” option on the main screen, type “Y”, and then press <Enter>.



### Exit Without Saving

Select this option to exit the Setup utility without saving the modifications you specify during the current session. To exit without saving, highlight the “Exit Without Saving” option on the main screen and then press <Enter>.

---

(This page was intentionally left blank.)

# V. Support CD

---

## Support CD Contents

At the time that this manual was printed, the support CD was in development. For information on the support software provided, please check the README files on the support CD.

---

(This page was intentionally left blank)

# A. Video Driver

---

## First Time Installation

### Installing Video drivers in Windows 95 (New Hardware Found)

If you are installing the S3 Trio64 graphics device for Windows 95 for the first time, a **New Hardware Found** window will appear:

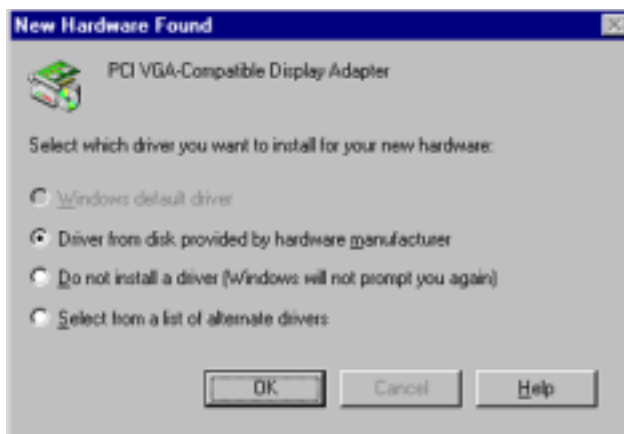

1. Click **OK** to use the default selection: **Driver from disk provided by hardware manufacturer.**
2. Insert the ASUS support CD and click **Browse** - The *Open* window appears.
3. Select your CD-ROM drive in the **Drives:** box.
4. Select **VGA\WIN95**.
5. Click **OK** - Install from Disk appears - Click **OK** again.
6. After restarting Windows, your S3 Trio64 graphics device should be automatically detected.

# A. Video Driver

## Install Windows 95 Video Driver

### Using Control Panel

1. Start Windows 95, switch display to VGA mode, then restart.
2. Right-click your desktop and select **Properties**, and then click the **Settings** tab.



3. Select **Change Display Type**.
4. Click **Change**.
5. Click **Have Disk**. Insert the ASUS support CD. Type **D:\VGA\WIN95** (assuming your CD-ROM drive is letter D) or click **Browse** to select the path of the display driver for Windows 95. Click **OK**. You will see a list of ASUS VGA devices. Select the appropriate VGA device and press **OK** to start installation.
6. When all files are copied, return to **Display Properties** window by clicking **Close**. Click **Apply**, and then click **Yes** to restart Windows.



7. When Windows starts up, your VGA device is ready to use.



# A. Video Driver

## Windows 95 Display Settings

### Changing display settings

To enter the **Display Properties** at any time, right click your mouse on the desktop and select **Properties** or double click the **Display** icon in the **Control Panel**. Click the appropriate Tab as follows:

### Adjustment:

Lets you change your monitor settings, such as position, size, refresh rate and performance.

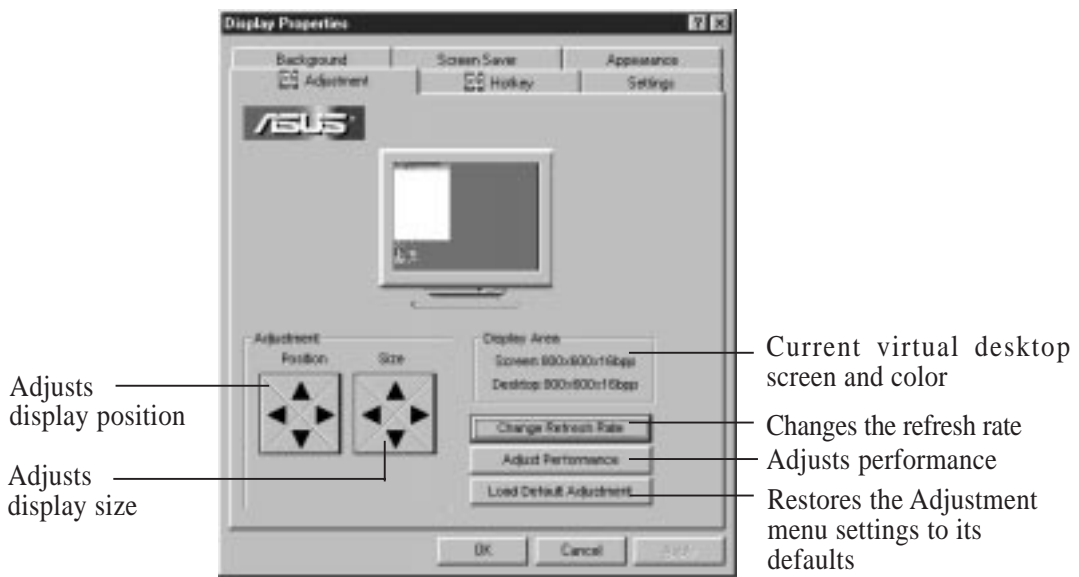

### Change Refresh Rate:

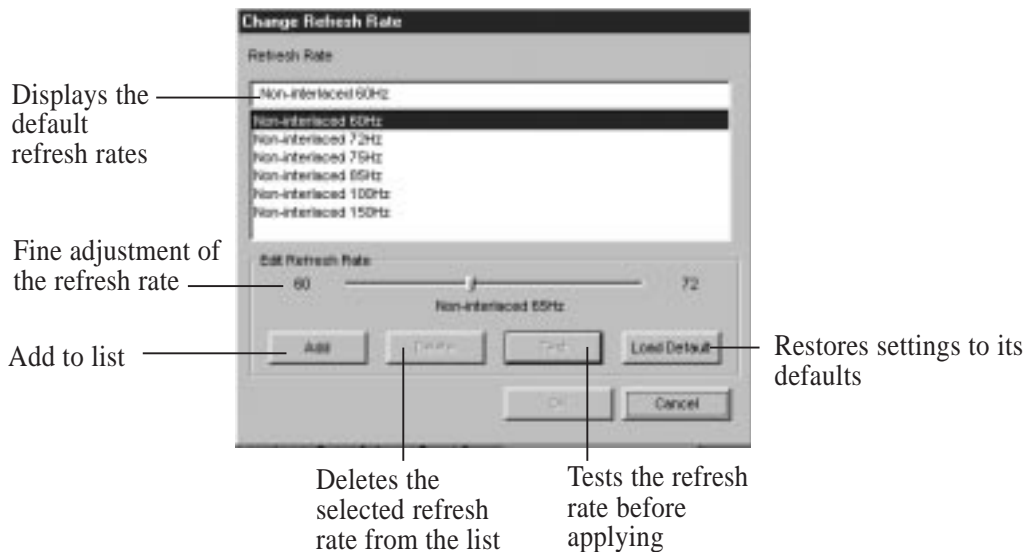

# A. Video Driver

## Adjust Performance

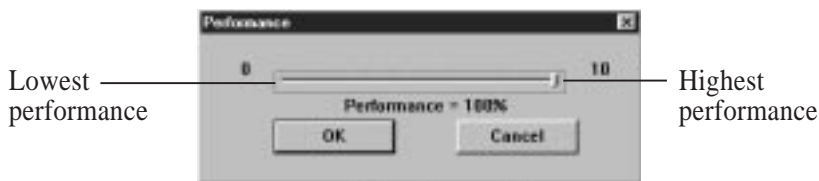

## Hotkey:

Allows you to assign hotkeys in the "Value" box to move your screen up, down, left, and right, or zoom in, zoom out in virtual desktop.

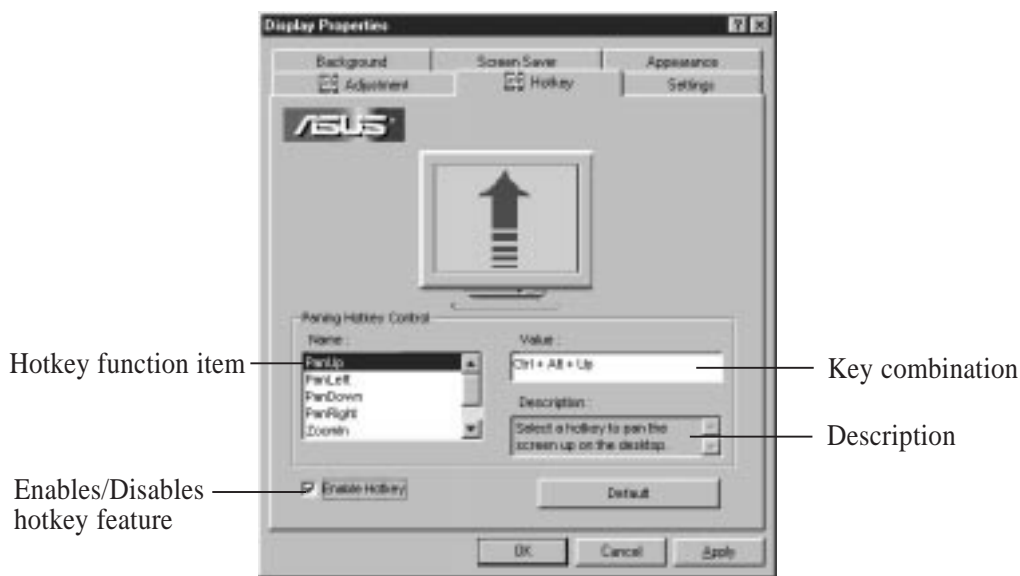

## Settings:

Allows you to change your display settings, adjust screen resolution and color depth, virtual desktop, color palette and font size.

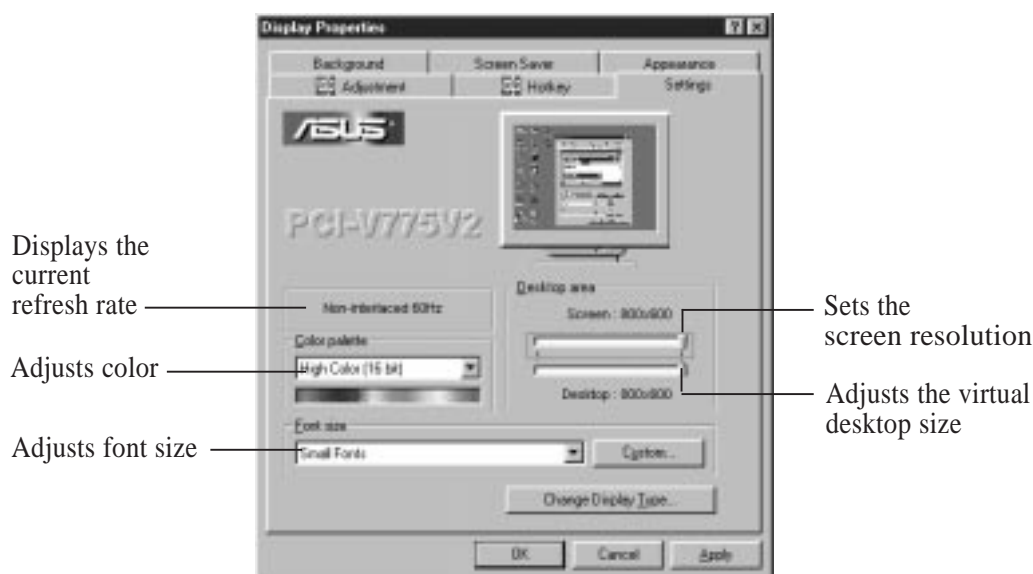

## A. Video Driver

---

### Windows NT 4.0 Video Driver Installation

1. Boot Windows NT in standard VGA mode (recommended).
2. Run Windows NT Display program located in the **Control Panel**, under **Settings** in the **Start** menu. Alternatively, position the cursor on the background of the desktop, click the right mouse button, then select **Properties** from the popup menu.
3. Select the **Settings** page.
4. Select **Display Type**.
5. Select **Change** from the display options.
6. Select **Have Disk**.
7. Windows NT will prompt you for the correct path, enter the path of driver in CD-ROM such as **D:\VGA\NT40** (assuming your CD-ROM drive is letter D).
8. A list of ASUS S3 series video adapters will be displayed. Select the one you are using, then click **OK**.
9. Windows NT will once again prompt for confirmation. All appropriate files are then copied to the hard disk.
10. Select **Apply** in **Control Panel**. Restart Windows NT. Windows NT will start up using the S3 drivers.
11. Windows NT will boot into a default mode and start the Display applet allowing for mode selection.

---

(This page was intentionally left blank)

## B. NETWORK INTERFACE

---

This motherboard features an optional 32-bit 10/100Mbps Ethernet network interface. This interface supports the bus mastering architecture and auto-negotiation feature, which makes it possible to use the common twisted-pair cabling with RJ45 connectors for both 10Mbps and 100Mbps connections. Extensive driver support for commonly-used network systems is also provided.

### Features

- Intel 82558 Ethernet LAN Controller (Fully integrated 10BASE-T/100BASE-TX)
- Wake-On-LAN Remote Control Function Supported
- PCI Bus Master Complies to PCI Rev. 2.1
- Consists of MAC & PHY (10/100Mbps) interfaces
- Complies to IEEE 802.3 10BASE-T and IEEE 802.3U 100BASE-TX interfaces
- Fully supports 10BASE-T & 100BASE-TX operations
- Single RJ-45 Connector: Auto-Detection of 10Mbps or 100Mbps Network Data Transfer Rates and Connected Cable Types
- 32 bit Bus Master Technology / PCI Rev. 2.1
- Plug and Play
- Enhancements on ACPI & APM
- Adheres to PCI Bus Power Management Interface Rev. 1.0, ACPI Rev. 1.0, and Device Class Power Management Rev. 1.0

### Software Driver Support

**NetWare ODI Drivers** - Novell Netware 3.x, 4.x; NetWare LAN WorkPlace TCP/IP; Novell LAN Analyzer for Netware

**Packet Drivers** - FTP PC/TCP, NCSA TCP/IP, Accton LANSoft

**NDIS Drivers** - LAN Manager V2.x; Windows 3.x, 95, NT (Server/Workstation) V3.x, V4.0; IBM LAN Server 2.x, 3.0; IBM LAN Support V1.x; IBM OS/2 EE V2.0; DEC Pathworks V4.x & V5.0; Sun PC-NFS; Banyan VINES; IBM TCP/IP for DOS & OS/2; Wollongong Pathway Access

**Unix Driver** - SCO Unix

# B. NETWORK INTERFACE

## LED Connectors

**Link Indicator:** This connects to an LED to monitor 10Base-T and 100Base-TX connections. The LED lights to indicate a successful network connection, and remains steady if the connection is stable. If this indicator is off, the cable connection between the hub and the computer may be faulty or the driver configuration may be faulty.

**Activity Indicator:** This connects to an LED to monitor network activity. The LED lights when there are network packets sent or received through the RJ45 port. The rate of flashing is proportional to the amount of network traffic. If this is off, the computer is not sending or receiving network data.

**Speed Indicator:** This connects to an LED to monitor connection speed. The LED lights (**On**) when connection is made to a 100Base-TX host. If **Off**, the network connection is operating at 10Mbps.

## Network Cable Connection

**Twisted Pair Ethernet (TPE)** - Connect a single network cable to the RJ45 connector. For 100BASE-TX, your network cable must be category 5 (not category 3), twisted-pair wiring with RJ45 connectors. If you plan on running the interface at 100 Mbps, it must be connected to a 100BASE-TX hub (not a 100BASE-T4 hub). For 10BASE-T, use category 3, 4, or 5 twisted-pair wiring.

## Twisted-Pair Cable

The cable used to connect the Ethernet card to a host (generally a Hub) is called a straight-through twisted-pair. The end connectors are called RJ45 connectors, which are not compatible with the standard RJ11 telephone connectors. The illustration shows a connection between a typical Hub and this motherboard's network interface.

### Straight-Through Cable

Hub	Card
1 IRD+	1 OTD+
2 IRD-	2 OTD-
3 OTD+	3 IRD+
6 OTD-	6 IRD-

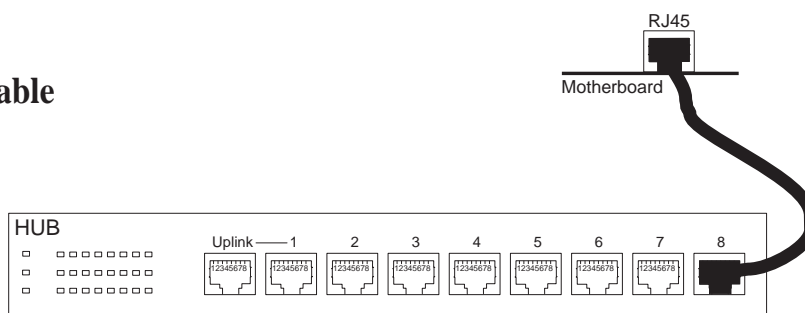

## RJ45 Connector

Pin 1	Output Transmit Data +
Pin 2	Output Transmit Data -
Pin 3	Input Receive Data +
Pin 6	Input Receive Data -
Pins 4,5,7,8	(Reserved)

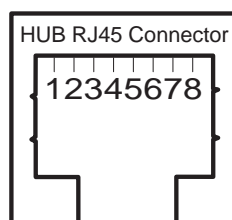

# B. NETWORK INTERFACE

---

## DOS and Windows 3.1 Setup for Novell

### **Automatic configuration**

Some computers automatically detect and configure adapters and interfaces while booting. The network interface's IRQ level and I/O memory address of this motherboard are automatically set by the BIOS each time you start your computer.

Start your computer to automatically configure the network interface. Configuration is complete when the DOS prompt appears. You can now continue with the procedure below.

If your computer displays an error while booting, it may require additional steps.

### **Run Setup to install network drivers**

Setup can automatically install NetWare DOS ODI client drivers for you or display a README file with installation instructions for other NOS drivers.

1. If your computer already has network drivers installed, restart the computer without loading them. If the drivers are loaded from the AUTOEXEC.BAT or CONFIG.SYS file, type REM in front of each line that loads a network driver. Or, with DOS 6.x or later press "F5" as DOS starts, to bypass the drivers.
2. Insert the ASUS Configuration and Drivers disk in a floppy drive, switch to that drive, and at the DOS prompt, type "SETUP".
3. If you have another network adapter in your computer, an adapter selection menu appears on the screen. Select the adapter you want by noting the Ethernet address.
4. Select Automatic Setup from the Main menu. Then follow the instructions on the screen. (If you want to test the interface with a responder on the network, see the next procedure.) Setup displays the configuration, then runs a series of diagnostic tests that makes sure the network interface or adapter and network are functioning properly. If Setup finds a problem, it displays the results and some possible solutions.
5. When Setup finishes the tests, you'll see the Install Network Drivers screen.
6. Select the driver you want to install. Setup can install a NetWare client driver for you. If you're installing other drivers, Setup displays a README file with installation instructions.

## B. NETWORK INTERFACE

---

### Troubleshooting

If you can't connect to a server, first try the suggestions here, then turn to the Troubleshooting section if necessary.

- Make sure you're using the drivers for this interface. The driver filename contains the letter B (for example, E100BODI.COM).
- If you're replacing an existing adapter, make sure the LINK statement in your NET.CFG is correct for the new interface or adapter. For example, the LINK statement for a NetWare client should be: "LINK DRIVER E100BODI"
- Verify that the frame type in your NET.CFG file matches your network.
- If setting up a server, check your LOAD and BIND statements.
- Test the interface by running diagnostics in Setup. Additional testing is available by using a responder.
- Check the README files.

### Responder testing on the network (optional)

Setup can test the interface more thoroughly if you have a responder on the network while running the tests.

1. Go to a computer on the network with any EtherExpress adapter or interface installed (except EtherExpress 32 or EtherExpress 16 MCA).
2. Run the appropriate configuration program for the installed interface and set it up as a responder.
3. Return to the computer with the new adapter or interface. Run Setup and make the new interface the sender. Test the interface.

## Windows NT Server or Workstation

### Automatic configuration

Some computers automatically detect and configure adapters or interfaces while booting. The network interface's IRQ level and I/O address are automatically set by the BIOS each time you start your computer.

Start your computer to automatically configure the network interface. Configuration is complete when Windows NT starts or the DOS prompt appears.

If your computer displays an error while booting, it may require additional steps to configure.

### Install network drivers - Windows NT Version 4.0 only

After starting Windows NT, you need to install the device drivers. Have the Windows NT CD-ROM disk available for this procedure.



## B. NETWORK INTERFACE

---

**NOTE:** If you are installing Windows NT 4.0 at this time, click the Start Search button when the network network interface or adapter installation window appears. This allows NT to autodetect the network interface or adapter. You may then skip steps 1 - 4 below.

1. Double-click the Network icon in the Control Panel.
2. Click the Adapters tab in the window that appears.
3. Click Add. A list of network interface or adapter appears.
4. Select “Intel EtherExpress PRO Adapter” and click OK.

### **Install network drivers - Windows NT Version 3.5x only.**

After setting up the network interface and starting Windows NT, you need to install the Intel drivers and test the network interface or adapter.

1. Double-click the Network icon in the Control Panel.
2. Click Add Adapter.
3. When the list of adapters appears, scroll to the end of the list and select <Other> Requires disk from manufacturer.
4. Insert the ASUS Configuration and Drivers disk in the A: drive and click OK.
5. Select the “Intel EtherExpress PRO Adapter” and click OK.
6. Click OK in the Network Settings dialog box and remove the installation disk. When prompted, restart Windows NT.

To install multiple network interface or adapters, repeat this procedure for each new network interface or adapter.

### **Troubleshooting**

If Windows NT reports an error or you can't connect to the network, try the suggestions here first, then turn to the Troubleshooting section if necessary.

- Make sure you're using the drivers for this network interface or adapter. Drivers are located on the Windows NT CD-ROM or on the ASUS Drivers and Configuration disk.
- Make sure the driver is loaded and the protocols are bound. Check the Network Bindings dialog box in Windows NT.
- Check the Windows NT Event Viewer for error messages.
- If you are attaching to a NetWare network, check your frame type and verify that NetWare client software has been installed.
- Check with your LAN administrator — you may need to install supplemental networking software.

## B. NETWORK INTERFACE

---

### Windows 95

#### Automatic Configuration

Some computers automatically detect and configure adapters or interfaces while booting. The network interface's IRQ level and I/O address of this motherboard are automatically set by the BIOS each time you start your computer.

Start your computer to automatically configure the network interface or adapter. Configuration is complete when Windows 95 starts. If your computer displays an error while booting, it may require additional steps to configure.

#### Install Network Drivers from Diskette

Have your Windows 95 installation CD-ROM or disks available, as Windows 95 prompts for them when you install the new network interface or adapter.

1. After you have set up your motherboard for network use, start Windows 95. The New Hardware Found dialog box appears. If this box does not appear and Windows 95 starts normally, you may need to manually add the network interface or adapter.
2. Click "Driver from disk provided by hardware manufacturer," then click OK. The Install From Disk dialog box appears.
3. Insert the ASUS Configuration and Drivers disk.
4. Specify A:\ (or B:\) as the path, then click OK.
5. Follow prompts for any Windows 95 installation disks and restart when prompted. (If you installed from CD-ROM, the installation files are typically located at D:\Win95, where D is your CD-ROM drive.)

After restarting Windows 95, you should be able to connect to your network by double-clicking the Network Neighborhood.

#### Troubleshooting

If you can't connect to a server or if Windows 95 reports an error after you double-click Network Neighborhood, try the suggestions here first, then the Troubleshooting section if necessary.

- Make sure you're using the drivers that are on the drivers diskette that ships with this network interface or adapter.
- Make sure the driver is loaded and the protocols are bound. Check Device Properties list for trouble indicators (an X or ! symbol).
- Check with your LAN administrator — you may need to install supplemental networking software.

NetWare Server, Client 32, UNIX, OS/2, Banyan, and Other Operating Systems

For these, refer to our online documents. On a DOS computer, view the appropriate README file for information on installing your network driver.

## B. NETWORK INTERFACE

---

### Select Duplex Mode (optional)

Duplexing is a performance option that lets you choose how the network interface or adapter sends and receives data packets over the network. This motherboard's network interface can operate at full duplex only when connected to a full duplex 10BASE-T, 100BASE-TX switching hub, or another full duplex network interface or adapter. To summarize:

- **Auto (requires a full duplex network interface or adapter or switching hub with auto-negotiation capability).** The network interface or adapter negotiates with the hub to send and receive packets at the highest rate. This is the default setting. If the hub does not provide auto-negotiation, the network interface or adapter runs at half duplex.
- **Full duplex (requires a full duplex switching hub or network interface or adapter).** The network interface or adapter can send and receive packets at the same time. This mode can increase network interface or adapter performance capability. If the full duplex hub provides auto-negotiation, the network interface or adapter runs at full duplex. If the full duplex hub does not provide auto-negotiation, you need to set the network interface or adapter duplex mode manually (see following paragraphs)
- **Half duplex.** The network interface or adapter performs one operation at a time; it either sends or receives.

**NOTE:** If your hub is running at 100 Mbps and half duplex, your potential bandwidth is higher than if you run at 10 Mbps and full duplex.

#### Manually Configuring for Full Duplex

If your switch supports auto-negotiation with the N-way standard, duplex configuration is automatic and no action is required on your part. However, few switches in the current installed base support auto-negotiation. Check with your network system administrator to verify. Most installations will require manual configuration to change to full duplex.

Configuration is specific to the driver you're loading for your network operating system (NOS), as shown in the following paragraphs. To set up the duplex mode, refer to the section below that corresponds to your operating system. The performance of the network interface or adapter may suffer or your network interface or adapter may not operate if your hub does not support full duplex and you configure the network interface or adapter to full duplex. Leave the network interface or adapter on half duplex if you are not sure what type of hub you are connected to.

#### DOS ODI, NDIS 2.01 Clients

Edit the NET.CFG or PROTOCOL.INI file. Add keywords to Link Driver section:

```
FORCEDUPLEX 2  
SPEED 100 (or 10 if 10BASE-T)
```

## B. NETWORK INTERFACE

---

### NetWare server

In AUTOEXEC.NCF, Load E100B.LAN and add the following statement (you must include the equal sign for servers):

```
FORCEDUPLEX=2  
SPEED=100 (or 10 if 10BASE-T)
```

For more information, see the README file for NetWare servers.

### Windows NT

While running Windows NT:

1. From the Control Panel, double-click the Intel PROSet icon.
2. PROSet examines your system and displays the Adapter Setup window.

### Windows 95

While running Windows 95:

1. From the Control Panel, double-click the Intel PROSet icon.
2. PROSet examines your system and displays the Adapter Setup window. If you have multiple adapters, click the adapter you are configuring (you can identify it by its Ethernet address). Each adapter must be configured separately.
3. From the window that appears, click Change.
4. From the Adapter Setup window, click the menu for Network Speed.
5. Click 100 or 10 Mbps, depending on hub speed.
6. Click the menu for Duplex Mode
7. Click Full.
8. Click OK when finished.
9. Click OK to restart Windows 95.

### Other operating systems

See the *Adapter Installation and Special Configurations* README file. "Push" Installation for Windows 95

If you are a LAN Administrator setting up server-based push installation of Windows 95 as defined in Microsoft Windows 95 Resource Kit, additional steps are required for this network interface or adapter.

# B. NETWORK INTERFACE

---

## Troubleshooting

*If the interface can't connect to the network*

**Make sure the cable is installed properly.**

The network cable must be securely attached at both RJ-45 connections (interface and hub). If the cable is attached but the problem persists, try a different cable. The maximum allowable distance from network interface or adapter or interface to hub is 100 meters.

If you're directly connecting two computers (no hub), use a crossover cable. Most hubs require a straight-through cable, while most switches require a crossover cable (see your hub or switch documentation to verify).

**Check the LED lights on the network interface or adapter.**

The optional network condition connector module has three diagnostic LEDs. These lights help indicate if there's a problem with the connector, cable, or hub. The table below describes the LEDs.

<b>LED</b>	<b>Indication</b>	<b>Meaning</b>
<b>LNK</b>	<b>On</b>	The interface and hub have acknowledged a connection; the link between the hub and interface is good.
	<b>Off</b>	The cable connection between the hub and interface is faulty; or you have a driver configuration problem.
<b>ACT</b>	<b>On or flashing</b>	The interface is sending or receiving network data. The frequency of the flashes varies with the amount of network traffic.
	<b>Off</b>	The interface is not sending or receiving network data.
<b>SPD</b>	<b>On</b>	Network connection operating at 100 Mbps.
	<b>Off</b>	Network connection operating at 10 Mbps.

**Make sure you're using the correct drivers.**

Make sure you're using the drivers that come with your motherboard. The driver filename contains the letter B (for example, E100BODI.DOS).

**Make sure the hub port and the network interface or adapter have the same duplex setting.**

If you configured the network interface for full duplex, make sure the hub port is also configured for full duplex. Setting the wrong duplex mode can degrade performance, cause data loss, or result in lost connections.

## B. NETWORK INTERFACE

---

### *Testing the network interface or adapter*

Test the network interface or adapter by running Intel diagnostics. For DOS or Windows 3.1 computers, run Setup on the ASUS Configuration and Drivers disk. For Windows NT and Windows 95 run Intel PROSet by double-clicking the Intel PROSet Icon in the Control Panel. Click Help from the main PROSet window to get complete diagnostics information and instructions.

### *Common problems and solutions*

**SETUP.EXE reports the network interface or adapter is “Not enabled by BIOS”.**

- The PCI BIOS isn't configuring the network interface or adapter correctly. Try the PCI installation tips.

**The computer hangs when the drivers are loaded.**

- Change the PCI BIOS interrupt settings. See the next page for PCI installation tips.
- If you are using EMM386, it must be version 4.49 or newer (this version ships with MS-DOS 6.22 or newer).

**Diagnostics pass, but the connection fails or errors occur.**

- At 100 Mbps use category 5 wiring and make sure the network cable is securely attached.
- For NetWare clients, make sure you specify the correct frame type in the NET.CFG file.
- Make sure the duplex mode setting on the network interface or adapter matches the setting on the hub.
- At 100 Mbps, connect to a 100BASE-TX hub only (not T4).

**The LNK LED doesn't light.**

- Make sure you've loaded the network drivers.
- Check all connections at the network interface or adapter and the hub.
- Try another port on the hub.
- Make sure the duplex mode setting on the network interface or adapter matches the setting on the hub.
- Make sure you have the correct type of cable between the network interface or adapter and the hub. 100 BASE-TX requires two pairs. Some hubs require a cross-over cable while others require a straight-through cable. See the *Cabling* README file for more information on cabling.

**The ACT LED doesn't light.**

- Make sure you've loaded the correct network drivers.
- The network may be idle. Try accessing a server.
- The network interface or adapter isn't transmitting or receiving data. Try another network interface or adapter.
- May not be using four-pair cable for TX wiring.

## B. NETWORK INTERFACE

---

### **The network interface or adapter stopped working when another network interface or adapter was added to the computer.**

- Make sure the cable is connected to the motherboard's network interface or RJ45 port.
- Make sure your PCI BIOS is current.
- Make sure the other network interface or adapter supports shared interrupts. Also, make sure your operating system supports shared interrupts — OS/2\* doesn't.

### **The interface stopped working without apparent cause.**

- Try reconnecting the cable to the RJ45 port first.
- The network driver files may be corrupt or deleted. Delete and then reinstall the drivers.
- Try another motherboard of the same model.
- Run the diagnostics.

### **The Wake On LAN feature is not working.**

- Make sure the WOL cable is attached and power is applied to the computer.
- Check the BIOS for its WOL setting. Some computers may need to be configured to WOL.
- Make sure the network cable is fully attached to the network interface or adapter.

### **Link LED does not light when power is connected.**

- Make sure WOL cable is attached and power is applied to computer.
- Make sure network cable is attached at both ends.

# B. NETWORK INTERFACE

---

## Technical Information

### Fast Ethernet Wiring

**100BASE-TX Specification:** The 100BASE-TX specification supports 100 Mbps transmission over two pairs of category 5 twisted-pair Ethernet (TPE) wiring. One pair is for transmit operations and the other for receive operations. Segment lengths are limited to 100 meters with 100BASE-TX for signal timing reasons. This complies with the EIA 568 wiring standard.

### Fast Ethernet Hubs and Switches

The two basic types of hubs are shared hubs and switching hubs. This motherboard's network interface can be used with either type of hub for 10 Mbps. At 100 Mbps, a TX hub or switch is required.

#### *Shared hubs*

In a shared network environment, computers are connected to hubs called repeaters. All ports of the repeater hub share a fixed amount of bandwidth, or data capacity. On a 100 Mbps shared hub, all nodes on the hub must share the 100 Mbps of bandwidth. As stations are added to the hub, the effective bandwidth available to any individual station gets smaller. Shared hubs do not support full duplex.

Think of a shared repeater hub as a single-lane highway that everyone shares. As the number of vehicles on the highway increases, the traffic becomes congested and transit time increases for individual cars.

On a shared hub all nodes must operate at the same speed, either 10 Mbps or 100 Mbps. Fast Ethernet repeaters provide 100 Mbps of available bandwidth, ten times more than what's available with a 10BASE-T repeater.

Repeaters use a well-established, uncomplicated design, making them highly cost effective for connecting PCs within a workgroup. These are the most common type of Ethernet hubs in the installed base.

#### *Switching hubs*

In a switched network environment, each port gets a fixed, dedicated amount of bandwidth. In the highway scenario, each car has its own lane on a multi-lane highway and there is no sharing.

In a switched environment, data is sent only to the port that leads to the proper destination station. Network bandwidth is not shared among all stations, and each new station added to the hub gets access to the full bandwidth of the network.

If a new user is added to a 100 Mbps switching hub, the new station receives its own dedicated 100 Mbps link and doesn't impact the 100 Mbps bandwidth of another station. Switching hubs can effectively increase the overall bandwidth available on the network, significantly improving performance. Switching hubs can also support full duplex.



## B. NETWORK INTERFACE

---

### Using Wake On LAN

The Wake On LAN feature operates according to a published specification. In simple terms, the specification allows designers to build network adapters or interfaces that are capable of “listening to” network activity even when the computer is turned off. WOL adapters or interfaces have a special low power standby mode that is active when the rest of the computer is without power. The network interface or adapter will respond to a special “wake-up” packet sent by another computer or network device. Typically this wake-up packet causes the network interface or adapter to signal the computer to power up and run a pre-defined program.

### Question and Answer

Q: What is Wake-On-LAN ?

A: The Wake-On-LAN feature provides the capability to remotely power on systems supporting Wake-On-LAN by simply sending a wake-up frame. With this feature, remotely uploading/downloading data to/from systems during off-peak hours will be feasible.

Q: What can Wake-On-LAN do for you ?

A: Wake-On-LAN is a remote management tool with advantages that can reduce system management workload, provide flexibility to the system administrator’s job, and then of course save you time-consuming efforts and costs.

Q: What components does Wake-On-LAN require to be enable?

A: To enable Wake-On-LAN function, your system requires an Ethernet LAN adapter card or interface that can activate the Wake-On-LAN function, a client with Wake-On-LAN capability, and software such as LDCM Rev. 3.10 or up that can trigger the wake-up frame.

# B. NETWORK INTERFACE

---

## Glossary

### **100Base-TX**

IEEE's specification for running 100Mbps Ethernet using twisted-pair cables.

### **10Base-T**

IEEE's specification for running 10Mbps Ethernet using twisted-pair cables.

### **10Base2**

IEEE's specification for running Ethernet using thick coaxial cables.

### **BNC**

A connector with a half-twick locking shell typically used for thin coaxial cables.

### **Boot ROM**

Read-only memory chip that allows a workstation to communicate with LAN cards or other network interfaces.

### **Driver**

A program that enables the network operating system to communicate with LAN cards.

### **IEEE 802.3 standard**

Standard for the physical and electrical connections in local area networks developed by the IEEE (Institute of Electrical and Electronics Engineers).

### **IEEE 802.3u standard**

IEEE standard for Local Area Networks (LAN) employing CSMA/CD as the access method. This standard is intended to encompass several media types and techniques for signal rates from 1Mb/s to 100Mb/s.

### **Interrupt (IRQ)**

Signal suspending a program temporarily and transfers control to the operating system when input or output is required.

### **LED**

Light emitting diode

### **Mbps**

Megabits per second

# C. ADAPTEC SCSI SELECT

---

## Configuring the SCSI Adapter

Access the SCSI BIOS by holding down both **CTRL** and **A** keys when you see the BIOS banner message listing the driver name and the attached devices. For example:

**Adaptec AIC-7890 SCSI BIOS Build 20107  
(c) 1998 Adaptec, Inc. All Rights Reserved.**

**<<< Press <Ctrl><A> for SCSISelect(TM) Utility! >>>**

The SCSISelect screen will come up. Instructions on how to move the cursor and select options are listed on the bottom of the program windows.

## SCSI Disk Utilities

The SCSI Disk Utilities option displays information on SCSI IDs 0 through 15, listing all devices on the bus including non-disk devices. When you select a device from the list and press Enter key, another window appears giving you the option of selecting one of two sub-utilities, **Format Disk** or **Verify Media**. These utilities are used for hard disk drives only and will have no effect on other non-disk SCSI devices.

**Format Disk** - low-level formats your SCSI hard disks. In general, SCSI hard disks have already been low-level formatted when you get them, so you generally do not need to use this function.

**Verify Media** - scans the selected drive media for defects, notifies you of any defects found and gives you the option of reassigning bad blocks so that data will not be written to them. This utility is only necessary if you suspect that your SCSI disk drive has a problem.

# D. ADAPTEC EZ-SCSI

---

Welcome to Adaptec EZSCSIVI, ADAPTEC EZ-SCSI UTILITY 4.03. Adaptec EZSCSI gives you what you need to use SCSI devices in DOS, Windows<sup>®</sup>3.1x, or Windows for Workgroups3.1x.

**Note:** The ADAPTEC EZ-SCSI UTILITY does not provide drivers for Windows<sup>®</sup>95 and WindowsNT<sup>™</sup>.

## Quick Start Instructions

First, install SCSI devices (see the hardware documentation for details). Then follow the instructions for your operating system software in one of the following sections. We recommend that after you install Adaptec EZSCSI, you run SCsITutor to learn more about the features of SCSI.

### Windows95 or WindowsNT

If you want to install Windows95 or WindowsNT on a new computer system, you may not be able to access your SCSI CDROM drive at first. (Usually, you install Windows95 and WindowsNT from a CDROM disc.) To gain access to your CDROM drive, follow the DOS Quick Start instructions.

### Windows/Windows for Workgroups 3.1x

- 1 Install Windows 3.1x or Windows for Workgroups 3.1x and start it running on your computer.
- 2 Insert the Adaptec EZSCSI Setup Disk into your floppy disk drive.
- 3 Select File/Run from the Program Manager menu.
- 4 When the Run dialog box appears, type a:\setup if you are using the A drive or b:\setup if you are using the B drive. Then click OK.
- 5 Follow the onscreen instructions.

### DOS

- 1 Install DOS 6.x or later and start it running on your computer.
- 2 Insert the Adaptec EZSCSI Setup Disk into your floppy disk drive.
- 3 At the DOS prompt, type a:\install (assuming your 3.5" floppy is A: drive). Then press <Enter>.
- 4 Follow the onscreen instructions.

## D. ADAPTEC EZ-SCSI

---

### Troubleshooting Tips

#### SCSI Device Troubleshooting

Review this checklist if your newly-installed SCSI disk drives, CDROM drives, and other devices do not seem to work properly:

- Be sure that termination is correctly set for all devices on the SCSI bus, as described in your host adapter documentation.
- Be sure there are no hardware conflicts such as devices in your computer trying to use the same interrupts (IRQs) or DMA channels.
- Be sure the cables connecting the external and internal SCSI devices and the host adapter are attached securely. Also be sure the pin-1 orientation is correct for internal cables. See the host adapter documentation for more information.
- Be sure that each SCSI device connected to the host adapter has a unique SCSI ID.
- Be sure CD-ROM drives and other SCSI devices are attached to a power source and are turned ON.

#### Windows95/WindowsNT Troubleshooting

**What is a miniport driver, and how do I make sure that the miniport driver is installed correctly?**

Miniport drivers are a new kind of 32bit protect mode device driver used by Windows95 and WindowsNT to control host adapters and other kinds of devices. Windows95 and WindowsNT include a set of miniport drivers for various types of SCSI host adapters. The host adapter miniport driver is automatically installed and configured during Windows95 and WindowsNT installation if your host adapter is already installed. To make sure the driver is installed correctly in systems running Windows95, open the Control Panel, double-click on System, and click the Device Manager tab. Then double-click the SCSI Controllers icon; you should see the model name of the SCSI host adapter(s) installed in your system.

**What if there is no SCSI controllers icon under Device Manager, or the model name of the SCSI chipset does not appear under Device Manager?**

If the SCSI controllers icon or your host adapter's model name do not appear, open Control Panel and double-click the Add New Hardware icon. Let Windows search for the host adapter by selecting Yes on the second screen of the Add New Hardware Wizard.

If Windows does not detect the host adapter, run the Add New Hardware Wizard again. This time, select No on the second screen of the wizard, then select SCSI controllers on the next screen. Select the name of your host adapter when it appears.

## D. ADAPTEC EZ-SCSI

---

**If the name of your SCSI chipset does not appear, you may be able to find its miniport driver on the Windows95 CD-ROM. Follow these steps:**

- 1 Place the Windows95 CD-ROM in your CDROM drive and run the Add New Hardware wizard.
- 2 Select No on the second screen, and select SCSI controllers on the next screen.
- 3 Click on the Have Disk button, then click the Browse button.
- 4 Look in the \drivers\storage directory of the CDROM and select the name of your SCSI host adapter if it appears.

**What if a yellow exclamation point or a red X appears in Device Manager in front of my host adapter?**

This means there is some kind of resource problem. First, see if the names of any host adapters appear that are not actually installed in your computer. If so, select the name and click Remove. If a red X appears in front of your host adapter name, remove all the host adapter references under SCSI Controllers and run Add New Hardware, as described in the previous question/answer. If a yellow exclamation point appears in front of your host adapter name, the resources that the driver uses probably do not match the resources used by the hardware. Double-click the host adapter name, then click on the Resource tab. Deselect the Use automatic settings box and edit the resources (Interrupt Request, Direct Memory Access, etc.) so they match those used by the host adapter. If the problem still remains, there is probably a hardware resource conflict between the host adapter and other hardware in your computer. You can fix this by changing the hardware resource settings. (See your hardware documentation.)

**What do I need to do if I want to use another host adapter?**

- 1 Open the Control Panel, double-click on System, and click the Device Manager tab.
- 2 Double-click the SCSI Controllers icon, select the name of the old host adapter, and click Remove.
- 3 Turn OFF the computer and physically remove the currently installed host adapter.
- 4 Install the new host adapter according to the instructions in the hardware documentation.
- 5 Turn the computer ON. If the new host adapter supports Plug and Play, Windows will install and configure it automatically. Otherwise, run Add New Hardware to make sure the new driver is loaded.

## D. ADAPTEC EZ-SCSI

---

### **If I am running under Windows95, do I need lines for the Adaptec real mode ASPI drivers and mscdex in my CONFIG.SYS and AUTOEXEC.BAT files?**

Usually, you do not need to use these real mode ASPI drivers, because the new Windows miniport drivers support most SCSI host adapters and SCSI devices. However, you need to load the drivers (including mscdex, if you have a CDROM drive) if any of the following is true:

- You are running in MSDOS mode
- You are using a scanner or another SCSI device with CONFIG.SYS- or AUTOEXEC.BAT-based drivers, such as HP's sjix.sys
- You have an older model SCSI-1 CDROM drive that Windows95 does not support
- You are using a CD-Recorder drive (however, some newer models of CD-Recorder drives can use the embedded Windows miniport drivers)

To install the Adaptec EZSCSI DOS drivers, click the Start button and select **Restart the computer in MS-DOS mode**. When the DOS prompt appears, follow the Quick Start instructions for DOS.

### **My CD-ROM drive doesn't work properly under Windows95.**

Some older models of SCSI CDROM drives are not compatible with the embedded Windows95 CDROM driver. You can add support for the CDROM drive by doing the following:

- 1 Click the Start button and select Restart the computer in MS-DOS mode.
- 2 When the DOS prompt appears, follow the Quick Start instructions for DOS.
- 3 When you are finished running Adaptec EZSCSI for DOS, find the file named cdttd.vxd in the windows\system\iosubsys directory and rename it cdttd.sav.

### **My CD-ROM drive shows up as more than one icon under My Computer.**

The mapping between mscdex, which runs in real mode, and the Windows95 CDROM driver does not match. You can correct this in one of two ways:

- Comment out the line that loads mscdex.exe in the AUTOEXEC.BAT file.
- Change the /L switch on the line that loads mscdex.exe in the AUTOEXEC.BAT file so it assigns the CDROM drive the next highest logical drive letter after the hard disk drives.

# D. ADAPTEC EZ-SCSI

---

## Information for DOS/Windows 3.1x Users

The following information may be useful if you install Adaptec EZSCSI on a computer running DOS, Windows 3.1x, or Windows for Workgroups3.1x.

**NOTE: The Windows95/WindowsNT Troubleshooting section on page 6 describes a few situations when you may need to use the DOS/Windows3.1x drivers and ASPI managers under Windows95 or WindowsNT.**

## DOS and Windows3.1x Device Drivers

Device drivers are software programs that enable your computer to communicate with SCSI devices such as hard disk drives, CDROM drives, and scanners. Each kind of device requires a different device driver. Adaptec EZSCSI includes several DOS/Windows3.1x device drivers that are copied to your hard disk during installation. Adaptec EZSCSI adds command lines to your CONFIG.SYS and AUTOEXEC.BAT files to load these device drivers if it finds these kinds of devices on your computer.

To learn more about the Adaptec EZSCSI device drivers, including their command line option information, see the online Adaptec EZSCSI Online Reference, a Windows Help application.

## DOS and Windows3.1x ASPI Managers

ASPI (Advanced SCSI Programming Interface) managers are software programs that enable the SCSI device drivers, your host adapter, and your SCSI devices to communicate with each other. ASPI managers are written for a specific operating system, such as DOS, and a specific family of Adaptec host adapters.

Adaptec EZSCSI includes several ASPI managers for DOS/Windows3.1x. When you install Adaptec EZSCSI on these operating systems, it detects what kind of host adapter is installed in your computer and automatically configures your system with the correct ASPI manager. To learn more about these ASPI managers, including their command line option information, see the Adaptec EZSCSI Online Reference, a Windows Help application.



# D. ADAPTEC EZ-SCSI

---

## DOS Formatting Utilities

Adaptec EZSCSI includes several DOS-based formatting utilities:

### *Low-level Formatter (scsifmt)*

Use the DOS-based scsifmt utility for low-level formatting of SCSI hard disk drives, removable media, Floptical<sup>®</sup> drives, and magneto-optical drives. You can also use it to scan a disk device for surface defects before you store data on it.

Run scsifmt from the DOS prompt, not from the Windows MSDOS prompt. Before you run it, be sure the disk devices you want to format are connected to the host adapter and that they are powered. Then follow these steps:

1. Change to the directory where scsifmt.exe is located (usually c:\scsi), type scsifmt at the DOS prompt, and press Enter.  
**NOTE:** If you are formatting a SCSI disk device that supports more than one LUN (for example, Iomega's Bernoulli dual multdrive) type scsifmt /L at the command line.
2. When the first screen appears, read it and press Enter to continue. (Press F1 at any time to view Help.) Information about your SCSI disk devices appears on the screen.
3. Use the arrow keys to move the highlight bar to a disk device you want to format or verify, then press Enter.
4. When the next screen appears, select either Format or Verify (to verify that the disk is free of surface defects), then press Enter.

**WARNING!** Back up important data before you format the disk device!  
A low-level format erases all data from the disk.

5. If you select Format, confirm that you want to format the disk, then wait while the disk device is formatted. This may take a long time if the disk is large.  
If you select Verify, you can press Esc at any time to stop the verification process. (This does not damage the disk.) If the utility finds bad blocks on the disk, it displays information about them. You can reassign the bad block(s) to prevent data from being stored there.
6. Repeat steps 3, 4, and 5, as needed, to format or verify other disk devices. When you are finished, press Esc to exit.

## D. ADAPTEC EZ-SCSI

---

### *Formatter and Partitioner (afdisk)*

Use the DOS-based afdisk utility to partition and format SCSI hard disk drives, Floptical drives, and magneto-optical drives. You can also use afdisk to remove DOS and non-DOS partitions from a disk drive and to format removable media in standard hard disk format, OS/2 floppy format, or DOS V (Japanese) format.

**NOTE:** Use afdisk only if the disk device is not controlled by the host adapter BIOS—that is, if the host adapter does not have a BIOS or if its BIOS is not enabled. If the disk device is controlled by the host adapter BIOS, use the DOS fdisk utility to partition and format the disk device. (See the MSDOS documentation.)

Run afdisk from the DOS prompt only, not from the Windows MSDOS prompt. Before you run it, be sure the disk devices you want to format and partition are connected to the host adapter and that they are powered. Then follow these steps:

1. Change to the directory where afdisk.exe is located (usually c:\scsi), type afdisk at the DOS prompt, and press Enter.

Information about your SCSI disk devices appears on the screen. (The number that appears after Target is the device's SCSI ID.)

2. Use the arrow keys to move the highlight bar to the disk device you want to partition, then press Enter.
  - If the selected disk device is controlled by the host adapter BIOS, you can view information about it but you cannot partition it with afdisk (Use the DOS fdisk and format utilities.)
  - If the selected disk device is unpartitioned, you must partition it before you can format it. To do this, follow the instructions on the screen. (Press F1 to see an explanation of the partitioning options.)

Information about the selected disk device appears in the lower left of the screen. Disks smaller than 1 Gigabyte have 64 heads, 32 sectors per track, and cylinders equal to the number of MB of available capacity. Disks larger than 1 Gigabyte have 255 heads, 63sectors per track, and one cylinder per 8 MB of available capacity.

## D. ADAPTEC EZ-SCSI

- To create a new partition on the disk device, press Ins. A screen similar to this appears:

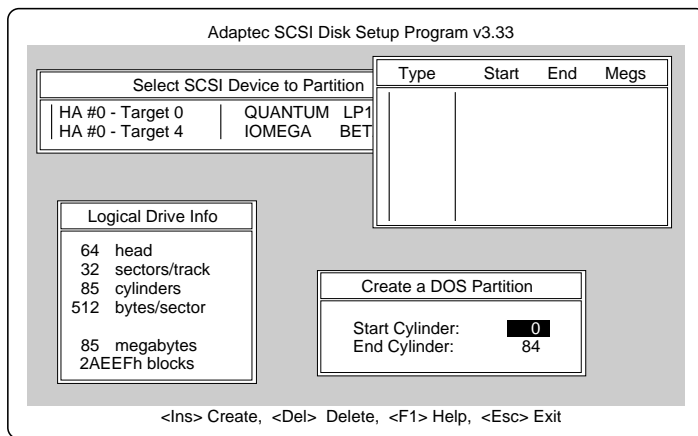

The Create a DOS Partition window suggests that you create one partition on the disk device, equal to its entire capacity. If this is what you want to do, skip to step 5.

- To change the size of the partition, use the arrow keys to select Start Cylinder and End Cylinder, and type in the numbers you want. Partitions up to 2Gigabytes are supported.
- When the number of cylinders is what you want, press Esc. When the confirmation prompt appears, select Yes and press Enter to create the partition.

To create more partitions on the same disk device, repeat steps 3, 4, and 5. As you create partitions on the disk, they are added to the window at the upper right of the screen, as shown here:

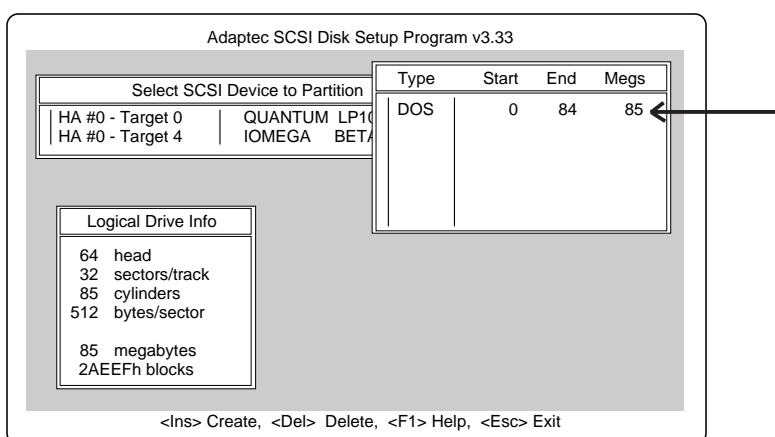

- Press Esc to return to the Select SCSI Device to Partition window. If you want to partition a different disk device, select the device from the list and repeat the earlier steps.
- To quit afdisk, press Esc and select Yes to confirm that you want to quit.

## E. DMI Utility

---

### Desktop Management Interface (DMI)

#### *Introducing the ASUS DMI Configuration Utility*

This motherboard supports DMI within the BIOS level and provides a DMI Configuration Utility to maintain the Management Information Format Database (MIFD). DMI is able to auto-detect and record information pertinent to a computer's system such as the CPU type, CPU speed, and internal/external frequencies, and memory size. The onboard BIOS will detect as many system information as possible and store those collected information in a 4KB block in the motherboard's Flash EPROM and allow the DMI to retrieve data from this database. Unlike other BIOS software, the BIOS on this motherboard uses the same technology implemented for Plug and Play to allow dynamic real-time updating of DMI information versus creating a new BIOS image file and requiring the user to update the whole BIOS. This DMI Configuration Utility also allows the system integrator or end user to add additional information into the MIFD such as serial numbers, housing configurations, and vendor information. Those information not detected by the motherboard BIOS and has to be manually entered through the DMI Configuration Utility and updated into the MIFD. This DMI Configuration Utility provides the same reliability as PnP updating and will prevent the refreshing failures associated with updating the entire BIOS.

#### *System Requirements*

The DMI Configuration Utility (DMICFG2.EXE) must be used in real mode in order for the program to run, the base memory must be at least 180K. Memory managers like HIMEM.SYS (required by windows) must not be installed. You can boot up from a system diskette without AUTOEXEC.BAT and CONFIG.SYS files, "REM" HIMEM.SYS in the CONFIG.SYS, or press <F5> during bootup to bypass your AUTOEXEC.BAT and CONFIG.SYS files.

# E. DMI Utility

## Using the ASUS DMI Configuration Utility

**NOTE:** The following screen displays are provided as examples only and may not reflect the screen contents on your system.

### Edit DMI (or delete)

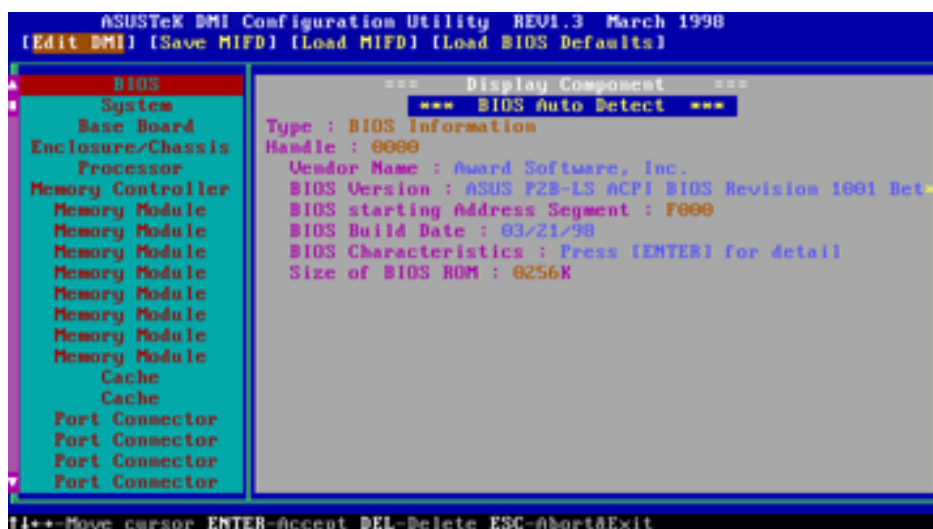

Use the ←→ (left-right) cursors to move the top menu items and the ↑↓ (up-down) cursor to move between the left hand menu items. The bottom of the screen will show the available keys for each screen. Press enter at the menu item to enter the right hand screen for editing. “Edit component” appears on top. The reversed color field is the current cursor position and the blue text are available for editing. The orange text shows auto-detected information and are not available for editing. The blue text “Press [ENTER] for detail” contains a second pop-up menu is available, use the + - (plus-minus) keys to change the settings. Enter to exit *and save*, ESC to exit *and not save*.

If the user has made changes, ESC will prompt you to answer Y or N. Enter Y to go back to the left-hand screen *and save*, enter N to go back to left-hand screen and *not save*. If editing has not been made, ESC will send you back to the left hand menu without any messages.

### Notes

A heading, \*\*\* BIOS Auto Detect \*\*\* appears on the right for each menu item on the left side that has been auto detected by the system BIOS.

A heading, \*\*\* User Modified \*\*\* will appear on the right for menu items that have been modified by the user.



# E. DMI Utility

## Save MIFD

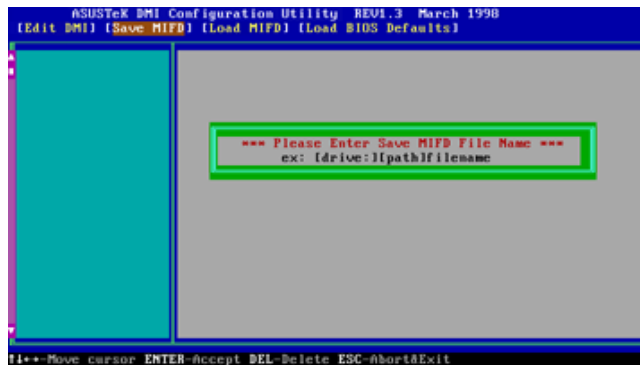

You can save the MIFD (normally only saved to flash ROM) to a file by entering the drive and path here. If you want to cancel save, you may press ESC and a message “Bad File Name” appears here to show it was not saved.

## Load MIFD

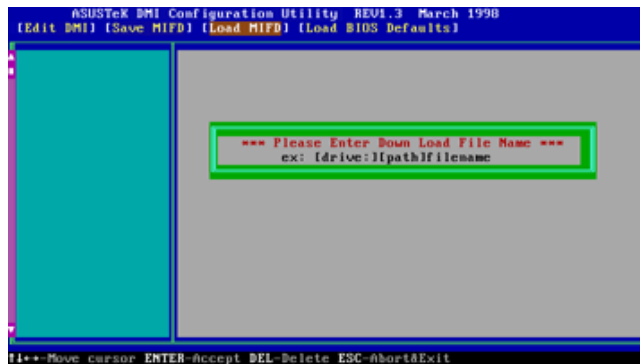

You can load the disk file to memory by entering a drive and path and file name here.

## Load BIOS Defaults

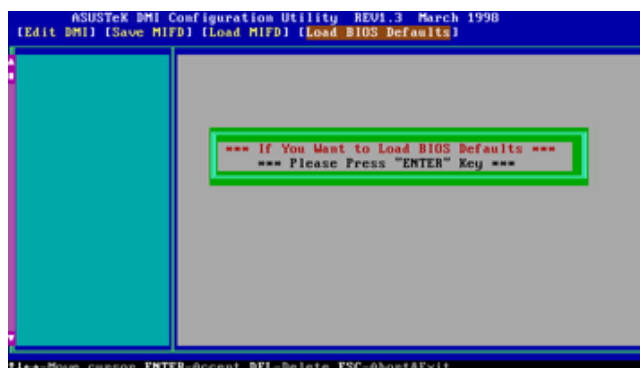

You can load the BIOS defaults from a MIFD file and can clear all user modified and added data. You must reboot your computer in order for the defaults to be saved back into the Flash BIOS.

# F. ASUS LAN Card

## ASUS PCI-L101 Fast Ethernet Card

F. ASUS LAN Card  
PCI-L101 LAN Card

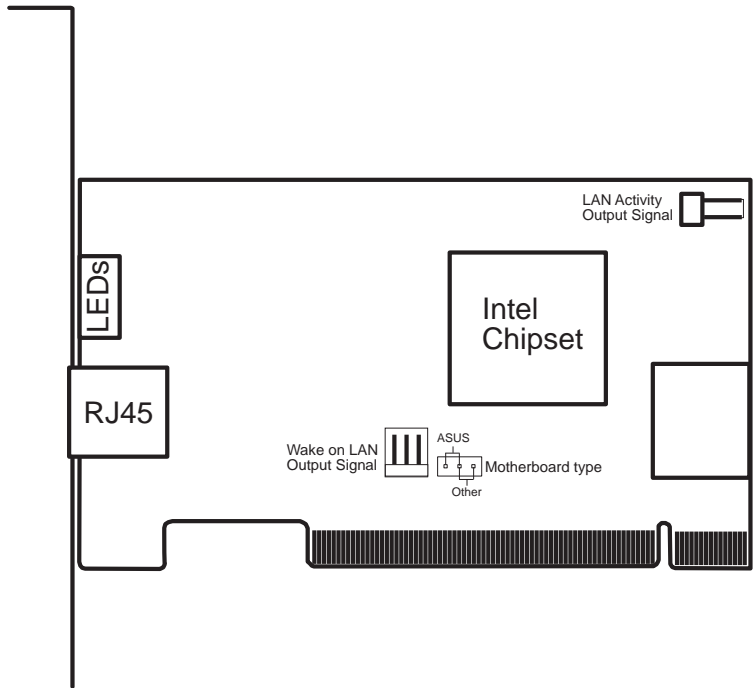
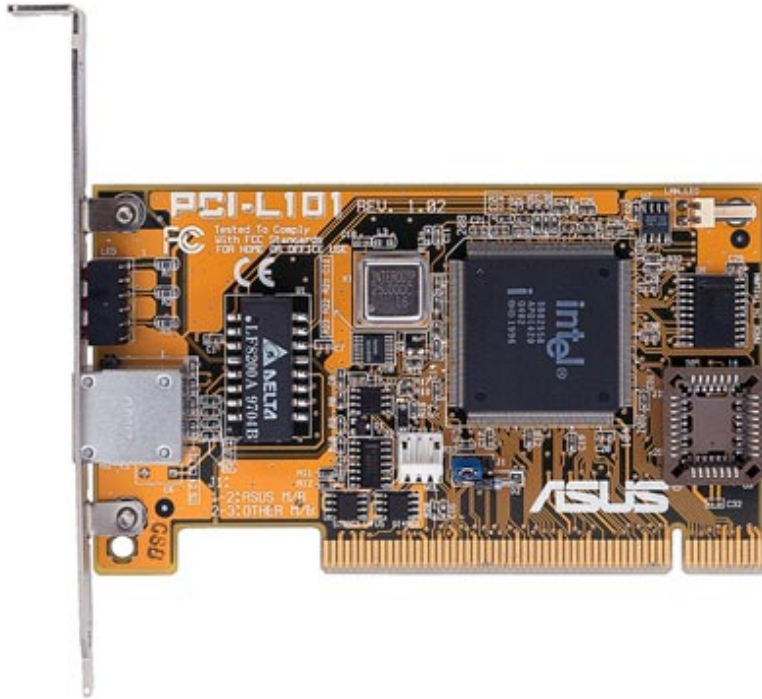

If you are using the ASUS PCI-L101 on an ASUS motherboard, leave the jumper on its default setting of “ASUS.” If you are using another brand of motherboard, set the jumper to “Other.” Connect the Wake on LAN (WOL) output signal to the motherboard’s WOL\_CON in order to utilize the wake on LAN feature of the motherboard. Connect the LAN activity output signal (LAN\_LED) to the system cabinet’s front panel LAN\_LED in order to display the LAN data activity.

# F. ASUS LAN Card

---

## Features

- Intel 82558 Ethernet LAN Controller (Fully integrated 10BASE-T/100BASE-TX)
- Wake-On-LAN Remote Control Function Supported
- PCI Bus Master Complies to PCI Local Bus Rev. 2.1 specifications
- Consists of MAC & PHY (10/100Mbps) interfaces
- Complies to IEEE 802.3 10BASE-T and IEEE 802.3u 100BASE-TX interfaces
- Fully supports 10BASE-T & 100BASE-TX operations through a single RJ45 port
- Supports 32-bit Bus Master Technology / PCI Rev. 2.1
- Enhancements on ACPI & APM
- Adheres to PCI Bus Power Management Interface Rev. 1.0, ACPI Rev. 1.0, and Device Class Power Management Rev. 1.0
- IEEE 802.3u auto-negotiation for 10Mbps/100Mbps Network Data Transfer Rates.
- Provides LED indicators for monitoring network conditions
- Plug and Play

## Software Driver Support

- **NetWare ODI Drivers** - Novell Netware 3.x, 4.x, DOS, OS/2 Client
- **NDIS 2.01 Drivers** - Microsoft LAN Manager, Microsoft Windows 3.11, IBM LAN Server
- **NDIS 3.0 Drivers** - Microsoft Windows NT, Microsoft Windows 95, Microsoft Windows 3.11

## Question and Answer

Q: What is Wake-On-LAN ?

A: The Wake-On-LAN feature provides the capability to remotely power on systems supporting Wake-On-LAN by simply sending a wake-up frame. With this feature, remotely uploading/downloading data to/from systems during off-peak hours will be feasible.

Q: What can Wake-On-LAN do for you ?

A: Wake-On-LAN is a remote management tool with advantages that can reduce system management workload, provide flexibility to the system administrator's job, and then of course save you time-consuming efforts and costs.

Q: What components does Wake-On-LAN require to be enable?

A: To enable Wake-On-LAN function, your system requires Ethernet LAN adapter card that can activate Wake-On-LAN function, a client with Wake-On-LAN capability, and software such as LDCM Rev. 3.10 or up that can trigger wake-up frame.