

MX3S-U

MX3SP-U

Online Manual

DOC. NO.: MX3SPU-OL-00108A

Overview

Hardware
Installation

Drivers &
Utilities

AWARD
BIOS Setup

Glossary

Troubleshooting &
Technical Support

What's in this manual

MX3S-U / MX3SP-U	1
<i>What's in this manual</i>	<i>2</i>
<i>You Must Notice</i>	<i>8</i>
<i>Before You Start</i>	<i>9</i>
<i>Overview</i>	<i>10</i>
<i>Feature Highlight.....</i>	<i>11</i>
<i>Quick Installation Procedure</i>	<i>15</i>
<i>Motherboard Map</i>	<i>16</i>
<i>Block Diagram</i>	<i>17</i>
Hardware Installation.....	18
<i>About "Optional" and "Upgrade Optional".....</i>	<i>19</i>
<i>JP14 Clear CMOS Data</i>	<i>20</i>
<i>CPU Installation</i>	<i>21</i>
<i>JPX2 EEPROM Select Jumper</i>	<i>24</i>
<i>CPU Jumper-less Design.....</i>	<i>25</i>
<i>CPU Fan Connector (with H/W Monitoring).....</i>	<i>29</i>
<i>DIMM Sockets</i>	<i>30</i>
<i>Support 10/100 Mbps LAN onboard</i>	<i>32</i>



<i>Front Panel Connector</i>	33
<i>ATX Power Connector</i>	34
<i>AC Power Auto Recovery</i>	34
<i>IDE and Floppy Connector</i>	35
<i>IrDA Connector</i>	37
<i>AGP (Accelerated Graphic Port) Expansion Slot</i>	38
<i>CNR (Communication and Network Riser) Expansion Slot</i>	39
<i>PC99 Color Coded Back Panel</i>	40
<i>Support 2nd USB Port</i>	41
<i>Chassis Intrusion Sensor</i>	42
<i>CD Audio Connector</i>	43
<i>Modem Audio Connector</i>	44
<i>Front Audio Connector</i>	45
<i>Battery-less and Long Life Design</i>	46
<i>Over-current Protection</i>	47
<i>Hardware Monitoring</i>	48
<i>Resettable Fuse</i>	49
<i>Year 2000 (Y2K)</i>	50
<i>1500 / 2200μF Low ESR Capacitor</i>	52



<i>Layout (Frequency Isolation Wall)</i>	54
<i>Pure Aluminum Heatsink</i>	55
Driver and Utility	56
<i>Auto-run Menu from Bonus CD Disc</i>	57
<i>Installing Intel® Chipset Software Installation Utility</i>	58
<i>Installing Onboard AGP Driver</i>	59
<i>Installing LAN Driver</i>	60
<i>Installing Ultra ATA/100 IDE Driver</i>	61
<i>Installing Onboard Sound Driver</i>	62
<i>ACPI Suspend to Hard Drive</i>	63
<i>ACPI Suspend to RAM (STR)</i>	67
AWARD BIOS	69
<i>About BIOS Function Description</i>	70
<i>How To Use Award™ BIOS Setup Program</i>	71
<i>How To Enter BIOS Setup</i>	73
<i>BIOS Upgrade</i>	74
Overclocking	76
<i>VGA Card & Hard Disk</i>	77
Glossary	78

<i>AC97</i>	78
<i>ACPI (Advanced Configuration & Power Interface)</i>	78
<i>AGP (Accelerated Graphic Port)</i>	78
<i>AMR (Audio/Modem Riser)</i>	79
<i>Bonus Pack CD</i>	79
<i>APM (Advanced Power Management)</i>	79
<i>ATA (AT Attachment)</i>	79
<i>ATA/66</i>	79
<i>ATA/100</i>	80
<i>BIOS (Basic Input/Output System)</i>	80
<i>Bus Master IDE (DMA mode)</i>	80
<i>CNR (Communication and Networking Riser)</i>	80
<i>CODEC (Coding and Decoding)</i>	81
<i>DDR (Double Data Rated) SDRAM</i>	81
<i>DIMM (Dual In Line Memory Module)</i>	81
<i>DMA (Direct Memory Access)</i>	81
<i>ECC (Error Checking and Correction)</i>	82
<i>EDO (Extended Data Output) Memory</i>	82
<i>EEPROM (Electronic Erasable Programmable ROM)</i>	82

EPROM (Erasable Programmable ROM)..... 82

EV6 Bus..... 83

FCC DoC (Declaration of Conformity)..... 83

FC-PGA (Flip Chip-Pin Grid Array)..... 83

Flash ROM 83

FSB (Front Side Bus) Clock..... 84

I²C Bus..... 84

IEEE 1394..... 84

Parity Bit..... 84

PBSRAM (Pipelined Burst SRAM) 85

PC-100 DIMM 85

PC-133 DIMM..... 85

PC-1600 or PC-2100 DDR DRAM 85

PCI (Peripheral Component Interface) Bus..... 85

PDF Format 86

PnP (Plug and Play) 86

POST (Power-On Self Test)..... 86

RDRAM (Rambus DRAM)..... 86

RIMM (Rambus Inline Memory Module)..... 87



SDRAM (Synchronous DRAM) 87

Shadow E²PROM 87

SIMM (Single In Line Memory Module) 87

SMBus (System Management Bus) 88

SPD (Serial Presence Detect) 88

Ultra DMA 88

USB (Universal Serial Bus) 89

VCM (Virtual Channel Memory) 89

ZIP file 89

Troubleshooting **90**

Technical Support **94**

You Must Notice



Adobe, the Adobe logo, Acrobat is trademarks of Adobe Systems Incorporated.

AMD, the AMD logo, Athlon and Duron are trademarks of Advanced Micro Devices, Inc.

Intel, the Intel logo, Intel Celeron, Pentium II, Pentium III are trademarks of Intel Corporation.

Microsoft, Windows, and Windows logo are either registered trademarks or trademarks of Microsoft Corporation in the United States and/or other countries.

All product and brand names used on this manual are used for identification purposes only and may be the registered trademarks of their respective owners.

All of the specifications and information contained in this manual are subject to change without notice. We reserves the right to revise this publication and to make reasonable changes. We assumes no responsibility for any errors or inaccuracies that may appear in this manual, including the products and software described in it.

This documentation is protected by copyright law. All rights are reserved.

No part of this document may be used or reproduced in any form or by any means, or stored in a database or retrieval system without prior written permission from our Corporation.

Copyright® 1996-2000, Inc. All Rights Reserved.

Before You Start



This Online Manual will introduce to the user how this product is installed. All useful information will be described in later chapters. Please keep this manual carefully for future upgrades or system configuration changes. This Online Manual is saved in [PDF format](#), we recommend using Adobe Acrobat Reader 4.0 for online viewing, it is included in [Bonus CD disc](#) or you can get free download from [Adobe web site](#).

Although this Online Manual is optimized for screen viewing, it is still capable for hardcopy printing, you can print it by A4 paper size and set 2 pages per A4 sheet on your printer. To do so, choose **File > Page Setup** and follow the instruction of your printer driver.

Thanks for the help of saving our earth.

Overview

Thank you for choosing our MX3S-U/MX3SP-U motherboard. The MX3S-U/MX3SP-U is Intel® Socket 370 motherboard (M/B) based on the MTX form factor featuring the [Intel® 815E B-Step / 815EP B-Step chipset](#). As high performance chipset built in the M/B, the MX3S-U/MX3SP-U motherboard can support Intel® Socket 370 series Pentium® III & Celeron™ processor (Both Coppermine & Tualatin are supported) and 66/100/133MHz [Front Side Bus \(FSB\)](#) clock. In the AGP performance, it has one AGP slot and supports AGP 1X/2X/4X mode and pipelined spilt-transaction long burst transfer up to 1056MB/sec. According to different customer's requirements, 32, 64, 128, 256 and 512MB SDRAM DIMM modules can be applied to the motherboard and the maximum memory size can be up to 512MB. The onboard IDE controller supports [Ultra DMA 33/66/100](#) mode and the transfer rate up to 100MB/s. Further flexibility can be achieved by taking advantage of the [Communication and Network Riser \(CNR\)](#) card option that allows audio, modem, and/or LAN configuration on a single baseboard design. In addition, on the strength of Intel 82562ET/EM PHY on board, which is an highly-integrated Platform LAN Connect device, it provides 10/100M bps Ethernet for office and home use. More than that, the MX3S-U/MX3SP-U has an AD 1885 [AC97 CODEC](#) chipset onboard for providing high performance and magic surround stereo sound to let people enjoy working with it. Now, enjoy all features from our MX3S-U/MX3SP-U motherboard.

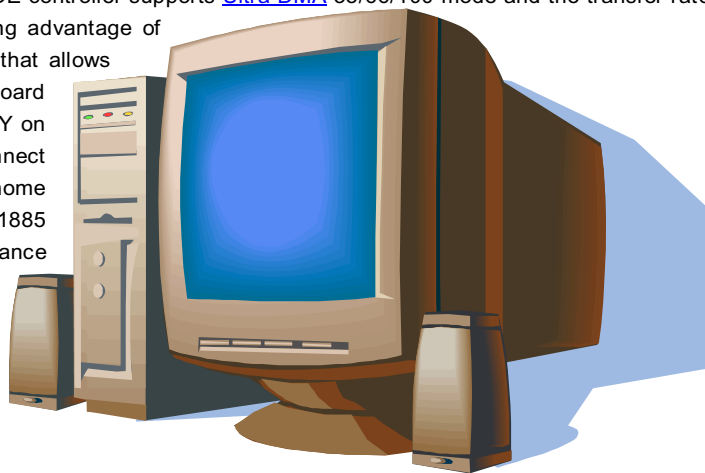

Feature Highlight

CPU

Supports Intel® Socket 370 Pentium® III & Celeron™ (Both Coppermine & Tualatin are supported) 533MHz~1.2GHz+ with 66/100/133MHz [Front Side Bus \(FSB\)](#) designed for Socket 370 technology. To avoid possible CPU damage caused by overheating, an automatic shutdown of system had been especially designed on this motherboard. System would be automatically power off when this motherboard with implementation of THERMTRIP circuit detected a CPU temperature above 135 degree for 4 seconds.

Chipset

With the Intel® 815E B-Step/815EP B-Step chipset, Intel delivers a discrete graphics solution with all the performance, innovative features and proven reliability of the Intel® 815 chipset family. With its highly scalable design, the new 815E B-Step/815EP B-Step chipset offers an ideal, leading-edge AGP graphics solution for Intel® Pentium® III/Celeron™ processor platforms. And the smart integration in the Intel 815E B-Step/815EP B-Step chipset's I/O Controller Hub (ICH2) features two USB controllers supporting four USB ports. With support for 5.1 channels of AC'97 audio and the ability to make the most of soft audio/modem technology, the 815E B-Step/815EP B-Step chipset delivers an ideal solution for innovative new form factors.

Expansion Slots

Including three 32-bit/33MHz PCI, one CNR and one AGP 4X slots. The [PCI](#) local bus throughput can be up to 132MB/s. The [Communication & Networking Riser \(CNR\)](#) slot provided from MX3S-U/MX3SP-U can support CNR interface for a Modem/Audio card. The [Accelerated Graphics Port \(AGP\)](#) specification provides a new level of video display sophistication and speed. The AGP video cards support data transfer rate up to 1056MB/s. MX3S-U/MX3SP-U motherboard includes one AGP expansion slot for a bus mastering AGP graphic card. For AD and SBA signaling, MX3S-U/MX3SP-U motherboard can support 2X/4X mode. Of three PCI slots provided, all of them are master PCI slots with arbitration and decoding for all integrated functions and LPC bus.

Memory

Provides three 168-pin [SDRAM](#) DIMM sockets that support up to 512MB of [PC-100/133](#) compliant SDRAM (Synchronous Dynamic Random Access Memory). You may install 32, 64, 128, 256 and 512MB SDRAM DIMM modules into each socket.

Ultra DMA 33/66/100 Bus Master IDE

Comes with an on-board PCI Bus Master IDE controller with two connectors that supports four IDE devices in two channels, supports [Ultra DMA](#) 33/66/100, PIO Modes 3 and 4 and Bus Master IDE DMA Mode 4, and supports Enhanced IDE devices.

On-board AC'97 Sound

MX3S-U/MX3SP-U uses the AD 1885 [AC97](#) sound chip. This on-board audio includes a complete audio recording and playback system.

LAN Port

On the strength of Intel 82562ET/EM PHY on board, which is an highly-integrated Platform LAN Connect device, it provides 10/100 Mbps Ethernet for office and home use.

Four USB Connectors

Provides two ports, four [USB](#) connectors for USB interface devices, such as mouse, keyboard, modem, scanner, etc.

Power Management/Plug and Play

Supports the power management function that confirms to the power-saving standards of the U.S. Environmental Protection Agency (EPA) Energy Star program. It also offers [Plug-and-Play](#), which helps save users from configuration problems, thus making the system much user-friendlier.

Hardware Monitoring Management

Supports CPU or system fans status, temperature and voltage monitoring and alert, through the on-board hardware monitor module.

Enhanced ACPI

Fully implement the [ACPI](#) standard for Windows[®] 98/ME/2000 series compatibility, and supports Soft-Off, STR (Suspend to RAM, S3), STD (Suspend to Disk, S4) features.

Super Multi-I/O

Provides two high-speed UART compatible serial ports and one parallel port with EPP and ECP capabilities. UART can also be directed from COM1 to the Infrared Module for the wireless connections.

Quick Installation Procedure

This page gives you a quick procedure on how to install your system. Follow each step accordingly.

1. Installing [CPU and Fan](#)
2. [Installing System Memory \(DIMM\)](#)
3. [Connecting Front Panel Cable](#)
4. [Connecting IDE and Floppy Cable](#)
5. [Connecting ATX Power Cable](#)
6. [Connecting Back Panel Cable](#)
7. [Power-on and Load BIOS Setup Default](#)
8. [Setting CPU Frequency](#)
9. Reboot
10. Installing Operating System (such as Windows 98)
11. [Installing Driver and Utility](#)

Motherboard Map

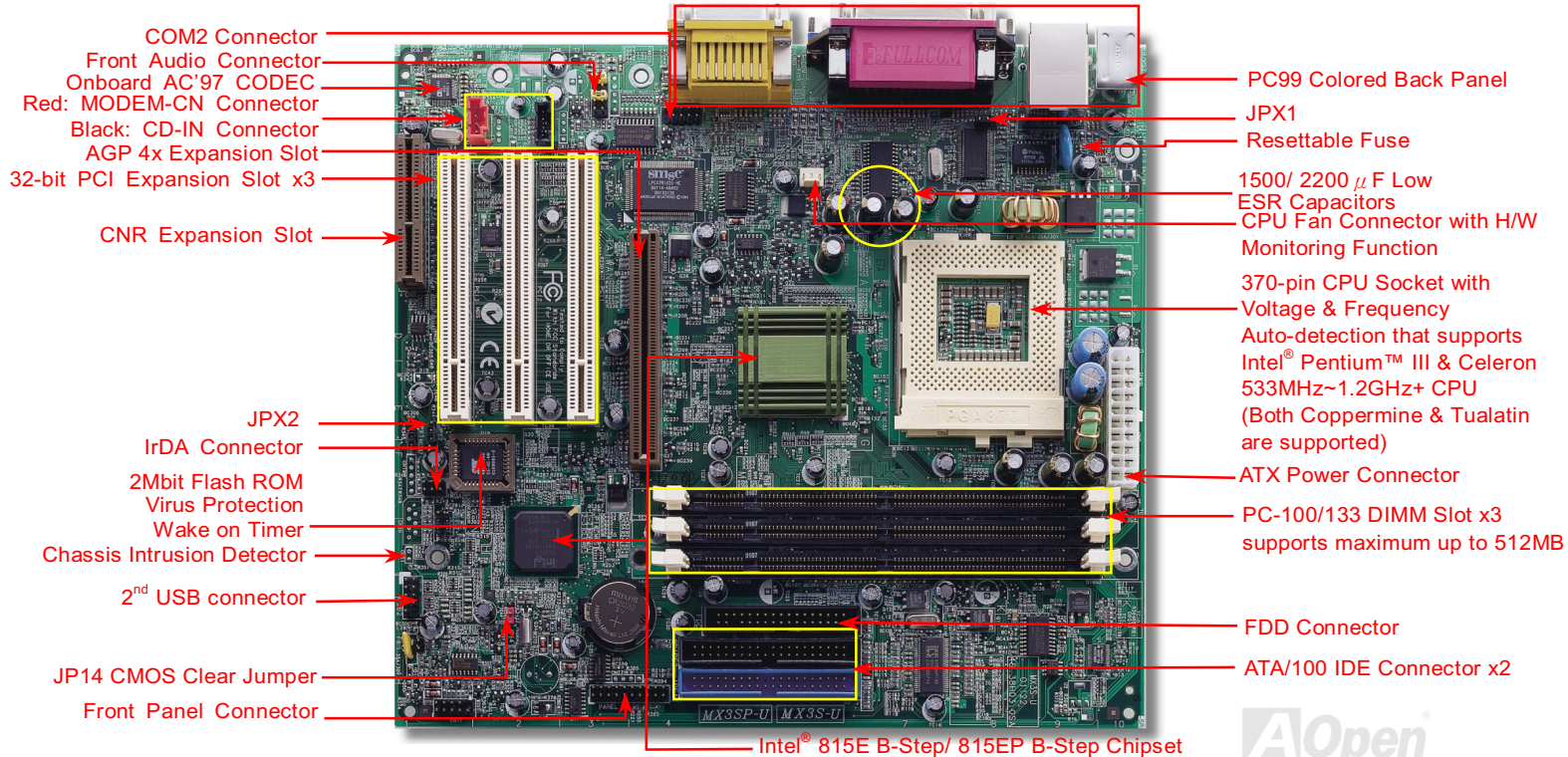

with enlarged Aluminum Heatsink



Block Diagram

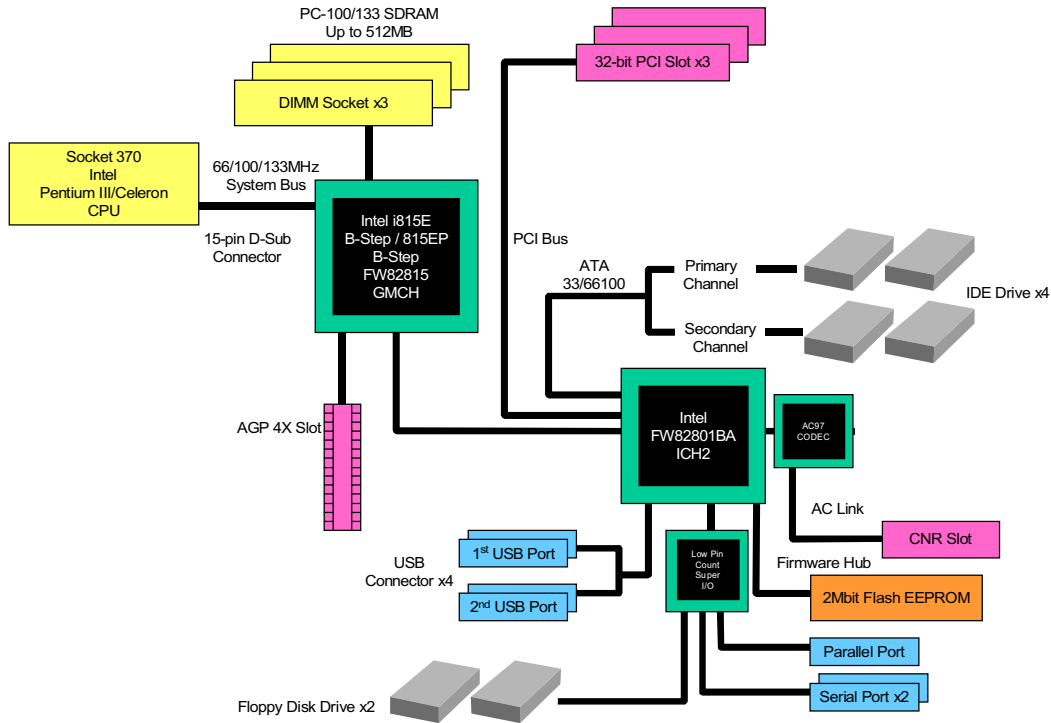

Hardware Installation

This chapter describes jumpers, connectors and hardware devices of this motherboard.



Note: *Electrostatic discharge (ESD) can damage your processor, disk drives, expansion boards, and other components. Always observe the following precautions before you install a system component.*

1. *Do not remove a component from its protective packaging until you are ready to install it.*
2. *Wear a wrist ground strap and attach it to a metal part of the system unit before handling a component. If a wrist strap is not available, maintain contact with the system unit throughout any procedure requiring ESD protection.*

About “Optional” and “Upgrade Optional”...

When you read this online manual and start to assemble your computer system, you may find some of functions are called “Optional”, and some are called “Upgrade Optional”. Though all of our motherboards include many amazing and powerful features, but in some situations, these powerful features are not used to every user. Hence, some of these key features are changed optional for you choose. Optional functions that can be upgraded by users, we call them “Upgrade Optional”. As for those optional functions that can't be upgraded by yourself, we call them “Optional”. If needed, you can contact our local distributors or resellers for purchasing “Upgrade Optional” components, and either you can visit our official web site for more detail information.



JP14 Clear CMOS Data

You can clear CMOS to restore system default setting. To clear the CMOS, follow the procedure below.

1. Turn off the system and unplug the AC power.
2. Remove ATX power cable from connector PWR2.
3. Locate JP14 and short pins 2-3 for a few seconds.
4. Return JP14 to its normal setting by shorting pins 1 & pin2.
5. Connect ATX power cable back to connector PWR2.

Pin 1

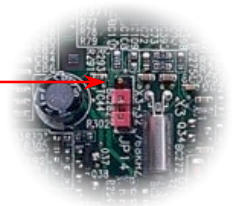

Normal
(default)



Clear CMOS

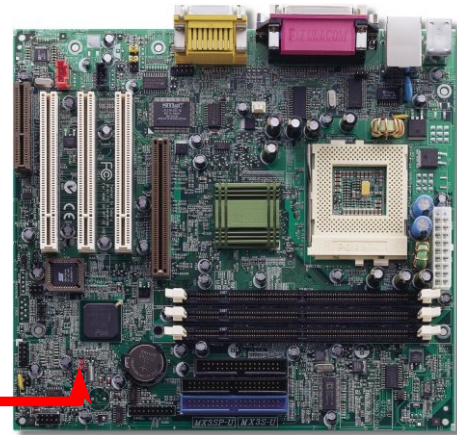

Tip: When should I Clear CMOS?

1. Boot fail because of overclocking...
2. Forget password...
3. Troubleshooting...

CPU Installation

This motherboard supports Intel® Pentium III® and Celeron™ Socket 370 series CPU (Both Coppermine & Tualatin are supported). Be careful of CPU orientation when you plug it into CPU socket.

1. Pull up the CPU socket lever and up to 90-degree angle.

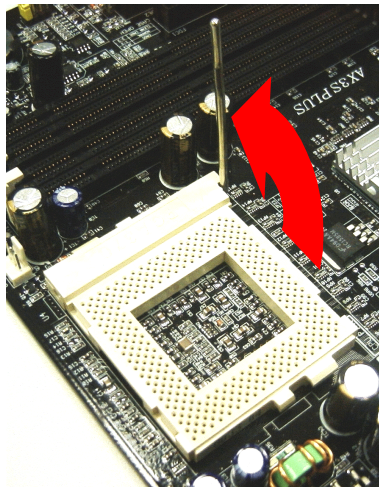

2. Locate Pin 1 in the socket and look for a black dot or cut edge on the CPU upper interface. Match Pin 1 and cut edge, then insert the CPU into the socket.

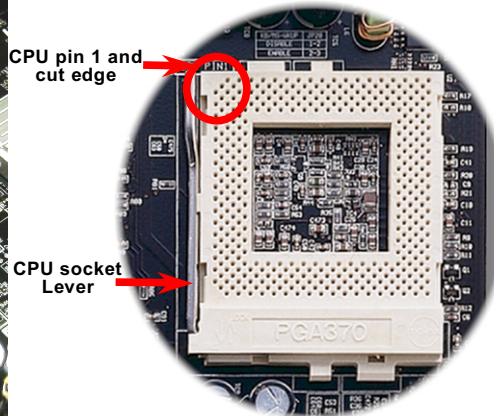

Note: These pictures are for example only, it may not exactly be the same motherboard.

3. Press down the CPU socket lever and finish CPU installation.

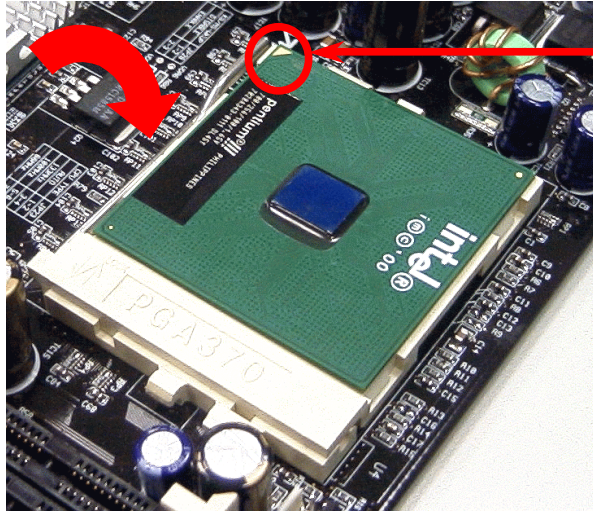

CPU cut edge

Note: If you do not match the CPU socket Pin 1 and CPU cut edge well, it may damage the CPU.

Note: This socket supports FC-PGA/FC-PGA2 package CPU, which is the latest CPU package developed by Intel, we strongly recommend you not to insert former PPGA-package CPU onto it.

Note: This picture is for example only, it may not exactly be the same motherboard.

JPX1 Onboard LAN Enable/Disable Jumper

This motherboard provides onboard LAN enable/disable function. You can use the JPX1 to enable or disable this function.

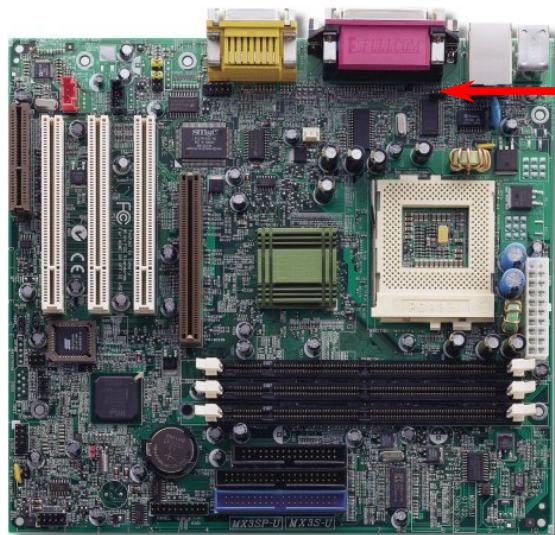

Pin 1

JPX1

LAN Select Jumper



Enable
(Default)



Disable

JPX2 EEPROM Select Jumper

This jumper is used to activate either the EEPROM chipset on CNR card or the onboard EEPROM chipset. With onboard LAN equipped on this motherboard, you may short pins 1-2 to enable the onboard EEPROM for running onboard LAN. However, if you were to use CNR card to run LAN, you may short pins 2-3 to disable the onboard EEPROM chipset.

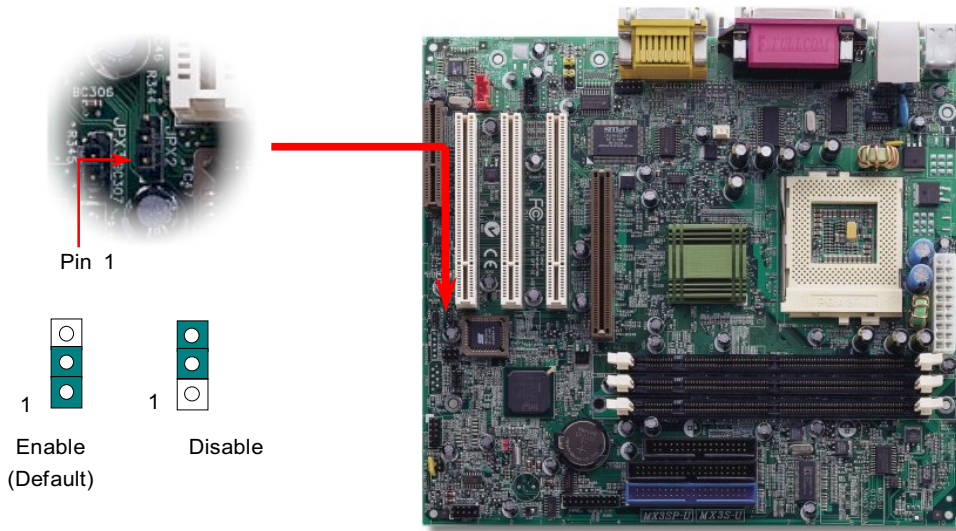

CPU Jumper-less Design

CPU VID signal and [SMBus](#) clock generator provide CPU voltage auto-detection and allows the user to set the CPU frequency through the [BIOS setup](#), therefore no jumpers or switches are used. The disadvantages of the Pentium based jumper-less designs are eliminated. There will be no worry of wrong CPU voltage detection.

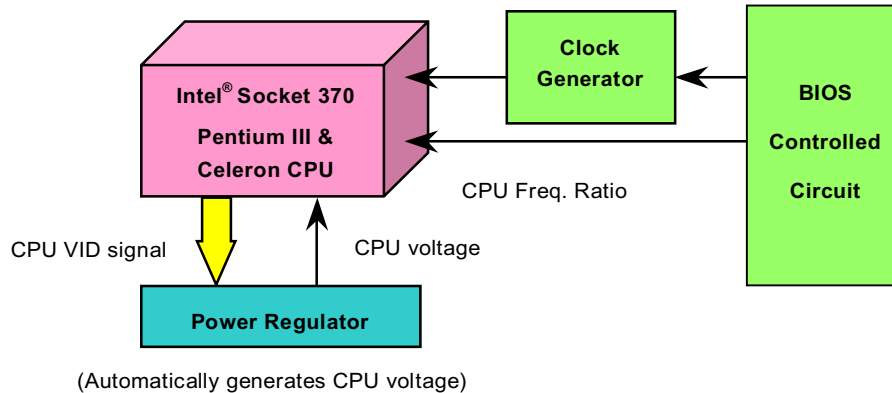

Full-range Auto-Detect CPU Core Voltage

This motherboard supports CPU VID function. The CPU core voltage will be automatically detected and the range is from 1.05V to 1.825V. It is not necessary to set CPU core voltage.

Setting CPU Frequency

CPU frequency can be set through BIOS setup.

BIOS Setup > Frequency/Voltage Control > CPU Clock Setting

CPU Ratio	3x, 3.5x, 4x, 4.5x, 5x, 5.5x, 6x, 6.5x, 7x, 7.5x, 8x, 8.5x, 9x, 9.5x, 10x, 10.5x, 11x, 11.5x, and 12x
CPU FSB (By BIOS table)	66, 67, 68, 70, 75, 80, 83, 100, 103, 110, 115, 133, 137, 140, 145, 150, 160, and 166 MHz

Warning: Intel® 815E B-Step / 815EP B-Step chipset supports maximum 133MHz FSB and 66MHz AGP clock, higher clock setting may cause serious system damage.

Supported CPU Frequency

Core Frequency = CPU FSB Clock * CPU Ratio

PCI Clock = CPU FSB Clock / Clock Ratio

AGP Clock = PCI Clock x 2

Note: This motherboard support CPU auto-detection function. Hence, you don't need to setup the CPU frequency manually.

CPU	CPU Core Frequency	FSB Clock	Ratio
Celeron 533	533MHz	66MHz	8x
Celeron 566	566MHz	66MHz	8.5x
Celeron 600	600MHz	66MHz	9x
Celeron 667	667MHz	66MHz	10x
Celeron 700	700MHz	66MHz	10.5
Pentium III 500E	500MHz	100MHz	5x
Pentium III 600E	600MHz	100MHz	6x
Pentium III 650E	650MHz	100MHz	6.5x
Pentium III 700E	700MHz	100MHz	7x
Pentium III 750E	750MHz	100MHz	7.5
Pentium III 800E	800MHz	100MHz	8x
Pentium III 850E	850MHz	100MHz	8.5x
Pentium III 533EB	533MHz	133MHz	4x
Pentium III 600EB	600MHz	133MHz	4.5x

Pentium III 667EB	667MHz	133MHz	5x
Pentium III 733EB	733MHz	133MHz	5.5
Pentium III 800EB	800MHz	133MHz	6x
Pentium III 866EB	866MHz	133MHz	6.5
Pentium III 933EB	933MHz	133MHz	7x
Pentium III 1G	1GHz	133MHz	7.5x
Pentium III 1.13G	1.13GHz	133MHz	8.5x
Pentium III 1.2G	1.2GHz	133MHz	9x

Warning: Intel® 815E B-Step / 815EP B-Step chipset supports maximum 133MHz FSB and 66MHz AGP clock, higher clock setting may cause serious system damage.

Warning: To avoid possible CPU damage caused by overheating, an automatic shutdown of system had been especially designed on this motherboard. System would be automatically power off when this motherboard with implementation of THERMTRIP circuit detected a CPU temperature above 135 degree for 4 seconds.

CPU Fan Connector (with H/W Monitoring)

Plug in the CPU fan cable to the 3-pin CPU FAN connector.

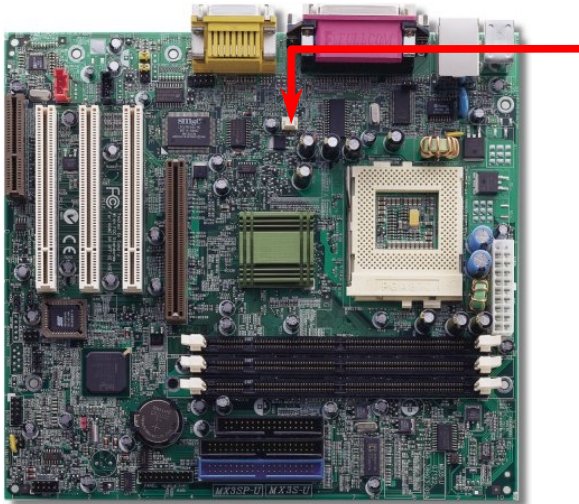

CPU Fan Connector

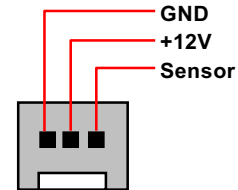

Note: Some CPU fans do not have sensor pin, so that cannot support hardware monitoring function. Please note the FAN3 connector does not support H/W monitoring function.

DIMM Sockets

This motherboard has three 168-pin [DIMM](#) sockets that allow you to install [PC100](#) or [PC133](#) memory up to 512MB.

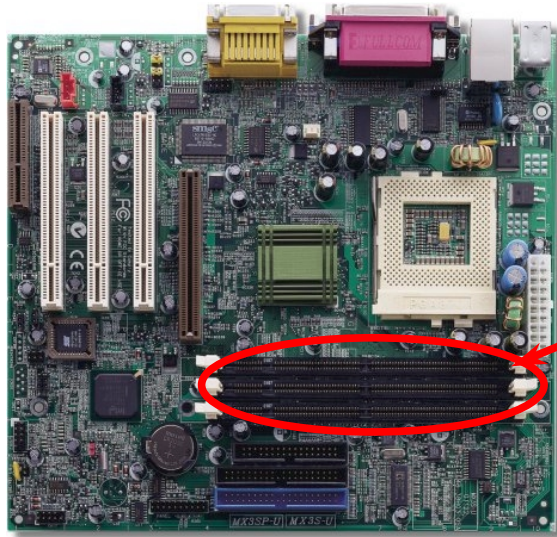

DIMM1
DIMM2
DIMM3

How to Install Memory Modules

Please follow the procedure as shown below to finish memory installation.

1. Make sure the DIMM module's pin face down and match the socket's size as depicted below.

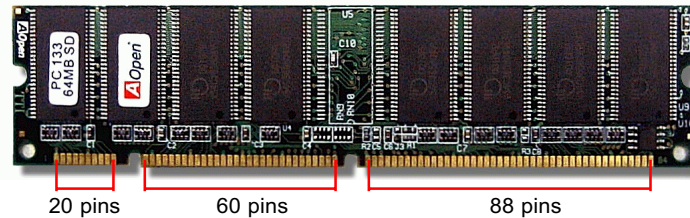

2. Insert the module straight down to the DIMM slot with both hands and press down firmly until the DIMM module is securely in place.

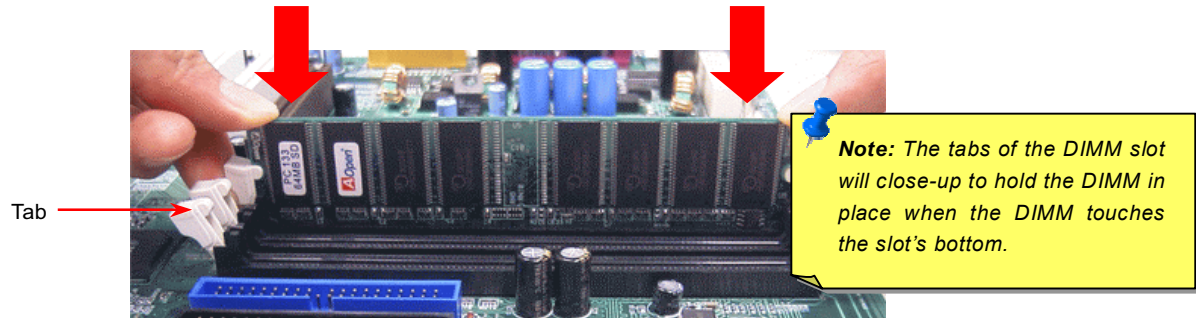

3. Repeat step 2 to finish additional DIMM modules installation.

Support 10/100 Mbps LAN onboard

Intel 815E B-Step/815EP B-Step (Solano Series) includes a fast Ethernet controller on chip. On the strength of Intel 82562ET/EM PHY on board, which is a highly-integrated Platform LAN Connect device, it provides 10/100M bps Ethernet for office and home use, the Ethernet RJ45 connector is located on top of USB connectors. The green LED indicate the link mode, it lights when linking to network; and the yellow LED indicates the transfer mode, it lights when transferring data in 100Mbps mode.

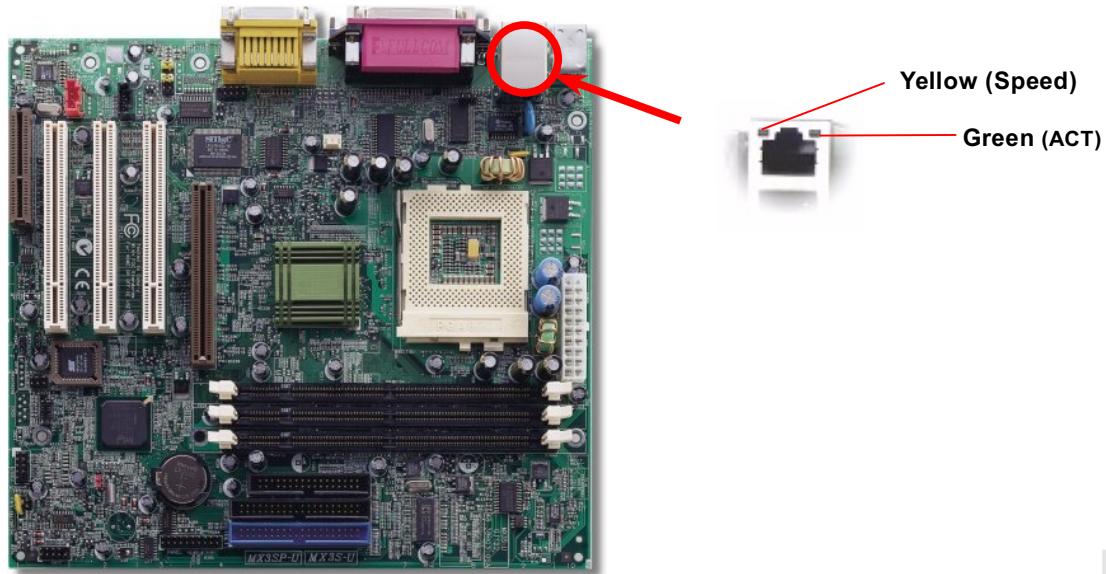

Front Panel Connector

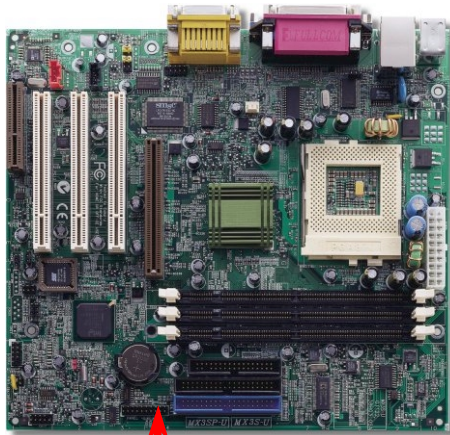

Pin 1

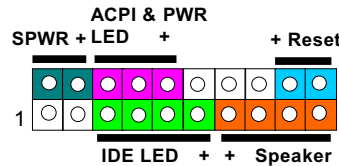

Attach the power LED, Keylock, speaker, power and reset switch connectors to the corresponding pins. If you enable "Suspend Mode" item in BIOS Setup, the ACPI & Power LED will keep flashing while the system is in suspend mode.

Locate the power switch cable from your ATX housing. It is 2-pin female connector from the housing front panel. Plug this connector to the soft-power switch connector marked **SPWR**.

Suspend Type	ACPI LED
Power on Suspend (S1) or Suspend to RAM (S3)	Flashing for every second
Suspend to Disk (S4)	The LED will be turned off

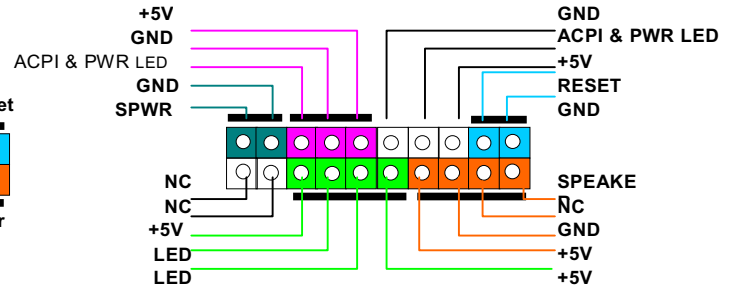

ATX Power Connector

The ATX power supply uses 20-pin connector shown below. Make sure you plug in the right direction.

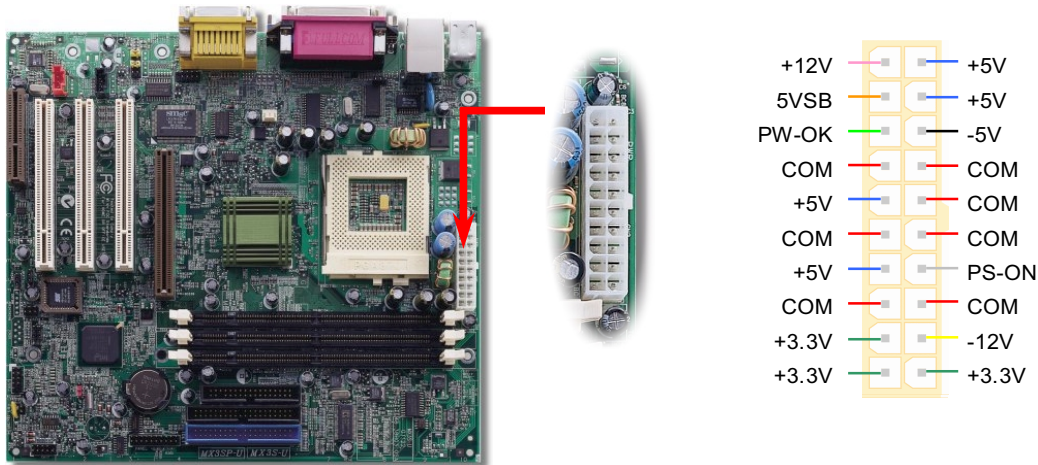

AC Power Auto Recovery

A traditional ATX system should remain at power off stage when AC power resumes from power failure. This design is inconvenient for a network server or workstation, without an UPS, that needs to keep power-on. This motherboard implements an AC Power Auto Recovery function to solve this problem.

IDE and Floppy Connector

Connect 34-pin floppy cable and 40-pin IDE cable to floppy connector FDC and IDE connector. The blue connector is IDE1 for clear identification. Be careful of the pin1 orientation. Wrong orientation may cause system damage.

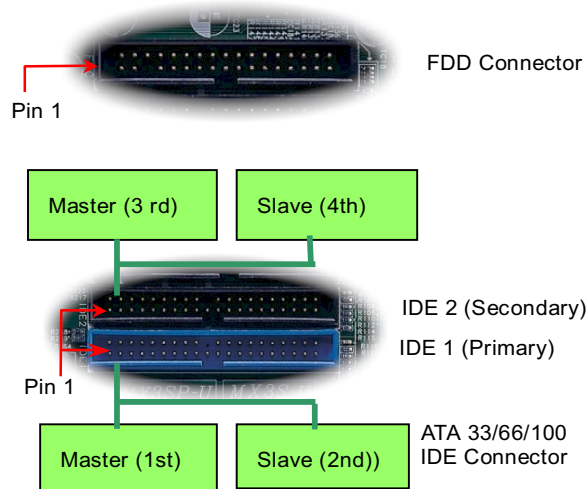
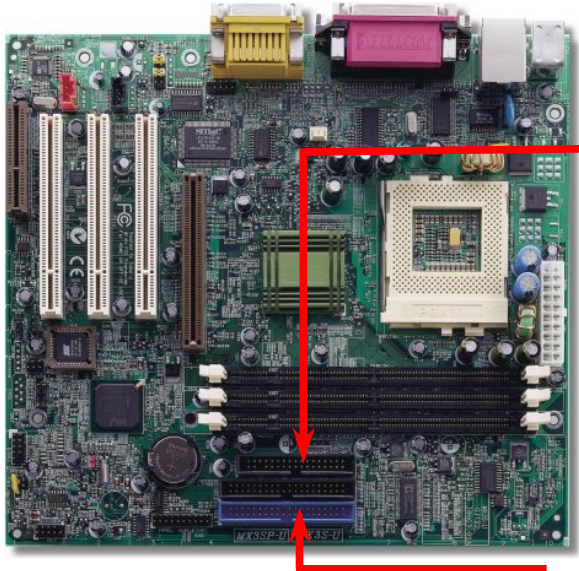

IDE1 is also known as the primary channel and IDE2 as the secondary channel. Each channel supports two IDE devices that make a total of four devices. In order to work together, the two devices on each channel must be set differently to **Master** and **Slave** mode. Either one can be the hard disk or the CDROM. The setting as master or slave mode depends on the jumper on your IDE device, so please refer to your hard disk and CDROM manual accordingly.

This motherboard supports [ATA33](#), [ATA66](#) or [ATA100](#) IDE devices. Following table lists the transfer rate of IDE PIO and DMA modes. The IDE bus is 16-bit, which means every transfer is two bytes.

Mode	Clock Period	Clock Count	Cycle Time	Data Transfer Rate
PIO mode 0	30ns	20	600ns	$(1/600\text{ns}) \times 2\text{byte} = 3.3\text{MB/s}$
PIO mode 1	30ns	13	383ns	$(1/383\text{ns}) \times 2\text{byte} = 5.2\text{MB/s}$
PIO mode 2	30ns	8	240ns	$(1/240\text{ns}) \times 2\text{byte} = 8.3\text{MB/s}$
PIO mode 3	30ns	6	180ns	$(1/180\text{ns}) \times 2\text{byte} = 11.1\text{MB/s}$
PIO mode 4	30ns	4	120ns	$(1/120\text{ns}) \times 2\text{byte} = 16.6\text{MB/s}$
DMA mode 0	30ns	16	480ns	$(1/480\text{ns}) \times 2\text{byte} = 4.16\text{MB/s}$
DMA mode 1	30ns	5	150ns	$(1/150\text{ns}) \times 2\text{byte} = 13.3\text{MB/s}$
DMA mode 2	30ns	4	120ns	$(1/120\text{ns}) \times 2\text{byte} = 16.6\text{MB/s}$
UDMA 33	30ns	4	120ns	$(1/120\text{ns}) \times 2\text{byte} \times 2 = 33\text{MB/s}$
UDMA 66	30ns	2	60ns	$(1/60\text{ns}) \times 2\text{byte} \times 2 = 66\text{MB/s}$
UDMA100	20ns	2	40ns	$(1/40\text{ns}) \times 2\text{byte} \times 2 = 100\text{MB/s}$

Warning: The specification of the IDE cable is a maximum of 46cm (18 inches); make sure your cable does not exceed this length.

Tip:

1. For better signal quality, it is recommended to set the far end side device to master mode and follow the suggested sequence to install your new device. Please refer to above diagram
2. To achieve the best performance of Ultra DMA 66/100 hard disks, a special **80-wires IDE cable** for Ultra DMA 66/100 is required.

IrDA Connector

The IrDA connector can be configured to support wireless infrared module, with this module and application software such as Laplink or Windows 95 Direct Cable Connection, the user can transfer files to or from laptops, notebooks, PDA devices and printers. This connector supports HPSIR (115.2Kbps, 2 meters) and ASK-IR (56Kbps).

Install the infrared module onto the **IrDA** connector and enable the infrared function from BIOS Setup, UART Mode, make sure to have the correct orientation when you plug in the IrDA connector.

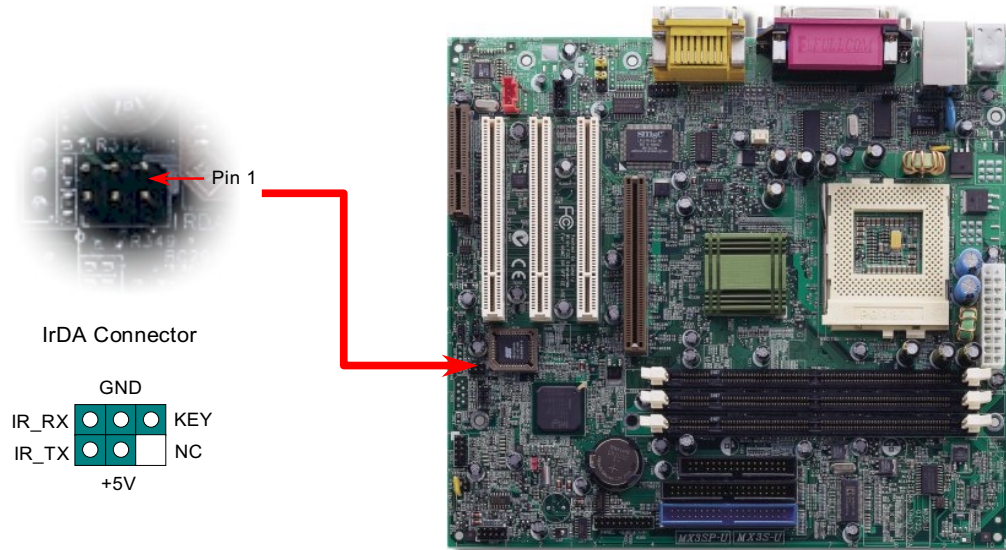

AGP (Accelerated Graphic Port) Expansion Slot

The MX3S-U/MX3SP-U provides an [AGP](#) 4x slot. The AGP 4x is a bus interface targeted for high-performance 3D graphic. AGP supports only memory read/write operation and single-master single-slave one-to-one only. AGP uses both rising and falling edge of the 66MHz clock, for 2X AGP, the data transfer rate is $66\text{MHz} \times 4\text{bytes} \times 2 = 528\text{MB/s}$. AGP is now moving to AGP 4x mode, $66\text{MHz} \times 4\text{bytes} \times 4 = 1056\text{MB/s}$.

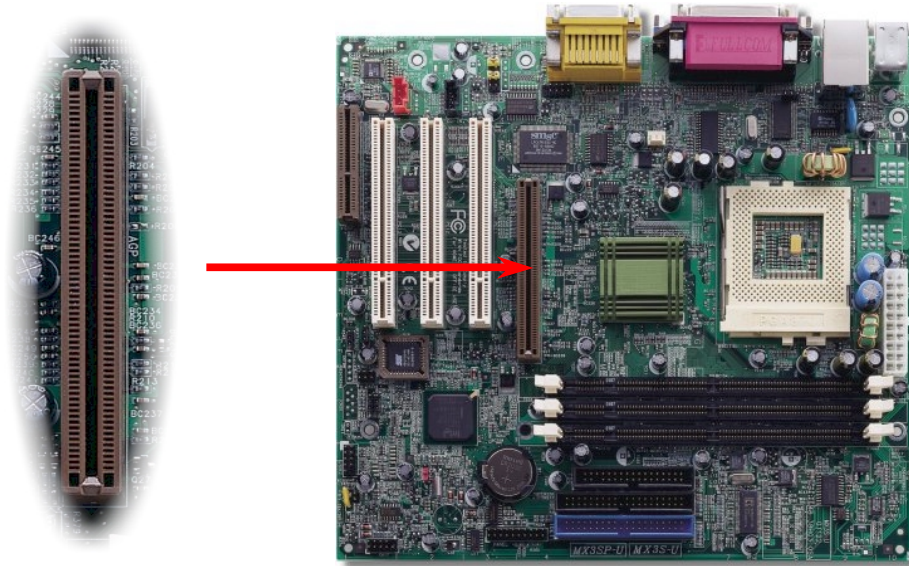

CNR (Communication and Network Riser) Expansion Slot

[CNR](#) is a riser card specification to replace the [AMR \(Audio/Modem Riser\)](#) that supports V.90 analog modem, multi-channel audio, and phone-line based networking. Owing to CPU computing power getting stronger, the digital processing job can be implemented in main chipset and share CPU power. The analog conversion ([CODEC](#)) circuit requires a different and separate circuit design, which is put on CNR card. This motherboard implements sound CODEC on board, but reserve CNR slot for the option of modem function. Note that you can still use PCI modem card.

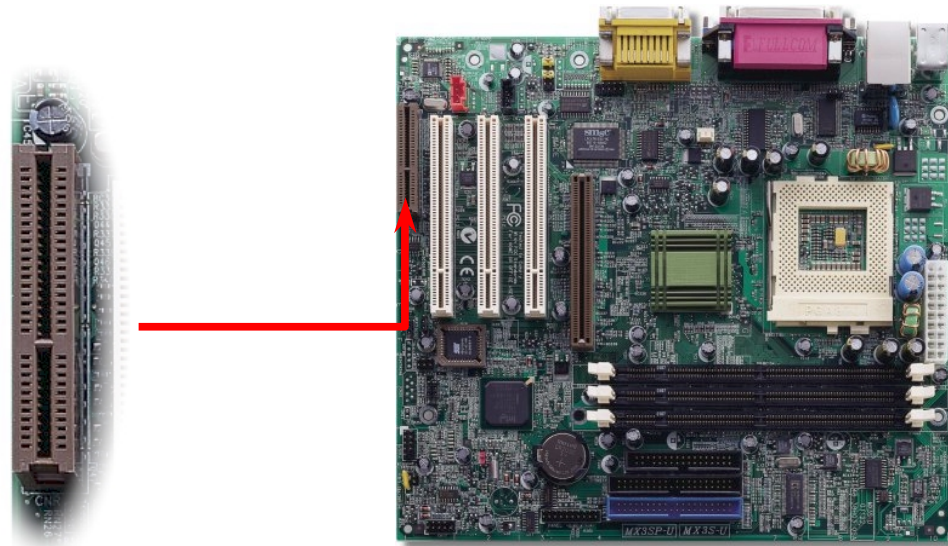

PC99 Color Coded Back Panel

The onboard I/O devices are PS/2 Keyboard, PS/2 Mouse, COM1 and 15-pin D-Sub connector, Printer, [four USB](#), AC97 sound and game ports. The view angle of drawing shown here is from the back panel of the housing.

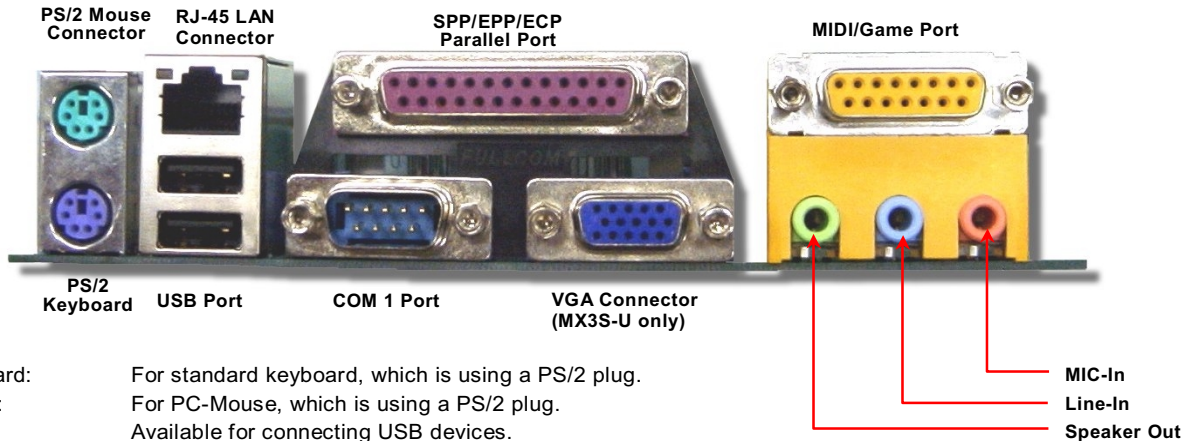

- PS/2 Keyboard: For standard keyboard, which is using a PS/2 plug.
- PS/2 Mouse: For PC-Mouse, which is using a PS/2 plug.
- USB Port: Available for connecting USB devices.
- Parallel Port: To connect with SPP/ECP/EPP printer.
- COM1/COM2 Port: To connect with pointing devices, modem or others serial devices.
- VGA Connector: To connect with PC monitor.
- Speaker Out: To External Speaker, Earphone or Amplifier.
- Line-In: Comes from the signal sources, such as CD/Tape player.
- MIC-In: From Microphone.
- MIDI/Game Port: For 15-pin PC joystick, game pad or MIDI devices.

Support 2nd USB Port

This motherboard provides four [USB](#) connectors to connect USB devices, such as mouse, keyboard, modem, printer, etc. There are two connectors on the PC99 back panel. You can use proper cable to connect the other USB connector to the back panel or front panel of chassis.



USB2 Connector

	1	2	
+5V			+5V
SBD2-			SBD3-
SBD2+			SBD3+
GND			GND
KEY			NC

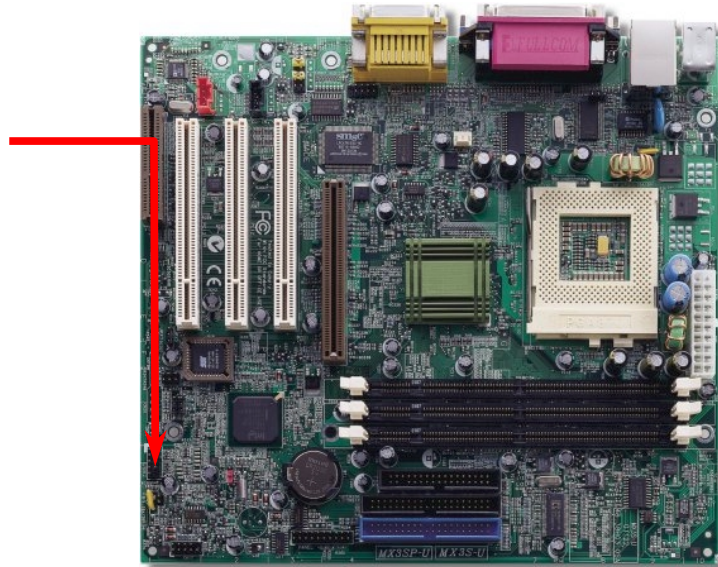

Chassis Intrusion Sensor

The “CASE OPEN” header provides chassis intrusion-monitoring function. This function logged the event in the system BIOS when chassis is opened. You can use the 2-pin chassis intrusion sensor to connect with this header, and enable the chassis monitoring function of system BIOS.

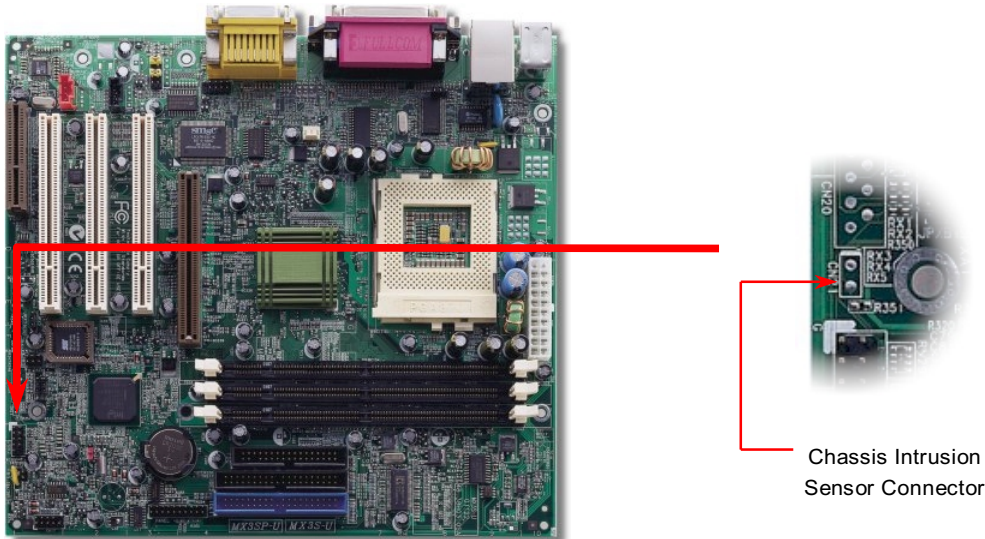

CD Audio Connector

This connector is used to connect CD Audio cable from CDROM or DVD drive to onboard sound.

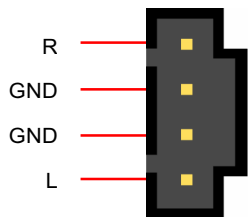

CD-IN

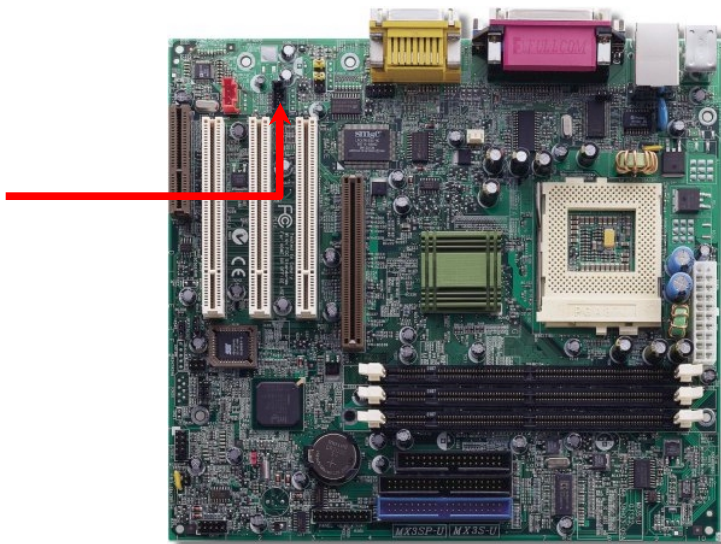

Modem Audio Connector

This connector is used to connect Mono In/MIC Out cable from internal modem card to onboard sound circuit. The pin 1-2 is Mono In, and the pin 3-4 is MIC Out. Please note that there is no standard for this kind of connector yet, only some internal modem cards implement this connector.

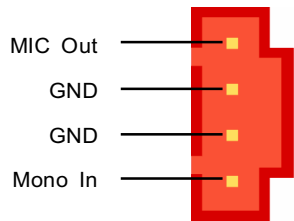

MODEM-CN

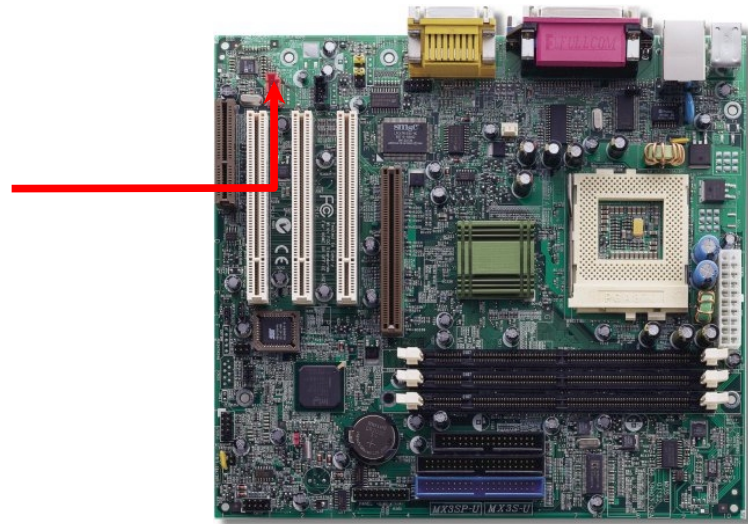

Front Audio Connector

If the housing has been designed with an audio port on the front panel, you'll be able to connect onboard audio to front panel through this connector. By the way, please remove 5-6 and 9-10 jumper caps from the Front Audio Connector before connecting the cable. Please do not remove these 5-6 and 9-10 yellow jumper caps if there's no audio port on the front panel.



Front Audio Connector

	10	9		
HPIN_L			HPOUT_L	
KEY			NC	
HPIN_R			HPOUT_R	
VCC			MIC_VREF	
GND			MIC	
	2	1		

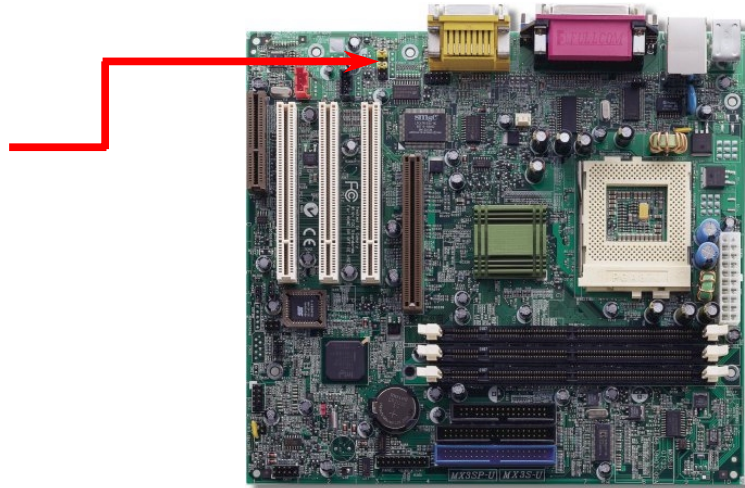

Note: Please remove the jumper cap from the Front Panel Audio Connector before you connect the cable. Do not remove this yellow jumper cap if housing without an audio port on the front panel.

Battery-less and Long Life Design

This Motherboard implements [Flash ROM](#) and a special circuit that allows you to save your current CPU and CMOS Setup configurations without the need of a battery. The RTC (real time clock) can also keep running as long as the power cord is plugged. If you lose your CMOS data by accident, you can just reload the CMOS configurations from Flash ROM and the system will recover as usual.

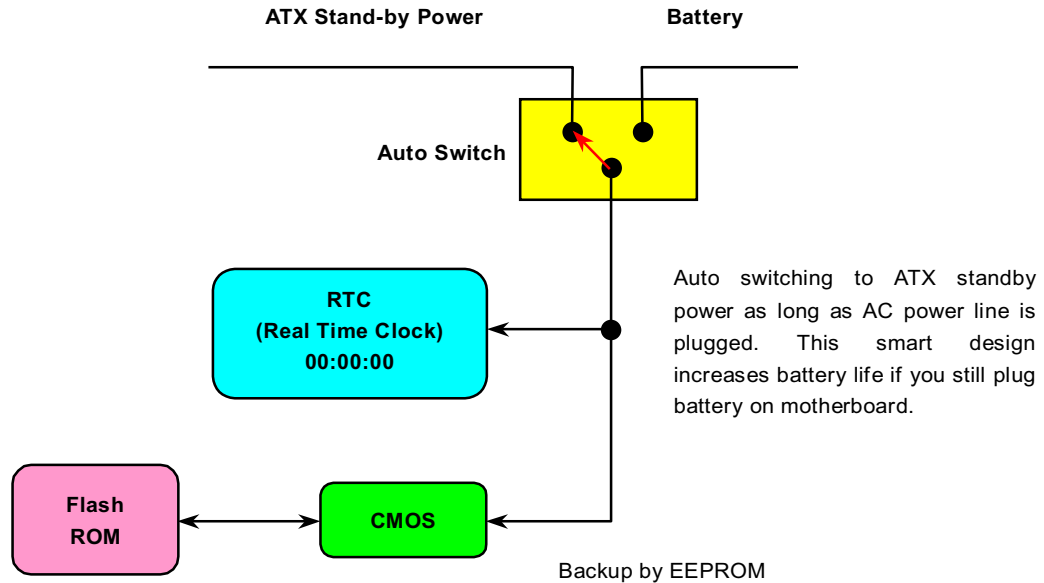

Over-current Protection

The Over Current Protection was very popular implemented on ATX 3.3V/5V/12V switching power supply. However, the new generation CPU uses different voltage that has regulator to transfer 5V to CPU voltage (for example, 2.0V), and makes 5V over current protection useless. This motherboard is with switching regulator onboard supports CPU over-current protection; in conjunction with 3.3V/5V/12V power supply provide the full line over-current protection.

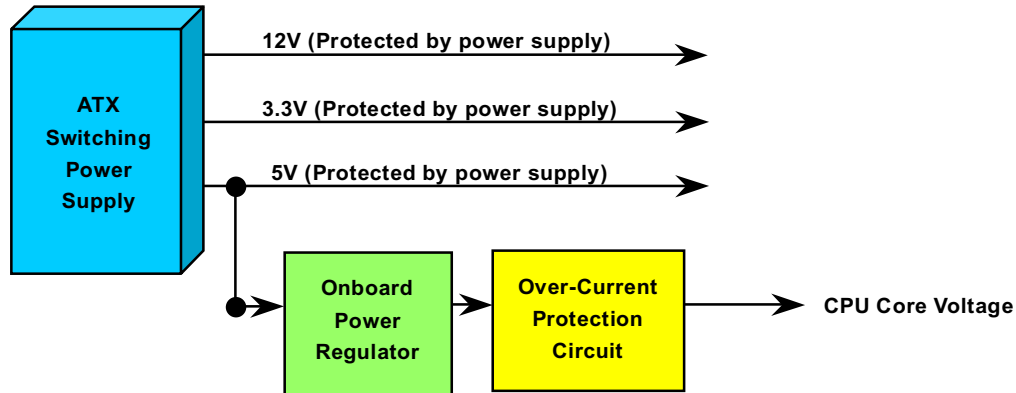

Note: Although we have implemented protection circuit try to prevent any human operating mistake, there is still certain risk that CPU, memory, HDD, add-on cards installed on this motherboard may be damaged because of component failure, human operating error or unknown nature reason. AOpen cannot guaranty the protection circuit will always work perfectly.

Hardware Monitoring

This motherboard implements a hardware monitoring system. As you turn on your system, this smart design will continue to monitor your system's working voltage, fan status and CPU temperature. If any of these systems' status went wrong, there would be an alarm through the chassis external speaker or buzzer of motherboard (if existed) to warn the user.

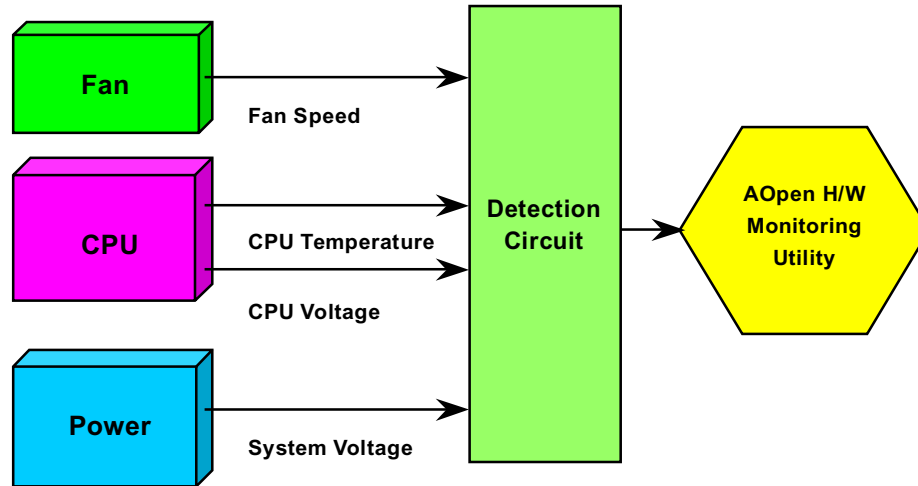

Resettable Fuse

Traditional motherboard has fuse for Keyboard and [USB](#) port to prevent over-current or shortage. These fuses are soldered onboard so that if it were broken (did the job to protect motherboard), user could not replace it and the motherboard would still be malfunctioning.

With expensive Resettable Fuse, the motherboard can be resumed back to normal function after the fuse had done its protection job.

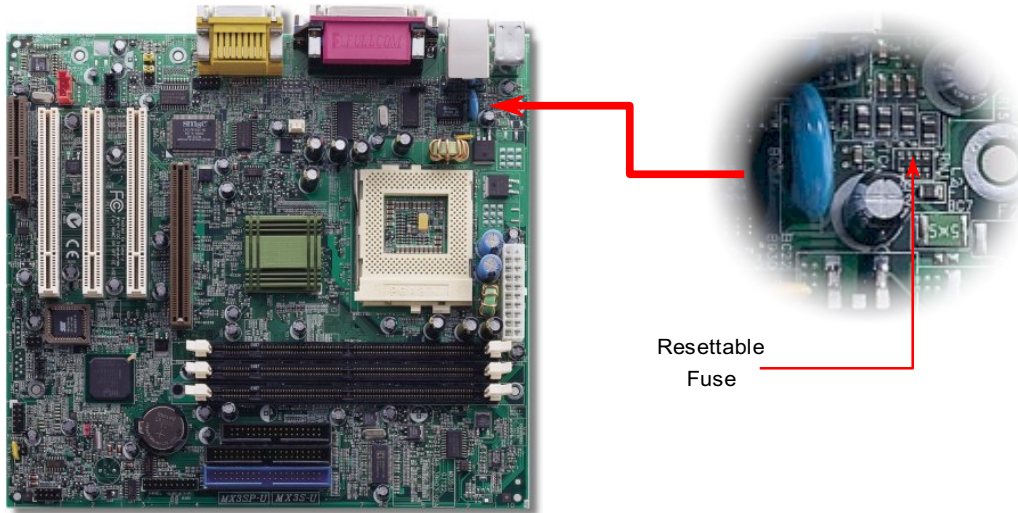

Resettable
Fuse

Year 2000 (Y2K)

Y2K is basically a problem of the identification of year code. To save storage space, traditional software uses only two digits for year identification. For example, 98 for 1998 and 99 for 1999, but 00 will be confused with 1900 and 2000.

There is an RTC circuit (Real Time Clock) in conjunction with 128 bytes of CMOS RAM data in the chipset of the motherboard. The RTC has only two digits and the CMOS has another 2 digits. Unfortunately, this circuit's behavior is like this 1997 → 1998 → 1999 → 1900, that means it may have the Y2K problem. Below is a diagram of how applications work with the OS, BIOS and RTC. In order to keep the best compatibility in the PC industry there is a rule that applications must call the OS to get services and OS must call the BIOS, and then only BIOS is allowed to access the hardware (RTC) directly.

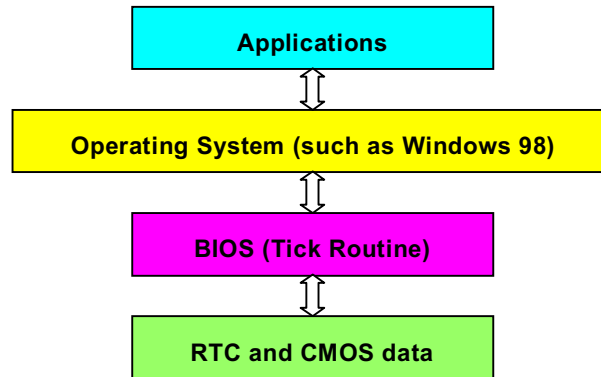

There is a Tick Routine (that goes live around every 50m sec) in the BIOS to keep record of date/time information. In general the BIOS, this Tick Routine does not update the CMOS every time because the CMOS is a very slow device that degrades system performance. The Tick Routine of the BIOS has 4 digits for year coding, as long as applications and the operating system follow the

rule to get date/time information. There will be no Y2K problem (such as NSTL's test program). But unfortunately again, we found some test programs (such as Checkit 98) accesses RTC/CMOS directly. **This motherboard has hardware Y2K checking and protection that ensures risk free operation.**

1500 / 2200 μ F Low ESR Capacitor

The quality of low ESR capacitor (Low Equivalent Series Resistance) during high frequency operation is very important for the stability of CPU power. The idea of where to put these capacitors is another know-how that requires experience and detail calculation.

Not only that, MX3S-U/MX3S Pro-U implements 1500/2200 μ f condensers, which is much larger than normal condenser (1000 μ f) and it provides better stability for CPU power.

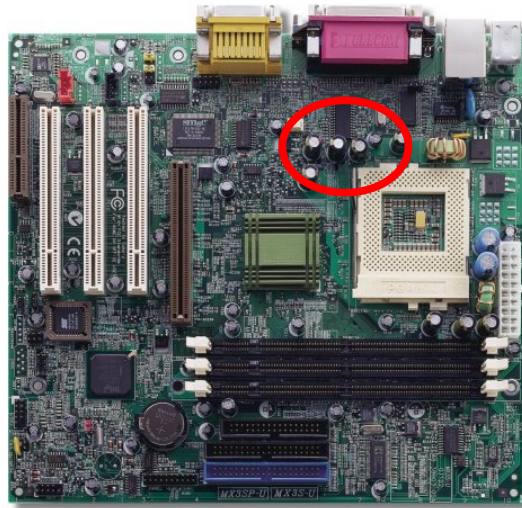

The power circuit of the CPU core voltage must be checked to ensure system stability for high speed CPUs (such as the new Pentium III, or when overclocking). A typical CPU core voltage is 2.0V, so a good design should control voltage between 1.860V and 2.140V. That is, the transient must be below 280mV. Below is a timing diagram captured by a Digital Storage Scope, it shows the voltage transient is only 143mv even when maximum 18A current is applied.

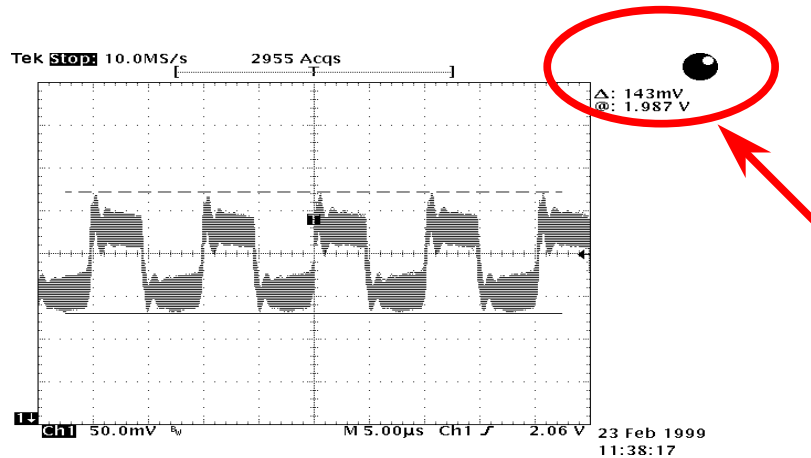

Note: This diagram for example only, it may not be exactly the same as this motherboard.

Layout (Frequency Isolation Wall)

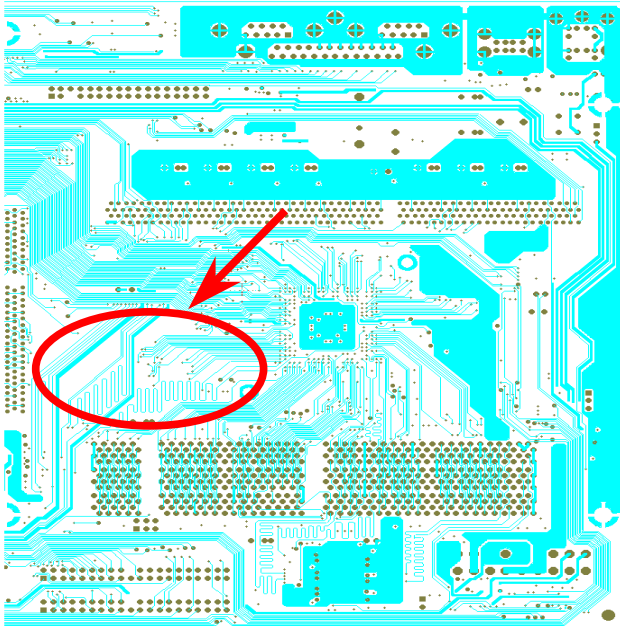

For high frequency operation, especially overclocking, layout is the most important factor to make sure chipset and CPU working in stable condition. The layout of this motherboard implements AOpen's unique design called " Frequency Isolation Wall". Separating each critical portion of motherboard into regions where each region operates in a same or similar frequency range to avoid cross talk and frequency interference between each region's operations and condition. The trace length and route must be calculated carefully. For example, the clock trace must be equal length (not necessarily as short as possible) so that clock skew will be controlled within few a pico second ($1/10^{12}$ Sec)

Note: This diagram for example only, it may not be exactly the same as this motherboard.

Pure Aluminum Heatsink

Cool down CPU and Chipset is important for system reliability. Aluminum heat sink provides better heat dissipation especially when you are trying to over clocking the CPU.

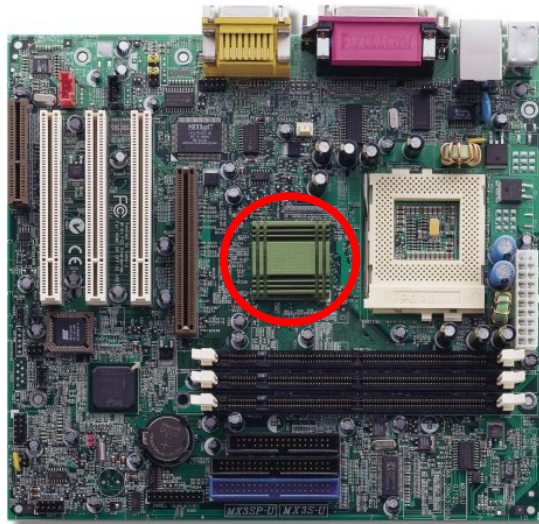

Driver and Utility

There are motherboard drivers and utilities included in [Bonus CD disc](#). You don't need to install all of them in order to boot your system. But after you finish the hardware installation, you have to install your operation system first (such as Windows 98) before you can install any drivers or utilities. Please refer to your operation system's installation guide.

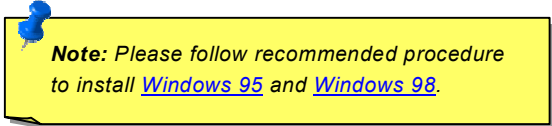

Note: Please follow recommended procedure to install [Windows 95](#) and [Windows 98](#).

Auto-run Menu from Bonus CD Disc

You can use the auto-run menu of Bonus CD disc. Choose the utility and driver and select model name.

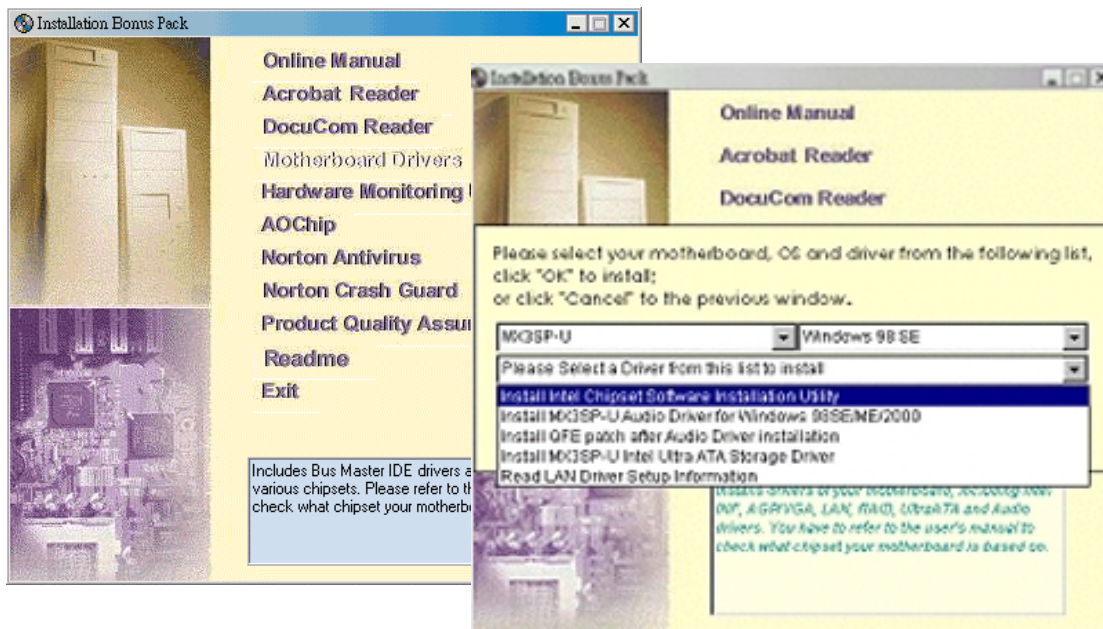

Installing Intel® Chipset Software Installation Utility

Windows 95/98 cannot recognize this chipset, because it was released before the Intel 815E B-Step/815EP B-Step chipset. You can install the Intel INF Update Utility from the Bonus Pack CD disc auto-run menu to eliminate the “?” marks.



Installing Onboard AGP Driver

Intel 815E B-Step/815EP B-Step chipset integrates a 2D/3D graphics accelerator and provides AGP 2X/4X incredible performance to access main memory at over 1GB/s. You can find the audio driver from the Bonus Pack CD disc auto-run menu.

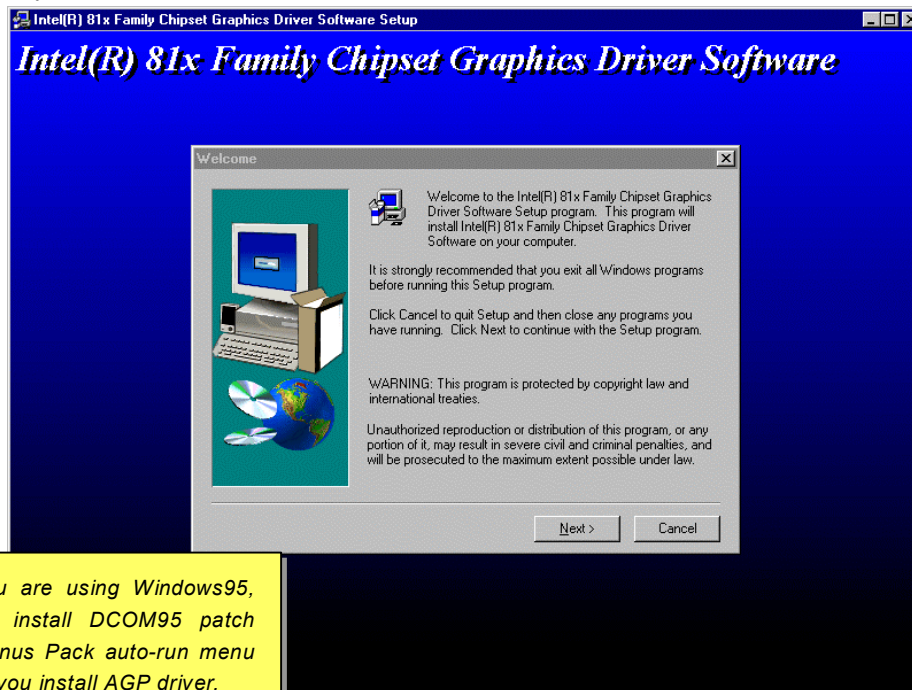

Note: If you are using Windows95, you should install DCOM95 patch from the Bonus Pack auto-run menu first, before you install AGP driver.

Installing LAN Driver

The South Bridge in Intel i815E B-Step/i815EP B-Step (Solano Series) integrates a total communication solution including 10/100Mb Fast Ethernet for Office requirement. You can install LAN Driver under Windows95/98, WindowsNT & Windows2000 by following steps.

Manually Adding an Adapter in Windows 95 / 98

=====

LOCATION OF DRIVER: \Intel\Driver\Lan\E100BNT5.SYS (NDIS 5.0)

LOCATION OF SETUP FILE: \Intel\Driver\Lan\NET82557.INF

1. From the Control Panel, double-click the "Add Hardware" icon.
2. Double-click Other Devices or Network Adapters in the list area.
3. Double-click a PCI Ethernet Controller.
4. Click the Driver tab, then click Update Driver.
5. Click Next at the Update Device Driver Wizard.
6. Select "Display a list of all the drivers..." and click Next.
7. Insert the AOpen Bonus CD and click Have Disk.
8. Enter the appropriate drive for your disk media (for example: D:\) ,and click OK.
9. Click OK at the Select Device dialog box.
10. The Update Wizard displays the message that it has found the driver. Click Next.
11. Click Finish and restart your computer when prompted.

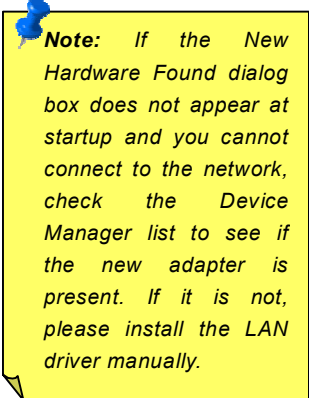

Note: If the New Hardware Found dialog box does not appear at startup and you cannot connect to the network, check the Device Manager list to see if the new adapter is present. If it is not, please install the LAN driver manually.

Installing Ultra ATA/100 IDE Driver

This Intel® Ultra ATA Storage Driver is designed to take advantage of devices supporting ATA DMA/Ultra DMA technologies, and improve system performance of Windows 98, Windows 98 Second Edition(SE), Windows Millennium Edition(Me), Windows NT* 4.0 (any Service Pack), and Windows 2000 operating systems. However, we could not guarantee it would not trigger any system instabilities as Intel also suggests it is not a requirement for your operating system to work properly. Nevertheless, if you need this driver, you can still find it in the [Bonus Pack](#) CD disc.

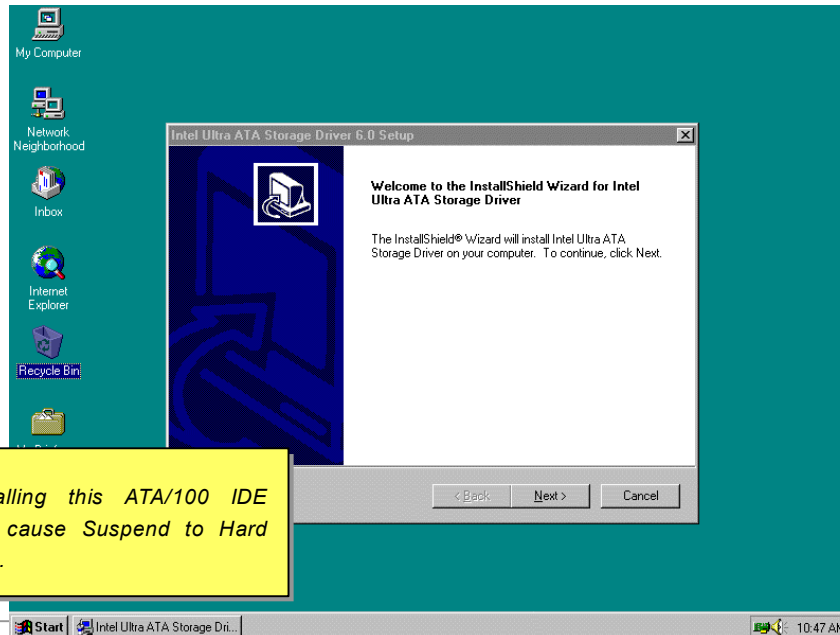

Installing Onboard Sound Driver

This motherboard comes with an AD1885 [AC97 CODEC](#). You can find the audio driver from the Bonus Pack CD disc auto-run menu.

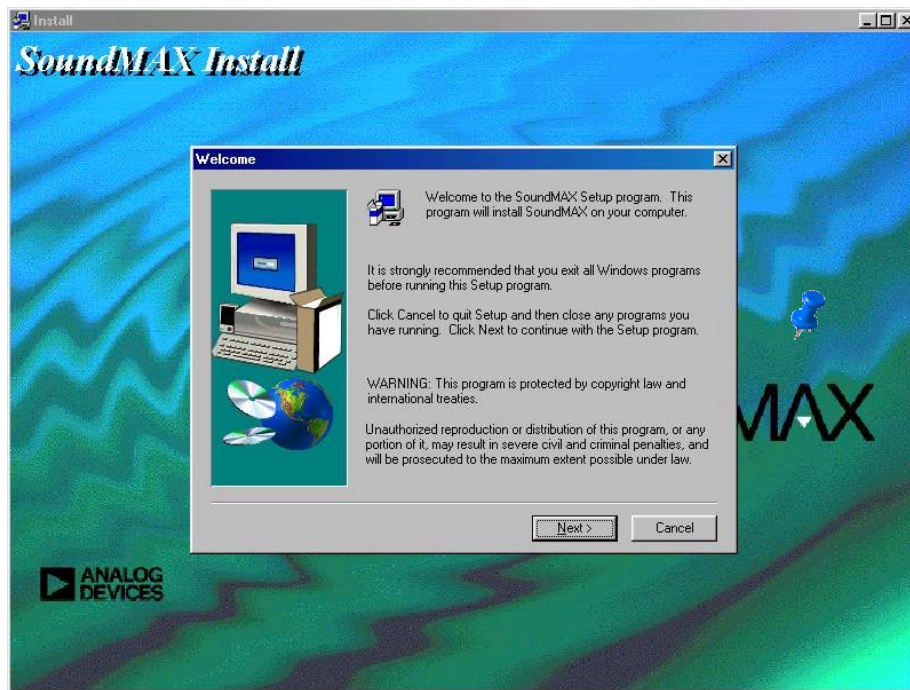

ACPI Suspend to Hard Drive

[ACPI](#) Suspend to Hard Drive is basically controlled by Windows operation system. It saves your current work (system status, memory and screen image) into hard disk, and then the system can be totally power off. Next time, when power is on, you can resume your original work directly from hard disk within few seconds without go through the Windows booting process and run your application again. If your memory is 64MB, normally, you need to reserve at least 64MB HDD space to save your memory image.

When go into Suspend:

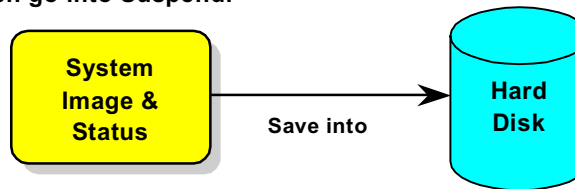

When power-on next time:

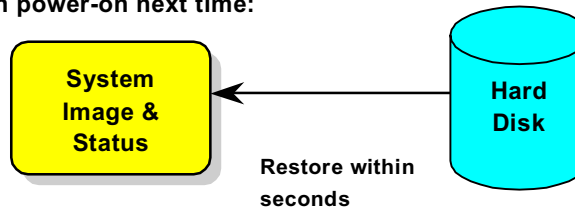

System Requirement

1. **AOZVHDD.EXE 1.30b** or later.
2. Delete **config.sys** and **autoexec.bat**.

Fresh installation of Windows 98 on a new system

1. Execute "**Setup.exe /p j**" to install Windows 98
2. After Windows 98's installation is complete, go to the **Control Panel > Power Management**.
 - a. Set **Power Schemes > System Standby** to "Never".
 - b. Click on "Hibernate" and select "Enable Hibernate Support" then "Apply".
 - c. Click on the "Advanced" tab, you'll see "Hibernate" on "Power Buttons". Note that this option will only be seen after step b mentioned above has been completed; otherwise only "Standby" and "Shutdown" will be shown. Select "Hibernate" and "Apply".
3. Clean boot into DOS and run AOZVHDD utility.
 - a. If you assign the whole disk to your Win 98 system (FAT 16 or FAT 32), please run "**aozvhd /c /file**". Please remember sufficient free space has to be reserved in the disk, e.g. if you have 64 MB DRAM and 16 MB VGA card installed, the system needs at least 80 MB free space. The utility will locate the space automatically.
 - b. If you assign an individual partition for Win 98, please run "**aozvhd /c /partition**". Of course, the system needs to provide unformatted an empty partition.
4. Reboot system.
5. You've already implemented ACPI Suspend to-Hard Drive. Click "**Start > Shut Down > Standby**" then the screen will go off immediately. And 1 minute or so will be taken for the system to save what's in the memory to the hard drive; the larger the memory

Changing from APM to ACPI (Windows 98 only)

1. Run "Regedit.exe"

- a. Go through the following path

HKEY_LOCAL_MACHINE

SOFTWARE

MICROSOFT

WINDOWS

CURRENT VERSION

DETECT

- b. Select "ADD Binary" and name it as "**ACPIOPTION**".
- c. Right click and select Modify, add "01" after "0000" to make it "0000 01".
- d. Save changes.

2. Select "Add New Hardware" under Control Panel. Allow Windows 98 to detect new hardware. (It will find "**ACPI BIOS**" and remove "**Plug and Play BIOS**")

3. Reboot system.

4. Clean boot into DOS and run "AOZVHDD.EXE /C /File"

Changing from ACPI to APM

1. Run "Regedit.exe"

- a. Go through the following path

HKEY_LOCAL_MACHINE
SOFTWARE
MICROSOFT
WINDOWS
CURRENT VERSION
DETECT
ACPI OPTION

b. Right click and select "Modify, change "01" to "02" to make it "0000 02".

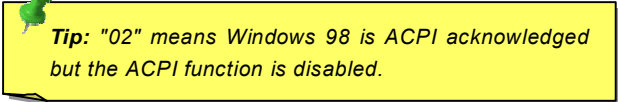

Tip: "02" means Windows 98 is ACPI acknowledged but the ACPI function is disabled.

c. Save changes.

2. Select "Add New Hardware" under Control Panel. Allow Windows 98 to detect new hardware. (It will find "**Plug and Play BIOS**" and **remove "ACPI BIOS"**)
3. Reboot system.
4. Run "Add New Hardware" again and it will find "Advanced Power Management Resource".
5. Click "OK".

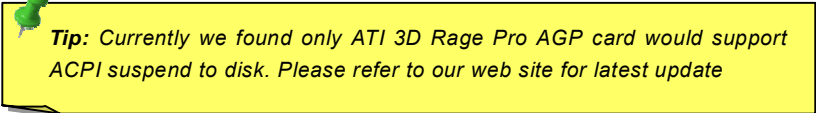

Tip: Currently we found only ATI 3D Rage Pro AGP card would support ACPI suspend to disk. Please refer to our web site for latest update

ACPI Suspend to RAM (STR)

This motherboard supports [ACPI](#) Suspend to RAM function. With this function, you can resume your original work directly from DRAM without going through the Windows 98 booting process and run your application again. Suspend to DRAM saves your current work in the system memory, it is faster than Suspend to Hard Drive but requires power supplied to DRAM, while Suspend to Hard Drive requires no power.

When go into Suspend:

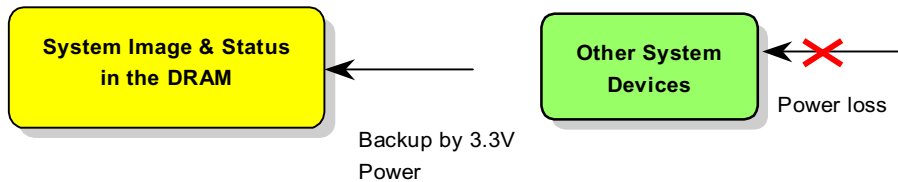

When power-on next time:

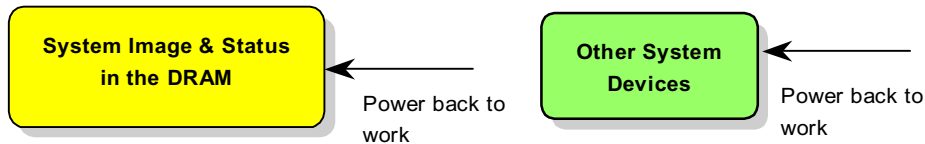

To implement ACPI Suspend to DRAM, please follow the procedures as below:

System Requirement

1. An ACPI OS is required. Currently, Windows 98 is the only choice.
2. The Intel® Chipset Software Installation Utility must have been installed properly.

Procedures

1. Changed the following BIOS settings.

BIOS Setup > Power Management Setup > ACPI Function: Enabled

BIOS Setup > Power Management Setup > ACPI Suspend Type: S3.

2. Go to Control Panel > Power Management. Set "Power Buttons" to "Standby".
3. Press power button or standby button to wake up the system.

AWARD BIOS

System parameters can be modified by going into [BIOS](#) Setup menu, this menu allows you to configure the system parameters and save the configuration into the 128 bytes CMOS area, (normally in the RTC chip or in the main chipset).

The AwardBIOS™ that installed in the [Flash ROM](#) of the motherboard is a custom version of an industry standard BIOS. The BIOS provides critical low-level support for standard devices such as hard disk drives, serial and parallel ports.

Most BIOS setting of MX3S-U/MX3SP-U had optimized by our R&D engineering team. But, the default setting of BIOS still can't fine-tune the chipset controlling entire system. Hence, the rest of this chapter is intended to guide you through the process of configuring your system using setup.

[To enter to BIOS setup menu](#), press when [POST \(Power-On Self Test\)](#) screen is shown on your monitor.

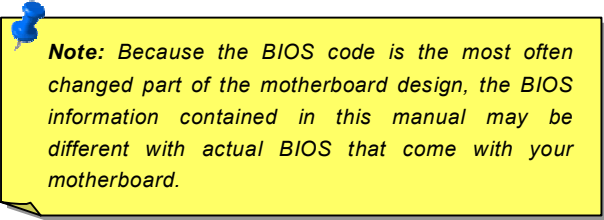

***Note:** Because the BIOS code is the most often changed part of the motherboard design, the BIOS information contained in this manual may be different with actual BIOS that come with your motherboard.*

About BIOS Function Description...

We always dedicates to give users a more friendly computer system. Now, we include all function descriptions of BIOS setup program into the BIOS Flash ROM. When you select one function of BIOS setup program, the function description will appeared at right side of screen. Hence, you don't need read this manual while you changing the BIOS setting.

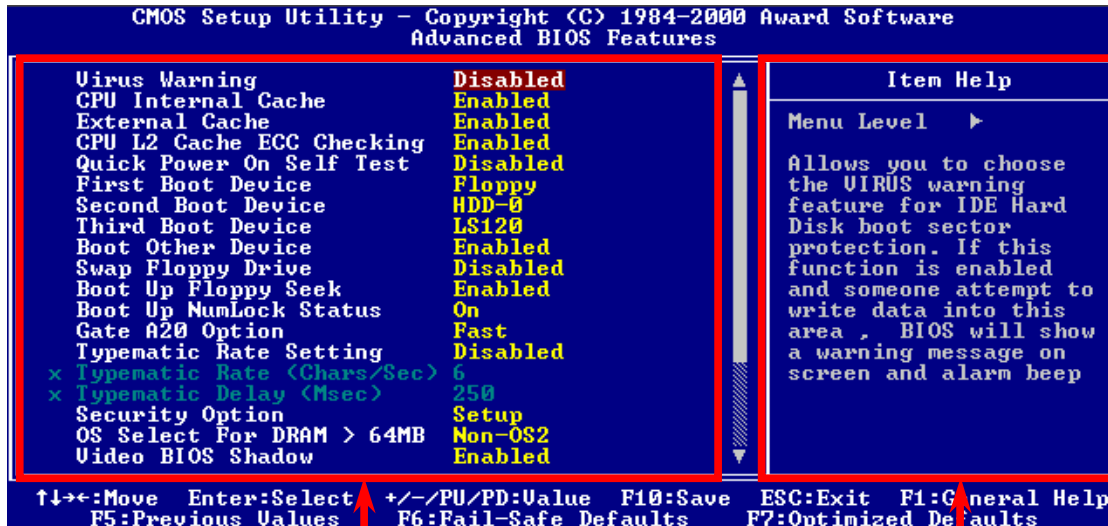

Menu Items Select Window

Item Function Description Window

How To Use Award™ BIOS Setup Program

Generally, you can use the arrow keys to highlight items that you want to choose, then press <Enter> key to select, and use the <Page Up> and <Page Down> key to change setting value. You also can press <F1> key for help and press <Esc> key to quit Award™ BIOS setup program. The following table provides details about how to use keyboard in the Award™ BIOS setup program. By the way, all of our products also provide a special function in the BIOS setup, you can press <F3> key selecting preferred menu language to display.

Key	Description
Page Up or +	Changing setting to next value or increase the value.
Page Down or -	Changing setting to previous value or decrease value.
Enter	Select the item.
Esc	1. In main menu: Quit and don't save any change. 2. In sub menu: Exit current menu to main menu.
Up Arrow	Highlight previous item.
Down Arrow	Highlight next item.
Left Arrow	Move the light bar to left side of menu.
Right Arrow	Move the light bar to right side of menu.
F1	Get menu or item help description.
F3	Changing menu language.
F5	Load previous setting value from CMOS.

Key	Description
F6	Load fail-save setting value from CMOS.
F7	Load turbo setting value from CMOS.
F10	Save changed setting and exit setup program.



Note: We always dedicate to give users a more friendly computer system. Now, we include all function descriptions of BIOS setup program into the BIOS Flash ROM. When you select one function of BIOS setup program, the function description will appeared at right side of screen. Hence, you don't need read this manual while you changing the BIOS setting.

How To Enter BIOS Setup

After you finish the setting of jumpers and connect correct cables. Power on and enter the BIOS Setup, press during POST (Power-On Self Test). Choose "Load Setup Defaults" for recommended optimal performance.

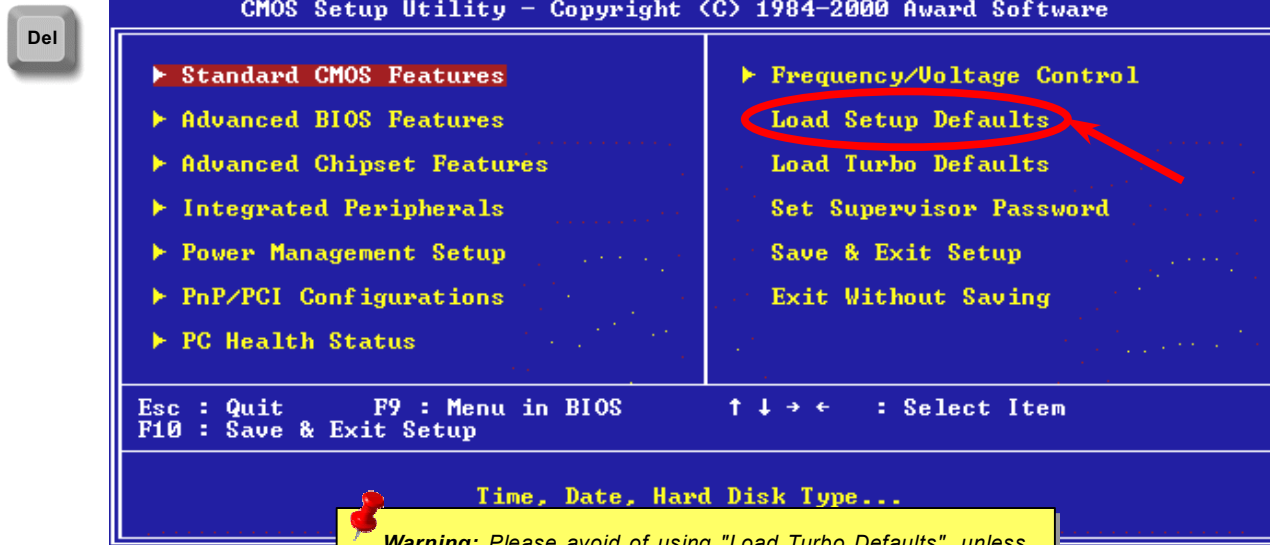

BIOS Upgrade

By flashing your motherboard, you agree to accept the possibility of BIOS flash failure. If your motherboard is working and is stable, and there are no major bugs that were fixed by a latter BIOS revision, we recommend that you DO NOT try to upgrade your BIOS.

By doing so, you are taking a risk of BIOS flash failure. If you indeed intend on upgrading, PLEASE BE SURE to use the right BIOS revision for the right motherboard model.

This Easy Flash is a little different than traditional flash method. The [BIOS](#) binary file and flash routine are linked together and you simply run a single command to complete the flash process.

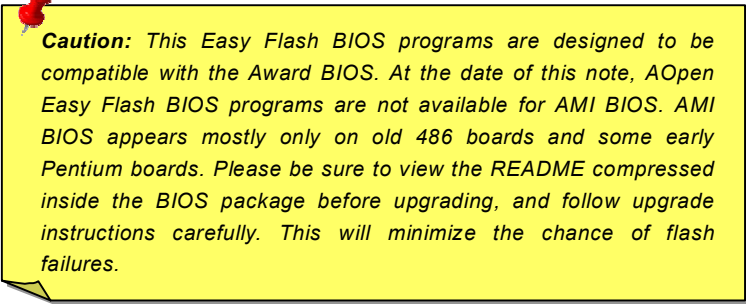

Caution: *This Easy Flash BIOS programs are designed to be compatible with the Award BIOS. At the date of this note, AOpen Easy Flash BIOS programs are not available for AMI BIOS. AMI BIOS appears mostly only on old 486 boards and some early Pentium boards. Please be sure to view the README compressed inside the BIOS package before upgrading, and follow upgrade instructions carefully. This will minimize the chance of flash failures.*

Below are the steps for easy flashing procedures: (applies for Award BIOS ONLY)

1. Download new BIOS upgrade [zip](#) file from our web site. For example, MX3SPU102.ZIP.
2. Run shareware PKUNZIP (<http://www.pkware.com/>) which supports miscellaneous operation systems to extract the binary BIOS file and the flash utility. Or Winzip (<http://www.winzip.com/>) in Windows environment.
3. Save the unzipped file into a bootable floppy disk. For example, MX3SPU102.BIN & MX3SPU102.EXE
4. Reboot the system to DOS mode without loading any memory handler (such as EMM386) or device driver. It needs around 520K free memory spaces.
5. Execute A:> MX3SPU102 and the program will do the rest of it.

DO NOT turn off the power during FLASH PROCESS until you are asked to!!

6. Reboot system and press to [enter BIOS setup](#), Choose "Load Setup Defaults", then "Save & Exit Setup". Done!

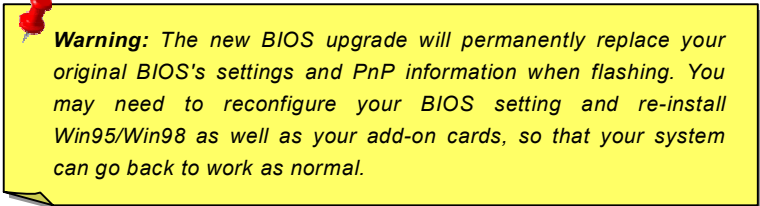

Warning: The new BIOS upgrade will permanently replace your original BIOS's settings and PnP information when flashing. You may need to reconfigure your BIOS setting and re-install Win95/Win98 as well as your add-on cards, so that your system can go back to work as normal.

Overclocking

As a leading manufacturer in motherboard industry, we always listen to what customers want and develop products to fit different user's requirements. Reliability, compatibility, leading technology and friendly features are our basic goals when designing motherboards. Other than above mentioned design criteria, there are power users who are always seeking to push the limitation of the system performance by overclocking which we call them "Overclocker".

This section is dedicated to overclockers.

This high performance motherboard is designed for maximum **133MHz** CPU bus clock. But it comes with clock generator of **248MHz** when we design it to accommodate future CPU bus clock. Our lab test results shown that **166MHz** is achievable when proper setting and qualified components were presented, we feel quite comfortable overclocking to **166MHz**. Not only that, this motherboard has full-range (CPU core voltage) settings and an option to adjust CPU core voltage. The CPU clock ratio can be up to 12x that supports almost all of Pentium III/Celeron CPUs in the future and provides flexibility for overclockers. For your reference, the following configurations are what we feel comfortable at **166MHz** bus clock.

But not guaranty. 😊

***Tip:** Note that overclocking may also cause thermal problem. Please make sure that the cooling fan and the heatsink were adequate to dissipate excessive heat that's generated by overclocking the CPU.*

***Warning:** The design of this product follows CPU and chipset vendor's design guideline. Any attempts to push beyond product specification are not recommended and you are taking your own risk to damage your system or important data. Before doing overclocking, you must make sure your components are able to tolerate such abnormal setting, especially CPU, DRAMs, hard disks, and AGP VGA cards.*

VGA Card & Hard Disk

VGA and HDD are key components for overclocking, following list are what have been tested in our lab. Please note that we can not guaranty they can be successful overclocked again.

Glossary

AC97

Basically, AC97 specification separates sound/modem circuit to two parts, digital processor and a [CODEC](#) for analogy I/O they are linked by AC97 link bus. Since digital processor can be put into motherboard main chipset, the cost of sound/modem onboard solution can be reduced.

ACPI (Advanced Configuration & Power Interface)

ACPI is the power management specification of PC97 (1997). It intends to save more power by taking full control of power management to operating system and bypass [BIOS](#). The chipset or super I/O chip needs to provide standard register interface to operating system (such as Windows 98). This is a bit similar as the [PnP](#) register interface. ACPI defines ATX momentary soft power switch to control the power state transition.

AGP (Accelerated Graphic Port)

AGP is a bus interface targeted for high-performance 3D graphic. AGP supports only memory read/write operation and single-master single-slave one-to-one only. AGP uses both rising and falling edge of the 66MHz clock, for 2X AGP, the data transfer rate is $66\text{MHz} \times 4\text{byte} \times 2 = 528\text{MB/s}$. AGP is now moving to 4X mode, $66\text{MHz} \times 4\text{byte} \times 4 = 1056\text{MB/s}$. We are the first company to support 4X AGP motherboards by both AX6C (Intel 820) and MX64/AX64 (VIA 694x), started from Oct 1999.

AMR (Audio/Modem Riser)

The [CODEC](#) circuit of AC97 sound/modem solution can be put on motherboard or put on a riser card (AMR card) that connects to motherboard through AMR connector.

Bonus Pack CD

A disc bundled with our motherboard product; there are motherboard drivers, Acrobat Reader for [PDF](#) online manual and other useful utilities.

APM (Advanced Power Management)

Unlike [ACPI](#), BIOS controls most APM power management functions. Our Suspend to Hard Drive is a good example of APM power management.

ATA (AT Attachment)

ATA is the specification of diskette interface. In 80's, many software and hardware manufacturers instituted the ATA specification together. The AT is meaning International Business Machines Corporation (IBM) personal computer/AT's bus structure.

ATA/66

ATA/66 uses both rising edge and falling edge but doubles [UDMA/33](#) transfer rate. The data transfer rate is 4 times of the PIO mode 4 or DMA mode 2, 16.6MB/s x4 = 66MB/s. To use ATA/66, you need special ATA/66 IDE cable.

ATA/100

ATA/100 is a new IDE specification under developing. ATA/100 uses both rising edge and falling edge as [ATA/66](#) but clock cycle time is reduced to 40ns. The data transfer rate is $(1/40\text{ns}) \times 2 \text{ bytes} \times 2 = 100\text{MB/s}$. To use ATA/100, you need special 80-wire IDE cable, the same as ATA/66.

BIOS (Basic Input/Output System)

BIOS is a set of assembly routine/program that reside in [EPROM](#) or [Flash ROM](#). BIOS controls Input/output devices and other hardware devices of motherboard. In general, to provide hardware independent portability, operation system and drivers is required to access BIOS without directly access hardware devices.

Bus Master IDE (DMA mode)

The traditional PIO (Programmable I/O) IDE requires the CPU to involve in all the activities of the IDE access including waiting for the mechanical events. To reduce the workload of the CPU, the bus master IDE device transfers data from/to memory without interrupting CPU, and releases CPU to operate concurrently while data is transferring between memory and IDE device. You need the bus master IDE driver and the bus master IDE HDD to support bus master IDE mode.

CNR (Communication and Networking Riser)

The CNR specification provides the PC industry the opportunity to deliver a flexible and cost reduced method of implementing LAN, home networking, DSL, USB, wireless, audio and modem subsystems widely used in today's "connected PCs". The CNR specification is an open industry specification and is supported by OEMs, IHV card manufacturers, silicon supplier and Microsoft.

CODEC (Coding and Decoding)

Normally, CODEC means a circuit that can do digital to analog conversion and also the analog to digital conversion. It is part of [AC97](#) sound/modem solution.

DDR (Double Data Rated) SDRAM

DDR SDRAM utilizes the existing DRAM infrastructure and technology while doubling the nominal bandwidth available to systems in an easy to design and simple to adopt way. Initially a perfect solution for memory intensive server and workstation applications, DDR low cost and low voltage will ultimately make it an ideal solution for all segments of the PC market, high performance desktop and mobile PCs, Value PCs and even Internet Appliances and mobile devices.

DIMM (Dual In Line Memory Module)

DIMM socket has total 168-pin and supports 64-bit data. It can be single or double side, the golden finger signals on each side of PCB are different, and that is why it was called Dual In Line. Almost all DIMMs are made by [SDRAM](#), which operate at 3.3V. Note that some old DIMMs are made by FPM/[EDO](#) and only operate at 5V. Do not confuse them with SDRAM DIMM.

DMA (Direct Memory Access)

Channel for communications between the memory and surrounding devices.

ECC (Error Checking and Correction)

The ECC mode needs 8 ECC bits for 64-bit data. Each time memory is accessed; ECC bits are updated and checked by a special algorithm. The ECC algorithm has the ability to detect double-bit error and automatically correct single-bit error while parity mode can only detect single-bit error.

EDO (Extended Data Output) Memory

The EDO DRAM technology is actually very similar to FPM (Fast Page Mode). Unlike traditional FPM that tri-states the memory output data to start the pre-charge activity, EDO DRAM holds the memory data valid until the next memory access cycle, that is similar to pipeline effect and reduces one clock state.

EEPROM (Electronic Erasable Programmable ROM)

Also known as E²PROM. Both EEPROM and [Flash ROM](#) can be re-programmed by electronic signals, but the interface technology is different. Size of EEPROM is much smaller than flash ROM.

EPROM (Erasable Programmable ROM)

Traditional motherboard stores BIOS code in EPROM. EPROM can only be erased by ultra-violet (UV) light. If BIOS has to be upgraded, you need to remove EPROM from motherboard, clear by UV light, re-program, and then insert back.

EV6 Bus

EV6 Bus in the technology of Alpha processor from Digital Equipment Corporation. EV6 bus uses both rising and falling clock edge to transfer data, similar as DDR SDRAM or ATA/66 IDE bus.

EV6 Bus Speed = CPU external bus clock x 2.

For example, 200 MHz EV6 bus is actually using 100 MHz external bus clock, but the equivalent speed is 200 MHz.

FCC DoC (Declaration of Conformity)

The DoC is component certification standard of FCC EMI regulations. This standard allows DIY component (such as motherboard) to apply DoC label separately without a shielding of housing.

FC-PGA (Flip Chip-Pin Grid Array)

FC means Flip Chip, FC-PGA is a new package of Intel for Pentium III CPU. It can plug into SKT370 socket, but require motherboard to add some signals on socket 370. That is, the motherboard needs to be redesigned. Intel is going to ship FC-PGA 370 CPU and phase out slot1 CPU.

Flash ROM

Flash ROM can be re-programmed by electronic signals. It is easier for BIOS to upgrade by a flash utility, but it is also easier to be infected by virus. Because of increase of new functions, BIOS size is increased from 64KB to 256KB (2M bit). Our AX5T is the first board to implement 256KB (2Mbit) Flash ROM. Now flash ROM size is moving to 4M bit on AX6C (Intel 820) and MX3W (Intel 810) motherboard. , Our motherboard uses EEPROM for jumper-less and battery-less design.

FSB (Front Side Bus) Clock

FSB Clock means CPU external bus clock.

CPU internal clock = CPU FSB Clock x CPU Clock Ratio

I²C Bus

See [SMBus](#).

IEEE 1394

IEEE 1394 is a low-cost digital interface originated by Apple Computer as a desktop LAN and developed by the IEEE 1394 working group. The IEEE 1394 can transport data at 100, 200 or 400 Mbps. One of the solutions to connect digital television devices together at 200 Mbps. Serial Bus Management provides overall configuration control of the serial bus in the form of optimizing arbitration timing, guarantee of adequate electrical power for all devices on the bus, assignment of isochronous channel ID, and notification of errors. There are two type of IEEE 1394 data transfer: asynchronous and isochronous. Asynchronous transport is the traditional computer memory-mapped, load and store interface. Data requests are sent to a specific address and an acknowledgment is returned. In addition to an architecture that scales with silicon technology, IEEE 1394 features a unique isochronous data channel interface. Isochronous data channels provide guaranteed data transport at a pre-determined rate. This is especially important for time-critical multimedia data where just-in-time delivery eliminates the need for costly buffering.

Parity Bit

The parity mode uses 1 parity bit for each byte, normally it is even parity mode, that is, each time the memory data is updated, parity bit will be adjusted to have even count "1" for each byte. When next time, if memory is read with odd number of "1", the parity error is occurred and this is called single bit error detection.

PBSRAM (Pipelined Burst SRAM)

For Socket 7 CPU, one burst data read requires four QWord (Quad-word, $4 \times 16 = 64$ bits). PBSRAM only needs one address decoding time and automatically sends the remaining QWords to CPU according to a predefined sequence. Normally, it is 3-1-1-1, total 6 clocks, which is faster than asynchronous SRAM. PBSRAM is often used on L2 (level 2) cache of Socket 7 CPU. Slot 1 and Socket 370 CPU do not need PBSRAM.

PC-100 DIMM

[SDRAM](#) DIMM that supports 100MHz CPU [FSB](#) bus clock.

PC-133 DIMM

[SDRAM](#) DIMM that supports 133MHz CPU [FSB](#) bus clock.

PC-1600 or PC-2100 DDR DRAM

Based on FSB frequency, the DDR DRAM has 200MHz and 266MHz two type of working frequency. Because of DDR DRAM data bus is 64-bit, it provides data transfer bandwidth up to $200 \times 64 / 8 = 1600 \text{MB/s}$, and $266 \times 64 / 8 = 2100 \text{MB/s}$. Hence, the PC-1600 DDR DRAM is working with 100MHz and PC-2100 DDR DRAM is working with 133MHz FSB frequency.

PCI (Peripheral Component Interface) Bus

Bus for the internal connection of peripheral devices, high-speed data channel between the computer and expansion card.

PDF Format

A file format for electronic document, PDF format is independent from platform, you can read PDF file under Windows, Unix, Linux, Mac ... with different PDF reader. You can also read PDF file by web browser such as IE and Netscape, note that you need to install PDF plug-in first (Included in Acrobat Reader).

PnP (Plug and Play)

The PnP specification suggests a standard register interface for both BIOS and operating system (such as Windows 95). These registers are used by BIOS and operating system to configure system resource and prevent any conflicts. PnP BIOS or operating system will automatically allocate the IRQ/DMA/Memory. Currently, almost all the PCI cards and most ISA cards are already PnP compliant.

POST (Power-On Self Test)

The BIOS self-test procedure after power-on, sometimes, it is the first or the second screen shown on your monitor during system boot.

RDRAM (Rambus DRAM)

Rambus is a memory technology that uses large burst mode data transfer. Theoretically, the data transfer should be high than [SDRAM](#). RDRAM is cascaded in channel operation. For Intel 820, only one RDRAM channel is supported, 16-bit data per channel, and this channel may have maximum 32 RDRAM devices, no matter how many [RIMM](#) sockets.

RIMM (Rambus Inline Memory Module)

184-pin memory module that supports [RDRAM](#) memory technology. A RIMM memory module may contain up to maximum of 16 RDRAM devices.

SDRAM (Synchronous DRAM)

SDRAM is one of the DRAM technologies that allow DRAM to use the same clock as the CPU host bus ([EDO](#) and FPM are asynchronous and do not have clock signal). It is similar as [PBSRAM](#) to use burst mode transfer. SDRAM comes in 64-bit 168-pin [DIMM](#) and operates at 3.3V. We are the first company to support dual-SDRAM DIMMs onboard (AP5V), from Q1 1996

Shadow E²PROM

A memory space in Flash-ROM to simulate E²PROM operation, our motherboard uses Shadow E²PROM for jumper-less and battery-less design

SIMM (Single In Line Memory Module)

SIMM socket is only 72-pin, and is only single side. The golden finger signals on each side of PCB are identical. That is why it was called Single In Line. SIMM is made by FPM or [EDO](#) DRAM and supports 32-bit data. SIMM had been phased out on current motherboard design.

SMBus (System Management Bus)

SMBus is also called I2C bus. It is a two-wire bus developed for component communication (especially for semiconductor IC). For example, set clock of clock generator for jumper-less motherboard. The data transfer rate of SMBus is only 100Kbit/s, it allows one host to communicate with CPU and many masters and slaves to send/receive message.

SPD (Serial Presence Detect)

SPD is a small ROM or [EEPROM](#) device resided on the [DIMM](#) or [RIMM](#). SPD stores memory module information such as DRAM timing and chip parameters. SPD can be used by [BIOS](#) to decide best timing for this DIMM or RIMM.

Ultra DMA

Ultra DMA (or, more accurately, Ultra DMA/33) is a protocol for transferring data between a hard disk drive through the computer's data path (or bus) to the computer's random access memory (RAM). The Ultra DMA/33 protocol transfers data in burst mode at a rate of 33.3MB/s, twice as fast as the previous [Direct Access Memory \(DMA\)](#) interface. Ultra DMA was developed as a proposed industry standard by the Quantum corporation, makes of hard disk drives, and Intel, makes of chipset that support computer bus technology. Ultra DMA support in your computer means that it will boot (start) and open new applications more quickly. It will help users of graphic-intensive and applications that require large amounts of access to data on the hard disk drive. Ultra DMA uses Cyclical Redundancy Checking (CRC), offering a new level of data protection. Ultra DMA uses the same 40-pin IDE interface cable as PIO and DMA.

16.6MB/s x2 = 33MB/s

16.6MB/s x4 = 66MB/s

16.6MB/s x6 = 100MB/s

USB (Universal Serial Bus)

USB is a 4-pin serial peripheral bus that is capable of cascading low/medium speed peripherals (less than 10Mbit/s) such as keyboard, mouse, joystick, scanner, printer and modem. With USB, the traditional complex cables from back panel of your PC can be eliminated.

VCM (Virtual Channel Memory)

NEC's Virtual Channel Memory (VCM) is a new DRAM core architecture that dramatically improves the memory system's ability to service multimedia requirements. VCM increases memory bus efficiency and performance of any DRAM technology by providing a set of fast static registers between the memory core and I/O pins. Using VCM technology results in reduced data access latency and reduced power consumption.

ZIP file

A compressed file format to reduce file size. To unzip file, run shareware PKUNZIP (<http://www.pkware.com/>) for DOS and other operating system or WINZIP (<http://www.winzip.com/>) for windows environment.



Troubleshooting

If you encounter any trouble to boot your system, follow the procedures accordingly to resolve the problem.

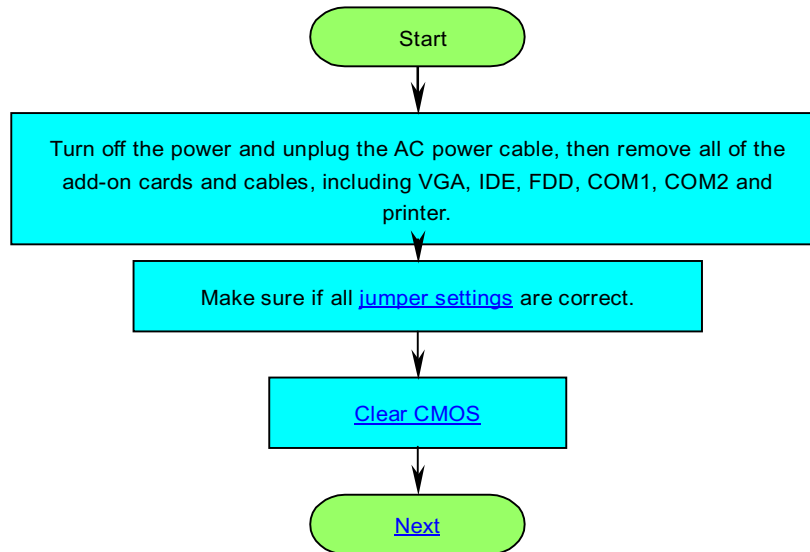

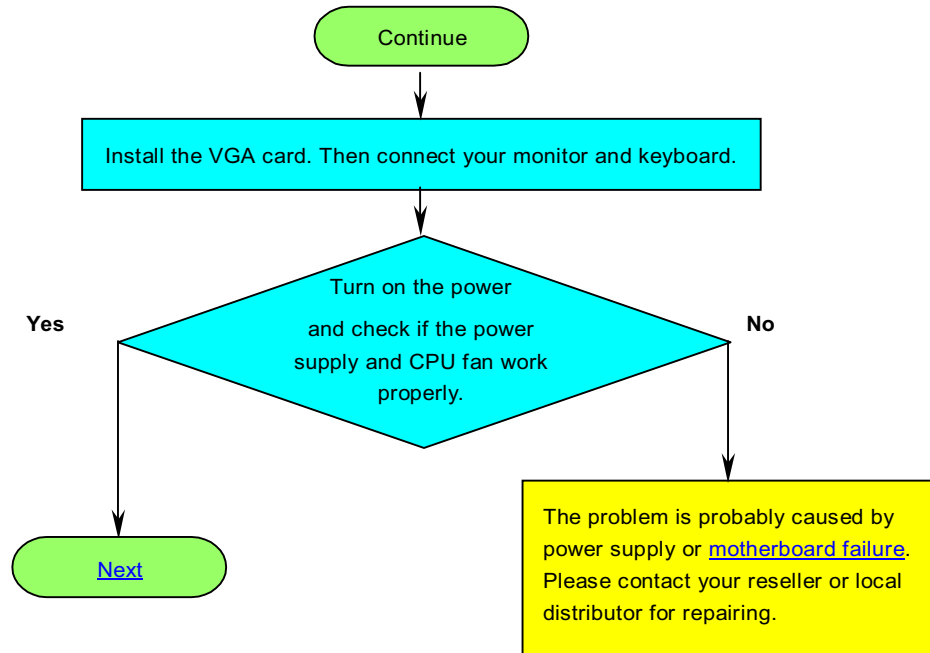

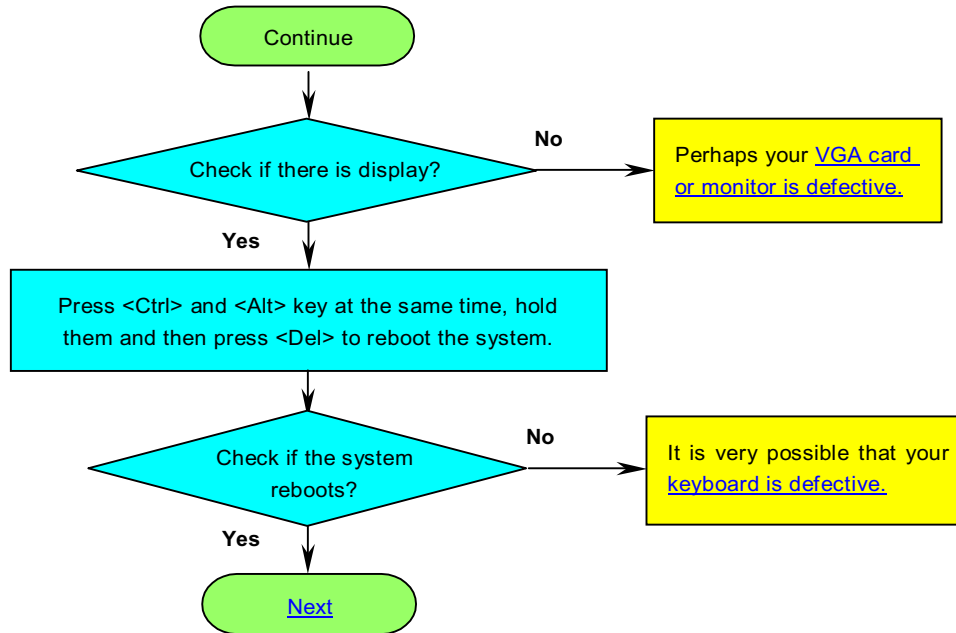

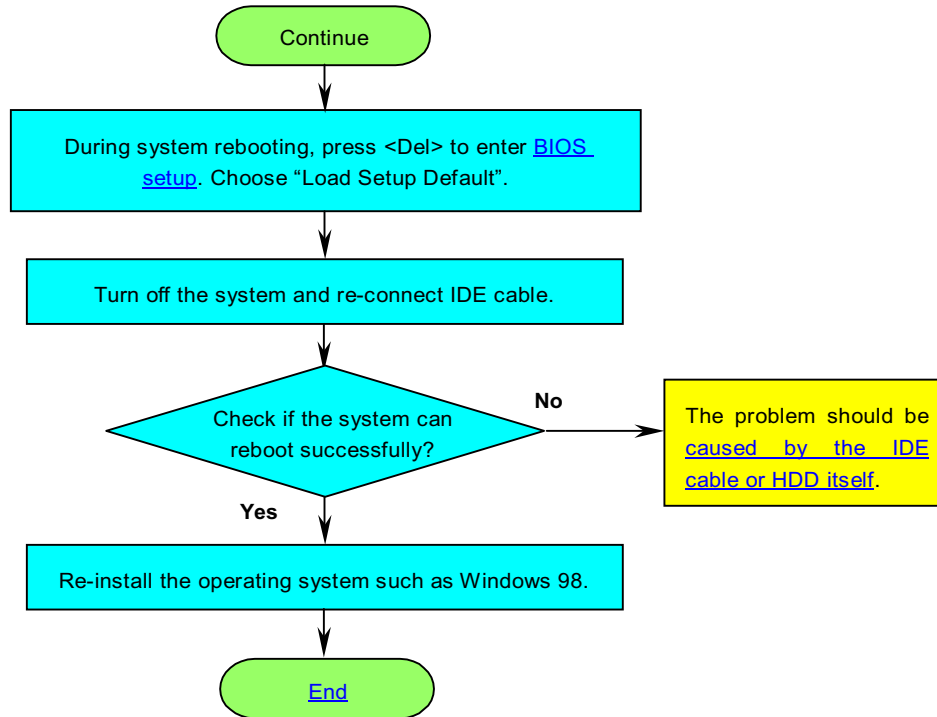



Technical Support

Dear Customer,

Thanks for choosing our products. To provide the best and fastest service to our customer is our first priority. However, we receive numerous emails and phone-calls worldwide everyday, it is very hard for us to serve everyone on time. We recommend you follow the procedures below and seek help before contact us. With your help, we can then continue to provide the best quality service to more customers.

Thanks very much for your understanding!

Technical Supporting Team

1

Online Manual: Please check the manual carefully and make sure the jumper settings and installation procedure are correct.

2

Test Report: We recommend to choose board/card/device from the compatibility test reports for assembling your PC.

3

FAQ: The latest FAQ (Frequently Asked Questions) may contain a solution to your problem.

4

Download Software: Check out this table to get the latest updated BIOS/utility and drivers.

5

News Group: Your problem probably had been answered by our support engineer or professional users on the news group.

6

Contact Distributors/Resellers: We sell our products through resellers and integrators. They should know your system configuration very well and should be able to solve your problem more efficiently than us. After all, their attitude of service is an important reference for you if next time you want to buy something else from them.

Part Number and Serial Number

The Part Number and Serial number are printed on bar code label. You can find this bar code label on the outside packing, on ISA/CPU slot or on component side of PCB. For example:

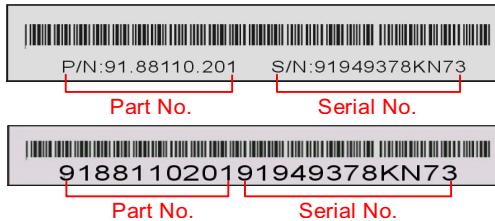

P/N: 91.88110.201 is part number, **S/N: 91949378KN73** is serial number.

Model name and BIOS version

Model name and BIOS version can be found on upper left corner of first boot screen ([POST](#) screen). For example:

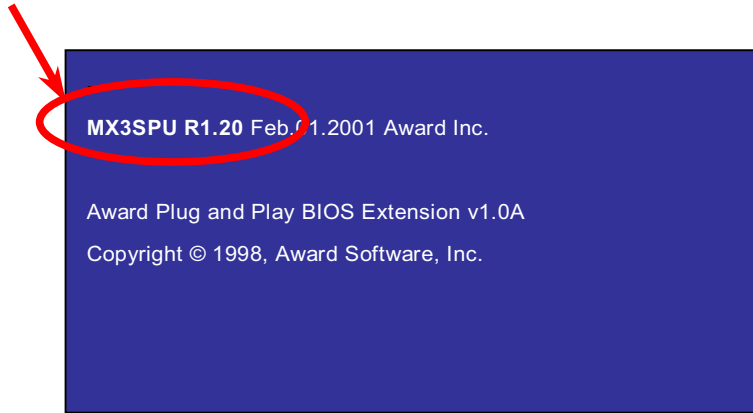

MX3SPU is model name of motherboard; **R1.20** is BIOS version.