

AX3S

Online Manual

DOC. NO: AX3S-OL-E0010B



What's in this manual

AX3S	1
<i>What's in this manual</i>	2
<i>Before You Start</i>	10
<i>Quick Installation Procedure</i>	11
<i>Motherboard Map</i>	12
<i>Block Diagram</i>	13
Hardware	14
<i>JP14 Clear CMOS</i>	15
<i>JP28 Keyboard/Mouse Wakeup</i>	16
<i>CPU Socket and Fan Connector</i>	18
<i>CPU Jumper-less Design</i>	19
<i>JP23/JP29 FSB/PCI Clock Ratio</i>	22
<i>DIMM Socket</i>	23
<i>RAM Power LED & Blinking LED</i>	24

<i>Front Panel Connector</i>	27
<i>ATX Power Connector</i>	29
<i>AC Power Auto Recovery</i>	30
<i>IDE and Floppy Connector</i>	31
<i>IrDA Connector</i>	34
<i>GPIO-Connector (General Purpose I/O) (Optional)</i>	35
<i>WOM (Zero Voltage Wake on Modem)</i>	36
<i>WOL (Wake on LAN)</i>	39
<i>4X AGP (Accelerated Graphic Port)</i>	41
<i>CNR (Communications and Networking Riser)</i>	42
<i>PC99 Color Coded Back Panel</i>	44
<i>Support 4 USB Ports</i>	45
<i>JP12 Enable/Disable Onboard Sound Chip</i>	46
<i>CD Audio Connector</i>	47
<i>Video_Audio_IN Connector</i>	48
<i>Modem Audio Connector</i>	49

<i>Front Panel Audio (Optional)</i>	50
<i>Battery-less and Long Life Design</i>	51
<i>Over-current Protection</i>	53
<i>Hardware Monitoring</i>	55
<i>Resettable Fuse</i>	56
<i>BIOS Write Protection</i>	57
<i>Year 2000 (Y2K)</i>	58
<i>1500uF Low ESR Capacitor</i>	60
<i>Layout (Frequency Isolation Wall)</i>	62
Driver and Utility	63
<i>Autorun Menu from Bonus CD Disc</i>	64
<i>Eliminate “?” mark from Windows 95/98</i>	65
<i>Installing Onboard AGP Driver</i>	66
<i>Installing Onboard Sound Driver</i>	67
<i>Installing Ultra ATA/100 IDE Driver</i>	68
<i>Installing Hardware Monitoring Utility</i>	69

ACPI Suspend to Hard Drive	71
ACPI Suspend to RAM (STR)	78
AWARD BIOS	80
Enter BIOS Setup	81
Change Language	82
Standard CMOS Features.....	83
Advanced BIOS Features	89
Advanced Chipset Features.....	98
Integrated Peripherals.....	104
Power Management Setup.....	121
PnP/PCI Configurations	131
PC Health Status	136
Frequency / Voltage Control.....	138
Load Setup Defaults	142
Load Turbo Defaults.....	143
Set Password.....	144

Save & Exit Setup	145
Exit without Saving	146
Load EEPROM Default	146
Save EEPROM Default	146
NCR SCSI BIOS and Drivers	146
BIOS Upgrade	147
Overclocking	148
VGA and HDD	150
Glossary	151
AC97	151
ACPI (Advanced Configuration & Power Interface)	151
AGP (Accelerated Graphic Port)	152
AMR (Audio/Modem Riser)	152
AOpen Bonus Pack CD	152
APM	152
ATA/66	153

<i>ATA/100</i>	153
<i>BIOS (Basic Input/Output System)</i>	153
<i>Bus Master IDE (DMA mode)</i>	154
<i>CODEC (Coding and Decoding)</i>	154
<i>DIMM (Dual In Line Memory Module)</i>	154
<i>ECC (Error Checking and Correction)</i>	154
<i>EDO (Extended Data Output) Memory</i>	155
<i>EEPROM (Electronic Erasable Programmable ROM)</i>	155
<i>EPROM (Erasable Programmable ROM)</i>	155
<i>FCC DoC (Declaration of Conformity)</i>	155
<i>Flash ROM</i>	156
<i>FSB (Front Side Bus) Clock</i>	156
<i>I2C Bus</i>	156
<i>P1394</i>	156
<i>PBSRAM (Pipelined Burst SRAM)</i>	157
<i>PC100 DIMM</i>	157

<i>PC133 DIMM</i>	157
<i>PDF Format</i>	157
<i>PnP (Plug and Play)</i>	158
<i>POST (Power-On Self Test)</i>	158
<i>RDRAM (Rambus DRAM)</i>	158
<i>RIMM</i>	158
<i>SDRAM (Synchronous DRAM)</i>	159
<i>SIMM (Single In Line Memory Module)</i>	159
<i>SMBus (System Management Bus)</i>	159
<i>SPD (Serial Presence Detect)</i>	159
<i>Ultra DMA/33</i>	160
<i>USB (Universal Serial Bus)</i>	160
<i>ZIP file</i>	160
Troubleshooting	161
Technical Support	165
<i>Part Number and Serial Number</i>	167

Model name and BIOS version 168

Before You Start



This Online Manual is in [PDF format](#), we recommend using Adobe Acrobat Reader 4.0 for online viewing, it is included in [Bonus CD disc](#) or you can get free download from [Adobe web site](#).

Although this Online Manual is optimized for screen viewing, it is still capable for hardcopy printing, you can print it by A4 paper size and set 2 pages per A4 sheet on your printer. To do so, choose **File > Page Setup** and follow the instruction of your printer driver.

Thanks for the help of saving our earth.

Quick Installation Procedure

This page gives you a quick procedure on how to install your system. Follow each step accordingly.

- [1 Installing CPU and Fan](#)
- [2 Installing System Memory \(DIMM\)](#)
- [3 Connecting Front Panel Cable](#)
- [4 Connecting IDE and Floppy Cable](#)
- [5 Connecting ATX Power Cable](#)
- [6 Connecting Back Panel Cable](#)
- [7 Power-on and Load BIOS Setup Default](#)
- [8 Setting CPU Frequency](#)
- 9 Reboot
- [10 Installing Operating System \(such as Windows 98\)](#)
- [11 Installing Driver and Utility](#)

Motherboard Map

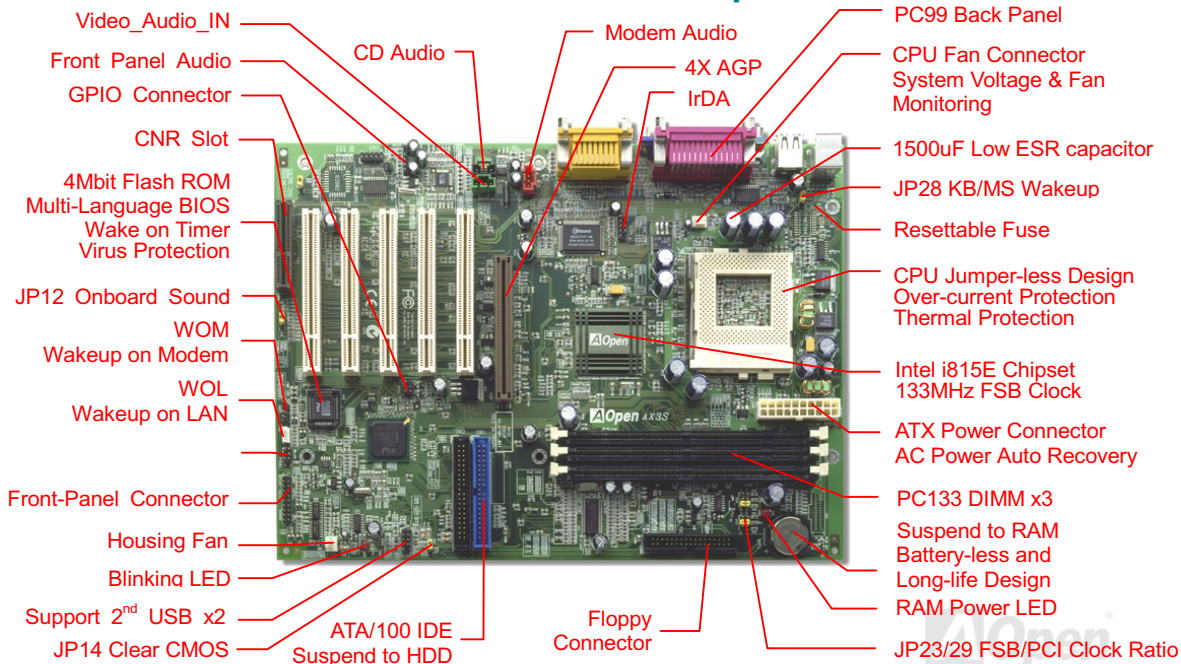

Block Diagram

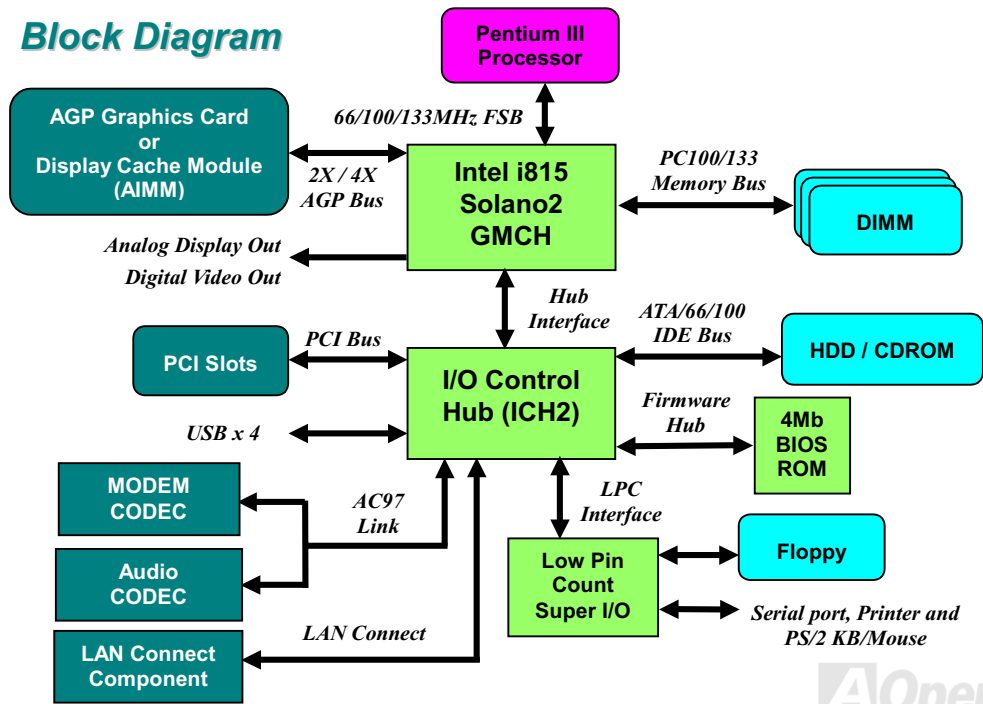

Hardware

This chapter describes jumpers, connectors and hardware devices of this motherboard.



Note: *Electrostatic discharge (ESD) can damage your processor, disk drives, expansion boards, and other components. Always observe the following precautions before you install a system component.*

- 1. Do not remove a component from its protective packaging until you are ready to install it.*
- 2. Wear a wrist ground strap and attach it to a metal part of the system unit before handling a component. If a wrist strap is not available, maintain contact with the system unit throughout any procedure requiring ESD protection.*

JP14 Clear CMOS

You can clear CMOS to restore system default setting. To clear the CMOS, follow the procedure below.

1. Turn off the system and unplug the AC power.
2. Remove ATX power cable from ATX power connector.
3. Locate JP14 and short pins 2-3 for a few seconds.
4. Return JP14 to its normal setting by shorting pins 1-2.
5. Connect ATX power cable back to ATX power connector.



Normal Operation
(default)



Clear CMOS

Tip: When should I Clear CMOS?

1. Boot fail because of overclocking...
2. Forget password...
3. Troubleshooting...

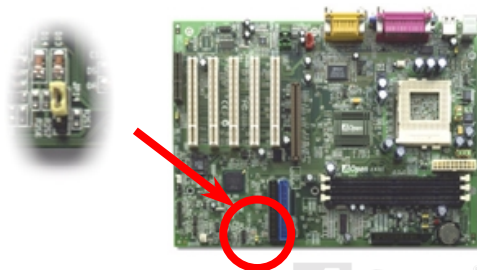

JP28 Keyboard/Mouse Wakeup

This jumper is used to enable or disable Keyboard/Mouse Wake Up function. If you select Enable, you can decide the wake up mode from BIOS Setup > Integrated Peripherals > [Power On Function](#). To implement this function, the power supply 5V standby current must be greater than 800mA. Note that only PS/2 mouse supports Wake on Mouse function.

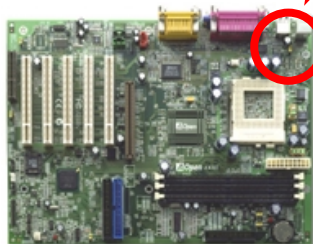
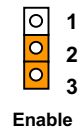
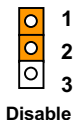

Tip: You have to wait for system to successfully boot from operation system (such as Windows or DOS) before the Wake-On-Keyboard/Mouse can take effect. This is because the information of how to support this function must be stored into Super I/O Controller and then you can use it for next power on.

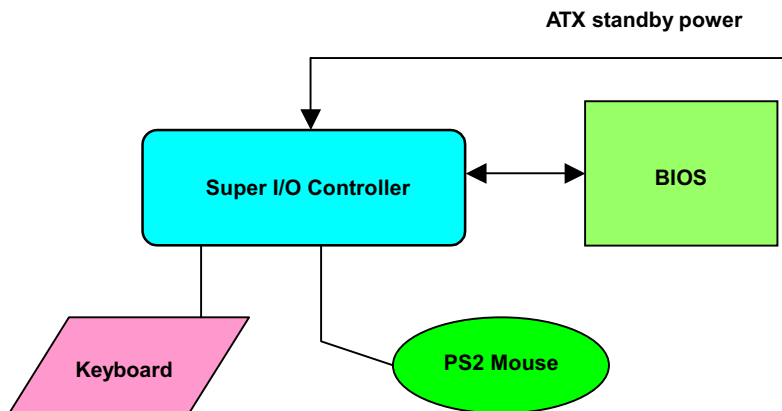

CPU Socket and Fan Connector

Plug CPU to Socket370 connector. Be careful of CPU orientation. Plug in the fan cable to the 3-pin CPUFAN or FAN 1 connector.

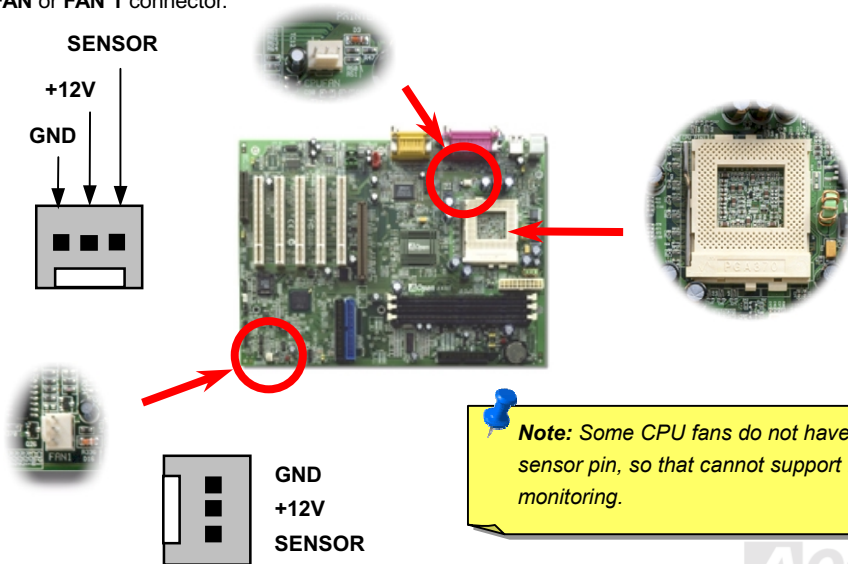

CPU Jumper-less Design

CPU VID signal and [SMBus](#) clock generator provide CPU voltage auto-detection and allows the user to set the CPU frequency through the [BIOS setup](#), therefore no jumpers or switches are used. The correct CPU information is saved into the [EEPROM](#). With these technologies, the disadvantages of the Pentium based jumper-less designs are eliminated. There will be no worry of wrong CPU voltage detection and no need to re-open the housing in case of CMOS battery loss.

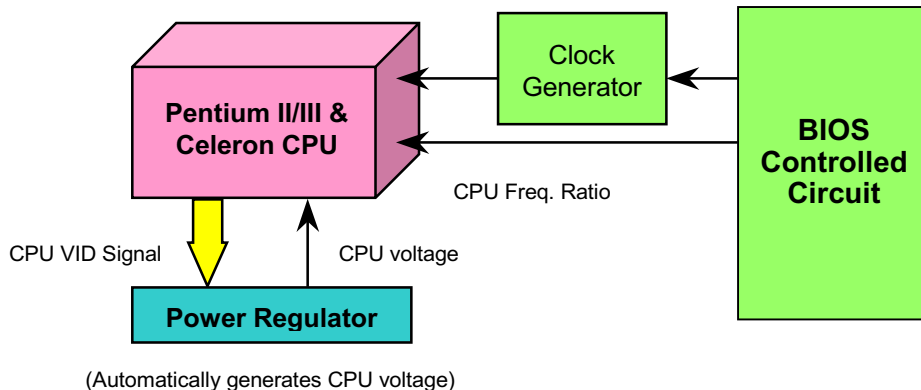

Setting CPU Frequency

This motherboard is CPU jumper-less design, you can set CPU frequency through the BIOS setup, no jumpers or switches are needed.

BIOS Setup > Frequency / Voltage Control > [CPU Speed Setup](#)

CPU Ratio	x2, x2.5, x 3, x 3.5, x 4, x 4.5, x 5, x 5.5, x 6, x 6.5, x 7, x 7.5, and x8
CPU FSB	66.6, 66.8, 68.3, 75.3, 78, 80, 95, 100, 100.2, 105, 110, 114, 117, 122, 127, 129, 133.3, 133.6, 138, 140, 144, 146.4, 150, 157.3, 160 and 166 MHz



Warning: INTEL I815E chipset supports maximum 133MHz FSB and 66MHz AGP clock, higher clock setting may cause serious system damage.



Tip: If your system hangs or fails to boot because of overclocking, simply use JP14 to clear CMOS and restore to the default setting.

Core Frequency = CPU FSB Clock * CPU Ratio

CPU Type	CPU Core Frequency	FSB Clock	Ratio
CELERON 300A	300 MHz=	66 MHZ	4.5x
CELERON 366	366 MHz=	66 MHZ	5.5x
CELERON 433	433 MHz=	66 MHZ	6.5x
CELERON 466	466 MHz=	66 MHZ	7x
CELERON 500	500 MHz=	66 MHZ	7.5x
CELERON 533	533 MHz=	66 MHZ	8x
Pentium II 350	350 MHz=	100 MHZ	3.5x
Pentium II 400	400 MHz =	100 MHZ	4x
Pentium III 450	450 MHz=	100 MHZ	4.5x
Pentium III 500	500 MHz =	100 MHZ	5x
Pentium III 533EB	533 MHz =	133 MHZ	4x
Pentium III 550E	550 MHz =	100 MHZ	5.5x
Pentium III 600E	600 MHz =	100 MHZ	6x
Pentium III 600EB	600 MHz =	133 MHZ	4.5x
Pentium III 650E	650 MHz =	100 MHZ	6.5x
Pentium III 667EB	667 MHz =	133 MHZ	5x
Pentium III 700E	700 MHz =	100 MHZ	7x
Pentium III 733EB	733 MHz =	133 MHZ	5.5x
Pentium III 866EB	866 MHz =	133 MHZ	6.5x

JP23/JP29 FSB/PCI Clock Ratio

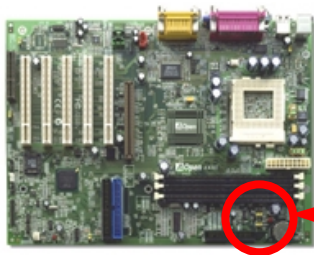

This jumper is used to specify the relationship of PCI and [FSB](#) clock. Generally speaking, if you are not overclockers, we recommend to set at the default setting.

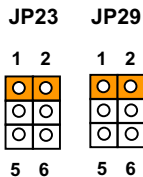

Auto
(default)

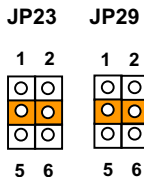

4X
(122~166 MHz)

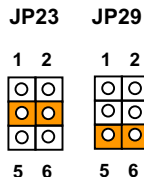

3X
(95~133.6 MHz)

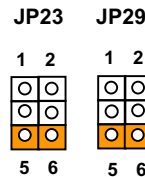

2X
(66.8~80MHz)



DIMM Socket

This motherboard has three 168-pin [DIMM sockets](#) that allow you to install [PC133](#) memory up to 512 MB. Only SDRAM is supported.

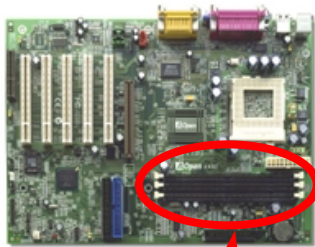

Pin 1

DIMM1
DIMM2
DIMM3



Tip: The driving capability of new generation chipset is limited due to the lack of a memory buffer (to improve performance). This makes DRAM chip count an important factor to take into consideration when you install DIMMs. Unfortunately, there is no way that the BIOS can identify the correct chip count; you need to calculate the chip count by yourself. The simple rule is: **By visual inspection, use only DIMMs, which are less than 16 chips.**

RAM Power LED & Blinking LED

The **RAM Power LED** indicates there is power applies to memory. It is useful to check RAM power during Suspend to RAM. Do not unplug DIMM when this LED is On.

The **Blinking LED** shows you whether system is boot OK. It will continue blinking while system is at POST procedure, and keep ON while system boot successfully.

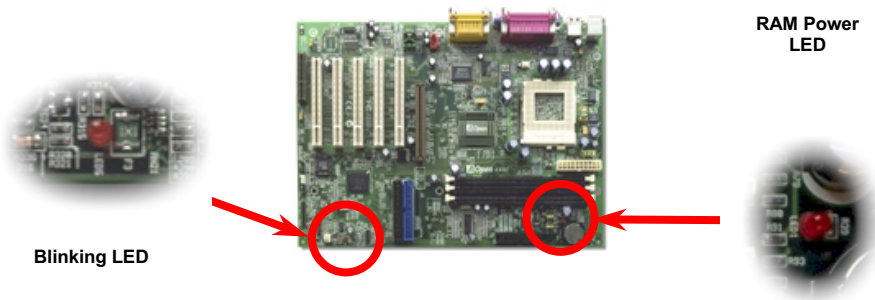

Front Panel Connector

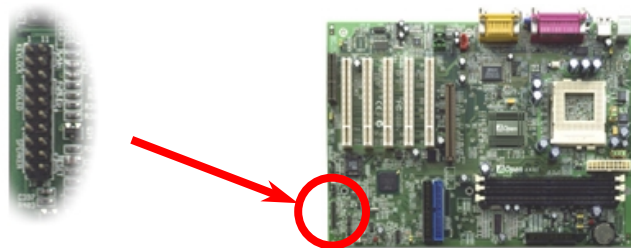
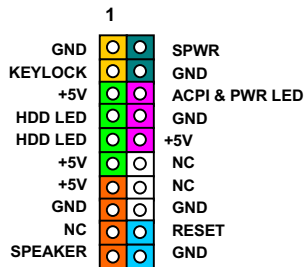
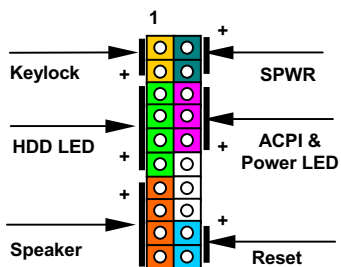

Attach the power LED, keylock, speaker, and reset switch connectors to the corresponding pins. If you enable Power Management Setup > [ACPI Function](#) in BIOS Setup, the ACPI & Power LED will keep flashing while the system is in suspend mode.

Suspend Type	ACPI LED
Power on Suspend (S1)	Flashing for every 0.5 second
Suspend to RAM (S3)	Flashing for every 1 seconds

Locate the power switch cable from your ATX housing. It is 2-pin female connector from the housing front panel. Plug this connector to the soft-power switch connector marked **SPWR**.

ATX Power Connector

The ATX power supply uses 20-pin connector shown below. Make sure you plug in the right direction.

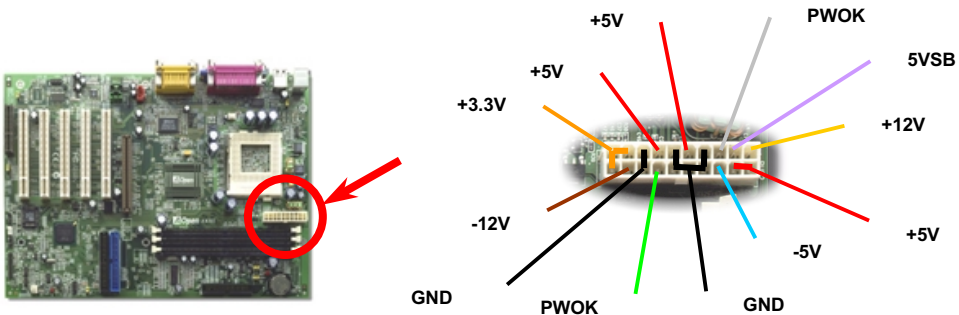

Warning: For ATX system, there is always a standby current on the motherboard. Please make sure that you have unplugged the ATX power cable from the connector before you insert or pull out any CPU, DIMM, PCI and AGP cards. Otherwise, a serious component damage may occur.

AC Power Auto Recovery

A traditional ATX system should remain at power off stage when AC power resumes from power failure. This design is inconvenient for a network server or workstation, without an UPS, that needs to keep power-on. This motherboard implements an AC Power Auto Recovery function to solve this problem. If BIOS Setup > Integrated Peripherals > [AC PWR Auto Recovery](#) is set to "Enabled" the system will automatically power-on after AC power resumes.

IDE and Floppy Connector

Connect 34-pin floppy cable and 80-pin IDE cable to floppy connector FDC and IDE connector **IDE1**, **IDE2**. Pin1 of cable is normally marked with red color. Be careful of the pin1 orientation. Wrong orientation may cause system damage.

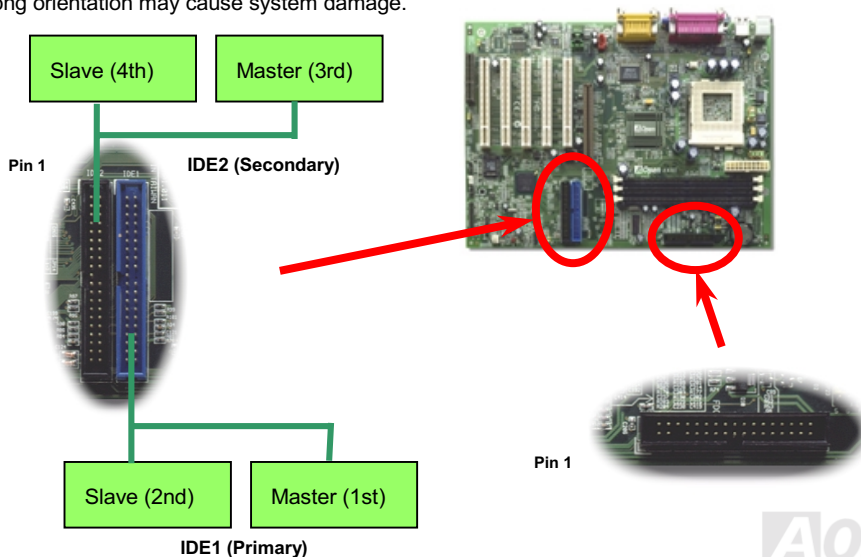

IDE1 is also known as the primary channel and IDE2 as the secondary channel. Each channel supports two IDE devices that make a total of four devices. In order to work together, the two devices on each channel must be set differently to **master** and **slave** mode. Either one can be the hard disk or the CDROM. The setting as master or slave mode depends on the jumper on your IDE device, so please refer to your hard disk and CDROM manual accordingly.



Warning: *The specification of the IDE cable is a maximum of 46cm (18 inches), make sure your cable does not exceed this length.*



Tip: *For better signal quality, it is recommended to set the far end side device to master mode and follow the suggested sequence to install your new device. Please refer to above diagram.*

This motherboard supports [ATA/100 IDE](#). Following table lists the transfer rate of IDE PIO and DMA modes. The IDE bus is 16-bit, which means every transfer is two bytes.

Mode	Clock Period	Clock Count	Cycle Time	Data Transfer Rate
PIO mode 0	30ns	20	600ns	$(1/600\text{ns}) \times 2\text{byte} = 3.3\text{MB/s}$
PIO mode 1	30ns	13	383ns	$(1/383\text{ns}) \times 2\text{byte} = 5.2\text{MB/s}$
PIO mode 2	30ns	8	240ns	$(1/240\text{ns}) \times 2\text{byte} = 8.3\text{MB/s}$
PIO mode 3	30ns	6	180ns	$(1/180\text{ns}) \times 2\text{byte} = 11.1\text{MB/s}$
PIO mode 4	30ns	4	120ns	$(1/120\text{ns}) \times 2\text{byte} = 16.6\text{MB/s}$
DMA mode 0	30ns	16	480ns	$(1/480\text{ns}) \times 2\text{byte} = 4.16\text{MB/s}$
DMA mode 1	30ns	5	150ns	$(1/150\text{ns}) \times 2\text{byte} = 13.3\text{MB/s}$
DMA mode 2	30ns	4	120ns	$(1/120\text{ns}) \times 2\text{byte} = 16.6\text{MB/s}$
UDMA/33	30ns	4	120ns	$(1/120\text{ns}) \times 2\text{byte} \times 2 = 33\text{MB/s}$
UDMA/66	30ns	2	60ns	$(1/60\text{ns}) \times 2\text{byte} \times 2 = 66\text{MB/s}$
UDMA/100	20ns	2	40ns	$(1/40\text{ns}) \times 2\text{byte} \times 2 = 100\text{MB/s}$

 **Tip:** To achieve the best performance of Ultra DMA/100 hard disks, a special **80-wires IDE cable** is required.

IrDA Connector

The IrDA connector can be configured to support wireless infrared module, with this module and application software such as Laplink or Windows 95 Direct Cable Connection, the user can transfer files to or from laptops, notebooks, PDA devices and printers. This connector supports SIR (115.2Kbps, 2 meters) and ASK-IR (57.6Kbps).

Install the infrared module onto the **IrDA** connector and enable the infrared function from BIOS Setup > Integrated Peripherals > [UART Mode Select](#), make sure to have the correct orientation when you plug in the IrDA connector.

	1	2		
+5V	●	●	NC	
NC	●	●	CIRRX	
IRRX	●	●	5VSB	
GND	●	●	NC	
IRTX	●	●	NC	
	9	10		

Pin 1

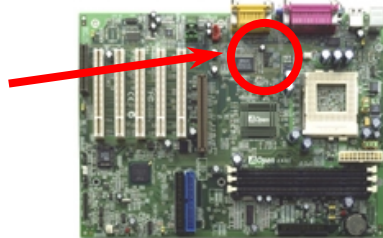

GPIO-Connector (General Purpose I/O) (Optional)

GPIO (General Purpose Input / Output) is an advanced specification developed by AOpen for power users to define the further function by oneself. For example, you can design a daughter board to provide additional capabilities, such as an alarm, a buzzer, a timekeeper, etc.

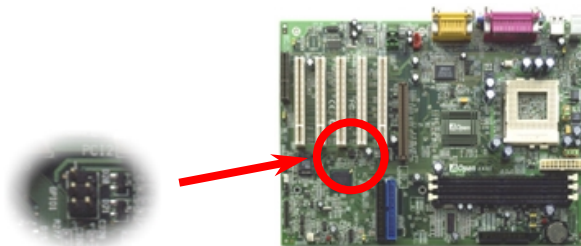
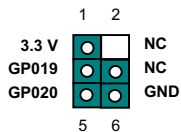

WOM (Zero Voltage Wake on Modem)

This motherboard implements special circuit to support Wake On Modem, both internal modem card and external box modem are supported. Since Internal modem card consumes no power when system power is off, it is recommended to use an internal modem. To use internal modem, connect 4-pin cable from **RING** connector of modem card to the **WOM** connector on the motherboard.

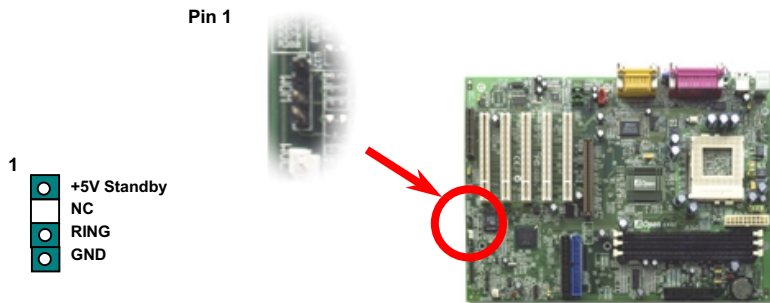

WOM by External BOX Modem

Traditional Green PC suspend mode does not really turn off the system power supply, it uses external box modem to trigger MB COM port and resume back to active.

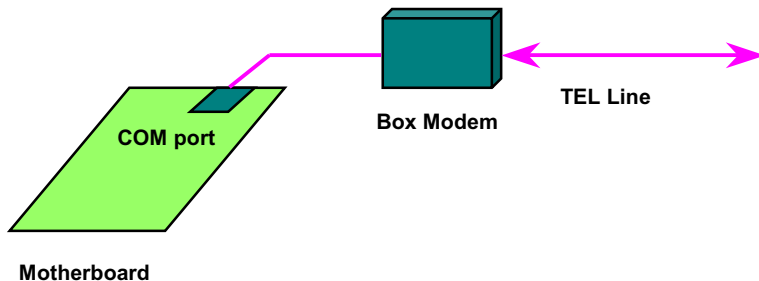

WOM by Internal Modem Card

With the help of the ATX soft power On/Off, it is possible to have a system totally power off, and wakeup to automatically answer a phone call as an answering machine or to send/receive a fax. You may identify whether or not your system is in true power off mode by checking to see if the fan of your power supply is off. Both an external box modem and an internal modem card can be used to support Modem Wake Up, but if you use an external modem, you have to leave your box modem on.

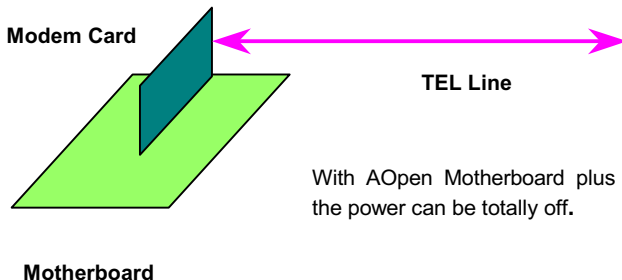

With AOpen Motherboard plus AOpen Modem Card, the power can be totally off.

WOL (Wake on LAN)

This feature is very similar as [Wake On Modem](#), but it goes through local area network. To use Wake On LAN function, you must have a network card with chipset that supports this feature, and connect a cable from LAN card to motherboard WOL connector. The system identification information (probably IP address) is stored on network card and because there is a lot of traffic on the Ethernet, you need to install a network management software, such as ADM, for the checking of how to wake up the system. Note that, at least 600mA ATX standby current is required to support the LAN card for this function.

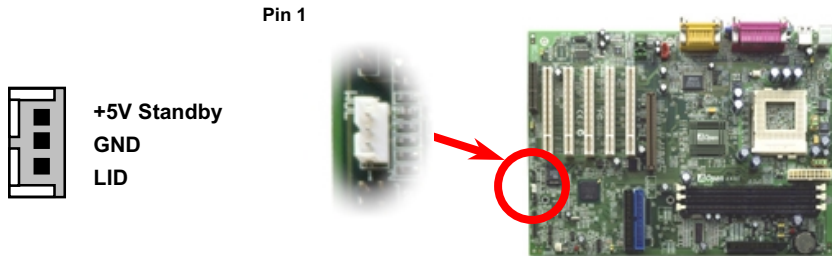

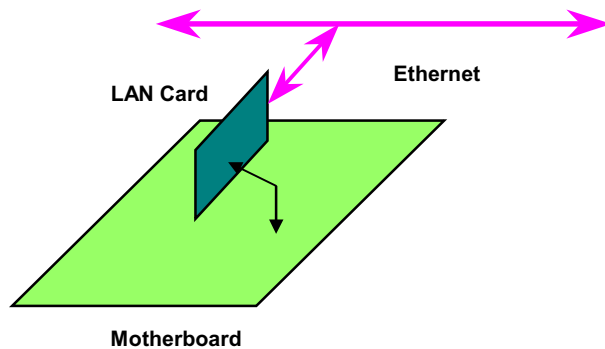

4X AGP (Accelerated Graphic Port)

This motherboard supports 4X [AGP](#). AGP is a bus interface designed for high-performance 3D graphic and supports only memory read/write operation. One motherboard can only have one AGP slot. **2X AGP** uses both rising and falling edge of the 66MHz clock, the data transfer rate is $66\text{MHz} \times 4 \text{ bytes} \times 2 = 528\text{MB/s}$. **4X AGP** is still using 66MHz AGP clock but the it has 4 data transfers within one 66MHz clock cycle, so that the data transfer rate will achieve the maximum of $66\text{MHz} \times 4 \text{ bytes} \times 4 = 1056\text{MB/s}$.

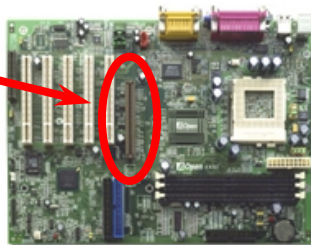
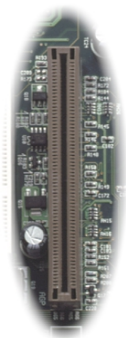

CNR (Communications and Networking Riser)

CNR is a riser card specification to replace the AMR, (Audio/Modem Riser) which supports V.90 analog modem, multi-channel audio, phone-line based networking, and 10/100 Ethernet based networking. Owing to CPU computing power getting stronger, the digital processing job can be implemented in main chipset and share CPU power. The analogy conversion ([CODEC](#)) circuit requires a different and separate circuit design, which is put on CNR card. This motherboard implements sound CODEC on board (can be disabled by JP12), but reserve CNR slot for the option of modem function. Note that you can still use PCI modem card.

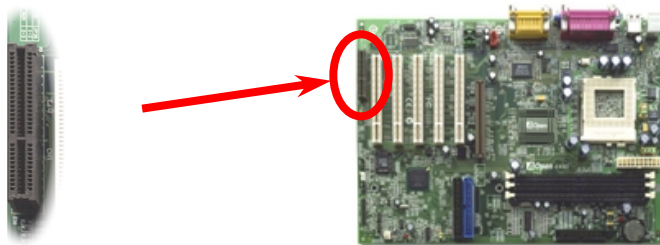

This motherboard is [AC97](#) sound onboard. That is, audio CODEC is put on motherboard and modem function is supported by CNR card.

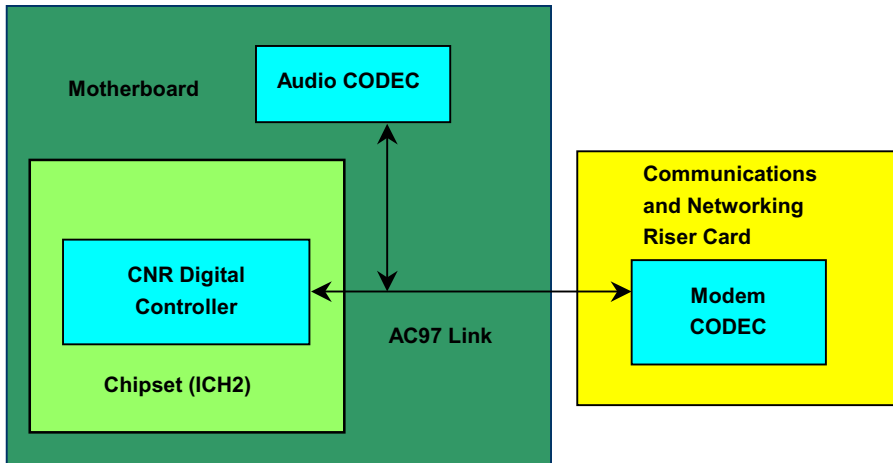

PC99 Color Coded Back Panel

The onboard I/O devices are PS/2 Keyboard, PS/2 Mouse, serial ports COM1 and VGA, Printer, [four USB](#), AC97 sound and Game port. The view angle of drawing shown here is from the back panel of the housing.

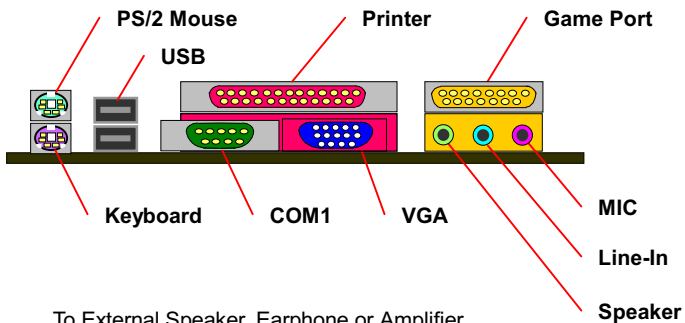

Speaker: To External Speaker, Earphone or Amplifier.

Line-In: From signal source such as CD/Tape player.

MIC: From Microphone

Support 4 USB Ports

This motherboard supports four USB ports. Two of them are on back panel connector, the other two are on the left-bottom area of this motherboard. With proper cable, you can connect them to front panel.

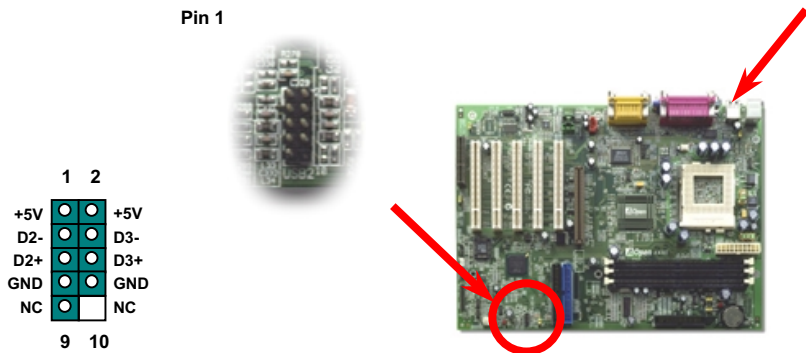

JP12 Enable/Disable Onboard Sound Chip

This motherboard has [AC97](#) sound onboard. JP12 is used to enable or disable onboard AD1885 [CODEC](#) chip. If you select Disable, you can use your preferred PCI sound card or CNR card.

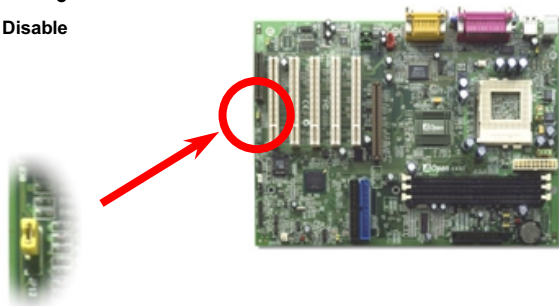
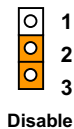
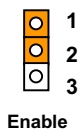

CD Audio Connector

This **black** connector is used to connect CD Audio cable from CDROM or DVD drive to onboard sound.



Pin 1

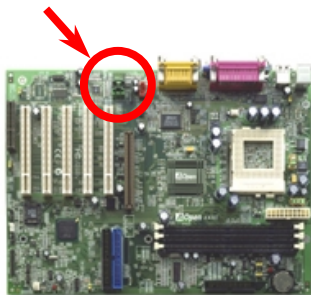

CD-IN



4 3 2 1

R G G L
N N
D D

Video_Audio_IN Connector

This **green** connector is used to connect MPEG Audio cable from MPEG card to onboard sound.



Pin 1

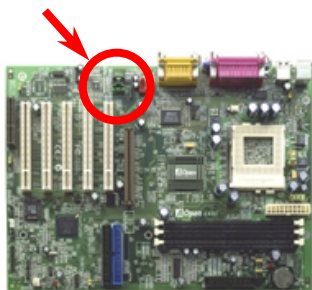

VIDEO_AUDIO_IN

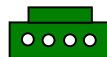

4 3 2 1

R G G L
N N
D D

Modem Audio Connector

This connector is used to connect Mono In/Mic Out cable from internal modem card to onboard sound circuit. The pin 1-2 is **Mono In**, and the pin 3-4 is **Mic Out**. Please note that there is no standard for this kind of connector yet, only some internal modem cards implement this connector.



Pin 1

MODEM-CN

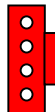

4
3
2
1

Mic Out (to Modem)
GND
GND
Mono In (from Modem)

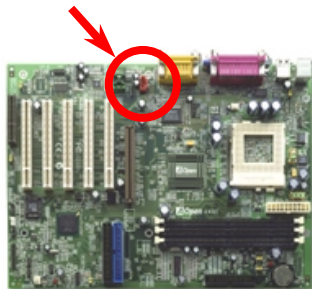



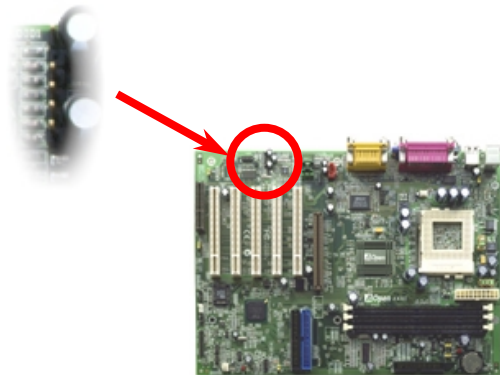

Front Panel Audio (Optional)

If the housing has been design with an audio port on the front panel, you'll be able to connect onboard audio to front panel through this connector.

Pin 1



	1 GND
	2 NC
	3 Phone_R
	4 Phone_L
	5 NC
	6 FP_Mic

Battery-less and Long Life Design

This Motherboard implements [EEPROM](#) and a special circuit that allows you to save your current CPU and CMOS Setup configurations without the need of a battery. The RTC (real time clock) can also keep running as long as the power cord is plugged. If you lose your CMOS data by accident, you can just reload the CMOS configurations from EEPROM and the system will recover as usual.



Tip: For your convenience, this motherboard is still shipped with one Lithium (CR-2032) battery in the battery socket. If you prefer to use battery, you can keep it in the socket. The RTC will still keep running even power cord is removed.

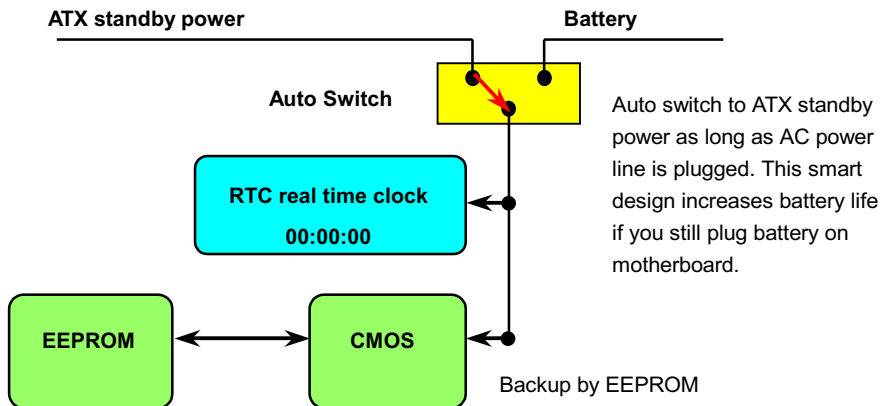

Over-current Protection

The Over Current Protection was very popular implemented on ATX 3.3V/5V/12V switching power supply. However, the new generation CPU uses different voltage that has regulator to transfer 5V to CPU voltage (for example, 2.0V), and makes 5V over current protection useless. This motherboard with switching regulator onboard support CPU over-current protection, in conjunction with 3.3V/5V/12V power supply provide the full line over-current protection.

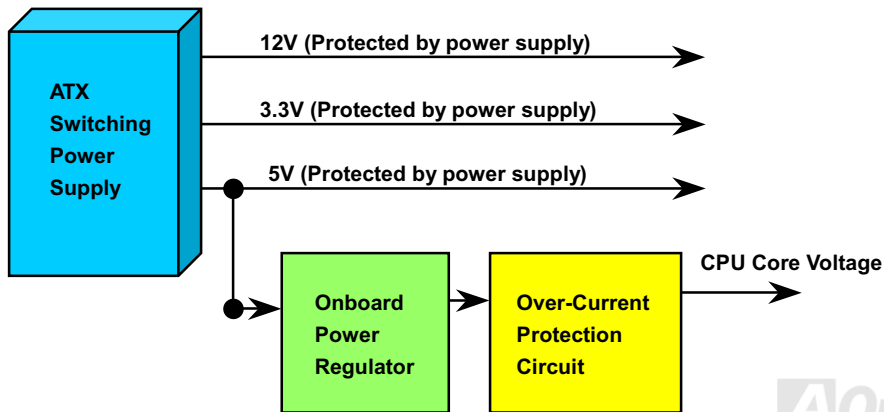



Note: Although we have implemented protection circuit try to prevent any human operating mistake, there is still certain risk that CPU, memory, HDD, add-on cards that install on this motherboard may be damaged because of component failure, human operating error or unknown nature reason. **AOpen cannot guaranty the protection circuit will always work perfectly.**

Hardware Monitoring

This motherboard implements a hardware monitoring system. As you turn on your system, this smart design will continue to monitor your system's working voltage, fan status and CPU temperature. If any of these systems status goes wrong, there will be an alarm through the AOpen [Hardware Monitoring Utility](#) to warn the user.

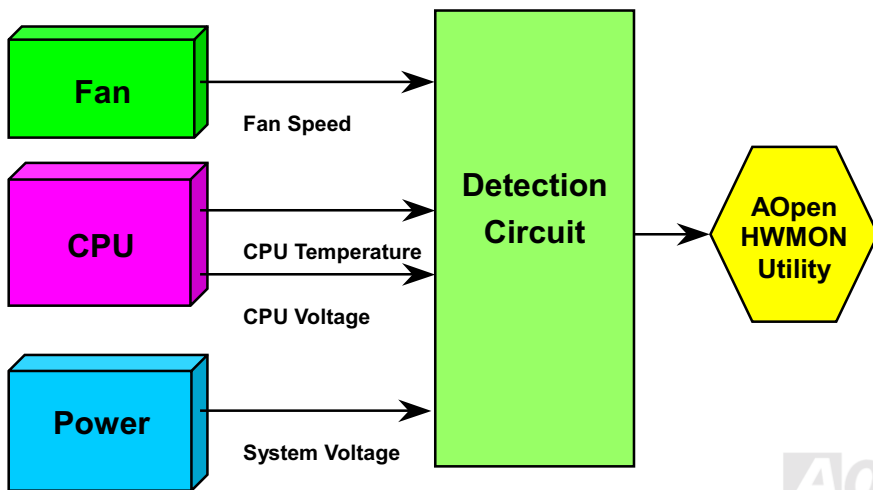

Resettable Fuse

Traditional motherboard has fuse for Keyboard and [USB](#) port to prevent over-current or shortage. These fuses are soldered onboard that when it is broken (did the job to protect motherboard), user still cannot replace it and the motherboard is still malfunction.

With expensive Resettable Fuse, the motherboard can back to normal function after fuse did the protection job.



The green part at the both side of JP28.

BIOS Write Protection

Recently, many viruses have been found that may destroy bios code and data area. This motherboard implements two layers firewall to protect from unauthorized writing to BIOS. One is hardware and the other is [software](#).

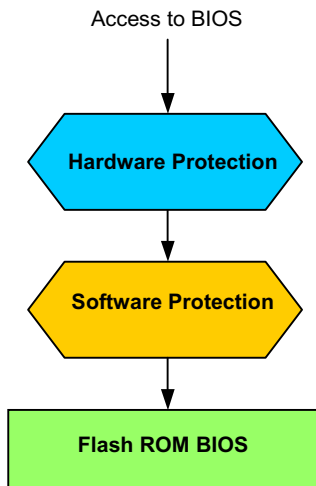

Year 2000 (Y2K)

Y2K is basically a problem of the identification of year code. To save storage space, traditional software uses only two digits for year identification. For example, 98 for 1998 and 99 for 1999, but 00 will be confused with 1900 and 2000.

There is an RTC circuit (Real Time Clock) in conjunction with 128 bytes of CMOS RAM data in the chipset of the motherboard. The RTC has only two digits and the CMOS has another 2 digits.

Unfortunately, this circuit's behavior is like this 1997 → 1998 → 1999 → 1900, that means it may have the Y2K problem. Below is a diagram of how applications work with the OS, BIOS and RTC. In order to keep the best compatibility in the PC industry there is a rule that applications must call the OS to get services and OS must call the BIOS, and then only BIOS is allowed to access the hardware (RTC) directly.

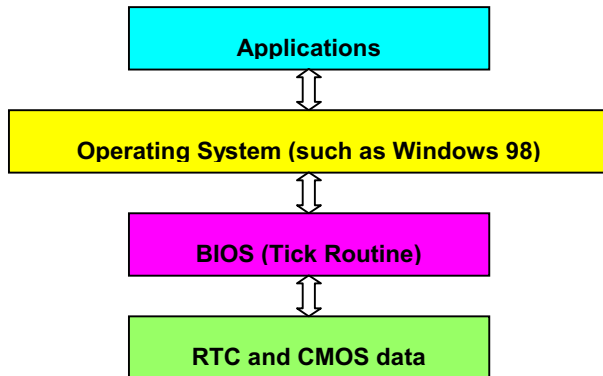

There is a Tick Routine (that goes live around every 50m sec) in the BIOS to keep record of date/time information. In general the BIOS, this Tick Routine does not update the CMOS every time because the CMOS is a very slow device which degrades system performance. The Tick Routine of the AOpen BIOS has 4 digits for year coding, as long as applications and the operating system follow the rule to get date/time information. There will be no Y2K problem (such as NSTL's test program). But unfortunately again, we found some test programs (such as Checkit 98) accesses RTC/CMOS directly.

1500uF Low ESR Capacitor

The quality of low ESR capacitor (Low Equivalent Series Resistance) during high frequency operation is very important for stability of CPU power. The location of where to put these capacitors is another know-how that requires experience and detail calculation.

Not only that, this motherboard implements **1500uF capacitors**, which is much larger than normal (1000uF) and provide better stability for CPU power.

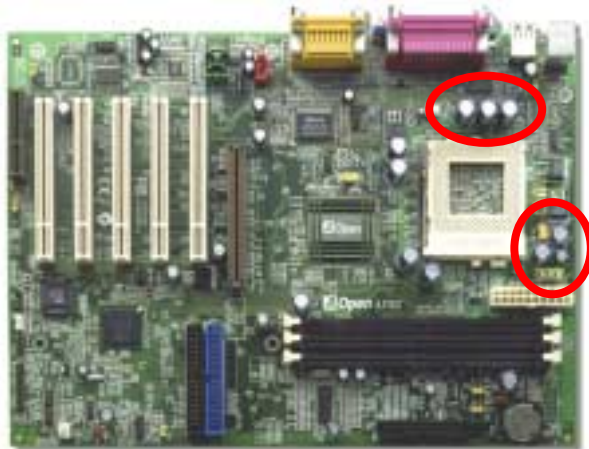

The power circuit of the CPU core voltage must be checked to ensure system stability for high speed CPUs (such as the new Pentium III, or when overclocking). A typical CPU core voltage is 2.0V, so a good design should control voltage between 1.860V and 2.140V. That is, the transient must be below 280mV. Below is a timing diagram captured by a Digital Storage Scope, it shows the voltage transient is only 143mV even when maximum 18A current is applied.

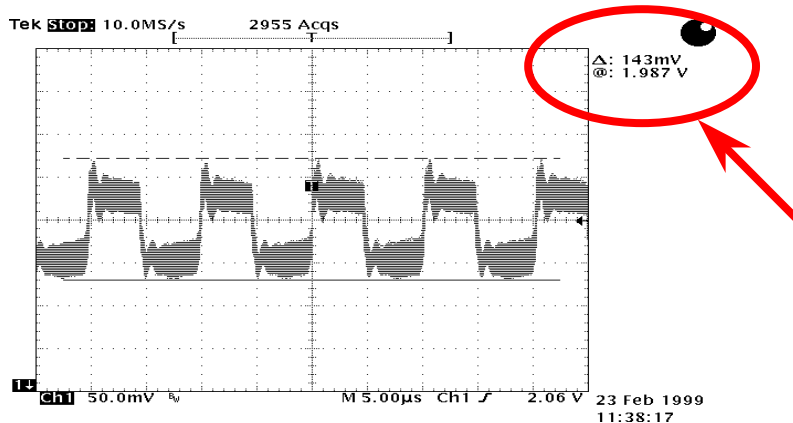

Note: This diagram is for example only, it may not be exactly the same as this motherboard.

Layout (Frequency Isolation Wall)

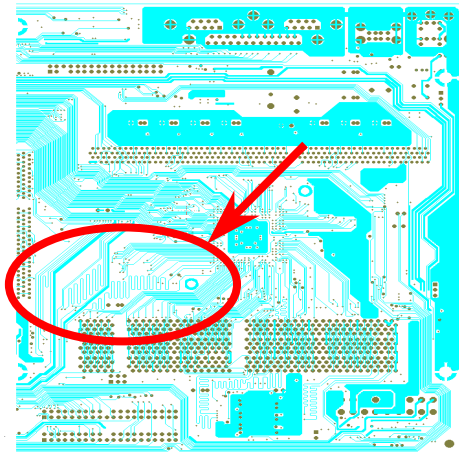

Note: This diagram is for example only, it may not be exactly the same as this motherboard.

For high frequency operation, especially overclocking, layout is the most important factor to make sure chipset and CPU working in stable condition. The layout of this motherboard implements AOpen's unique design called "Frequency Isolation Wall". Separating each critical portion of motherboard into regions where each region operates in a same or similar frequency range to avoid crosstalk and frequency interference between each region's operations and condition. The trace length and route must be calculated carefully. For example, the clock trace must be equal length (not necessarily as short as possible) so that clock skew will be controlled within few a pico second ($1/10^{12}$ Sec)

Driver and Utility

There are motherboard drivers and utilities included in [AOpen Bonus CD disc](#). You don't need to install all of them in order to boot your system. But after you finish the hardware installation, you have to install your operation system first (such as Windows 98) before you can install any drivers or utilities. Please refer to your operation system's installation guide.

Autorun Menu from Bonus CD Disc

You can use the autorun menu of Bonus CD disc. Choose the utility and driver and select model name

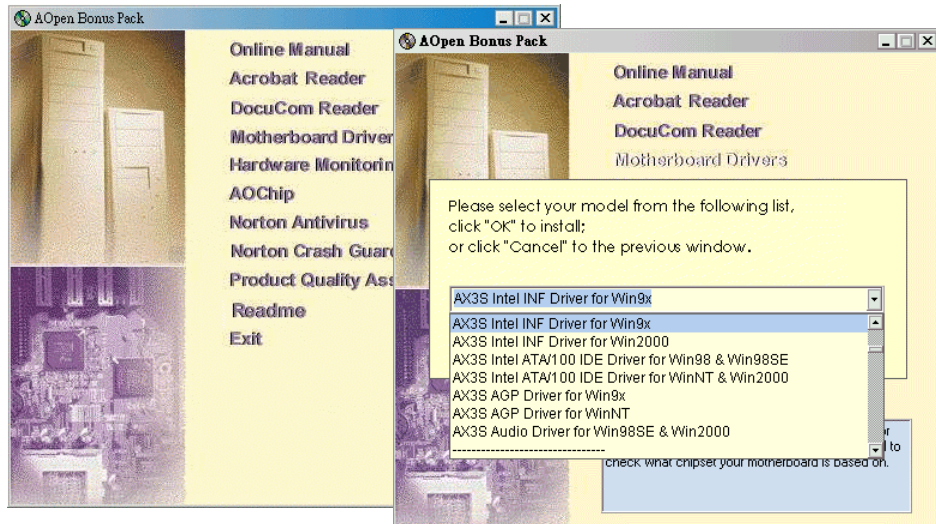

Eliminate “?” mark from Windows 95/98

Windows 95/98 cannot recognize this chipset, because it was released before the Intel i815E chipset. You can install the Intel INF Update Utility from the Bonus Pack CD disc autorun menu to eliminate the “?” marks.

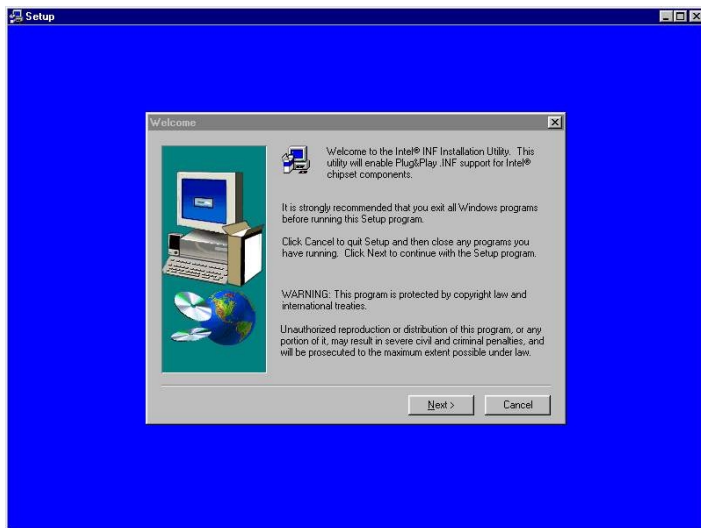

Installing Onboard AGP Driver

Intel i815E(Solano) integrates a 2D/3D graphics accelerator and provides AGP 2X/4X incredible performance to access main memory at over 1GB/s. You can find the audio driver from the Bonus Pack CD disc autorun menu.

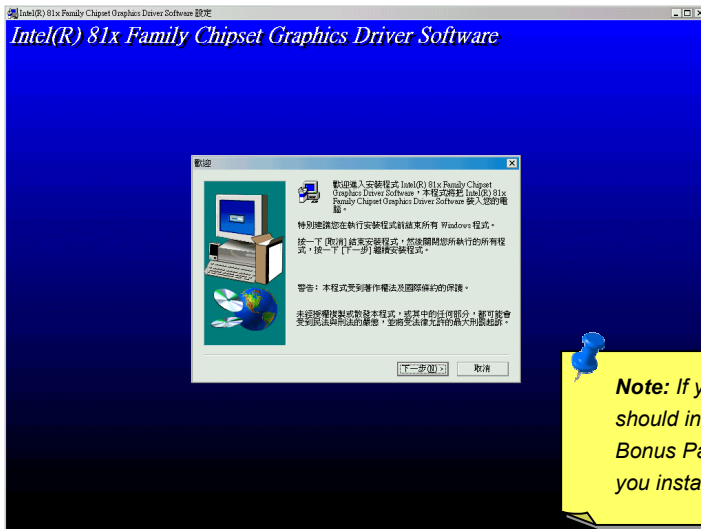

Installing Onboard Sound Driver

This motherboard comes with an AD1885 [AC97 CODEC](#). You can find the audio driver from the Bonus Pack CD disc autorun menu.

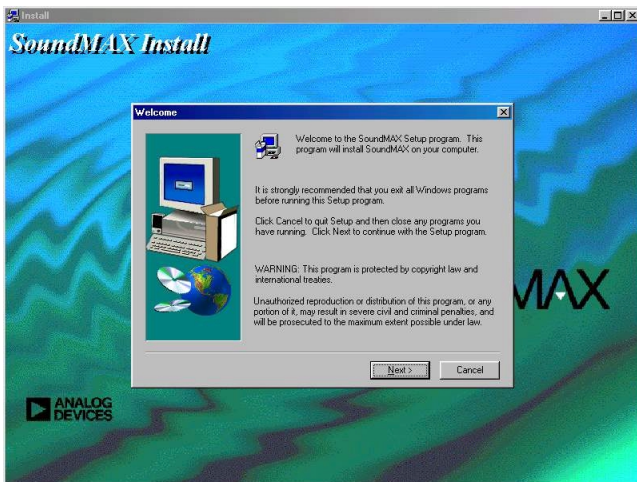

Installing Ultra ATA/100 IDE Driver

It is necessary to install [Bus Master IDE](#) driver to support [ATA/100](#) hard disk. If you need this driver, you can find it in the [AOpen Bonus Pack](#) CD disc.

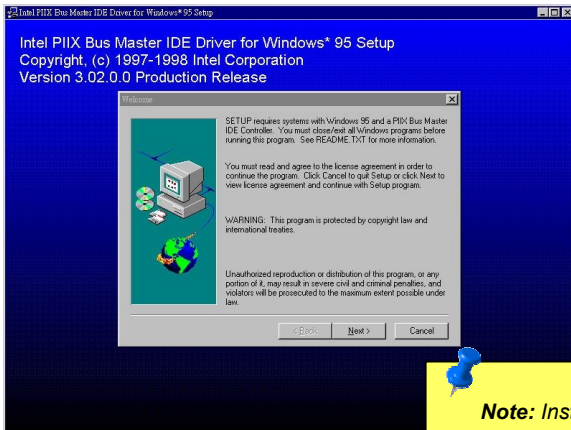

Note: Installing this ATA/100 IDE driver may cause Suspend to Hard Drive failure.

Installing Hardware Monitoring Utility

You can install Hardware Monitoring Utility to monitor CPU temperature, fans and system voltage.

You can find it in the [AOpen Bonus Pack](#) CD disc.



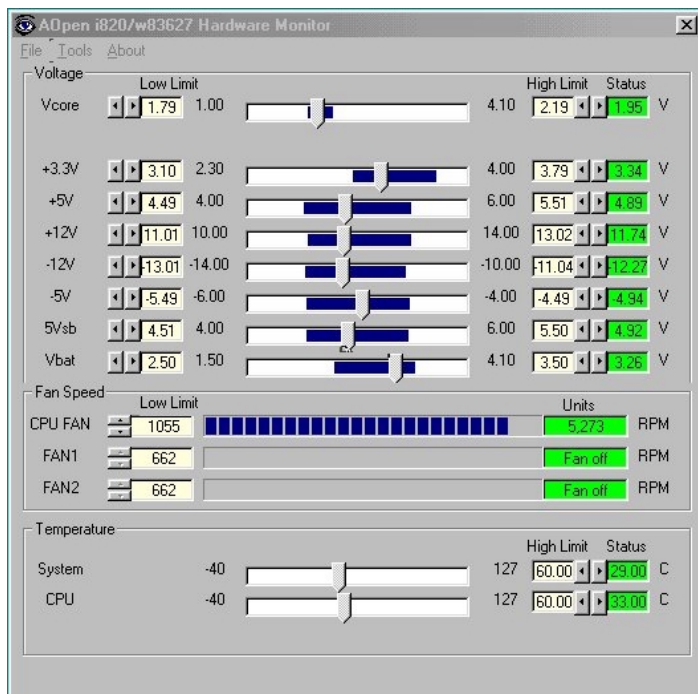

ACPI Suspend to Hard Drive

[ACPI](#) Suspend to Hard Drive is basically controlled by Windows operation system. It saves your current work (system status, memory and screen image) into hard disk, and then the system can be totally power off. Next time, when power is on, you can resume your original work directly from hard disk within few seconds without go through the Windows booting process and run your application again. If your memory is 64MB, normally, you need to reserve at least 64MB HDD space to save your memory image.

When go into Suspend:

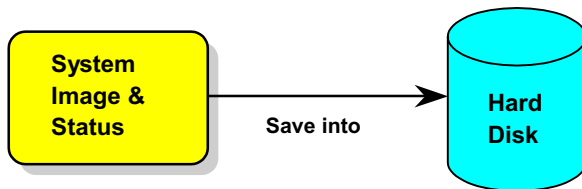

When power-on next time:

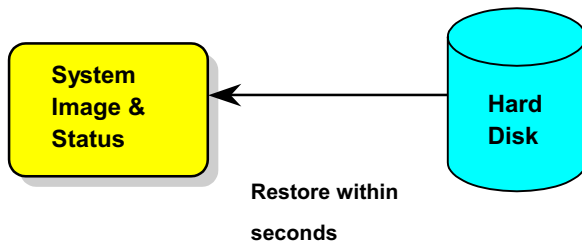

System Requirement

1. **AOZVHDD.EXE 1.30** or later.
2. Delete **config.sys** and **autoexec.bat**.

Fresh installation of Windows 98 on a new system

1. Execute "**Setup.exe /p j**" to install Windows 98
2. After Windows 98's installation is complete, go to the Control Panel > Power Management.
 - a. Set Power Schemes > System Standby to "Never".
 - b. Click on "Hibernate" and select "Enable Hibernate Support" then "Apply".
 - c. Click on the "Advanced" tab, you'll see "Hibernate" on "Power Buttons". Note that this option will only be seen after step b mentioned above has been completed, otherwise only "Standby" and "Shutdown" will be shown. Select "Hibernate" and "Apply".
3. Clean boot into DOS and run AOZVHDD utility.
 - a. If you assign the whole disk to your Win 98 system (FAT 16 or FAT 32), please run "**aozvhd /c /file**". Please remember sufficient free space has to be reserved in the disk, e.g. if you have 64 MB DRAM and 16 MB VGA card installed, the system needs at least 80 MB free space. The utility will locate the space automatically.

- b. If you assign an individual partition for Win 98, please run "**aozvhd /c /partition**". Of course, the system needs to provide unformatted an empty partition.
4. Reboot system.
5. You've already implemented ACPI Suspend to-Hard Drive. Click "**Start > Shut Down > Standby**" then the screen will go off immediately. And 1 minute or so will be taken for the system to save what's in the memory to the hard drive; the larger the memory size the longer this process will take.

Changing from APM to ACPI (Windows 98 only)

1. Run "Regedit.exe"

- a. Go through the following path

HKEY_LOCAL_MACHINE

SOFTWARE

MICROSOFT

WINDOWS

CURRENT VERSION

DETECT

- b. Select "ADD Binary" and name it as "**ACPIOPTION**".
- c. Right click and select Modify, add "01" after "0000" to make it "0000 01".
- d. Save changes.

2. Select "Add New Hardware" under Control Panel. Allow Windows 98 to detect new hardware. (It will find "**ACPI BIOS**" and remove "**Plug and Play BIOS**")

3. Reboot system.

4. Clean boot into DOS and run "AOZVHDD.EXE /C /File"



Changing from ACPI to APM

1. Run "Regedit.exe"

- a. Go through the following path

HKEY_LOCAL_MACHINE

SOFTWARE

MICROSOFT

WINDOWS

CURRENT VERSION

DETECT

ACPI OPTION

- b. Right click and select "Modify, change "01" to "00" to make it "0000 02".



Tip: "02" means Windows 98 is ACPI acknowledged but the ACPI function is disabled.

- c. Save changes.

2. Select "Add New Hardware" under Control Panel. Allow Windows 98 to detect new hardware. (It will find "**Plug and Play BIOS**" and remove "**ACPI BIOS**")
3. Reboot system.
4. Run "Add New Hardware" again and it will find "Advanced Power Management Resource".
5. Click "OK".



Tip: Currently we found only ATI 3D Rage Pro AGP card would support ACPI suspend to disk. Please refer to AOpen web site for latest update.

ACPI Suspend to RAM (STR)

This motherboard supports ACPI Suspend to RAM function. With this function, you can resume your original work directly from DRAM without going through the Windows 98 booting process and run your application again. Suspend to DRAM saves your current work in the system memory, it is faster than Suspend to Hard Drive but requires power supplied to DRAM, while Suspend to Hard Drive requires no power.

When go into Suspend:

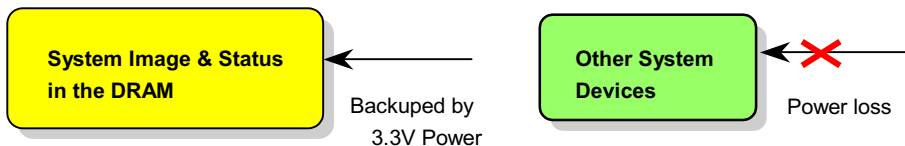

When power-on next time:

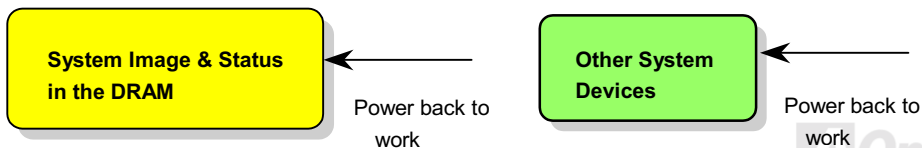

To implement ACPI Suspend to DRAM, please follow the procedures as below:

System Requirement

1. An ACPI OS is required. Currently, Windows 98 is the only choice. Please refer to [ACPI Suspend to Hard Drive](#) of how to setup Windows 98 ACPI mode.
2. The Intel INF Update Utility must be installed properly.

Procedures

1. Changed the following BIOS settings.

BIOS Setup > Power Management Setup > [ACPI Function](#) : Enabled

BIOS Setup > Power Management Setup > [ACPI Suspend Type](#) :S3.

2. Go to Control Panel > Power Management. Set "Power Buttons" to "Standby".
3. Press power button or standby button to wake up the system.

AWARD BIOS

System parameters can be modified by going into [BIOS](#) Setup menu, this menu allows you to configure the system parameters and save the configuration into the 128 byte CMOS area, (normally in the RTC chip or in the main chipset). [To enter to BIOS setup menu](#), press when [POST \(Power-On Self Test\)](#) screen is shown on your monitor.

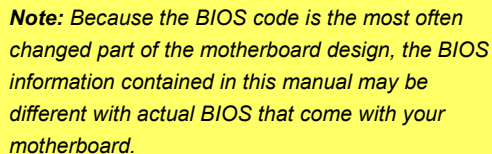

Note: Because the BIOS code is the most often changed part of the motherboard design, the BIOS information contained in this manual may be different with actual BIOS that come with your motherboard.

Enter BIOS Setup

Del

After you finish the setting of jumpers and connect correct cables. Power on and enter the BIOS Setup, press during [POST \(Power-On Self Test\)](#). Choose "[Load Setup Defaults](#)" for recommended optimal performance.

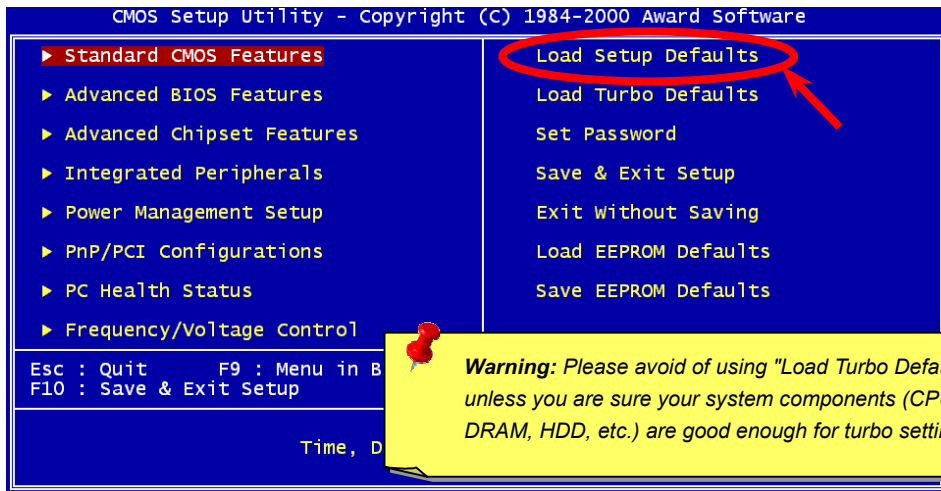

Change Language

F3

You can change language by press <F3>. Depends on available BIOS space. The possible languages are English, German, Japanese and Chinese.

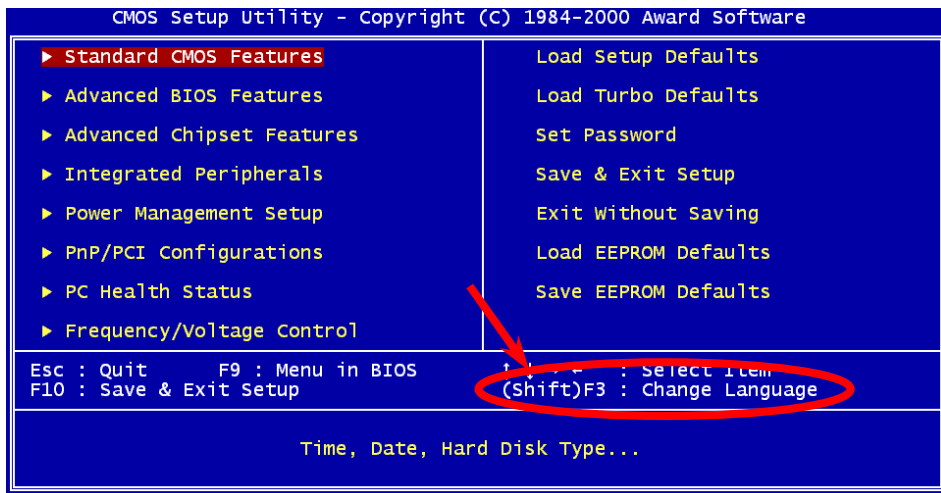

Standard CMOS Features

The "Standard CMOS Features" sets the basic system parameters such as the date, time, and the hard disk type. Use the arrow keys to highlight an item and <PgUp> or <PgDn> to select the value for each item.

```

CMOS Setup Utility - Copyright (C) 1984-2000 Award Software
Standard CMOS Features

```

Date (mm:dd:yy)	Thu, Apr 13 2000	Item Help
Time (hh:mm:ss)	15 : 55 : 44	Menu Level ▶
▶ IDE Primary Master	Press Enter 10243 MB	Change the day, month, year and century
▶ IDE Primary Slave	Press Enter 4311 MB	
▶ IDE Secondary Master	Press Enter None	
▶ IDE Secondary Slave	Press Enter None	
Drive A	1.44M, 3.5 in.	
Drive B	None	
Video	EGA/VGA	
Halt On	All Errors	
Base Memory	640K	
Extended Memory	65472K	
Total Memory	1024K	

```

] | ++: Move Enter: Select +/-/PU/PD: Value F10: Save ESC: Exit F1: General Help
F3: Language F5: Previous Values F6: Setup Defaults F7: Turbo Defaults

```

Standard CMOS Features > Date (mm:dd:yy)

To set the date, highlight the Date parameter. Press <PgUp> or <PgDn> to set the current date. The date format is month, date, and year.

Standard CMOS Features > Time (hh:mm:ss)

To set the time, highlight the Time parameter. Press <PgUp> or <PgDn> to set the current time in hour, minute, and second format. The time is based on the 24 hour military clock.

Standard CMOS Features > IDE Primary Master

Standard CMOS Features > IDE Primary Slave

Standard CMOS Features > IDE Secondary Master

Standard CMOS Features > IDE Secondary Slave

Press <Enter> to the next page for detail Hard Drive setting.

CMOS Setup Utility - Copyright (C) 1984-2000 Award Software
IDE Primary Master

IDE HDD Auto-Detection	Press Enter	Item Help
IDE Primary Master Access Mode	Auto Auto	Menu Level ▶▶
Capacity	10243	To auto-detect the HDD's size, head... on this channel
Cylinder	19846	
Head	16	
Precomp	0	
Landing Zone	19845	
Sector	63	

↑|←:Move Enter:Select +/-/PU/PD:Value F10:Save ESC:Exit F1:General Help
F3:Language F5:Previous Values F6:Setup Defaults F7:Turbo Defaults

Standard CMOS Features > IDE Primary Master > IDE HDD Auto-Detection

IDE HDD Auto-Dete ction

Select this item to detect the IDE hard disk parameters automatically at [POST](#) (Power-On Self Test), such as Size, Number of Cylinder, Number of Head, Start Cylinder for Pre-compensation, Cylinder number of Head Landing Zone and Number of Sector per Track.

Standard CMOS Features > IDE Primary Master > IDE Primary Master

IDE Primary Master

None
Auto
Manual

This item lets you select the IDE hard disk parameters manually. The default setting is **Auto**, which enables BIOS to automatically detect the parameters of installed HDD (Hard Disk Drive) at [POST](#) (Power-On Self Test). If you prefer to enter HDD parameters manually, select Manual. The IDE CDROM is always automatically detected.

Standard CMOS Features > IDE Primary Master > Access Mode

Access

Mode

Normal

LBA

Large

Auto

This item lets you select the transfer mode of your IDE hard disk. These parameters are Size, Number of Cylinder, Number of Head, Start Cylinder for Pre-compensation, Cylinder number of Head Landing Zone and Number of Sector per Track. The default setting is **Auto**, which enables BIOS to automatically detect the parameters of installed HDD (Hard Disk Drive) at [POST](#) (Power-On Self Test). If you prefer to enter HDD parameters manually, select Manual. The IDE CDROM is always automatically detected.

Standard CMOS Features > Drive A

Standard CMOS Features > Drive B

Drive A

None

360KB 5.25"

1.2MB 5.25"

720KB 3.5"

1.44MB 3.5"

2.88MB 3.5"

These items select the floppy drive type. The available settings and types supported by the motherboard are listed to the left.



Standard CMOS Features > Video

Video

EGA/VGA
CGA 40
CGA 80
Mono

This item specifies the type of video card in use. The default setting is EGA/VGA. Since current PCs use VGA only, this function is almost useless and may be disregarded in the future.

Standard CMOS Features > Halt On

Halt On

No Errors
All Errors
All, But Keyboard
All, But Diskette
All, But Disk/Key

This parameter enables you to control the system stops in case of Power-On Self Test ([POST](#)) error.

Advanced BIOS Features

This screen appears when you select the option "Advanced BIOS Features" from the main menu.

```

CMOS Setup Utility - Copyright (C) 1984-2000 Award Software
Advanced BIOS Features
  
```

Virus Warning	Disabled	Item Help
CPU Internal Cache	Enabled	Menu Level ▶
External Cache	Enabled	
CPU L2 Cache ECC Checking	Disabled	Allows you to choose
Processor Number Feature	Enabled	the VIRUS warning
Quick Power On Self Test	Enabled	feature for IDE Hard
First Boot device	C:	Disk boot sector
Second Boot device	CDROM	protection. If this
Third Boot device	Disabled	function is enabled
Boot other device	Disabled	and someone attempt to
Swap Floppy Drive	Disabled	write data into this
Boot Up Floppy Seek	Disabled	area, BIOS will show a
Boot Up NumLock Status	On	warning message on
TypeMatic Rate Setting	Enabled	screen and alarm beep
TypeMatic Rate (Chars/Sec)	30	
TypeMatic Delay (Msec)	250	
Security Option	Setup	
OS Select For DRAM > 64MB	Non-OS2	
Show Logo On Screen	Enabled	

```

| |←→:Move Enter:Select +/-/PU/PD:Value F10:Save ESC:Exit F1:General Help
F3:Language F5:Previous Values F6:Setup Defaults F7:Turbo Defaults
  
```

Advanced BIOS Features > Virus Warning

Virus Warning

Enabled

Disabled

Set this parameter to Enabled to activate the warning message.

This feature protects the boot sector and partition table of your hard disk from virus intrusion. Any attempt during boot up to write to the boot sector of the hard disk drive stops the system and the following warning message appears on the screen. Run an anti-virus program to locate the problem.

! WARNING !

Disk Boot Sector is to be modified
Type "Y" to accept write, or "N" to abort write
Award Software, Inc.

Advanced BIOS Features > CPU Internal Cache

CPU Internal Cache

Enabled
Disabled

Enabling this parameter activates the CPU internal cache (currently, PBSRAM cache). Disabling the parameter slows down the system. Therefore, we recommend that you leave it enabled unless you are troubleshooting a problem.

Advanced BIOS Features > External Cache

External Cache

Enabled
Disabled

Enabling this parameter activates the secondary cache (currently, PBSRAM cache). Disabling the parameter slows down the system. Therefore, we recommend that you leave it enabled unless you are troubleshooting a problem.

Advanced BIOS Features > CPU L2 Cache ECC Checking

CPU L2 Cache ECC Checking

Enabled
Disabled

This item lets you enable or disable L2 Cache [ECC](#) checking.

Advanced BIOS Features > Processor Number Feature

**Processor Number
Feature**

Enabled
Disabled

This item is used to enable or disable Pentium III CPU Number Feature.

Advanced BIOS Features > Quick Power On Self Test

**Quick Power on Self
Test**

Enable
Disabled

This parameter speeds up [POST](#) by skipping some items that are normally checked.

[Advanced BIOS Features > First Boot Device](#)

[Advanced BIOS Features > Second Boot Device](#)

[Advanced BIOS Features > Third Boot Device](#)

First Boot Device

A:
LS/ZIP
C:
SCSI
CDROM
D:
E:
F:
LAN
Disabled

This parameter allows you to specify the system boot up search sequence. The hard disk ID are listed below:

C: Primary master
D: Primary slave
E: Secondary master
F: Secondary slave
LS: LS120
Zip: IOMEGA ZIP Drive
LAN: LAN card with boot ROM

Advanced BIOS Features > Boot Other Device

Boot Other Device

Enabled
Disabled

This parameter allows you to enable other system boot up devices that is not described above.

Advanced BIOS Features > Swap Floppy Drive

Swap Floppy Drive

Enabled
Disabled

This item allows you to swap floppy drives. For example, if you have two floppy drives (A and B), you can assign the first drive as drive B and the second drive as drive A or vice-versa.

Advanced BIOS Features > Boot Up Floppy Seek

**Boot Up Floppy
Seek**

Enabled
Disabled

Setting this parameter to enable/disable floppy seek test during Power On Self Test.

Advanced BIOS Features > Boot Up NumLock Status

Boot Up NumLock Status

On
Off

Setting this parameter to On enables the numeric function of the numeric keypad. Set this parameter to Off to disregard the function. Disabling the numeric function allows you to use the numeric keypad for cursor control.

Advanced BIOS Features > Typematic Rate Setting

Typematic Rate Setting

Enabled
Disabled

Set this parameter to Enable/Disable the keyboard repeat function. When enabled, continually holding down a key on the keyboard will generate repeatedly keystrokes.

Advanced BIOS Features > Typematic Rate (Chars/Sec)

Typematic Rate (Chars/Sec)

6, 8, 10, 12, 15, 20,
24, 30

This item allows you to control the speed of repeated keystrokes. The default is 30 characters/sec.

Advanced BIOS Features > Typematic Delay (Msec)

**Typematic Delay
(Msec)**

250, 500, 750, 1000

This parameter allows you to control the delay time between the first and the second keystroke (where the repeated keystrokes begin).

Advanced BIOS Features > Security Option

Security Option

Setup

System

The **System** option limits access to both the System boot and BIOS setup. A prompt asking you to enter your password appears on the screen every time you boot the system.

The **Setup** option limits access only to BIOS setup.

To disable the security option, select Password Setting from the main menu, don't type anything and just press <Enter>.

Advanced BIOS Features > OS Select for DRAM > 64MB

**OS Select for DRAM
> 64MB**

OS/2

Non-OS/2

Set to OS/2 if your system is utilizing an OS/2 operating system and has a memory size of more than 64 MB.



Advanced BIOS Features > Show Logo On Screen

**Show Logo On
Screen**

Enabled

Disabled

This item lets you show or hide AOpen logo on the [POST](#) screen.

Advanced Chipset Features

The "Advanced Chipset Features" includes settings for the chipset dependent features. These features are related to system performance.

CMOS Setup Utility - Copyright (C) 1984-2000 Award Software
Advanced Chipset Features

SDRAM CAS Latency Time	3	Item Help
SDRAM Cycle Time Tras/Trc	6/8	
SDRAM RAS-to-CAS Delay	2	Menu Level ▶
SDRAM RAS Precharge Time	2	
System BIOS Cacheable	Disabled	
Video BIOS Cacheable	Enabled	
Memory Hole At 15M-16M	Disabled	
Delayed Transaction	Enabled	
On-Chip Video	Disabled	
Display Cache Frequency	PCI CLK x4	
* Onboard Display Cache Setting *		
CAS# Latency	3	
Paging Mode Control	Open	
RAS-to-CAS Override	by CAS	
RAS# Timing	Slow	
RAS# Precharge Timing	Slow	

↑|←:Move Enter:Select +/-/PU/PD:V
F3:Language F5:Previous Values F6:S

Warning: Make sure you fully understand the items contained in this menu before you try to change anything. You may change the parameter settings to improve system performance. However, it may cause your system to be unstable if the setting is not correct for your system configuration.

Advanced Chipset Features > SDRAM CAS Latency Time

**SDRAM CAS Latency
(Time)**2
3

This [SDRAM](#) timing is calculated by clocks. Adjust its value affects SDRAM performance, the default setting is 2 clocks. If your system has unstable problem, change 2 to 3.

This option is selectable only if SDRAM is installed on your system.

Advanced Chipset Features > SDRAM Cycle Time Tras/Trc

**SDRAM Cycle Time
Tras/Trc**5/7
6/8

This item will affect SDRAM performance. If the system fails to bootup, please set this item to 6/8.

Advanced Chipset Features > SDRAM RAS-to-CAS Delay

**SDRAM RAS-to-CAS
Delay**3
2

SDRAM RAS-to-CAS Delay is an important parameter that affects SDRAM performance. If the system fails to bootup, please set this item to 3.

Advanced Chipset Features > SDRAM RAS Precharge Time

**SDRAM RAS
Precharge Time**

3
2

The RAS Precharge means the timing to inactive RAS and the timing for DRAM to do precharge before next RAS can be issued. RAS is the address latch control signal of DRAM row address. The default setting is **3**.

Advanced Chipset Features > System BIOS Cacheable

**System BIOS
Cacheable**

Enable
Disable

Allows the system BIOS to be cached to allow faster system performance.

Advanced Chipset Features > Video BIOS Cacheable

**Video BIOS
Cacheable**

Enabled
Disabled

Allows the video BIOS to be cached to allow faster video performance.

Advanced Chipset Features > Memory Hole At 15M-16M

**Memory Hole At
15M-16M**

Enabled
Disabled

This option lets you reserve system memory area for special I/O cards. The chipset accesses code/data of these areas from the I/O bus directly. Normally, these areas are reserved for memory mapped I/O card.

Advanced Chipset Features > Delayed Transaction

Delayed Transaction

Enabled
Disabled

This item lets you control the Delayed Transaction function of the ICH. This function is used to meet latency of PCI cycles to or from ISA cycle.

Advanced Chipset Features > On-Chip Video

On-Chip Video

Enabled
Disabled

This item is used to enable or disable the onchip AGP.

Advanced Chipset Features > Display Cache Frequency

**Display Cache
Frequency**

PCI CLK x 3
PCI CLK x 4

This option allows you to define the Display Cache Frequency on the motherboard, which will affect the graphics performance.

Advanced Chipset Features > Cas# Latency

Cas# Latency

2
3

Cas# Latency is an important parameter that affects SDRAM performance. If the system fails to boot up, please set this item to 3.

Advanced Chipset Features > Paging Mode Control

Paging Mode Control

Open
Close

This item will affect SDRAM performance. If the system fails to boot up, please set this item to **Close**.

Advanced Chipset Features > RAS-to-CAS Override

RAS-to-CAS Override

by CAS# LT

Override (2)

This item will affect SDRAM performance. If the system fails to boot up, please set this item to **Override (2)**.

Advanced Chipset Features > RAS# Timing

RAS# Timing

Slow

Fast

This item will affect SDRAM performance. If the system fails to boot up, please set this item to Slow.

Advanced Chipset Features > RAS# Precharge Timing

**RAS# Precharge
Timing**

Slow

Fast

The RAS Precharge means the timing to inactive RAS and the timing for DRAM to do precharge before next RAS can be issued. RAS is the address latch control signal of DRAM row address. The default setting is "**Slow**".

Integrated Peripherals

This submenu appears if you select the option "Integrated Peripherals" from the main menu. This option allows you to configure the I/O features.

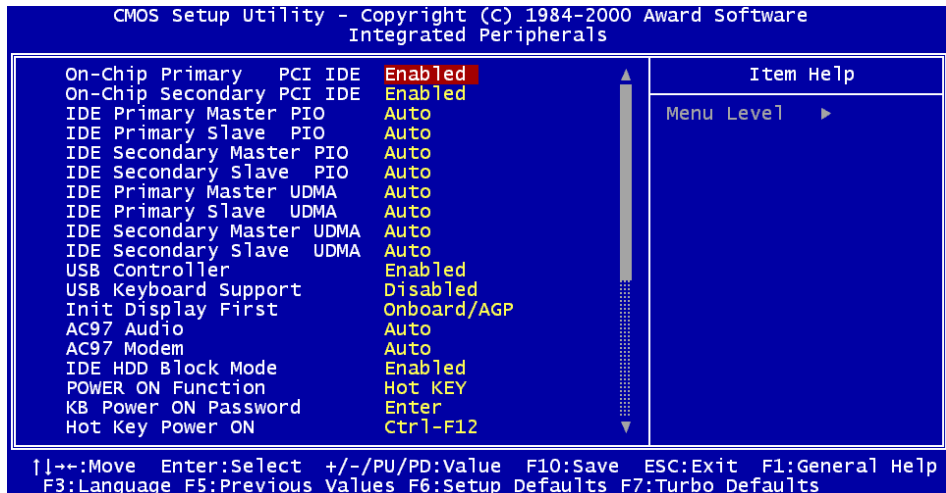

This page is the lower half of Integrated Peripherals submenu.

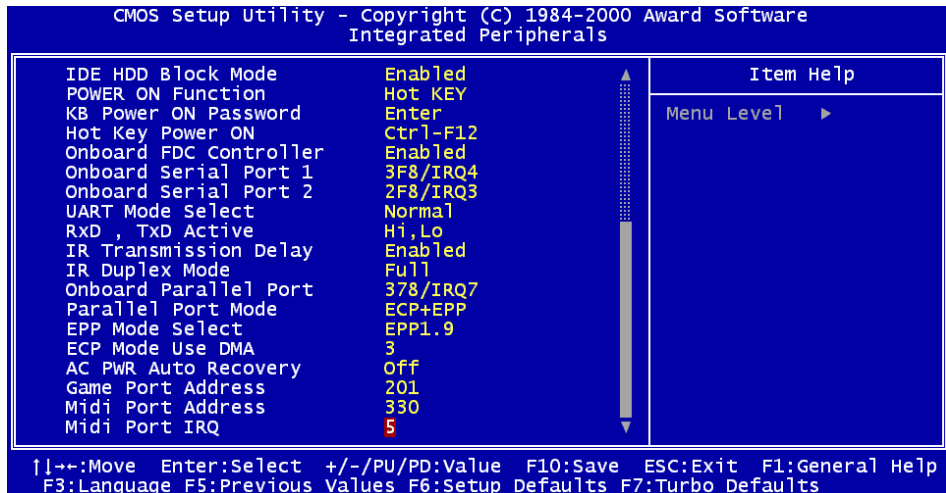

Integrated Peripherals > On-Chip Primary PCI IDE

Integrated Peripherals > On-Chip Secondary PCI IDE

On-Chip Primary PCI IDE

Enabled
Disabled

This parameter lets you enable or disable the IDE device connected to the primary IDE connector.

Integrated Peripherals > IDE Primary Master PIO

Integrated Peripherals > IDE Primary Slave PIO

Integrated Peripherals > IDE Secondary Master PIO

Integrated Peripherals > IDE Secondary Slave PIO

IDE Primary Master PIO

Auto
Mode 1
Mode 2
Mode 3
Mode 4

Setting this item to **Auto** activates the HDD speed auto-detect function. The PIO mode specifies the data transfer rate of HDD. For example: mode 0 data transfer rate is 3.3MB/s, mode 1 is 5.2MB/s, mode 2 is 8.3MB/s, mode 3 is 11.1MB/s and mode 4 is 16.6MB/s. If your hard disk performance becomes unstable, you may manually try the slower mode.

Integrated Peripherals > IDE Primary Master UDMA**Integrated Peripherals > IDE Primary Slave UDMA****Integrated Peripherals > IDE Secondary Master UDMA****Integrated Peripherals > IDE Secondary Slave UDMA****IDE Primary Master
UDMA**

Auto

Disabled

This item allows you to set the [ATA/100](#) mode supported by the hard disk drive connected to your primary IDE connector.

Integrated Peripherals > USB Controller**USB Controller**

Enabled

Disabled

This item lets you enable or disable the [USB](#) controller.

Integrated Peripherals > USB Keyboard Support

USB Keyboard Support

Enabled
Disabled

This item lets you enable or disable the USB keyboard driver within the onboard BIOS. The keyboard driver simulates legacy keyboard command and let you use USB keyboard during POST or after boot if you don't have USB driver in the operating system.



Note: You cannot use both USB driver and USB legacy keyboard at the same time. Disable "[USB Keyboard Support](#)" if you have USB driver in the operating system.

Integrated Peripherals > Init Display First

Init Display First

PCI Slot
Onboard/AGP

If you installed a PCI VGA card, this item lets you decide which one is the initial display card.

Integrated Peripherals > AC97 Audio

AC97 Audio

Auto

Disabled

This item is used to enable or disable the onboard audio.

Integrated Peripherals > AC97 Modem

AC97 Modem

Auto

Disabled

The item is used to enable or disable the AC97 modem. If disabled, a CNR modem card can't work properly.

Integrated Peripherals > IDE HDD Block Mode

IDE HDD Block Mode

Enabled

Disabled

This feature enhances disk performance by allowing multi-sector data transfers and eliminates the interrupt handling time for each sector. Most IDE drives, except with old designs, can support this feature.

Integrated Peripherals > Power On Function

Power On Function

Any Key
Button Only
Keyboard 98
Password
Hot Key
Mouse Left
Mouse Right

This item is used to select Wake on Keyboard/Mouse mode.

Any Key: This function allows you wake up the system by clicking any key.

Button Only: Disable Wake on KB/MS function. You can boot up your system by power button only.

Keyboard 98: If selecting this option, you can boot up the system by power button and the "Wake" key on Keyboard 98.

Password: Disable the function of power button and let the system can only be powered on through the preset keys (like a password).

Hot Key: If selecting this option, you also need to specify the hot key from "Hot Key Power On" item.

Mouse Left: This function allows you wake up the system by clicking left mouse button twice successively.

Mouse Right: This function allows you wake up the system by clicking right mouse button twice successively.

**Note:**

- *Whenever you change this item, it will only take effect after you restart the system and successfully boot the Windows or DOS.*
- *To implement Wake on Keyboard/Mouse function, you must set [JP28](#) to Enabled.*
- *Wake on Mouse function applies to PS/2 mouse only.*
- *If you set a password but forget it, please [clear CMOS](#).*
- *If you want to use Wake on Mouse function in DOS, it is necessary to install the DOS driver of the mouse.*

Integrated Peripherals > KB Power On Password

<u>KB Power On Password</u>
--

You can specify 1-5 keys as a password.

Integrated Peripherals > Hot Key Power On

Hot Key Power On

Ctrl-F1, Ctrl-F2, Ctrl-F3,
Ctrl-F4, Ctrl-F5, Ctrl-F6,
Ctrl-F7, Ctrl-F8, Ctrl-F9,
Ctrl-F10, Ctrl-F11,
Ctrl-F12

If you select "Hot Key" option in "Power On Function" Item, you need to specify a hot key here.

Integrated Peripherals > Onboard FDC Controller

Onboard FDC Controller

Enabled
Disabled

Setting this parameter to **Enabled** allows you to connect your floppy disk drives to the onboard floppy disk connector instead of a separate controller card. Change the setting to Disabled if you want to use a separate controller card.

Integrated Peripherals > Onboard Serial Port 1

Integrated Peripherals > Onboard Serial Port 2

Onboard Serial Port 1

Auto

3F8/IRQ4

2F8/IRQ3

3E8/IRQ4

2E8/IRQ3

Disabled

This item allows you to assign address and interrupt for the board serial port. Default is **Auto**.



Note: *If you are using network card, make sure that the IRQ do not conflict.*

Integrated Peripherals > UART Mode Select

UART Mode Select

IrDA
ASKIR
Normal

This item is configurable only if the "[Onboard Serial Port 2](#)" is enabled. This allows you to specify the mode of serial port2. The available mode selections are:

Normal

Sets serial port 2 to operate in normal mode. This is the default setting.

IrDA (SIR)

This setting allows infrared serial communication at a maximum baud rate of 115.2K baud.

ASKIR

This setting allows infrared serial communication at a maximum baud rate of 57.6K baud.

Integrated Peripherals > RxD, TxD Active

RxD, TxD Active

Hi, Hi
Hi, Lo,
Lo, Hi
Lo, Lo

This item is used to select RxD (Receive Data) and TxD (Transmit Data) mode for UART, for instance, IR device, modem, etc. Normally, we suggest you keep the default setting. Please see the documentation that comes with your device.

Integrated Peripherals > IR Transmission Delay

**IR Transmission
Delay**

Enabled
Disabled

If Enabled is selected, there will be a 4 characters delay when SIR is changed from TX mode to RX mode.

Integrated Peripherals > IR Duplex Mode

IR Duplex Mode

Full
Half

This item is used to select Full Duplex or Half Duplex of IR function. Normally, Full Duplex is faster, because it transmits data bi-direction at the same time.

Integrated Peripherals > Onboard Parallel Port

Onboard Parallel Port

3BC/IRQ7

378/IRQ7

278/IRQ5

Disabled

This item controls the onboard parallel port address and interrupt.



Note: *If you are using an I/O card with a parallel port, make sure that the addresses and IRQ do not conflict.*

Integrated Peripherals > Parallel Port Mode

Parallel Port Mode

SPP

EPP

ECP

ECP + EPP

This item lets you set the parallel port mode. The mode options are SPP (Standard and Bi-direction Parallel Port), EPP (Enhanced Parallel Port) and ECP (Extended Parallel Port).

SPP (Standard and Bi-direction Parallel Port)

SPP is the IBM AT and PS/2 compatible mode.

EPP (Enhanced Parallel Port)

EPP enhances the parallel port throughput by directly writing/reading data to/from parallel port without latch.

ECP (Extended Parallel Port)

ECP supports DMA and RLE (Run Length Encoded) compression and decompression.

Integrated Peripherals > EPP Mode Select

EPP Mode Select

EPP1.7

EPP1.9

This item lets you select EPP mode protocol.

Integrated Peripherals > ECP Mode Use DMA

ECP Mode Use DMA

3

1

This item lets you set the DMA channel of ECP mode.

Integrated Peripherals > AC PWR Auto Recovery

**AC PWR Auto
Recovery**

Former Status

On

Off

A traditional ATX system should remain at power off stage when AC power resumes from power failure. This design is inconvenient for a network server or workstation, without an UPS, that needs to keep power-on. This item is used to solve this problem. Selecting On enabling system to automatically power-on after AC power resumes; on the other hand, the system will remain power-off if you select Off. If former status option is selected, the system will power-on or power-off based on the original state.

Integrated Peripherals > Game Port Address

Game Port Address

Disabled

201

209

This item is used to assign an address for the Game port.

Integrated Peripherals > Midi Port Address

Midi Port Address

Disabled

330

300

290

This item is used to assign an address for the Midi port.

Integrated Peripherals > Midi Port IRQ

Midi Port IRQ

5

7

This item is used to assign an IRQ for the Midi port.

Power Management Setup

The Power Management Setup screen enables you to control the motherboard green features. See the following screen.

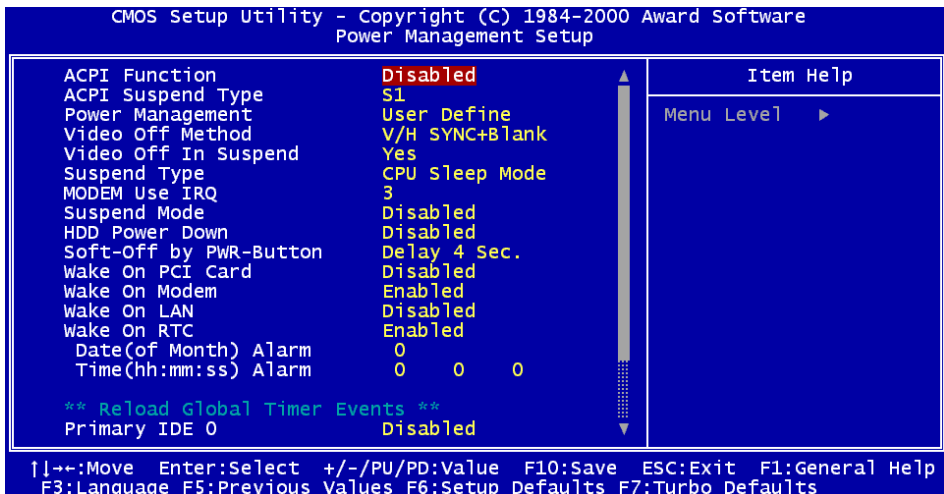

This page is the lower half of Power Management Setup submenu.

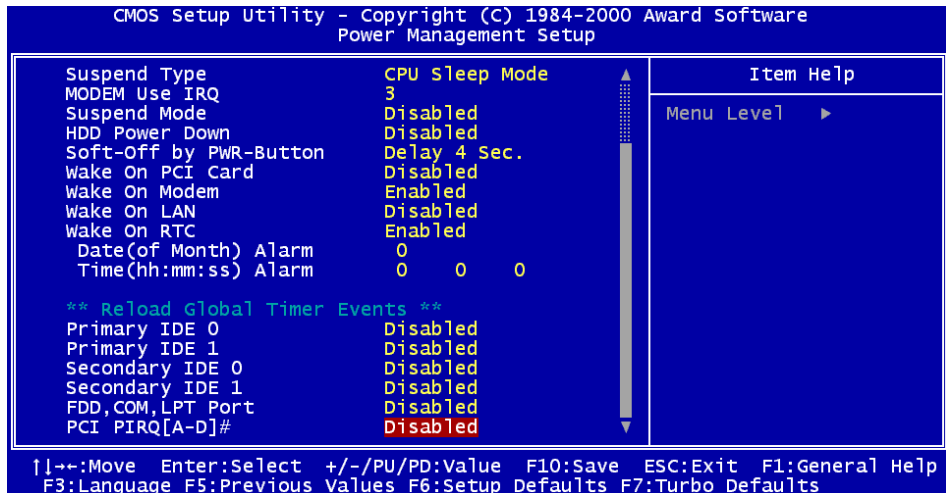

Power Management Setup > ACPI Function

ACPI Function

Enabled
Disabled

If your OS is [ACPI](#) enabled you have to set this item to Enabled, or there may be unexpected errors. If your OS is APM mode, you can remain the Disabled setting.

Power Management Setup > ACPI Suspend Type

ACPI Suspend Type

S1
S3

This function allows you to select suspend types. S1 is Power On Suspend and S3 is Suspend to RAM.

Power Management Setup > Power Management

Power Management

Max Saving
Min Saving
User Define

This function allows you to set the default parameters of power-saving modes. You can set this item to **User Define** to choose your own parameters or to turn off the power management function.

Mode	Suspend	HDD Power Down
Min Saving	1 hour	15 min
Max Saving	1 min	1 min

Power Management Setup > Video Off Method

Video Off Method

V/H SYNC + Blank
DPMS
Blank Screen

This determines the way that the monitor is off. Blank Screen writes blanks to video buffer. V/H SYNC + Blank allows BIOS to control VSYNC and HSYNC signals. This function applies only for DPMS (Display Power Management Standard) monitor. The DPMS mode uses DPMS functions provided by the VGA card.

Power Management Setup > Video Off In Suspend

Video Off In Suspend

No
Yes

The item is used to decide whether the video is off in the suspend mode.

Power Management Setup > Suspend Type

Suspend Type

PWR On Suspend

CPU Sleep Mode

You can select [APM](#) suspend mode by this item. If **PWR On Suspend** is selected, the CPU clock will be stopped and all other devices are shut off. But power must be kept On to detect activities from modem, keyboard/mouse and returns the system to full power. The system activities are detected by monitoring the IRQ signals or I/O. **CPU Sleep Mode** is similar as above but CPU will go into deep sleep mode and save more power.

Power Management Setup > Modem Use IRQ

Modem Use IRQ

3, 4, 5, 7, 9, 10, 11, N/A

This item lets you set an IRQ for the modem.

Power Management Setup > Suspend Mode

Suspend Mode

Disabled, 1-2 Min,
2-3 Min, 4-5 Min,
8-9 Min, 12 Min,
20 Min, 30 Min,
40 Min, 1 Hour

This item lets you set the period of time after which the system enters into Suspend mode. The Suspend mode can be Power On Suspend or Suspend to Hard Drive, selected by "Suspend Type".

Power Management Setup > HDD Power Down

HDD Power Down

Disabled, 1 Min,,
15 Min

This option lets you specify the IDE HDD idle time before the device enters the power down state. This item is independent from the power states previously described in this section (Standby and Suspend).

Power Management Setup > Soft-Off by PWR-BTTN

**Soft-Off by
PWR-BTTN**

Delay 4 sec.

Instant-Off

This is a specification of ACPI and supported by hardware. When **Delay 4 sec.** is selected, the soft power switch on the front panel can be used to control power On, Suspend and Off. If the switch is pressed for less than 4 seconds during power On, the system will go into Suspend mode. If the switch is pressed for longer than 4 seconds, the system will be turned Off. The default setting is **Instant-Off**. If **Instant-Off** is selected the soft power switch is only used to control On and Off, so there is no need to press it for 4 seconds, and there is no Suspend.

Power Management Setup > Wake On PCI Card

Wake On PCI Card

Enabled

Disabled

This is a function of PCI specification 2.2. PCI bus supports standby current to PCI card and PCI card can wakeup system if it detects certain activity.

Power Management Setup > Wake On Modem

Wake On Modem

Enabled
Disabled

This option lets you specify enable or disable Wake On Modem function.

Power Management Setup > Wake On LAN

Wake On LAN

Enabled
Disabled

This option lets you specify enable or disable Wake On LAN function.

Power Management Setup > Wake On RTC

Wake On RTC

Enabled
Disabled

The Wake On RTC is more like an alarm, which wakes up and powers on your system at a pre-defined time for a specific application. It can be set to wake up everyday or on specific date within a month. The date/time is accurate to within a second. This option lets you enable or disable the RTC wake up function.

Power Management Setup > Date (of Month) Alarm

Date (of Month) Alarm

0, 1,, 31

This item is displayed when you enable the Wake On RTC Timer option. Here you can specify what date you want to wake up the system. For Example, setting to 15 will wake up the system on the 15th day of every month.



Tip: Setting this item to 0 will wake up the system on the specified time (which can be set in the Wake On RTC Timer) every day.

Power Management Setup > Time (hh:mm:ss) Alarm

Time (hh:mm:ss) Alarm

hh:mm:ss

This item is displayed when you enable the Wake On RTC Timer option. Here you can specify what time you want to wake up the system.

Power Management Setup > Primary IDE 0

Power Management Setup > Primary IDE 1

Power Management Setup > Secondary IDE 0

Power Management Setup > Secondary IDE 1

Power Management Setup > FDD, COM, LPT Port

Power Management Setup > PCI PIRQ [A-D] #

Primary IDE 0

Enabled

Disabled

These items enable or disable the detection of IDE, floppy, serial, parallel and PCI IRQ activities for power down state transition.

PnP/PCI Configurations

The [PnP](#)/PCI Configurations allows you to configure the ISA and PCI devices installed in your system. The following screen appears if you select the option "PnP/PCI Configurations" from the main menu.

```

CMOS Setup Utility - Copyright (C) 1984-2000 Award Software
PnP/PCI Configurations

```

Reset Configuration Data	Disabled	Item Help
Resources Controlled By	Auto(ESCD)	Menu Level ▶
x IRQ Resources	Press Enter	Default is Disabled. Select Enabled to reset Extended System Configuration Data (ESCD) when you exit Setup if you have installed a new add-on and the system reconfiguration has caused such a serious conflict that the OS cannot boot
PCI/VGA Palette Snoop	Disabled	
Assign IRQ For VGA	Enabled	
Assign IRQ For USB	Enabled	

```

↑|←:Move Enter:Select +/-/PU/PD:Value F10:Save ESC:Exit F1:General Help
F3:Language F5:Previous Values F6:Setup Defaults F7:Turbo Defaults

```

PnP/PCI Configurations > Reset Configuration Data

Reset Configuration Data

Enabled
Disabled

In case conflict occurs after you assign the IRQs or after you configure your system, you can enable this function, allow your system to automatically reset your configuration and reassign the IRQs, DMAs, and I/O address.

PnP/PCI Configurations > Resources Controlled By

Resources Controlled By

Auto (ESCD)
Manual

Setting this option to Manual allows you to individually assign the IRQs and DMAs to the ISA and PCI devices. Set this to **Auto** to enable the auto-configuration function.

PnP/PCI Configurations > IRQ Resources

IRQ-3 assigned to

IRQ-4 assigned to

IRQ-5 assigned to

IRQ-7 assigned to

IRQ-9 assigned to

IRQ-10 assigned to

IRQ-11 assigned to

IRQ-12 assigned to

IRQ-14 assigned to

IRQ-15 assigned to

PCI Device

Reserved

When resources are controlled manually, assign each system interrupt a type, depending on the type of device using the interrupt

The available IRQs are: IRQ3 (COM2), IRQ4 (COM1), IRQ5 (Network/Sound or Others), IRQ7 (Printer or Others), IRQ9 (Video or Others), IRQ10 (SCSI or Others), IRQ11 (SCSI or Others), IRQ12 (PS/2 Mouse), IRQ14 (IDE1), IRQ15 (IDE2).

PnP/PCI Configurations > PCI/VGA Palette Snoop

**PCI/VGA Palette
Snoop**

Enabled
Disabled

Enabling this item informs the PCI VGA card to keep silent (and to prevent conflict) when palette register is updated (i.e., accepts data without responding any communication signals). This is useful only when two display cards use the same palette address and plugged in the PCI bus at the same time (such as MPEQ or Video capture). In such case, PCI VGA is silent while MPEQ/Video capture is set to function normally.

PnP/PCI Configurations > Assign IRQ For VGA

Assign IRQ For VGA

Enabled
Disabled

In case conflict occurs after you assign the IRQs or after you configure your system, you can enable this function, allow your system to automatically reset your configuration and reassign the IRQs, DMAs, and I/O address.

PnP/PCI Configurations > Assign IRQ For USB

Assign IRQ For USB

Enabled

Disabled

In case conflict occurs after you assign the IRQs or after you configure your system, you can enable this function, allow your system to automatically reset your configuration and reassign the IRQs, DMAs, and I/O address.

PC Health Status

This submenu displays hardware monitor status and provide some basic control function. You can install Hardware Monitoring utility without using setup items in this submenu.

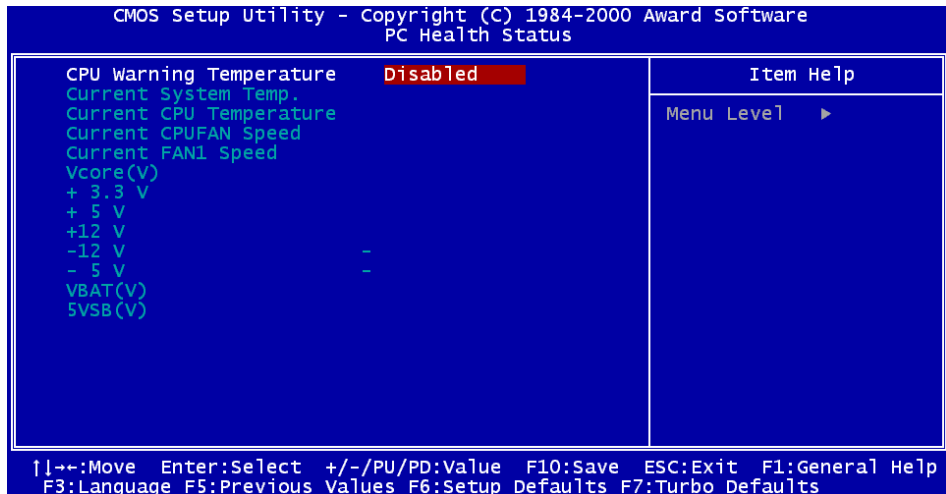

PC Health Status > CPU Warning Temperature

CPU Warning Temperature

Disabled

50°C / 122°F

53°C / 127°F

56°C / 133°F

60°C / 140°F

63°C / 145°F

66°C / 151°F

70°C / 158°F

This item is used to specify a CPU warning temperature. When the CPU's temperature is higher than this predefined value, the CPU's speed will automatically slow down and there will be a warning from BIOS.

Frequency / Voltage Control

This submenu allows you to configure the CPU and memory clock.

CMOS Setup Utility - Copyright (C) 1984-2000 Award Software
Frequency/Voltage Control

CPU Speed Detected	0	
Clock Spread Spectrum	OFF	
CPU Speed Setup	80	x6.5 = 520
SDRAM Clock(MHz)	120	
CPU Voltage Default		
CPU Voltage Setting	2.05 V	

Item Help
Menu Level ▶
1. If CPU speed detected does not match the CPU speed setup. It is probably caused by the CPU has a fixed FSB clock or fixed clock ratio.
2. If you fail to reboot the system, please press <Home> key first and then press Reset button at the same time.

↑↓←→:Move Enter:Select +/-/PU/PD:Value F10:Save ESC:Exit F1:General Help
F3:Language F5:Previous Values F6:Setup Defaults F7:Turbo Defaults

Frequency / Voltage Control > CPU Speed Detected

CPU Speed Detected

This column shows you present CPU Speed.

Frequency / Voltage Control > Clock Spread Spectrum

**Clock Spread
Spectrum**

ON
OFF

This item is used to set clock spread spectrum for EMI testing. Normally, you don't need to change the default setting.

Frequency / Voltage Control > CPU Speed Setup

CPU Speed Setting

FSB clock:

66.6, 66.8, 68.3, 75.3,
78, 80, 95, 100, 100.2,
105, 110, 114, 117,
122, 127, 129, 133.3,
133.6, 138, 140, 144,
146.6, 150, 157.3, 160
and 166 MHz.

Clock Ratio:

x2, x2.5, x3, x3.5, x4,
x4.5, x5, x5.5, x6,
x6.5, x7, x7.5, and x8

The item is used to select the CPU clock speed.

CPU Clock = FSB clock x Clock Ratio..

Frequency / Voltage Control > SDRAM Clock (MHz)

SDRAM Clock (MHz)

This column shows you the SDRAM clock.

SDRAM clock = FSB clock x SDRAM Clock Ratio

Frequency / Voltage Control > CPU Voltage Default

<u>CPU Voltage Default</u>

This column shows you the Default voltage of the processor installed.

Load Setup Defaults

The "Load Setup Defaults" option loads optimized settings for optimum system performance. Optimal settings are relatively safer than the Turbo settings. **All the product verification, compatibility/reliability test report and manufacture quality control are based on "Load Setup Defaults"**. We recommend to use this settings for normal operation. "Load Setup Defaults" is not the slowest setting for this motherboard. If you need to verify an unstable problem, you may manually set the parameter in the "[Advanced BIOS Features](#)" and "[Advanced Chipset Features](#)" to get slowest and safer setting.

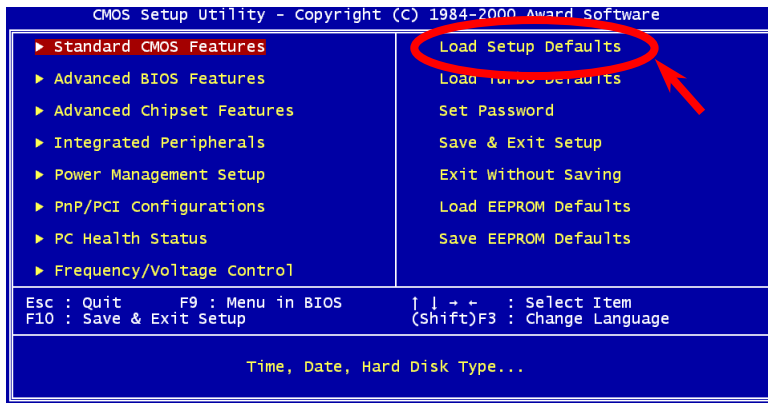

Load Turbo Defaults

The "Load Turbo Defaults" option gives better performance than "Load Setup Defaults". It is provided for the convenience of power user who wants to push the motherboard to get better performance. Turbo setting does not go through all the detail reliability and compatibility test, it is tested only with limited configuration and loading (for example, a system that contains only a VGA card and one DIMM/RIMM). **Use Turbo setting only when you fully understand the items in Chipset Setup menu.** The performance improvement of Turbo setting is normally around 3% to 5%, depending on the chipset and the application.

Set Password

Password prevents unauthorized use of your computer. If you set a password, the system prompts for the correct password before boot or access to Setup.

To set a password:

1. At the prompt, type your password. Your password can be up to 8 alphanumeric characters. When you type the characters, they appear as asterisks on the password screen box.
2. After typing the password, press.
3. At the next prompt, re-type your password and press again to confirm the new password. After the password entry, the screen automatically reverts to the main screen.

To disable the password, press when prompted to enter the password. The screen displays a message confirming that the password has been disabled.

Save & Exit Setup

This function automatically saves all CMOS values before leaving Setup.

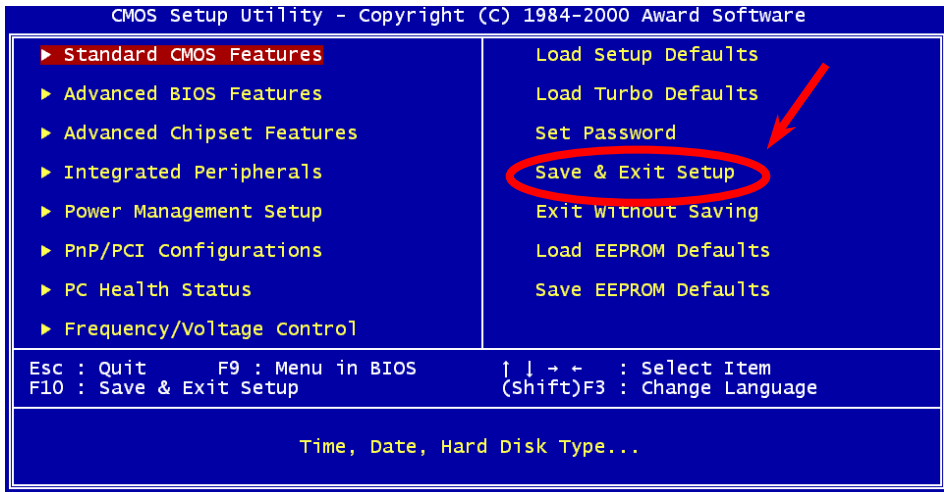

Exit without Saving

Use this function to exit Setup without saving the CMOS value changes. Do not use this option if you want to save the new configuration.

Load EEPROM Default

Except "Load Setup Default" and "Load Turbo Default", you may also use "Save EEPROM Default " to save your own settings into [EEPROM](#), and reload by using this item.

Save EEPROM Default

You may use this item to save your own settings into [EEPROM](#). Then, if the data in CMOS is lost or you forget the previous settings, you may use "Load EEPROM Default " to reload.

NCR SCSI BIOS and Drivers

Due to [Flash ROM](#) space limitation, some BIOS versions do not include NCR 53C810 SCSI BIOS (supports DOS, Windows 3.1 and OS/2) into the system BIOS. Many SCSI cards have its own SCSI BIOS on card, for better system performance, you may use the drivers that come with the NCR SCSI card or with your operating system. For details, refer to the installation manual of your NCR 53C810 SCSI card.

BIOS Upgrade

AOpen Easy Flash is a little different than traditional flash method. The [BIOS](#) binary file and flash routine are linked together and you simply run a single command to complete the flash process.

1. Download new BIOS upgrade [zipped](#) file from AOpen's web site. For example, AX3S102.ZIP.
2. [Unzip](#) it and we recommend saving the files into a bootable DOS floppy diskette for error recovery.
3. Reboot the system to DOS mode without loading any memory handler (such as EMM386) or device driver. It needs around 520K free memory space.
4. Execute A:> AX3S102

DO NOT turn off the power during FLASH PROCESS!

Del

5. Reboot system and press to [enter BIOS setup](#), Choose "[Load Setup Defaults](#)", then "[Save & Exit Setup](#)". Done!



Warning: The upgrade of new BIOS will permanently replace your original BIOS content after flashing. The original BIOS setting and Win95/Win98 PnP information will be refreshed and you probably need to re-configure your system.

Overclocking

As a leading manufacturer in motherboard industry, AOpen always listens to what customers want and develop products to fit different user's requirements. Reliability, compatibility, leading technology and friendly features are our basic goals when designing motherboards. Other than above mentioned design criteria, there are power users who are always seeking to push the limitation of the system performance by overclocking which we call them "Overclocker".

This section is dedicated to Overclockers.

This high performance motherboard is designed for maximum **133MHz** CPU bus clock. But it comes with clock generator of **166MHz** when we design it to accommodate future CPU bus clock. Our lab test results shown that **166MHz** is achievable when proper setting and qualified components were presented.



Warning: *The design of this product follows CPU and chipset vendor's design guideline. Any attempts to push beyond product specification are not recommended and you are taking your own risk to damage your system or important data. Before doing overclocking, you must make sure your components are able to tolerate such abnormal setting, especially CPU, memory, hard disks, and AGP VGA cards.*



Tip: *Note that overclocking may also cause thermal problem. Please make sure that the cooling fan and the heatsink were adequate to dissipate excessive heat that's generated by overclocking the CPU.*

VGA and HDD

VGA and HDD are key components for overclocking, following list are what have been tested in our lab. Please note that AOpen can not guaranty they can be successful overclocked again.

VGA: <http://www.aopen.com.tw/tech/report/overclk/mb/vga-oc.htm>

HDD: <http://www.aopen.com.tw/tech/report/overclk/mb/hdd-oc.htm>

Glossary

AC97

Basically, AC97 specification separates sound/modem circuit to two parts, digital processor and a [CODEC](#) for analog I/O, they are linked by AC97 link bus. Since digital processor can be put into motherboard main chipset, the cost of sound/modem onboard solution can be reduced.

ACPI (Advanced Configuration & Power Interface)

ACPI is the power management specification of PC97 (1997). It intends to save more power by taking full control of power management to operating system and bypass [BIOS](#). The chipset or super I/O chip needs to provide standard register interface to operating system (such as Windows 98). This is a bit similar as the [PnP](#) register interface. ACPI defines ATX momentary soft power switch to control the power state transition.

AGP (Accelerated Graphic Port)

AGP is a bus interface targeted for high-performance 3D graphic. AGP supports only memory read/write operation and single-master single-slave one-to-one only. AGP uses both rising and falling edge of the 66MHz clock, for 2X AGP, the data transfer rate is $66\text{MHz} \times 4\text{byte} \times 2 = 528\text{MB/s}$. AGP is now moving to 4X mode, $66\text{MHz} \times 4\text{byte} \times 4 = 1056\text{MB/s}$. AOpen is the first company to support 4X AGP motherboards by both AX6C (Intel 820) and MX64/AX64 (VIA 694x), started from Oct 1999.

AMR (Audio/Modem Riser)

The [CODEC](#) circuit of AC97 sound/modem solution can be put on motherboard or put on a riser card (AMR card) that connects to motherboard through AMR connector.

AOpen Bonus Pack CD

A disc bundled with AOpen motherboard product, which includes motherboard drivers, Acrobat Reader for [PDF](#) online manual and other useful utilities.

APM

Unlike [ACPI](#), BIOS controls most APM power management functions. AOpen Suspend to Hard Drive is a good example of APM power management.



ATA/66

ATA/66 uses both rising edge and falling edge as [UDMA/33](#), but reduces the cycle time to 2 clocks, that is 60ns. The data transfer rate is $(1/60\text{ns}) \times 2 \text{ bytes} \times 2 = 66\text{MB/s}$. To use ATA/66, you need special 80-wire ATA/66 IDE cable.

ATA/100

ATA/100 is a new IDE specification to enhance the bandwidth of data transfer, which uses both rising edge and falling edge as [ATA/66](#) but clock cycle time is reduced to 40ns. The data transfer rate is $(1/40\text{ns}) \times 2 \text{ bytes} \times 2 = 100\text{MB/s}$. To use ATA/100, you need special 80-wire IDE cable, the same as ATA/66.

BIOS (Basic Input/Output System)

BIOS is a set of assembly routine/program that reside in [EPROM](#) or [Flash ROM](#). BIOS controls Input/output devices and other hardware devices of motherboard. In general, to provide hardware independent portability, operation system and drivers is required to access BIOS without directly access hardware devices.

Bus Master IDE (DMA mode)

The traditional PIO (Programmable I/O) IDE requires the CPU to involve in all the activities of the IDE access including waiting for the mechanical events. To reduce the workload of the CPU, the bus master IDE device transfers data from/to memory without interrupting CPU, and releases CPU to operate concurrently while data is transferring between memory and IDE device. You need the bus master IDE driver and the bus master IDE HDD to support bus master IDE mode.

CODEC (Coding and Decoding)

Normally, CODEC means a circuit that can do digital to analog conversion and also the analog to digital conversion. It is part of [AC97](#) sound/modem solution.

DIMM (Dual In Line Memory Module)

DIMM socket has total 168-pin and supports 64-bit data. It can be single or double side, the golden finger signals on each side of PCB are different, that is why it was called Dual In Line. Almost all DIMMs are made by [SDRAM](#), which operate at 3.3V. Note that some old DIMMs are made by FPM/[EDO](#) and only operate at 5V. Do not confuse them with SDRAM DIMM..

ECC (Error Checking and Correction)

The ECC mode needs 8 ECC bits for 64-bit data. Each time memory is accessed, ECC bits are updated and checked by a special algorithm. The ECC algorithm has the ability to detect double-bit error and automatically correct single-bit error while parity mode can only detect single-bit error.



EDO (Extended Data Output) Memory

The EDO DRAM technology is actually very similar to FPM (Fast Page Mode). Unlike traditional FPM that tri-states the memory output data to start the pre-charge activity, EDO DRAM holds the memory data valid until the next memory access cycle, that is similar to pipeline effect and reduces one clock state.

EEPROM (Electronic Erasable Programmable ROM)

Also known as E²PROM. Both EEPROM and [Flash ROM](#) can be re-programmed by electronic signals, but the interface technology is different. Size of EEPROM is much smaller than flash ROM, AOpen motherboard uses EEPROM for jumper-less and battery-less design.

EPROM (Erasable Programmable ROM)

Traditional motherboard stores BIOS code in EPROM. EPROM can only be erased by ultra-violet (UV) light. If BIOS has to be upgraded, you need to remove EPROM from motherboard, clear by UV light, re-program, and then insert back.

FCC DoC (Declaration of Conformity)

The DoC is component certification standard of FCC EMI regulations. This standard allows DIY component (such as motherboard) to apply DoC label separately without a shielding of housing.

Flash ROM

Flash ROM can be re-programmed by electronic signals. It is easier for BIOS to upgrade by a flash utility, but it is also easier to be infected by virus. Because of increase of new functions, BIOS size is increased from 64KB to 256KB (2M bit). AOpen AX5T is the first board to implement 256KB (2Mbit) Flash ROM. Now flash ROM size is moving to 4M bit on AX6C (Intel 820) and MX3W (Intel 810) motherboard.

FSB (Front Side Bus) Clock

FSB Clock means CPU external bus clock.

$\text{CPU internal clock} = \text{CPU FSB Clock} \times \text{CPU Clock Ratio}$

I2C Bus

See [SMBus](#).

P1394

P1394 (IEEE 1394) is a standard of high-speed serial peripheral bus. Unlike low or medium speed [USB](#), P1394 supports 50 to 1000Mbit/s and can be used for video camera, disk and LAN.

PBSRAM (Pipelined Burst SRAM)

For Socket 7 CPU, one burst data read requires four QWord (Quad-word, $4 \times 16 = 64$ bits). PBSRAM only needs one address decoding time and automatically sends the remaining QWords to CPU according to a predefined sequence. Normally, it is 3-1-1-1, total 6 clocks, which is faster than asynchronous SRAM. PBSRAM is often used on L2 (level 2) cache of Socket 7 CPU. Slot 1 and Socket 370 CPU do not need PBSRAM.

PC100 DIMM

[SDRAM](#) DIMM that supports 100MHz CPU [FSB](#) bus clock.

PC133 DIMM

[SDRAM](#) DIMM that supports 133MHz CPU [FSB](#) bus clock.

PDF Format

A file format for electronic document, PDF format is independent from platform, you can read PDF file under Windows, Unix, Linux, Mac ... with different PDF reader. You can also read PDF file by web browser such as IE and Netscape, note that you need to install PDF plug-in first (Included in Acrobat Reader).

PnP (Plug and Play)

The PnP specification suggests a standard register interface for both BIOS and operating system (such as Windows 95). These registers are used by BIOS and operating system to configure system resource and prevent any conflicts. The IRQ/DMA/Memory will be automatically allocated by PnP BIOS or operating system. Currently, almost all the PCI cards and most ISA cards are already PnP compliant.

POST (Power-On Self Test)

The BIOS self test procedure after power-on, sometimes, it is the first or the second screen shown on your monitor during system boot.

RDRAM (Rambus DRAM)

Rambus is a memory technology that uses large burst mode data transfer. Theoretically, the data transfer should be high than [SDRAM](#). RDRAM is cascaded in channel operation. For Intel 820, only one RDRAM channel is supported, 16-bit data per channel, and this channel may have maximum 32 RDRAM devices, no matter how many [RIMM](#) sockets.

RIMM

184-pin memory module that supports [RDRAM](#) memory technology. A RIMM memory module may contain up to maximum of 16 RDRAM devices.



SDRAM (Synchronous DRAM)

SDRAM is one of the DRAM technologies that allows DRAM to use the same clock as the CPU host bus ([EDO](#) and FPM are asynchronous and do not have clock signal). It is similar as [PBSRAM](#) to use burst mode transfer. SDRAM comes in 64-bit 168-pin [DIMM](#) and operates at 3.3V. AOpen is the first company to support dual-SDRAM DIMMs onboard (AP5V), from Q1 1996

SIMM (Single In Line Memory Module)

SIMM socket is only 72-pin, and is only single side. The golden finger signals on each side of PCB are identical. That is why it was called Single In Line. SIMM is made by FPM or [EDO](#) DRAM and supports 32-bit data. SIMM had been phased out on current motherboard design.

SMBus (System Management Bus)

SMBus is also called I2C bus. It is a two-wire bus developed for component communication (especially for semiconductor IC). For example, set clock of clock generator for jumper-less motherboard. The data transfer rate of SMBus is only 100Kbit/s, it allows one host to communicate with CPU and many masters and slaves to send/receive message.

SPD (Serial Presence Detect)

SPD is a small ROM or [EEPROM](#) device resided on the [DIMM](#) or [RIMM](#). SPD stores memory module information such as DRAM timing and chip parameters. SPD can be used by [BIOS](#) to decide best timing for this DIMM or RIMM.

Ultra DMA/33

Unlike traditional PIO/DMA mode, which only uses the rising edge of IDE command signal to transfer data. UDMA/33 uses both rising edge and falling edge, the data transfer rate is double of the PIO mode 4 or DMA mode 2.

16.6MB/s x2 = 33MB/s

USB (Universal Serial Bus)

USB is a 4-pin serial peripheral bus that is capable of cascading low/medium speed peripherals (less than 10Mbit/s) such as keyboard, mouse, joystick, scanner, printer and modem. With USB, the traditional complex cables from back panel of your PC can be eliminated.

ZIP file

A compressed file format to reduce file size. To unzip file, run shareware PKUNZIP (<http://www.pkware.com/>) for DOS and other operating system or WINZIP (<http://www.winzip.com/>) for windows environment.



Troubleshooting

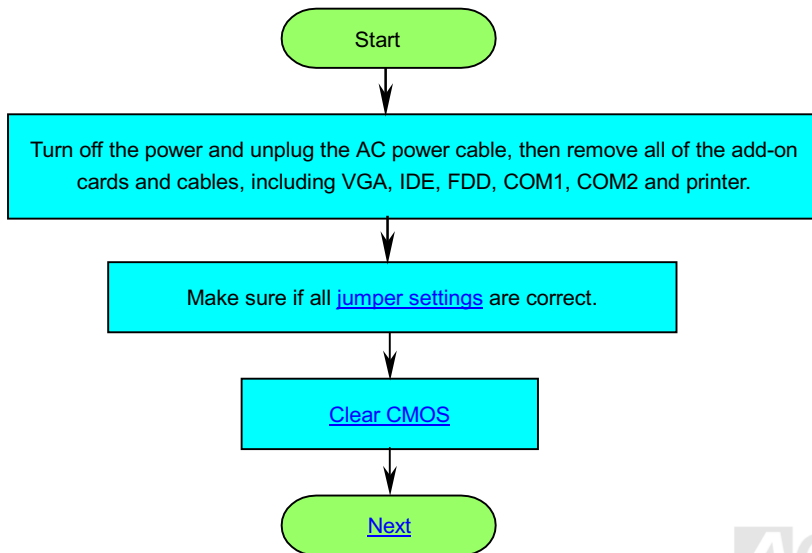

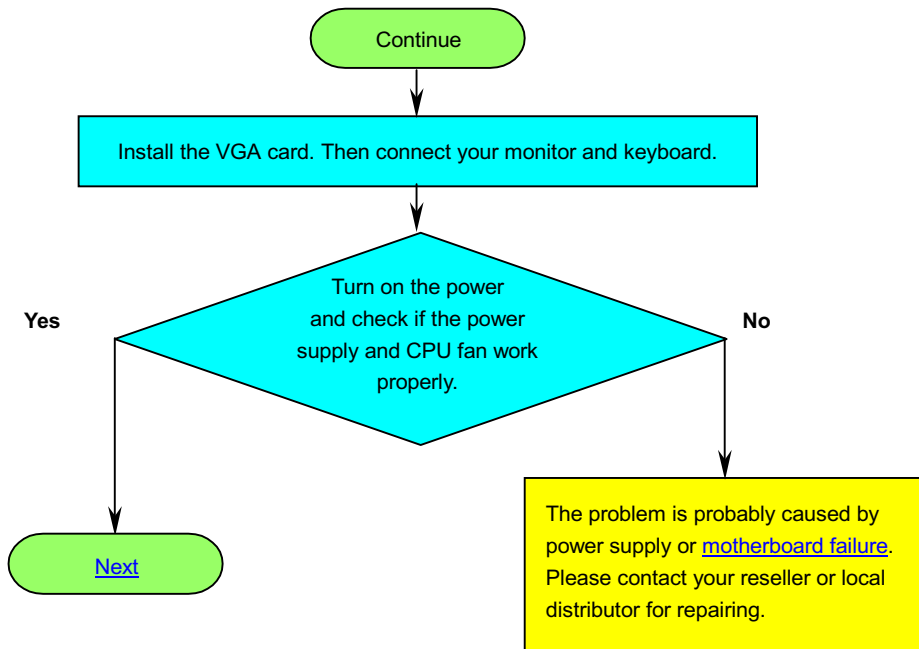

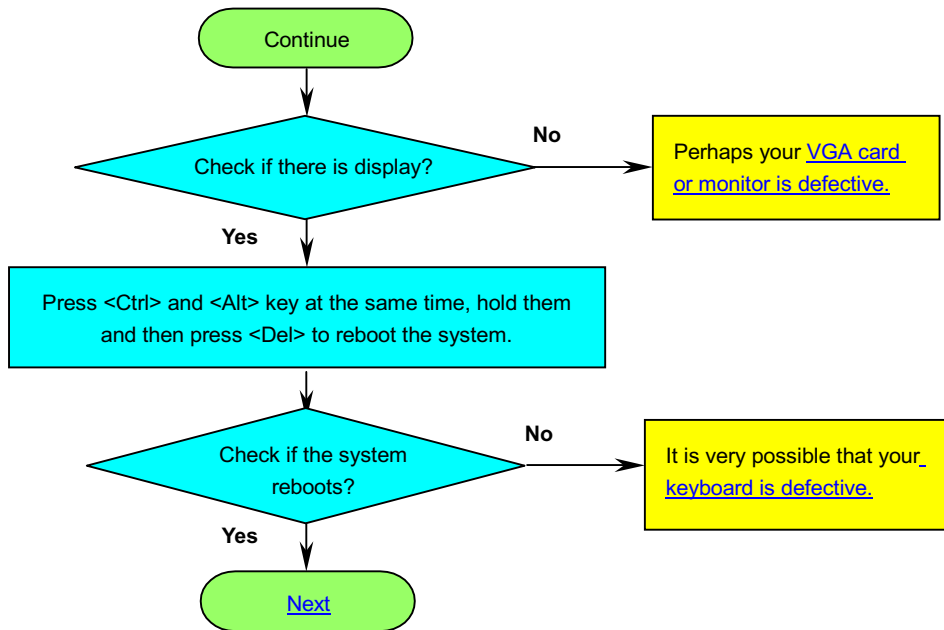

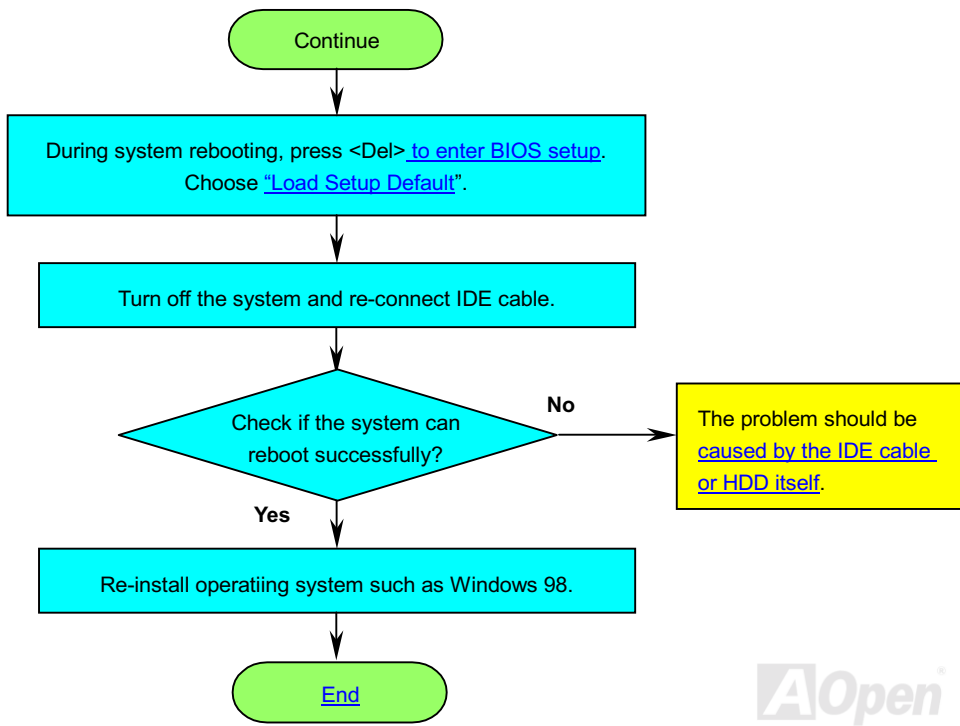



Technical Support

Dear Customer,

Thanks for choosing AOpen products. To provide the best and fastest service to our customer is our first priority. However, we receive numerous emails and phone-calls worldwide everyday, it is very hard for us to serve everyone on time. We recommend you follow the procedures below and seek help before contact us. With your help, we can then continue to provide the best quality service to more customers.

Thanks very much for your understanding!

AOpen Technical Supporting Team

1

Online Manual: Please check the manual carefully and make sure the jumper settings and installation procedure are correct.

<http://www.aopen.com.tw/tech/download/manual/default.htm>

2

Test Report: We recommend to choose board/card/device from the compatibility test reports for assembling your PC.

<http://www.aopen.com.tw/tech/report/default.htm>

3

FAQ: The latest FAQ (Frequently Asked Questions) may contain a solution to your problem.

<http://www.aopen.com.tw/tech/faq/default.htm>

4

Download Software: Check out this table to get the latest updated BIOS/utility and drivers.

<http://www.aopen.com.tw/tech/download/default.htm>

5

News Group: Your problem probably had been answered by our support engineer or professional users on the news group.

<http://www.aopen.com.tw/tech/newsgrp/default.htm>

6

Contact Distributors/Resellers: We sell our products through resellers and integrators. They should know your system configuration very well and should be able to solve your problem more efficiently than us. After all, their attitude of service is an important reference for you if next time you want to buy something else from them.

7

Contact Us: Please prepare detail system configuration and error symptom before contacting us. The **part number**, **serial number** and **BIOS version** are also very helpful.

Part Number and Serial Number

The Part Number and Serial number are printed on bar code label. You can find this bar code label on the outside packing, on ISA/CPU slot or on component side of PCB. For example:



P/N: 91.88110.201 is part number, **S/N: 91949378KN73** is serial number

Model name and BIOS version

Model name and BIOS version can be found on upper left corner of first boot screen ([POST](#) screen).
For example:

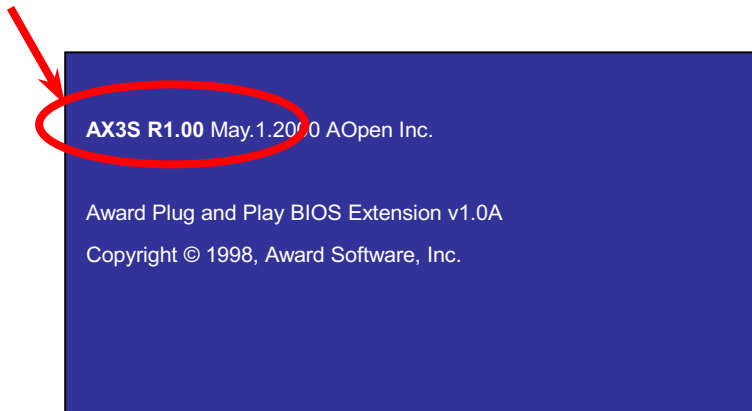

AX3S is model name of motherboard, **R1.00** is BIOS version.

Web: <http://www.aopen.com>

Email : Send us email by going through the contact form below.

English <http://www.aopen.com.tw/tech/contact/techusa.htm>

Japanese <http://aojp.aopen.com.tw/tech/contact/techjp.htm>

Chinese <http://w3.aopen.com.tw/tech/contact/techtw.htm>

German <http://www.aopencom.de/tech/contact/techde.htm>

Simplified Chinese <http://www.aopen.com.cn/tech/contact/techcn.htm>

TEL:

USA	650-827-9688
Netherlands	+31 73-645-9516
China	(86) 755-375-3013
Taiwan	(886) 2-2696-1333
Germany	+49 (0) 2102-157-700

