

AK33

Online Manual

DOC. NO. : AK33-OL-E0007A



What's in this manual

AK33	1
<i>What's in this manual</i>	2
<i>You Must Notice</i>	9
<i>Before You Start</i>	10
<i>Quick Installation Procedure</i>	11
<i>Motherboard Map</i>	12
<i>Block Diagram</i>	13
Hardware.....	14
<i>JP14 Clear CMOS</i>	15
<i>CPU Socket and Fan Connector</i>	16
<i>CPU Jumper-less Design</i>	17
<i>DIMM Socket</i>	20
<i>RAM Power LED</i>	22
<i>PC-Doctor Debug LED (Optional)</i>	23
<i>Front Panel Connector</i>	25

<i>ATX Power Connector</i>	26
<i>IDE and Floppy Connector</i>	27
<i>IrDA Connector</i>	30
<i>JP26 / JP27 Thermal Sensor (Optional)</i>	31
<i>WOL (Wake on LAN)</i>	32
<i>4X AGP (Accelerated Graphic Port)</i>	34
<i>PC99 Color Coded Back Panel</i>	35
<i>Support 4 USB Ports</i>	36
<i>JP12 Enable/Disable Onboard Sound Chip</i>	37
<i>CD Audio Connector</i>	38
<i>AUX_IN Connector</i>	39
<i>Battery-less and Long Life Design</i>	40
<i>Over-current Protection</i>	41
<i>Hardware Monitoring</i>	43
<i>Resettable Fuse</i>	44
<i>Year 2000 (Y2K)</i>	45

1500uF Low ESR Capacitor.....	47
Layout (Frequency Isolation Wall).....	49
Driver and Utility.....	50
Autorun Menu from Bonus CD Disc.....	51
Installing Windows 95.....	52
Installing Windows 98.....	53
Installing Windows 98 SE & Windows2000.....	54
Installing VIA 4 in 1 Driver.....	55
Installing Onboard Sound Driver.....	56
Installing Hardware Monitoring Utility.....	57
ACPI Suspend to Hard Drive.....	58
ACPI Suspend to RAM (STR).....	65
AWARD BIOS.....	67
Enter BIOS Setup.....	68
Standard CMOS Features.....	69
Advanced BIOS Features.....	75

<i>Advanced Chipset Features</i>	84
<i>Integrated Peripherals</i>	97
<i>Power Management Setup</i>	111
<i>PnP/PCI Configurations</i>	122
<i>PC Health Status</i>	128
<i>Load Setup Defaults</i>	129
<i>Load Turbo Defaults</i>	130
<i>Set Supervisor Password</i>	131
<i>Set User Password</i>	131
<i>Save & Exit Setup</i>	132
<i>Exit without Saving</i>	133
<i>NCR SCSI BIOS and Drivers</i>	133
<i>BIOS Upgrade</i>	134
Overclocking	136
<i>VGA and HDD</i>	138
Glossary	139

AC97	139
ACPI (Advanced Configuration & Power Interface)	139
AGP (Accelerated Graphic Port)	140
AMR (Audio/Modem Riser)	140
AOpen Bonus Pack CD	140
APM.....	140
ATA/66.....	141
ATA/100.....	141
BIOS (Basic Input/Output System).....	141
Bus Master IDE (DMA mode).....	142
CODEC (Coding and Decoding)	142
DIMM (Dual In Line Memory Module).....	142
ECC (Error Checking and Correction)	142
EDO (Extended Data Output) Memory.....	143
EEPROM (Electronic Erasable Programmable ROM)	143
EPROM (Erasable Programmable ROM).....	143

<i>EV6 Bus</i>	143
<i>FCC DoC (Declaration of Conformity)</i>	144
<i>FC-PGA</i>	144
<i>Flash ROM</i>	144
<i>FSB (Front Side Bus) Clock</i>	144
<i>I2C Bus</i>	145
<i>P1394</i>	145
<i>Parity Bit</i>	145
<i>PBSRAM (Pipelined Burst SRAM)</i>	145
<i>PC100 DIMM</i>	145
<i>PC133 DIMM</i>	146
<i>PDF Format</i>	146
<i>PnP (Plug and Play)</i>	146
<i>POST (Power-On Self Test)</i>	146
<i>RDRAM (Rambus DRAM)</i>	147
<i>RIMM</i>	147

<i>SDRAM (Synchronous DRAM)</i>	147
<i>SIMM (Single In Line Memory Module)</i>	147
<i>SMBus (System Management Bus)</i>	148
<i>SPD (Serial Presence Detect)</i>	148
<i>Ultra DMA/33</i>	148
<i>USB (Universal Serial Bus)</i>	148
<i>ZIP file</i>	149
Troubleshooting	150
Technical Support	154
<i>Part Number and Serial Number</i>	156
<i>Model name and BIOS version</i>	157

You Must Notice



Adobe, the Adobe logo, Acrobat are trademarks of Adobe Systems Incorporated.

AMD, the AMD logo, Athlon and Duron are trademarks of Advanced Micro Devices, Inc.

Intel, the Intel logo, Intel Celeron, PentiumIII, Pentium!!! are trademarks of Intel Corporation.

Microsoft, Windows, and Windows logo are either registered trademarks or trademarks of Microsoft Corporation in the United States and/or other countries.

All product and brand names used on this manual are used for identification purposes only and may be the registered trademarks of their respective owners.

All of the specifications and information contained in this manual are subject to change without notice. AOpen reserves the right to revise this publication and to make reasonable changes. AOpen assumes no responsibility for any errors or inaccuracies that may appear in this manual, including the products and software described in it.

This documentation is protected by copyright law. All rights are reserved.

No part of this document may be used or reproduced in any form or by any means, or stored in a database or retrieval system without prior written permission from AOpen Corporation. Copyright(c) 1996-2000, AOpen Inc. All Rights Reserved.



Before You Start



This Online Manual will introduce to the user how this product is installed. All useful information will be described in later chapters. Please keep this manual carefully for future upgrades or system configuration changes. This Online Manual is saved in [PDF format](#), we recommend using Adobe Acrobat Reader 4.0 for online viewing, it is included in [Bonus CD disc](#) or you can get free download from [Adobe web site](#).

Although this Online Manual is optimized for screen viewing, it is still capable for hardcopy printing, you can print it by A4 paper size and set 2 pages per A4 sheet on your printer. To do so, choose **File > Page Setup** and follow the instruction of your printer driver.

Thanks for the help of saving our earth.

Quick Installation Procedure

This page gives you a quick procedure on how to install your system. Follow each step accordingly.

- 1 Installing [CPU](#) and [Fan](#)
- 2 [Installing System Memory \(DIMM\)](#)
- 3 [Connecting Front Panel Cable](#)
- 4 [Connecting IDE and Floppy Cable](#)
- 5 [Connecting ATX Power Cable](#)
- 6 [Connecting Back Panel Cable](#)
- 7 [Power-on and Load BIOS Setup Default](#)
- 8 [Setting CPU Frequency](#)
- 9 Reboot
- 10 [Installing Operating System \(such as Windows 98\)](#)
- 11 [Installing Driver and Utility](#)

Motherboard Map

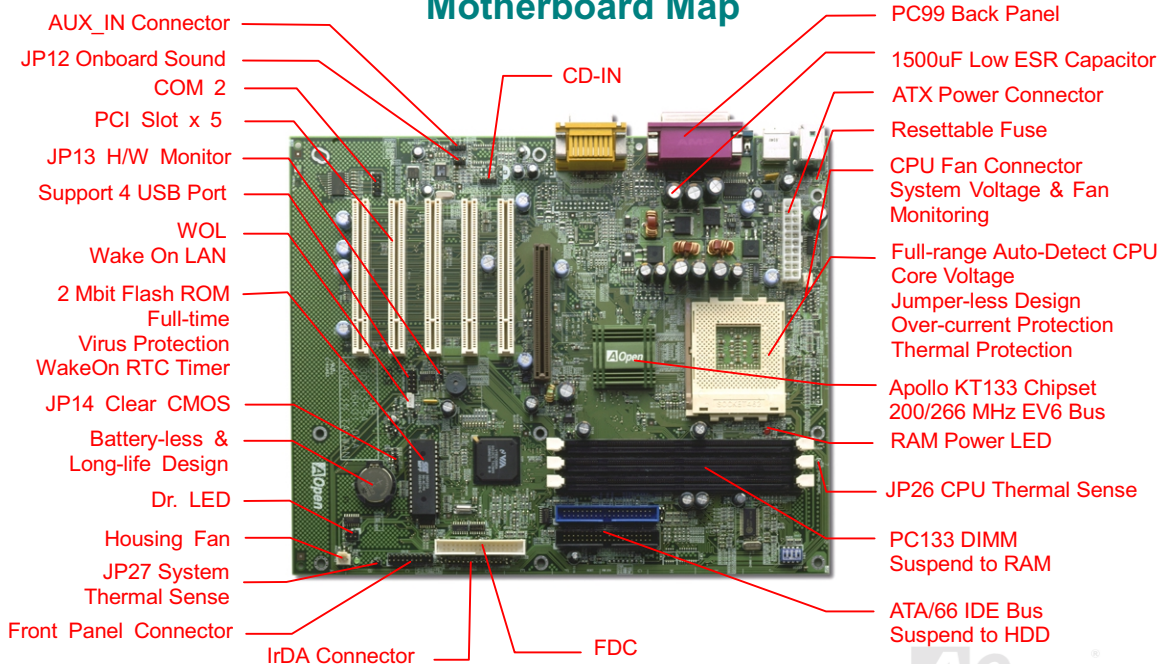

Block Diagram

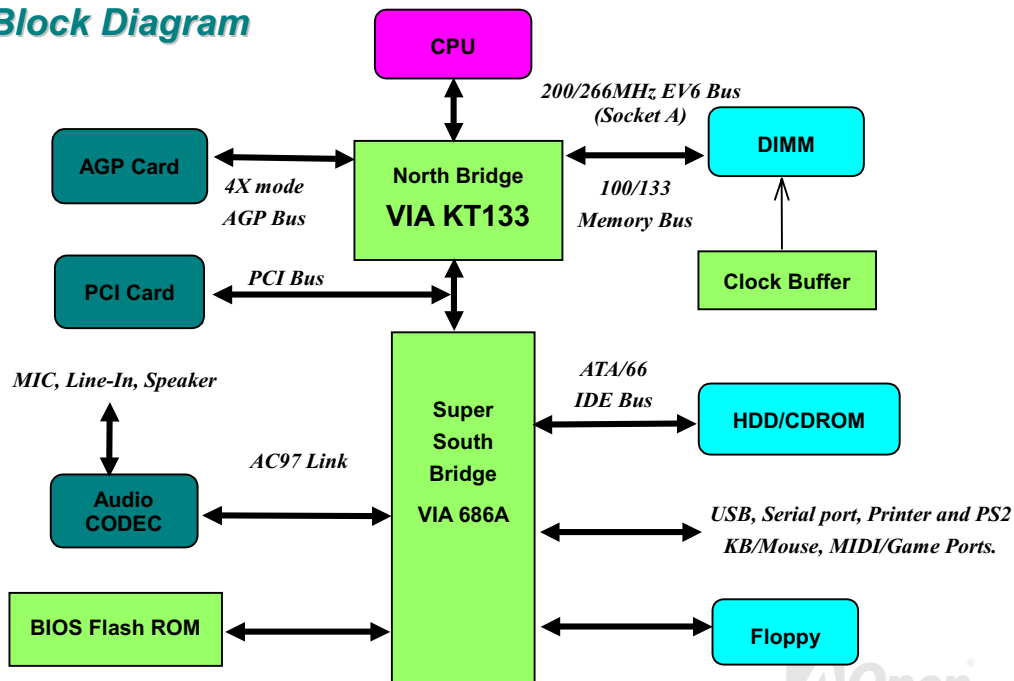

Hardware

This chapter describes jumpers, connectors and hardware devices of this motherboard.



Note: *Electrostatic discharge (ESD) can damage your processor, disk drives, expansion boards, and other components. Always observe the following precautions before you install a system component.*

1. *Do not remove a component from its protective packaging until you are ready to install it.*
2. *Wear a wrist ground strap and attach it to a metal part of the system unit before handling a component. If a wrist strap is not available, maintain contact with the system unit throughout any procedure requiring ESD protection.*

JP14 Clear CMOS

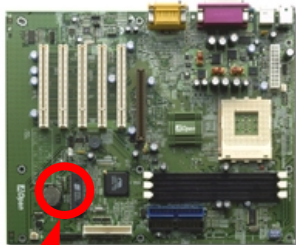

You can clear CMOS to restore system default setting. To clear the CMOS, follow the procedure below.

1. Turn off the system and unplug the AC power.
2. Remove ATX power cable from connector PWR2.
3. Locate JP14 and short pins 2-3 for a few seconds.
4. Return JP14 to its normal setting by shorting pins 1-2.
5. Connect ATX power cable back to connector PWR2.



Normal Operation
(default)



Clear CMOS

Tip: When should I Clear CMOS?

1. Boot fail because of overclocking...
2. Forget password...
3. Troubleshooting...

CPU Socket and Fan Connector

Plug CPU to AMD Socket 462 connector. Be careful of CPU orientation. Plug in the fan cable to the 3-pin **CPUFAN** connector.

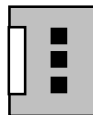
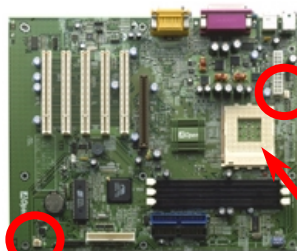

GND
+12V
SENSOR



Note: Some CPU fans do not have sensor pin, so that cannot support fan monitoring.

CPU Jumper-less Design

CPU VID signal and [SMBus](#) clock generator provide CPU voltage auto-detection and allows the user to set the CPU frequency through the [BIOS setup](#), therefore no jumpers or switches are used. The disadvantages of the Pentium based jumper-less designs are eliminated. There will be no worry of wrong CPU voltage detection.

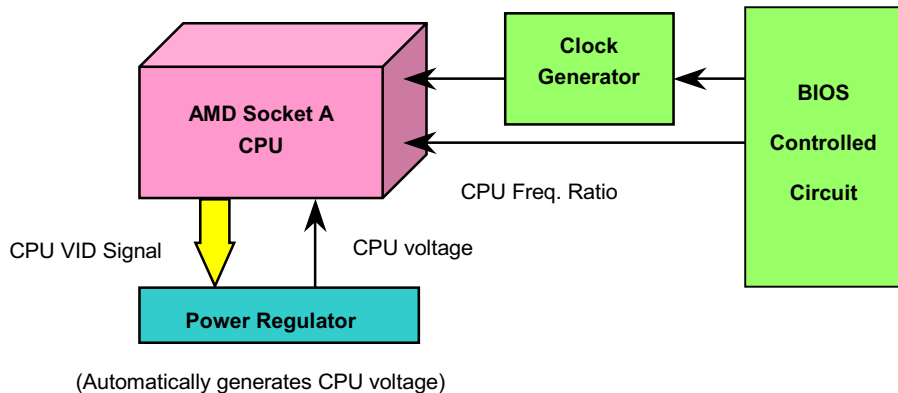

Full-range Auto-Detect CPU Core Voltage

This motherboard supports CPU VID function. The CPU core voltage will be automatically detected and the range is from 1.1V to 1.85V.



Warning: High CPU core voltage may be able to increase CPU speed for overclocking, but you may damage the CPU or reduce the CPU lifecycle.

Supported CPU Frequency

Core Frequency = CPU Bus Clock * CPU Ratio

EV6 Bus Speed = CPU Bus Clock x 2

PCI Clock = CPU Bus Clock / Clock Ratio

AGP Clock = PCI Clock x 2

CPU	CPU Core Frequency	EV6 Bus Clock	Ratio
Athlon 600	600 MHz	200 MHz	6x
Athlon 650	650 MHz	200 MHz	6.5x
Athlon 700	700 MHz	200 MHz	7x
Athlon 750	750 MHz	200 MHz	7.5x
Athlon 800	800 MHz	200 MHz	8x
Athlon 850	850 MHz	200 MHz	8.5x
Duron 600	600 MHz	200 MHz	6x
Duron 650	650 MHz	200 MHz	6.5x
Duron 700	700 MHz	200 MHz	7x
Duron 750	750 MHz	200 MHz	7.5x

DIMM Socket

This motherboard has three 168-pin [DIMM sockets](#) that allow you to install [PC133](#) memory up to 1.5 GB. Both SDRAM and VCM SDRAM are supported.

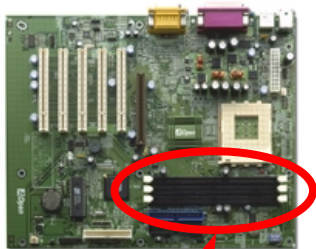

Pin 1

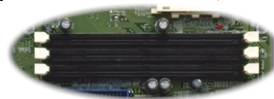

DIMM1
DIMM2
DIMM3

Tip: The driving capability of new generation chipset is limited due to the lack of a memory buffer (to improve performance). This makes DRAM chip count an important factor to take into consideration when you install DIMMs. Unfortunately, there is no way that the BIOS can identify the correct chip count; you need to calculate the chip count by yourself. The simple rule is: **By visual inspection, use only DIMMs which are less than 16 chips.**

DIMM can be single side or double side; it has 64 bit data and 2 or 4 clock signals. We strongly recommend choosing 4-clock SDRAM for its reliability

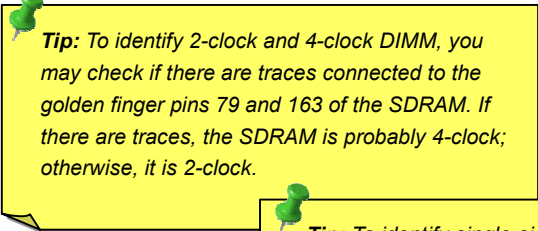

Tip: To identify 2-clock and 4-clock DIMM, you may check if there are traces connected to the golden finger pins 79 and 163 of the SDRAM. If there are traces, the SDRAM is probably 4-clock; otherwise, it is 2-clock.

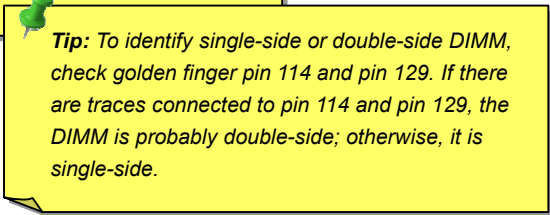

Tip: To identify single-side or double-side DIMM, check golden finger pin 114 and pin 129. If there are traces connected to pin 114 and pin 129, the DIMM is probably double-side; otherwise, it is single-side.

RAM Power LED

This LED indicates there is power applies to memory. It is useful to check RAM power during Suspend to RAM. Do not unplug memory module when this LED is On.

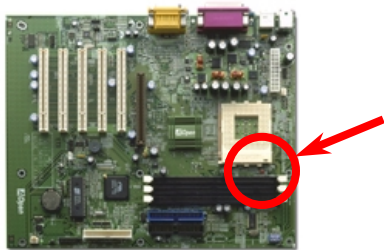

PC-Doctor Debug LED (Optional)

In conjunction with PC Doctor (Optional). The **Dr. LED** can easily show what kind of problem you may incur on your system during assembly. It can clearly indicate whether there is a component issue or an installed issue by the 8 LEDs on the front panel of PC-Doctor. This helps you quickly self diagnostic your system status.

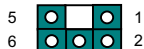

1	3.3V	2	GP014
3	NC	4	GP011
5	GND	6	GP012

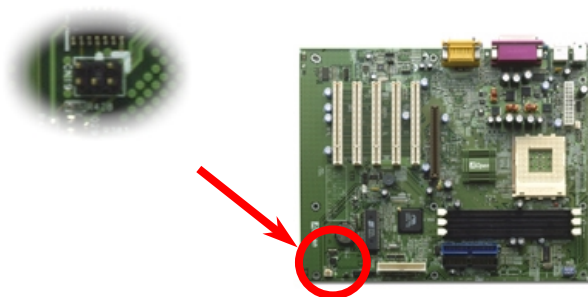

PC-Doctor is a CD disc storage box with 8 LEDs on its front panel, the size of PC-Doctor is exactly the same as 5.25 in floppy drive, so that it can be mount into normal 5.25 in drive bay of any housing.

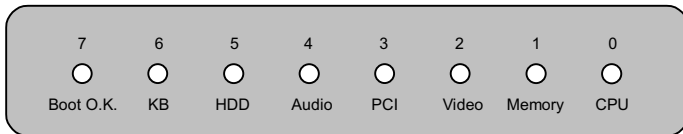

The total 8 LEDs light-up alternatively if the system fails in one of eight stages. Once the LED7 (latest LED) is lit, this indicates that the system has completed its boot-up procedure.

The 8 LEDs indicate the following messages when lit:

LED 0 - Indicates that the CPU may have been installed incorrectly or is damaged.

LED 1 - Indicates that the memory may have been installed incorrectly or is damaged.

LED 2 - Indicates that the AGP may have been installed incorrectly or is damaged.

LED 3 - Indicates that the PCI card may have been installed incorrectly or is damaged.

LED 4 - Indicates that the floppy disk drive may have been installed incorrectly or is damaged.

LED 5 - Indicates that the HDD may have been installed incorrectly or is damaged.

LED 6 - Indicates that the keyboard may have been installed incorrectly or is damaged.

LED 7 - Indicates that the system is OK.

Note: During POST (power on self test) procedure, the Debug LED will light on sequentially from LED0 to LED7 until the system boot O.K.

Front Panel Connector

Attach the power LED, speaker, and reset switch connectors to the corresponding pins. Locate the power switch cable from your ATX housing. It is 2-pin female connector from the housing front panel. Plug this connector to the soft-power switch connector marked **SPWR**.

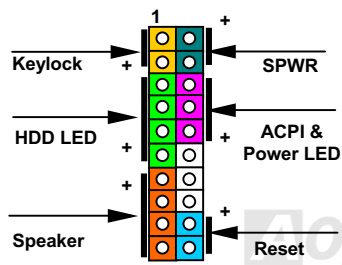
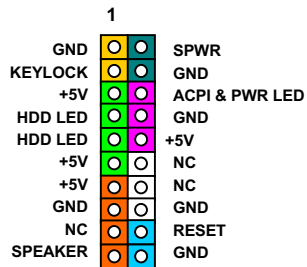
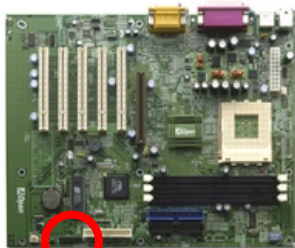

ATX Power Connector

The ATX power supply uses 20-pin connector shown below. Make sure you plug in the right direction.

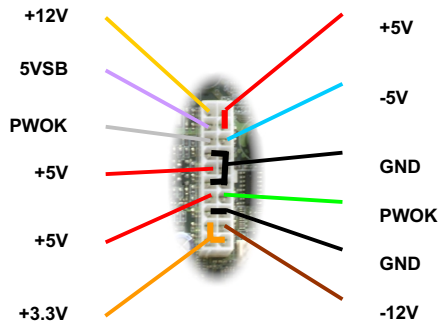
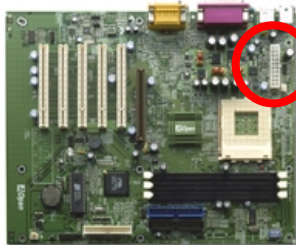

Warning: For ATX system, there is always a standby current on the motherboard. Please make sure that you have unplugged the ATX power cable from the connector before you insert or pull out any CPU, DIMM, PCI and AGP cards. Otherwise, serious component damage may occur.

IDE and Floppy Connector

Connect 34-pin floppy cable and 40-pin IDE cable to floppy connector FDC and IDE connector. The **blue connector** is IDE1 for clear identification. Be careful of the pin1 orientation. Wrong orientation may cause system damage.

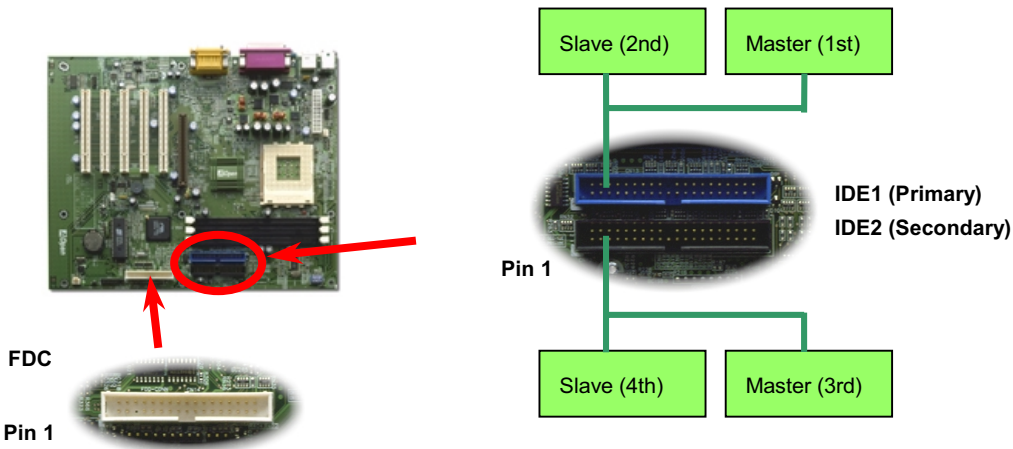

IDE1 is also known as the primary channel and IDE2 as the secondary channel. Each channel supports two IDE devices that make a total of four devices. In order to work together, the two devices on each channel must be set differently to **master** and **slave** mode. Either one can be the hard disk or the CDROM. The setting as master or slave mode depends on the jumper on your IDE device, so please refer to your hard disk and CDROM manual accordingly.



Warning: *The specification of the IDE cable is a maximum of 46cm (18 inches), make sure your cable does not exceed this length.*



Tip: *For better signal quality, it is recommended to set the far end side device to master mode and follow the suggested sequence to install your new device. Please refer to above diagram.*

This motherboard supports [ATA/66 IDE](#). Following table lists the transfer rate of IDE PIO and DMA modes. The IDE bus is 16-bit, which means every transfer is two bytes.

Mode	Clock Period	Clock Count	Cycle Time	Data Transfer Rate
PIO mode 0	30ns	20	600ns	$(1/600\text{ns}) \times 2\text{byte} = 3.3\text{MB/s}$
PIO mode 1	30ns	13	383ns	$(1/383\text{ns}) \times 2\text{byte} = 5.2\text{MB/s}$
PIO mode 2	30ns	8	240ns	$(1/240\text{ns}) \times 2\text{byte} = 8.3\text{MB/s}$
PIO mode 3	30ns	6	180ns	$(1/180\text{ns}) \times 2\text{byte} = 11.1\text{MB/s}$
PIO mode 4	30ns	4	120ns	$(1/120\text{ns}) \times 2\text{byte} = 16.6\text{MB/s}$
DMA mode 0	30ns	16	480ns	$(1/480\text{ns}) \times 2\text{byte} = 4.16\text{MB/s}$
DMA mode 1	30ns	5	150ns	$(1/150\text{ns}) \times 2\text{byte} = 13.3\text{MB/s}$
DMA mode 2	30ns	4	120ns	$(1/120\text{ns}) \times 2\text{byte} = 16.6\text{MB/s}$
UDMA/33	30ns	4	120ns	$(1/120\text{ns}) \times 2\text{byte} \times 2 = 33\text{MB/s}$
UDMA/66	30ns	2	60ns	$(1/60\text{ns}) \times 2\text{byte} \times 2 = 66\text{MB/s}$
UDMA/100	20ns	2	40ns	$(1/40\text{ns}) \times 2\text{byte} \times 2 = 100\text{MB/s}$



Tip: To achieve the best performance of Ultra DMA/66 hard disks, a special 80-wires IDE cable for Ultra DMA/66 is required.

IrDA Connector

The IrDA connector can be configured to support wireless infrared module, with this module and application software such as Laplink or Windows 95 Direct Cable Connection, the user can transfer files to or from laptops, notebooks, PDA devices and printers. This connector supports HPSIR (115.2Kbps, 2 meters) and ASK-IR (56Kbps).

Install the infrared module onto the **IrDA** connector and enable the infrared function from BIOS Setup, [UART 2 Mode](#), make sure to have the correct orientation when you plug in the IrDA connector.

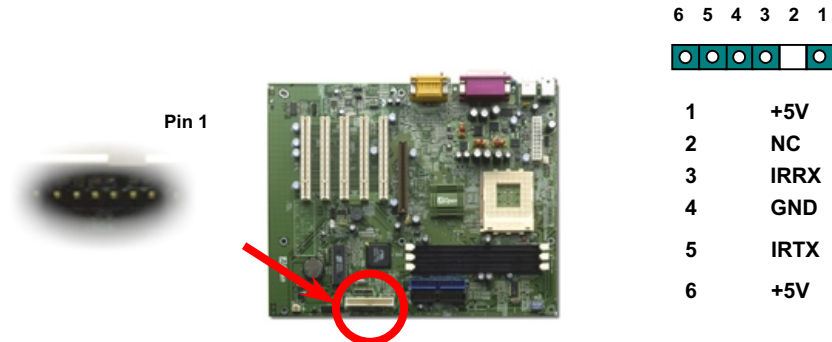

JP26 / JP27 Thermal Sensor (Optional)

With the increasing performance, the components nowadays always generate enormous heat inside the system, such as CPU, VGA card, HDD, and so on. In the meanwhile, they're the most important components that concern the stability of the system. The thermal sensor provides a convenient and flexible way of an extensible sensor for users to detect the temperature of any component.

For example, you can just plug the sliced sensor into the narrow opening between CPU and heat sink to monitor accurate temperature.

JP 27 System Thermal Sense

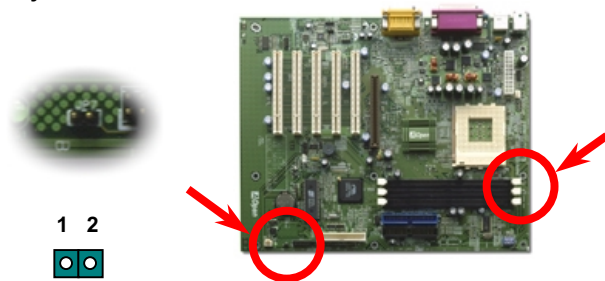

JP 26 CPU Thermal Sense

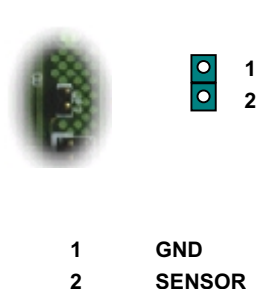

AOpen

WOL (Wake on LAN)

This feature is very similar as [Wake On Modem](#), but it goes through local area network. To use Wake On LAN function, you must have a network card with chipset that supports this feature, and connect a cable from LAN card to motherboard WOL connector. The system identification information (probably IP address) is stored on network card and because there is a lot of traffic on the Ethernet, you need to install a network management software, such as ADM, for the checking of how to wake up the system. Note that, at least 600mA ATX standby current is required to support the LAN card for this function.

Pin 1



+5V Standby
GND
LID

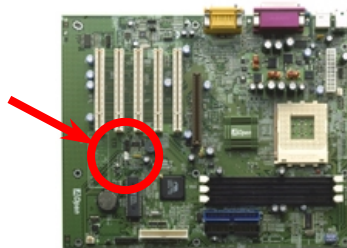

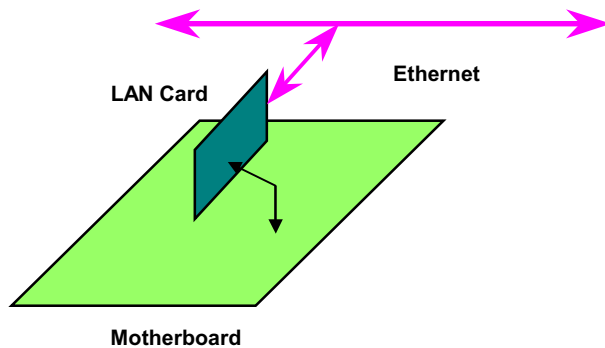

4X AGP (Accelerated Graphic Port)

This motherboard supports 4X [AGP](#). AGP is a bus interface designed for high-performance 3D graphic and supports only memory read/write operation. One motherboard can only have one AGP slot. **2X AGP** uses both rising and falling edge of the 66MHz clock, the data transfer rate is $66\text{MHz} \times 4 \text{ bytes} \times 2 = 528\text{MB/s}$. **4X AGP** is still using 66MHz AGP clock but the it has 4 data transfers within one 66MHz clock cycle, so that the data transfer rate is $66\text{MHz} \times 4 \text{ bytes} \times 4 = 1056\text{MB/s}$.

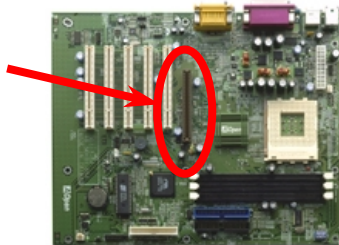

PC99 Color Coded Back Panel



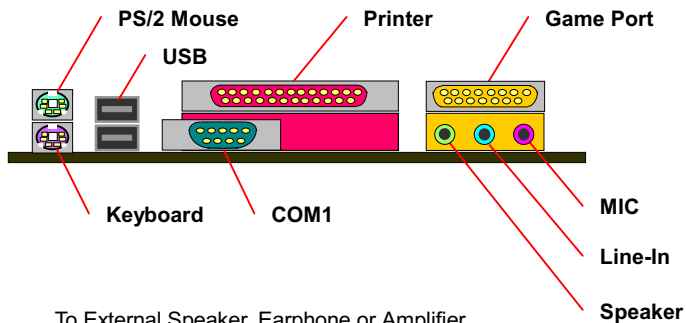







The onboard I/O devices are PS/2 Keyboard, PS/2 Mouse, serial ports COM1 , Printer, [four USB](#), AC97 sound and Game port. The view angle of drawing shown here is from the back panel of the housing.



- Speaker:** To External Speaker, Earphone or Amplifier
- Line-In:** From signal source such as CD/Tape player
- MIC:** From Microphone

Support 4 USB Ports

This motherboard supports four USB ports. Two of them are on back panel connector, the other two are on the left-bottom area of this motherboard. With proper cable, you can connect them to front panel.

	10	9	
NC			NC
GND			GND
+3D			+2D
-3D			-2D
+5V			+5V
	2	1	

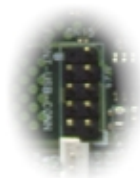

Pin 1

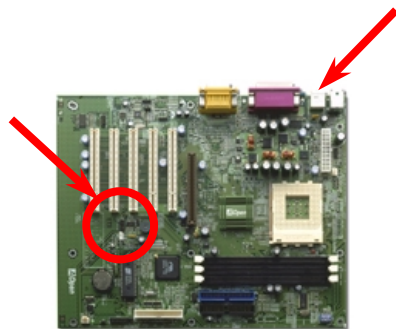

JP12 Enable/Disable Onboard Sound Chip

This motherboard has [AC97](#) sound onboard. JP12 is used to enable or disable onboard AD1885 [CODEC](#) chip. If you don't want to enable the Onboard Audio, you should set this jumper to 2-3, and disable the "OnChip Sound" from BIOS setting > Advanced Chipset Features, before you install your preferred PCI Sound Card.

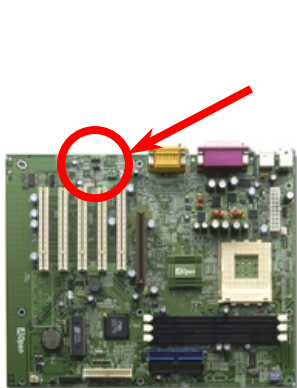

Enable



Disable

CD Audio Connector

This connector is used to connect CD Audio cable from CDROM or DVD drive to onboard sound.

Pin 1

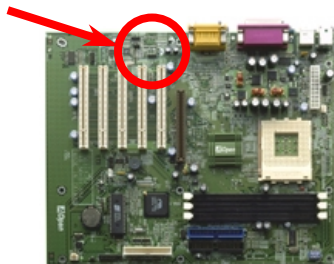

CD-IN

4 3 2 1



1	L
2	GND
3	GND
4	R

AUX_IN Connector

This connector is used to connect MPEG Audio cable from MPEG card to onboard sound.

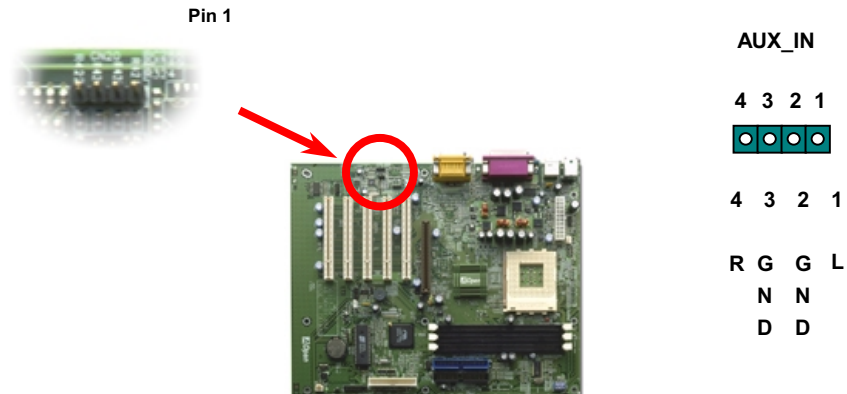

Battery-less and Long Life Design

This Motherboard implements a special circuit that allows you to keep your current CPU and CMOS Setup configurations without the need of a battery. The RTC (real time clock) can also keep running as long as the power cord is plugged.

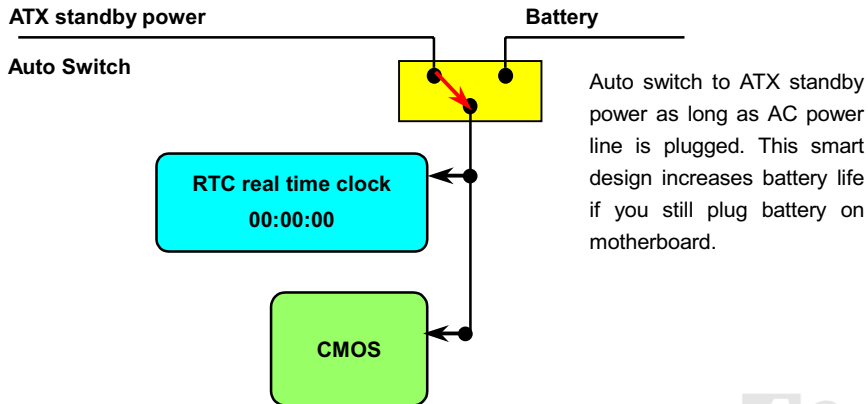

Over-current Protection

The Over Current Protection was very popular implemented on ATX 3.3V/5V/12V switching power supply. However, the new generation CPU uses different voltage that has regulator to transfer 5V to CPU voltage (for example, 2.0V), and makes 5V over current protection useless. This motherboard with switching regulator onboard support CPU over-current protection, in conjunction with 3.3V/5V/12V power supply provide the full line over-current protection.

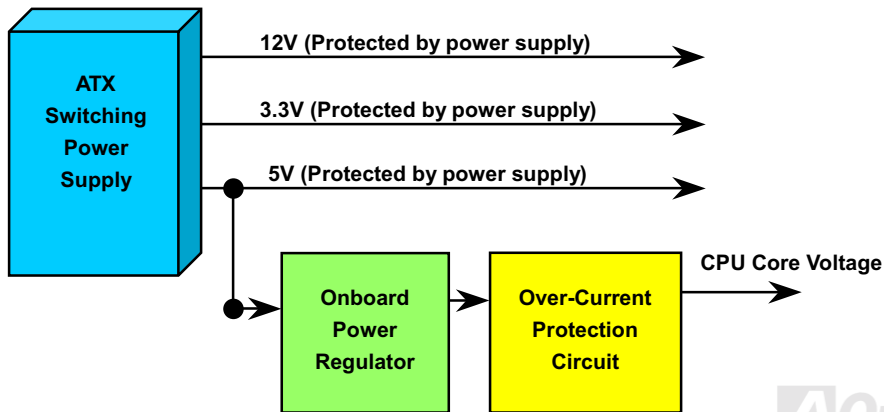



Note: Although we have implemented protection circuit try to prevent any human operating mistake, there is still certain risk that CPU, memory, HDD, add-on cards installed on this motherboard may be damaged because of component failure, human operating error or unknown nature reason. **AOpen cannot guaranty the protection circuit will always work perfectly.**

Hardware Monitoring

This motherboard implements a hardware monitoring system. As you turn on your system, this smart design will continue to monitor your system's working voltage, fan status and CPU temperature. If any of these systems's status goes wrong, there will be an alarm through the AOpen [Hardware Monitoring Utility](#) to warn the user.

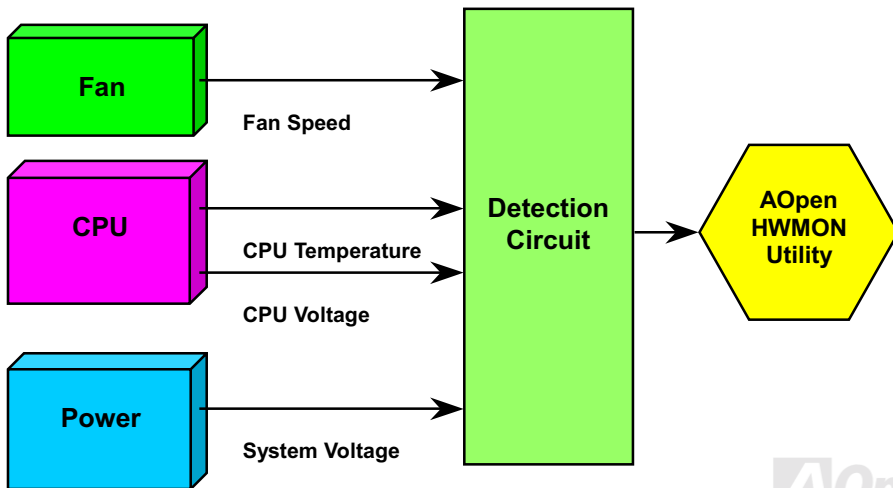

Resettable Fuse

Traditional motherboard has fuse for Keyboard and [USB](#) port to prevent over-current or shortage. These fuses are soldered onboard that when it is broken (did the job to protect motherboard), user still cannot replace it and the motherboard is still malfunction.

With expensive Resettable Fuse, the motherboard can back to normal function after fuse did the protection job.

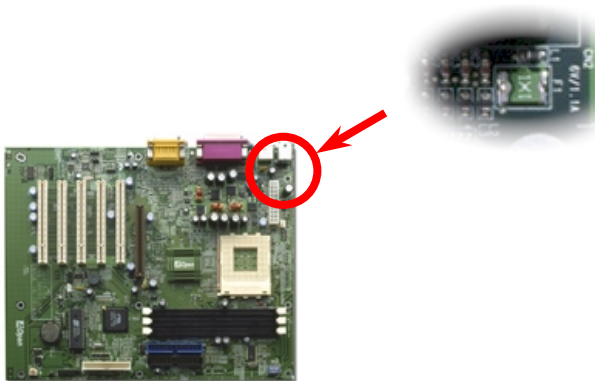

Year 2000 (Y2K)

Y2K is basically a problem of the identification of year code. To save storage space, traditional software uses only two digits for year identification. For example, 98 for 1998 and 99 for 1999, but 00 will be confused with 1900 and 2000.

There is an RTC circuit (Real Time Clock) in conjunction with 128 bytes of CMOS RAM data in the chipset of the motherboard. The RTC has only two digits and the CMOS has another 2 digits. Unfortunately, this circuit's behavior is like this 1997 → 1998 → 1999 → 1900, that means it may have the Y2K problem. Below is a diagram of how applications work with the OS, BIOS and RTC. In order to keep the best compatibility in the PC industry there is a rule that applications must call the OS to get services and OS must call the BIOS, and then only BIOS is allowed to access the hardware (RTC) directly.

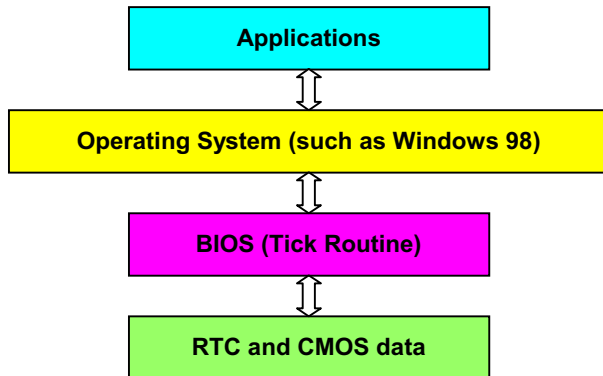

There is a Tick Routine (that goes live around every 50m sec) in the BIOS to keep record of date/time information. In general the BIOS, this Tick Routine does not update the CMOS every time because the CMOS is a very slow device which degrades system performance. The Tick Routine of the AOpen BIOS has 4 digits for year coding, as long as applications and the operating system follow the rule to get date/time information. There will be no Y2K problem (such as NSTL's test program). But unfortunately again, we found some test programs (such as Checkit 98) accesses RTC/CMOS directly. **This motherboard has hardware Y2K checking and protection that ensures risk free operation.**

1500uF Low ESR Capacitor

The quality of low ESR capacitor (Low Equivalent Series Resistor) during high frequency operation is very important for stability of CPU power. The location of where to put these capacitors is another know-how that requires experience and detail calculation.

Not only that, this motherboard implements **1500uF capacitors**, which is much larger than normal 1000 uF and provide better stability for CPU power.

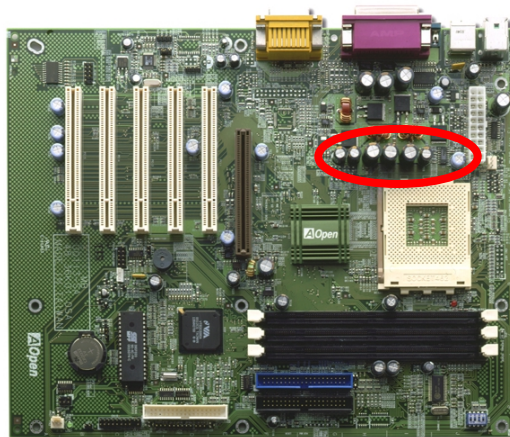

The power circuit of the CPU core voltage must be checked to ensure system stability for high speed CPUs (such as the new Pentium III, or when overclocking). A typical CPU core voltage is 2.0V, so a good design should control voltage between 1.860V and 2.140V. That is, the transient must be below 280mV. Below is a timing diagram captured by a Digital Storage Scope, it shows the voltage transient is only 143mV even when maximum 18A current is applied.

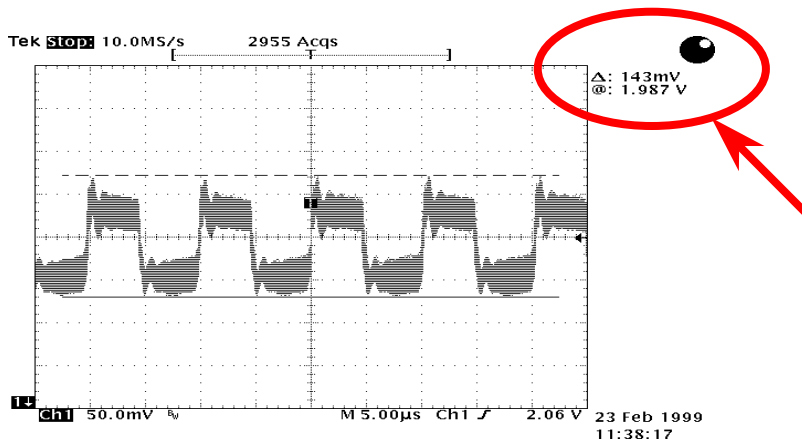

Note: This diagram for example only, it may not be exactly the same as this motherboard.

Layout (Frequency Isolation Wall)

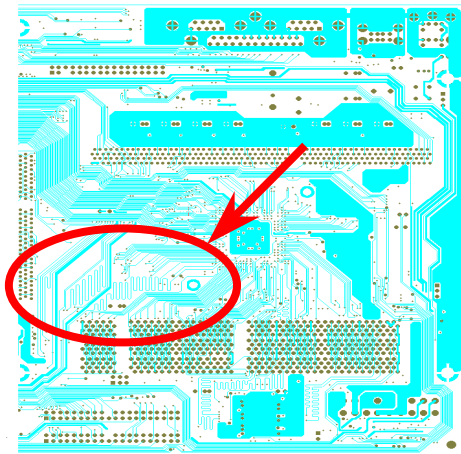

Note: This diagram for example only, it may not be exactly the same as this motherboard.

For high frequency operation, especially overclocking, layout is the most important factor to make sure chipset and CPU working in stable condition. The layout of this motherboard implements AOpen's unique design called "Frequency Isolation Wall". Separating each critical portion of motherboard into regions where each region operates in a same or similar frequency range to avoid crosstalk and frequency interference between each region's operations and condition. The trace length and route must be calculated carefully. For example, the clock trace must be equal length (not necessarily as short as possible) so that clock skew will be controlled within few a pico second ($1/10^{12}$ Sec)

Driver and Utility

There are motherboard drivers and utilities included in [AOpen Bonus CD disc](#). You don't need to install all of them in order to boot your system. But after you finish the hardware installation, you have to install your operation system first (such as Windows 98) before you can install any drivers or utilities. Please refer to your operation system's installation guide.



Note: Please follow recommended procedure to install [Windows 95](#) and [Windows 98](#).

Autorun Menu from Bonus CD Disc

You can use the autorun menu of Bonus CD disc. Choose the utility and driver and select model name.

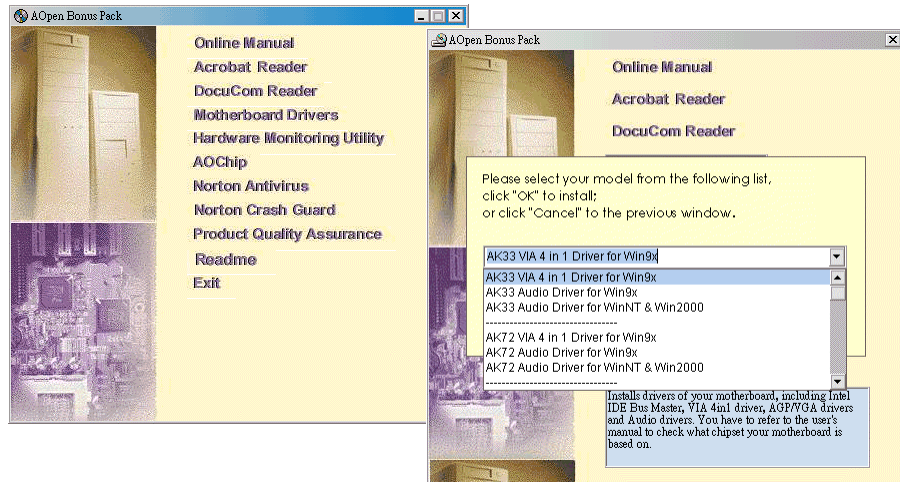

Installing Windows 95

1. First, don't install any add-on card except [AGP](#) card.
2. Install Windows 95 OSR2 v2.1, 1212 or 1214 version and later with USB support. Otherwise, you need to install USBSUPP.EXE.
3. Install the [VIA 4 in 1 driver](#), which includes VIA AGP Vxd driver, IRQ routing driver, and VIA chipset function registry program.
4. Finally, Install other add-on cards and their drivers.

Installing Windows 98

1. First, don't install any add-on card except [AGP](#) card.
2. Enable USB Controller in BIOS Setup > Advanced Chipset Features > [OnChip USB](#), to make BIOS fully capable of controlling IRQ assignment.
3. Install Window 98 into your system.
4. Install the [VIA 4 in 1 driver](#), which includes VIA AGP Vxd driver, IRQ routing driver, and VIA chipset function registry program.
5. Finally, Install other add-on cards and their drivers.

Installing Windows 98 SE & Windows2000

If you are using Windows® 98 Second Edition or Windows2000, you do not need to install the 4-in-1 driver as the IRQ Routing Driver and the ACPI Registry are already incorporated into the operating system. Users with Windows® 98 SE may update the IDE Busmaster and AGP drivers by installing them individually.

Please refer to [VIA Technologies Inc.](http://www.via.com/) for latest version of 4 in 1 driver:

<http://www.via.com/>

<http://www.via.com/drivers/4in1420.exe>

Installing VIA 4 in 1 Driver

You can install the VIA 4 in 1 driver ([IDE Bus master](#), VIA [AGP](#), IRQ Routing Driver, VIA Registry) from the Bonus Pack CD disc Autorun menu.

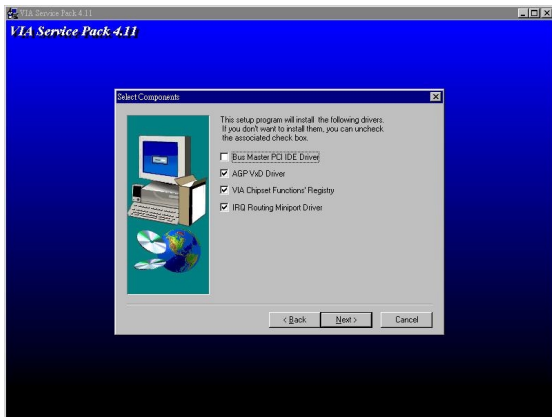

Note: Installing this Bus Master IDE driver may cause Suspend to Hard Drive failure.

Warning: If you want to uninstall the VIA AGP Vxd driver, please remove the AGP card driver first. Otherwise, the screen may go black at rebooting after the un-installation.

Installing Onboard Sound Driver

This motherboard comes with an AD 1885 [AC97 CODEC](#) and the sound controller is in VIA South Bridge chipset. You can find the audio driver from the Bonus Pack CD disc Autorun menu.

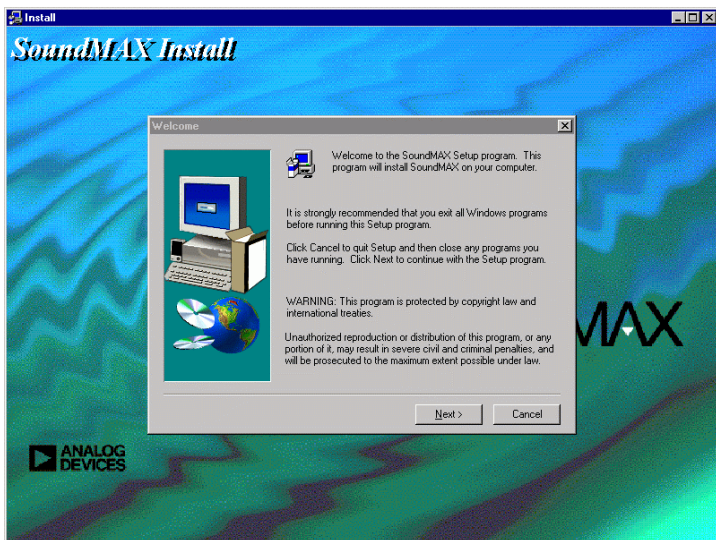

Installing Hardware Monitoring Utility

You can install Hardware Monitoring Utility to monitor CPU temperature, fans and system voltage. The hardware monitoring function is automatically implemented by the BIOS and utility software, no hardware installation is needed.

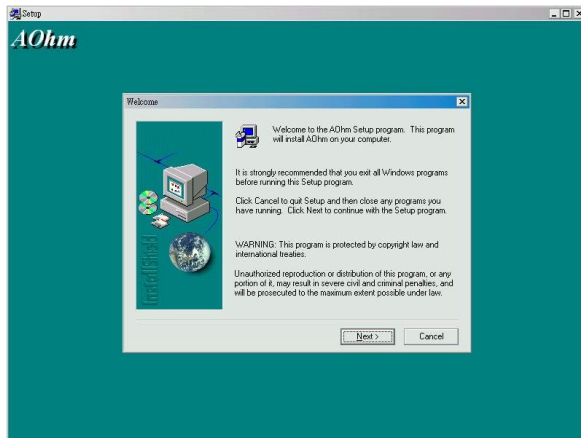

ACPI Suspend to Hard Drive

[ACPI](#) Suspend to Hard Drive is basically controlled by Windows operation system. It saves your current work (system status, memory and screen image) into hard disk, and then the system can be totally power off. Next time, when power is on, you can resume your original work directly from hard disk within few seconds without go through the Windows booting process and run your application again. If your memory is 64MB, normally, you need to reserve at least 64MB HDD space to save your memory image.

When go into Suspend:

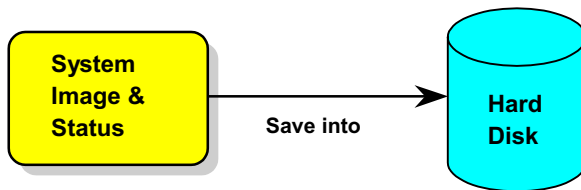

When power-on next time:

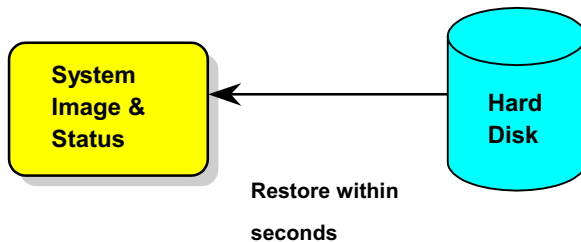

System Requirement

1. **AOZVHDD.EXE 1.30b** or later.
2. Delete **config.sys** and **autoexec.bat**.

Fresh installation of Windows 98 on a new system

1. Execute "**Setup.exe /p j**" to install Windows 98
2. After Windows 98's installation is complete, go to the Control Panel > Power Management.
 - a. Set Power Schemes > System Standby to "Never".
 - b. Click on "Hibernate" and select "Enable Hibernate Support" then "Apply".
 - c. Click on the "Advanced" tab, you'll see "Hibernate" on "Power Buttons". Note that this option will only be seen after step b mentioned above has been completed, otherwise only "Standby" and "Shutdown" will be shown. Select "Hibernate" and "Apply".
3. Clean boot into DOS and run AOZVHDD utility.
 - a. If you assign the whole disk to your Win 98 system (FAT 16 or FAT 32), please run "**aozvhd /c /file**". Please remember sufficient free space has to be reserved in the disk, e.g. if you have 64 MB DRAM and 16 MB VGA card installed, the system needs at least 80 MB free space. The utility will locate the space automatically.

- b. If you assign an individual partition for Win 98, please run "**aozvhd /c /partition**". Of course, the system needs to provide unformatted an empty partition.
4. Reboot system.
5. You've already implemented ACPI Suspend to-Hard Drive. Click "**Start > Shut Down > Standby**" then the screen will go off immediately. And 1 minute or so will be taken for the system to save what's in the memory to the hard drive; the larger the memory size the longer this process will take.

Changing from APM to ACPI (Windows 98 only)

1. Run "Regedit.exe"

- a. Go through the following path

HKEY_LOCAL_MACHINE

SOFTWARE

MICROSOFT

WINDOWS

CURRENT VERSION

DETECT

- b. Select "ADD Binary" and name it as "**ACPIOPTION**".
- c. Right click and select Modify, add "01" after "0000" to make it "0000 01".
- d. Save changes.

2. Select "Add New Hardware" under Control Panel. Allow Windows 98 to detect new hardware. (It will find "**ACPI BIOS**" and remove "**Plug and Play BIOS**")

3. Reboot system.

4. Clean boot into DOS and run "AOZVHDD.EXE /C /File"



Changing from ACPI to APM

1. Run "Regedit.exe"

- a. Go through the following path

HKEY_LOCAL_MACHINE

SOFTWARE

MICROSOFT

WINDOWS

CURRENT VERSION

DETECT

ACPI OPTION

- b. Right click and select "Modify, change "01" to "02" to make it "0000 02".

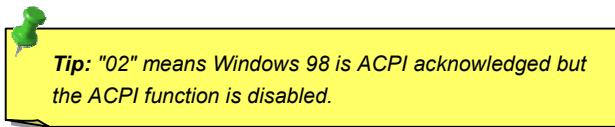

Tip: "02" means Windows 98 is ACPI acknowledged but the ACPI function is disabled.

- c. Save changes.

2. Select "Add New Hardware" under Control Panel. Allow Windows 98 to detect new hardware. (It will find "**Plug and Play BIOS**" and remove "**ACPI BIOS**")
3. Reboot system.
4. Run "Add New Hardware" again and it will find "Advanced Power Management Resource".
5. Click "OK".

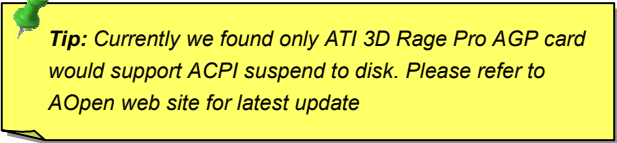

Tip: Currently we found only ATI 3D Rage Pro AGP card would support ACPI suspend to disk. Please refer to AOpen web site for latest update

ACPI Suspend to RAM (STR)

This motherboard supports ACPI Suspend to RAM function. With this function, you can resume your original work directly from DRAM without going through the Windows 98 booting process and run your application again. Suspend to DRAM saves your current work in the system memory, it is faster than Suspend to Hard Drive but requires power supplied to DRAM, while Suspend to Hard Drive requires no power.

When go into Suspend:

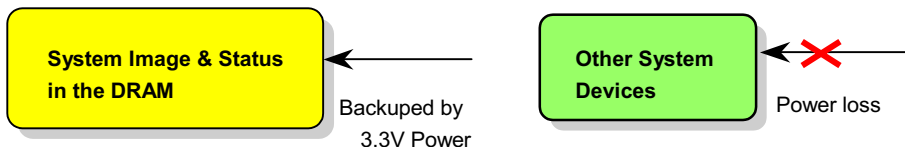

When power-on next time:

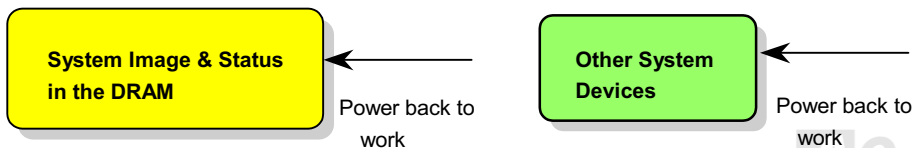

To implement ACPI Suspend to DRAM, please follow the procedures as below:

System Requirement

1. An ACPI OS is required. Currently, Windows 98 is the only choice. Please refer to ACPI [Suspend to Hard Drive](#) of how to setup Windows 98 ACPI mode.
2. The VIA 4 in 1 Driver must have been installed properly.

Procedures

1. Changed the following BIOS settings.

BIOS Setup > Power Management Setup > [ACPI Function](#): Enabled

BIOS Setup > Power Management Setup > [ACPI Suspend Type](#):S3.

2. Go to Control Panel > Power Management. Set "Power Buttons" to "Standby".
3. Press power button or standby button to wake up the system.

AWARD BIOS

System parameters can be modified by going into [BIOS](#) Setup menu, this menu allows you to configure the system parameters and save the configuration into the 128 byte CMOS area, (normally in the RTC chip or in the main chipset). [To enter to BIOS setup menu](#), press when [POST \(Power-On Self Test\)](#) screen is shown on your monitor.

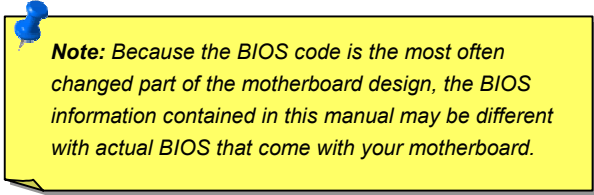

Note: *Because the BIOS code is the most often changed part of the motherboard design, the BIOS information contained in this manual may be different with actual BIOS that come with your motherboard.*

Enter BIOS Setup

Del

After you finish the setting of jumpers and connect correct cables. Power on and enter the BIOS Setup, press during POST (Power-On Self Test). Choose "Load Setup Defaults" for recommended optimal performance.

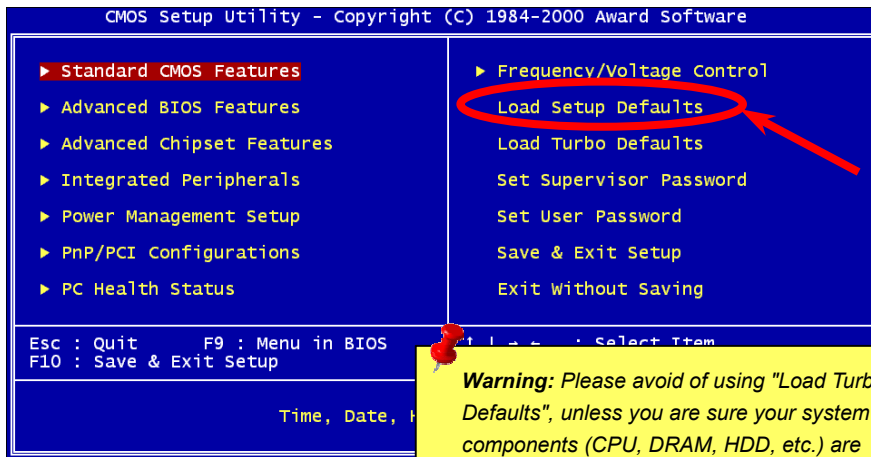

Standard CMOS Features

PgUp

PgDn

The "Standard CMOS Features" sets the basic system parameters such as the date, time, and the hard disk type. Use the arrow keys to highlight an item and <PgUp> or <PgDn> to select the value for each item.

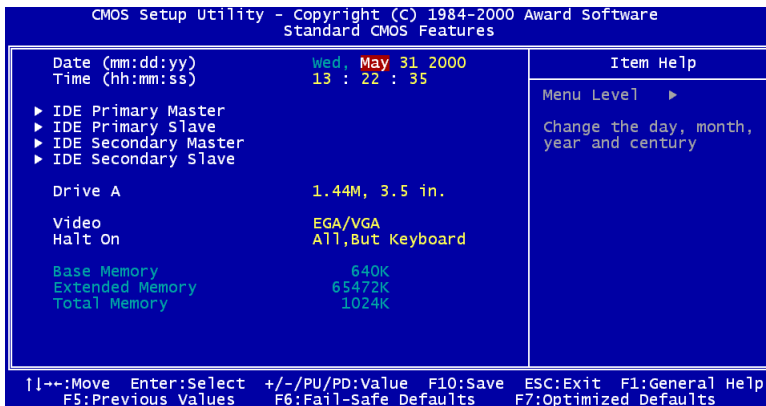



Standard CMOS Features > Date (mm:dd:yy)

To set the date, highlight the Date parameter. Press <PgUp> or <PgDn> to set the current date. The date format is month, date, and year.

Standard CMOS Features > Time (hh:mm:ss)

To set the time, highlight the Time parameter. Press <PgUp> or <PgDn> to set the current time in hour, minute, and second format. The time is based on the 24 hour military clock.

Standard CMOS Features > IDE Primary Master > Type

Standard CMOS Features > IDE Primary Slave > Type

Standard CMOS Features > IDE Secondary Master > Type

Standard CMOS Features > IDE Secondary Slave > Type

Type

Auto

User

None

This item lets you select the IDE hard disk parameters that your system supports. These parameters are Size, Number of Cylinder, Number of Head, Start Cylinder for Pre-compensation, Cylinder number of Head Landing Zone and Number of Sector per Track. The default setting is **Auto**, which enables BIOS to automatically detect the parameters of installed HDD (Hard Disk Drive) at [POST](#) (Power-On Self Test). If you prefer to enter HDD parameters manually, select **User**. Select **None** if no HDD is connected to the system.

The IDE CDROM is always automatically detected.

[Standard CMOS Features > IDE Primary Master > Mode](#)

[Standard CMOS Features > IDE Primary Slave > Mode](#)

[Standard CMOS Features > IDE Secondary Master > Mode](#)

[Standard CMOS Features > IDE Secondary Slave > Mode](#)

Mode

Auto

Normal

LBA

Large

The enhanced IDE feature allows the system to use a hard disk with a capacity of more than 528MB. This is made possible through the Logical Block Address (LBA) mode translation. The LBA is now considered a standard feature of current IDE hard disk on the market because of its capability to support capacity larger than 528MB. Note that if a HDD is formatted with LBA On, it will not be able to boot with LBA Off.

Standard CMOS Features > Drive A

Drive A

None

360KB 5.25"

1.2MB 5.25"

720KB 3.5"

1.44MB 3.5"

2.88MB 3.5"

These items select the floppy drive type. The available settings and types supported by the motherboard are listed to the left.

Standard CMOS Features > Video

Video

EGA/VGA

CGA40

CGA80

Mono

This item specifies the type of video card in use. The default setting is EGA/VGA. Since current PCs use VGA only, this function is almost useless and may be disregarded in the future.

Standard CMOS Features > Halt On

Halt On

No Errors

All Errors

All, But Keyboard

All, But Diskette

All, But Disk/Key

This parameter enables you to control the system stops in case of Power-On Self Test ([POST](#)) error.

Advanced BIOS Features

This screen appears when you select the option "Advanced BIOS Features" from the main menu.

CMOS Setup Utility - Copyright (C) 1984-2000 Award Software
Advanced BIOS Features

Virus warning	Disabled	↑ ↓	Item Help
CPU Internal Cache	Enabled		Menu Level ▶
External Cache	Enabled		Allows you to choose the VIRUS warning feature for IDE Hard Disk boot sector protection. If this function is enabled and someone attempt to write data into this area, BIOS will show a warning message on screen and alarm beep
CPU L2 Cache ECC Checking	Enabled		
Quick Power On Self Test	Enabled		
First Boot Device	Floppy		
Second Boot Device	HDD-0		
Third Boot Device	LS120		
Boot Other Device	Enabled		
Boot Up Floppy Seek	Enabled		
Boot Up NumLock Status	On		
Gate A20 Option	Normal		
Typematic Rate Setting	Disabled		
x Typematic Rate (Chars/Sec)	6		
x Typematic Delay (Msec)	250		
Security Option	Setup		
OS Select For DRAM > 64MB	Non-OS2		
Video BIOS Shadow	Enabled		
C8000-CBFFF Shadow	Disabled		

↑|←:Move Enter:Select +/-/PU/PD:Value F10:Save ESC:Exit F1:General Help
F5:Previous Values F6:Fail-Safe Defaults F7:Optimized Defaults

This page is the lower half of Advanced BIOS Features submenu.

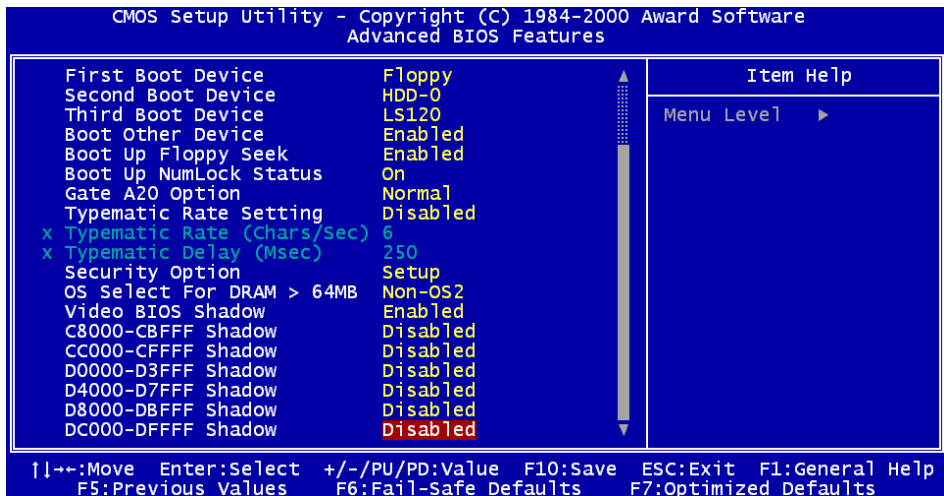

Advanced BIOS Features > Virus Warning

Virus Warning

Enabled

Disabled

Set this parameter to Enabled to activate the warning message. This feature protects the boot sector and partition table of your hard disk from virus intrusion. Any attempt during boot up to write to the boot sector of the hard disk drive stops the system and the following warning message appears on the screen. Run an anti-virus program to locate the problem.

! WARNING !

Disk Boot Sector is to be modified
Type "Y" to accept write, or "N" to abort write
Award Software, Inc.

Advanced BIOS Features > CPU Internal Cache

CPU Internal Cache

Enabled

Disabled

Enabling this parameter activates the CPU internal cache (currently, PBSRAM cache). Disabling the parameter slows down the system. Therefore, we recommend that you leave it enabled unless you are troubleshooting a problem.



Advanced BIOS Features > External Cache

External Cache

Enabled

Disabled

Enabling this parameter activates the secondary cache. Disabling the parameter slows down the system. Therefore, we recommend that you leave it enabled unless you are troubleshooting a problem.

Advanced BIOS Features > CPU L2 Cache ECC Checking

CPU L2 Cache ECC Checking

Enabled

Disabled

This item lets you enable or disable L2 Cache [ECC](#) checking.

Advanced BIOS Features > Quick Power On Self Test

Quick Power on Self Test

Enable

Disabled

This parameter speeds up [POST](#) by skipping some items that are normally checked.

[Advanced BIOS Features > First Boot Device](#)

[Advanced BIOS Features > Second Boot Device](#)

[Advanced BIOS Features > Third Boot Device](#)

First Boot Device

A:

LS/ZIP

C:

SCSI

CDROM

D:

E:

F:

LAN

Disabled

This parameter allows you to specify the system boot up search sequence. The hard disk ID are listed below:

C: Primary master

D: Primary slave

E: Secondary master

F: Secondary slave

LS: LS120

Zip: IOMEGA ZIP Drive

LAN: LAN card with boot ROM

Advanced BIOS Features > Boot Other Device

Boot Other Device

Enabled

Disabled

This parameter allows you to enable other system boot up devices that is not described above.

Advanced BIOS Features > Boot Up Floppy Seek

Boot Up Floppy**Seek**

Enable

Disabled

Setting this item to force the system to seek the status in detail and detects any errors in both floppy drives during POST.

Advanced BIOS Features > Boot Up NumLock Status

Boot Up NumLock**Status**

On

Off

Setting this parameter to On enables the numeric function of the numeric keypad. Set this parameter to Off to disregard the function. Disabling the numeric function allows you to use the numeric keypad for cursor control.

Advanced BIOS Features > Gate A20 Option

Gate A20 Option

Normal

Fast

Select if chipset or keyboard controller should control gate A20.

Normal : A pin in the keyboard controller controls GateA20.

Fast : Lets chipset control GateA20.

Advanced BIOS Features > Typematic Rate Setting

Typematic Rate**Setting**

Disable

Enable

Set this parameter to Enable/Disable the keyboard repeat function. When enabled, continually holding down a key on the keyboard will generate repeatedly keystrokes.

Advanced BIOS Features > Typematic Rate (Chars/Sec)

Typematic Rate6, 8, 10, 12, 15, 20,
24, 30

This item allows you to control the speed of repeated keystrokes. The default is 30 characters/sec.

Advanced BIOS Features > Typematic Delay (Msec)

Typematic Delay

250, 500, 750, 1000

This parameter allows you to control the delay time between the first and the second keystroke (where the repeated keystrokes begin).

Advanced BIOS Features > Security Option

Security Option

Setup

System

The **System** option limits access to both the System boot and BIOS setup. A prompt asking you to enter your password appears on the screen every time you boot the system. The **Setup** option limits access only to BIOS setup. To disable the security option, select Password Setting from the main menu, don't type anything and just press <Enter>.

Advanced BIOS Features > OS Select for DRAM > 64MB

OS Select for DRAM
> 64MB

OS/2

Non-OS/2

Set to OS/2 if your system is utilizing an OS/2 operating system and has a memory size of more than 64 MB.



Advanced BIOS Features > Video BIOS Shadow

Video BIOS Shadow

Enabled

Disabled

VGA BIOS Shadowing means to copy video display card BIOS into the DRAM area. This enhances system performance because DRAM access time is faster than ROM.

Advanced BIOS Features > C800-CBFF Shadow

Advanced BIOS Features > CC00-CFFF Shadow

Advanced BIOS Features > D000-D3FF Shadow

Advanced BIOS Features > D400-D7FF Shadow

Advanced BIOS Features > D800-DBFF Shadow

Advanced BIOS Features > DC00-DFFF Shadow

C800-CBFF

Shadow

Enabled

Disabled

These six items are for shadowing ROM code on other expansion cards. Before you set these parameters, you need to know the specific addresses of that ROM code. If you do not know this information, enable all the ROM shadow settings.

Note: *The F000 and E000 segments are always shadowed because BIOS code occupies these areas.*

Advanced Chipset Features

The "Advanced Chipset Features" includes settings for the chipset dependent features. These features are related to system performance.

CMOS Setup Utility - Copyright (C) 1984-2000 Award Software
Advanced Chipset Features

Bank 0/1 DRAM Timing	SDRAM 8/10ns	↑	Item Help
Bank 2/3 DRAM Timing	SDRAM 8/10ns		Menu Level ▶
Bank 4/5 DRAM Timing	SDRAM 8/10ns		
SDRAM Cycle Length	3		
DRAM Clock	Host CLK		
Memory Hole	Disabled		
PCI Master Pipeline Req	Enabled		
P2C/C2P Concurrency	Enabled		
Fast R-W Turn Around	Disabled		
System BIOS Cacheable	Disabled		
Video RAM Cacheable	Disabled		
AGP Aperture Size	64M		
AGP-4X Mode	Enabled		
AGP Driving Control	Auto		
x AGP Driving Value	DA		
K7 Clock Control Select	Optimal		
OnChip USB	Enabled		
USB Keyboard Support	Disabled		
USB Mouse Support	Disabled		

↑|↔:Move Enter:Select +/-/PU/PD:Val
F5:Previous Values F6:Setup Def

Warning: Make sure you fully understand the items contained in this menu before you try to change anything. You may change the parameter settings to improve system performance. However, it may cause your system to be unstable if the setting is not correct for your system configuration.

This page is the lower half of Advanced Chipset Features submenu.

CMOS Setup Utility - Copyright (C) 1984-2000 Award Software
Advanced Chipset Features

System BIOS Cacheable	Disabled	Item Help Menu Level ▶ Enabled adds a parity check to the boot-up memory tests. Select Enabled only if the system DRAM contains parity
Video RAM Cacheable	Disabled	
AGP Aperture Size	64M	
AGP-4X Mode	Enabled	
AGP Driving Control	Auto	
x AGP Driving Value	DA	
K7 Clock Control Select	Optimal	
OnChip USB	Enabled	
USB Keyboard Support	Disabled	
USB Mouse Support	Disabled	
OnChip Sound	Enable	
CPU to PCI Write Buffer	Enabled	
PCI Dynamic Bursting	Enabled	
PCI Master 0 WS Write	Enabled	
PCI Delay Transaction	Enabled	
PCI#2 Access #1 Retry	Enabled	
AGP Master 1 WS Write	Disabled	
AGP Master 1 WS Read	Disabled	
Memory Parity/ECC Check	Disabled	

[↓→]:Move Enter:Select +/-/PU/PD:Value F10:Save ESC:Exit F1:General Help
 F5:Previous Values F6:Setup Defaults F7:Turbo Defaults

[Advanced Chipset Features > Bank 0/1 DRAM Timing](#)

[Advanced Chipset Features > Bank 2/3 DRAM Timing](#)

[Advanced Chipset Features > Bank 4/5 DRAM Timing](#)

Bank 0/1 DRAM

Timing

SDRAM 8/10 ns

Normal

Medium

Fast

Turbo

Change this item to control the DRAM timing.

The default value is “**Normal**”. Do not change the default value without understanding engineering knowledge.

[Advanced Chipset Features > SDRAM Cycle Length](#)

SDRAM Cycle Length

2

3

This [SDRAM](#) timing is calculated by clocks. Adjust its value affects SDRAM performance, the default setting is 2 clocks.

If your system has unstable problem, change 2T to 3T.

Advanced Chipset Features > DRAM Clock

DRAM Clock

Host CLK,
HCLK +33M
Auto

To be easily understood by users who do not overclock, it is displayed here as Host CLK and HCLK +33M. Actually, it is CPU CLK and CPU +PCI CLK. Default setting is **Auto**.

Advanced Chipset Features > Memory Hole

Memory Hole

15 M – 16 M
Disabled

This option lets you reserve system memory area for special ISA cards. The chipset accesses code/data of these areas from the ISA bus directly. Normally, these areas are reserved for memory mapped I/O card.

Advanced Chipset Features > PCI Master Pipeline Req

**PCI Master Pipeline
Req**

Enabled
Disabled

Enable this item to enhance PCI bus for better performance. Default setting is **Disabled**.

Advanced Chipset Features > P2C/C2P Concurrency

P2C/C2P Concurrency

Enabled

Disabled

This option enables PCI to CPU and CPU to PCI concurrent mode. It allows CPU and AGP/PCI master to active at the same time.

Advanced Chipset Features > Fast R-W Turn Around

**Fast R-W Turn
Around**

Enabled

Disabled

This item is used to increase CPU read to write turn around time, which improves DRAM performance.

Advanced Chipset Features > System BIOS Cacheable

**System BIOS
Cacheable**

Enabled
Disabled

Setting it to Enabled allows the system BIOS data at F0000h-FFFFFh (in main memory, 64K in all) to be cacheable for a better system performance.

However, if any program writes to this memory range, a system error may result.

Advanced Chipset Features > Video RAM Cacheable

Video RAM Cacheable

Enabled
Disabled

This item lets you cache Video RAM A000 and B000. In general, it should improve VGA BIOS performance. But since VGA BIOS has been shadowed (mirror) into video RAM, the performance improvement may not be so obvious.

Advanced Chipset Features > AGP Aperture Size

AGP Aperture Size

4M, 8M, 16M, 32M,
64M, 128M

This item lets you determine the effective size of the [AGP](#) Graphic Aperture. The AGP Aperture is an memory area, used to transfer data to/from AGP card.

Advanced Chipset Features > AGP-4X Mode

AGP-4X Mode

Enabled

Disabled

This item allows you to enable your AGP 4X mode.

4X mode has higher graphic performance, but may have more compatibility problem.

Advanced Chipset Features > AGP Driving Control

AGP Driving Control

Auto

Manual

This item is use for control AGP drive strength.

Auto: Setup AGP drive strength by default setting.

Manual: Setup AGP drive strength by manual setting.

Advanced Chipset Features > AGP Driving Value

AGP Driving Value

DA

Key in a HEX number Min=000 Max=00FF

Bit 7-4: AGP output buffer drive strength N control.

Bit 3-0: AGP output buffer drive strength P control.

Advanced Chipset Features > K7 Clock Control Select

K7 Clock Control**Select**

Default

Optimal

This option used to adjust clock control circuit within K7 CPU, if set at "optimal" different CPU clock ratio may have different clock control timing. It is recommended to set at "**Default**".

Advanced Chipset Features > OnChip USB

OnChip USB

Enabled

Disabled

This item is used to enable or disable [USB](#) controller.

Advanced Chipset Features > USB Keyboard Support

USB Keyboard**Support**

Enabled

Disabled

This item lets you enable or disable the [USB](#) keyboard driver within the onboard BIOS. The keyboard driver simulates legacy keyboard command and let you use USB keyboard during [POST](#) or after boot if you don't have USB driver in the operating system.

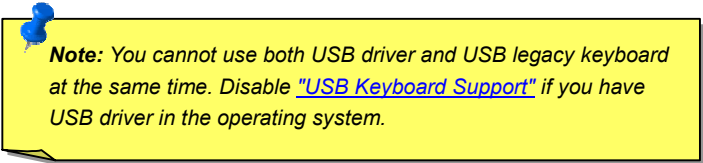

Note: You cannot use both USB driver and USB legacy keyboard at the same time. Disable "[USB Keyboard Support](#)" if you have USB driver in the operating system.

Advanced Chipset Features > USB Mouse Support

USB Mouse Support

Enabled

Disabled

This item lets you enable or disable the [USB](#) mouse driver within the onboard BIOS.

Advanced Chipset Features > OnChip Sound

OnChip Sound

Enable

Disable

This item is used to enable or disable the onboard audio.

Advanced Chipset Features > CPU to PCI Write Buffer

**CPU to PCI Write
Buffer**

Enable
Disable

This item is used to enable or disable CPU to PCI write buffer. The write buffer stores CPU to PCI data temporary and release CPU for other task, It improves CPU performance, but some times, creates compatibility problem.

Advanced Chipset Features > PCI Dynamic Bursting

PCI Dynamic Bursting

Enable
Disable

This item is used to improve PCI performance and can be adjusted to solve PCI compatibility problem.

If enabled, no matter burstable or non-burstable PCI write goes into PCI write buffer. Otherwise, non-burstable PCI write goes to PCI bus directly.

Advanced Chipset Features > PCI Master 0 WS Write

PCI Master 0 WS**Write**

Enable

Disable

This item is used to control the PCI master write cycle. If enabled, there is no wait state. If disabled, there will be one wait state for PCI master write.

Advanced Chipset Features > PCI Delay Transaction

PCI Delay Transaction

Enable

Disable

This item lets you control the Delayed Transaction function of the VIA 586A chipset (Intel PCI to ISA bridge). This function is used to meet latency of PCI cycles to or from ISA bus. Try to enable or disable it, if you have ISA card compatibility problem.

Advanced Chipset Features > PCI#2 Access #1 Retry

PCI#2 Access #1**Retry**

Enable

Disable

This item is used to enable or disable AGP master retry disconnect. If enabled, AGP master will be disconnected if max retries are attempted without success. PCI#2 means AGP.

Advanced Chipset Features > AGP Master 1 WS Write

AGP Master 1 WS**Write**

Enable

Disable

This item is used to enable or disable AGP master 1 wait state write. Wait state can be used to delay AGP operation and improve compatibility. If you find your AGP operation is unstable, you can try to enable this wait state.

Advanced Chipset Features > AGP Master 1 WS Read

AGP Master 1 WS**Read**

Enable

Disable

This item is used to enable or disable AGP master 1 wait state read. Wait state can be used to delay AGP operation and improve compatibility. If you find your AGP operation is unstable, you can try to enable this wait state.

Advanced Chipset Features > Memory Parity / ECC Check

Memory Parity / ECC**Check**

Enable

Disable

This lets you enable or disable memory [ECC](#) function. The ECC algorithm has the ability to detect double bit error and automatically correct single bit error.

Integrated Peripherals

The following screen appears if you select the option "Integrated Peripherals" from the main menu. This option allows you to configure the I/O features.

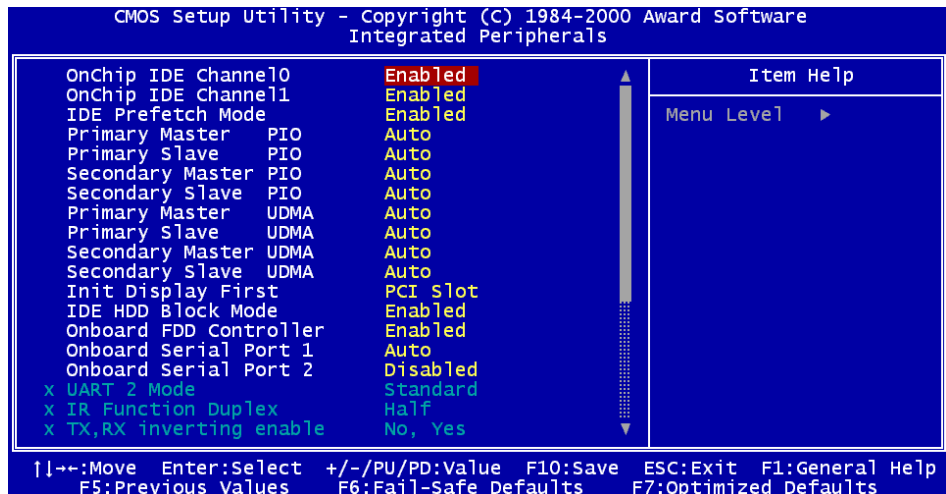

This page is the lower half of Integrated Peripherals submenu.

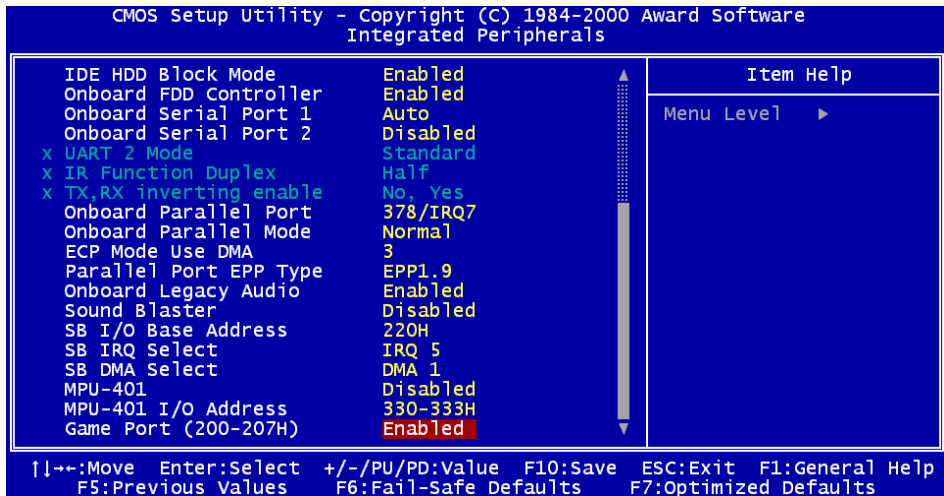

Integrated Peripherals > OnChip IDE Channel0

Integrated Peripherals > OnChip IDE Channel1

OnChip IDE Channel0

Enabled

Disabled

This item is used to enable and disable IDE channel 0. If you install a high-performance IDE card on your system, you have to disable this item first.

Integrated Peripherals > IDE Prefetch Mode

IDE Prefetch Mode

Enabled

Disabled

This item is used to enable and disable IDE prefetch mode. It is useful to improve the system performance.

[Integrated Peripherals > Primary Master PIO](#)

[Integrated Peripherals > Primary Slave PIO](#)

[Integrated Peripherals > Secondary Master PIO](#)

[Integrated Peripherals > Secondary Slave PIO](#)

Primary Master PIO

Auto

Mode 1

Mode 2

Mode 3

Mode 4

Setting this item to **Auto** activates the HDD speed auto-detect function. The PIO mode specifies the data transfer rate of HDD. For example: mode 0 data transfer rate is 3.3MB/s, mode 1 is 5.2MB/s, mode 2 is 8.3MB/s, mode 3 is 11.1MB/s and mode 4 is 16.6MB/s. If your hard disk performance becomes unstable, you may manually try the slower mode.

Integrated Peripherals > Primary Master UDMA

Integrated Peripherals > Primary Slave UDMA

Integrated Peripherals > Secondary Master UDMA

Integrated Peripherals > Secondary Slave UDMA

Primary Master UDMA

Auto

Disabled

This item allows you to set the [ATA/66](#) mode supported by the hard disk drive connected to your primary IDE connector.

Integrated Peripherals > Init Display First

Init Display First

PCI Slot

AGP

If you installed a PCI VGA card and an [AGP](#) card at the same time, this item lets you decide which one is the initial display card.

Integrated Peripherals > IDE HDD Block Mode

IDE HDD Block Mode

Enabled

Disabled

This feature enhances disk performance by allowing multi-sector data transfers and eliminates the interrupt handling time for each sector. Most IDE drives, except with old designs, can support this feature.

Integrated Peripherals > Onboard FDD Controller

**Onboard FDD
Controller**

Enabled

Disabled

Setting this parameter to **Enabled** allows you to connect your floppy disk drives to the onboard floppy disk connector instead of a separate controller card. Change the setting to Disabled if you want to use a separate controller card.

Integrated Peripherals > Onboard Serial Port 1

Integrated Peripherals > Onboard Serial Port 2

Onboard Serial Port 1

Auto

3F8/IRQ4

2F8/IRQ3

3E8/IRQ4

2E8/IRQ3

Disabled

This item allows you to assign address and interrupt for the board serial port. Default is **Auto**.

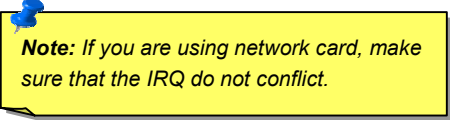

Note: *If you are using network card, make sure that the IRQ do not conflict.*

Integrated Peripherals > UART 2 Mode

UART 2 Mode

Standard

HPSIR

ASKIR

This item is configurable only if the "[Onboard Serial Port 2](#)" is enabled. This allows you to specify the mode of serial port2. The available mode selections are:

Standard

Sets serial port 2 to operate in normal mode. This is the default setting.

HPSIR

This setting allows infrared serial communication at a maximum baud rate of 115K baud.

ASKIR

This setting allows infrared serial communication at a maximum baud rate of 19.2K baud.

Integrated Peripherals > IR Function Duplex**IR Function Duplex**

Full

Half

This item is used to select Full Duplex or Half Duplex of IR function. Normally, Full Duplex is faster, because it transmits data bi-direction at the same time.

Integrated Peripherals > TX, RX inverting enable

TX, RX inverting enable

No, No

No, Yes.

Yes, No

Yes, Yes

This item is used to select RxD (Receive Data) and TxD (Transmit Data) mode for UART2, when used for IR function. Please refer to the documentation that comes with your IR device.

Integrated Peripherals > Onboard Parallel Port

Onboard Parallel Port

3BC/IRQ7

378/IRQ7

278/IRQ5

Disabled

This item controls the onboard parallel port address and interrupt.

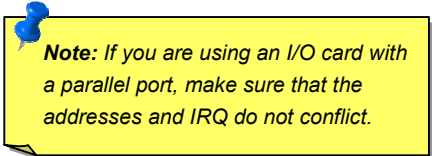

Note: If you are using an I/O card with a parallel port, make sure that the addresses and IRQ do not conflict.

Integrated Peripherals > Onboard Parallel Mode

Onboard Parallel**Mode**

Normal

ECP

EPP

ECP/EPP

This item lets you set the parallel port mode. The mode options are Normal, EPP (Enhanced Parallel Port) and ECP (Extended Parallel Port).

Normal (SPP - Standard and Bi-direction Parallel Port)

SPP is the IBM AT and PS/2 compatible mode.

EPP (Enhanced Parallel Port)

EPP enhances the parallel port throughput by directly writing/reading data to/from parallel port without latch.

ECP (Extended Parallel Port)

ECP supports DMA and RLE (Run Length Encoded) compression and decompression.

Integrated Peripherals > ECP Mode Use DMA

ECP Mode Use DMA

3

1

This item lets you set the DMA channel of ECP mode.

Integrated Peripherals > Parallel Port EPP Type

Parallel Port EPP**Type**

EPP1.7

EPP1.9

This item lets you select EPP mode protocol.

Integrated Peripherals > Onboard Legacy Audio

Onboard Legacy**Audio**

Enable

Disable

This motherboard has a Sound Blaster Pro compatible onboard audio. Legacy means DOS mode, some old software can only support DOS mode, enable this item if you want to run these software under DOS mode.

Integrated Peripherals > Sound Blaster

Sound Blaster

Enable

Disable

Since this motherboard has a Sound Blaster Pro compatible onboard audio, you can select this item to force the on-board audio to simulate as a Sound Blaster.

Integrated Peripherals > SB I/O Base Address

SB I/O Base Address220H, 240H, 260H,
280H

This item is used to select Sound Blaster compatible I/O base address for the onboard audio.

Integrated Peripherals > SB IRQ Select

SB IRQ SelectIRQ5, IRQ7, IRQ9,
IRQ10

This item is used to select Sound Blaster compatible IRQ for the onboard audio.

Integrated Peripherals > SB DMA Select

SB DMA Select

DMA0, DMA1,
DMA2, DMA3

This item is used to select Sound Blaster compatible DMA for the onboard audio.

Integrated Peripherals > MPU-401

MPU-401

Enabled
Disabled

This item is used to select I/O base address for the MIDI port.

Integrated Peripherals > MPU-401 I/O Address

MPU-401 I/O Address

300-303H
310-313H
320-323H
330-333H

This item is used to select I/O base address for the MIDI port.

Integrated Peripherals > Game Port (200-207H)**Game Port (200-207H)**

Enabled

Disabled

This item is used to assign an address for the Game port.

Power Management Setup

The Power Management Setup screen enables you to control the motherboard green features. See the following screen.

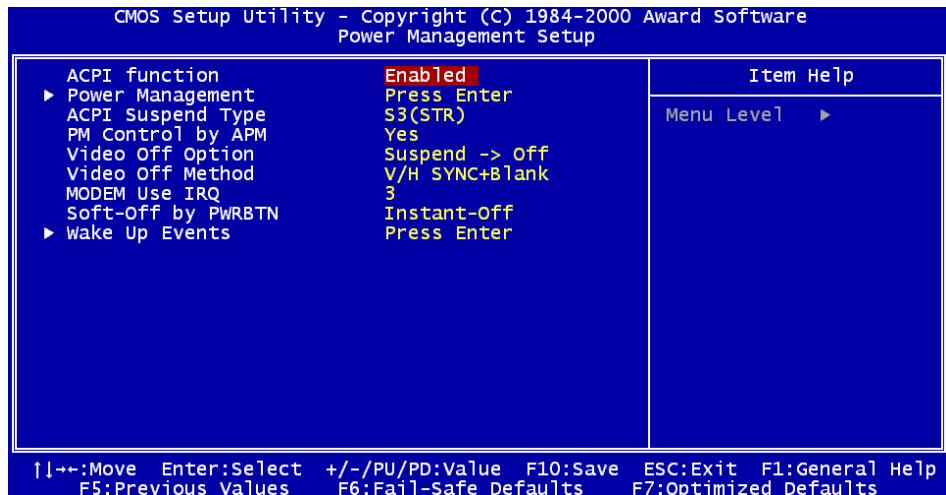

Power Management Setup > ACPI Function

ACPI Function

Enabled

Disabled

If your OS is ACPI enabled you have to set this item to Enabled, or there may be unexpected errors. If your OS is APM mode, you can remain the Disabled setting.

Power Management Setup > Power Management > Power Management

Power Management

Max Saving

Min Saving

User Define

This function allows you to set the default parameters of power-saving modes. Set to “**User Define**” to choose your own parameters or turning off the power management function.

Mode	Suspend	HDD Power Down
Min Saving	1 hour	15 min
Max Saving	1 min	1 min

Power Management Setup > Power Management > HDD Power Down**HDD Power Down**

Disabled, 1 Min,,
15 Min

This option lets you specify the IDE HDD idle time before the device enters the power down state. This item is independent from the power states previously described in this section (Standby and Suspend).

Power Management Setup > Power Management > Doze Mode**Doze Mode**

Disabled, 1 Min, 2 Min,
4 Min., 6 Min, 8 Min, 10
Min, 20 Min, 30 Min, 40
Min, 1 Hour

This item lets you set the period of time after which the system enters into Doze mode.

Power Management Setup > Power Management > Suspend Mode

Suspend Mode

Disabled, 1 Min, 2 Min,
4 Min., 6 Min, 8 Min, 10
Min, 20 Min, 30 Min, 40
Min, 1 Hour

This item lets you set the period of time after which the system enters into Suspend mode. The Suspend mode can be Power On Suspend or Suspend to Hard Drive, selected by "Suspend Type".

Power Management Setup > ACPI Suspend Type

ACPI Suspend Type

S1 (POS)
S3 (STR)

This function allows you to select suspend types. S1 is Power On Suspend and S3 is Suspend to RAM.

Power Management Setup > PM Controlled by APM

PM Controlled by**APM**

Yes
No

If "Max Saving" is selected, you can turn on this item, transfer power management control to APM (Advanced Power Management) and enhance power saving function. For example, stop CPU internal clock.

Power Management Setup > Video Off Option

Video Off Option

Suspend -> Off

All modes -> Off

Always On

This option is specified to change the video-off and power-saving mode, which is used to decide whether the video is off in the suspend mode.

Power Management Setup > Video Off Method

Video Off Method

V/H SYNC + Blank

DPMS Support

Blank Screen

This determines the way that the monitor is off. Blank Screen writes blanks to video buffer. V/H SYNC + Blank allows BIOS to control VSYNC and HSYNC signals. This function applies only for DPMS (Display Power Management Standard) monitor. The DPMS mode uses DPMS functions provided by the VGA card.

Power Management Setup > Modem Use IRQ

Modem Use IRQ

3, 4, 5, 7, 9, 10, 11, N/A

This item lets you set an IRQ for the modem.

Power Management Setup > Soft-Off by PWRBTN

Soft-Off by PWRBTN

Delay 4 sec.

Instant-Off

This is a specification of ACPI and supported by hardware. When **Delay 4 sec.** is selected, the soft power switch on the front panel can be used to control power On, Suspend and Off. If the switch is pressed less than 4 sec during power On, the system will go into Suspend mode. If the switch is pressed longer than 4 sec, the system will be turned Off. The default setting is **Instant-Off**, soft power switch is only used to control On and Off, there is no need to press 4 sec, and there is no Suspend.

Power Management Setup > Wake up Events > VGA

VGA

On

Off

These items enable or disable the detection of VGA activities for power down state transition.

Power Management Setup > Wake up Events > LPT & COM**LPT & COM**

LPT/COM

NONE

LPT

COM

These items enable or disable the detection of LPT & COM activities for power down state transition.

Power Management Setup > Wake up Events > HDD & FDD**HDD & FDD**

On

Off

These items enable or disable the detection of HDD & FDD activities for power down state transition.

Power Management Setup > Wake up Events > PCI Master**PCI Master**

On

Off

These items enable or disable the detection of PCI Master activities for power down state transition.

Power Management Setup > Wake up Events > PowerOn by PCI Card**PowerOn by PCI
Card**

Enabled
Disabled

Enable this item to let you boot your system by remote control through a PCI card, such as LAN card.

Power Management Setup > Wake up Events > Modem Ring Resume**Modem Ring
Resume**

Enabled
Disabled

This option lets you specify enable or disable Wake On Modem function.

Power Management Setup > Wake up Events > RTC Alarm Resume

RTC Alarm Resume

Enabled

Disabled

The Wake Up Timer is more like an alarm, which wakes up and powers on your system at a pre-defined time for a specific application. It can be set to wake up everyday or on specific date within a month. The date/time is accurate to within a second. This option lets you enable or disable the RTC Wake Up function.

Power Management Setup > Wake up Events > Date (of Month)

Date (of Month)

0, 1,, 31

This item is displayed when you enable the Wake On RTC Timer option. Here you can specify what date you want to wake up the system. For Example, setting to 15 will wake up the system on the 15th day of every month.



Tip: Setting this item to 0 will wake up the system on the specified time (which can be set in the Wake On RTC Timer) every day.

Power Management Setup > Wake up Events > Resume Time (hh:mm:ss)**ResumeTime****(hh:mm:ss)**

hh:mm:ss

This item is displayed when you enable the Wake On RTC Timer option. Here you can specify what time you want to wake up the system.

Power Management Setup > Wake up Events > Primary INTR**Primary INTR**

ON

OFF

This item is used to enable or disable the detection of IRQ3-15 or NMI interrupt events for power down state transition. Normally, this is applied to network card.

Power Management Setup > Wake up Events > IRQs Activity Monitoring**IRQs Activity
Monitoring**

IRQ3 (COM 2)

IRQ4 (COM 1)

IRQ5 (LPT 2)

IRQ6 (Floppy Disk)

IRQ7 (LPT 1)

IRQ8 (RTC Alarm)

IRQ9 (IRQ2 Redir)

IRQ10 (Reserved)

IRQ11 (Reserved)

IRQ12 (PS/2 Mouse)

IRQ13 (Coprocessor)

IRQ14 (Hard Disk)

IRQ15 (Reserved)

These items enable or disable the detection of devices activities by IRQs for power down state transition.

PnP/PCI Configurations

The [PnP/PCI](#) Configurations allows you to configure the ISA and PCI devices installed in your system. The following screen appears if you select the option "PnP/PCI Configurations" from the main menu.

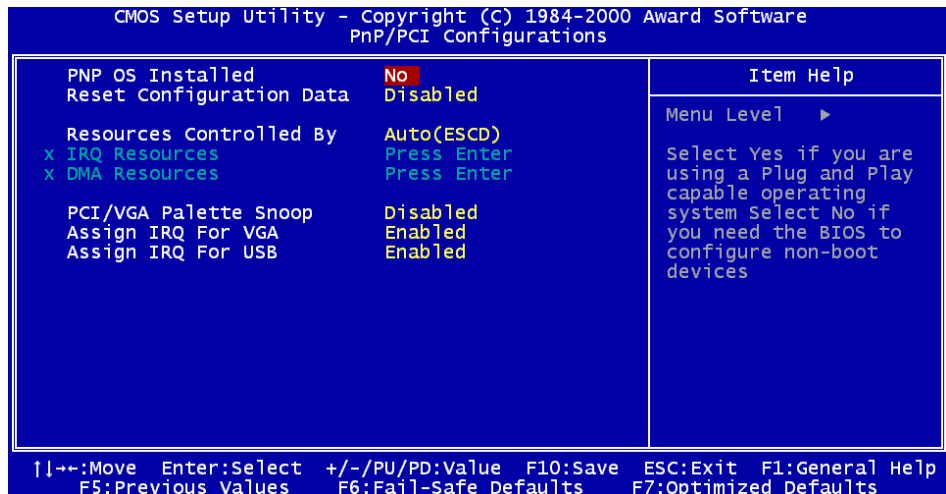

PnP/PCI Configurations > PNP OS Installed

PnP OS Installed

Yes

No

Normally, the PnP resources are allocated by BIOS during **POST** (Power-On Self Test). If you are using a **PnP** operating system (such as Windows 95), set this item to **Yes** to inform BIOS to configure only the resources needed for booting (VGA/IDE or SCSI). The rest of system resources will be allocated by PnP operating system.

PnP/PCI Configurations > Reset Configuration Data

Reset Configuration**Data**

Enabled

Disabled

In case conflict occurs after you assign the IRQs or after you configure your system, you can enable this function, allow your system to automatically reset your configuration and reassign the IRQs, DMAs, and I/O address.

PnP/PCI Configurations > Resources Controlled By

Resources Controlled**By**

Auto (ESCD)

Manual

Setting this option to Manual allows you to individually assign the IRQs and DMAs to the ISA and PCI devices. Set this to **Auto** to enable the auto-configuration function.

PnP/PCI Configurations > IRQ Resources

IRQ-3 assigned to

IRQ-4 assigned to

IRQ-5 assigned to

IRQ-7 assigned to

IRQ-9 assigned to

IRQ-10 assigned to

IRQ-11 assigned to

IRQ-12 assigned to

IRQ-14 assigned to

IRQ-15 assigned to

PCI/ISA PnP

Legacy ISA

When resources are controlled manually, assign each system interrupt a type, depending on the type of device using the interrupt

The available IRQs are: IRQ3 (COM2), IRQ4 (COM1), IRQ5 (Network/Sound or Others), IRQ7 (Printer or Others), IRQ9 (Video or Others), IRQ10 (SCSI or Others), IRQ11 (SCSI or Others), IRQ12 (PS/2 Mouse), IRQ14 (IDE1), IRQ15 (IDE2).

PnP/PCI Configurations > DMA Resources

DMA-0 assigned to

DMA-1 assigned to

DMA-3 assigned to

DMA-5 assigned to

DMA-6 assigned to

DMA-7 assigned to

PCI/ISA PnP

Legacy ISA

When resources are controlled manually, assign each system DMA channel a type, depending on the type of device using the DMA channel

PnP/PCI Configurations > PCI/VGA Palette Snoop

PCI/VGA Palette

Snoop

Enabled

Disabled

Enabling this item informs the PCI VGA card to keep silent (and to prevent conflict) when palette register is updated (i.e., accepts data without responding any communication signals). This is useful only when two display cards use the same palette address and plugged in the PCI bus at the same time (such as MPEQ or Video capture). In such case, PCI VGA is silent while MPEQ/Video capture is set to function normally.

PnP/PCI Configurations > Assign IRQ For VGA

Assign IRQ For VGA

Enabled

Disabled

In case conflict occurs after you assign the IRQs or after you configure your system, you can enable this function, allow your system to automatically reset your configuration and reassign the IRQs, DMAs, and I/O address.

PnP/PCI Configurations > Assign IRQ For USB

Assign IRQ For USB

Enabled

Disabled

In case conflict occurs after you assign the IRQs or after you configure your system, you can enable this function, allow your system to automatically reset your configuration and reassign the IRQs, DMAs, and I/O address.

PC Health Status

This submenu displays hardware monitor status and provide some basic control function. You can install Hardware Monitoring utility without using setup items in this submenu.

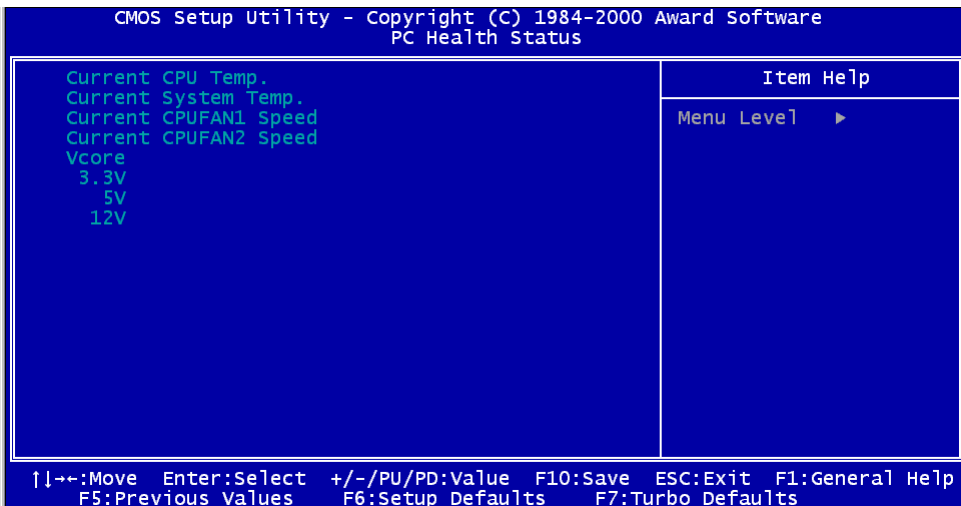

Load Setup Defaults

The "Load Setup Defaults" option loads optimized settings for optimum system performance. Optimal settings are relatively safer than the Turbo settings. **All the product verification, compatibility/reliability test report and manufacture quality control are based on "Load Setup Defaults"**. We recommend to use this settings for normal operation. "Load Setup Defaults" is not the slowest setting for this motherboard. If you need to verify an unstable problem, you may manually set the parameter in the "[Advanced BIOS Features](#)" and "[Advanced Chipset Features](#)" to get slowest and safer setting.

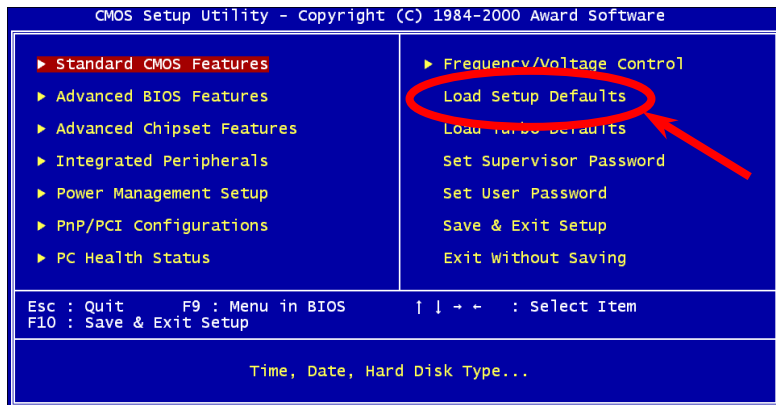

Load Turbo Defaults

The "Load Turbo Defaults" option gives better performance than "Load Setup Defaults". It is provided for the convenience of power user who wants to push the motherboard to get better performance. Turbo setting does not go through all the detail reliability and compatibility test, it is tested only with limited configuration and loading (for example, a system that contains only a VGA card and two DIMMs). **Use Turbo setting only when you fully understand the items in Chipset Setup menu.** The performance improvement of Turbo setting is normally around 3% to 5%, depending on the chipset and the application.

Set Supervisor Password

Password prevents unauthorized use of your computer. If you set a user password, the system prompts for the correct password before boot or access to Setup.

To disable the password, press when prompted to enter the password. The screen displays a message confirming that the password has been disabled.

Set User Password

Password prevents unauthorized use of your computer. If you set a user password, the system prompts for the correct password before boot or access to Setup.

To set a password:

1. At the prompt, type your password. Your password can be up to 8 alphanumeric characters. When you type the characters, they appear as asterisks on the password screen box.
2. After typing the password, press.
3. At the next prompt, re-type your password and press again to confirm the new password. After the password entry, the screen automatically reverts to the main screen.

To disable the password, press when prompted to enter the password. The screen displays a message confirming that the password has been disabled.

Save & Exit Setup

This function automatically saves all CMOS values before leaving Setup.

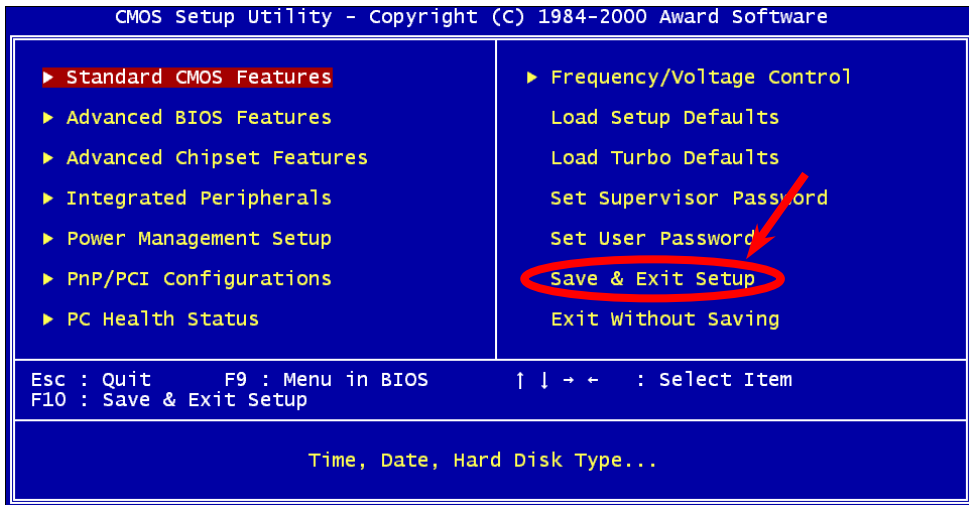

Exit without Saving

Use this function to exit Setup without saving the CMOS value changes. Do not use this option if you want to save the new configuration.

NCR SCSI BIOS and Drivers

Due to [Flash ROM](#) space limitation, some BIOS versions do not include NCR 53C810 SCSI BIOS (supports DOS, Windows 3.1 and OS/2) into the system BIOS. Many SCSI cards have its own SCSI BIOS on card, for better system performance, you may use the drivers that come with the NCR SCSI card or with your operating system. For details, refer to the installation manual of your NCR 53C810 SCSI card.

BIOS Upgrade

By flashing your motherboard, you agree to accept the possibility of BIOS flash failure. If you motherboard is working and is stable, and there are no major bugs that were fixed by a latter BIOS revision, we recommend that you DO NOT try to upgrade your BIOS.

By doing so, you are taking a risk of BIOS flash failure. If you indeed intent on upgrading, PLEASE BE SURE to use the right BIOS revision for the right motherboard model.

AOpen Easy Flash is a little different than traditional flash method. The [BIOS](#) binary file and flash routine are linked together and you simply run a single commend to complete the flash process.



Caution: *AOpen Easy Flash BIOS programs are designed to be compatible with the Award BIOS. At the date of this note, AOpen Easy Flash BIOS programs are not available for AMI BIOS. AMI BIOS appears mostly only on old 486 boards and some early Pentium boards. Please be sure to view the README compressed inside the BIOS package before upgrading, and follow upgrade instructions carefully. This will minimize the chance of flash failures.*

Below are the steps for easy flashing procedures: (applies for Award BIOS ONLY)

1. Download new BIOS upgrade [zipped](#) file from AOpen's web site.
For example, AK33102.ZIP.
2. Run shareware PKUNZIP (<http://www.pkware.com/>) which supports miscellaneous operation systems to extract the binary BIOS file and the flash utility.
Or Winzip (<http://www.winzip.com/>) in Windows environment.
3. Save the unzipped file into a bootable floppy disk.
For example, AK33102.BIN & AK33102.EXE
4. Reboot the system to DOS mode without loading any memory handler (such as EMM386) or device driver. It needs around 520K free memory space.
5. Execute A:> AK33102 and the program will do the rest of it.

DO NOT turn off the power during FLASH PROCESS until you are asked to!!

Del

6. Reboot system and press to [enter BIOS setup](#). Choose "[Load Setup Defaults](#)", then "[Save & Exit Setup](#)". Done!



Warning: *The new BIOS upgrade will permanently replace your original BIOS's settings and PnP information when flashing. You may need to reconfigure your BIOS setting and re-install Win95/Win98 as well as your add-on cards, so that your system can go back to work as normal.*

Overclocking

As a leading manufacturer in motherboard industry, AOpen always listens to what customers want and develop products to fit different user's requirements. Reliability, compatibility, leading technology and friendly features are our basic goals when designing motherboards. Other than above mentioned design criteria, there are power users who are always seeking to push the limitation of the system performance by overclocking which we call them "Overclocker".



Warning: *The design of this product follows CPU and chipset vendor's design guideline. Any attempts to push beyond product specification are not recommended and you are taking your own risk to damage your system or important data. Before doing overclocking, you must make sure your components are able to tolerate such abnormal setting, especially CPU, memory, hard disks, and AGP VGA cards.*



Tip: *Note that overclocking may also cause thermal problem. Please make sure that the cooling fan and the heatsink were adequate to dissipate excessive heat that's generated by overclocking the CPU.*

VGA and HDD

VGA and HDD are key components for overclocking, following list are what have been tested in our lab. Please note that AOpen can not guaranty they can be successful overclocked again.

VGA: <http://www.aopen.com.tw/tech/report/overclk/mb/vga-oc.htm>

HDD: <http://www.aopen.com.tw/tech/report/overclk/mb/hdd-oc.htm>

Glossary

AC97

Basically, AC97 specification separates sound/modem circuit to two parts, digital processor and a [CODEC](#) for analog I/O, they are linked by AC97 link bus. Since digital processor can be put into motherboard main chipset, the cost of sound/modem onboard solution can be reduced.

ACPI (Advanced Configuration & Power Interface)

ACPI is the power management specification of PC97 (1997). It intends to save more power by taking full control of power management to operating system and bypass [BIOS](#). The chipset or super I/O chip needs to provide standard register interface to operating system (such as Windows 98). This is a bit similar as the [PnP](#) register interface. ACPI defines ATX momentary soft power switch to control the power state transition.

AGP (Accelerated Graphic Port)

AGP is a bus interface targeted for high-performance 3D graphic. AGP supports only memory read/write operation and single-master single-slave one-to-one only. AGP uses both rising and falling edge of the 66MHz clock, for 2X AGP, the data transfer rate is $66\text{MHz} \times 4\text{byte} \times 2 = 528\text{MB/s}$. AGP is now moving to 4X mode, $66\text{MHz} \times 4\text{byte} \times 4 = 1056\text{MB/s}$. AOpen is the first company to support 4X AGP motherboards by both AX6C (Intel 820) and MX64/AX64 (VIA 694x), started from Oct 1999.

AMR (Audio/Modem Riser)

The [CODEC](#) circuit of AC97 sound/modem solution can be put on motherboard or put on a riser card (AMR card) that connects to motherboard through AMR connector.

AOpen Bonus Pack CD

A disc bundled with AOpen motherboard product, there are motherboard drivers, Acrobat Reader for [PDF](#) online manual and other useful utilities.

APM

Unlike [ACPI](#), BIOS controls most APM power management functions. AOpen Suspend to Hard Drive is a good example of APM power management.



ATA/66

ATA/66 uses both rising edge and falling edge but doubles [UDMA/33](#) transfer rate. The data transfer rate is 4 times of the PIO mode 4 or DMA mode 2, 16.6MB/s x4 = 66MB/s. To use ATA/66, you need special ATA/66 IDE cable.

ATA/100

ATA/100 is a new IDE specification under developing. ATA/100 uses both rising edge and falling edge as [ATA/66](#) but clock cycle time is reduced to 40ns. The data transfer rate is (1/40ns) x 2 bytes x 2 = 100MB/s. To use ATA/100, you need special 80-wire IDE cable, the same as ATA/66.

BIOS (Basic Input/Output System)

BIOS is a set of assembly routine/program that reside in [EPROM](#) or [Flash ROM](#). BIOS controls Input/output devices and other hardware devices of motherboard. In general, to provide hardware independent portability, operation system and drivers is required to access BIOS without directly access hardware devices.

Bus Master IDE (DMA mode)

The traditional PIO (Programmable I/O) IDE requires the CPU to involve in all the activities of the IDE access including waiting for the mechanical events. To reduce the workload of the CPU, the bus master IDE device transfers data from/to memory without interrupting CPU, and releases CPU to operate concurrently while data is transferring between memory and IDE device. You need the bus master IDE driver and the bus master IDE HDD to support bus master IDE mode.

CODEC (Coding and Decoding)

Normally, CODEC means a circuit that can do digital to analog conversion and also the analog to digital conversion. It is part of [AC97](#) sound/modem solution.

DIMM (Dual In Line Memory Module)

DIMM socket has total 168-pin and supports 64-bit data. It can be single or double side, the golden finger signals on each side of PCB are different, that is why it was called Dual In Line. Almost all DIMMs are made by [SDRAM](#), which operate at 3.3V. Note that some old DIMMs are made by FPM/[EDO](#) and only operate at 5V. Do not confuse them with SDRAM DIMM..

ECC (Error Checking and Correction)

The ECC mode needs 8 ECC bits for 64-bit data. Each time memory is accessed, ECC bits are updated and checked by a special algorithm. The ECC algorithm has the ability to detect double-bit error and automatically correct single-bit error while parity mode can only detect single-bit error.



EDO (Extended Data Output) Memory

The EDO DRAM technology is actually very similar to FPM (Fast Page Mode). Unlike traditional FPM that tri-states the memory output data to start the pre-charge activity, EDO DRAM holds the memory data valid until the next memory access cycle, that is similar to pipeline effect and reduces one clock state.

EEPROM (Electronic Erasable Programmable ROM)

Also known as E²PROM. Both EEPROM and [Flash ROM](#) can be re-programmed by electronic signals, but the interface technology is different. Size of EEPROM is much smaller than flash ROM, AOpen motherboard uses EEPROM for jumper-less and battery-less design.

EPROM (Erasable Programmable ROM)

Traditional motherboard stores BIOS code in EPROM. EPROM can only be erased by ultra-violet (UV) light. If BIOS has to be upgraded, you need to remove EPROM from motherboard, clear by UV light, re-program, and then insert back.

EV6 Bus

EV6 Bus in the technology of Alpha processor from Digital Equipment Corporation. EV6 bus uses both rising and falling clock edge to transfer data, similar as DDR SDRAM or ATA/66 IDE bus.

EV6 Bus Speed = CPU external bus clock x 2.

For example, 200 MHz EV6 bus is actually using 100 MHz external bus clock, but the equivalent speed is 200 MHz.

FCC DoC (Declaration of Conformity)

The DoC is component certification standard of FCC EMI regulations. This standard allows DIY component (such as motherboard) to apply DoC label separately without a shielding of housing.

FC-PGA

FC means Flip Chip, FC-PGA is a new package of Intel for Pentium III CPU. It can plug into SKT370 socket, but require motherboard to add some signals on socket 370. That is, the motherboard needs to be redesigned. Intel is going to ship FC-PGA 370 CPU and phase out slot1 CPU.

Flash ROM

Flash ROM can be re-programmed by electronic signals. It is easier for BIOS to upgrade by a flash utility, but it is also easier to be infected by virus. Because of increase of new functions, BIOS size is increased from 64KB to 256KB (2M bit). AOpen AX5T is the first board to implement 256KB (2Mbit) Flash ROM. Now flash ROM size is moving to 4M bit on AX6C (Intel 820) and MX3W (Intel 810) motherboard.

FSB (Front Side Bus) Clock

FSB Clock means CPU external bus clock.

CPU internal clock = CPU FSB Clock x CPU Clock Ratio

I2C Bus

See [SMBus](#).

P1394

P1394 (IEEE 1394) is a standard of high-speed serial peripheral bus. Unlike low or medium speed [USB](#), P1394 supports 50 to 1000Mbit/s and can be used for video camera, disk and LAN.

Parity Bit

The parity mode uses 1 parity bit for each byte, normally it is even parity mode, that is, each time the memory data is updated, parity bit will be adjusted to have even count "1" for each byte. When next time, if memory is read with odd number of "1", the parity error is occurred and this is called single bit error detection.

PBSRAM (Pipelined Burst SRAM)

For Socket 7 CPU, one burst data read requires four QWord (Quad-word, 4x16 = 64 bits). PBSRAM only needs one address decoding time and automatically sends the remaining QWords to CPU according to a predefined sequence. Normally, it is 3-1-1-1, total 6 clocks, which is faster than asynchronous SRAM. PBSRAM is often used on L2 (level 2) cache of Socket 7 CPU. Slot 1 and Socket 370 CPU do not need PBSRAM.

PC100 DIMM

[SDRAM](#) DIMM that supports 100MHz CPU [FSB](#) bus clock.



PC133 DIMM

[SDRAM](#) DIMM that supports 133MHz CPU [FSB](#) bus clock.

PDF Format

A file format for electronic document, PDF format is independent from platform, you can read PDF file under Windows, Unix, Linux, Mac ... with different PDF reader. You can also read PDF file by web browser such as IE and Netscape, note that you need to install PDF plug-in first (Included in Acrobat Reader).

PnP (Plug and Play)

The PnP specification suggests a standard register interface for both BIOS and operating system (such as Windows 95). These registers are used by BIOS and operating system to configure system resource and prevent any conflicts. The IRQ/DMA/Memory will be automatically allocated by PnP BIOS or operating system. Currently, almost all the PCI cards and most ISA cards are already PnP compliant.

POST (Power-On Self Test)

The BIOS self test procedure after power-on, sometimes, it is the first or the second screen shown on your monitor during system boot.

RDRAM (Rambus DRAM)

Rambus is a memory technology that uses large burst mode data transfer. Theoretically, the data transfer should be high than [SDRAM](#). RDRAM is cascaded in channel operation. For Intel 820, only one RDRAM channel is supported, 16-bit data per channel, and this channel may have maximum 32 RDRAM devices, no matter how many [RIMM](#) sockets.

RIMM

184-pin memory module that supports [RDRAM](#) memory technology. A RIMM memory module may contain up to maximum of 16 RDRAM devices.

SDRAM (Synchronous DRAM)

SDRAM is one of the DRAM technologies that allows DRAM to use the same clock as the CPU host bus ([EDO](#) and FPM are asynchronous and do not have clock signal). It is similar as [PBSRAM](#) to use burst mode transfer. SDRAM comes in 64-bit 168-pin [DIMM](#) and operates at 3.3V. AOpen is the first company to support dual-SDRAM DIMMs onboard (AP5V), from Q1 1996

SIMM (Single In Line Memory Module)

SIMM socket is only 72-pin, and is only single side. The golden finger signals on each side of PCB are identical. That is why it was called Single In Line. SIMM is made by FPM or [EDO](#) DRAM and supports 32-bit data. SIMM had been phased out on current motherboard design.

SMBus (System Management Bus)

SMBus is also called I2C bus. It is a two-wire bus developed for component communication (especially for semiconductor IC). For example, set clock of clock generator for jumper-less motherboard. The data transfer rate of SMBus is only 100Kbit/s, it allows one host to communicate with CPU and many masters and slaves to send/receive message.

SPD (Serial Presence Detect)

SPD is a small ROM or [EEPROM](#) device resided on the [DIMM](#) or [RIMM](#). SPD stores memory module information such as DRAM timing and chip parameters. SPD can be used by [BIOS](#) to decide best timing for this DIMM or RIMM.

Ultra DMA/33

Unlike traditional PIO/DMA mode, which only uses the rising edge of IDE command signal to transfer data. UDMA/33 uses both rising edge and falling edge, the data transfer rate is double of the PIO mode 4 or DMA mode 2.

16.6MB/s x2 = 33MB/s

USB (Universal Serial Bus)

USB is a 4-pin serial peripheral bus that is capable of cascading low/medium speed peripherals (less than 10Mbit/s) such as keyboard, mouse, joystick, scanner, printer and modem. With USB, the traditional complex cables from back panel of your PC can be eliminated.



ZIP file

A compressed file format to reduce file size. To unzip file, run shareware PKUNZIP (<http://www.pkware.com/>) for DOS and other operating system or WINZIP (<http://www.winzip.com/>) for windows environment.



Troubleshooting

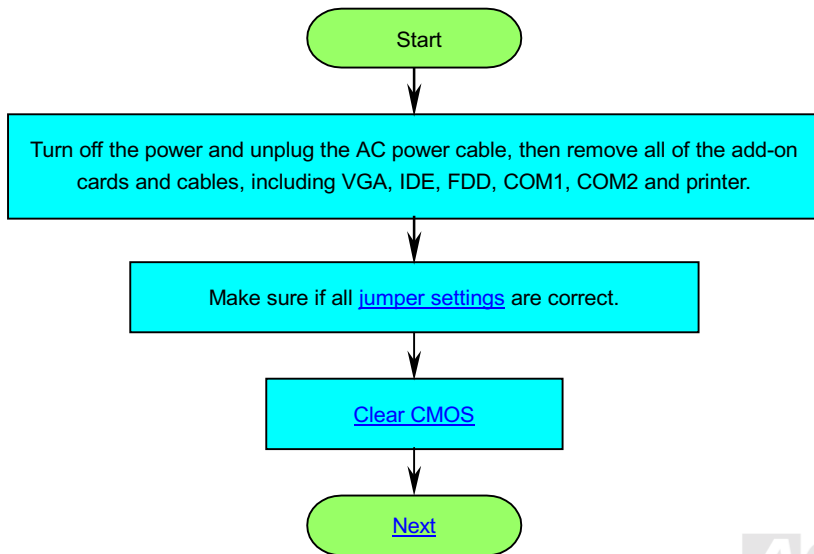

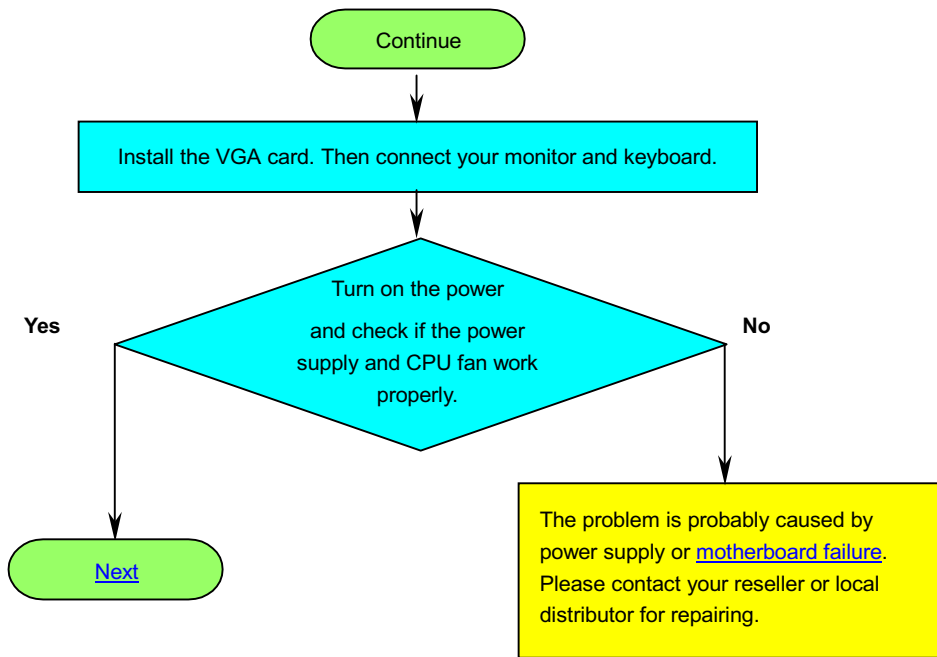

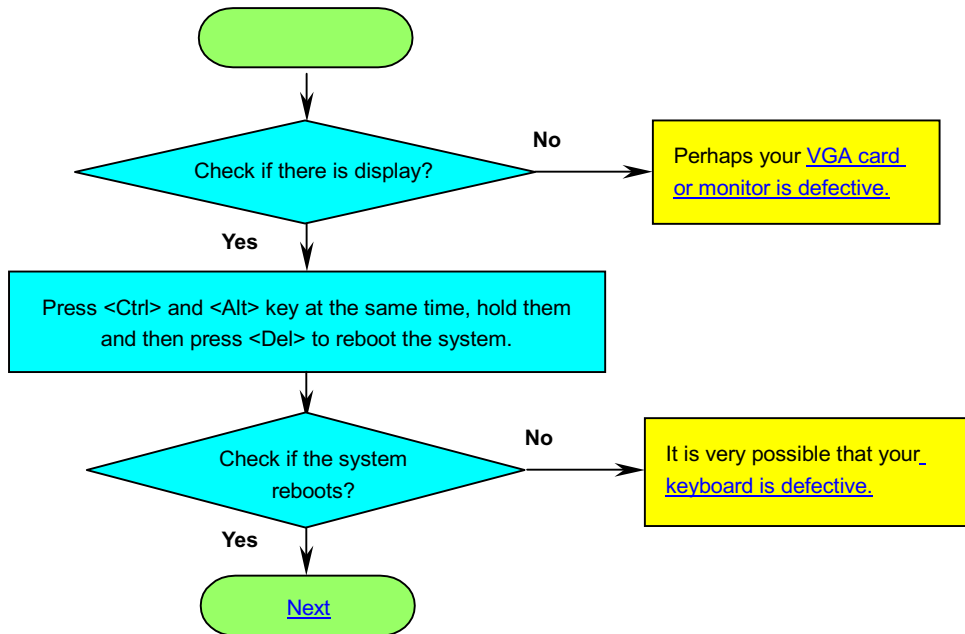

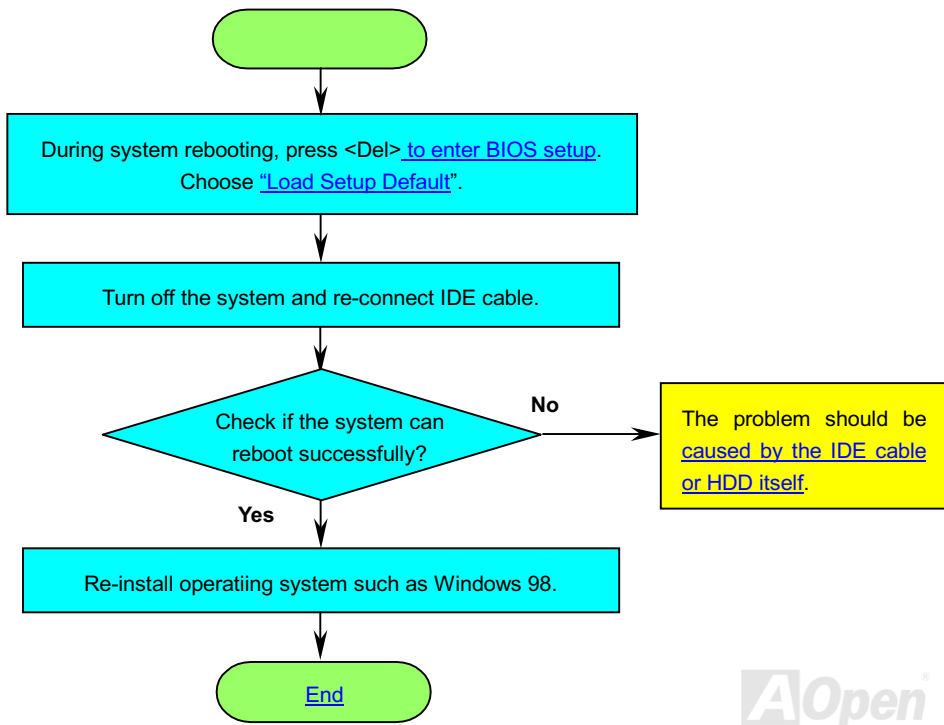



Technical Support

Dear Customer,

Thanks for choosing AOpen products. To provide the best and fastest service to our customer is our first priority. However, we receive numerous emails and phone-calls worldwide everyday, it is very hard for us to serve everyone on time. We recommend you follow the procedures below and seek help before contact us. With your help, we can then continue to provide the best quality service to more customers.

Thanks very much for your understanding!

AOpen Technical Supporting Team

1

Online Manual: Please check the manual carefully and make sure the jumper settings and installation procedure are correct.

<http://www.aopen.com.tw/tech/download/manual/default.htm>

2

Test Report: We recommend to choose board/card/device from the compatibility test reports for assembling your PC.

<http://www.aopen.com.tw/tech/report/default.htm>

3

FAQ: The latest FAQ (Frequently Asked Questions) may contain a solution to your problem.

<http://www.aopen.com.tw/tech/faq/default.htm>

4

Download Software: Check out this table to get the latest updated BIOS/utility and drivers.

<http://www.aopen.com.tw/tech/download/default.htm>

5

News Group: Your problem probably had been answered by our support engineer or professional users on the news group.

<http://www.aopen.com.tw/tech/newsgrp/default.htm>

6

Contact Distributors/Resellers: We sell our products through resellers and integrators. They should know your system configuration very well and should be able to solve your problem more efficiently than us. After all, their attitude of service is an important reference for you if next time you want to buy something else from them.

7

Contact Us: Please prepare detail system configuration and error symptom before contacting us. The **part number**, **serial number** and **BIOS version** are also very helpful.

Part Number and Serial Number

The Part Number and Serial number are printed on bar code label. You can find this bar code label on the outside packing, on ISA/CPU slot or on component side of PCB. For example:



P/N: 91.88110.201 is part number, **S/N: 91949378KN73** is serial number.

Model name and BIOS version

Model name and BIOS version can be found on upper left corner of first boot screen ([POST](#) screen).

For example:

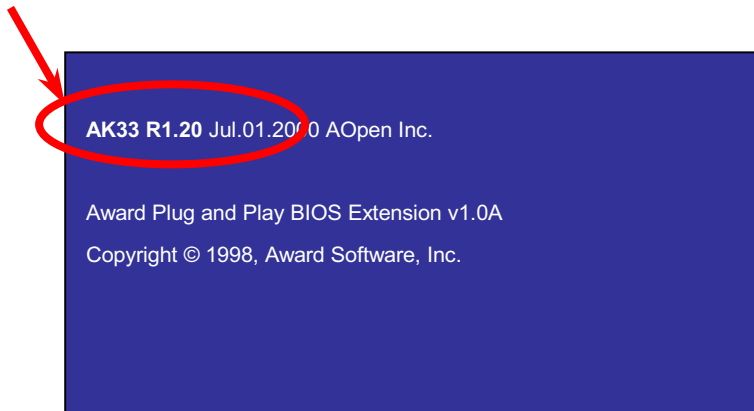

AK33 is model name of motherboard, **R1.20** is BIOS version.

Web: <http://www.aopen.com>

Email : Send us email by going through the contact form below.

English <http://www.aopen.com.tw/tech/contact/techusa.htm>

Japanese <http://aojp.aopen.com.tw/tech/contact/techjp.htm>

Chinese <http://w3.aopen.com.tw/tech/contact/techtw.htm>

German <http://www.aopencom.de/tech/contact/techde.htm>

Simplified Chinese <http://www.aopen.com.cn/tech/contact/techcn.htm>

TEL:

USA	650-827-9688
Netherlands	+31 73-645-9516
China	(86) 755-375-3013
Taiwan	(886) 2-2696-1333
Germany	+49 (0) 2102-157-700