

Caution!

When installing a CPU heatsink and cooling fan make sure that you DO NOT scratch the motherboard or any of the surface-mount resistors with the clip of the cooling fan. If the clip of the cooling fan scrapes across the mainboard, you may cause serious damage to both the mainboard and the processor.

On most mainboards, there are small surface-mount resistors near the processor socket, which may be damaged if the cooling fan is carelessly installed.

Avoid using cooling fans with sharp edges on the fan casing and the clips. Also, install the cooling fan in a well-lit work area so that you can clearly see the mainboard and processor socket.

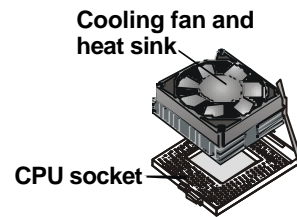

Important Information

Copyright

This publication, including all photographs, illustrations and software, is protected under international copyright laws, with all rights reserved. Neither this manual, nor any of the material contained herein, may be reproduced without the express written consent of the manufacturer.

Version 2.0

Disclaimer

The information in this document is subject to change without notice. The manufacturer makes no representations or warranties with respect to the contents hereof and specifically disclaims any implied warranties of merchantability or fitness for any particular purpose. Further, the manufacturer reserves the right to revise this publication and to make changes from time to time in the content hereof without obligation of the manufacturer to notify any person of such revision or changes.

Trademark Recognition

Microsoft, MS-DOS and Windows are registered trademarks of Microsoft Corp.

MMX, Pentium, Pentium-II, Pentium-III, Celeron are registered trademarks of Intel Corporation.

Other product names used in this manual are the properties of their respective owners and are acknowledged.

Federal Communications Commission (FCC)

This equipment has been tested and found to comply with the limits for a Class B digital device, pursuant to Part 15 of the FCC Rules. These limits are designed to provide reasonable protection against harmful interference in a residential installation. This equipment generates, uses, and can radiate radio frequency energy and, if not installed and used in accordance with the instructions, may cause harmful interference to radio communications. However, there is no guarantee that interference will not occur in a particular installation. If this equipment does cause harmful interference to radio or television reception, which can be determined by turning the equipment off and on, the user is encouraged to try to correct the interference by one or more of the following measures:

- Reorient or relocate the receiving antenna.
- Increase the separation between the equipment and the receiver.
- Connect the equipment onto an outlet on a circuit different from that to which the receiver is connected.
- Consult the dealer or an experienced radio/TV technician for help.

Shielded interconnect cables and a shielded AC power cable must be employed with this equipment to ensure compliance with the pertinent RF emission limits governing this device. Changes or modifications not expressly approved by the system's manufacturer could void the user's authority to operate the equipment.

Declaration of Conformity

This device complies with part 15 of the FCC rules. Operation is subject to the following conditions:

- This device may not cause harmful interference, and
- This device must accept any interference received, including interference that may cause undesired operation.

Canadian Department of Communications

This class B digital apparatus meets all requirements of the Canadian Interference-causing Equipment Regulations.

Cet appareil numérique de la classe B respecte toutes les exigences du Règlement sur le matériel brouilleur du Canada.

About the Manual

The manual consists of the following chapters:

Introduction

Use the **Introduction** Chapter to learn about the features of the mainboard, and verify the checklist of items that are shipped with the package.

Installation

Use the **Installation** Chapter to learn how to install the mainboard and get your system up and running.

Setup

Use the **Setup** Chapter to configure the mainboard for optimum performance.

Software

Use the **Software** Chapter to learn how to install the software drivers and support programs that are provided with this mainboard.

Contents

Important Information	i
<i>Copyright</i>	<i>i</i>
<i>Disclaimer</i>	<i>i</i>
<i>Trademark Recognition</i>	<i>ii</i>
<i>Federal Communications Commission (FCC)</i>	<i>ii</i>
<i>Declaration of Conformity</i>	<i>iii</i>
<i>Canadian Department of Communications</i>	<i>iii</i>
About the Manual	iv
CHAPTER 1: INTRODUCTION	1
Welcome	1
Checklist	2
Recommendations	3
Features	4
CHAPTER 2: INSTALLATION	7
Quick Installation Table	7
Before You Begin	8
<i>Static Electricity</i>	8
<i>Choosing a Case</i>	9
Preparing the Mainboard	10
<i>Mainboard Guide</i>	10
<i>I/O Ports Side View</i>	12
<i>How to Set Jumpers</i>	13
<i>Check the Jumper Settings</i>	14
<i>Installing the Mainboard in a Case</i>	17
<i>Connecting Internal Components</i>	18
Installing Other Hardware	20
<i>Installing the Processor</i>	20
<i>Install the Memory Modules</i>	22
<i>Installing a Hard Disk Drive and CD-ROM</i>	24
<i>Installing a Floppy Diskette Drive</i>	27
<i>Using the Expansion Slots</i>	28
<i>Other Options</i>	30

<i>Making External Connections</i>	32
<i>External Connector Color Coding</i>	33
CHAPTER 3: SETUP	35
About the Setup Utility	35
<i>Entering the Setup Utility</i>	36
<i>BIOS Navigation Keys</i>	37
<i>Using BIOS</i>	38
<i>How to Flash a New BIOS</i>	39
<i>Standard CMOS Features Option</i>	40
<i>Advanced BIOS Features Setup Option</i>	43
<i>Advanced Chipset Features Option</i>	47
<i>Integrated Peripherals Option</i>	51
<i>Power Management Setup Option</i>	54
<i>PnP/PCI Configuration Option</i>	60
<i>PC Health Status Option</i>	62
<i>Frequency Control Option</i>	63
<i>Load Fail-Safe Defaults Option</i>	64
<i>Load Optimized Defaults Option</i>	64
<i>Set Supervisor and User Passwords</i>	65
<i>Save & Exit Setup Option</i>	66
<i>Exit Without Saving Option</i>	66
CHAPTER 4: SOFTWARE	67
About the Software	67
Folders for this Mainboard	67
Auto-installing under Windows 98	68
Utility Folder Installation Notes	72
Mainboard (K7VZM) Installation Notes	73
<i>Audio Software</i>	73
<i>IDE Software</i>	73
<i>LAN Software</i>	74
<i>Monitor Software</i>	74
APPENDIX: JUMPER SETTING REFERENCE	75
<i>Jumper Setting Quick Reference</i>	75

Chapter 1: Introduction

Welcome

Congratulations on purchasing the K7VZM mainboard. The K7VZM mainboard is a Micro ATX mainboard that uses a 4-layer printed circuit board and measures 244 mm x 220 mm. The mainboard has a Socket 462 to accommodate AMD Athlon (K7) processors that support frontside bus (FSB) speeds up to 200/266 MHz. The K7VZM is installed with the VIA VT8363/VT8363A North Bridge (NB) and T82C686A/VT82C686B South Bridge (SB) chipset and built-in 3D sound that features the AC 97 audio codec.

The mainboard delivers high-level performance with a 4xAGP (Accelerated Graphics Port) slot and two PCI Bus Master Ultra DMA (UDMA) ports that support up to four ATAPI (AT Attachment Packet Interface) devices. The PCI IDE also supports PIO Mode 3 and 4, UDMA33/66/100 IDE, and an ATAPI CD-ROM.

The mainboard accommodates PC 100/133 SDRAM (Synchronous DRAM) or VCM (Virtual Channel Memory) up to 1 GB using two 3.3V unbuffered DIMM modules.

Other features include a built-in PCI 3D sound system that supports the AC 97 audio codec and a built-in LAN chip. The mainboard has a full set of I/O ports, such as dual channel PCI EIDE interfaces, a floppy controller, two FIFO serial port connectors, an EPP/ECP-capable bi-directional parallel port connector, a dual USB (Universal Serial Bus) connector, and PS/2 keyboard and mouse connectors.

One AGP slot, two PCI local bus slots and an audio modem riser (AMR) slot provide expandability for add-on peripheral cards.

This chapter contains the following information:

- Checklist** comprises a list of the standard and optional components that are shipped with this mainboard
- Recommendations** lists some Do's and Don'ts from the manufacturer to help ensure reliability and performance from this product
- Features** highlights the functions and components that make this one of the best value mainboards on the market

Checklist

Compare the contents of your mainboard package with the standard checklist below. If any item is missing or appears damaged, please contact the vendor of your mainboard package.

Standard Items

- One K7VZM Mainboard
- One diskette drive ribbon cable and bracket
- One IDE drive ribbon cable and bracket
- This user's manual
- Software support CD-ROM disc

Recommendations

This mainboard automatically determines the CPU clock frequency and system bus frequency for the kind of processor you install. You may be able to change these automatic settings by making changes to the settings in the system Setup Utility. We strongly recommend that you do not overclock the mainboard to run processors or other components faster than their rated speed.

Warning: *Overclocking components can adversely affect the reliability of the system and introduce errors into your system. Overclocking can permanently damage the mainboard by generating excess heat in components that are run beyond the rated limits.*

Components on this mainboard can be damaged by discharges of static electricity. Handle the board carefully holding it by the edges. Don't flex or stress the circuit board. Keep the board in its static-proof packing until you are ready to install it. Follow the static guidelines given at the beginning of Chapter 2.

Features

The key features of this mainboard are the wide range of processors that can be installed, and the high level of integration, which includes built-in audio, video, networking, and communications.

High-end Processors

Functioning as a platform for a high-end PC, the K7VZM features a Socket 462 accommodating AMD Athlon processors that support 64/256 KB L2 OnChip cache, a 100/200 MHz or 133/266 MHz host bus/core speed, and a 200/266 MHz frontside bus (FSB).

VIA Chipset

VT8363/VT8363A and VT82C686A/VT82C686B chipsets from VIA are featured on this board. These chipsets are designed for high-end desktops and workstations and provide ATA-66/100, 4xAGP, and DRAM support.

The VT82C686A I/O chip makes a direct connection between the graphics system, the IDE controller, and the PCI bus. It uses accelerated hub architecture to effectively double the bandwidth between these components enabling more lifelike audio and video. The VT82C686A I/O chip includes an integrated audio codec controller (AC 97) that lets the processor more effectively decode sound generated by the integrated audio system or the integrated fax/modem.

Note: *The K7VZM supports two VIA South Bridge chipsets—the VT82C686A and VT82C686B. The VT82C686A supports UDMA33/66; the VT82C686B supports up to UDMA100.*

Inexpensive Memory

The board has two DIMM sockets for the installation of 168-pin, 3.3V non-buffered DIMM memory modules. The DIMM memory modules use SDRAM memory chips. The K7VZM board supports a memory bus of 100/133 MHz.

If your processor operates over a 133 MHz system bus, you can install PC133 or PC100 memory that operates over a 133 or 100 MHz bus. If your processor operates over a 100 MHz system bus, you can install memory that operates over a 133 MHz, 100 MHz, or 66MHz bus. If your processor operates over a 66 MHz, you can only install memory chips that operate at 66 MHz or 100 MHz.

Each installed memory module can be populated with from 32 MB to 512 MB of memory; a maximum of 1 GB memory can be installed. You must install at least one module, but it makes no difference which slot you use to install the module.

4xAGP Graphics Adapter Slot

The mainboard includes an 4xAGP slot that provides four times the bandwidth of the original AGP specification. AGP technology provides a direct connection between the graphics sub-system and the processor so that the graphics do not have to compete for processor time with other devices on the PCI bus. The AGP design allows the graphics controller to use part of the main memory when it needs it, for example, to handle the very large texture maps required by virtual reality and 3D video games and applications.

AC 97 Audio codec

The AC 97 Audio codec is compliant with the AC 97 2.1 specification, and supports 18-bit ADC (Analog Digital Converter) and DAC (Digital Analog Converter) resolution as well as 18-bit stereo full-duplex codec with independent and variable sampling rates. Further features include support for four analog line-level stereo inputs.

LAN Chip

The RTL8139C LAN chip is an integrated chip and transceiver capable of operating at 10/100 Mbps. This PCI Revision 2.2-compliant chip supports PCI target fast back-to-back transaction, Vital Product Data (VPD), and ACPI/PCI power management.

Expansion Options

The K7VZM mainboard is pre-installed with features such as audio that normally require add-in cards. The two 32-bit PCI slots and the AMR slot provide plenty of expansion potential.

Integrated I/O

The mainboard has a full set of I/O ports and connectors. The I/O template on the backplane includes two PS/2 ports for mouse and keyboard, two serial ports, one parallel port, one MIDI/game port, two USB ports, and audio jacks for microphone, line-in and line-out. The board includes two PCI IDE channels and a floppy disk drive interface.

Keyboard Power on Feature

Using the system BIOS setup program, you can configure the system to turn on using a keyboard-typed password. A green keyboard is not required.

Programmable Firmware

The mainboard includes Award BIOS that allows BIOS setting of CPU parameters. This fully programmable firmware enhances the system features and allows users to set such items as power management, CPU and memory timing, and LAN and modem wake-up alarms. The firmware can also be used to set parameters for different processor clock speeds so that you don't need to change mainboard jumpers and switches.

This concludes Chapter 1. The next chapter covers installing and building a working system.

Chapter 2: Installation

Quick Installation Table

This chapter explains how to successfully install the mainboard into a computer case and build a working system. The installation procedure is as follows:

Before you Begin	Provides advice on choosing a case, avoiding static electricity damage, and setting jumpers.
Preparing the Mainboard	Provides a guide to the mainboard and I/O port locations, full details on the jumper settings, and advice on installing the mainboard in the system case.
Installing Other Hardware	Provides guidance on installing essential hardware: processor, memory, hard disk drive, CD-ROM, floppy disk drive, and expansion cards.
Making External Connections	Provides advice on using the external I/O ports to install peripheral devices such as a keyboard, a monitor, a mouse, a printer, and loudspeakers.
Appendix	The Appendix provides a quick reference for the jumper settings on this mainboard.

Before You Begin

Before you begin to install your mainboard, take care not to damage the product from static electricity. Ensure too that you are installing the mainboard into a suitable case.

Static Electricity

In adverse conditions, static electricity can accumulate and discharge through the integrated circuits and silicon chips on this product. These circuits and chips are sensitive and can be permanently damaged by static discharge.

- If possible, wear a grounding wrist strap clipped to a safely grounded device during the installation.
- If you don't have a wrist strap, discharge any static by touching the metal case of a safely grounded device before beginning the installation.
- Leave all components inside their static-proof bags until they are required for the installation procedure.
- Handle all circuit boards and electronic components carefully. Hold boards by the edges only. Do not flex or stress circuit boards.

Choosing a Case

The mainboard complies with the specifications for the Micro ATX system case. Some features on the mainboard are implemented by cabling connectors on the mainboard to indicators and switches on the system case. Ensure that your case supports all the features required. The mainboard can support one or two floppy diskette drives and four enhanced IDE drives. Ensure that your case has sufficient power and space for all the drives that you intend to install.

The mainboard has a set of I/O ports on the rear edge. Ensure that your case has an I/O template that supports the I/O ports and expansion slots.

Preparing the Mainboard

Mainboard Guide

Use the following illustration and key to identify the components on your mainboard.

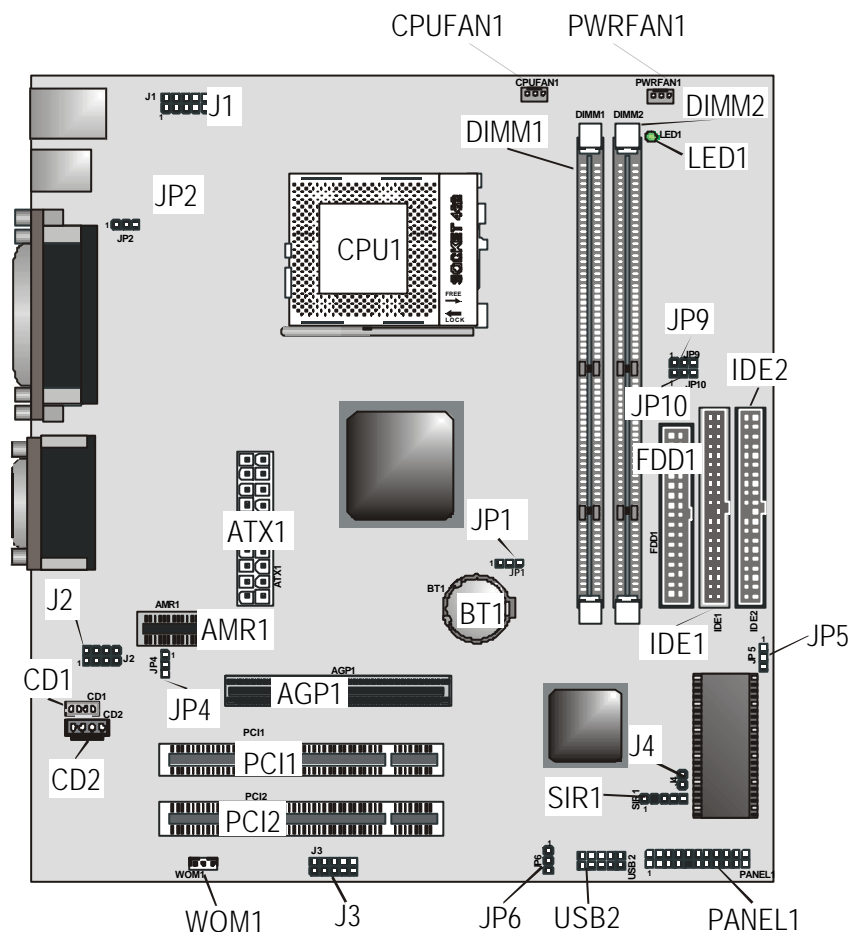

Key to Mainboard Components

Component	Description
J1	Extra IR/KB/mouse header
CPUFAN1	Power connector for CPU cooling fan
PWRFAN1	Power connector for power source cooling fan
CPU1	462-pin ZIF socket for AMD Athlon processor
DIMM1~2	Two 168-pin SDRAM memory module slots
LED1	3VSB LED for SDRAM
J2	Extra MIC/Line out header
ATX1	ATX power supply connection
AMR1	Audio modem riser (AMR) slot
AGP	132-pin 4X accelerated graphics port (AGP) slot
BT1	3 volt battery for realtime clock
FDD1	Connector for floppy disk drives
IDE1, 2	Primary and secondary IDE channels
J4	Dual color LED header
SIR1	IrDA device header
CD1	Primary ATAPI device header
CD2	Secondary ATAPI device header
PCI1, 2	Two 120-pin PCI slots
WOM1	Wake On Modem (WOM) connector
J3	LAN header
USB2	USB port 3-4
PANEL1	Front panel connection
JP2	USB port 1-2 wake-up jumper
JP4	AC 97 codec selector jumper
JP1	Clear CMOS jumper
JP5	Write protect BIOS jumper
JP6	USB port 3-4 wake-up jumper
JP9/JP10	FSB 100/133 select jumpers (only supported on mainboards with the VIA VT8363A NB chipset)

Note: *The green indicator LED1 turns on if your system is still powered, at which time memory modules cannot be installed or uninstalled.*

The dual color LED header J4 can be plugged into LEDs to indicate the following conditions: software power down, suspend to RAM, suspend to disk, and soft off.

I/O Ports Side View

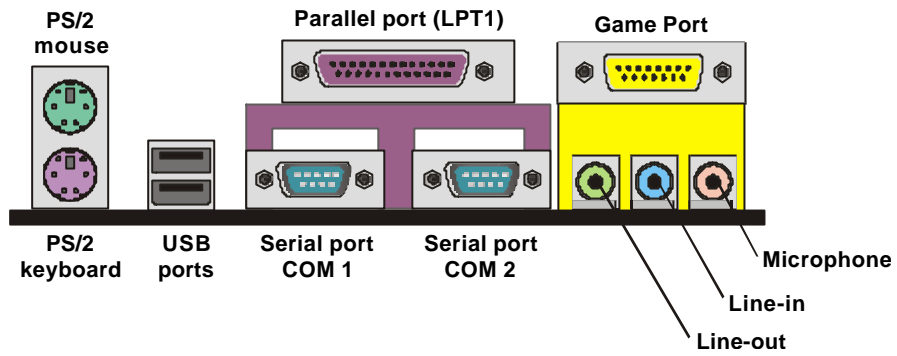

Key to I/O Ports

Component	Description
PS/2 mouse	PS/2 port for pointing device (upper port)
PS/2 keyboard	PS/2 port for keyboard (lower port)
USB ports	Two stacked Universal Serial Bus ports
LPT1	External parallel port
COM1	External serial port COM 1
COM2	External serial port COM 2
Game port	External MIDI/game port
Audio ports	Audio jacks for (from left to right) line-out, line-in, microphone

How to Set Jumpers

A jumper consists of two or more pins mounted on the mainboard. Some jumpers might be arranged in a series with each pair of pins numbered differently. Jumpers are used to change the electronic circuits on the mainboard. When a jumper cap (or shunt) is placed on two jumper pins, the pins are **SHORT**. If the jumper cap is removed (or placed on just a single pin), the pins are **OPEN**.

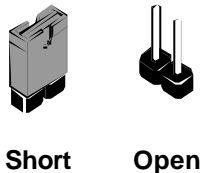

This illustration shows a 2-pin jumper. When the jumper cap is placed on both pins, the jumper is **SHORT**. If you remove the jumper cap, or place the jumper cap on just one pin, the jumper is **OPEN**.

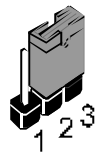

This illustration shows a 3-pin jumper. The jumper cap is placed on pins 2 and 3, so this jumper setting is **SHORT PINS 2-3**.

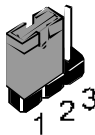

This illustration shows the same 3-pin jumper. The jumper cap is placed on pins 1 and 2, so this jumper setting is **SHORT PINS 1-2**.

In this manual, all the jumper illustrations clearly show the pin numbers. When you are setting the jumpers, make sure that the jumper caps are placed on the correct pins to select the function or feature that you want to enable or disable.

Check the Jumper Settings

Check the mainboard jumpers to ensure that the board is configured correctly.

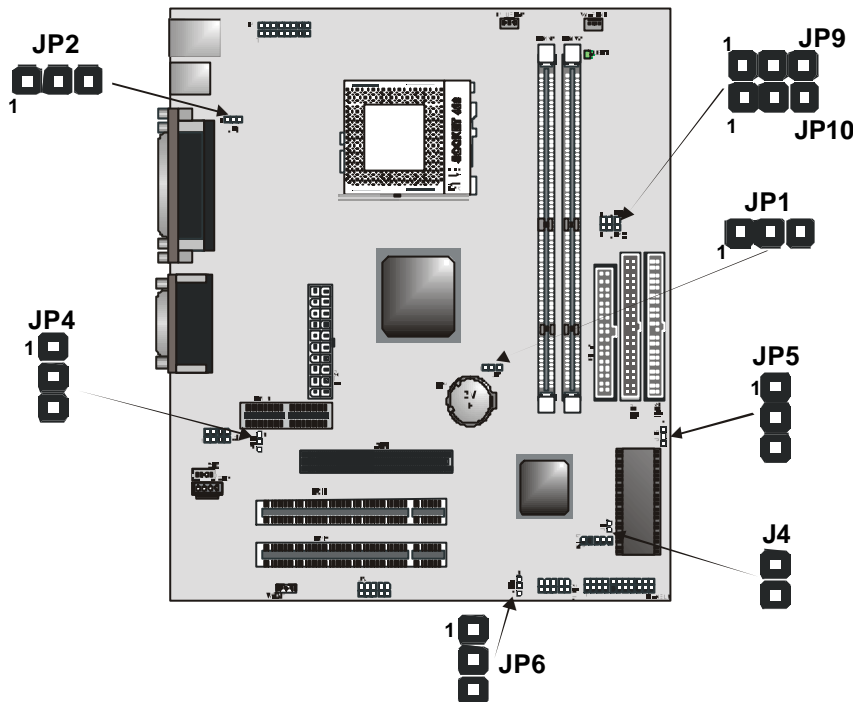

JP1: Clear CMOS jumper

Use this jumper to erase the system setup settings that are stored in CMOS memory. You might need to erase this data if incorrect settings are preventing your system from operating. To clear the CMOS memory, turn off the system, disconnect the power cable from the mainboard, and short the appropriate pins for a few seconds.

Function	Jumper Setting
Normal operation	Short pins 1-2
Clear CMOS	Short pins 2-3

The diagram shows the JP1 jumper with three pins labeled 1, 2, and 3. A small component is shown bridging pins 1 and 2, representing the 'Normal operation' setting.

JP2: USB port 1-2 wake-up jumper

Use this jumper to enable device activity on USB ports 1-2 to power on the computer.

Function	Jumper Setting
Disable	Short pins 1-2
Enable	Short pins 2-3



JP4: Codec selector jumper

Use this jumper to select the onboard AC 97 audio codec or Audio Modem Riser (AMR) slot.

Function	Jumper Setting
Use on board codec	Short pins 1-2
Use AMR slot codec	Short pins 2-3



JP5: BIOS write protect jumper

Use this jumper to make the BIOS read-only.

Function	Jumper Setting
Disable	Short pins 1-2
Enable	Short pins 2-3



JP6: USB port 3-4 wake-up jumper

Use this jumper to enable device activity on USB ports 3-4 to power on the computer.

Function	Jumper Setting
Disable	Short pins 1-2
Enable	Short pins 2-3



JP7: Onboard codec mode

Use this jumper to define the onboard codec mode function.

Function	Jumper Setting
Master	Open
Slave	Short



JP9/10: FSB 100/133 select jumpers

Note: JP9 and JP10 are only supported by the VIA VT8363A North Bridge chipset

Use these jumpers to select the FSB speed.

Function	Jumper Setting
100 MHz FSB	Short pins 2-3 of JP9 Short pins 1-2 of JP10
133 MHz FSB	Short pins 1-2 of JP9 Short pins 2-3 of JP10

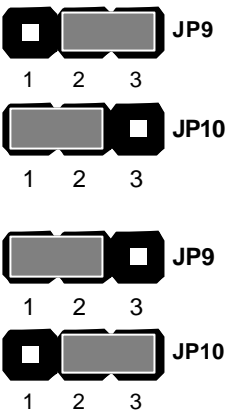

Installing the Mainboard in a Case

Most system cases have mounting brackets installed in the case, which correspond to the holes in the mainboard. Place the mainboard over the mounting brackets and secure the mainboard into the mounting brackets with screws.

Most cases have a choice of I/O templates in the rear panel. Make sure that the I/O template in the case matches the I/O ports installed on the rear edge of the mainboard.

This illustration shows a mainboard installed in a standard desktop case.

Note: Do not over-tighten the screws as this can stress the mainboard.

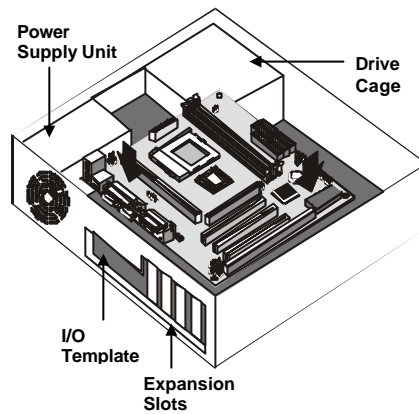

This illustration shows a mainboard installed in a tower-type case.

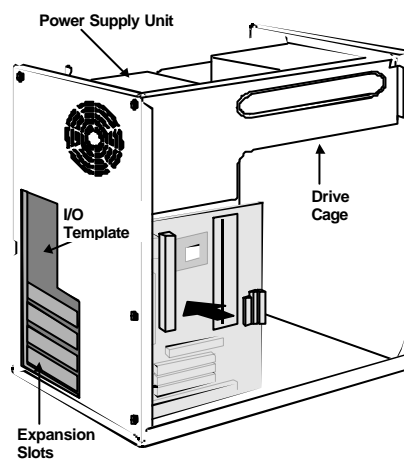

Connecting Internal Components

After you have installed the mainboard into the system case, connect the power cable from the case power supply unit to the mainboard power connector ATX1.

Your case and CPU might have cooling fans attached to provide adequate ventilation to the system. Connect the CPU fan to the 12-volt connector CPUFAN1. Connect the case fan to the 12-volt power supply connector PWRFAN1.

After you have connected the power supply and the cooling fans, connect the case switches and indicators to the PANEL1 connectors.

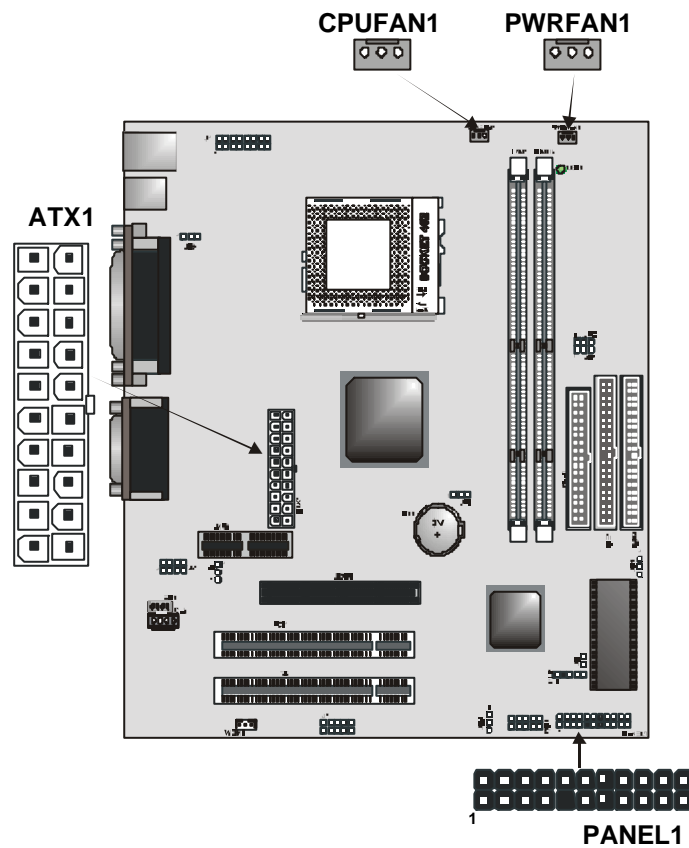

PANEL1 Panel Connector

The mainboard PANEL1 panel connector has a standard set of switch and indicator connectors that are commonly found on ATX system cases. Use the illustration below to make the correct connections to the case switches and indicators.

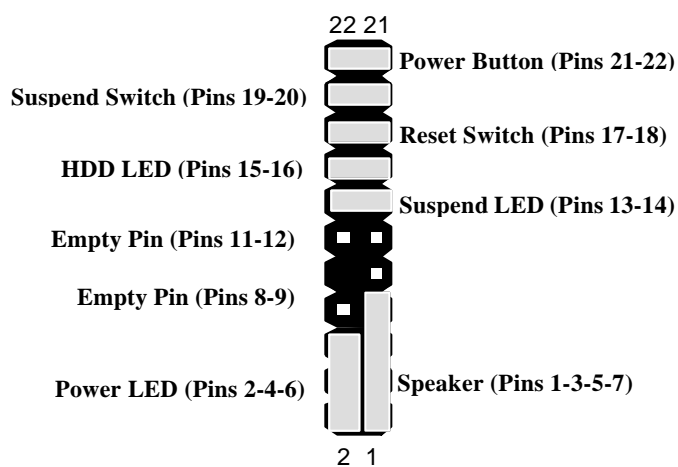

Function	Pins
Speaker	1, 3, 5, 7
Power LED Indicator	+2, 4, 6
Empty Pin	8, 9
Empty Pin	11, 12
Suspend LED Indicator	+13, 14
Hard Disk LED Indicator	+15, 16
Reset Switch	17, 18
Suspend Switch	19, 20
Power Button	21, 22

Note: The plus sign (+) indicates a pin which must be connected to a positive voltage.

Installing Other Hardware

Start installing the essential hardware required to get your system started.

Installing the Processor

This mainboard has a Socket 462 processor socket. To choose a processor, you need to consider the performance requirements of the system and the price of the processor. Performance is based on the processor design, the clock speed and system bus frequency of the processor, and the quantity of internal cache memory and external cache memory. Higher clock speeds and larger amounts of cache memory deliver greater performance.

Installation Procedure

To install a processor on the mainboard follow the steps below.

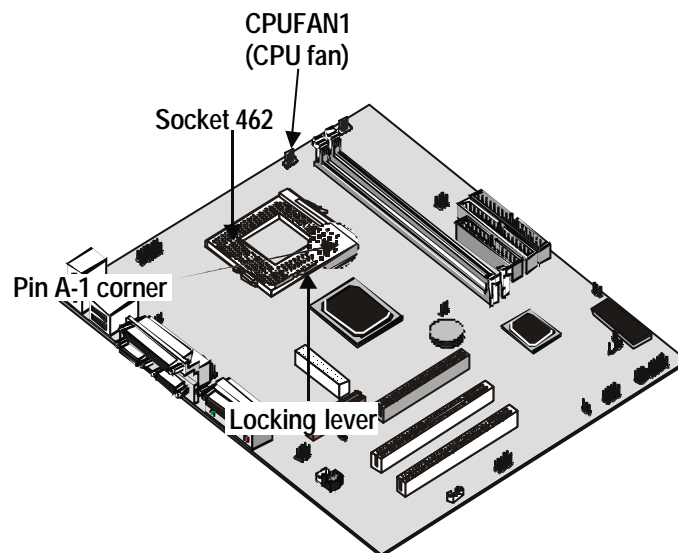

1. On the mainboard, locate the Socket 462 and CPU cooling fan CPUFAN1.

2. On the Socket 462, pull the locking lever away from the socket to unhook it and then raise the locking lever to the upright position.
3. Identify the pin A-1 corner on the Socket 462 and the pin A-1 corner on the processor. The socket pin A-1 corner is adjacent to the handle of the locking lever. The processor pin A-1 corner is beveled.
4. Matching the pin A-1 corners, drop the processor into the socket. No force is required and the processor should seat into the socket easily.
5. Swing the locking lever down and hook it under the latch on the edge of the socket. This locks the processor in place.
6. Locate the power cable on the heatsink/cooling fan assembly that is attached to the top of the processor.
7. Plug the power cable into the CPU cooling CPUFAN1 12V-power supply on the mainboard.

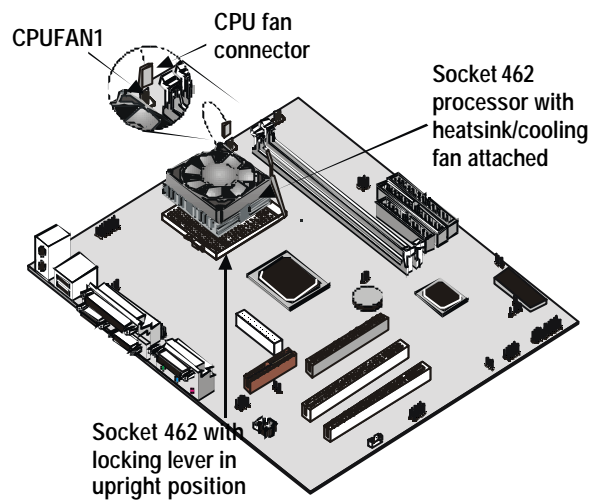

The mainboard must be configured to deliver the correct clock speed and the correct system bus for the kind of processor that you have installed. You can do this by using the BIOS Setup Utility. The first time you start the system, immediately enter the Setup Utility and make the appropriate settings. Usually, you can automatically configure the CPU by using the CPU & BIOS Features page of the Setup Utility. See Chapter 3 for more information.

Install the Memory Modules

For this mainboard, you must use 168-pin 3.3V non-buffered Dual In-line Memory Modules (DIMMs). The memory chips must be standard or registered SDRAM (Synchronous Dynamic Random Access Memory).

The memory bus can run at 100 MHz or 133 MHz. If your processor operates over a 100 MHz system bus, you can install PC100 or PC133 memory modules that operate over a 100 MHz or 133 MHz memory bus. If your processor operates over a 133 MHz system bus, you can only install PC133 memory modules that operate over a 133 MHz memory bus.

Supported Memory Configurations

The following table shows the memory configurations supported:

Technology	Configuration	# of Row Addr Bits	# of Col Addr Bits	# of Bank Addr Bits	Page Size
64 Mbit	8M x 8	12	8	2	4 KB
64 Mbit	4M x 16	12	9	2	2 KB
128 Mbit	32M x 4	12	11	2	16 KB
128 Mbit	16M x 8	12	10	2	8 KB

Note: 32M x 4 128 Mbit is for registered DIMMs only, 4M x 16 64 Mbit support is for unbuffered DIMMs only.

The following table shows the maximum memory for DIMM based platforms:

DRAM Configuration		1 DIMM		2 DIMMs	
		SS	DS	SS	DS
64 Mbit	8M x 8	64 MB	128 MB	128 MB	256 MB
64 Mbit	4M x 16	32 MB	64 MB	64 MB	128 MB
128 Mbit	16M x 8	128 MB	256 MB	256 MB	512 MB
128 Mbit	32M x 4	256 MB	512 MB	512 MB	1024 MB

Installation Procedure

There are two slots for memory modules. You must install at least one module, and it makes no difference which slot you use to install the module. Each module can be installed with 32 MB to 512 MB of memory; total memory capacity is 1 GB.

1. Locate the DIMM slots on the mainboard.

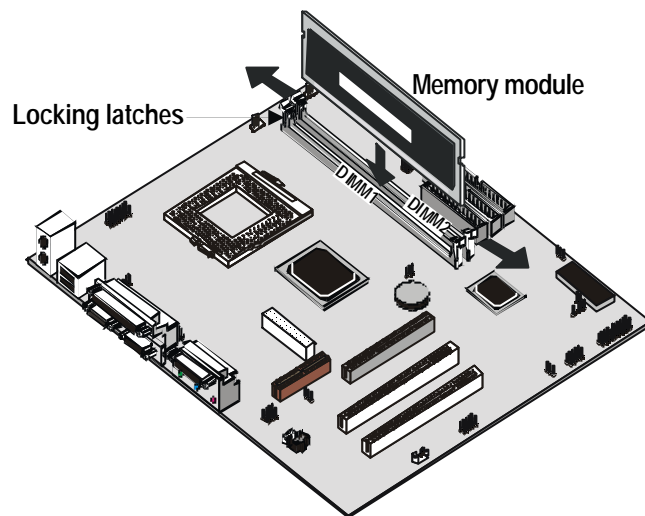

2. The DIMM slots are keyed with notches and the DIMMs are keyed with cutouts so that they can only be installed correctly. Check that the cutouts on the DIMM module edge connector match the notches in the DIMM slot.
3. Push the latches on each side of the DIMM slot down.
4. Install the DIMM module into the slot and press it carefully but firmly down so that it seats correctly. The latches at either side of the slot will be levered upwards and latch on to the edges of the DIMM when it is installed correctly.

Installing a Hard Disk Drive and CD-ROM

This section describes how to install IDE devices such as a hard disk drive and a CD-ROM drive.

Note: Ribbon cable connectors are usually keyed so that they can only be installed correctly on the device connector. If the connector is not keyed, make sure that you match the pin-1 side of the cable connector with the pin-1 side of the device connector. Each connector has the pin-1 side clearly marked. The pin-1 side of each ribbon cable is always marked with a colored stripe on the cable.

About IDE Devices

Your mainboard has a primary IDE channel interface (IDE1) and a secondary IDE interface (IDE2). The mainboard ships with one IDE ribbon cable that supports one or two IDE devices. All IDE devices have jumpers or switches that can be used to set the IDE device as MASTER or SLAVE.

If you install two IDE devices on one cable, you must make sure that one device is set to MASTER and the other device is set to SLAVE. The documentation of your IDE device explains how to do this.

If you want to install more than two IDE devices, obtain a second IDE cable and you can add two more devices to the secondary IDE channel. If there are two devices on the cable, make one MASTER and one SLAVE.

About UDMA

This board supports UltraDMA 66/100. UDMA is a technology that accelerates the performance of devices in the IDE channel. We recommend that you install IDE devices that support UDMA, and use IDE cables that support UDMA.

Note: The K7VZM supports two VIA South Bridge chipsets—the VT82C686A and VT82C686B. The VT82C686A supports UDMA3366; the VT82C686B supports up to UDMA100.

Installing a Hard Disk Drive

1. Install the hard disk drive into the drive cage in your system case.
2. Plug the IDE cable into the primary IDE channel on the mainboard IDE1.
3. Plug one of the connectors on the IDE cable into the IDE connector on the back edge of the hard disk drive. It doesn't matter which connector on the cable you use. Make sure that you have the pin-1 side of the cable matched with the pin-1 side of the connector.
4. Plug a power cable from the case power supply unit into the power connector on the back edge of the hard disk drive.
5. When you first start up your system, go immediately to the Setup Utility and use the IDE Hard Disk Auto Detect feature to configure the IDE devices that you have installed. See Chapter 3 for more information.

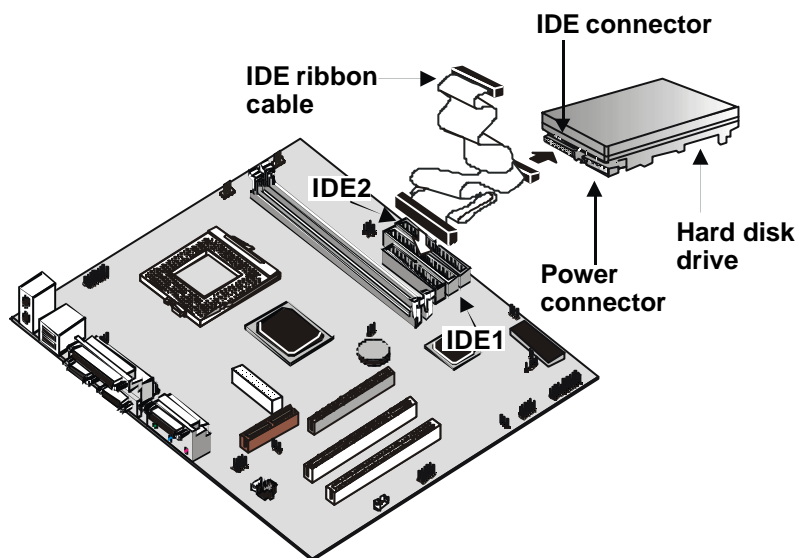

Installing a CD-ROM/DVD Drive

1. Install the CD-ROM/DVD drive into the drive cage in your system case. Plug the IDE cable into the primary IDE channel on the mainboard IDE1.
2. Plug one of the connectors on the IDE cable into the IDE connector on the back edge of the CD-ROM/DVD drive. It doesn't matter which connector on the cable that you use. Make sure that you have the pin-1 side of the cable matched with the pin-1 side of the connector.
3. Plug a power cable from the case power supply unit into the power connector on the back edge of the CD-ROM/DVD drive.
4. Use the audio cable provided with the CD-ROM/DVD drive to connect the audio connector on the rear edge of the CD-ROM/DVD drive to the one of the two audio-in connectors CD1 and CD2 on the mainboard.
5. When you first start up your system, go immediately to the Setup Utility and use the IDE Hard Disk Auto Detect feature to configure the IDE devices that you have installed. See Chapter 3 for more information.

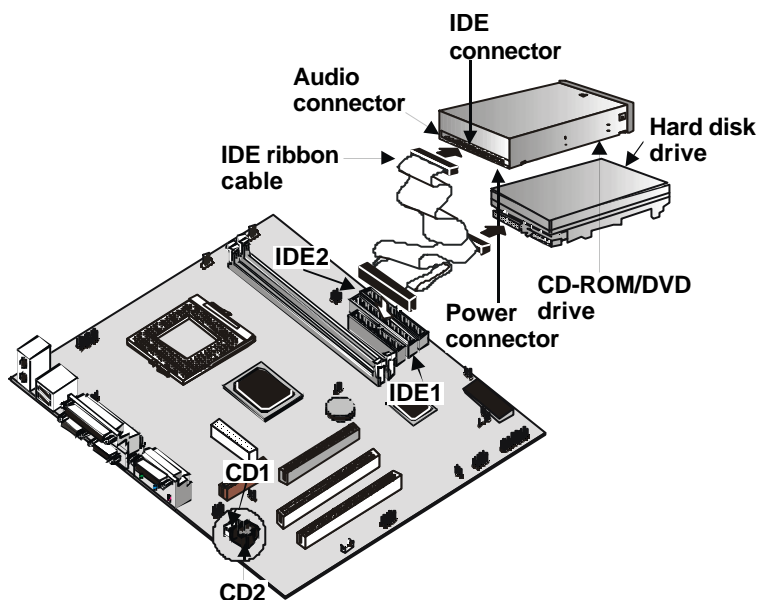

Installing a Floppy Diskette Drive

The mainboard has a floppy diskette drive interface and it ships with a diskette drive ribbon cable that supports one or two floppy diskette drives. You can install a 5.25-inch drive and a 3.5-inch drive with various capacities. The floppy diskette drive cable has one type of connector for a 5.25-inch drive and another type of connector for a 3.5-inch drive

1. Install the floppy diskette drive into the drive cage in your system case. Plug the diskette drive cable into the diskette drive interface on the mainboard FDD1.
2. Plug one of the connectors on the diskette drive cable into the data connector on the back edge of the floppy diskette drive. Make sure that you have the pin-1 side of the cable matched with the pin-1 side of the connector.
3. Plug a power cable from the case power supply unit into the power connector on the back edge of the diskette drive.
4. When you first start up your system, go immediately to the Setup Utility and use the Standard page to configure the floppy diskette drives that you have installed. See Chapter 3 for more information.

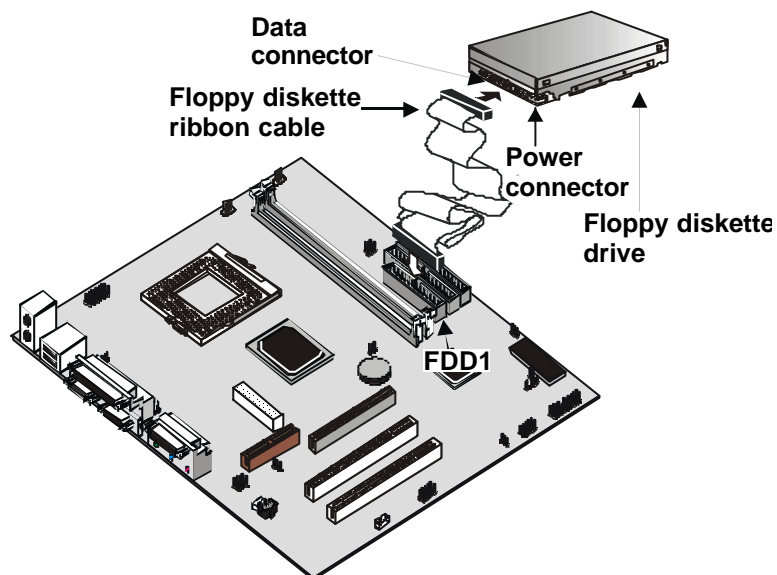

Using the Expansion Slots

This mainboard has two 32-bit PCI expansion slots, one 4xAGP slot, and one Audio Modem Riser (AMR) slot.

PCI Slots: The PCI slots can be used to install expansion cards that have the 32-bit (Peripheral Components Interconnect) PCI interface.

4xAGP Slot: The 4xAGP slot can be used to install a graphics adapter that supports the 4xAGP specification and has the 4xAGP edge connector.

AMR Slot: The Audio Modem Riser (AMR) slot can be used to insert an AMR card.

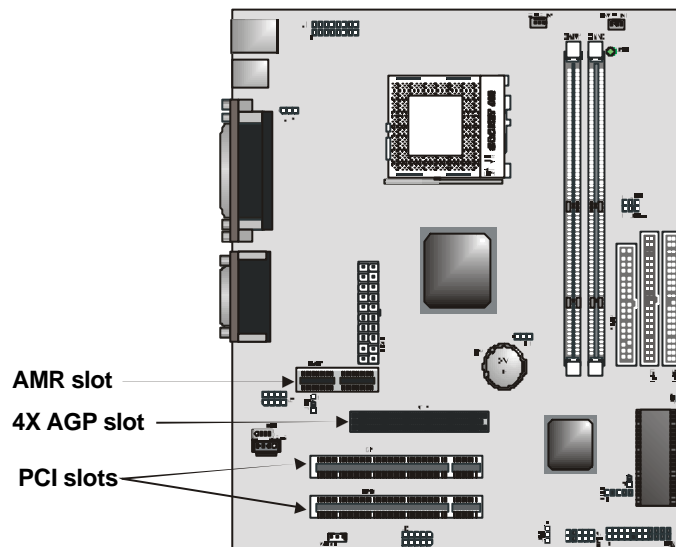

1. Before installing an add-in card, check the documentation for the card carefully. If the card is not Plug and Play, you may have to manually configure the card before installation.
2. Remove the blanking plate from the slot in the system case that corresponds to the expansion slot that you are going to use.
3. Install the edge connector of the add-in card into the expansion slot. Press down quite firmly to ensure that the edge connector is correctly seated in the slot.

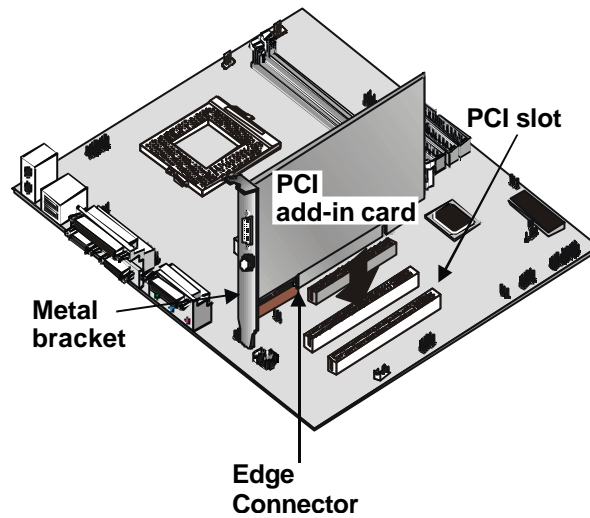

4. Secure the metal bracket of the card in the empty slot in the system case with a screw.
5. For some add-in cards, for example graphics adapters and network adapters, you have to install drivers and software before you can begin using the add-in card.

The following illustration shows how to insert an AMR card:

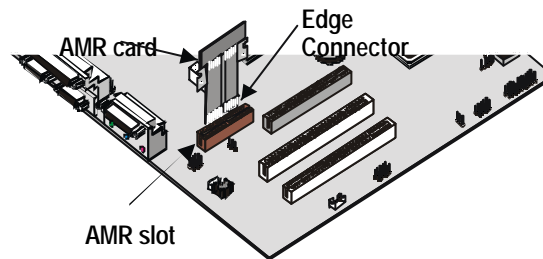

Other Options

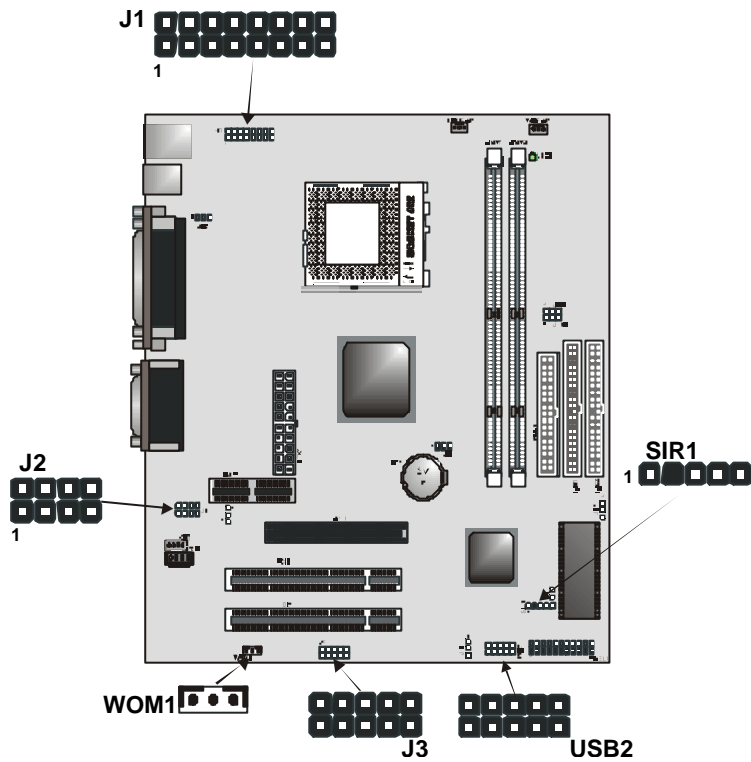

J1: Extra IR/keyboard/mouse header

This motherboard provides a second infrared, keyboard, and mouse header, giving the option of installing second infrared, keyboard, and mouse ports on the front panel. Depending on your case and system configuration this connector may be more suitable as the sole IR port connector.

J2: Extra MIC/Line-out header

This header allows the user to install auxiliary front-oriented microphone and line-out ports for easier access.

WOM1: Wake On Modem connector

If you have installed a modem, you can use the cable provided with the modem to plug into the WOM1 connector on the mainboard. This is the Wake On Modem (WOM) feature. When your system is in a power-saving mode, any modem signal automatically resumes the system. You must enable this item using the Power Management page of the Setup Utility. See Chapter 3 for more information.

J3: LAN header

This header allows the user to attach an RJ-45 cable to access a Local Area Network (LAN). The motherboard is equipped with a LAN chip that supports 10 Mbps or 100 Mbps LAN connections.

USB2: Universal Serial Bus port 3, 4 connector

This motherboard has PS/2 and USB ports installed on the rear edge I/O port array. However, some computer cases have a special module that mounts USB ports on the front side of the case. If you have this kind of case, you can use the auxiliary USB connector USB2 to connect the front-mounted ports to the motherboard. You can use both the front and rear-mounted USB ports at the same time.

J4: Dual color LED header

This header allows the user to install red and green LED indicators to indicate when the computer is in Suspend to RAM (STR) or normal. Although the values are not predefined, red usually indicates STR and green indicates normal.

SIR1: Serial infrared port connector

This motherboard can support a Serial Infrared (SIR) data port. Infrared ports allow the wireless exchange of information between your computer and similarly equipped devices such as printers, laptops, Personal Digital Assistants (PDA), and other desktop computers.

Making External Connections

After you have installed the mainboard, make the connections to the external ports.

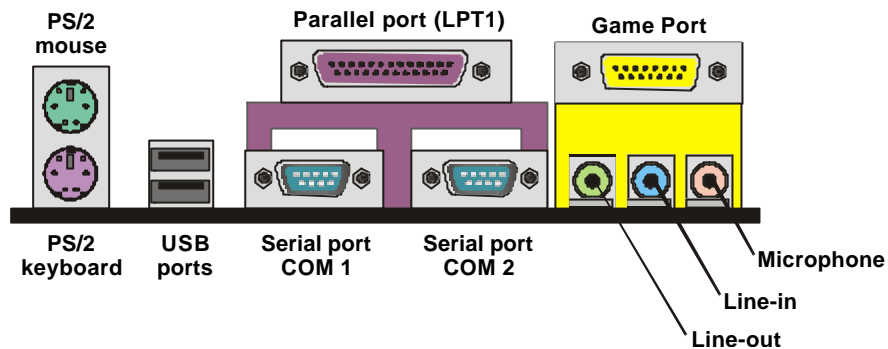

1. The PS/2 mouse port can be used by a PS/2 mouse or pointing device. The PS/2 keyboard port can be used by a PS/2 keyboard.
2. Use the USB ports to connect to USB devices.
3. LPT1 is a parallel port that can be used by printers or other parallel communications devices. The system identifies the parallel port as LPT1.
4. COM1 and COM2 are serial ports that can be used by serial devices such as mice or fax/modems.
5. You can use the game port to connect a joystick or a MIDI device to your system.
6. Three audio ports are provided. The left side jack is for a stereo line-out signal. The middle jack is for a stereo line-in signal. The right side jack is for a microphone.

External Connector Color Coding

To help identify the external connectors, many connectors now use standard colors as shown in the table below.

Connector	Color
Analog VGA	Blue
Audio line in	Light blue
Audio line out	Lime
Digital monitor / flat panel	White
IEEE 1394	Grey
Microphone	Pink
MIDI/Game	Gold
Parallel	Burgundy
PS/2 compatible keyboard	Purple
PS/2 compatible mouse	Green
Serial	Teal or Turquoise
Speaker out/subwoofer	Orange
Right-to-left speaker	Brown
USB	Black
Video out	Yellow
SCSI, network, telephone, modem	None



Note

Chapter 3: Setup

About the Setup Utility

The computer employs the latest Award BIOS CMOS chip with support for Windows Plug and Play. This CMOS chip contains the ROM setup instructions for configuring the mainboard's BIOS. The BIOS (Basic Input and Output System) Setup Utility is a ROM-based configuration utility that displays the system's configuration status and provides you with a tool to set system parameters. These parameters are stored in non-volatile battery-backed-up CMOS RAM that saves this information even when the power is turned off. When the system is turned back on, the system is configured with the values found in CMOS.

Using easy-to-use pull down menus, you can configure such items as:

- Hard drives, diskette drives, and peripherals
- Video display type and display options
- Password protection from unauthorized use
- Power management features

The settings made in the Setup Utility intimately affect how the computer performs. It is important, therefore, first to try to understand all the Setup Utility's options, and second, to make settings appropriate for the way you use the computer. This chapter guides you through the Setup Utility by providing clear explanations for all Setup Utility options.

A standard configuration has already been set in the Setup Utility, so you will very likely have little to worry about for now. However, we recommend that you read this chapter just in case you need to make any changes in the future.

This program should be executed under the following conditions:

- When changing the system configuration
- When a configuration error is detected by the system and you are prompted to make changes to the Setup Utility
- When resetting the system clock
- When setting the CPU clock speed so that it runs either fast or slow
- When redefining the communication ports to prevent any conflicts
- When making changes to the Power Management configuration
- When changing the password or making other changes to the security setup

Normally, running the Setup Utility is needed when the system hardware is not consistent with the information contained in the CMOS RAM, whenever the CMOS RAM has lost power, or the system features need to be changed.

Entering the Setup Utility

When the system is powered on, the BIOS will enter the Power-On Self Test (POST) routines. These routines perform various diagnostic checks; if an error is encountered, the error will be reported in one of two different ways:

1. If the error occurs before the display device is initialized, a series of beeps will be transmitted.
2. If the error occurs after the display device is initialized, the screen will display an error message.

After the POST routines are completed, the following message appears:

Press DEL to enter SETUP

To access the Award BIOS Setup Utility, press the delete key to display the “CMOS Setup Utility” screen:

CMOS Setup Utility – Copyright (C) 1984 – 2000 Award Software

<ul style="list-style-type: none"> ▶ Standard CMOS Features ▶ Advanced BIOS Features ▶ Advanced Chipset Features ▶ Integrated Peripherals ▶ Power Management Setup ▶ PnP/PCI Configurations ▶ PC Health Status 	<ul style="list-style-type: none"> ▶ Frequency/Voltage Control Load Fail-Safe Defaults Load Optimized Defaults Set Supervisor Password Set User Password Save & Exit Setup Exit Without Saving
Esc : Quit F9: Menu in BIOS - - ® - - : Select Item F10 : Save & Exit Setup	
Time, Date, Hard Disk Type . . .	

This screen provides access to the utility's various functions.

BIOS Navigation Keys

Listed below are explanations of the keys displayed at the bottom of the screens:

Key	Function
Esc	Escape key: Exits the current menu
- - ® - -	Cursor keys: Scroll through the items on a menu
+/-/PU/PD	Plus, minus, Page Up and Page Down keys: Modify the selected field's values
F10	F10 key: Saves the current configuration and exits setup
F1	F1 key: Displays a screen that explains all key functions
F5	F5 key: Loads previously saved values to CMOS
F6	F6 key: Loads a minimum configuration for troubleshooting.
F7	F7 key: Loads an optimum set of values for peak performance

Using BIOS

When you start the Setup Utility, the main menu appears. The main menu of the Setup Utility shows a list of the options that are available. A highlight indicates which option is currently selected. You can use the cursor arrow keys to move the highlight to other options. When an option is highlighted, you can execute the option by pressing the enter key.

Some options lead to pop-up dialog boxes that may ask you to verify that you wish to execute that option. You usually answer these dialogs by typing **Y** for yes and **N** for no. Some options may lead to more dialog boxes that ask for more information. Setting passwords have this kind of dialog box.

Enter Password:

Selecting some fields and pressing the enter key displays a list of options for that field. In the Standard CMOS Features screen, selecting "Drive A" and pressing <Enter> displays this screen:

Drive A	
None []
360K , 5.25 in. []
1.2M , 5.25 in. []
720K , 3.5 in. []
1.44M , 3.5 in. []
2.88M , 3.5 in. []

- : Move Enter : Accept ESC: Abort

Select the setting you want with the cursor keys. Press <Enter> to select, or <ESC> to discard changes and return to the previous menu. Alternatively, you can select a field and press the minus, plus, Page Up or Page Down keys to scroll through the options for that field.

Some options (marked with a triangle ►) lead to submenus that enable you to change the values for the option. Use the cursor arrow keys to scroll through the items in the submenu.

How to Flash a New BIOS

You can install updated BIOS for this mainboard that you can download from the manufacturer' s web site. New BIOS may provide support for new peripherals, improvements in performance or fixes for known bugs. Install new BIOS as follows:

1. Some mainboards have a Flash BIOS jumper that protects the current BIOS from being changed or overwritten. If your mainboard has this jumper, change the setting to allow BIOS flashing.
2. Some Setup Utilities have an item called Firmware Write Protect that prevents the BIOS from being overwritten. If your BIOS has this item (check the Advanced BIOS Features Setup page) disable it for the present.
3. Your computer must be running in a real-mode DOS environment, not the DOS window of Windows NT or Windows 95/98. We recommend that you create a new formatted DOS system floppy diskette.
4. Download the Flash Utility and new BIOS file from the manufacturer' s Web site. Copy these files to a system diskette.
5. Turn off your computer and insert the system diskette in your computer' s diskette drive.
6. You might need to run the Setup Utility and change the boot priority items on the Advanced BIOS Features Setup page, to force your computer to boot from the floppy diskette drive first.
7. At the A:\ prompt, after your computer has booted to DOS from the diskette, run the Flash Utility and press <Enter>. You see a screen similar to the following.

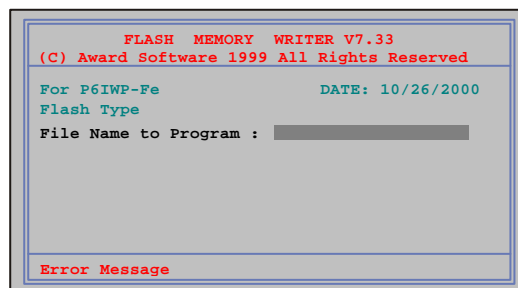

8. In the "File Name to Program" dialog box, type in the file-name of the new BIOS and follow the onscreen directions to flash the new BIOS to the mainboard.
9. When the installation is complete, remove the floppy diskette from the diskette drive and restart your computer. If your mainboard has a Flash BIOS jumper, reset the jumper to protect the newly installed BIOS from being overwritten.

Standard CMOS Features Option

This option displays a table of items defining basic information about your system.

CMOS Setup Utility – Copyright (C) 1984 – 2000 Award Software
Standard CMOS Features

Date (mm:dd:yy)	Tue, May 15 2000	Item Help
Time (hh:mm:ss)	12 : 8 : 59	
▶ IDE Primary Master	Press Enter 4303 MB	Menu Level ▶
▶ IDE Primary Slave	Press Enter None	Change the day, month,
▶ IDE Secondary Master	Press Enter None	year and century.
▶ IDE Secondary Slave	Press Enter None	
Drive A	1.44M, 3.5 in.	
Drive B	None	
Floppy 3 Mode Support	Disabled	
Video	EGA/VGA	
Halt On	All, But Keyboard	
Base Memory	640K	
Extended Memory	63488	
Total Memory	64512K	

- - ® → : Move Enter : Select +/-/PU/PD:Value: F10: Save ESC: Exit F1: General Help
F5: Previous Values F6: Fail-Safe Defaults F7: Optimized Defaults

Date and Time

The Date and Time items show the current date and time held by your computer. If you are running a Windows OS, these items are automatically updated whenever you make changes to the Windows Date and Time Properties utility.

► **IDE Devices**

Default: None

Your computer has two IDE channels (Primary and Secondary) and each channel can be installed with one or two devices (Master and Slave). Use these items to configure each device on the IDE channel. Press **Enter** to display the IDE sub-menu:

CMOS Setup Utility – Copyright © 1984 – 2000 Award Software
IDE Primary Master

IDE HDD Auto-Detection	Press Enter	Item Help
IDE Primary Master	Auto	Menu Level ►►
Access Mode	Auto	To auto-detect the
Capacity	8448 MB	HDD's size, head . . . on
Cylinder	16368	this channel
Head	16	
Precomp	0	
Landing Zone	16367	
Sector	63	

⏪ ⏩ : Move Enter : Select +/-/PU/PD:Value: F10: Save ESC: Exit F1:General Help
F5:Previous Values F6:Fail-Safe Defaults F7:Optimized Defaults

IDE HDD Auto-Detection

Press **Enter** while this item is highlighted if you want the Setup Utility to automatically detect and configure a hard disk drive on the IDE channel.

Note: If you are setting up a new hard disk drive that supports Large Block Addressing (LBA) mode, more than one line will appear in the parameter box. Choose the line that lists LBA for an LBA drive.

IDE Primary/Secondary Master/Slave

If you leave this item at *Auto*, the system will automatically detect and configure any IDE devices it finds. If it fails to find a hard disk, change the value to *Manual* and then manually configure the drive by entering the characteristics of the drive in the items below (Capacity, Cylinder, Head, Precomp, etc.) Refer to your drive's documentation or look on the drive if you need to obtain this information. If no device is installed, change the value to *None*.

Note: Before attempting to configure a hard disk drive, make sure you have the configuration information supplied by the manufacturer of your hard drive. Incorrect settings can result in your system not recognizing the installed hard disk.

Access Mode

This item defines some special ways that can be used to access IDE hard disks such as LBA (Large Block Addressing). Leave this value at *Auto* and the system will automatically decide the fastest way to access the hard disk drive.

Press **Esc** to close the IDE device sub-menu and return to the Standard CMOS Features page.

Drive A and Drive B **Default: 1.44M, 3.5 in., None**

These items define the characteristics of any diskette drive attached to the system. You can connect one or two diskette drives.

Floppy 3 Mode Support **Default: Disabled**

Floppy 3 mode refers to a 3.5-inch diskette with a capacity of 1.2 MB. Floppy 3 mode is sometimes used in Japan.

Video **Default: EGA/VGA**

This item defines the video mode of the system. This mainboard has a built-in VGA graphics system; you must leave this item at the default value.

Halt On **Default: All Errors**

This item defines the operation of the system POST (Power On Self Test) routine. You can use this item to select which types of errors in the POST are sufficient to halt the system.

Base Memory, Extended Memory, and Total Memory

These items are automatically detected by the system at start up time. These are display-only fields. You cannot make changes to these fields.

Advanced BIOS Features Setup Option

This option displays a table of items that define advanced information about your system. You can make modifications to most of these items without introducing fatal errors to your system.

Note that the page has a scroll-bar to scroll down to more items.

CMOS Setup Utility – Copyright (C) 1984 – 2000 Award Software
Advanced BIOS Features

Virus Warning	Disabled		Item Help
Y2K Monitor	Disabled		Menu Level ▶
H/W Reset Function	Enabled		Allows you to choose
CPU Internal Cache	Enabled		the VIRUS warning
External Cache	Enabled		feature for IDE Hard
CPU L2 Cache ECC Checking	Enabled		Disk boot sector
Quick Power On Self Test	Enabled		protection. If this
First Boot Device	Floppy		function is enabled
Second Boot Device	HDD0		and someone attempts
Third Boot Device	LS/120		to write data into this
Boot Other Device	Enabled		area, BIOS will show a
Swap Floppy Drive	Disabled		warning message on
Boot Up Floppy Seek	Enabled		screen and alarm beep
Boot Up NumLock Status	On		
Gate A20 Option	Normal		
FirmWare Write Protect	Disabled		
Typematic Rate Setting	Disabled		
x Typematic Rate (Chars/Sec)	6		
x Typematic Delay (Msec)	250		
Security Option	Setup		

- - ® → : Move Enter : Select +/-/PU/PD:Value: F10: Save ESC: Exit F1:General Help
F5:Previous Values F6:Fail-Safe Defaults F7:Optimized Defaults

Virus Warning

Default: Disabled

When this item is enabled, it provides some protection against viruses that try to write to the boot sector and partition table of your hard disk drive. This item is *Disabled* by default. You need to disable it so that you can install an operating system. We recommend that you enable Anti-Virus Protection as soon as you have installed your disk with an OS.

Y2K Monitor

Default: Disabled

If you enable this item, the system will monitor for errors generated by the year 2000 bug.

H/W Reset Function ***Default: Enabled***

Enables or disables the computer' s hardware reset button.

CPU Internal Cache ***Default: Enabled***

All the processors that can be installed in this mainboard use internal (level 1) cache memory to improve performance. Leave this item at the default value *Enabled* for better performance.

External Cache ***Default: Enabled***

Most processors that can be installed in this system use external (L2) cache memory to improve performance. The exceptions are older SEPP Celeron CPUs running at 266 or 300 MHz. Enable this item for all but these two processors.

CPU L2 Cache ECC Checking ***Default: Enabled***

This item enables or disables ECC (Error Correction Code) error checking on the CPU cache memory. We recommend that you leave this item at the default value.

Quick Power On Self Test ***Default: Enabled***

You can enable this item to shorten the power on testing (POST) and have your system start up a little faster. You might like to enable this item after you are confident that your system hardware is operating smoothly.

1st/2nd/3rd Boot Device ***Default: Floppy/HDD-0/LS120***

Use these three items to select the priority and order of the devices that your system searches for an operating system at start-up time.

Boot Other Device ***Default: Enabled***

If you enable this item, the system will search all other possible locations for an operating system if it fails to find one in the devices specified under the first, second, and third boot devices.

Swap Floppy Drive **Default: Disabled**

If you have two floppy diskette drives in your system, this item allows you to swap the assigned drive letters so that drive A becomes drive B, and drive B becomes drive A.

Boot Up Floppy Seek **Default: Enabled**

If this item is enabled, it checks the geometry of the floppy disk drives at start-up time. You don't need to enable this item unless you have an old diskette drive with 360K capacity.

Boot Up NumLock Status **Default: On**

This item defines if the keyboard Num Lock key is active when your system is started.

Gate A20 Option **Default: Normal**

This item defines how the system handles legacy software that was written for an earlier generation of processors. Leave this item at the default value.

Typematic Rate Setting **Default: Disabled**

If this item is enabled, you can use the following two items to set the typematic rate and the typematic delay settings for your keyboard.

Typematic Rate (Chars/Sec) **Default: 6**

If the item Typematic Rate Setting is enabled, you can use this item to define how many characters per second are generated by a held-down key.

Typematic Delay (Msec) **Default: 250**

If the item Typematic Rate Setting is enabled, you can use this item to define how many milliseconds must elapse before a held-down key begins generating repeat characters.

Security Option ***Default: Setup***

If you have installed password protection, this item defines if the password is required at system start up, or if it is only required when a user tries to enter the Setup Utility.

OS Select For DRAM > 64 MB ***Default: Non-OS2***

This item is only required if you have installed more than 64 MB of memory and you are running the OS/2 operating system. Otherwise, leave this item at the default Non-OS2.

HDD S.M.A.R.T. Capability ***Default: Disabled***

The S.M.A.R.T. (Self-Monitoring, Analysis, and Reporting Technology) system is a diagnostics technology that monitors and predicts device performance. S.M.A.R.T. software resides on both the disk drive and the host computer. The disk drive software monitors the internal performance of the motors, media, heads, and electronics of the drive. The host software monitors the overall reliability status of the drive. If a device failure is predicted, the host software, through the Client WORKS S.M.A.R.T applet, warns the user of the impending condition and advises appropriate action to protect the data.

Report No FDD for WIN 95 ***Default: Yes***

If you are running a system with no floppy drive and using the Windows 95 OS, select Yes for this item to ensure compatibility with the Windows 95 logo certification.

Advanced Chipset Features Option

This option displays a table of items that define critical timing parameters of the mainboard components including the memory, and the system logic. Generally, you should leave the items on this page at their default values unless you are very familiar with the technical specifications of your system hardware. If you change the values incorrectly, you may introduce fatal errors or recurring instability into your system.

CMOS Setup Utility – Copyright (C) 1984 – 2000 Award Software
Advanced Chipset Features

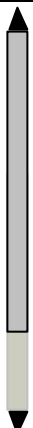
Bank 0/1 DRAM Timing	SDRAM 10ns		Item Help
Bank 2/3 DRAM Timing	SDRAM 10ns		
SDRAM Cycle Length	3		Menu Level ▶
DRAM Clock	Host CLK		
Memory Hole	Disabled		
P2C/C2P Concurrency	Enabled		
Fast R-W Turn Around	Disabled		
System BIOS Cacheable	Enabled		
Video RAM Cacheable	Enabled		
AGP Aperture Size	64M		
AGP 4X Mode	Enabled		
AGP Driving Control	Auto		
X AGP Driving Value	DA		
K7 CLK_CTL Select	Optimal		
OnChip USB	Enabled		
USB Keyboard Support	Disabled		
OnChip Sound	Auto		

- - ® - : Move Enter : Select +/-/PU/PD:Value: F10: Save ESC: Exit F1: General Help
 F5: Previous Values F6: Fail-Safe Defaults F7: Optimized Defaults

Bank 0/1 2/3 DRAM Timing **Default: SDRAM 10ns**

This item allows you to select the timing for the DRAM slots, depending on whether the board has paged SDRAMs.

SDRAM Cycle Length **Default: 3**

This field enables you to set the CAS latency time in HCLKs of 2/2 or 3/3. The system board designer should have set the values in this field, depending on the DRAM installed. Do not change the values in this field unless you change specifications of the installed DRAM or the installed CPU.

DRAM Clock **Default: Host CLK**

Enables the user to select the DRAM Clock.

Memory Hole **Default: Disabled**

If this feature is enabled when the system memory size is equal to or greater than 16 MB, the physical memory address from 15 MB to 16 MB will be passed to PCI or ISA and there will be a 1 MB hole in your system memory. This option is designed for some OS with special add-in cards which need 15-16 MB memory space.

P2C/C2P Concurrency **Default: Enabled**

When disabled, the CPU bus is occupied during the entire PCI operation period.

Fast R-W Turn Around **Default: Disabled**

When this is enabled, the chipset will insert one extra clock to the turn-around of back-to-back DRAM cycles.

System BIOS Cacheable **Default: Enabled**

When enabled, the System BIOS will be cached for faster execution.

Video RAM Cacheable **Default: Enabled**

When enabled, the graphics card's local memory will be cached for faster execution. However, if any program writes to this memory area, a system error may result.

AGP Aperture Size **Default: 64M**

This option determines the effective size of the AGP Graphic *Aperture*, where memory-mapped graphic data structures are located.

AGP 4X Mode **Default: Enabled**

This item allows you to enable or disable the caching of display data for the video memory of the processor. Enabling can greatly improve the display speed. If your graphics display card does not support this feature, you need to disable this item.

AGP Driving Control **Default: Auto**

This item can be used to signal driving current on AGP cards to auto or Manual. Some AGP cards need stronger than normal driving current in order to operate. We recommend that you set this item to Auto by default.

AGP Driving Value **Default: DA**

When the previous item AGP Driving Control is set to Manual, you can use this item to set the AGP current driving value.

K7CLK_CTL Select **Default: Optimal**

This item adjusts the CPU clock to match the internal clock.

OnChip USB **Default: Enabled**

This should be enabled if your system has a USB installed on the system board and you wish to use it.

USB Keyboard Support **Default: Disabled**

Enables function when the USB keyboard is being used. Disabled (default) when an AT keyboard is used.

OnChip Sound **Default: Auto**

Disabling this function turns off the onboard audio chip.

Onboard PCI LAN **Default: Enabled**

This should be enabled if your system is connected to a Local Area Network (LAN).

CPU to PCI Write Buffer **Default: Enabled**

When enabled, up to four words of data can be written to the PCI bus without interrupting the CPU. When disabled, a write buffer is not used and the CPU read cycle will not be completed until the PCI bus signals that it is ready to receive the data.

PCI Dynamic Bursting ***Default: Enabled***

When enabled, every write transaction goes to the write buffer. “Burstable” transactions then burst on the PCI bus and “nonburstable” transactions do not.

PCI Master 0 WS Write ***Default: Enabled***

When enabled, writes to the PCI bus are executed with zero wait state s.

PCI Delay Transaction ***Default: Enabled***

The chipset has an embedded 32-bit posted write buffer to support delay transactions cycles. Enable to support compliance with PCI specification version 2.1.

PCI#2 Access #1 Retry ***Default: Disabled***

When enabled, the AGP Bus (PCI#1) access to PCI Bus (PCI#2) is executed with the error retry feature.

AGP Master 1 WS Write ***Default: Disabled***

This implements a single delay when writing to the AGP Bus. By default, two-wait states are used by the system, allowing for greater stability.

AGP Master WS Read ***Default: Enabled***

This implements a single delay when reading to the AGP Bus. By default, two-wait states are used by the system, allowing for greater stability.

After you have made your selections in the Chipset Features Setup screen, press ESC to go back to the main screen.

Integrated Peripherals Option

This option displays a list of items that defines the operation of some peripheral components on the system's input/output ports.

CMOS Setup Utility – Copyright (C) 1984 – 2000 Award Software
Integrated Peripherals

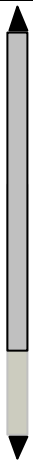
On-Chip IDE Channel0	Enabled			Item Help
On-Chip IDE Channel1	Enabled			Menu Level ▶
IDE Prefetch Mode	Enabled			
Primary Master	PIO	Auto		
Primary Slave	PIO	Auto		
Secondary Master	PIO	Auto		
Secondary Slave	PIO	Auto		
Primary Master	UDMA	Auto		
Primary Slave	UDMA	Auto		
Secondary Master	UDMA	Auto		
Secondary Slave	UDMA	Auto		
Init Display First		PCI Slot		
IDE HDD Block Mode		Enabled		
Onboard FDD Controller		Enabled		
Onboard Serial Port 1		Auto		
Onboard Serial Port 2		Auto		
UART 2 Mode		Standard		
x IR Function Duplex		Half		
x TX,RX inverting enable		No, Yes		

- : Move Enter : Select +/-/PU/PD:Value: F10: Save ESC: Exit F1:General Help
 F5:Previous Values F6:Fail-Safe Defaults F7:Optimized Defaults

On-Chip IDE Channel 0,1 **Default: Enabled**

Use these items to enable or disable the PCI IDE channels that are integrated on the mainboard.

Primary/Secondary Master/Slave PIO **Default: Auto**

Each channel supports a master device and a slave device. These four items let you assign which kind of PIO (Programmed Input/Output) is used by IDE devices. You can choose Auto, to let the system auto detect which PIO mode is best, or you can install a PIO mode from 0-4.

Primary/Secondary Master/Slave UDMA **Default: Auto**

Each channel supports a master device and a slave device. This motherboard supports UltraDMA. UltraDMA technology provides faster access to IDE devices.

If you install a device that supports UltraDMA, change the appropriate item on this list to Auto. You may have to install the UltraDMA driver supplied with this motherboard in order to use an UltraDMA device.

Init Display First ***Default: PCI Slot***

Use this item to define if your graphics adapter is installed in one of the PCI slots or select Onboard if you have a graphics system integrated on the mainboard.

IDE HDD Block Mode ***Default: Enabled***

Block mode transfers can improve the access to IDE devices. Enable this item if your IDE devices support block mode transfers.

Onboard FDD Controller ***Default: Enabled***

This option enables the onboard floppy disk drive controller.

Onboard Serial Port 1, 2 ***Default: Auto***

This option is used to assign the I/O address for the onboard serial ports.

UART2 Mode Select ***Default: Standard***

This field is available if the Onboard Serial Port 2 field is set to any option but Disabled. UART Mode Select enables you to select the infrared communication protocol—Standard (default), HPSIR, or ASKIR. HPSIR is Hewlett Packard's infrared communication protocol with a maximum baud rate up to 115.2 Kbps. ASKIR is Sharp's infrared communication protocol with a maximum baud rate up to 57.6 Kbps.

IR Function Duplex ***Default: Half***

This field is available when UART 2 Mode is set to either ASKIR or HPSIR. This item enables you to determine the infrared (IR) function of the onboard infrared chip. Full-duplex means that you can transmit and send information simultaneously. Half-duplex is the transmission of data in both directions, but only one direction at a time.

TX, RX inverting enable ***Default: No, Yes***

Defines the voltage level for Infrared module RxD (receive) mode and TxD (transmit) mode. This setting has to match the requirements of the infrared module used in the system.

Onboard Parallel Port **Default: 378/IRQ7**

This option is used to assign the I/O address for the onboard parallel port.

Onboard Parallel Mode **Default: Normal**

This feature enables you to set the data transfer protocol for your parallel port. Normal allows data output only. Extended Capabilities Port (ECP) and Enhanced Parallel Port (EPP) are bi-directional modes, allowing both data input and output. ECP and EPP modes are only supported with EPP and ECP aware peripherals.

ECP Mode Use DMA **Default: 3**

When the onboard parallel port is set to ECP mode, the parallel port has the option to use DMA 3 or DMA 1.

Parallel Port EPP Type **Default: EPP1.7**

This option sets the Enhanced Parallel Port (EPP) specification.

Onboard Legacy Audio **Default: Enabled**

This option enables the onboard legacy audio function. When enabled the following items become available.

Sound Blaster **Default: Disabled**

This feature is used to enable or disable a Sound Blaster card if installed.

SB I/O Base Address **Default: 220H**

This item lets you set the I/O base address for the Sound Blaster card.

SB IRQ Select **Default: IRQ 5**

This item lets you set the Interrupt Request (IRQ) for the Sound Blaster card.

SB DMA Select **Default: DMA 1**

This item lets you select the Direct Memory Access (DMA) for the Sound Blaster card.

MPU-401 **Default: Enabled**

Use this item to enable or disable the MPU-401 function for the game port.

MPU-401 I/O Address **Default: 330-333H**

Use this item to set the I/O address for the game port.

Game Port (200-207H) **Default: Enabled**

This item shows the I/O address for the game port.

Power Management Setup Option

This option displays items that let you control the system power management. Modern operating systems take care of much of the power management. This mainboard supports ACPI (Advanced Configuration and Power Interface). The system has various power saving modes including powering down the hard disk, turning off the video, suspending to RAM, and a software power down that allows the system to be automatically resumed by certain events.

Power Management Timeouts

The power-saving modes can be controlled by timeouts. If the system is inactive for a time, the timeouts begin counting. If the inactivity continues so that the timeout period elapses, the system enters a power-saving mode. If any item in the list of *Reload Global Timer Events* is Enabled, then any activity on that item will reset the timeout counters to zero.

Wake Up Calls

If the system is suspended, or has been powered down by software, it can be resumed by a wake up call that is generated by incoming traffic to a modem, a LAN card, a PCI card, or a fixed alarm on the system realtime clock,

CMOS Setup Utility – Copyright (C) 1984 – 2000 Award Software
Power Management Setup

▶ ACPI Function	Enabled	Item Help
▶ Power Management	Press Enter	
ACPI Suspend Type	S1(POS)	Menu Level ▶
PM Control by APM	Yes	
Video Off Option	Suspend --> Off	
Video Off Method	DPMS Support	
MODEM Use IRQ	3	
Soft-Off by PWRBTN	Instant-Off	
AC Resume Function	Always Off	
▶ Wake Up Events	Press Enter	

← → : Move Enter : Select +/-/PU/PD:Value: F10: Save ESC: Exit F1:General Help
F5:Previous Values F6:Fail-Safe Defaults F7:Optimized Defaults

ACPI Function **Default: Enabled**

This mainboard supports ACPI (Advanced Configuration and Power management Interface). Use this item to enable or disable the ACPI feature.

***Note:** ACPI (Advanced Configuration and Power Interface) is a power management specification that makes hardware status information available to the operating system. ACPI enables a PC to turn its peripherals on and off for improved power management. It also allows the PC to be turned on and off by external devices, so that mouse or keyboard activity wakes up the computer.*

Power Management

This item enables you to choose the type of Power Management you want. Selecting Power Management and pressing **Enter** displays the following screen:

CMOS Setup Utility – Copyright (C) 1984 – 2000 Award Software
Power Management

Power Management	User Define	Item Help
HDD Power Down	Disable	
Doze Mode	Disable	
Suspend Mode	Disable	
		Menu Level ▶▶

← : Move ® : Select +/-/PU/PD:Value: F10: Save ESC: Exit F1:General Help
F5:Previous Values F6:Fail-Safe Defaults F7:Optimized Defaults

This menu enables you to set the following items:

Power Management **Default: User Define**

This item acts like a master switch for the power-saving modes and hard disk timeouts. If this item is set to Max Saving, power-saving modes occur after a short timeout. If this item is set to Min Saving, power-saving modes occur after a longer timeout. If the item is set to User Define, you can insert your own timeouts for the power-saving modes.

HDD Power Down **Default: Disable**

The IDE hard drive will spin down if it is not accessed within a specified length of time. Options are from 1 Min to 15 Min and Disable.

Doze Mode **Default: Disable**

The system speed will change from turbo to slow if no Power Management events occur for a specified length of time. Full power function will return when a Power Management event is detected.

Suspend Mode **Default: Disable**

The CPU clock will be stopped and the video signal will be suspended if no Power Management events occur for a specified length of time. Full power function will return when a Power Management event is detected. Options are from 1 Min to 1 Hour and Disable.

ACPI Suspend Type **Default: S1 (POS)**

Use this item to define how your system suspends. In the default, S1 (POS), the suspend mode is equivalent to a software power down. If you select S3 (STR), the suspend mode is a suspend to RAM –the system shuts down with the exception of a refresh current to the system memory.

PM Control by APM **Default: Yes**

This field allows you to control the PC Monitor' s power management features via Intel-Microsoft Advanced Power Management software. Once you have enabled the APM interface, some settings made in the BIOS Setup program may be overridden by APM.

Video Off Option **Default: Suspend --> Off**

This option defines if the video is powered down when the system is put into suspend mode.

Video Off Method **Default: DPMS Support**

This item defines how the video is powered down to save power. This item is set to DPMS (display power management software) by default.

MODEM Use IRQ **Default: 3**

If you want an incoming call on a modem to automatically resume the system from a power-saving mode, use this item to specify the interrupt request line (IRQ) that is used by the modem. You might have to connect the fax/modem to the mainboard Wake On Modem connector for this feature to work.

Soft-Off by PWRBTN **Default: Instant-Off**

Under ACPI (Advanced Configuration and Power management Interface) you can create a software power down. In a software power down, the system can be resumed by Wake Up Alarms. This item lets you install a software power down that is controlled by the normal power button on your system. If the item is set to Instant-Off, then the power button causes a software power down. If the item is set to "Delay 4 Sec." then you have to hold the power button down for four seconds to cause a software power down.

AC Resume Function **Default: Always Off**

This sets the power state after a shutdown due to an unexpected interrupt of AC power.

Wake Up Events

This item opens a submenu that enables you to set events that will resume the system from a power saving mode. Select Wake Up Events and press **Enter** to display the following menu:

CMOS Setup Utility – Copyright (C) 1984 – 2000 Award Software
Wake Up Events

USB Resume from S3/S4/S5	Disabled	Item Help
VGA	OFF	
LPT & COM	LPT/COM	Menu Level ▶▶
HDD & FDD	ON	
PCI Master	OFF	
PowerOn by PCI Card	Disabled	
Wake Up On LAN/Ring	Disabled	
RTC Alarm Resume	Disabled	
x Date (of Month)	0	
x Resume Time (hh:mm:ss)	0 32 0	
Primary INTR	ON	
▶ IRQs Activity Monitoring	Press Enter	

- : Move Enter : Select +/-PU/PD:Value: F10: Save ESC: Exit F1:General Help
F5:Prevbus Values F6:Fail-Safe Defaults F7:Optimized Defaults

VGA Default: Off

When set to On, the system power will resume the system from a power saving mode if there is any VGA activity. Default is Off.

LPT & COM Default: LPT/COM

When this item is enabled, the system will restart the power-saving timeout counters when any activity is detected on the serial ports, or the parallel port.

HDD & FDD Default: ON

When this item is enabled, the system will restart the power-saving timeout counters when any activity is detected on the hard disk drive or the floppy diskette drive.

PCI Master Default: Off

When set to Off any PCI device with Master function will not power on the system.

PowerOn by PCI Card Default: Disabled

When set to Enabled, the system power will be turned on if there is any PCI card activity from PCI cards that trigger a PME event, such as LAN or modem cards.

Wake Up On LAN/Ring **Default: Disabled**

When set to Enabled, the system power will be turned on if there is any LAN card or modem activity.

RTC Alarm Resume **Default: Disabled**

When set to Enabled, the following two fields become available and you can set the date (day of the month), hour, minute and second to turn on your system. When set to 0 (zero) for the day of the month, the alarm will power on your system every day at the specified time.

Primary INTR **Default: ON**

When set to On (default), any event occurring at the specified IRQ will awaken a system which has been powered down.

IRQs Activity Monitoring

This item opens a submenu that enables you to set IRQs that will resume the system from a power saving mode. Select IRQs Activity Monitoring and press **Enter** to display the following menu:

CMOS Setup Utility – Copyright (C) 1984 – 2000 Award Software
IRQs Activity Monitoring

IRQ 3	(COM2)	Enabled	Item Help
IRQ 4	(COM1)	Enabled	
IRQ 5	(LPT2)	Enabled	
IRQ 6	(Floppy Disk)	Enabled	
IRQ 7	(LPT1)	Enabled	
IRQ 8	(RTC Alarm)	Disabled	
IRQ 9	(IRQ2 Redir)	Disabled	
IRQ 10	(Reserved)	Disabled	
IRQ 11	(Reserved)	Disabled	
IRQ 12	(PS/2 Mouse)	Enabled	
IRQ 13	(Coprocessor)	Enabled	
IRQ 14	(Hard Disk)	Enabled	
IRQ 15	(Reserved)	Disabled	
			Menu Level >>>

- - ® - : Move Enter : Select +/-/PU/PD: Value: F10: Save ESC: Exit F1: General Help
 F5: Previous Values F6: Fail-Safe Defaults F7: Optimized Defaults

Set Primary INTR to ON to allow you to enable or disable IRQ 3 through IRQ 15 activity monitoring. Set it to OFF to disable IRQ activity monitoring.

Set any IRQ to Enabled to allow activity at the IRQ to wake up the system from a power saving mode.

PnP/PCI Configuration Option

This option displays a table of items that configures how PnP (Plug and Play) and PCI add-in cards operate in your system.

CMOS Setup Utility – Copyright (C) 1984 – 2000 Award Software
PnP/PCI Configurations

PNP OS Installed	No	Item Help
Reset Configuration Data	Disabled	
Resources Controlled by	Auto(ESCD)	Menu Level ► Default is Disabled. Select Enabled to reset Extended System Configuration Data (ESCD) when you exit Setup if you have installed a new add-on and the system reconfiguration has caused such a serious conflict that the OS cannot boot.
x IRQ Resources	Press Enter	
x DMA Resources	Press Enter	
PCI/VGA Palette Snoop	Disabled	
Assign IRQ For VGA	Enabled	
Assign IRQ For USB	Enabled	

← → : Move Enter : Select +/-/PU/PD:Value: F10: Save ESC: Exit F1:General Help
F5:Previous Values F6:Fail-Safe Defaults F7:Optimized Defaults

PNP OS Installed

Default: No

Setting this option to Yes allows the PnP OS (instead of BIOS) to assign the system resources such as IRQ and I/O address to the ISA PnP device.

Reset Configuration Data

Default: Disabled

If you enable this item and restart the system, any PnP configuration data stored in the BIOS setup is cleared from memory. New updated data is created.

Resources Controlled By

Default: Auto(ESCD)

You should leave this item at the default Auto (ESCD). Under this setting, the system dynamically allocates resources to plug and play devices as they are required. If you cannot get a legacy ISA (Industry Standard Architecture) add-in card to work properly, you might be able to solve the problem by changing this item to Manual, and then opening up the *IRQ Resources* and *Memory Resources* sub-menus.

In the *IRQ Resources* sub-menu, if you change any of the IRQ assignments to Legacy ISA, then that Interrupt Request Line is reserved for a legacy ISA add-in card. Press **Esc** to close the IRQ Resources sub-menu.

PCI/VGA Palette Snoop ***Default: Disabled***

This item is designed to overcome some problems that can be caused by some non-standard VGA cards. This board includes a built-in VGA system that does not require palette snooping so you must leave this item disabled.

Assign IRQ For VGA ***Default: Enabled***

Names the interrupt request (IRQ) line assigned to the VGA (if any) on your system. Activity of the selected IRQ always awakens the system.

Assign IRQ For USB ***Default: Enabled***

Names the interrupt request (IRQ) line assigned to the USB (if any) on your system. Activity of the selected IRQ always awakens the system.

PC Health Status Option

On mainboards that support hardware monitoring, this item lets you monitor the parameters for critical voltages, critical temperatures, and fan speeds.

CMOS Setup Utility – Copyright (C) 1984 – 2000 Award Software
PC Health Status

Shutdown Temperature	Disabled	Item Help
Current CPU Temp.		Menu Level ▶
Current System Temp.		
Current CPU FAN speed		
Current POWER FAN speed		
Vcore		
3.3V		
5V		
12V		

⊞ : Move Enter : Select +/-/PU/PD:Value: F10: Save ESC: Exit F1:General Help
F5:Previous Values F6:Fail-Safe Defaults F7:Optimized Defaults

Shutdown Temperature

Enables you to set the maximum temperature the system can reach before powering down.

System Component Characteristics

These fields provide you with information about the systems current operating status. You cannot make changes to these fields. The following information is displayed:

- CPU Temperature
- System Temperature
- CPU FAN (in RPMs)
- POWER FAN (in RPMs)
- Vcore (CPU Core voltage)
- 3.3V (onboard 3.3 volt)
- 5V (power supply' s 5 volt)
- 12V (power supply' s 12 volt)

Frequency Control Option

This item enables you to set the clock speed and system bus for your system. The clock speed and system bus are determined by the kind of processor you have installed in your system.

CMOS Setup Utility – Copyright (C) 1984 – 2000 Award Software
Frequency Control

Auto Detect DIMM/PCI Clk	Enabled	Item Help
Spread Spectrum Modulated	Disabled	Menu Level ▶
CPU Host/PCI Clock	Default	

- - ® - : Move Enter : Select +/-/PU/PD:Value: F10: Save ESC: Exit F1:General Help
 F5:Previous Values F6:Fail-Safe Defaults F7:Optimized Defaults

Auto Detect DIMM/PCI Clk ***Default: Enabled***

When this item is enabled, BIOS will disable the clock signal of free DIMM and PCI slots.

Spread Spectrum ***Default: Disabled***

If you enable spread spectrum, it can significantly reduce the EMI (Electro-Magnetic Interference) generated by the system.

CPU Host/PCI Clock

These items appear if you have set the *CPU Internal Core Speed* to Manual. Use the *CPU/DIMM/PCI Clock* to set the system bus frequency for the installed processor (usually 133 MHz, 100 MHz or 66 MHz).

Load Fail-Safe Defaults Option

This option opens a dialog box that lets you install fail-safe defaults for all appropriate items in the whole Setup Utility. Press <Y> and then <Enter> to install the defaults. Press <N> and then <Enter> to not install the defaults. The fail-safe defaults place no great demands on the system and are generally stable. If your system is not functioning correctly, try installing the fail-safe defaults as a first step in getting your system working properly again. If you only want to install fail-safe defaults for a specific option, select and display that option, and then press <F6>.

Load Optimized Defaults Option

This option opens a dialog box that lets you install optimized defaults for all appropriate items in the whole Setup Utility. Press <Y> and then <Enter> to install the defaults. Press <N> and then <Enter> to not install the defaults. The optimized defaults place demands on the system that may be greater than the performance level of the components, such as the CPU and the memory. You can cause fatal errors or instability if you install the optimized defaults when your hardware does not support them. If you only want to install setup defaults for a specific option, select and display that option, and then press the <F7> key.

Set Supervisor and User Passwords

These items can be used to install a password. A Supervisor password takes precedence over a User password, and the Supervisor can limit the activities of a User. To install a password, follow these steps:

1. Highlight the item Set Supervisor/User password on the main menu and press <Enter>.
2. The password dialog box appears.

Enter Password:

3. If you are installing a new password, type in the password. You cannot use more than eight characters or numbers. The Set Supervisor/User Password item differentiates between upper case and lower characters. Press <Enter> after you have typed in the password. If you are deleting a password that is already installed just press <Enter> when the password dialog box appears. You see a message that indicates that the password has been disabled.

PASSWORD DISABLED !!!
Press any key to continue . . .

4. The system will ask you to confirm the new password by asking you to type it in a second time.

Confirm Password:

5. Type the password again and press <Enter>, or just press <Enter> if you are deleting a password that is already installed.
6. If you typed the password correctly, the password will be installed.

Save & Exit Setup Option

Highlight this item and press <Enter> to save the changes that you have made in the Setup Utility and exit the Setup Utility. When the Save and Exit dialog box appears, press <Y> to save and exit, or press <N> to return to the Setup Utility main menu:

SAVE to CMOS and EXIT (Y/N)? **Y**

Exit Without Saving Option

Highlight this item and press <Enter> to discard any changes that you have made in the Setup Utility and exit the Setup Utility. When the Exit Without Saving dialog box appears, press <Y> to discard changes and exit, or press <N> to return to the setup main menu.

Quit Without Saving (Y/N)? **N**

Note: If you have made settings that you do not want to save, use the "Exit Without Saving" item and press Y to discard any changes you have made.

This concludes Chapter 3. Refer to the next chapter for information on the software supplied with the mainboard.

Chapter 4: Software

About the Software

The support software CD-ROM that is included in the mainboard package contains all the drivers and utility programs needed to properly run the bundled products. Below you can find a brief description of each software program, and the location for your mainboard version. More information on some programs is available in a README file, located in the same directory as the software.

***Note:** Never try to install software from a folder that is not specified for use with your mainboard. Before installing any software, always inspect folders for files named README.TXT or something similar. These files may contain important information that is not included in this manual.*

Folders for this Mainboard

For this board, you can install software from the following folders:

Utility Folder

You can use the software in the following sub-folders:

- AWDFLASH** Software to erase and install revisions of the system BIOS (CMOS)
- GAMUT:** Audio rack for built-in sound system
- MEDIARING TALK:** Telephony software
- PC-CILLIN:** Anti-virus software
- SUPER VOICE:** Fax/modem software

K7VZM Folder

You can use the software in the following sub-folders:

- AUDIO:** Drivers and software for the built-in audio.
- IDE:** Drivers and software for the built-in IDE.
- LAN:** Drivers for onboard network adapter.
- Monitor:** Software for the VIA Hardware Monitor.

Auto-installing under Windows 98

The Auto-install CD-ROM makes it easy for you to install the drivers and software for your mainboard.

Note: If the Auto-install CD-ROM does not work on your system, you can still install all the drivers through the file manager.

The support software CD-ROM disc loads automatically under Windows 98. When you insert the CD-ROM disc in the system CD-ROM drive, the autorun feature will automatically bring up the install screen:

Note: The following screens are examples only. The screens and driver lists will be different according to the mainboard you are installing.

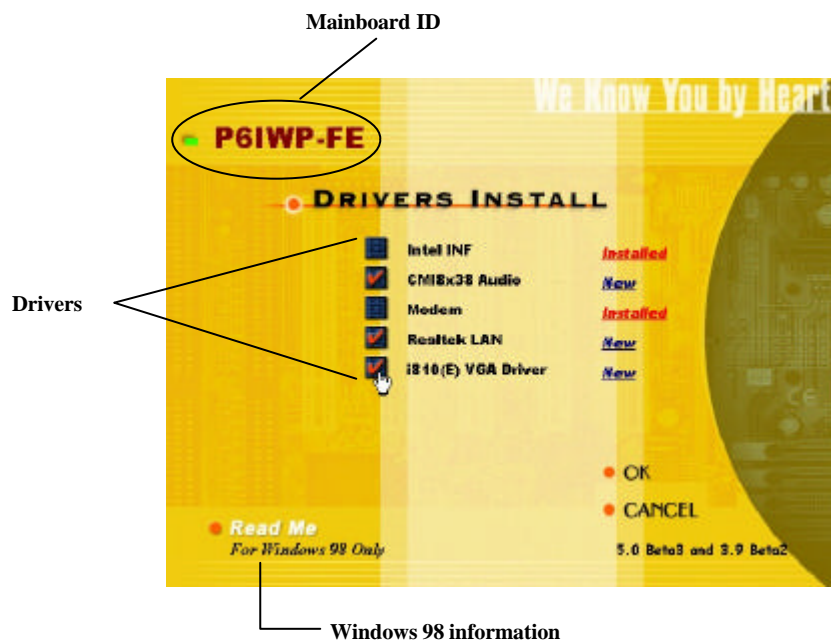

The mainboard identification is located in the upper left-hand corner. Click which drivers you want to install, and then click **OK**. Click **Cancel** if you do not want to install drivers at this time.

After clicking **OK**, the install Wizard will start.



A driver installation screen appears:

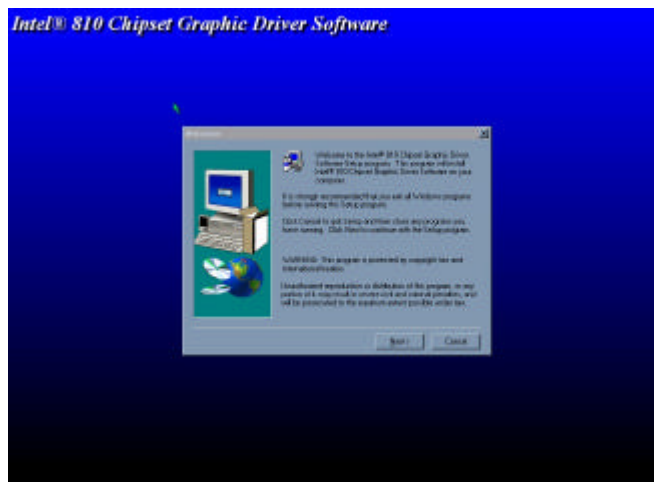

Follow the instructions on the screen to install the driver.

Software is automatically installed in sequence. You will need to follow the onscreen instructions, confirm commands and allow the computer to restart a few times to complete installing whatever software you selected to install:



When the process is finished, all the support software will be installed and working.

After you finish installing the drivers for your mainboard, the Applications screen appears:

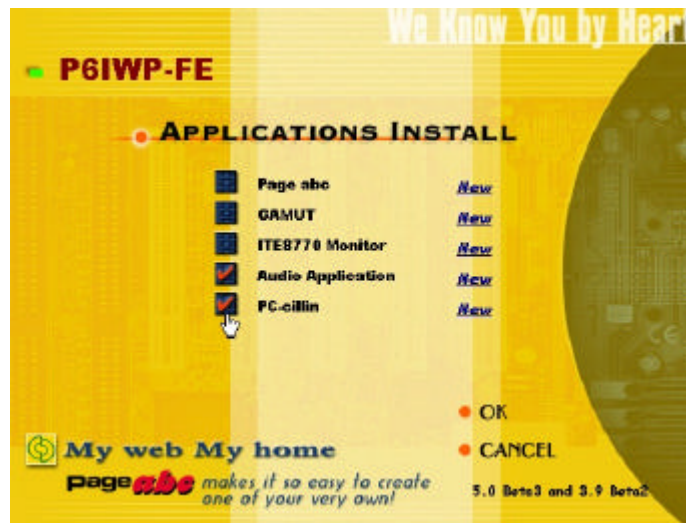

Select which applications you want to install, and click **OK**.

If the mainboard doesn't support the autoinstall feature, you will see the following screen:



Note: If the opening screen doesn't appear, double-click the file "autorun.exe" in the AUTORUN directory.

Click READ ME to read the latest installation instructions. Click BROWSE THE CD TITLE to open Windows File Manager and show the contents of the support CD.

Double-click a folder to display the sub-folders. Before installing the software, look for a file named README.TXT, INSTALL.TXT or something similar. This file may contain important information to help you install the software correctly.

Some software is installed in separate folders for different operating systems, such as DOS, WIN NT, or WIN98/95. Always go to the correct folder for the kind of OS you are using.

To install the software, execute a file named SETUP.EXE or INSTALL.EXE by double-clicking the file and then following the instructions on the screen.

Note: Enable Windows File Manager to display file extensions (for example, EXE).

Utility Folder Installation Notes

AWD Flash Memory Utility

The AWD Flash Memory Utility allows you to update the BIOS file on the mainboard to a newer version. You can download the latest version of the BIOS Setup Utility available for your mainboard from the Award Web site (www.award.com).

\UTILITY\AWDFLASH\AWD7XX.EXE

PC-Cillin Software

The PC-cillin software program provides anti-virus protection for your system. This program is available for:

- DOS – \UTILITY\PC-CILLIN\DOS\PCSCAN.EXE
- Win98 – \UTILITY\PC-CILLIN\WIN98\SETUP.EXE

Anti-virus software is provided for DOS and WIN98. Browse to the appropriate directory for your operating system. For DOS, copy all the files in the DOS folder to your hard disk drive and run PSCAN to scan your system. For Windows 98, run SETUP to install the application software.

GAMUT

To install the Gamut audio rack software for the built-in sound system go to the directory \UTILITY\GAMUT, then run SETUP.EXE to install the application software.

MediaRing Talk

To install the MediaRing Talk voice modem software for the built-in modem, go to the directory \UTILITY\MEDIARING TALK; then run MRTALK-SETUP7.2.EXE to install the application software.

Super Voice

To install the Super Voice voice, fax, data communication application for use with the built-in fax/modem, go the directory \UTILITY\SUPER VOICE; then run PICSHELL.EXE to install the application software.

Mainboard (K7VZM) Installation Notes

Most of the sub-folders in this folder are empty, with a short README file giving directions to alternate folders for the appropriate software.

Audio Software

This folder has software and drivers for the sound system that is integrated on this mainboard. Drivers are provided for Windows 2000/ME/98/95, Windows NT, and DOS.

DOS Installation

Browse to the VIA\AC97AUDIO\DOS folder on the driver CD-ROM and run the INSTALL program.

Windows 2000/ME/98/95 Installation

Browse to the \VIA\AC97AUDIO\ folder and run SETUP.EXE to install the audio driver for your operating system.

Windows NT 4.0 Installation

Browse to the \VIA\AC97AUDIO\ folder, then browse to the WINNT40\Setup subfolder, and run the SETUP.EXE for your operating system.

IDE Software

This folder has software and drivers for the IDE that is integrated on this mainboard. Drivers are provided for Windows 2000/ME/98/95, Windows NT.

Windows 2000/ME/98/95/NT Installation

Browse to the \VIA\IDE\ folder and run SETUP.EXE to install the IDE driver for your operating system.

LAN Software

This folder has software and drivers for the LAN system that is integrated on this mainboard. Drivers are provided for Windows 2000/ME/98/95 and Windows NT.

Windows ME/2000/98/95/NT Installation

When Windows detects your LAN hardware, choose Have Disk when the Windows Hardware Wizard prompts you for the model of your LAN adapter. Browse to the path \Peripheral\LAN\Realtek to load the OEM information and follow the instructions on the screen to install your hardware.

Monitor Software

This folder has the VIA Hardware Monitor software that is provided for Windows 2000/ME/98/95.

Windows 2000/ME/98/95 Installation

Browse to the \VIA\Monitor\ folder and run SETUP.EXE to install the VIA Hardware Monitor to your operating system.

Appendix: Jumper Setting Reference

Jumper Setting Quick Reference

JP1: Clear CMOS jumper

Use this jumper to clear the system CMOS. Before clearing CMOS, the AC power should be disconnected.

Function	Jumper Setting
Normal operation	Short pins 1-2
Clear CMOS	Short pins 2-3



JP2: USB port 1-2 wake-up jumper

Use this jumper to enable device activity on USB ports 1-2 to power on the computer.

Function	Jumper Setting
Disable	Short pins 1-2
Enable	Short pins 2-3



JP4: Codec selector jumper

Use this jumper to select onboard or AMR slot codec.

Function	Jumper Setting
Use on board codec	Short pins 1-2
Use AMR slot codec	Short pins 2-3



JP5: BIOS write protect jumper

Use this jumper to make the BIOS read-only.

Function	Jumper Setting
Disable	Short pins 1-2
Enable	Short pins 2-3



JP6: USB port 3-4 wake-up jumper

Use this jumper to enable device activity on USB ports 3-4 to power on the computer.

Function	Jumper Setting
Disable	Short pins 1-2
Enable	Short pins 2-3

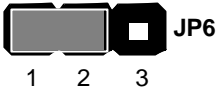

JP7: Onboard codec mode

Use this jumper to define the onboard codec mode function.

Function	Jumper Setting
Master	Open
Slave	Short



JP9/10: FSB 100/133 select jumpers

Note: JP9 and JP10 are only supported by the VIA VT8363A North Bridge chipset

Use these jumpers to select the FSB speed.

Function	Jumper Setting
100 MHz FSB	Short pins 2-3 of JP9 Short pins 1-2 of JP10
133 MHz FSB	Short pins 1-2 of JP9 Short pins 2-3 of JP10

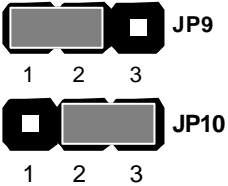
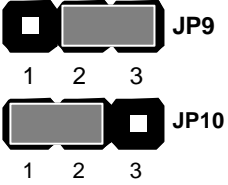

PANEL 1: Panel connectors for switches and indicators

Use the panel connector to implement the switches and indicators on your system case.

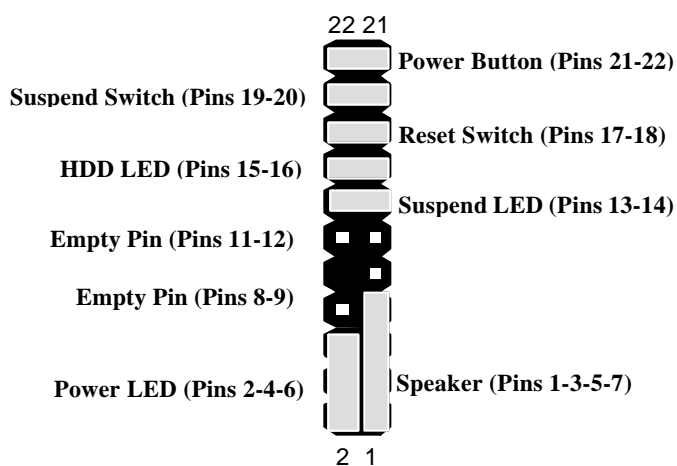

Function	Pins
Speaker	1, 3, 5, 7
Power LED Indicator	+2, 4, 6
Empty Pin	8, 9
Empty Pin	11, 12
Suspend LED Indicator	+13, 14
Hard Disk LED Indicator	+15, 16
Reset Switch	17, 18
Suspend Switch	19, 20
Power Button	21, 22

Note: The plus sign (+) indicates a pin which must be connected to a positive voltage.