



- ⚡ The author assumes no responsibility for any errors or omissions that may appear in this document nor does the author make a commitment to update the information contained herein.
- ⚡ Third-party brands and names are the property of their respective owners.
- ⚡ Please do not remove any labels on motherboard, this may void the warranty of this motherboard.
- ⚡ Due to rapid change in technology, some of the specifications might be out of date before publication of this booklet.



Before you install PCI cards, please remove the Dual BIOS label from PCI slots if there is one.



WARNING: *Never run the processor without the heatsink properly and firmly attached. PERMANENT DAMAGE WILL RESULT!*

Mise en garde : *Ne faites jamais tourner le processeur sans que le dissipateur de chaleur soit fixé correctement et fermement. UN DOMMAGE PERMANENT EN RÉSULTERA !*

Achtung: *Der Prozessor darf nur in Betrieb genommen werden, wenn der Wärmeableiter ordnungsgemäß und fest angebracht ist. DIES HAT EINEN PERMANENTEN SCHADEN ZUR FOLGE!*

Advertencia: *Nunca haga funcionar el procesador sin el dissipador de calor instalado correcto y firmemente. ¡SE PRODUCIRÁ UN DAÑO PERMANENTE!*

Aviso: *Nunca execute o procesador sem o dissipador de calor estar adequado e firmemente conectado. O RESULTADO SERÁ UM DANO PERMANENTE!*

警告: *將散熱板牢固地安裝到處理器上之前，不要運行處理器。過熱將永遠損壞處理器！*

警告: *將散熱板牢固地安裝到處理器上之前，不要運行處理器。過熱將永遠損壞處理器！*

경고: *히트싱크를 제대로 또 단단히 부착시키지 않은 채 프로세서를 구동시키지 마십시오. 영구적 고장이 발생할 수 있습니다!*

警告: *永久的な損傷を防ぐため、ヒートシンクを正しくしっかりと取り付けるまでは、プロセッサを動作させないようにしてください。*

DECLARATION OF CONFORMITY

Per FCC Part 2 Section 2.1077(a)



Responsible Party Name: G.B.T. INC. (U.S.A.)

**Address: 17358 Railroad Street
City of Industry, CA 91748**

Phone/Fax No: (818) 854-9338/ (818) 854-9339

hereby declares that the product

Product Name: Motherboard

Model Number: GA-8IGX

Conforms to the following specifications:

FCC Part 15, Subpart B, Section 15.107(a) and Section 15.109(a),
Class B Digital Device

Supplementary Information:

This device complies with part 15 of the FCC Rules. Operation is subject to the following two conditions: (1) This device may not cause harmful and (2) this device must accept any inference received, including that may cause undesired operation.

Representative Person's Name: ERIC LU

Signature: Eric Lu

Date: March 29,2002

Declaration of Conformity

We, Manufacturer/Importer
(full address)

G.B.T. Technology Trading GmbH
Ausschlagler Weg 41, 1F, 20537 Hamburg, Germany

declare that the product
(description of the apparatus, system, installation to which it refers)

Mother Board

GA-8IGX

is in conformity with

(reference to the specification under which conformity is declared)

in accordance with 89/336 EEC-EMC Directive

<input type="checkbox"/> EN 55011	Limits and methods of measurement of radio disturbance characteristics of industrial, scientific and medical (ISM) high frequency equipment	<input type="checkbox"/> EN 61000-3-2* <input checked="" type="checkbox"/> EN 60555-2	Disturbances in supply systems cause by household appliances and similar electrical equipment "Harmonics"
<input type="checkbox"/> EN 55013	Limits and methods of measurement of radio disturbance characteristics of broadcast receivers and associated equipment	<input type="checkbox"/> EN 61000-3-3* <input checked="" type="checkbox"/> EN 60555-3	Disturbances in supply systems cause by household appliances and similar electrical equipment "Voltage fluctuations"
<input type="checkbox"/> EN 55014	Limits and methods of measurement of radio disturbance characteristics of household electrical appliances, portable tools and similar electrical apparatus	<input checked="" type="checkbox"/> EN 50081-1 <input checked="" type="checkbox"/> EN 50082-1	Generic emission standard Part 1: Residual commercial and light industry Generic immunity standard Part 1: Residual commercial and light industry
<input type="checkbox"/> EN 55015	Limits and methods of measurement of radio disturbance characteristics of fluorescent lamps and luminaries	<input type="checkbox"/> EN 55081-2	Generic emission standard Part 2: Industrial environment
<input type="checkbox"/> EN 55020	Immunity from radio interference of broadcast receivers and associated equipment	<input type="checkbox"/> EN 55082-2	Generic emission standard Part 2: Industrial environment
<input checked="" type="checkbox"/> EN 55022	Limits and methods of measurement of radio disturbance characteristics of information technology equipment	<input type="checkbox"/> ENV 55104	Immunity requirements for household appliances tools and similar apparatus
<input type="checkbox"/> DIN VDE 0855 <input type="checkbox"/> part 10 <input type="checkbox"/> part 12	Cabled distribution systems; Equipment for receiving and/or distribution from sound and television signals	<input type="checkbox"/> EN50091-2	EMC requirements for uninterruptible power systems (UPS)

CE marking



(EC conformity marking)

The manufacturer also declares the conformity of above mentioned product with the actual required safety standards in accordance with LVD 73/23 EEC

<input type="checkbox"/> EN 60065	Safety requirements for mains operated electronic and related apparatus for household and similar general use	<input type="checkbox"/> EN 60950	
<input type="checkbox"/> EN 60335	Safety of household and similar electrical appliances	<input type="checkbox"/> EN 50091-1	

Manufacturer/Importer

(Stamp)

Date : March 29, 2002

Signature: Timmy Huang
Name: Timmy Huang

GA-8IGX
P4 Titan 533 Motherboard

USER'S MANUAL

Pentium®4 Processor Motherboard

Rev. 1101

12ME-8IGX-1101

Table of Content

Item Checklist	4
WARNING!	4
Chapter 1 Introduction	5
Features Summary	5
GA-8IGX Motherboard Layout	7
Chapter 2 Hardware Installation Process	8
Step 1: Install the Central Processing Unit (CPU)	9
CPU Installation	9
CPU Heat Sink Installation	10
Step 2: Install memory modules	11
Step 3: Install expansion cards	13
Step 4: Connect ribbon cables, cabinet wires, and power supply	14
Step4-1: I/O Back Panel Introduction	14
Step4-2: Connectors Introduction	16
Step4-3: Jumper Introduction	23
Chapter 3 BIOS Setup	24
The Main Menu (For example: BIOS Ver. : F1)	25
Standard CMOS Features	27
Advanced BIOS Features	30
Integrated Peripherals	32

Power Management Setup	37
PnP/PCI Configurations	39
PC Health Status	40
Frequency/Voltage Control	42
Top Performance	45
Select Language	46
Load Fail-Safe Defaults	47
Load Optimized Defaults	48
Set Supervisor/User Password	49
Save & Exit Setup	50
Exit Without Saving	51
Chapter 4 Technical Reference	52
Block Diagram	52
Dual BIOS/Q-Flash Introduction	53
@ BIOS Introduction	61
Easy Tune™ 4 Introduction	62
Chapter 5 Appendix	63

Item Checklist

- | | |
|---|---|
| <input checked="" type="checkbox"/> The GA-8IGX motherboard | <input checked="" type="checkbox"/> Quick PC Installation Guide |
| <input checked="" type="checkbox"/> IDE cable x 1/ Floppy cable x 1 | <input checked="" type="checkbox"/> USB Cable x 1 |
| <input checked="" type="checkbox"/> CD for motherboard driver & utility | |
| <input checked="" type="checkbox"/> I/O Shield | |
| <input checked="" type="checkbox"/> GA-8IGX user's manual | |



WARNING!

Computer motherboards and expansion cards contain very delicate Integrated Circuit (IC) chips. To protect them against damage from static electricity, you should follow some precautions whenever you work on your computer.

1. Unplug your computer when working on the inside.
2. Use a grounded wrist strap before handling computer components. If you do not have one, touch both of your hands to a safely grounded object or to a metal object, such as the power supply case.
3. Hold components by the edges and try not touch the IC chips, leads or connectors, or other components.
4. Place components on a grounded antistatic pad or on the bag that came with the components whenever the components are separated from the system.
5. Ensure that the ATX power supply is switched off before you plug in or remove the ATX power connector on the motherboard.

Installing the motherboard to the chassis...

If the motherboard has mounting holes, but they don't line up with the holes on the base and there are no slots to attach the spacers, do not become alarmed you can still attach the spacers to the mounting holes. Just cut the bottom portion of the spacers (the spacer may be a little hard to cut off, so be careful of your hands). In this way you can still attach the motherboard to the base without worrying about short circuits. Sometimes you may need to use the plastic springs to isolate the screw from the motherboard PCB surface, because the circuit wire may be near by the hole. Be careful, don't let the screw contact any printed circuit write or parts on the PCB that are near the fixing hole, otherwise it may damage the board or cause board malfunctioning.

Chapter 1 Introduction

Features Summary

Form Factor	<ul style="list-style-type: none"> • 30.5cm x 24.4cm ATX size form factor, 4 layers PCB.
CPU	<ul style="list-style-type: none"> • Socket 478 for Intel® Micro FC-PGA2 Pentium® 4 processor • Support Intel® Pentium® 4 (Northwood, 0.13 μm) processor • Intel Pentium®4 400/533MHz FSB • 2nd cache depends on CPU
Chipset	<ul style="list-style-type: none"> • Chipset Intel 82845G HOST/AGP/Controller • ICH4 I/O Controller Hub
Memory	<ul style="list-style-type: none"> • 3 184-pin DDR DIMM sockets • Supports PC2100 DDR or PC1600 DDR DIMM • Supports up to 2GB DRAM (Max) • Supports only 2.5V DDR DIMM
I/O Control	<ul style="list-style-type: none"> • ITE8712F
Slots	<ul style="list-style-type: none"> • 1 AGP slot 4X (1.5V) device support • 6 PCI slot supports 33MHz & PCI 2.2 compliant
On-Board IDE	<ul style="list-style-type: none"> • 2 IDE bus master (DMA33/ATA66/ATA100) IDE ports for up to 4 ATAPI devices • Supports PIO mode3,4 (UDMA 33/ATA66/ATA100) IDE & ATAPI CD-ROM
On-Board Peripherals	<ul style="list-style-type: none"> • 1 Floppy port supports 2 FDD with 360K, 720K, 1.2M, 1.44M and 2.88M bytes. • 1 Parallel port supports Normal/EPP/ECP mode • 1 Serial ports (COMA), 1 VGA port , COMB on Board • 6 x USB 2.0/1.1 (2 x Rear, 4 xFront by cable) • 1 IrDA connector for IR/CIR • 1 Front Audio connector
Hardware Monitor	<ul style="list-style-type: none"> • CPU/Power/System Fan Revolution detect • CPU Overheat Warning • System Voltage Detect

to be continued.....

GA-8IGX Motherboard

On-Board VGA	<ul style="list-style-type: none">• Build in Intel 82845G Chipset
On-Board USB 2.0	<ul style="list-style-type: none">• Build in ICH4 Chipset
On-Board SC	<ul style="list-style-type: none">• ITE8712F SMART @I/O Chipset (SC header)
On-Board Sound	<ul style="list-style-type: none">• Realtek ALC650 CODEC• Line Out : 2 front speaker• Line In : 2 rear speaker(by s/w switch)• Mic In : center& woofer(by s/w switch)• SPDIF out : by s/w switch
On-Board LAN	<ul style="list-style-type: none">• Build in Kinnereth Chipset
PS/2 Connector	<ul style="list-style-type: none">• PS/2 Keyboard interface and PS/2 Mouse interface
BIOS	<ul style="list-style-type: none">• Licensed AWARD BIOS, 4M bit FWH• Supports Dual BIOS• Supports Multi Language• Supports Q-Flash• Supports Face-Wizard
Additional Features	<ul style="list-style-type: none">• External Modem wake up• PS/2 Keyboard password power on• PS/2 Mouse power on• STR(Suspend-To-RAM)• AC Recovery• USB KB/Mouse wake up from S3• Poly fuse for keyboard,USB,game port over-current protection• Supports @BIOS• Supports EasyTune 4
Jumper less	<ul style="list-style-type: none">• Over Voltage (DDR/AGP/CPU) by BIOS
Overclocking	<ul style="list-style-type: none">• Over Clock (CPU/DDR/AGP) by BIOS



Please set the CPU host frequency in accordance with your processor's specifications. We don't recommend you to set the system bus frequency over the CPU's specification because these specific bus frequencies are not the standard specifications for CPU, chipset and most of the peripherals. Whether your system can run under these specific bus frequencies properly will depend on your hardware configurations, including CPU, Chipsets,SDRAM,Cards....etc.

GA-8IGX Motherboard Layout

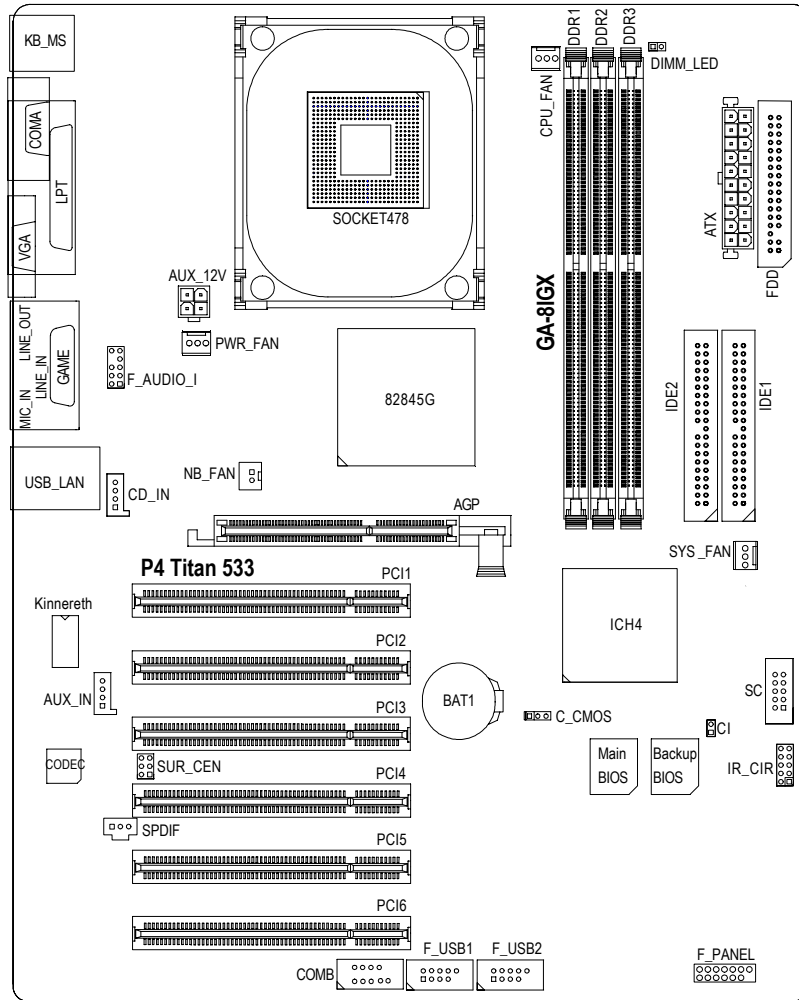

Chapter 2 Hardware Installation Process

To set up your computer, you must complete the following steps:

- Step 1- Install the Central Processing Unit (CPU)
- Step 2- Install memory modules
- Step 3- Install expansion cards
- Step 4- Connect ribbon cables, cabinet wires, and power supply
- Step 5- Setup BIOS software
- Step 6- Install supporting software tools

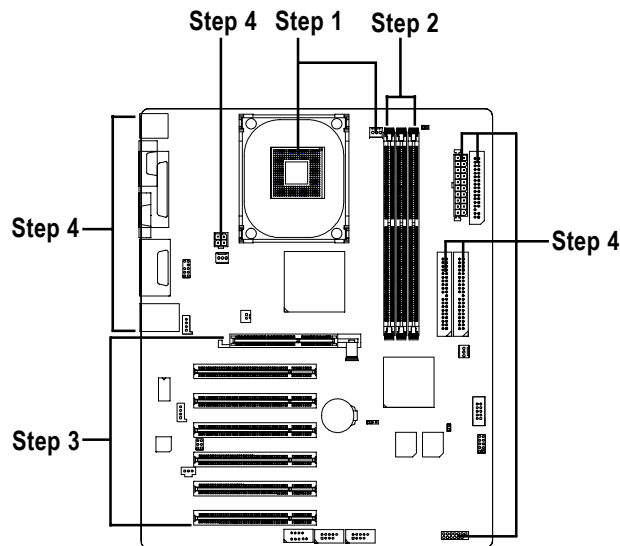

Step 1: Install the Central Processing Unit (CPU)

CPU Installation



CPU Top View

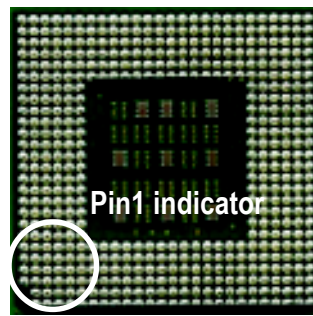

CPU Bottom View

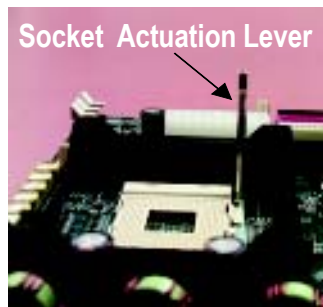

1. Pull up the CPU socket lever and up to 90-degree angle.
3. Press down the CPU socket lever and finish CPU installation.

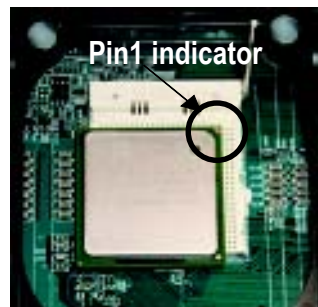

2. Locate Pin 1 in the socket and look for a (golden) cut edge on the CPU upper corner. Then insert the CPU into the socket.

- ⚠ Please make sure the CPU type is supported by the motherboard.
- ⚠ If you do not match the CPU socket Pin 1 and CPU cut edge well, it will cause improper installation. Please change the insert orientation.

CPU Heat Sink Installation



1. Hook one end of the cooler bracket to the CPU socket first.

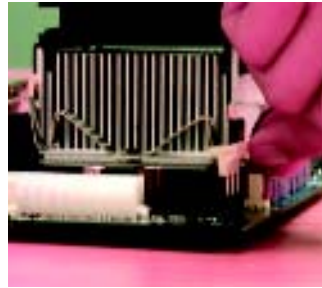

2. Hook the other end of the cooler bracket to the CPU socket.

- * Please use Intel approved cooling fan.
- * We recommend you to apply the thermal tape to provide better heat conduction between your CPU and heatsink.
(The CPU cooling fan might stick to the CPU due to the hardening of the thermal paste. During this condition if you try to remove the cooling fan, you might pull the processor out of the CPU socket along with the cooling fan, and might damage the processor. To avoid this from happening, we suggest you to either use thermal tape instead of thermal paste, or remove the cooling fan with extreme caution.)
- * Make sure the CPU fan power cable is plugged in to the CPU fan connector, this completes the installation.
- * Please refer to CPU heat sink user's manual for more detail installation procedure.

Step 2: Install memory modules

The motherboard has 3 dual inline memory module (DIMM) sockets, but it can only support a maximum of 4 banks of DDR memory. DDR slot 1 uses 2 banks, DDR slot 2&3 share the remaining 2 banks. Please refer to the following tables for possible memory configurations supported. The BIOS will automatically detects memory type and size. To install the memory module, just push it vertically into the DIMM Slot. The DIMM module can only fit in one direction due to the notch. Memory size can vary between sockets.

Total Memory Sizes With Unbuffered DDR DIMM

Devices used on DIMM	1 DIMM x 64 / x 72	2 DIMMs x 64 / x 72	3 DIMMs x 64 / x 72
64 Mbit (2Mx8x4 banks)	128 MBytes	256 MBytes	256 MBytes
64 Mbit (1Mx16x4 banks)	32 MBytes	64 MBytes	96 MBytes
128 Mbit(4Mx8x4 banks)	256 MBytes	512 MBytes	512 MBytes
128 Mbit(2Mx16x4 banks)	64 MBytes	128 MBytes	196 MBytes
256 Mbit(8Mx8x4 banks)	512 MBytes	1 GBytes	1 GBytes
256 Mbit(4Mx16x4 banks)	128 MBytes	256 MBytes	384 MBytes
512 Mbit(16Mx8x4 banks)	1 GBytes	2 GBytes	2 GBytes
512 Mbit(8Mx16x4 banks)	256 MBytes	512 MBytes	768 MBytes

Notes: Double-sided x16 DDR memory devices are not support by Intel 845E/G chipset.

DDR1	DDR2	DDR3
S	S	S
D	S	S
D	D	X
D	X	D
S	D	X
S	X	D

D:Double Sided DIMM S:Single Sided DIMM

X:Not Use



DDR



1. The DIMM slot has a notch, so the DIMM memory module can only fit in one direction.
 2. Insert the DIMM memory module vertically into the DIMM slot. Then push it down.
 3. Close the plastic clip at both edges of the DIMM slots to lock the DIMM module.
- Reverse the installation steps when you wish to remove the DIMM module.

DDR Introduction

Established on the existing SDRAM industry infrastructure, DDR (Double Data Rate) memory is a high performance and cost-effective solution that allows easy adoption for memory vendors, OEMs and system integrators.

DDR memory is a sensible evolutionary solution for the PC industry that builds on the existing SDRAM infrastructure, yet makes awesome advances in solving the system performance bottleneck by doubling the memory bandwidth. DDR SDRAM will offer a superior solution and migration path from existing SDRAM designs due to its availability, pricing and overall market support. PC2100 DDR memory (DDR266) doubles the data rate through reading and writing at both the rising and falling edge of the clock, achieving data bandwidth 2X greater than PC133 when running with the same DRAM clock frequency. With peak bandwidth of 2.1GB per second, DDR memory enables system OEMs to build high performance and low latency DRAM subsystems that are suitable for servers, workstations, high-end PC's and value desktop SMA systems. With a core voltage of only 2.5 Volts compared to conventional SDRAM's 3.3 volts, DDR memory is a compelling solution for small form factor desktops and notebook applications.

- When STR/DIMM LED is ON, you do not install / remove DDR from socket.
- Please note that the DIMM module can only fit in one direction due to the two notches. Wrong orientation will cause improper installation. Please change the insert orientation.

Step 3: Install expansion cards

1. Read the related expansion card's instruction document before install the expansion card into the computer.
2. Remove your computer's chassis cover, screws and slot bracket from the computer.
3. Press the expansion card firmly into expansion slot in motherboard.
4. Be sure the metal contacts on the card are indeed seated in the slot.
5. Replace the screw to secure the slot bracket of the expansion card.
6. Replace your computer's chassis cover.
7. Power on the computer, if necessary, setup BIOS utility of expansion card from BIOS.
8. Install related driver from the operating system.

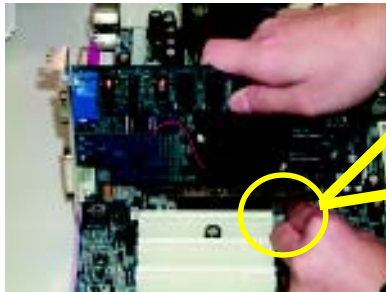

AGP Card

Please carefully pull out the small white-drawable bar at the end of the AGP slot when you try to install/ Uninstall the AGP card. Please align the AGP card to the onboard AGP slot and press firmly down on the slot . Make sure your AGP card is locked by the small white- drawable bar.

Step 4: Connect ribbon cables, cabinet wires, and power supply

Step4-1: I/O Back Panel Introduction

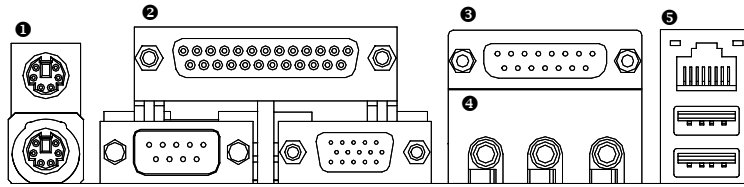

1 PS/2 Keyboard and PS/2 Mouse Connector

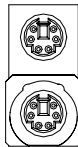

PS/2 Mouse Connector
(6 pin Female)

PS/2 Keyboard Connector
(6 pin Female)

➤ This connector supports standard PS/2 keyboard and PS/2 mouse.

2 Parallel Port and VGA Port/COMA Port

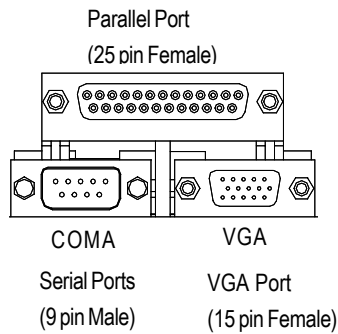

Parallel Port
(25 pin Female)

COMA

VGA

Serial Ports
(9 pin Male)

VGA Port
(15 pin Female)

➤ This mainboard supports 1 standard COM port, 1 VGA port and 1 LPT port. Device like printer can be connected to LPT port ; mouse and modem etc can be connected to COM port.

③ **Game /MIDI Ports**

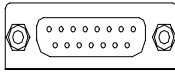

Joystick/ MIDI (15 pin Female)

➤ This connector supports joystick, MIDI keyboard and other relate audio devices.

④ **Audio Connectors**

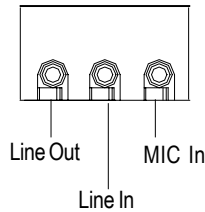

➤ After install onboard audio driver, you may connect speaker to Line Out jack, micro phone to MIC In jack. Device like CD-ROM , walkman etc can be connected to Line-In jack.

⑤ **USB/LAN Connector**

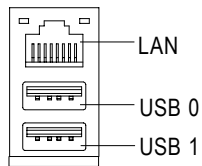

➤ Before you connect your device(s) into USB connector(s), please make sure your device(s) such as USB keyboard, mouse, scanner, zip,speaker..etc. Have a standard USB interface. Also make sure your OS (Win 95 with USB supplement, Win98, Windows 2000, Windows ME, Win NT with SP 6) supports USB controller. If your OS does not support USB controller, please contact OS vendor for possible patch or driver upgrade. For more information please contact your OS or device(s) vendors.

Step4-2: Connectors Introduction

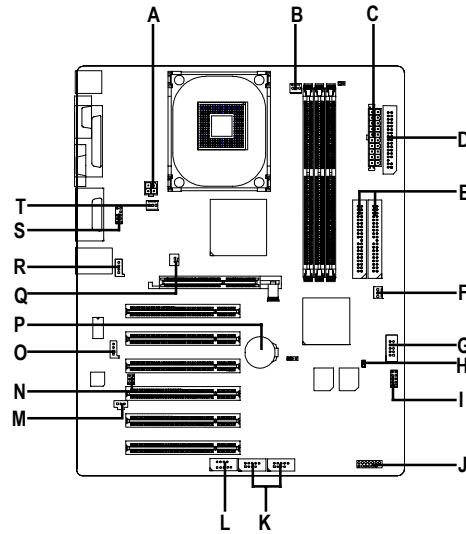

A) AUX_12V	K) F_USB1/F_USB2
B) CPU_FAN	L) COMB
C) ATX	M) SPDIF
D) FDD	N) SUR_CEN
E) IDE1/IDE2	O) AUX_IN
F) SYS_FAN	P) BAT1
G) SC	Q) NB_FAN
H) CI	R) CD_IN
I) IR_CIR	S) F_AUDIO_I
J) F_PANEL	T) PWR_FAN

A) AUX_12V (+12V Power Connector)

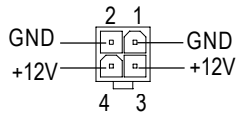

➤ This connector (ATX +12V) supplies the CPU operation voltage (V_{core}).
If this " ATX+ 12V connector" is not connected, system cannot boot.

B) CPU_FAN (CPU FAN Connector)

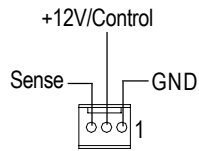

➤ Please note, a proper installation of the CPU cooler is essential to prevent the CPU from running under abnormal condition or damaged by overheating. The CPU fan connector supports Max. current up to 600 mA.

F) SYS_FAN (System FAN Connector)

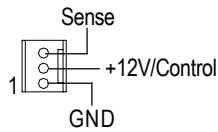

D) FDD (Floppy Connector)

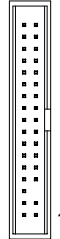

T) PWR_FAN (POWER FAN Connector)

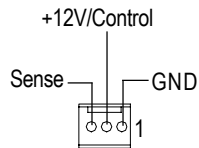

H) CI (CASE OPEN)

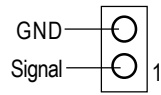

- This 2 pin connector allows your system to enable or disable the system alarm if the system case begins to remove.

E) IDE1/IDE2 [IDE1 / IDE2 Connector(Primary/Secondary)]

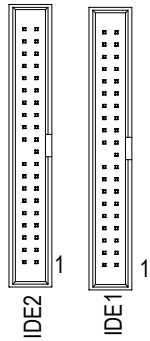

- Important Notice:
Please connect first harddisk to IDE1 and connect CDROM to IDE2.

M) SPDIF (SPDIF)

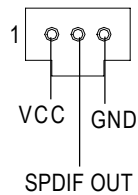

- The SPDIF output is capable of providing digital audio to external speakers or compressed AC3 data to an external Dolby Digital Decoder. Use this feature only when your stereo system has digital output function.

R) CD_IN (CD Audio Line In)

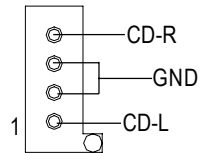

O) AUX_IN (AUX In Connector)

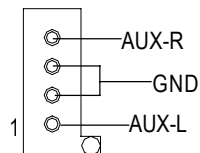

S) F_AUDIO_I (Front Audio)

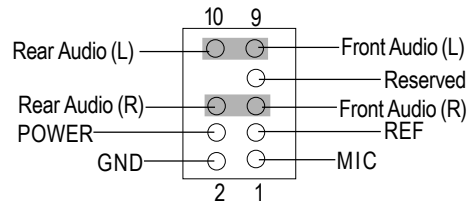

➤If you want to use "Front Audio" connector, you must move 5-6, 9-10 Jumper. In order to utilize the front audio header, your chassis must have front audio connector. Also please make sure the pin assignment on the cable is the same as the pin assignment on the MB header. To find out if the chassis you are buying support front audio connector, please contact your dealer.

N) SUR_CEN

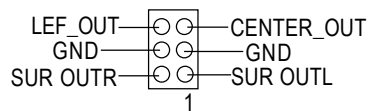

G) SC(Smart Card Interface)

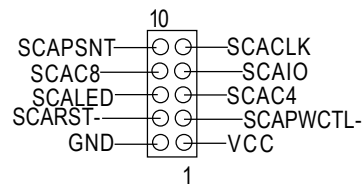

C) ATX (ATX Power)

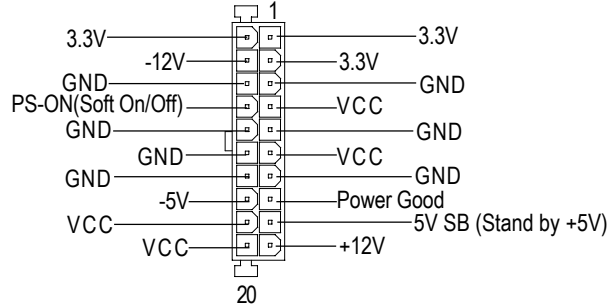

➤ AC power cord should only be connected to your power supply unit after ATX power cable and other related devices are firmly connected to the mainboard.

K) F_USB1/F_USB2 (Front USB Connector)

(F_USB1 & F_USB2 connectors in yellow are for USB 2.0)

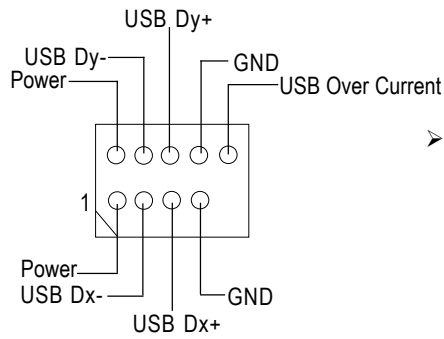

➤ Be careful with the polarity of the front panel USB connector. Check the pin assignment while you connect the front panel USB cable. Please contact your nearest dealer for optional front panel USB cable.

L) COMB (COM B Connector)(White)

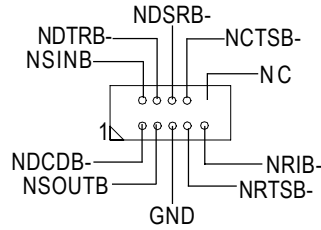

I) IR_CIR (IR/CIR)

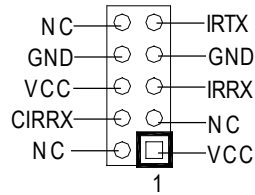

- Make sure the pin 1 on the IR device is aligning with pin one the connector. To enable the IR/CIR function on the board, you are required to purchase an option IR/CIR module. For detail information please contact your authorized Giga-Byte distributor.
- To use IR function only, please connect IR module to Pin1 to Pin5.

P) BAT1 (Battery)

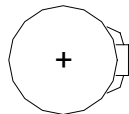

CAUTION

- ❖ Danger of explosion if battery is incorrectly replaced.
- ❖ Replace only with the same or equivalent type recommended by the manufacturer.
- ❖ Dispose of used batteries according to the manufacturer's instructions.

J) F_PANEL (2x7 pins jumper)

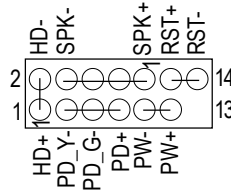

HD (IDE Hard Disk Active LED)	Pin 1: LED anode(+) Pin 2: LED cathode(-)
SPK (Speaker Connector)	Pin 1: VCC(+) Pin 2- Pin 3: NC Pin 4: Data(-)
RST (Reset Switch)	Open: Normal Operation Close: Reset Hardware System
PD+/PD_G-/PD_Y-(Power LED)	Pin 1: LED anode(+) Pin 2: LED cathode(-) Pin 3: LED cathode(-)
PW (Soft Power Connector)	Open: Normal Operation Close: Power On/Off

- Please connect the power LED, PC speaker, reset switch and power switch etc of your chassis front panel to the F_PANEL connector according to the pin assignment above.

Q) NB_FAN (Chip Fan)

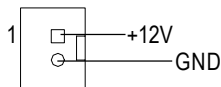

- Please note:
If installed wrong direction, the Chip Fan will not work. Sometimes will damage the Chip Fan.
(Usually black cable is GND)

Step4-3: Jumper Introduction

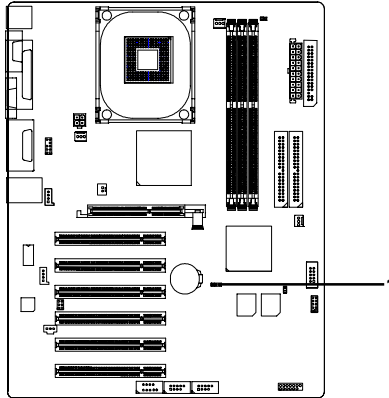

1) C_CMOS

1) C_CMOS (Clear CMOS Function)#

1  1-2 close: Clear CMOS

1  2-3 close: Normal

➤ Please note: You may clear the CMOS data to its default values by this jumper.

"#" Default doesn't include the "Shunter" to prevent from improper use this jumper. To clear CMOS, temporarily short 1-2 pin.

Chapter 3 BIOS Setup

BIOS Setup is an overview of the BIOS Setup Program. The program that allows users to modify the basic system configuration. This type of information is stored in battery-backed CMOS RAM so that it retains the Setup information when the power is turned off.

ENTERING SETUP

Powering ON the computer and pressing immediately will allow you to enter Setup. If you require more advanced BIOS settings, please go to "Advanced BIOS" setting menu. To enter Advanced BIOS setting menu, press "Ctrl+F1" key on the BIOS screen.

CONTROL KEYS

<↑>	Move to previous item
<↓>	Move to next item
<←>	Move to the item in the left hand
<→>	Move to the item in the right hand
<Esc>	Main Menu - Quit and not save changes into CMOS Status Page Setup Menu and Option Page Setup Menu - Exit current page and return to Main Menu
<+/PgUp>	Increase the numeric value or make changes
<-/PgDn>	Decrease the numeric value or make changes
<F1>	General help, only for Status Page Setup Menu and Option Page Setup Menu
<F2>	Reserved
<F3>	Reserved
<F4>	Reserved
<F5>	Restore the previous CMOS value from CMOS, only for Option Page Setup Menu
<F6>	Load the file-safe default CMOS value from BIOS default table
<F7>	Load the Optimized Defaults
<F8>	Dual BIOS/Q-Flash function
<F9>	Reserved
<F10>	Save all the CMOS changes, only for Main Menu

GETTING HELP

Main Menu

The on-line description of the highlighted setup function is displayed at the bottom of the screen.

Status Page Setup Menu / Option Page Setup Menu

Press F1 to pop up a small help window that describes the appropriate keys to use and the possible selections for the highlighted item. To exit the Help Window press <Esc>.

The Main Menu (For example: BIOS Ver. : F1)

Once you enter Award BIOS CMOS Setup Utility, the Main Menu (Figure 1) will appear on the screen. The Main Menu allows you to select from eight setup functions and two exit choices. Use arrow keys to select among the items and press <Enter> to accept or enter the sub-menu.

CMOS Setup Utility-Copyright (C) 1984-2002 Award Software

▶Standard CMOS Features	Select Language
▶Advanced BIOS Features	Load Fail-Safe Defaults
▶Integrated Peripherals	Load Optimized Defaults
▶Power Management Setup	Set Supervisor Password
▶PnP/PCI Configurations	Set User Password
▶PC Health Status	Save & Exit Setup
▶Frequency/Voltage Control	Exit Without Saving
Top Performance	
ESC:Quit	F3: Select Language
F8: Dual BIOS/Q-Flash	F10:Save & Exit Setup
Time, Date, Hard Disk Type...	

Figure 1: Main Menu

- **Standard CMOS Features**
This setup page includes all the items in standard compatible BIOS.
- **Advanced BIOS Features**
This setup page includes all the items of Award special enhanced features.

- **Integrated Peripherals**
This setup page includes all onboard peripherals.
- **Power Management Setup**
This setup page includes all the items of Green function features.
- **PnP/PCI Configurations**
This setup page includes all the configurations of PCI & PnP ISA resources.
- **PC Health Status**
This setup page is the System auto detect Temperature, voltage, fan, speed.
- **Frequency/Voltage Control**
This setup page is control CPU's clock and frequency ratio.
- **Top Performance**
If you wish to maximize the performance of your system, set "Top Performance" as "Enabled".
- **Select Language**
This setup page is select multi language.
- **Load Fail-Safe Defaults**
Fail-Safe Defaults indicates the value of the system parameters which the system would be in safe configuration.
- **Load Optimized Defaults**
Optimized Defaults indicates the value of the system parameters which the system would be in best performance configuration.
- **Set Supervisor password**
Change, set, or disable password. It allows you to limit access to the system and Setup, or just to Setup.
- **Set User password**
Change, set, or disable password. It allows you to limit access to the system.
- **Save & Exit Setup**
Save CMOS value settings to CMOS and exit setup.
- **Exit Without Saving**
Abandon all CMOS value changes and exit setup.

Standard CMOS Features

CMOS Setup Utility-Copyright (C) 1984-2002 Award Software

Standard CMOS Features

Date (mm:dd:yy)	Mon, Feb 21 2000	Item Help
Time (hh:mm:ss)	22:31:24	Menu Level ►
►IDE Primary Master	None	Change the day, month, year
►IDE Primary Slave	None	<Week>
►IDE Secondary Master	None	Sun. to Sat.
►IDE Secondary Slave	None	<Month>
Drive A	1.44M, 3.5 in.	Jan. to Dec.
Drive B	None	<Day>
Floppy 3 Mode Support	Disabled	1 to 31 (or maximum allowed in the month)
Halt On	All, But Keyboard	<Year>
Base Memory	640K	1999 to 2098
Extended Memory	130048K	
Total Memory	131072K	
↑↓→←: Move Enter:Select +/-/PU/PD:Value F10:Save ESC:Exit F1:General Help F3: Language F5:Previous Values F6:Fail-Safe Defaults F7:Optimized Defaults		

Figure 2: Standard CMOS Features

☞ Date

The date format is <week>, <month>, <day>, <year>.

- Week The week, from Sun to Sat, determined by the BIOS and is display only
- Month The month, Jan. Through Dec.
- Day The day, from 1 to 31 (or the maximum allowed in the month)
- Year The year, from 1999 through 2098

☞ **Time**

The times format in <hour> <minute> <second>. The time is calculated base on the 24-hour military-time clock. For example, 1 p.m. is 13:00:00.

☞ **IDE Primary Master, Slave / IDE Secondary Master, Slave**

The category identifies the types of hard disk from drive C to F that has been installed in the computer. There are two types: auto type, and manual type. Manual type is user-definable; Auto type which will automatically detect HDD type.

Note that the specifications of your drive must match with the drive table. The hard disk will not work properly if you enter improper information for this category.

If you select User Type, related information will be asked to enter to the following items. Enter the information directly from the keyboard and press <Enter>. Such information should be provided in the documentation form your hard disk vendor or the system manufacturer.

- ▶▶ CYLS. Number of cylinders
- ▶▶ HEADS Number of heads
- ▶▶ PRECOMP Write precomp
- ▶▶ LANDZONE Landing zone
- ▶▶ SECTORS Number of sectors

If a hard disk has not been installed select NONE and press <Enter>.

☞ **Drive A / Drive B**

The category identifies the types of floppy disk drive A or drive B that has been installed in the computer.

- ▶▶ None No floppy drive installed
- ▶▶ 360K, 5.25 in. 5.25 inch PC-type standard drive; 360K byte capacity.
- ▶▶ 1.2M, 5.25 in. 5.25 inch AT-type high-density drive; 1.2M byte capacity
(3.5 inch when 3 Mode is Enabled).
- ▶▶ 720K, 3.5 in. 3.5 inch double-sided drive; 720K byte capacity
- ▶▶ 1.44M, 3.5 in. 3.5 inch double-sided drive; 1.44M byte capacity.
- ▶▶ 2.88M, 3.5 in. 3.5 inch double-sided drive; 2.88M byte capacity.

☞ Floppy 3 Mode Support (for Japan Area)

- ▶▶ Disabled Normal Floppy Drive. (Default value)
- ▶▶ Drive A Drive A is 3 mode Floppy Drive.
- ▶▶ Drive B Drive B is 3 mode Floppy Drive.
- ▶▶ Both Drive A & B are 3 mode Floppy Drives.

☞ Halt on

The category determines whether the computer will stop if an error is detected during power up.

- ▶▶ NO Errors The system boot will not stop for any error that may be detected and you will be prompted.
- ▶▶ All Errors Whenever the BIOS detects a non-fatal error the system will be stopped.
- ▶▶ All, But Keyboard The system boot will not stop for a keyboard error; it will stop for all other errors. (Default value)
- ▶▶ All, But Diskette The system boot will not stop for a disk error; it will stop for all other errors.
- ▶▶ All, But Disk/Key The system boot will not stop for a keyboard or disk error; it will stop for all other errors.

☞ Memory

The category is display-only which is determined by POST (Power On Self Test) of the BIOS.

Base Memory

The POST of the BIOS will determine the amount of base (or conventional) memory installed in the system.

The value of the base memory is typically 512 K for systems with 512 K memory installed on the motherboard, or 640 K for systems with 640 K or more memory installed on the motherboard.

Extended Memory

The BIOS determines how much extended memory is present during the POST.

This is the amount of memory located above 1 MB in the CPU's memory address map.

Advanced BIOS Features

CMOS Setup Utility-Copyright (C) 1984-2002 Award Software

Advanced BIOS Features

First Boot Device	Floppy	Item Help
Second Boot Device	HDD-0	Menu Level ►
Third Boot Device	CDROM	
Boot Up Floppy Seek	Disabled	
Init Display First	Onboard/AGP	
Graphics Memory Size	128MB	
Graphics Share Memory	8MB	
↑↓→←: Move Enter:Select +/-/PU/PD:Value F10:Save ESC:Exit F1:General Help F3: Language F5:Previous Values F6:Fail-Safe Defaults F7:Optimized Defaults		

Figure 3: Advanced BIOS Features

☞ First / Second / Third Boot Device

- ☞ Floppy Select your boot device priority by Floppy.
- ☞ LS120 Select your boot device priority by LS120.
- ☞ HDD-0~3 Select your boot device priority by HDD-0~3.
- ☞ SCSI Select your boot device priority by SCSI.
- ☞ CDROM Select your boot device priority by CDROM.
- ☞ ZIP Select your boot device priority by ZIP.
- ☞ USB-FDD Select your boot device priority by USB-FDD.
- ☞ USB-ZIP Select your boot device priority by USB-ZIP.
- ☞ USB-CDROM Select your boot device priority by USB-CDROM.
- ☞ USB-HDD Select your boot device priority by USB-HDD.
- ☞ LAN Select your boot device priority by LAN.
- ☞ Disabled Select your boot device priority by Disabled.

☞ **Boot Up Floppy Seek**

During POST, BIOS will determine the floppy disk drive installed is 40 or 80 tracks. 360 K type is 40 tracks 720 K, 1.2 M and 1.44 M are all 80 tracks.

- ▶▶ Enabled BIOS searches for floppy disk drive to determine it is 40 or 80 tracks. Note that BIOS can not tell from 720 K, 1.2 M or 1.44 M drive type as they are all 80tracks.
- ▶▶ Disabled BIOS will not search for the type of floppy disk drive by track number. Note that there will not be any warning message if the drive installed is 360 K. (Default value)

☞ **Init Display First**

- ▶▶ Onboard/AGP Set Init Display First to onboard/AGP. (Default value)
- ▶▶ PCI Set Init Display First to PCI.

☞ **Graphics Memory Size**

- ▶▶ 128MB Set Graphics Memory Size to 128MB. (Default value)
- ▶▶ 64MB Set Graphics Memory Size to 64MB.
- ▶▶ Disabled Disable this function.

☞ **Graphics Share Memory**

- ▶▶ 8MB Set Graphics Share Memory to 8MB. (Default value)
- ▶▶ 1MB Set Graphics Share Memory to 1MB.

Integrated Peripherals

CMOS Setup Utility-Copyright (C) 1984-2002 Award Software

Integrated Peripherals

		Item Help
On-Chip Primary PCI IDE	Enabled	
On-Chip Secondary PCI IDE	Enabled	Menu Level ►
IDE1 Conductor Cable	Auto	If a hard disk
IDE2 Conductor Cable	Auto	controller card is
USB Controller	Enabled	used, set at Disable
USB Keyboard Support	Disabled	
USB Mouse Support	Disabled	[Enabled]
AC97 Audio	Auto	Enable onboard IDE
Onboard LAN Chip	Enabled	PORT
Onboard LAN Boot ROM	Disabled	
Onboard Serial Port 1	3F8/IRQ4	[Disabled]
Onboard Serial Port 2	2F8/IRQ3	Disable onboard IDE
UART Mode Select	Normal	PORT
x UR2 Duplex Mode	Half	
Onboard Parallel Port	378/IRQ7	
Parallel Port Mode	SPP	
x ECP Mode Use DMA	3	
Game Port Address	201	
Midi Port Address	330	
Midi Port IRQ	10	
CIR Port Address	Disabled	
x CIR Port IRQ	11	
↑↓→←: Move Enter:Select +/-/PU/PD:Value F10:Save ESC:Exit F1:General Help F3: Language F5:Previous Values F6:Fail-Safe Defaults F7:Optimized Defaults		

Figure 4: Integrated Peripherals

☞ On-Chip Primary PCI IDE

- ▶▶ Enabled Enable onboard 1st channel IDE port. (Default value)
- ▶▶ Disabled Disable onboard 1st channel IDE port.

☞ On-Chip Secondary PCI IDE

- ▶▶ Enabled Enable onboard 2nd channel IDE port. (Default value)
- ▶▶ Disabled Disable onboard 2nd channel IDE port.

☞ IDE1 Conductor Cable

- ▶▶ Auto Will be automatically detected by BIOS. (Default Value)
- ▶▶ ATA66/100 Set IDE1 Conductor Cable to ATA66/100 (Please make sure your IDE device and cable is compatible with ATA66/100).
- ▶▶ ATA33 Set IDE1 Conductor Cable to ATA33 (Please make sure your IDE device and cable is compatible with ATA33).

☞ IDE2 Conductor Cable

- ▶▶ Auto Will be automatically detected by BIOS. (Default Value)
- ▶▶ ATA66/100 Set IDE2 Conductor Cable to ATA66/100 (Please make sure your IDE device and cable is compatible with ATA66/100).
- ▶▶ ATA33 Set IDE2 Conductor Cable to ATA33 (Please make sure your IDE device and cable is compatible with ATA33).

☞ USB Controller

- ▶▶ Enabled Enable USB Controller. (Default value)
- ▶▶ Disabled Disable USB Controller.

☞ USB Keyboard Support

- ▶▶ Enabled Enable USB Keyboard Support.
- ▶▶ Disabled Disable USB Keyboard Support. (Default value)

☞ **USB Mouse Support**

- ▶▶ Enabled Enable USB Mouse Support.
- ▶▶ Disabled Disable USB Mouse Support. (Default value)

☞ **AC97 Audio**

- ▶▶ Auto Enable onboard AC'97 audio function. (Default Value)
- ▶▶ Disabled Disable this function.

☞ **Onboard LAN Chip**

- ▶▶ Enabled Enable Onboard LAN Chip function. (Default value)
- ▶▶ Disabled Disable this function.

☞ **Onboard LAN Boot ROM**

- ▶▶ Enabled Enable Onboard LAN Boot ROM function. (Default value)
- ▶▶ Disabled Disable this function.

☞ **Onboard Serial Port 1**

- ▶▶ Auto BIOS will automatically setup the port 1 address.
- ▶▶ 3F8/IRQ4 Enable onboard Serial port 1 and address is 3F8. (Default value)
- ▶▶ 2F8/IRQ3 Enable onboard Serial port 1 and address is 2F8.
- ▶▶ 3E8/IRQ4 Enable onboard Serial port 1 and address is 3E8.
- ▶▶ 2E8/IRQ3 Enable onboard Serial port 1 and address is 2E8.
- ▶▶ Disabled Disable onboard Serial port 1.

☞ **Onboard Serial Port 2**

- ▶▶ Auto BIOS will automatically setup the port 2 address.
- ▶▶ 3F8/IRQ4 Enable onboard Serial port 2 and address is 3F8.
- ▶▶ 2F8/IRQ3 Enable onboard Serial port 2 and address is 2F8. (Default value)
- ▶▶ 3E8/IRQ4 Enable onboard Serial port 2 and address is 3E8.
- ▶▶ 2E8/IRQ3 Enable onboard Serial port 2 and address is 2E8.
- ▶▶ Disabled Disable onboard Serial port 2.

☞ UART Mode Select

(This item allows you to determine which Infra Red(IR) function of Onboard I/O chip)

- ▶▶ ASKIR Set onboard I/O chip UART to ASKIR Mode.
- ▶▶ IrDA Set onboard I/O chip UART to IrDA Mode.
- ▶▶ Normal Set onboard I/O chip UART to Normal Mode. (Default Value)

☞ UR2 Duplex Mode

- ▶▶ Half IR Function Duplex Half. (Default Value)
- ▶▶ Full IR Function Duplex Full.

☞ Onboard Parallel port

- ▶▶ 378/IRQ7 Enable onboard LPT port and address is 378/IRQ7. (Default Value)
- ▶▶ 278/IRQ5 Enable onboard LPT port and address is 278/IRQ5.
- ▶▶ Disabled Disable onboard LPT port.
- ▶▶ 3BC/IRQ7 Enable onboard LPT port and address is 3BC/IRQ7.

☞ Parallel Port Mode

- ▶▶ SPP Using Parallel port as Standard Parallel Port. (Default Value)
- ▶▶ EPP Using Parallel port as Enhanced Parallel Port.
- ▶▶ ECP Using Parallel port as Extended Capabilities Port.
- ▶▶ ECP+EPP Using Parallel port as ECP & EPP mode.

☞ ECP Mode Use DMA

- ▶▶ 3 Set ECP Mode Use DMA to 3. (Default Value)
- ▶▶ 1 Set ECP Mode Use DMA to 1.

☞ Game Port Address

- ▶▶ 201 Set Game Port Address to 201. (Default Value)
- ▶▶ 209 Set Game Port Address to 209.
- ▶▶ Disabled Disable this function.

☞ Midi Port Address

- ▶▶ 290 Set Midi Port Address to 290.

- ▶▶ 300 Set Midi Port Address to 300.
- ▶▶ 330 Set Midi Port Address to 330.(Default Value)
- ▶▶ Disabled Disable this function.

☞ **Midi Port IRQ**

- ▶▶ 5 Set Midi Port IRQ to 5.
- ▶▶ 10 Set Midi Port IRQ to 10. (Default Value)

☞ **CIR Port Address**

- ▶▶ 310 Set CIR Port Address to 310.
- ▶▶ 320 Set CIR Port Address to 320.
- ▶▶ Disabled Disable this function. (Default Value)

☞ **CIR Port IRQ**

- ▶▶ 5 Set CIR Port IRQ to 5.
- ▶▶ 11 Set CIR Port IRQ to 11. (Default Value)

Power Management Setup

CMOS Setup Utility-Copyright (C) 1984-2002 Award Software

Power Management Setup

ACPI Suspend Type	S1(POS)	Item Help
Soft-Off by PWR_BTTN	Instant-Off	Menu Level ►
PME Event Wake Up	Enabled	[S1]
Resume by Alarm	Disabled	Set suspend type to
x Date (of Month) Alarm	Everyday	Power On Suspend under
x Time (hh:nn:ss)	0 0 0	ACPI OS
Power On By Mouse	Disabled	
Power On By Keyboard	Disabled	[S3]
x KB Power ON Password	Enter	Set suspend type to
AC Back Function	Soft-Off	Suspend to RAM under
		ACPI OS
↑↓→←: Move Enter:Select +/-/PU/PD:Value F10:Save ESC:Exit F1:General Help F3: Language F5:Previous Values F6:Fail-Safe Defaults F7:Optimized Defaults		

Figure 5: Power Management Setup

☞ ACPI Suspend Type

- ▶▶ S1(POS) Set ACPI suspend type to S1. (Default Value)
- ▶▶ S3(STR) Set ACPI suspend type to S3.

☞ Soft-off by PWR_BTTN

- ▶▶ Instant-off Press power button then Power off instantly. (Default value)
- ▶▶ Delay 4 Sec. Press power button 4 sec to Power off. Enter suspend if button is pressed less than 4 sec.

☞ **PME Event Wake Up**

- ▶▶ Disabled Disable this function.
- ▶▶ Enabled Enable PME Event Wake up. (Default Value)

☞ **Resume by Alarm**

You can set "Resume by Alarm" item to enabled and key in Data/time to power on system.

- ▶▶ Disabled Disable this function. (Default Value)
- ▶▶ Enabled Enable alarm function to POWER ON system.

If RTC Alarm Lead To Power On is Enabled.

Date (of Month) Alarm : Everyday, 1~31

Time (hh: mm: ss) Alarm : (0~23) : (0~59) : (0~59)

☞ **Power On By Mouse**

- ▶▶ Disabled Disabled this function. (Default value)
- ▶▶ Mouse Click Double click on PS/2 mouse left button.

☞ **Power On By Keyboard**

- ▶▶ Password Enter from 1 to 5 characters to set the Keyboard Power On Password.
- ▶▶ Disabled Disabled this function. (Default value)
- ▶▶ Keyboard 98 If your keyboard have "POWER Key" button, you can press the key to power on your system.

☞ **KB Power ON Password**

- ▶▶ Enter Input password (from 1 to 5 characters) and press Enter to set the Key board Power On Password.

☞ **AC Back Function**

- ▶▶ Memory System power on depends on the status before AC lost.
- ▶▶ Soft-Off Always in Off state when AC back. (Default value)
- ▶▶ Full-On Always power on the system when AC back.

PnP/PCI Configurations

CMOS Setup Utility-Copyright (C) 1984-2002 Award Software

PnP/PCI Configurations

PCI 1/PCI 5 IRQ Assignment	Auto	Item Help
PCI 2/PCI 6 IRQ Assignment	Auto	Menu Level ►
PCI 3 IRQ Assignment	Auto	
PCI 4 IRQ Assignment	Auto	
↑↓→←: Move Enter:Select +/-/PU/PD:Value F10:Save ESC:Exit F1:General Help F3: Language F5:Previous Values F6:Fail-Safe Defaults F7:Optimized Defaults		

Figure 6: PnP/PCI Configurations

☞ PCI 1/PCI 5 IRQ Assignment

- ▶▶ Auto Auto assign IRQ to PCI 1/PCI 5. (Default value)
- ▶▶ 3,4,5,7,9,10,11,12,14,15 Set IRQ 3,4,5,7,9,10,11,12,14,15 to PCI 1/PCI 5.

☞ PCI 2/PCI 6 IRQ Assignment

- ▶▶ Auto Auto assign IRQ to PCI 2/PCI 6. (Default value)
- ▶▶ 3,4,5,7,9,10,11,12,14,15 Set IRQ 3,4,5,7,9,10,11,12,14,15 to PCI 2/PCI 6.

☞ PCI 3 IRQ Assignment

- ▶▶ Auto Auto assign IRQ to PCI 3. (Default value)
- ▶▶ 3,4,5,7,9,10,11,12,14,15 Set IRQ 3,4,5,7,9,10,11,12,14,15 to PCI 3.

☞ PCI 4 IRQ Assignment

- ▶▶ Auto Auto assign IRQ to PCI 4. (Default value)
- ▶▶ 3,4,5,7,9,10,11,12,14,15 Set IRQ 3,4,5,7,9,10,11,12,14,15 to PCI 4.

PC Health Status

CMOS Setup Utility-Copyright (C) 1984-2002 Award Software

PC Health Status

Reset Case Open Status	Disabled	Item Help
Case Opened	No	Menu Level ►
VCORE	1.730V	
+1.5V	1.504V	
+3.3V	3.360V	
+5V	5.053V	
+12V	11.840V	
Current CPU Temperature	35°C/95°F	
Current CPU FAN Speed	6490 RPM	
Current POWER FAN Speed	0 RPM	
Current SYSTEM FAN Speed	0 RPM	
CPU Warning Temperature	Disabled	
CPU FAN Fail Warning	Disabled	
POWER FAN Fail Waring	Disabled	
SYSTEM FAN Fail Warning	Disabled	
↑↓→←: Move Enter:Select +/-/PU/PD:Value F10:Save ESC:Exit F1:General Help F3: Language F5:Previous Values F6:Fail-Safe Defaults F7:Optimized Defaults		

Figure 7: PC Health Status

Reset Case Open Status

Case Opened

If the case is closed, "Case Opened" will show "No".

If the case have been opened, "Case Opened" will show "Yes".

If you want to reset "Case Opened" value, set "Reset Case Open Status" to "Enabled" and save CMOS, your computer will restart.

Current Voltage (V) VCORE / +1.5V / +3.3V / +5V / +12V

►► Detect system's voltage status automatically.

☞ Current CPU Temperature

- ▶▶ Detect CPU Temp. automatically.

☞ Current CPU/POWER/SYSTEM FAN Speed (RPM)

- ▶▶ Detect CPU/POWER/SYSTEM Fan speed status automatically.

☞ CPU Warning Temperature

- ▶▶ 60°C / 140°F Monitor CPU Temp. at 60°C / 140°F.
- ▶▶ 70°C / 158°F Monitor CPU Temp. at 70°C / 158°F.
- ▶▶ 80°C / 176°F Monitor CPU Temp. at 80°C / 176°F.
- ▶▶ 90°C / 194°F Monitor CPU Temp. at 90°C / 194°F.
- ▶▶ Disabled Disable this function.(Default value)

☞ CPU FAN Fail Warning

- ▶▶ Disabled Fan Warning Function Disable. (Default value)
- ▶▶ Enabled Fan Warning Function Enable.

☞ POWER FAN Fail Warning

- ▶▶ Disabled Fan Warning Function Disable. (Default value)
- ▶▶ Enabled Fan Warning Function Enable.

☞ SYSTEM FAN Fail Warning

- ▶▶ Disabled Fan Warning Function Disable. (Default value)
- ▶▶ Enabled Fan Warning Function Enable.

Frequency/Voltage Control

CMOS Setup Utility-Copyright (C) 1984-2002 Award Software

Frequency/Voltage Control

CPU Clock Ratio	15X	Item Help
CPU Host Clock Control	Disabled	Menu Level ►
x CPU Host Frequency (Mhz)	100	
x PCI/AGP Divider	Disabled	
Host/DRAM Clock ratio	Auto	
Memory Frequency (Mhz)	266	
PCI/AGP Frequency (Mhz)	33/66	
DIMM OverVoltage Control	Normal	
AGP OverVoltage Control	Normal	
CPU Voltage Control	Normal	
Normal CPU Vcore	1.750V	
↑↓→←: Move Enter:Select +/-/PU/PD:Value F10:Save ESC:Exit F1:General Help F3: Language F5:Previous Values F6:Fail-Safe Defaults F7:Optimized Defaults		

Figure 8: Frequency/Voltage Control

☞ CPU Clock Ratio

Set CPU Ratio if CPU Ratio is unlocked.

▶▶ 10X~24X It's depends on CPU Clock Ratio.

☞ CPU Host Clock Control

Note: If system hangs up before enter CMOS setup utility, wait for 20 sec for times out reboot . When time out occur, system will reset and run at CPU default Host clock at next boot.

▶▶ Disable Disable CPU Host Clock Control.(Default value)

▶▶ Enable Enable CPU Host Clock Control.

☞ CPU Host Frequency

▶▶ 100MHz ~ 355MHz Set CPU Host Clock from 100MHz to 355MHz.

PCI/AGP Divider

▶ You can choose Disabled,PLL/40,PLL/32,PLL/24,PLL/20/PLL/16 mode to adjust PCI/AGP frequency.

Host/DRAM Clock Ratio

(Warning: wrong frequency may make system can't boot, clear CMOS to overcome wrong frequency issue)

- ▶ 2.0 Memory Frequency = Host clock X 2.0.
- ▶ 2.66 Memory Frequency = Host clock X 2.66.
- ▶ Auto Set Memory frequency by DRAM SPD data. (Default value)

Memory Frequency(Mhz)

▶ The values depend on CPU Host Frequency(Mhz) .

PCI/AGP Frequency(Mhz)

▶ Setup PCI/AGP frequency by adjusting CPU Host Frequency or PCI/AGP Divider item.

DIMM OverVoltage Control

- ▶ Normal Set DIMM OverVoltage Control to Normal. (Default value)
- ▶ +0.1V Set DIMM OverVoltage Control to +0.1V.
- ▶ +0.2V Set DIMM OverVoltage Control to +0.2V.
- ▶ +0.3V Set DIMM OverVoltage Control to +0.3V.

AGP OverVoltage Control

- ▶ Normal Set AGP OverVoltage Control to Normal. (Default value)
- ▶ +0.1V Set AGP OverVoltage Control to +0.1V.
- ▶ +0.2V Set AGP OverVoltage Control to +0.2V.
- ▶ +0.3V Set AGP OverVoltage Control to +0.3V.

☞ **CPU Voltage Control**

- ▶ Supports adjustable CPU Vcore from 1.100V to 1.850V by 0.025V step.
(Default value: Normal)

☞ **Normal CPU Vcore**

- ▶ Display your CPU Vcore Voltage.

Top Performance

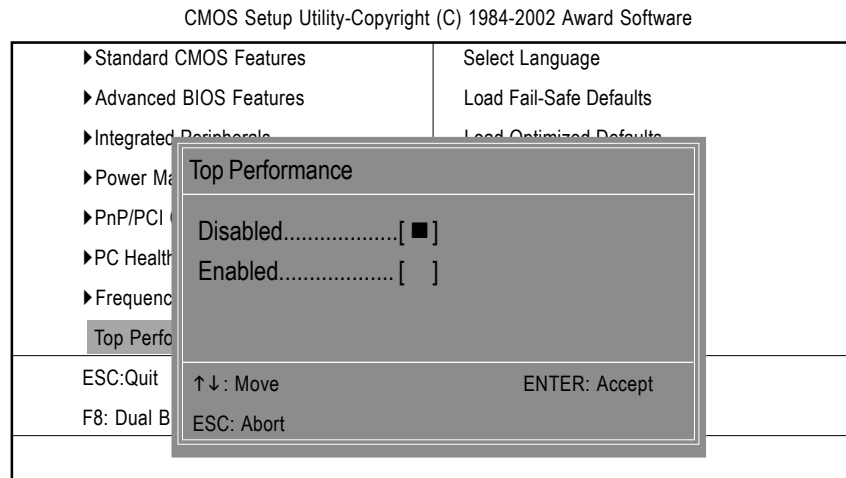

Figure 9: Top Performance

Top Performance

If you wish to maximize the performance of your system, set "Top Performance" as "Enabled".

- ▶▶ Disabled Disable this function. (Default Value)
- ▶▶ Enabled Enable Top Performance function.

Select Language

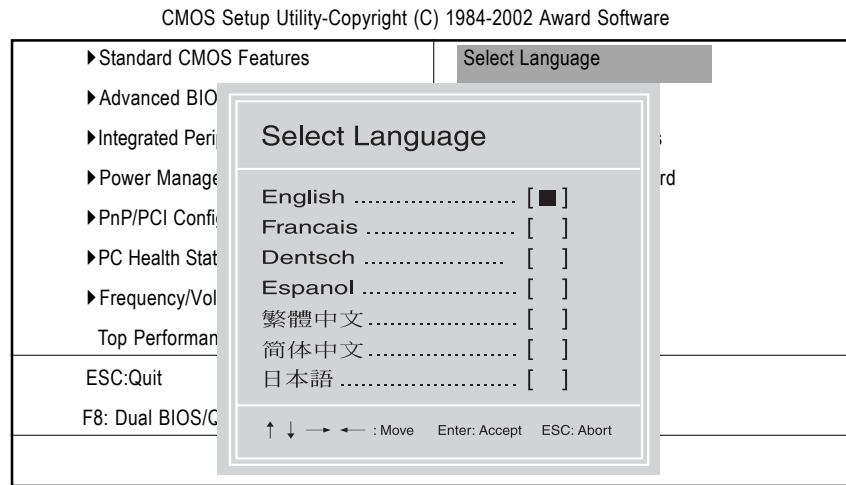

Figure 10:Select Language

Select Language

Multi Language is supports 7 languages. There are English, Japanese, French, Spanish, Germany, Simplified Chinese, Traditional Chinese.

Load Fail-Safe Defaults

CMOS Setup Utility-Copyright (C) 1984-2002 Award Software

▶Standard CMOS Features	Select Language
▶Advanced BIOS Features	Load Fail-Safe Defaults
▶Integrated Peripherals	Load Optimized Defaults
▶Power Man	
▶PnP/PCI C	Load Fail-Safe Defaults? (Y/N)?Y
▶PC Health Status	Save & Exit Setup
▶Frequency/Voltage Control	Exit Without Saving
Top Performance	
ESC:Quit	F3: Select Language
F8: Dual BIOS/Q-Flash	F10:Save & Exit Setup
Load Fail-Safe Defaults	

Figure 11: Load Fail-Safe Defaults

Load Fail-Safe Defaults

Fail-Safe defaults contain the most appropriate values of the system parameters that allow minimum system performance.

Load Optimized Defaults

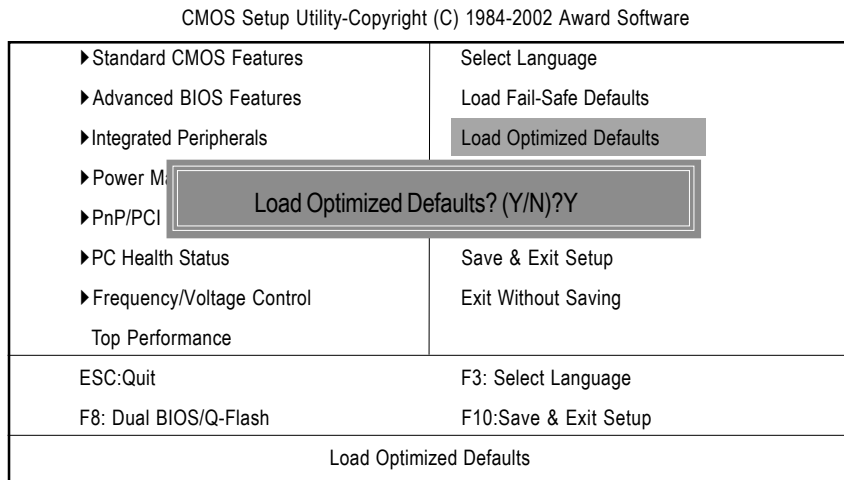

Figure 12: Load Optimized Defaults

Load Optimized Defaults

Selecting this field loads the factory defaults for BIOS and Chipset Features which the system automatically detects.

Set Supervisor/User Password

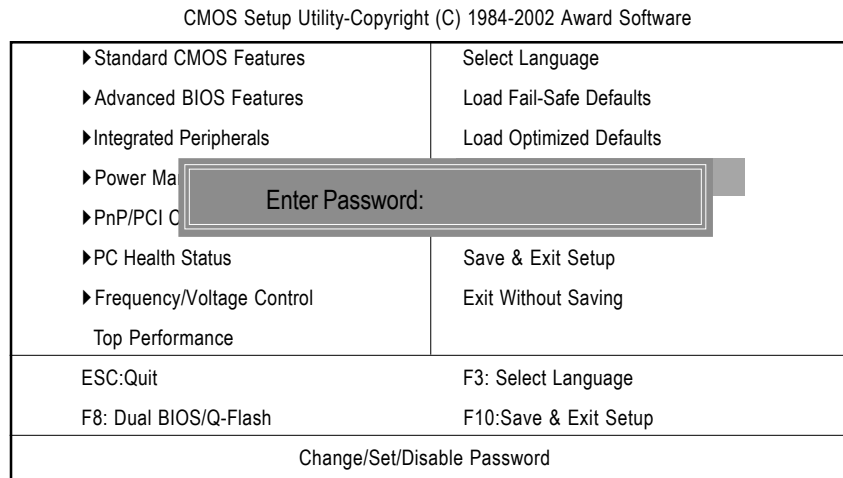

Figure 13: Password Setting

When you select this function, the following message will appear at the center of the screen to assist you in creating a password.

Type the password, up to eight characters, and press <Enter>. You will be asked to confirm the password. Type the password again and press <Enter>. You may also press <Esc> to abort the selection and not enter a password.

To disable password, just press <Enter> when you are prompted to enter password. A message “PASSWORD DISABLED” will appear to confirm the password being disabled. Once the password is disabled, the system will boot and you can enter Setup freely.

The BIOS Setup program allows you to specify two separate passwords:

SUPERVISOR PASSWORD and a USER PASSWORD. When disabled, anyone may access all BIOS Setup program function. When enabled, the Supervisor password is required for entering the BIOS Setup program and having full configuration fields, the User password is required to access only basic items.

If you select “System” at “Password Check” in Advance BIOS Features Menu, you will be prompted for the password every time the system is rebooted or any time you try to enter Setup Menu.

If you select “Setup” at “Password Check” in Advance BIOS Features Menu, you will be prompted only when you try to enter Setup.

Save & Exit Setup

CMOS Setup Utility-Copyright (C) 1984-2002 Award Software

▶Standard CMOS Features	Select Language
▶Advanced BIOS Features	Load Fail-Safe Defaults
▶Integrated Peripherals	Load Optimized Defaults
▶Power Management Setup	Set Supervisor Password
▶PnP/PCI C	
▶PC Health	
▶Frequency/Voltage Control	Exit Without Saving
Top Performance	
ESC:Quit	F3: Select Language
F8: Dual BIOS/Q-Flash	F10:Save & Exit Setup
Save Data to CMOS	

Figure 14: Save & Exit Setup

Type "Y" will quit the Setup Utility and save the user setup value to RTC CMOS.

Type "N" will return to Setup Utility.

Exit Without Saving

CMOS Setup Utility-Copyright (C) 1984-2002 Award Software

▶Standard CMOS Features	Select Language
▶Advanced BIOS Features	Load Fail-Safe Defaults
▶Integrated Peripherals	Load Optimized Defaults
▶Power Management Setup	Set Supervisor Password
▶PnP/PCI Co	Quit Without Saving (Y/N)? N
▶PC Health S	Exit Without Saving
▶Frequency/Voltage Control	
Top Performance	
ESC:Quit	F3: Select Language
F8: Dual BIOS/Q-Flash	F10:Save & Exit Setup
Abandon all Data	

Figure 15: Exit Without Saving

Type "Y" will quit the Setup Utility without saving to RTC CMOS.

Type "N" will return to Setup Utility.

Chapter 4 Technical Reference

Block Diagram

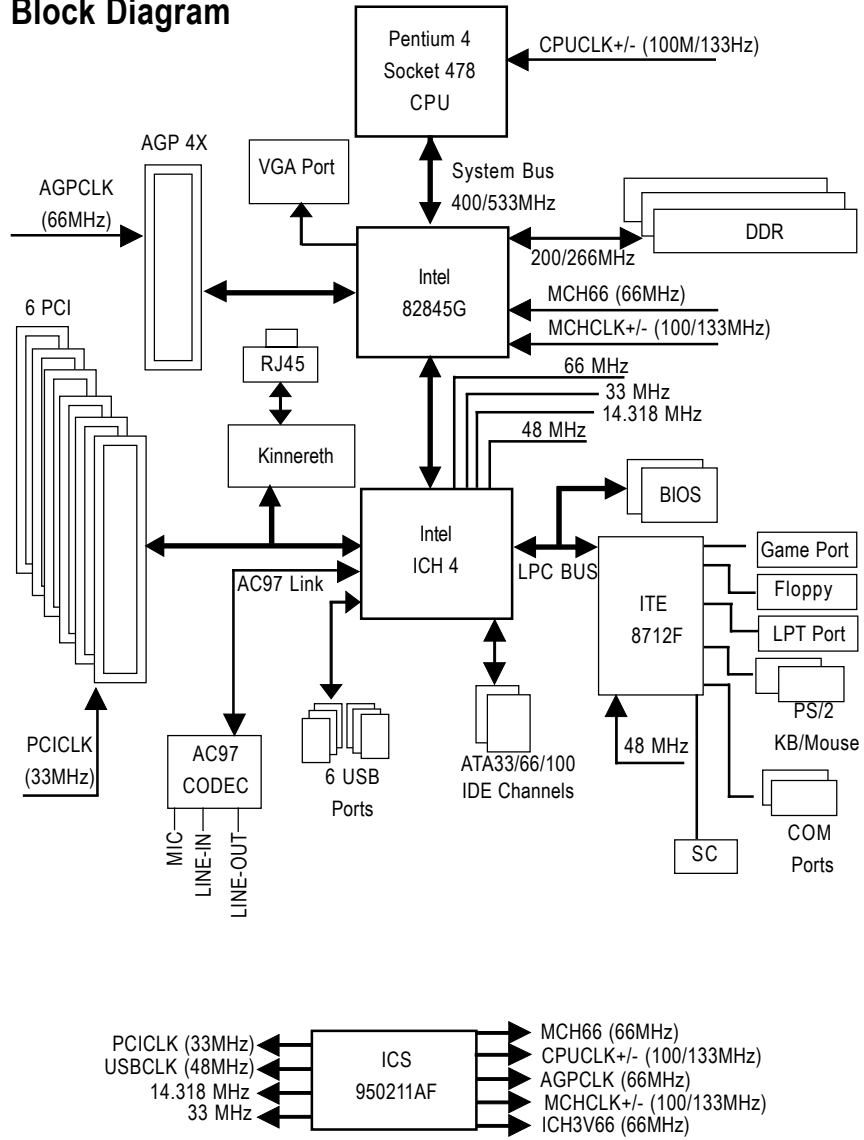

Dual BIOS/Q-Flash Introduction

A. What is Dual BIOS Technology?

Dual BIOS means that there are two system BIOS (ROM) on the motherboard, one is the Main BIOS and the other is Backup BIOS. Under the normal circumstances, the system works on the Main BIOS. If the Main BIOS is corrupted or damaged, the Backup BIOS can take over while the system is powered on. This means that your PC will still be able to run stably as if nothing has happened in your BIOS.

B. How to use Dual BIOS and Q-Flash Utility?

a. After power on the computer, pressing immediately during POST (Power On Self Test) it will allow you to enter Award BIOS CMOS SETUP, then press <F8> to enter Flash utility.

CMOS Setup Utility-Copyright (C) 1984-2002 Award Software

▶Standard CMOS Features	Select Language
▶Advanced BIOS Features	Load Fail-Safe Defaults
▶Integrated Peripherals	Load Optimized Defaults
▶Power Management Setup	Set Supervisor Password
▶PnP	
▶PC Health Status	Enter Dual BIOS/Q-Flash Utility (Y/N)? Y
▶Frequency/Voltage Control	Exit without Saving
Top Performance	
ESC:Quit	F3: Select Language
F8: Dual BIOS/Q-Flash	F10: Save & Exit Setup
Time, Date, Hard Disk Type...	

b. Award Dual BIOS Flash ROM Programming Utility

Dual BIOS Utility V.SIS.P3 (C) 2001, Gigabyte Technology Co., LTD.	
Wide Range Protection	:Disabled
Halt On BIOS Defects	:Disabled
Auto Recovery	:Enabled
Boot From	:Main BIOS
BIOS Recovery	:Main to Backup
F3: Load Default	F5:Start BIOS Recovery
F7: Save And Restart	F9:Exit Without Saving
F8: Update BIOS from disk	F10:Recovery from Disk
Use <Space> key to toggle setup	

c. Dual BIOS Item explanation:

Wide Range Protection: Disabled(Default), Enabled

Status 1:

If any failure (ex. Update ESCD failure, checksum error or reset...) occurs in the Main BIOS, just before the Operating System is loaded and after the power is on, and that the Wide Range Protection is set to "Enable", the PC will boot from Backup BIOS automatically.

Status 2:

If the ROM BIOS on peripherals cards(ex. SCSI Cards, LAN Cards,...) emits signals to request restart of the system after the user make any alteration on it, the boot up BIOS will not be changed to the Backup BIOS.

Halt On BIOS Defects : Disabled(Default), Enabled

If the BIOS occurs a checksum error or the Main BIOS occurs a WIDE RANGE PROTECTION error and Halt On BIOS Defects set to Enable, the PC will show messages on the boot screen, and the system will pause and wait for the user's instruction.

If Auto Recovery :**Disabled**, it will show *<or the other key to continue.>*

If Auto Recovery :**Enabled**, it will show *<or the other key to Auto Recover.>*

Auto Recovery : Enabled(Default), Disabled

When one of the Main BIOS or Backup BIOS occurs checksum failure, the working BIOS will automatically recover the BIOS of checksum failure.

(In the Power Management Setup of the BIOS Setting, if ACPI Suspend Type is set to Suspend to RAM, the Auto Recovery will be set to Enable automatically.)

(If you want to enter the BIOS setting, please press "Del" key when the boot screen appears.)

Boot From : Main BIOS(Default), Backup BIOS

Status 1:

The user can set to boot from main BIOS or Backup BIOS.

Status 2:

If one of the main BIOS or the Backup BIOS fails, this item "*Boot From : Main BIOS(Default)*" will become gray and will not be changed by user.

BIOS Recovery : Main to Backup

Auto recovery message:

BIOS Recovery: Main to Backup

The means that the Main BIOS works normally and could automatically recover the Backup BIOS.

BIOS Recovery: Backup to Main

The means that the Backup BIOS works normally and could automatically recover the Main BIOS.

(This auto recovery utility is set by system automatically and can't be changed by user.)

C. What is Q-Flash Utility?

Q-Flash utility is a pre-O.S. BIOS flash utility enables users to update its BIOS within BIOS mode, no more fooling around any OS.

D. How to use Q-Flash?

F3: Load Default Load current BIOS default value.	F5: Start BIOS Recovery Press F5 to recovery new BIOS version.
F7: Save And Restart Save revised setting and restart the computer.	F9: Exit Without Saving Exit without changing.
F8: Update BIOS from disk Update BIOS from disk.	F10: Recovery from Disk Recovery from disk.



DualBIOS™ Technology FAQ

GIGABYTE Technology is pleased to introduce DualBIOS technology, a hot spare for your system BIOS. This newest “Value-added” feature, in a long series of innovations from GIGABYTE, is available on this motherboard. Future GIGABYTE motherboards will also incorporate this innovation.

What's DualBIOS™?

On GIGABYTE motherboards with DualBIOS there are physically two BIOS chips. For simplicity we'll call one your “Main BIOS” and the other we'll call your “Backup” BIOS (your “hot spare”). If your Main BIOS fails, the Backup BIOS almost automatically takes over on your next system boot. Almost automatically and with virtually zero down time! Whether the problem is a failure in flashing your BIOS or a virus or a catastrophic failure of the Main BIOS chip, the result is the same - the Backup BIOS backs you up, almost automatically.

I. Q: What is DualBIOS™ technology?

Answer:

DualBIOS technology is a patented technology from Giga-Byte Technology. The concept of this technology is based on the redundancy and fault tolerance theory. DualBIOS™ technology simply means there are two system BIOSes (ROM) integrated onto the motherboard. One is a main BIOS, and the other is a backup BIOS. The mainboard will operate normally with the main BIOS, however, if the main BIOS is corrupt or damaged for various reasons, the backup BIOS will be automatically used when the system powered-On. Your PC will operate as before the main BIOS was damaged, and is completely transparent to the user.

II. Q: Why does anyone need a motherboard with DualBIOS™ technology?

Answer:

In today's systems there are more and more BIOS failures. The most common reasons are virus attacks, BIOS upgrade failures, and/or deterioration of the BIOS (ROM) chip itself.

1. New computer viruses are being found that attack and destroy the system BIOS. They may corrupt your BIOS code, causing your PC to be unstable or even not boot normally.
2. BIOS data will be corrupted if a power loss/surge occurs, or if a user resets the system, or if the power button is pressed during the process of performing a system BIOS upgrade.
3. If a user mistakenly updates their mainboard with the incorrect BIOS file, then the system may not be able to boot correctly. This may cause the PC system hang in operation or during boot.
4. A flash ROM's life cycle is limited according to electronic characteristics. The modern PC utilizes the Plug and Play BIOS, and is updated regularly. If a user changes peripherals often, there is a slight chance of damage to the flash ROM.

With Giga-Byte Technology's patented DualBIOS™ technology you can reduce the possibility of hangs during system boot up, and/or loss BIOS data due to above reasons. This new technology will eliminate valuable system down time and costly repair bills cause by BIOS failures.

III. Q: How does DualBIOS™ technology work?**Answer:**

1. DualBIOS™ technology provides a wide range of protection during the boot up procedure. It protects your BIOS during system POST, ESCD update, and even all the way to PNP detection/assignment.
2. DualBIOS™ provides automatic recovery for the BIOS. When the first BIOS used during boot up does not complete or if a BIOS checksum error occurs, boot-up is still possible. In the DualBIOS™ utility, the “Auto Recovery” option will guarantee that if either the main BIOS or backup BIOS is corrupted, the DualBIOS™ technology will use the good BIOS and correct the wrong BIOS automatically.
3. DualBIOS™ provides manual recovery for the BIOS. DualBIOS™ technology contains a built-in flash utility, which can flash your system BIOS from backup to main and/or visa versa. There is no need for an OS-dependent flash utility program.
4. DualBIOS™ contains a one-way flash utility. The built-in one-way flash utility will ensure that the corrupt BIOS is not mistaken as the good BIOS during recovery and that the correct BIOS (main vs. backup) will be flashed. This will prevent the good BIOS from being flashed.

IV. Q: Who Needs DualBIOS™ technology?**Answer:**

1. Every user should have DualBIOS™ technology due to the advancement of computer viruses.
Everyday, there are new BIOS-type viruses discovered that will destroy your system BIOS. Most commercial products on the market do not have solutions to guard against this type of virus intrusion. The DualBIOS™ technology will provide a state-of-the-art solution to protect your PC:
Case I.) Vicious computer viruses may wipe out your entire system BIOS. With a conventional single system BIOS PC, the PC will not be functional until it is sent for repairs.
Case II.) If the “Auto Recovery” option is enabled in the DualBIOS™ utility, and if a virus corrupts your system BIOS, the backup BIOS will automatically reboot the system and correct the main BIOS.
Case III.) A user may override booting from the main system BIOS. The DualBIOS™ utility may be entered to manually change the boot sequence to boot from the backup BIOS.

2. During or after a BIOS upgrade, if DualBIOS™ detects that the main BIOS is corrupt, the backup BIOS will take over the boot-up process automatically. Moreover, it will verify the main and backup BIOS checksums when booting-up. DualBIOS™ technology examines the checksum of the main and backup BIOS while the system is powered on to guarantee your BIOS operates properly.
3. Power Users will have the advantage of having two BIOS versions on their mainboard. The benefit is being able to select either version BIOS to suit the performance system needs.
4. Flexibility for high-end desktop PCs and workstation/servers. In the DualBIOS™ utility, the option can be set, "Halt On When BIOS Defects," to be enabled to halt your system with a warning message that the main BIOS has been corrupted. Most workstation/servers require constant operation to guarantee services have not been interrupted. In this situation, the "Halt On When BIOS Defects" message may be disabled to avoid system pauses during normal booting. Another advantage you gain from Giga-Byte's DualBIOS™ technology is the ability to upgrade from dual 2 Mbit BIOS to dual 4 Mbit BIOS in the future if extra BIOS storage is need.

@ BIOS Introduction

Gigabyte announces @ BIOS Windows BIOS live update utility



Have you ever updated BIOS by yourself? Or like many other people, you just know what BIOS is, but always hesitate to update it? Because you think updating newest BIOS is unnecessary and actually you don't know how to update it.

Maybe not like others, you are very experienced in BIOS updating and spend quite a lot of time to do it. But of course you don't like to do it too much. First, download different BIOS from website and then switch the operating system to DOS mode. Secondly, use different flash utility to update BIOS. The above process is not a interesting job. Besides, always be carefully to store the BIOS source code correctly in your disks as if you update the wrong BIOS, it will be a nightmare.

Certainly, you wonder why motherboard vendors could not just do something right to save your time and effort and save you from the lousy BIOS updating work? Here it comes! Now Gigabyte announces @BIOS—the first Windows BIOS live update utility. This is a smart BIOS update software. It could help you to download the BIOS from internet and update it. Not like the other BIOS update software, it's a Windows utility. With the help of "@BIOS", BIOS updating is no more than a click.

Besides, no matter which mainboard you are using, if it's a Gigabyte's product*, @BIOS help you to maintain the BIOS. This utility could detect your correct mainboard model and help you to choose the BIOS accordingly. It then downloads the BIOS from the nearest Gigabyte ftp site automatically. There are several different choices; you could use "Internet Update" to download and update your BIOS directly. Or you may want to keep a backup for your current BIOS, just choose "Save Current BIOS" to save it first. You make a wise choice to use Gigabyte, and @BIOS update your BIOS smartly. You are now worry free from updating wrong BIOS, and capable to maintain and manage your BIOS easily. Again, Gigabyte's innovative product erects a milestone in mainboard industries.

For such a wonderful software, how much it costs? Impossible! It's free! Now, if you buy a Gigabyte's motherboard, you could find this amazing software in the attached driver CD. But please remember, connected to internet at first, then you could have a internet BIOS update from your Gigabyte @BIOS.

Easy Tune™ 4 Introduction

Gigabyte announces *EasyTune™ 4*

Windows based Overclocking utility

EasyTune 4 carries on the heritage so as to pave the way for future generations.



"Overclock" might be one of the most common issues in computer field. But have many users ever tried it? The answer is probably "no". Because "Overclock" is thought to be very difficult and includes a lot of technical know-how, sometimes "Overclock" is even considered as special skills found only in some enthusiasts. But as to the experts in "Overclock", what's the truth? They may spend quite a lot of time and money to study, try and use many different hard-

ware or BIOS tools to do "Overclock". And even with these technologies, they still learn that it's quite a risk because the safety and stability of an "Overclock" system is unknown. Now everything is different because of a Windows based overclocking utility "EasyTune 4" --announced by Gigabyte. This windows based utility has totally changed the gaming rule of "Overclock". This is the first windows based overclocking utility is suitable for both normal and power users. Users can choose either "Easy Mode" or "Advanced Mode" for overclocking at their convenience. For users who choose "Easy Mode", they just need to click "Auto Optimize" to have autoed and immediate CPU overclocking. This software will then overdrive CPU speed automatically with the result being shown in the control panel. If users prefer "Overclock" by them, there is also another choice. Click "Advanced Mode" to enjoy "sport drive" class Overclocking user interface. "Advanced Mode", allows users to change the system bus / AGP / Memory working frequency in small increments to get ultimate system performance. It operates in coordination with Gigabyte motherboards. Besides, it is different from other traditional over-clocking methods, EasyTune 4 doesn't require users to change neither BIOS nor hardware switch/ jumper setting; on the other hand, they can do "Overclock" at easy step . Therefore, this is a safer way for "Overclock" as nothing is changed on software or hardware. If user runs EasyTune 4 over system's limitation, the biggest lost is only to restart the computer again and the side effect is then well controlled. Moreover, if one well-performed system speed has been tested in EasyTune 4, user can "Save" this setting and "Load" it in next time. Obviously, Gigabyte EasyTune 4 has already turned the "Overclock" technology toward to a newer generation. This wonderful software is now free bundled in Gigabyte motherboard attached in driver CD. Users may make a test drive of "EasyTune 4" to find out more amazing features by themselves.

*Some Gigabyte products are not fully supported by EasyTune 4. Please find the products supported list in the web site.

*Any "Overclocking action" is at user's risk, Gigabyte Technology will not be responsible for any damage or instability to your processor, motherboard, or any other components.

Chapter 5 Appendix

Picture below are shown in Windows XP (IUCD driver version 2.0)

Insert the driver CD-title that came with your motherboard into your CD-ROM driver, the driver CD-title will auto start and show the installation guide. If not, please double click the CD-ROM device icon in "My computer", and execute the setup.exe.

A. Installing Intel 845-G Chipset Driver

Please install this driver as the first priority. this item installs the chipset driver utility that enables Plug-n-Plag INF support for Intel chipset component.

B. Installing Sound Driver

Click this item to install sound driver.

C. Installing LAN Driver

Click this item to install LAN driver.



Appendix A: Intel 845-G Chipset Driver Installation

Follow the setup that showing on the screen to install the Utility.



In order to install the driver successfully, please refer to the following installation procedures.



A-1. Intel Chipset Software Installation Utility

Insert the driver CD-title that came with your motherboard into your CD-ROM driver, the driver CD-title will auto start and show the installation guide. If not, please double click the CD-ROM device icon in "My computer", and execute the setup.exe.



(1)



(2)

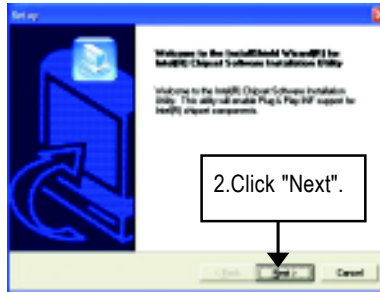

(3)

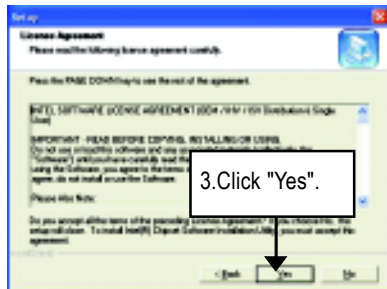

(4)



(5)

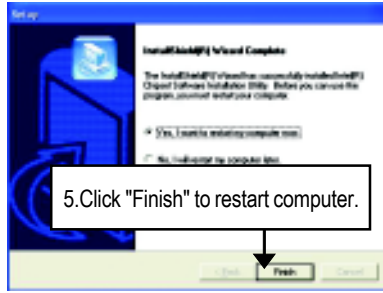

(6)

A-2. Intel Application Accelerator

Insert the driver CD-title that came with your motherboard into your CD-ROM driver, the driver CD-title will auto start and show the installation guide. If not, please double click the CD-ROM device icon in "My computer", and execute the setup.exe.



(1)



(2)

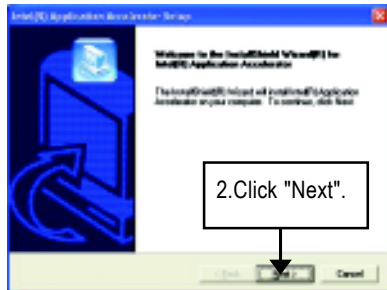

(3)

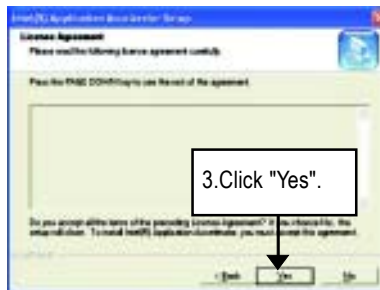

(4)



(5)

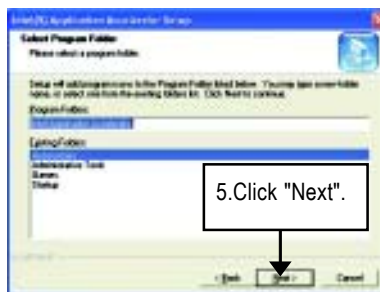

(6)



(7)

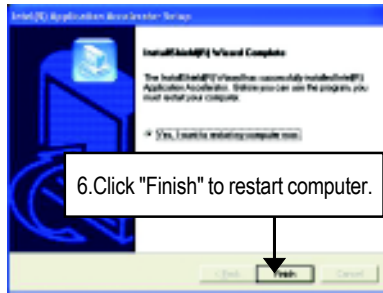

(8)

A-3. Intel 845G Chipset VGA Graphics Driver

Insert the driver CD-title that came with your motherboard into your CD-ROM driver, the driver CD-title will auto start and show the installation guide. If not, please double click the CD-ROM device icon in "My computer", and execute the setup.exe.



(1)

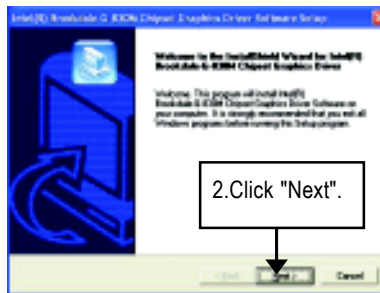

(2)

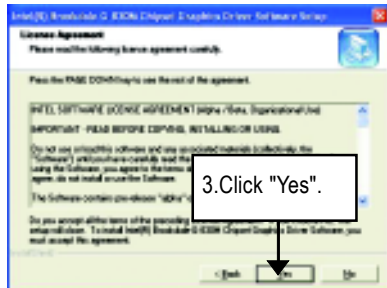

(3)



(4)

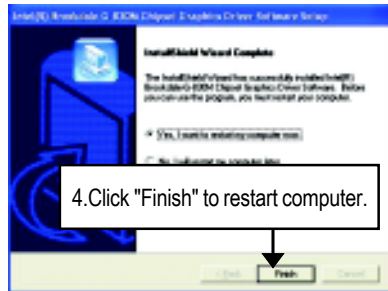

(5)

A-4. USB Patch Driver

Insert the driver CD-title that came with your motherboard into your CD-ROM driver, the driver CD-title will auto start and show the installation guide. If not, please double click the CD-ROM device icon in "My computer", and execute the setup.exe.



(1)

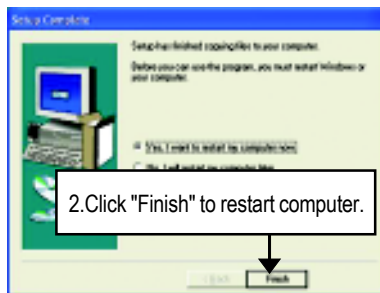

(2)

A-5. ITE Smart Card Reader

Insert the driver CD-title that came with your motherboard into your CD-ROM driver, the driver CD-title will auto start and show the installation guide. If not, please double click the CD-ROM device icon in "My computer", and execute the setup.exe.

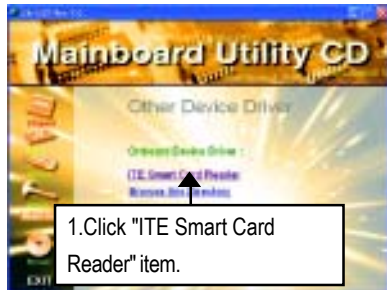

(1)

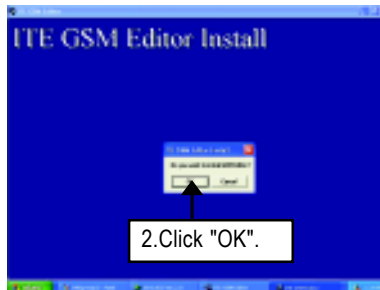

(2)

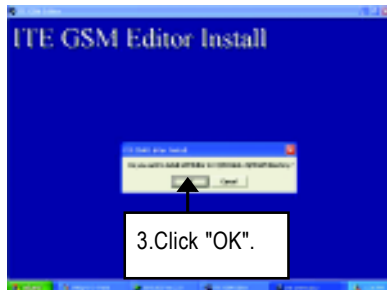

(3)

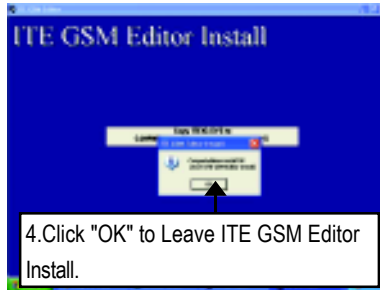

(4)



(5)

Appendix B: RealTek AC'97 Audio Driver

Insert the driver CD-title that came with your motherboard into your CD-ROM driver, the driver CD-title will auto start and show the installation guide. If not, please double click the CD-ROM device icon in "My computer", and execute the setup.exe.



(1)



(2)



(3)

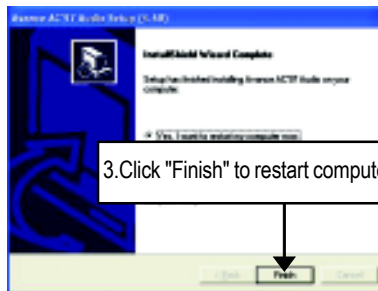

(4)

Appendix C: Intel 82562 Network Driver

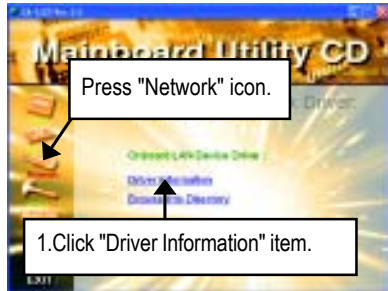

(1)



(2)

- For your reference, you can use the following steps to complete the Network Driver Installation.

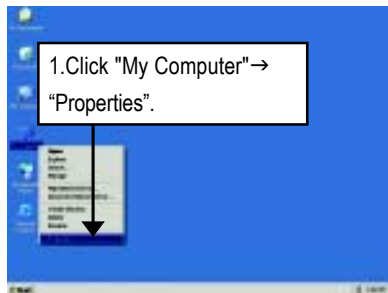

(3)

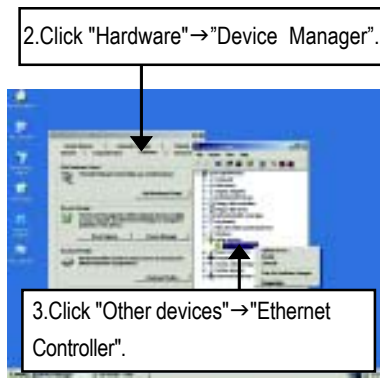

(4)

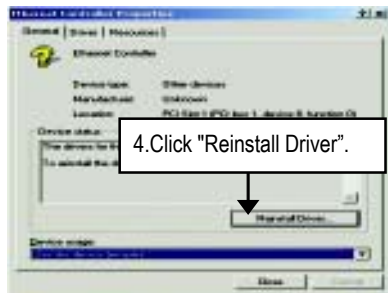

(5)

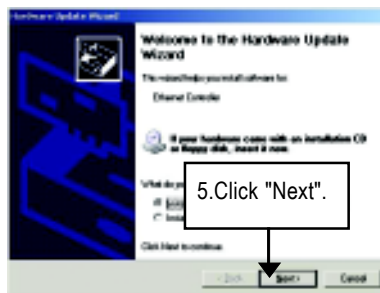

(6)



(7)

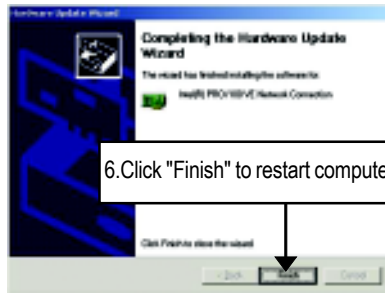

(8)

Appendix D: Face-Wizard Utilities Installation

What is Face-Wizard™?

Face-Wizard™ is a windows based utility with user-friendly interface that allows users to change the boot-up logo with picture from Gigabyte Logo Gallery on web site or other compatible picture you have.

How does it work?

Face-Wizard™ allows user to select BIOS on board or file in hard drive, floppy disk , zip, MO or other storage devices and combine the compatible picture you prefer into BIOS. And not only this, Face-Wizard™ also helps user to update BIOS in windows mode.

What's benefit for using Face-Wizard™?

It can personalize boot-up logo to show your unique style from others, and never again looking at the black and white boot up screen.



Appendix E: EasyTune 4 Utilities Installation

Insert the driver CD-title that came with your motherboard into your CD-ROM driver, the driver CD-title will auto start and show the installation guide. If not, please double click the CD-ROM device icon in "My computer", and execute the setup.exe.

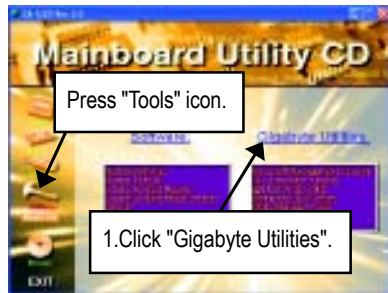

(1)



(2)



(3)



(4)



(5)



(6)

Appendix F: BIOS Flash Procedure

BIOS update procedure:

Method 1:

If your OS is Win9X, we recommend that you used Gigabyte @BIOS™ Program to flash BIOS.

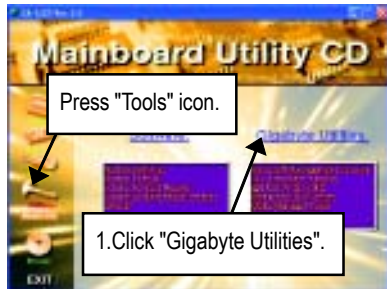

(1)

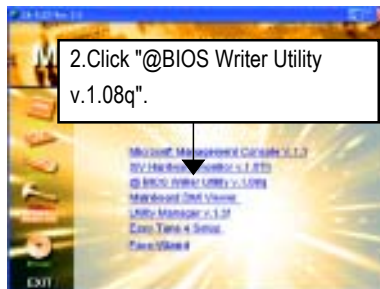

(2)

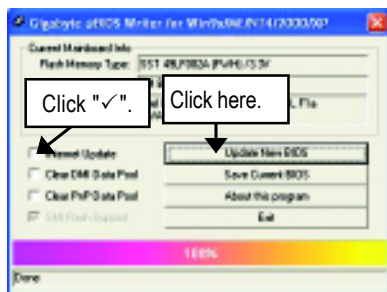

(3)

Methods and steps:

- I. Update BIOS through Internet
 - a. Click "Internet Update" icon
 - b. Click "Update New BIOS" icon
 - c. Select @BIOS™ sever ("Gigabyte @BIOSTM sever 1 in Taiwan" and "Gigabyte @BIOS™ sever 2 in Taiwan" are available for now, the others will be completed soon)
 - d. Select the exact model name on your motherboard
 - e. System will automatically download and update the BIOS.

II. Update BIOS NOT through Internet:

- a. Do not click "Internet Update" icon
- b. Click "Update New BIOS"
- c. Please select "All Files" in dialog box while opening the old file.
- d. Please search for BIOS unzip file, downloading from internet or any other methods (such as: 8IGX.F1).
- e. Complete update process following the instruction.

III. Save BIOS

In the very beginning, there is "Save Current BIOS" icon shown in dialog box. It means to save the current BIOS version.

IV. Check out supported motherboard and Flash ROM:

In the very beginning, there is "About this program" icon shown in dialog box. It can help you check out which kind of motherboard and which brand of Flash ROM are supported.

Note:

- a. In method I, if it shows two or more motherboard's model names to be selected, please make sure your motherboard's model name again. Selecting wrong model name will cause the system unbooted.
- b. In method II, be sure that motherboard's model name in BIOS unzip file are the same as your motherboard's. Otherwise, your system won't boot.
- c. In method I, if the BIOS file you need cannot be found in @BIOS™ server, please go onto Gigabyte's web site for downloading and updating it according to method II.
- d. Please note that any interruption during updating will cause system unbooted

Method 2:

We use GA-7VTX motherboard and Flash841 BIOS flash utility as example.

Please flash the BIOS according to the following procedures if you are now under the DOS mode.

Flash BIOS Procedure:

STEP 1:

- (1) Please make sure your system has installed the extraction utility such as winzip or pkunzip.
Firstly you have to install the extraction utility such as winzip or pkunzip for unzip the files. Both of these utilities are available on many shareware download pages like <http://www.shareware.cnet.com>

STEP 2: Make a DOS boot diskette. (See example: Windows 98 O.S.)

Beware: Windows ME/2000 are not allowed to make a DOS boot diskette.

- (1) With an available floppy disk in the floppy drive. Please leave the diskette "UN-write protected" type. Double click the "My Computer" icon from Desktop, then click "3.5 diskette (A)" and right click to select "Format (M)"



- (2) Select the "Quick (erase)" for Format Type, and pick both "Display summary when finished" and "Copy system files", after that press "Start". That will format the floppy and transfer the needed system files to it.

Beware: This procedure will erase all the prior data on that floppy, so please proceed accordingly.

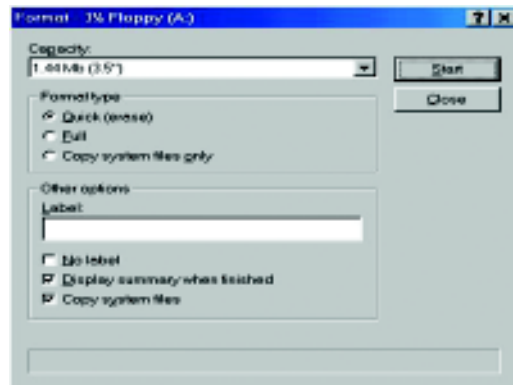

- (3) After the floppy has been formatted completely, please press "Close".



STEP 3: Download BIOS and BIOS utility program.

(1) Please go to Gigabyte website <http://www.gigabyte.com.tw/index.html>, and click "Support".



(2) From Support zone, click the "Motherboards BIOS & Drivers".



- (3) We use GA-7VTX motherboard as example. Please select GA-7VTX by Model or Chipset optional menu to obtain BIOS flash files.

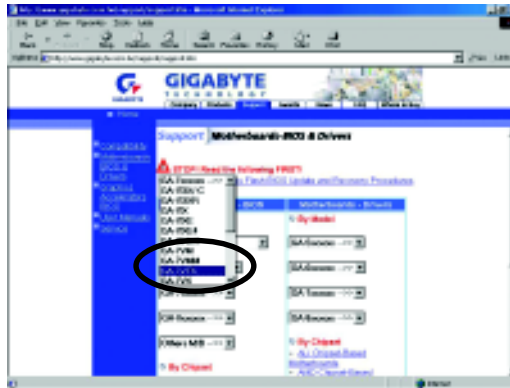

- (4) Select an appropriate BIOS version (For example: F4), and click to download the file. It will pop up a file download screen, then select the "Open this file from its current location" and press "OK".



(5) At this time the screen shows the following picture, please click "Extract" button to unzip the files.

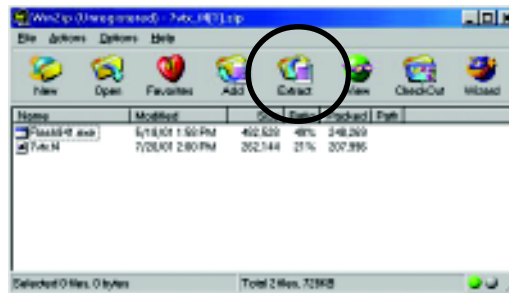

(6) Please extract the download files into the clean bootable floppy disk A mentioned in STEP 2, and press "Extract".



STEP 4: Make sure the system will boot from the floppy disk.

- (1) Insert the floppy disk (contains bootable program and unzip file) into the floppy drive A. Then, restart the system. The system will boot from the floppy disk. Please press key to enter BIOS setup main menu when system is boot up.

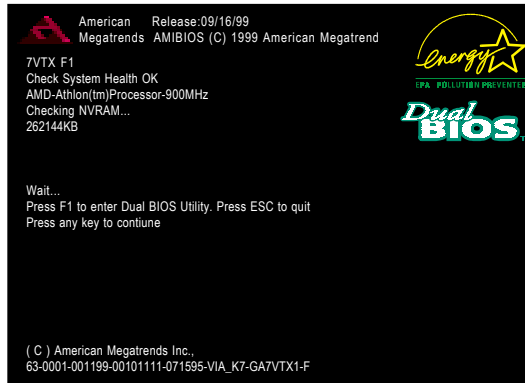

- (2) Once you enter the BIOS setup utility, the main menu will appear on the screen. Use the arrows to highlight the item "BIOS FEATURES SETUP".

AMIBIOS SIMPLE SETUP UTILITY - VERSION 1.24b (C) 1999 American Megatrends, Inc. All Rights Reserved	
STANDARD CMOS SETUP BIOS FEATURES SETUP CHIPSET FEATURES SETUP POWER MANAGEMENT SETUP PNP / PCI CONFIGURATION LOAD BIOS DEFAULTS LOAD SETUP DEFAULTS	INTEGRATED PERIPHERALS HARDWARE MONITOR & MISC SETUP SUPERVISOR PASSWORD USER PASSWORD IDE HDD AUTO DETECTION SAVE & EXIT SETUP EXIT WITHOUT SAVING
ESC: Quit ↑↓←→ : Select Item (Shift)F2 : Change Color F5: Old Values F6: Load BIOS Defaults F7: Load Setup Defaults F10: Save & Exit	
Time, Date , Hard Disk Type...	

- (3) Press "Enter" to enter "BIOS FEATURES SETUP" menu. Use the arrows to highlight the item "1st Boot Device", and then use the "Page Up" or "Page Down" keys to select "Floppy".

AMIBIOS SETUP - BIOS FEATURES SETUP	
(C) 2001 American Megatrends, Inc. All Rights Reserved	
1st Boot Device : Floppy	
2nd Boot Device : IDE-0	
3rd Boot Device : CDROM	
S.M.A.R.T. for Hard Disks : Disabled	
BootUp Num-Lock : On	ESC: Quit ↑↓←→: Select Item
Floppy Drive Seek : Disabled	F1 : Help PU/PD/+/- : Modify
Password Check : Setup	F5 : Old Values (Shift)F2: Color
	F6 : Load BIOS Defaults
	F7 : Load Setup Defaults

- (4) Press "ESC" to go back to previous screen. Use the arrows to highlight the item "SAVE & EXIT SETUP" then press "Enter". System will ask "SAVE to CMOS and EXIT (Y/N)?" Press "Y" and "Enter" keys to confirm. Now the system will reboot automatically, the new BIOS setting will be taken effect next boot-up.

AMIBIOS SIMPLE SETUP UTILITY - VERSION 1.24b	
(C) 2001 American Megatrends, Inc. All Rights Reserved	
STANDARD CMOS SETUP	INTEGRATED PERIPHERALS
BIOS FEATURES SETUP	HARDWARE MONITOR & MISC SETUP
CHIPSET FEATURES SETUP	SUPERVISOR PASSWORD
POWER MANAGEMENT SETUP	USER PASSWORD
PNP / PCI CONF	SAVE to CMOS and EXIT (Y/N)? Y
LOAD BIOS DEFAULTS	SAVE & EXIT SETUP
LOAD SETUP DEFAULTS	EXIT WITHOUT SAVING
ESC: Quit ↑↓←→ : Select Item (Shift)F2 : Change Color F5: Old Values	
F6: Load BIOS Defaults F7: Load Setup Defaults F10: Save & Exit	
Save Data to CMOS & Exit SETUP	

STEP 5: BIOS flashing.

- (1) After the system boot from floppy disk, type "A:\> dir/w" and press "Enter" to check the entire files in floppy A. Then type the "BIOS flash utility" and "BIOS file" after A:\>. In this case you have to type "A:\> Flash841 7VTX.F4" and then press "Enter".

```
Starting Windows 98...

Microsoft(R) Windows98
© Copyright Microsoft Corp 1981-1999

A:\> dir/w
Volume in drive A has no label
Volume Serial Number is 16EB-353D
Directory of A:\
COMMAND.COM  7VTX.F4  FLASH841.EXE
              3 file(s)  838,954 bytes
              0 dir(s)  324,608 bytes free

A:\> Flash841 7VTX.F4
```

- (2) Now screen appears the following Flash Utility main menu. Press "Enter", the highlighted item will locate on the model name of the right-upper screen. Right after that, press "Enter" to start BIOS Flash Utility.

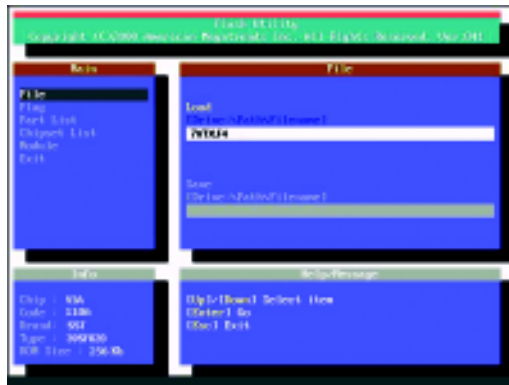

- (3) It will pop up a screen and asks "Are you sure to flash the BIOS?" Press [Enter] to continue the procedure, or press [ESC] to quit.

Beware: Please do not turn off the system while you are upgrading BIOS. It will render your BIOS corrupted and system totally inoperative.

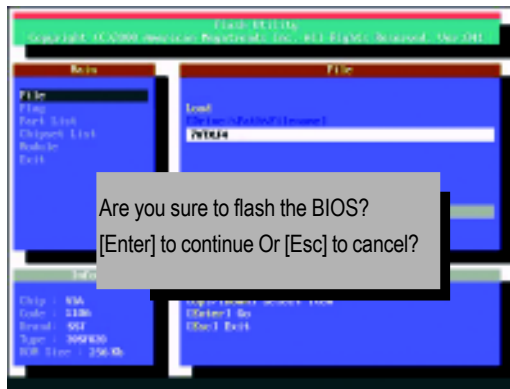

- (4) The BIOS flash completed. Please press [ESC] to exit Flash Utility.

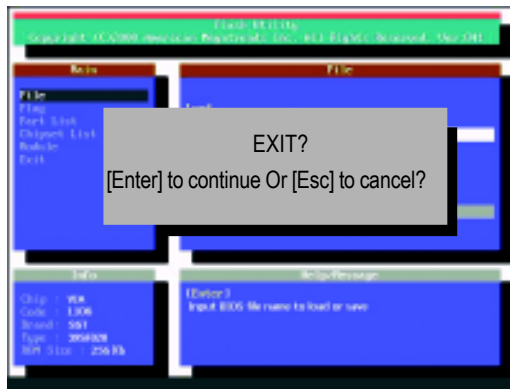

STEP 6: Load BIOS defaults.

Normally the system redetects all devices after BIOS has been upgraded. Therefore, we highly recommend reloading the BIOS defaults after BIOS has been upgraded. This important step resets everything after the flash.

- (1) Take out the floppy diskette from floppy drive, and then restart the system. The boot up screen will indicate your motherboard model and current BIOS version.



- (2) Don't forget to press key to enter BIOS setup again when system is boot up. Use the arrows to highlight the item "LOAD SETUP DEFAULTS" then press "Enter". System will ask "Load Setup Defaults (Y/N)?". Press "Y" and "Enter" keys to confirm.

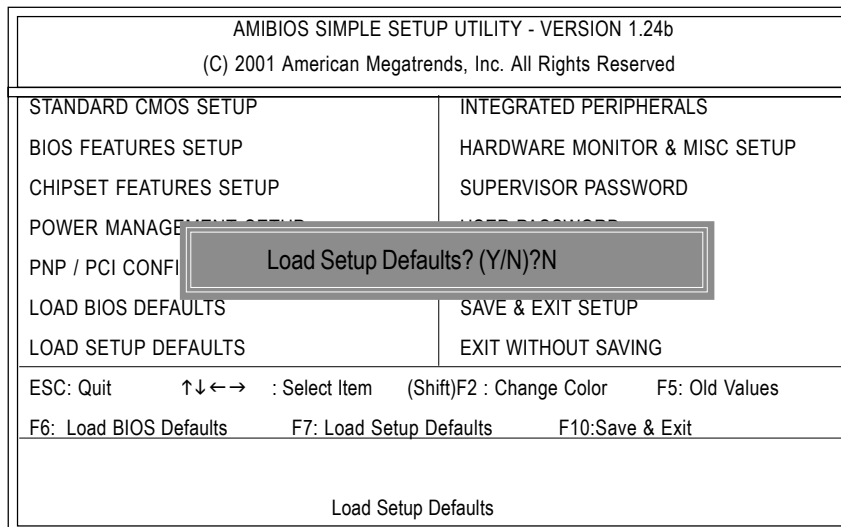

- (3) Use the arrows to highlight the item "SAVE & EXIT SETUP" and press "Enter". System will ask "SAVE to CMOS and EXIT (Y/N)?" Press "Y" and "Enter" keys to confirm. Now the system will reboot automatically, the new BIOS setting will be taken effect next boot-up.

AMIBIOS SIMPLE SETUP UTILITY - VERSION 1.24b (C) 2001 American Megatrends, Inc. All Rights Reserved	
STANDARD CMOS SETUP	INTEGRATED PERIPHERALS
BIOS FEATURES SETUP	HARDWARE MONITOR & MISC SETUP
CHIPSET FEATURES SETUP	SUPERVISOR PASSWORD
POWER MANAGEMENT SETUP	USER PASSWORD
PNP / PCI CONF	SAVE & EXIT SETUP
LOAD BIOS DEFAULTS	EXIT WITHOUT SAVING
LOAD SETUP DEFAULTS	
ESC: Quit ↑↓←→ : Select Item (Shift)F2 : Change Color F5: Old Values F6: Load BIOS Defaults F7: Load Setup Defaults F10: Save & Exit	
Save Data to CMOS & Exit SETUP	

- (4) Congratulate you have accomplished the BIOS flash procedure.

Appendix G: Acronyms

Acronyms	Meaning
ACPI	Advanced Configuration and Power Interface
APM	Advanced Power Management
AGP	Accelerated Graphics Port
AMR	Audio Modem Riser
ACR	Advanced Communications Riser
BIOS	Basic Input / Output System
CPU	Central Processing Unit
CMOS	Complementary Metal Oxide Semiconductor
CRIMM	Continuity RIMM
CNR	Communication and Networking Riser
DMA	Direct Memory Access
DMI	Desktop Management Interface
DIMM	Dual Inline Memory Module
DRM	Dual Retention Mechanism
DRAM	Dynamic Random Access Memory
DDR	Double Data Rate
ECP	Extended Capabilities Port
ESCD	Extended System Configuration Data
ECC	Error Checking and Correcting
EMC	Electromagnetic Compatibility
EPP	Enhanced Parallel Port
ESD	Electrostatic Discharge
FDD	Floppy Disk Device
FSB	Front Side Bus
HDD	Hard Disk Device
IDE	Integrated Dual Channel Enhanced
IRQ	Interrupt Request
I/O	Input / Output
IOAPIC	Input Output Advanced Programmable Input Controller
ISA	Industry Standard Architecture
LAN	Local Area Network

to be continued.....

GA-8IGX Motherboard

Acronyms	Meaning
LBA	Logical Block Addressing
LED	Light Emitting Diode
MHz	Megahertz
MIDI	Musical Interface Digital Interface
MTH	Memory Translator Hub
MPT	Memory Protocol Translator
NIC	Network Interface Card
OS	Operating System
OEM	Original Equipment Manufacturer
PAC	PCI A.G.P. Controller
POST	Power-On Self Test
PCI	Peripheral Component Interconnect
RIMM	Rambus in-line Memory Module
SCI	Special Circumstance Instructions
SECC	Single Edge Contact Cartridge
SRAM	Static Random Access Memory
SMP	Symmetric Multi-Processing
SMI	System Management Interrupt
USB	Universal Serial Bus
VID	Voltage ID

✂
Technical Support/RMA Sheet

Customer/Country:	Company:	Phone No.:
Contact Person:	E-mail Add. :	

Model name/Lot Number:	PCB revision:
BIOS version:	O.S./A.S.:

Hardware Configuration	Mfs.	Model name	Size:	Driver/Utility:
CPU				
Memory				
Brand				
Video Card				
Audio Card				
HDD				
CD-ROM / DVD-ROM				
Modem				
Network				
AMR / CNR				
Keyboard				
Mouse				
Power supply				
Other Device				

Problem Description:

