

GA-8IEX Series
P4 Titan 533 Motherboard

USER'S MANUAL

Pentium®4 Processor Motherboard
Rev. 1202
12MD-8IEX-1202

Table of Content

Item Checklist.....	3
WARNING!	3
Chapter 1 Introduction.....	4
Features Summary	4
GA-8IEX Series Motherboard Layout	7
Chapter 2 Hardware Installation Process	8
Step 1: Install the Central Processing Unit (CPU)	9
Step 1-1: CPU Installation	9
Step 1-2: CPU Heat Sink Installation	10
Step 2: Install memory modules	11
Step 3: Install expansion cards	12
Step 4: Connect ribbon cables, cabinet wires, and power supply	13
Step 4-1: I/O Back Panel Introduction	13
Step 4-2: Connectors & Jumper Setting Introduction	15
Chapter 3 BIOS Setup	23
The Main Menu	23
Dual BIOS / Q-Flash Utility	23
Select Language	23
Load Optimized Default	25
Save & Exit Setup	26
Chapter 4 Driver Installation	27
Chapter 5 BIOS Flash Procedure	29

Item Checklist

- | | |
|---|---|
| <input checked="" type="checkbox"/> The GA-8IEX Series motherboard | <input checked="" type="checkbox"/> SPD-KIT x 1 |
| <input checked="" type="checkbox"/> IDE (ATA100) cable x 1 / Floppy cable x 1 | <input checked="" type="checkbox"/> IEEE1394 Cable x 1 (**) |
| <input checked="" type="checkbox"/> IDE (ATA133) cable x 2(**) | <input checked="" type="checkbox"/> I/O Shield |
| <input checked="" type="checkbox"/> 4-Port USB Cable x 1 | |
| <input checked="" type="checkbox"/> CD for motherboard driver & utility | |
| <input checked="" type="checkbox"/> GA-8IEX Series user's manual | |
| <input checked="" type="checkbox"/> Quick PC Installation Guide | |



WARNING!

Computer motherboards and expansion cards contain very delicate Integrated Circuit (IC) chips. To protect them against damage from static electricity, you should follow some precautions whenever you work on your computer.

1. Unplug your computer when working on the inside.
2. Use a grounded wrist strap before handling computer components. If you do not have one, touch both of your hands to a safely grounded object or to a metal object, such as the power supply case.
3. Hold components by the edges and try not to touch the IC chips, leads or connectors, or other components.
4. Place components on a grounded antistatic pad or on the bag that came with the components whenever the components are separated from the system.
5. Ensure that the ATX power supply is switched off before you plug in or remove the ATX power connector on the motherboard.

Installing the motherboard to the chassis...

If the motherboard has mounting holes, but they don't line up with the holes on the base and there are no slots to attach the spacers, do not become alarmed you can still attach the spacers to the mounting holes. Just cut the bottom portion of the spacers (the spacer may be a little hard to cut off, so be careful of your hands). In this way you can still attach the motherboard to the base without worrying about short circuits. Sometimes you may need to use the plastic springs to isolate the screw from the motherboard PCB surface, because the circuit wire may be near by the hole. Be careful, don't let the screw contact any printed circuit wire or parts on the PCB that are near the fixing hole, otherwise it may damage the board or cause board malfunctioning.

* For GA-8IEX Only. ** For GA-8IEXP Only.

Chapter 1 Introduction

Features Summary

Form Factor	<ul style="list-style-type: none"> 30.6cm x 24.4cm ATX size form factor, 4 layers PCB.
Motherboard	<ul style="list-style-type: none"> GA-8IEX Series Motherboard: GA-8IEX and GA-8IEXP
CPU	<ul style="list-style-type: none"> Socket 478 for Intel® Micro FC-PGA2 Pentium® 4 processor Intel Pentium®4 533MHz/400MHz FSB Support Intel® Pentium® 4 (Northwood, 0.13µm) processor 2nd cache depend on CPU
Chipset	<ul style="list-style-type: none"> Chipset 845E HOST/AGP/Controller ICH4 I/O Controller Hub
Memory	<ul style="list-style-type: none"> 3 184-pin DDR DIMM sockets Supports PC2100 DDR or PC1600 DDR DIMM Supports up to 2GB DRAM (Max) Supports only 2.5V DDR DIMM Supports 64bit ECC type DRAM integrity mode
I/O Control	<ul style="list-style-type: none"> IT8712
Slots	<ul style="list-style-type: none"> 1 CNR(Communication and Networking Riser) Slot (**) 1 AGP slot 4X (1.5V only) device support 6 PCI slots supports 33MHz & PCI 2.2 compliant
On-Board IDE	<ul style="list-style-type: none"> 2 IDE controllers on the Intel ICH4 PCI chipset provides IDE HDD/CD-ROM (IDE1, IDE2) with PIO, Bus Master (Ultra DMA 33/ATA 66/ATA 100) operation modes. IDE3 and IDE4 Compatible with RAID, Ultra ATA 133/100. (**)
On-Board Peripherals	<ul style="list-style-type: none"> 1 Floppy port supports 2 FDD with 360K, 720K, 1.2M, 1.44M and 2.88M bytes. 1 Parallel port supports Normal/EPP/ECP mode 2 Serial ports (COMA & COMB) 6 x USB 2.0/1.1 (2 x Rear, 4 x Front by cable) 1 IrDA connector for IR/CIR 1 Front Audio connector 3 IEEE1394 connector (**)

to be continued.....

**** For GA-8IEXP Only.**

Hardware Monitor	<ul style="list-style-type: none"> • CPU/Power/System Fan Revolution detect • CPU/Power/System Fan Control • CPU Overheat Warning • System Voltage Detect
On-Board Sound	<ul style="list-style-type: none"> • Creative CT5880 Sound Chipset + Sigmatel 9708T CODEC • Line Out / 2 front speaker • Line In / 2 rear speaker(by s/w switch) • Mic In : Mic • SPDIF out: by s/w switch
On-Board RAID (**)	<ul style="list-style-type: none"> • Onboard Promise PDC20276 • Supports data striping (RAID 0) or mirroring (RAID 1) • Supports concurrent dual ATA133 IDE controller operation • Support ATAPI mode for CD ROM, DVD ROM ..etc. • Supports IDE bus master operation • Support ATA133/RAID mode switch by BIOS • Mirroring supports automatic background rebuilds • Features LBA and Extended Interrupt 13 drive translation in controller onboard BIOS
On-Board LAN	<ul style="list-style-type: none"> • Intel 82562ET LAN PHY
On-Board USB 2.0	<ul style="list-style-type: none"> • Built in ICH4 Chipset
On-Board 1394(**)	<ul style="list-style-type: none"> • Built in VT6306 C chipset (**)
On-Board MS(**), SC, SD(MMC)(*)	<ul style="list-style-type: none"> • Winbond SMART I/O Chipset (Memory Stick , Security Digital and SC header)
PS/2 Connector	<ul style="list-style-type: none"> • PS/2 Keyboard interface and PS/2 Mouse interace
BIOS	<ul style="list-style-type: none"> • Licensed AWARD BIOS, 4M bit x 2 FWH (**) • Licensed AWARD BIOS, 3M bit x 2 FWH (*) • Supports Dual BIOS • Supports Multi Language • Supports Face Wizard • Supports Q-Flash
Additional Features	<ul style="list-style-type: none"> • PS/2 Keyboard power on by password • PS/2 Mouse power on • External Modem wake up • STR(Suspend-To-RAM) • Wake on LAN (WOL)(**) • AC Recovery

to be continued.....

* For GA-8IEX Only.** For GA-8IEXP Only.

	<ul style="list-style-type: none">• Poly fuse for keyboard over-current protection• USB KB/Mouse wake up from S3• Supports @BIOS• Supports EasyTune 4
Overclocking	<ul style="list-style-type: none">• Over Voltage (DDR/AGP/CPU) by BIOS• OverClock (DDR/AGP/CPU) by BIOS



Please set the CPU host frequency in accordance with your processor's specifications. We don't recommend you to set the system bus frequency over the CPU's specification because these specific bus frequencies are not the standard specifications for CPU, chipset and most of the peripherals. Whether your system can run under these specific bus frequencies properly will depend on your hardware configurations, including CPU, Chipsets, SDRAM, Cards... etc.

*** For GA-8IEX Only. ** For GA-8IEXP Only.**

GA-8IEX Series Motherboard Layout

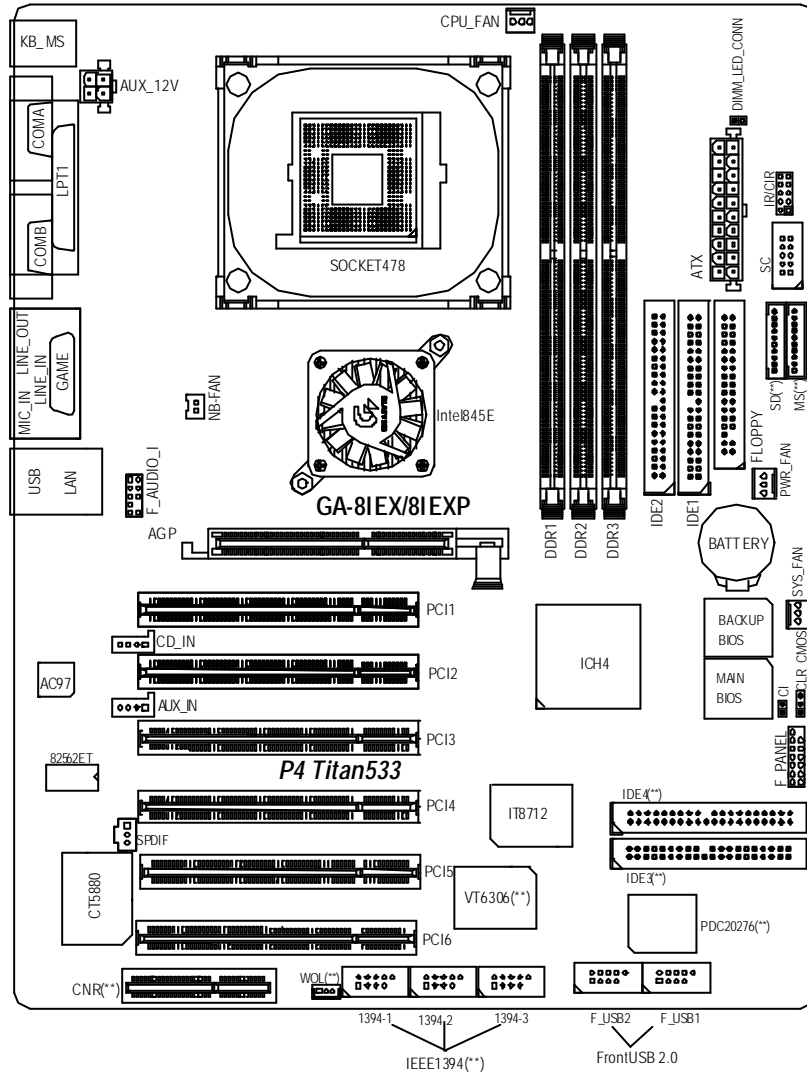

* For GA-8IEX Only. ** For GA-8IEXP Only.

Chapter 2 Hardware Installation Process

To set up your computer, you must complete the following steps:

- Step 1- Install the Central Processing Unit (CPU)
- Step 2- Install memory modules
- Step 3- Install expansion cards
- Step 4- Connect ribbon cables, cabinet wires, and power supply
- Step 5- Setup BIOS software
- Step 6- Install supporting software tools

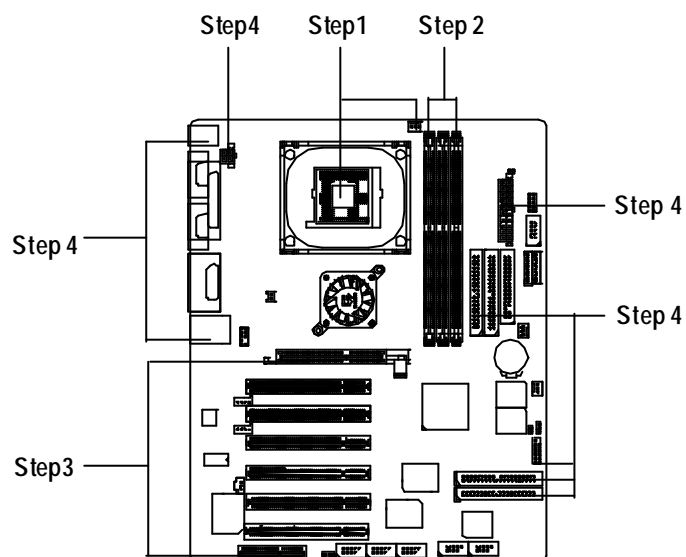

Step 1: Install the Central Processing Unit (CPU)

Step 1-1 CPU Installation



CPU Top View

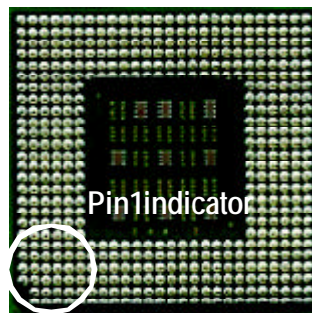

CPU Bottom View

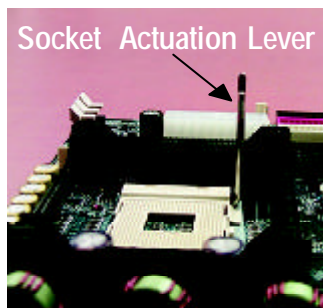

1. Pull up the CPU socket lever and up to 90-degree angle.
3. Press down the CPU socket lever and finish CPU installation.

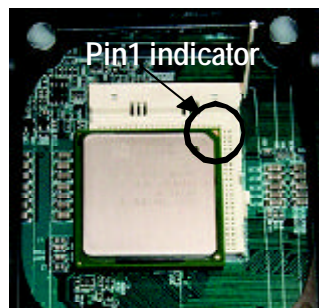

2. Locate Pin 1 in the socket and look for a (golden) cut edge on the CPU upper corner. Then insert the CPU into the socket.

- ⚠ Please make sure the CPU type is supported by the motherboard.
- ⚠ If you do not match the CPU socket Pin 1 and CPU cut edge well, it will cause improper installation. Please change the insert orientation.

Step 1-2 : CPU Heat Sink Installation



1. Fasten the heatsink supporting-base onto the CPU socket on the main-board.

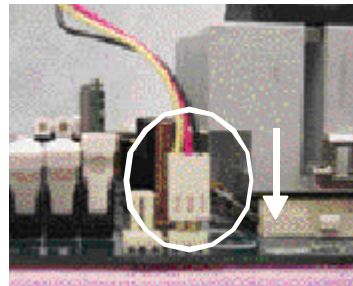

2. Make sure the CPU fan is plugged to the CPU fan connector, than install complete.

- Please use Intel approved cooling fan.
- We recommend you to apply the thermal tape to provide better heat conduction between your CPU and heatsink.
(The CPU cooling fan might stick to the CPU due to the hardening of the thermal paste. During this condition if you try to remove the cooling fan, you might pull the processor out of the CPU socket along with the cooling fan, and might damage the processor. To avoid this from happening, we suggest you to either use thermal tape instead of thermal paste, or remove the cooling fan with extreme caution.)
- Make sure the CPU fan power cable is plugged in to the CPU fan connector, this completes the installation.
- Please refer to CPU heat sink user's manual for more detail installation procedure.

Step 2: Install memory modules

The motherboard has 3 dual inline memory module (DIMM) sockets, but it can only support a maximum of 4 banks of DDR memory. DDR socket 1 uses 2 banks, DDR socket 2&3 share the remaining 2 banks. Please refer to the following tables for possible memory configurations supported. The BIOS will automatically detect memory type and size. To install the memory module, just push it vertically into the DIMM Slot. The DIMM module can only fit in one direction due to the notch. Memory size can vary between sockets.

Total Memory Sizes With Unbuffered DDR DIMM

Devices used on DIMM	1 DIMM x 64 / x 72	2 DIMMs x 64 / x 72	3 DIMMs x 64 / x 72
64 Mbit (2Mx 8x 4 banks)	128MBytes	256MBytes	256MBytes
64 Mbit (1Mx 16x 4 banks)	32MBytes	64MBytes	96MBytes
128 Mbit(4Mx 8x 4 banks)	256MBytes	512MBytes	512MBytes
128 Mbit(2Mx 16x 4 banks)	64MBytes	128MBytes	196MBytes
256 Mbit(8Mx 8x 4 banks)	512MBytes	1 GBytes	1 GBytes
256 Mbit(4Mx 16x 4 banks)	128MBytes	256MBytes	384MBytes
512 Mbit(16Mx 8x 4 banks)	1 GBytes	2GBytes	2GBytes
512 Mbit(8Mx 16x 4 banks)	256MBytes	512MBytes	768MBytes

Notes: Double-sided x 16 DDR memory devices are not supported by Intel 845E/G chipset.

DDR1	DDR2	DDR3
S	S	S
D	S	S
D	D	X
D	X	D
S	D	X
S	X	D

D: Double Sided DIMM S: Single Sided DIMM

X: Not Use

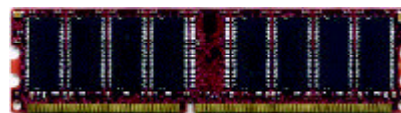

DDR



1. The DIMM socket has a notch, so the DIMM memory module can only fit in one direction.
2. Insert the DIMM memory module vertically into the DIMM socket. Then push it down.
3. Close the plastic clip at both edges of the DIMM sockets to lock the DIMM module.
Reverse the installation steps when you wish to remove the DIMM module.



⚠ When STR/DIMM LED is ON, do not install/remove DIMM from socket.

⚠ Please note that the DIMM module can only fit in one direction due to the two notches. Wrong orientation will cause improper installation. Please change the insert orientation.

Step 3: Install expansion cards

1. Read the related expansion card's instruction document before install the expansion card into the computer.
2. Remove your computer's chassis cover, necessary screws and slot bracket from the computer.
3. Press the expansion card firmly into expansion slot in motherboard.
4. Be sure the metal contacts on the card are indeed seated in the slot.
5. Replace the screw to secure the slot bracket of the expansion card.
6. Replace your computer's chassis cover.
7. Power on the computer, if necessary, setup BIOS utility of expansion card from BIOS.
8. Install related driver from the operating system.

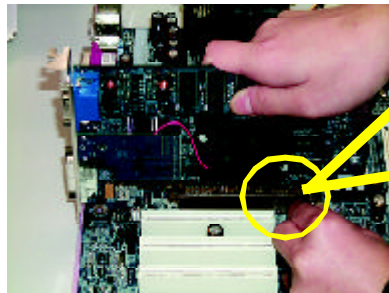

AGP Card



Please carefully pull out the small white-drawable bar at the end of the AGP slot when you try to install/ Uninstall the AGP card. Please align the AGP card to the onboard AGP slot and press firmly down on the slot. Make sure your AGP card is locked by the small white-drawable bar.

Issues To Beware Of When Installing CNR

Please use standard CNR card like the one in order to avoid mechanical problem.

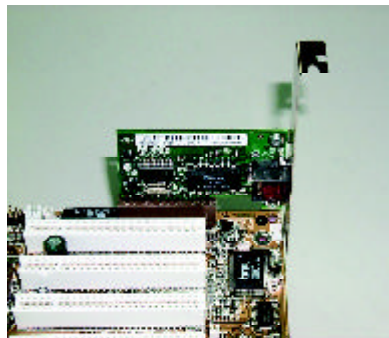

Standard CNR Card

● **Please note:**

If M/B has hardware audio (CT5880), your modem riser has been set to "Primary" automatically

Step 4: Connect ribbon cables, cabinet wires, and power supply

Step 4-1 : I/O Back Panel Introduction

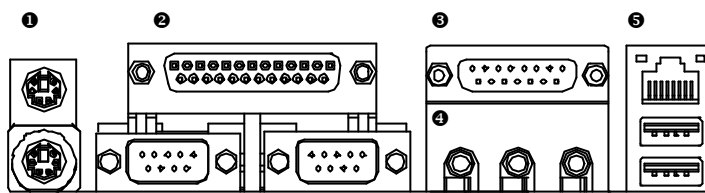

❶ PS/2 Keyboard and PS/2 Mouse Connector



PS/2 Mouse Connector
(6 pin Female)

PS/2 Keyboard Connector
(6 pin Female)

➤ This connector supports standard PS/2 keyboard and PS/2 mouse.

❷ Parallel Port and Serial Ports (COMA/COMB)

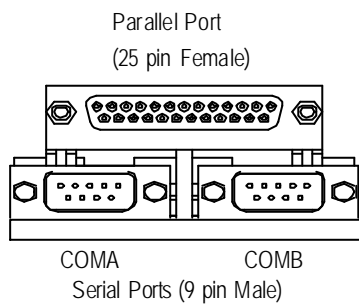

Parallel Port
(25 pin Female)

➤ This connector supports 2 standard COM ports and 1 Parallel port. Device like printer can be connected to Parallel port ; mouse and modem etc can be connected to Serial ports.

③ Game/MIDI Ports

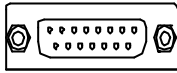

Joystick/ MIDI (15 pin Female)

- This connector supports joystick, MIDI keyboard and other relate audio devices.

④ Audio Connectors

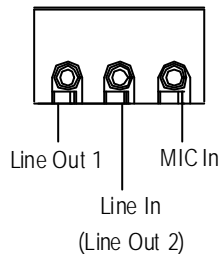

- After install onboard audio driver, you may connect speaker to Line Out jack, micro phone to MIC In jack. Device like CD-ROM , walkman etc can be connected to Line-In jack.
Please note: Line Out 1: Line Out or SPDIF (The SPDIF output is capable of providing digital audio to external speakers or compressed AC3 data to an external Dolby digital decoder). To enable SPDIF, simply insert SPDIF connector into Line Out1. Line Out1 will become SPDIF Out automatically.
To enable Four Speaker (for Creative 5880 audio only), and Line In will become Line Out2 to support second pair of stereo speakers.



If you want the detail information for " 4_Channel Audio & SPDIF " setup, please download 8IEX Series manual (Complete Version) from Gigabyte web. <http://www.gigabyte.com.tw>.

⑤ USB/LAN Connector

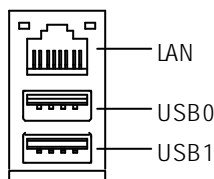

- Before you connect your device(s) into USB connector(s), please make sure your device(s) such as USB keyboard, mouse, scanner, zip, speaker..etc. Have a standard USB interface. Also make sure your OS (Win 95 with USB supplement, Win98, Windows 2000, Windows ME, WinNT with SP 6) supports USB controller. If your OS does not support USB controller, please contact OS vendor for possible patch or driver upgrade. For more information please contact your OS or device(s) vendors.

Step 4-2 :Connectors & Jumper Setting Introduction

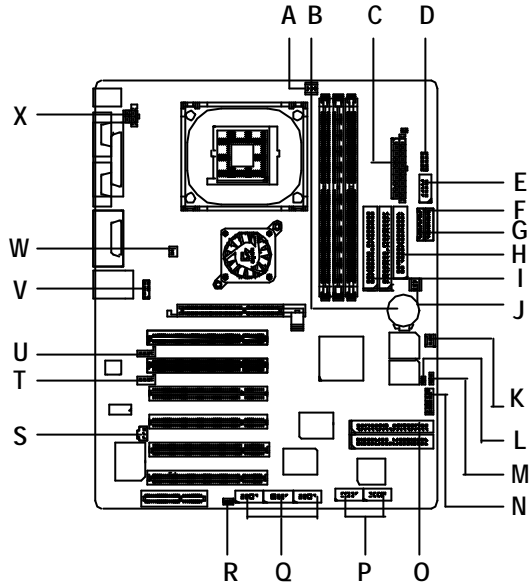

A) CPU_FAN	M) CLR_CMOS
B) BATTERY	N) F_PANEL
C) ATX	O) IDE3/IDE4 (**)
D) IR/CIR	P) F_USB1/F_USB2
E) SC	Q) 1394-1/1394-2/1394-3 (**)
F) MS (**)	R) WOL(**)
G) SD (**)	S) SPDIF
H) FDD	T) AUX_IN
I) IDE1/IDE2	U) CD_IN
J) PWR_FAN	V) F_AUDIO_I
K) SYS_FAN	W) NB_FAN
L) CI	X) AUX_12V

* For GA-8IEX Only. ** For GA-8IEXP Only.

X) AUX_12V(+12V Power Connector) ➤ This connector (ATX +12V) is used only for CPU Core Voltage.

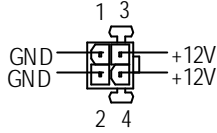

C) ATX (ATX Power Connector) ➤ AC power cord should only be connected to your power supply unit after ATX power cable and other related devices are firmly connected to the mainboard.

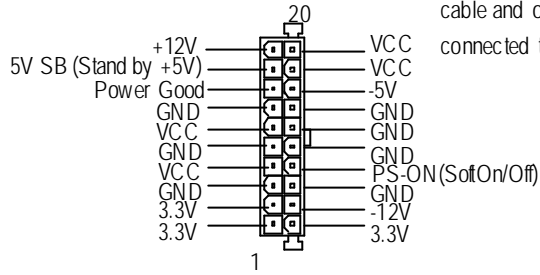

A) CPU_FAN (CPU Fan Connector) ➤ Please note, a proper installation of the CPU cooler is essential to prevent the CPU from running under abnormal condition or damaged by overheating. The CPU fan connector supports Max. current up to 600mA .



K) SYS_FAN (System Fan Connector) ➤ These connector allow you to link with the cooling fan on the system case to lower the system temperature.



J) PWR_FAN (Power Fan Connector)



W) NB_FAN

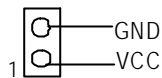

- If you installed wrong direction, the Chip Fan will not work. Sometimes will damage the Chip Fan. (Usually black cable is GND)

I,H) Floppy/ IDE1 / IDE2 Connector
(Primary/Secondary]

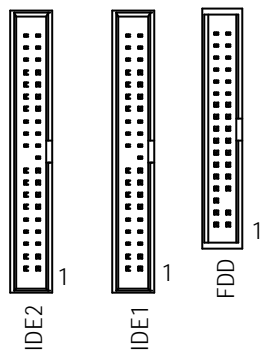

- Important Notice:
Please connect first harddisk to IDE1 and connect CD_ROM to IDE2.
The red stripe of the ribbon cable must be the same side with the Pin1.

O) IDE3/IDE4 Connector
(RAID/ATA133,Green Connector)(**)

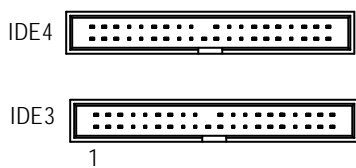

-  **Important Notice:**
1. The red stripe of the ribbon cable must be the same side with the Pin1.
 2. If you wish to use IDE3 and IDE4, please use it in unity with BIOS (either RAID or ATA133). Then, install the correct driver to have proper operation. For details, please refer to the RAID manual.

If you want the detail information for "RAID" setup , please download 8EX Series manual (Complete Version) from Gigabyte web. <http://www.gigabyte.com.tw>.

R) WOL(Wake on LAN)()**

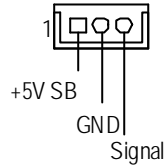

➤ This connector allows the remote servers to manage the system that installed this mainboard via your network adapter which also supports WOL.

S) SPDIF

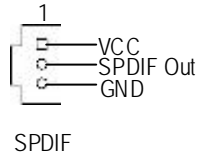

➤ The SPDIF output is capable of providing digital audio to external speakers or compressed AC3 data to an external Dolby Digital Decoder. Use this feature only when your stereo system has digital input function.

U) CD_IN (CD Audio Line In Connector)

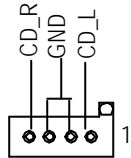

➤ Connect CD-ROM or DVD-ROM audio out to the connector.

T) AUX_IN (AUX In Connector)

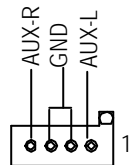

➤ Connect other device(such as PCI TV Tuner audio out)to the connector.

* For GA-8IEX Only. ** For GA-8IEXP Only.

**P) F_USB1 / F_USB2
(Front USB Connector, Yellow Connector)**

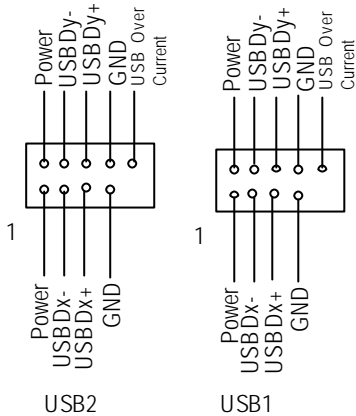

- Be careful with the polarity of the front panel USB connector. Check the pin assignment while you connect the front panel USB cable. Please contact your nearest dealer for optional front panel USB cable.

V) F_AUDIO_I (F_AUDIO Connector)

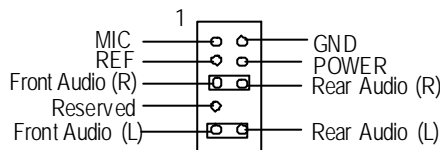

- If you want to use Front Audio connector, you must remove 5-6, 9-10 Jumper. In order to utilize the front audio header, your chassis must have front audio connector. Also please make sure the pin assignment on the cable is the same as the pin assignment on the MB header. To find out if the chassis you are buying support front audio connector, please contact your dealer.

Q) 1394-1/1394-2/1394-3 (IEEE1394 Connector, Grey Connector) ()**

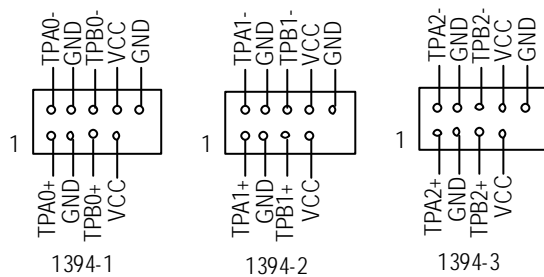

- **Please Note:** Serial interface standard set by Institute of Electrical and Electronics Engineers, which has features like high speed, high bandwidth and hot plug.

D) IR/CIR (IR/CIR)

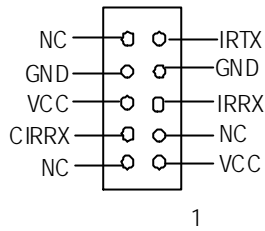

- Make sure the pin 1 on the IR device is aligning with pin one the connector. To enable the IR/CIR function on the board, you are required to purchase an option IR/CIR module. For detail information please contact your authorized Giga-Byte distributor.
To use IR function only, please connect IR module to Pin1 to Pin5.

E) SC(Smart Card Interface,Black Connector)

G)SD(MMC) (Secure Digital Memory Card Interface,Red exide Connector) ()**

F)MS (Memory Stick Interface,White Connector) ()**

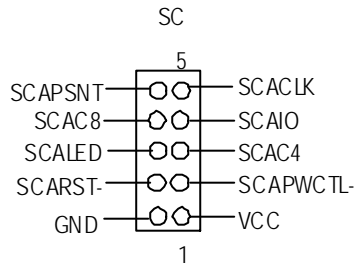

- The device could be expanded for reading Flash Memory, such as SD(Security Digital), MS (Memory Stick) and Smart Card Reader Connector. The Smart IC Card could increase security in authenticating online transactions; the card reader device (inquire local distributor) made by Third Party could be purchased by users.

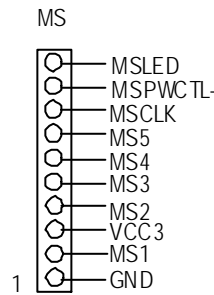
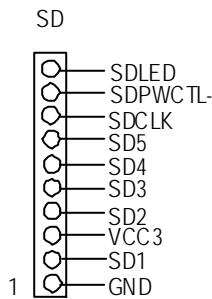

**** For GA-8IEXP Only.**

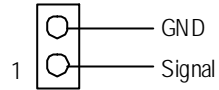
L) CI

- This 2 pin connector allows y our system to enable or disable the system alarm if the system case begin remove.

M) CLR_CMOS (Clear CMOS)

1-2 close: Clear CMOS



2-3 close: Normal

- You may clear the CMOS data to its default values by this jumper.

Default doesn't include the "Shunter" to prevent from improper use this jumper. To clear CMOS, temporarily short 1-2 pin.

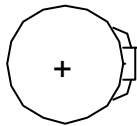
B) BATTERY (Battery)**CAUTION**

- ❖ Danger of explosion if battery is incorrectly replaced.
- ❖ Replace only with the same or equivalent type recommended by the manufacturer.
- ❖ Dispose of used batteries according to the manufacturer's instructions.

N) F_PANEL (2x7 pins connector)

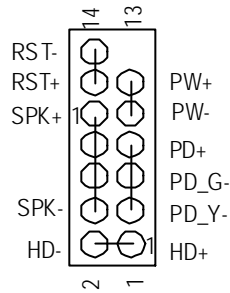

HD (IDE Hard Disk Active LED)	Pin 1: LED anode(+) Pin 2: LED cathode(-)
SPK (Speaker Connector)	Pin 1: VCC(+) Pin 2- Pin 3: NC Pin 4: Data(-)
RST (Reset Switch)	Open: Normal Operation Close: Reset Hardware System
PD+/PD_G-/PD_Y-(Power LED)	Pin 1: LED anode(+) Pin 2: LED cathode(-) Pin 3: LED cathode(-)
PW (Soft Power Connector)	Open: Normal Operation Close: Power On/Off

- Please connect the power LED, PC speaker, reset switch and power switch etc of your chassis front panel to the F_PANEL connector according to the pin assignment above.

Chapter 3 BIOS Setup

BIOS Setup is an overview of the BIOS Setup Program. The program that allows users to modify the basic system configuration. This type of information is stored in battery-backed CMOS RAM so that it retains the Setup information when the power is turned off.

ENTERING SETUP

Powering ON the computer and pressing immediately will allow you to enter Setup. If you require more advanced BIOS settings, please go to "Advanced BIOS" setting menu. To enter Advanced BIOS setting menu, press "Ctrl+F1" key on the BIOS screen.

GETTING HELP

Main Menu

The on-line description of the highlighted setup function is displayed at the bottom of the screen.

Status Page Setup Menu / Option Page Setup Menu

Press F1 to pop up a small help window that describes the appropriate keys to use and the possible selections for the highlighted item. To exit the Help Window press <Esc>.

The Main Menu

Once you enter Award BIOS CMOS Setup Utility, the Main Menu will appear on the screen. The Main Menu allows you to select from eight setup functions and two exit choices. Use arrow keys to select among the items and press <Enter> to accept or enter the sub-menu.

Dual BIOS / Q-Flash Utility

After power on the computer, pressing immediately during POST (Power On Self Test) it will allow you to enter Award BIOS CMOS SETUP, then press <F8> to enter DualBIOS/Q-Flash utility. *If you want to detail information for "DualBIOS/Q-Flash Utility", please download this manual from Gigabyte web <http://www.gigabyte.com.tw>.*

Select Language

You can press <F3> to select multi language. There are 7 languages available, including English, Japanese, French, Spanish, Germany, Simplified Chinese, Traditional Chinese.

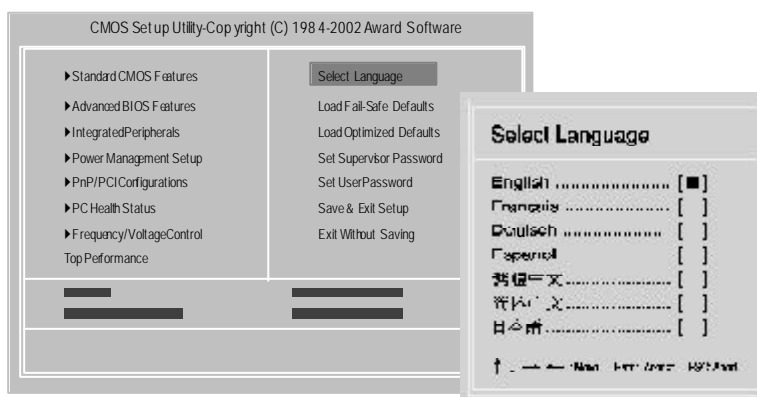

- **Standard CMOS Features**
This setup page includes all the items in standard compatible BIOS.
- **Advanced BIOS Features**
This setup page includes all the items of Award special enhanced features.
- **Advanced Chips et Features**
This setup page includes all the items of chipset special features.
We would not suggest you change the chipset default setting unless you really need it.
- **Integrated Peripherals**
This setup page includes all onboard peripherals.
*We would not suggest you change the default setting unless you really need it.
For power End-User use only.*
- **Power Management Setup**
This setup page includes all the items of Green function features.
*We would not suggest you change the default setting unless you really need it.
For power End-User use only.*
- **PnP/PCI Configurations**
This setup page includes all the configurations of PCI & PnP ISA resources.
*We would not suggest you change the default setting unless you really need it.
For power End-User use only.*
- **PC Health Status**
This setup page is the System auto detect Temperature, voltage, fan, speed.
- **Frequency/Voltage Control**
This setup page is control CPU's clock and frequency ratio.
For power End-User use only.
- **Top Performance Defaults**
Top Performance Defaults indicates the value of the system parameters which the system would be in best performance configuration.
- **Select Language**
This setup page is select multi language.
- **Load Fail-Safe Defaults**
Fail-Safe Defaults indicates the value of the system parameters which the system would be in safe configuration.

- **Load Optimized Defaults**
Optimized Defaults indicates the value of the system parameters which the system would be in best performance configuration.
- **Set Supervisor password**
Change, set, or disable password. It allows you to limit access to the system and Setup, or just to Setup.
- **Set User password**
Change, set, or disable password. It allows you to limit access to the system.
- **Save & Exit Setup**
Save CMOS value settings to CMOS and exit setup.
- **Exit Without Saving**
Abandon all CMOS value changes and exit setup.

Load Optimized Default

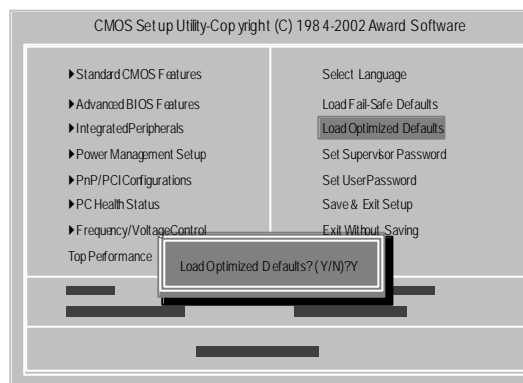

☞ **Load Optimized Defaults**

Selecting this field loads the factory defaults for BIOS and Chipset Features which the system automatically detects.

To Load Optimized, move cursor, by pressing the arrow keys on the keyboard, to highlight the optimized default and press enter key then press "Y" if you decide to load this option.

Save & Exit Setup

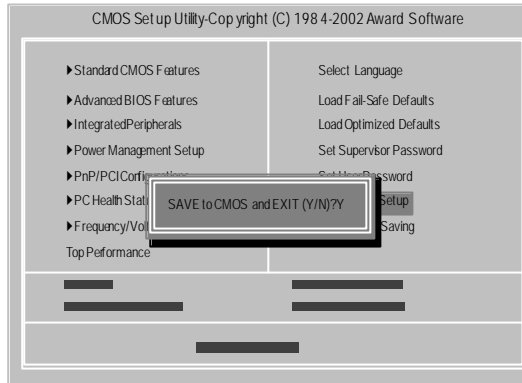

To save exit the BIOS setting screen press F10, and press "Y" if you want to save setting. By typing "N" or "ESC" will take you back to setup screen.



If you want the detail information for BIOS setup, please download 8IEXP (Complete Version) manual from Gigabyte web.

<http://www.gigabyte.com.tw>

Chapter 4 Driver Installation

Picture below are shown in Windows XP (IUCD driver version 2.0)

Insert the driver CD-title that came with your motherboard into your C D-ROM driver, the driver CD-title will auto start and show the installation guide. If not, please double click the CD-ROM device icon in "My computer", and execute the setup.exe.

A. Installing Intel 845-E Chipset Driver

Please install this driver as the first priority. this item installs the chipset driver utility that enables Plug-n-Plug INF support for Intel chipset component.

B. Installing Sound Driver

Click this item to install sound driver.

C. Installing LAN Driver

Click this item to install LAN driver.



If you want the detail information for Driver installation, please download 8IEXP (Complete Version) manual from Gigabyte web.

<http://www.gigabyte.com.tw>



Before the end of May 2002, Intel® didn't announce ICH4 USB2.0 driver. We'll put the driver on GIGABYTE's website asap. (<http://www.gigabyte.com.tw>). Please go to the website to get detail information.

Appendix A: Intel 845-E Chipset Driver Installation

Follow the setup that showing on the screen to install the Utility.



In order to install the driver successfully, please refer to the following installation procedures.



** For GA-8IEXP Only.

Appendix B: Creative CT5880 Sound Driver

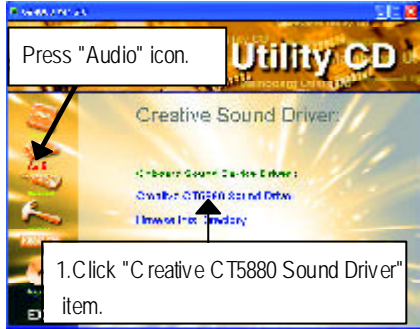

Appendix C: Intel 82562 Network Driver

If you would like to manually install LAN driver, please refer to "Driver Information" or download 8IEXP (Complete Version) manual from Gigabyte web. <http://www.gigabyte.com.tw>.

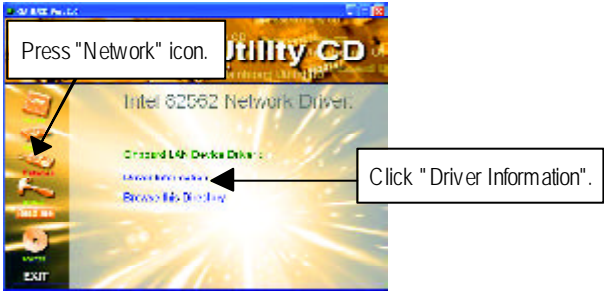

Chapter 5 BIOS Flash Procedure

BIOS update procedure:

Method 1:

If your OS is Win9X, we recommend that you used Gigabyte @BIOS™ Program to flash BIOS.

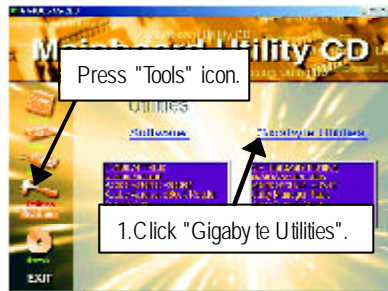

(1)

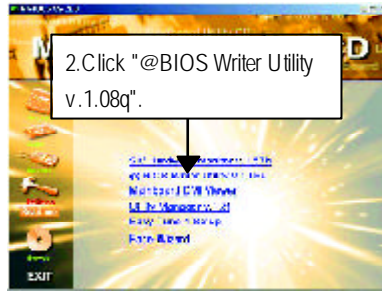

(2)



(3)

Methods and steps:

- I. Update BIOS through Internet
 - a. Click "Internet Update" icon
 - b. Click "Update New BIOS" icon
 - c. Select @BIOS™ sever ("Gigabyte @BIOS™ sever 1 in Taiwan" and "Gigabyte @BIOS™ sever 2 in Taiwan" are available for now, the others will be completed soon)
 - d. Select the exact model name on your motherboard
 - e. System will automatically download and update the BIOS.

II. Update BIOS NOT through Internet:

- a. Do not click "Internet Update" icon
- b. Click "Update New BIOS"
- c. Please select "All Files" in dialog box while opening the old file.
- d. Please search for BIOS unzip file, downloading from internet or any other methods (such as: 8IEXP.F1).
- e. Complete update process following the instruction.

III. Save BIOS

In the very beginning, there is "Save Current BIOS" icon shown in dialog box. It means to save the current BIOS version.

IV. Check out supported motherboard and Flash ROM:

In the very beginning, there is "About this program" icon shown in dialog box. It can help you check out which kind of motherboard and which brand of Flash ROM are supported.

Note:

- a. In method I, if it shows two or more motherboard's model names to be selected, please make sure your motherboard's model name again. Selecting wrong model name will cause the system unbooted.
- b. In method II, be sure that motherboard's model name in BIOS unzip file are the same as your motherboard's. Otherwise, your system won't boot.
- c. In method I, if the BIOS file you need cannot be found in @BIOS™ server, please go onto Gigabyte's web site for downloading and updating it according to method II.
- d. Please note that any interruption during updating will cause system unbooted.

Method 2:

We use GA-7VTX motherboard and Flash841 BIOS flash utility as example.

Please flash the BIOS according to the following procedures if you are now under the DOS mode.

Flash BIOS Procedure:

STEP 1:

(1) Please make sure your system has installed the extraction utility such as winzip or pkunzip.

Firstly you have to install the extraction utility such as winzip or pkunzip for unzip the files. Both of these utilities are available on many shareware download pages like

<http://www.shareware.cnet.com>

STEP 2: Make a DOS boot diskette. (See example: Windows 98 O.S.)

Beware: Windows ME/2000 are not allowed to make a DOS boot diskette.

(1) With an available floppy disk in the floppy drive. Please leave the diskette "UN-write protected" type. Double click the "My Computer" icon from Desktop, then click "3.5 diskette (A)" and right click to select "Format (M)"

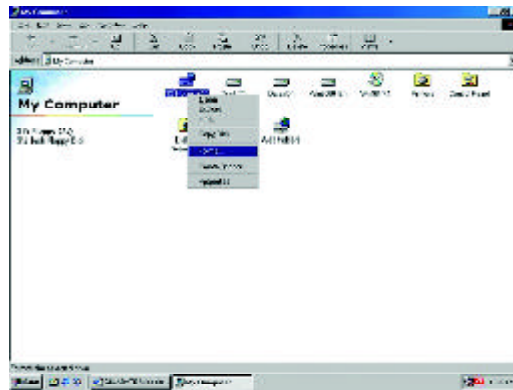

(2) Select the "Quick (erase)" for Format Type, and pick both "Display summary when finished" and "Copy system files", after that press "Start". That will format the floppy and transfer the needed system files to it.

Beware: This procedure will erase all the prior data on that floppy, so please proceed accordingly.

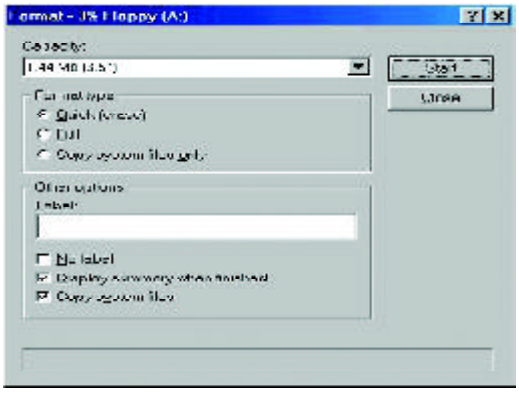

(3) After the floppy has been formatted completely, please press "Close".

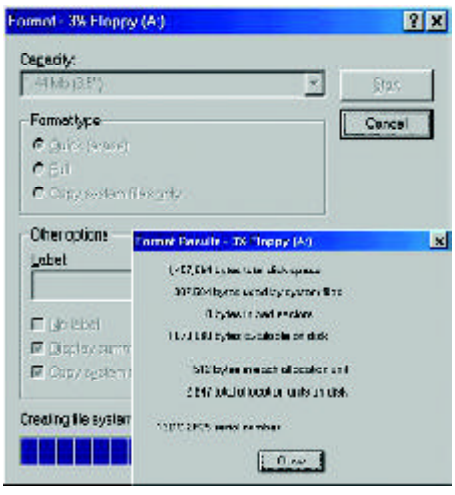

- (3) We use GA-7VTX motherboard as example. Please select GA-7VTX by Model or Chipset optional menu to obtain BIOS flash files.

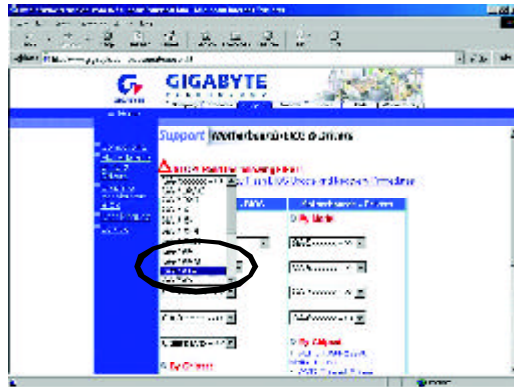

- (4) Select an appropriate BIOS version (For example: F4), and click to download the file. It will pop up a file download screen, then select the "Open this file from its current location" and press "OK".

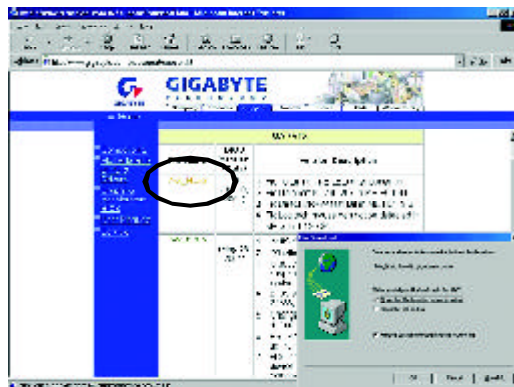

(5) At this time the screen shows the following picture, please click "Extract" button to unzip the files.

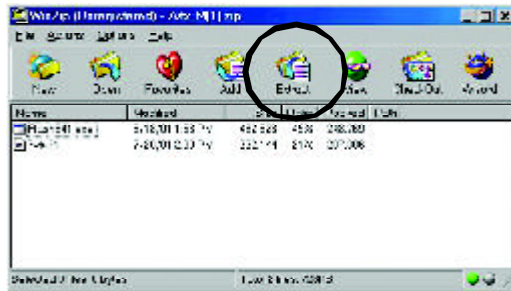

(6) Please extract the download files into the clean bootable floppy disk A mentioned in STEP 2, and press "Extract".

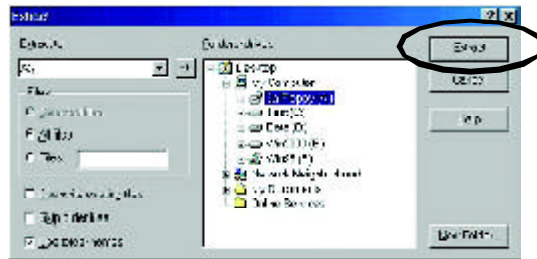

STEP 4: Make sure the system will boot from the floppy disk.

- (1) Insert the floppy disk (contains bootable program and unzip file) into the floppy drive A. Then, restart the system. The system will boot from the floppy disk. Please press key to enter BIOS setup main menu when system is boot up.



- (2) Once you enter the BIOS setup utility, the main menu will appear on the screen. Use the arrows to highlight the item "BIOS FEATURES SETUP".

AMIBIOS SIMPLE SETUP UTILITY - VERSION 1.24b (C) 1999 American Megatrends, Inc. All Rights Reserved	
STANDARD CMOS SETUP BIOS FEATURES SETUP CHIPSET FEATURES SETUP POWER MANAGEMENT SETUP PNP/ PC CONFIGURATION LOAD BIOS DEFAULTS LOAD SETUP DEFAULTS	INTEGRATED PERIPHERALS HARDWARE MONITOR & MISC SETUP SUPERVISOR PASSWORD USER PASSWORD IDE HDD AUTO DETECTION SAVE & EXIT SETUP EXIT WITHOUT SAVING
ESC: Quit ↑↓←→ : Select Item (Shift)F2 : Change Color F5: Old Values F6: Load BIOS Defaults F7: Load Setup Defaults F10: Save & Exit	
Time, Date, Hard Disk Type...	

(3) Press "Enter" to enter "BIOS FEATURES SETUP" menu. Use the arrows to highlight the item "1st Boot Device", and then use the "Page Up" or "Page Down" keys to select "Floppy".

AMIBIOS SETUP - BIOS FEATURES SETUP	
(C) 2001 American Megatrends, Inc. All Rights Reserved	
1st Boot Device : Floppy	
2nd Boot Device : IDE-0	
3rd Boot Device : CDROM	
S.M.A.R.T. for Hard Disks : Disabled	
BootUp Num-Lock : On	ESC: Quit ↑↓←→: Select Item
Floppy Drive Seek : Disabled	F1 : Help PU/PD/+/-: Modify
PasswordCheck : Setup	F5 : Old Values (Shift) F2: Color
	F6 : Load BIOS Defaults
	F7 : Load Setup Defaults

(4) Press "ESC" to go back to previous screen. Use the arrows to highlight the item "SAVE & EXIT SETUP" then press "Enter". System will ask "SAVE to CMOS and EXIT (Y/N)?" Press "Y" and "Enter" keys to confirm. Now the system will reboot automatically, the new BIOS setting will be taken effect next boot-up.

AMIBIOS SIMPLE SETUP UTILITY - VERSION 1.24b	
(C) 2001 American Megatrends, Inc. All Rights Reserved	
STANDARD CMOS SETUP	INTEGRATED PERIPHERALS
BIOS FEATURES SETUP	HARDWARE MONITOR & MISC SETUP
CHIPSET FEATURES SETUP	SUPERVISOR PASSWORD
POWER MANAGEMENT SETUP	USER PASSWORD
PNP/PC CONFIG	Save to CMOS and EXIT (Y/N)? Y
LOAD BIOS DEFAULTS	SAVE & EXIT SETUP
LOAD SETUP DEFAULTS	EXIT WITHOUT SAVING
ESC: Quit ↑↓←→ : Select Item (Shift) F2 : Change Color F5: Old Values	
F6: Load BIOS Defaults F7: Load Setup Defaults F10: Save & Exit	
Save Data to CMOS & Exit SETUP	

STEP 5: BIOS flashing.

- (1) After the system boot from floppy disk, type "A:\> dir/w" and press "Enter" to check the entire files in floppy A. Then type the "BIOS flash utility" and "BIOS file" after A:\>. In this case you have to type "A:\> Flash841 7VTX.F4" and then press "Enter".

```
Starting Windows 98..

Microsoft(R) Windows 98
  © Copyright Microsoft Corp 1981-1999

A:\> dir/w
  Volume in drive A has no label
  Volume Serial Number is 16EB-353D
  Directory of A:\
  COMMAND.COM  7VTX.F4  FLASH841.EXE
                3 file(s)  838,954 bytes
                0 dir(s)  324,608 bytes free

A:\> Flash841 7VTX.F4
```

- (2) Now screen appears the following Flash Utility main menu. Press "Enter", the highlighted item will locate on the model name of the right-upper screen. Right after that, press "Enter" to start BIOS Flash Utility.

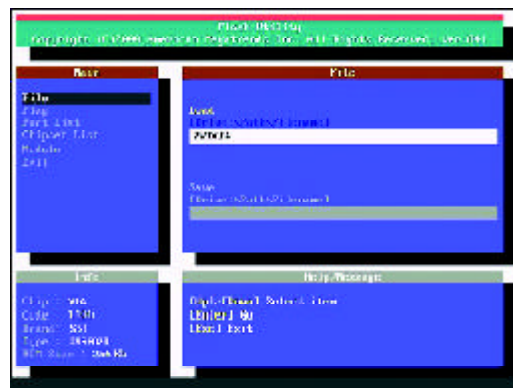

(3) It will pop up a screen and asks "Are you sure to flash the BIOS?" Press [Enter] to continue the procedure, or press [ESC] to quit.

Beware: Please do not turn off the system while you are upgrading BIOS. It will render your BIOS corrupted and system totally inoperative.

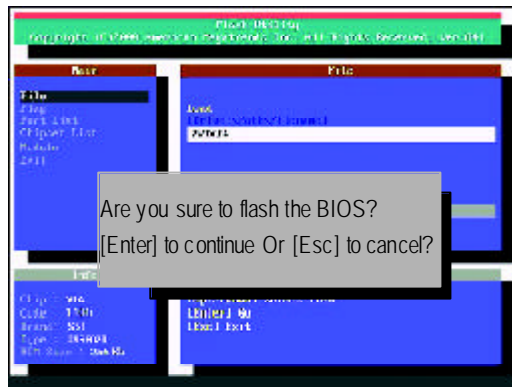

(4) The BIOS flash completed. Please press [ESC] to exit Flash Utility.

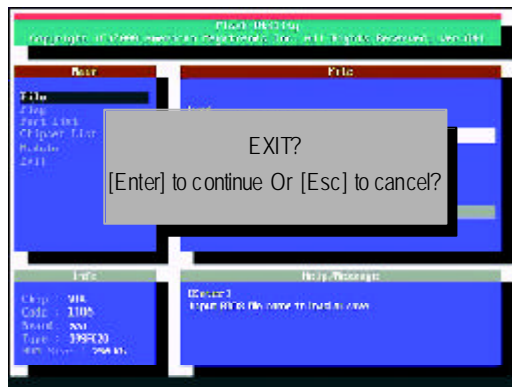

STEP 6: Load BIOS defaults.

Normally the system redetects all devices after BIOS has been upgraded. Therefore, we highly recommend reloading the BIOS defaults after BIOS has been upgraded. This important step resets everything after the flash.

- (1) Take out the floppy diskette from floppy drive, and then restart the system. The boot up screen will indicate your motherboard model and current BIOS version.

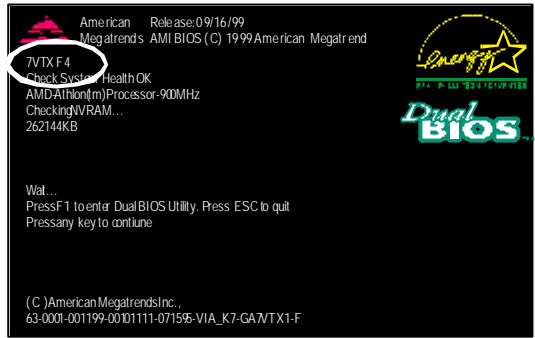

- (2) Don't forget to press key to enter BIOS setup again when system is boot up. Use the arrows to highlight the item "LOAD SETUP DE FAULTS" then press "Enter". System will ask "Load Setup Defaults (Y/N)?" Press "Y" and "Enter" keys to confirm.

AMIBIOS SIMPLE SETUP UTILITY - VERSION 1.24b (C) 2001 American Megatrends, Inc. All Rights Reserved	
STANDARD CMOS SETUP	INTEGRATED PERIPHERALS
BIOS FEATURES SETUP	HARDWARE MONITOR & MISC SETUP
CHIPSET FEATURES SETUP	SUPERVISOR PASSWORD
POWER MANAGEMENT	
PNP/PCICONFIG	<div style="border: 2px solid gray; padding: 5px;"> Load Setup Defaults? (Y/N)?N </div>
LOAD BIOS DEFAULTS	SAVE & EXIT SETUP
LOAD SETUP DEFAULTS	EXIT WITHOUT SAVING
ESC: Quit ↑↓←→ : Select Item (Shift)F2 : Change Color F5: Old Values F6: Load BIOS Defaults F7: Load Setup Defaults F10: Save & Exit	
Load Setup Defaults	

(3) Use the arrows to highlight the item "SAVE & EXIT SETUP" and press "Enter". System will ask "SAVE to CMOS and EXIT (Y/N)?" Press "Y" and "Enter" keys to confirm. Now the system will reboot automatically, the new BIOS setting will be taken effect next boot-up.

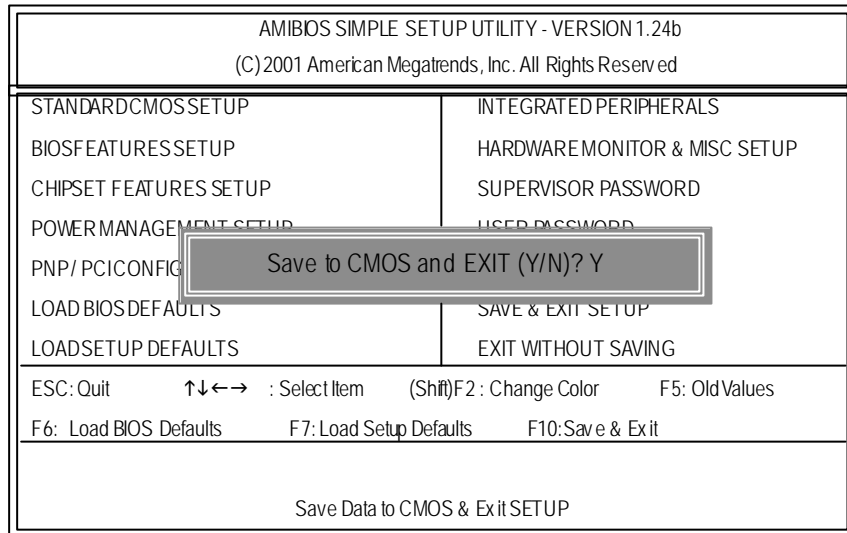

(4) Congratulate you have accomplished the BIOS flash procedure.