

M7NCD

FCC Information and Copyright

This equipment has been tested and found to comply with the limits of a Class B digital device, pursuant to Part 15 of the FCC Rules. These limits are designed to provide reasonable protection against harmful interference in a residential installation. This equipment generates, uses and can radiate radio frequency energy and, if not installed and used in accordance with the instructions, may cause harmful interference to radio communications. There is no guarantee that interference will not occur in a particular installation.

The vendor makes no representations or warranties with respect to the contents here of and specially disclaims any implied warranties of merchantability or fitness for any purpose. Further the vendor reserves the right to revise this publication and to make changes to the contents here of without obligation to notify any party beforehand.

Duplication of this publication, in part or in whole, is not allowed without first obtaining the vendor's approval in writing.

The content of this user's manual is subject to be changed without notice and we will not be responsible for any mistakes found in this user's manual. All the brand and product names are trademarks of their respective companies.

Content

LAYOUT OF M7NCD	1
COMPONENT INDEX	2
ENGLISH	3
M7NCD Features.....	3
Package contents.....	4
How to setup Jumper.....	5
CPU Installation.....	5
DDR DIMM Modules: DIMMB1, DIMMB2.....	6
Jumpers, Headers, Connectors & Slots.....	7
DEUTSCH	14
Spezifikationen von M7NCD.....	14
Verpackungsinhalt.....	15
Einstellung der Jumper.....	16
Installation der CPU.....	16
DDR-DIMM-Modules: DIMMB1, DIMMB2.....	17
Jumpers, Headers, Anschlüsse & Slots.....	18
WATCHDOG TECHNOLOGY	26
STUDIOFUN!™	27
Introduction.....	27
Hardware Requirements.....	27
Installation Procedure.....	27
Booting to StudioFun!.....	29
Media control.....	30
Control Panel.....	31
Software Details.....	32
Select Region.....	35
Screensaver.....	36
Display Settings.....	37
File Manager.....	37
WARPSPEEDER	39
Introduction.....	39
System Requirement.....	39
Installation.....	40
Usage.....	41
TROUBLE SHOOTING	49
PROBLEMLÖSUNG	50

Layout of M7NCD

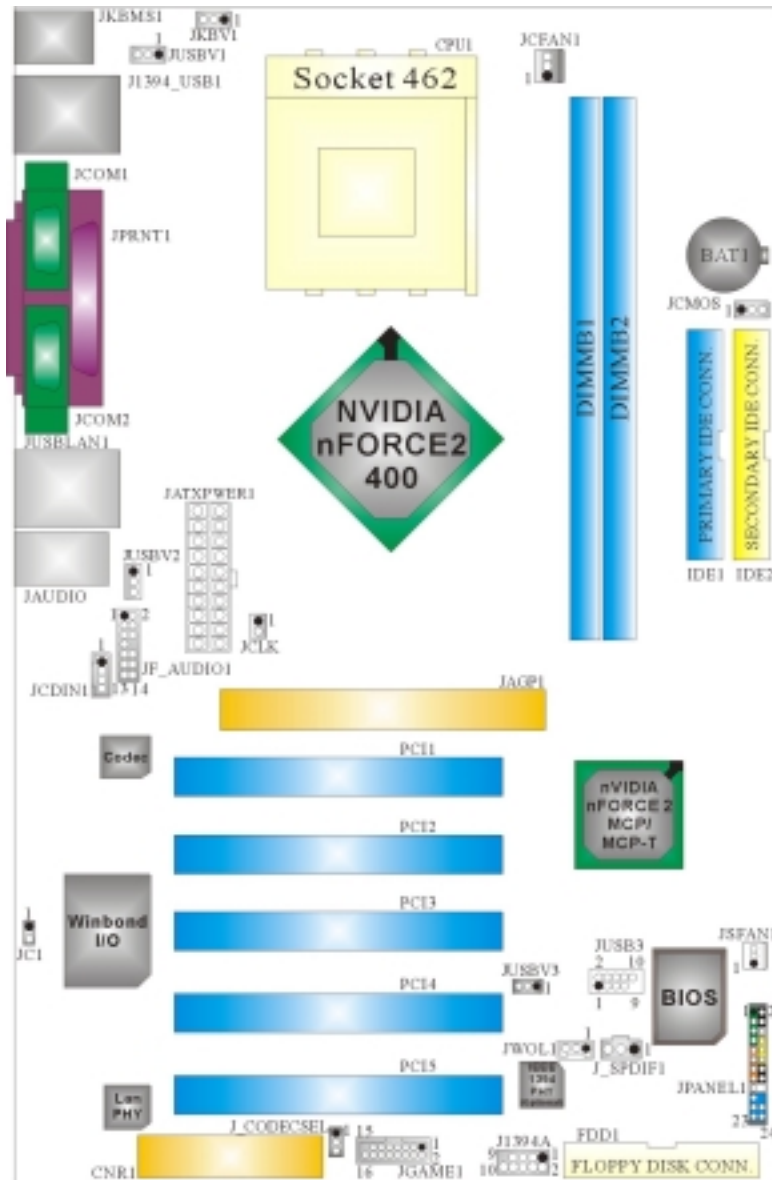

Component Index

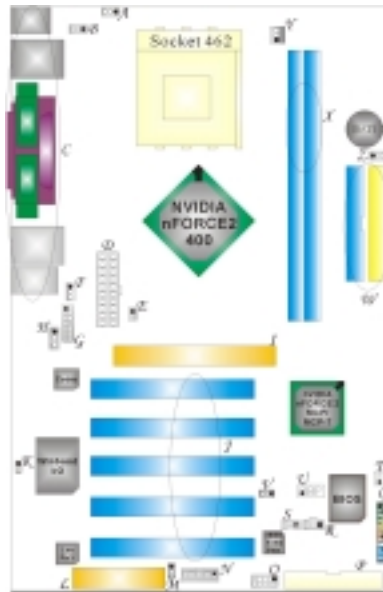

- | | |
|--|--|
| A. Power Source Selection for Keyboard and Mouse (JKBV1) | M. CNR Codec/ Onboard Selection (J_CODECSEL) |
| B. Power Source Selection for USB (JUSBV1) | N. Game Port Header (JGAME1) * |
| C. Back Panel Connector | O. Front 1394 Header (J1394A) * |
| D. ATX Power Connector (JATXPWER1) | P. Floppy Disk Connector (FDD1) |
| E. Safe/ User Mode Selection (JCLK) | Q. Front Panel Connector (JPANEL1) |
| F. Power Source Selection for USB (JUSBV2) | R. Digital Audio Connector (J_SPDIF1) * |
| G. Front Audio Header (JF_AUDIO1) | S. Wake On LAN Header (JWOL1) |
| H. CD-ROM Audio-In Header (JCDIN1) | T. System FAN Header (JSFAN1) |
| I. Accelerated Graphics Port Slot (JAGP1) | U. Front USB Header (JUSB3) |
| J. PCI BUS Slots (PCI 1-5) | V. Power Source Selection for USB (JUSBV3) |
| K. Case Open Connector (JC1) | W. IDE Connectors (IDE1-2) |
| L. Communication Network Riser Slot (CNR1) | X. DIMM Modules (DIMMB1-2) |
| | Y. CPU Fan Connector (JCFAN1) |
| | Z. Clear CMOS (JCMOS) |

* optional

English

M7NCD Features

A. Hardware

CPU

- Provides Socket-462.
- Supports the AMD® processor up to XP 3200+.
- Front Side Bus at 266/333/400 MHz.

Chipset

- North Bridge: nVIDIA nFORCE2 400.
- South Bridge: nVIDIA nFORCE2 MCP/ MCP-T.

Main Memory

- Supports up to 2 DDR devices.
- Supports 266/333/400MHz (without ECC) DDR devices.
- Maximum memory size of 2GB.

Super I/O

- Chip: Winbond W83627HF.

1394A Chip (optional)

- Chip: RTL8801B.
- Supports 2 ports with transfer up to 400 mbps.

LAN (optional)

- Chip: RTL8201BL.
- Dual Speed - 10/100 Mbps.
- Half and Full Duplex.
- Auto Negotiation: 10/ 100, Full/ Half Duplex

Slots

- Five 32-bit PCI bus master slots.
- One CNR slot.
- One AGP: ①AGP3.0 8X interface at 533Mb/s.
②Supports AGP 2X, 4X, 8X.

On Board IDE

- Supports four IDE disk drives.
- Supports PIO Mode 4, Master Mode and Ultra DMA 33/66/100/133 Bus Master Mode.

On Board AC'97 Sound Codec

- Chip: ALC650.
- Compliant with AC'97 specification.

-
- AC'97 2.2 interface.
 - Supports 6 channels.

On Board Peripherals

a. Rear side

- 2 serial ports.
- 1 parallel port. (SPP/EPP/ECP mode)
- Audio ports in vertical position.
- 1 LAN port. (optional)
- PS/2 mouse and PS/2 keyboard.
- 4 USB2.0 ports.
- 1 IEEE 1394A (FireWire) Connector. (optional)

b. Front Side

- 1 floppy port supports 2 FDDs with 360K, 720K, 1.2M, 1.44M and 2.88Mbytes.
- 2 USB2.0 ports.
- 1 front audio header.
- 1 IEEE 1394A (FireWire) Connector. (optional)

Dimensions

- ATX Form Factor: 19.9cm X 30.4cm (W X L)

B. BIOS & Software

BIOS

- Award legal Bios.
- APM1.2.
- ACPI.
- USB Function.

Software

- Supports CPU Savior™, 9th Touch™, FLASHER™, WinFlasher™, StudioFun!™ (optional) and Watchdog™.
- Offers the highest performance for Windows 98 SE, Windows 2000, Windows Me, Windows XP, SCO UNIX etc.

Package contents

- HDD Cable X1
- FDD Cable X1
- User's Manual X1
- USB Cable X1 (optional)
- Rear I/O Panel for ATX Case X1 (optional)
- Fully Setup Driver CD X1
- StudioFun! Application CD X1 (optional)

How to setup Jumper

The illustration shows how jumpers are setup. When the Jumper cap is placed on pins, the jumper is "**close**". If no jumper cap is placed on the pins, the jumper is "**open**". The illustration shows a 3-pin jumper whose pin 1 and 2 are "**close**" when jumper cap is placed on these 2 pins.



Jumper close



Jumper open

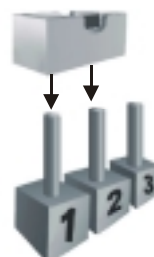

Pin1-2 close

CPU Installation

Step1: Pull the lever sideways away from the socket and then raise the lever up to a 90-degree angle.

Step2: Look for the white dot/cut edge. The white dot/cut edge should point towards the lever pivot. The CPU will fit only in the correct orientation.

Step3: Hold the CPU down firmly, and then close the lever.

Step4: Put the CPU fan on the CPU and buckle it. Connect the CPU fan power cable to the JCFAN1. This completes the installation.



Step1



Step2



Step3



Step4

CPU Fan Header: JCFAN1

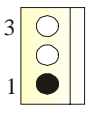
 JCFAN1	Pin No.	Assignment
	1	Ground
	2	+12V
	3	FAN rpm Rate Sense

System Fan Header: JSFAN1

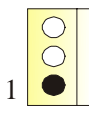
 JSFAN1	Pin No.	Assignment
	1	Ground
	2	+12V
	3	FAN rpm Rate Sense

DDR DIMM Modules: DIMMB1, DIMMB2

DRAM Access Time: 2.5V Unbuffered DDR 266/333/400 MHz Type required.

DRAM Type: 64MB/ 128MB/ 256MB/ 512MB/ 1GB DIMM Module (184 pin)

Total Memory Size with Unbuffered DIMMs

DIMM Socket Location	DDR Module	Total Memory Size (MB)
DIMMB1	64MB/128MB/256MB/512MB/1GB *1	Max is 2GB
DIMMB2	64MB/128MB/256MB/512MB/1GB *1	

Only for reference

Installing DDR Module

1. Unlock a DIMM slot by pressing the retaining clips outward. Align a DIMM on the slot such that the notch on the DIMM matches the break on the slot.
2. Insert the DIMM firmly and vertically into the slot until the retaining chip snap back in place and the Dimm is properly seated.



Jumpers, Headers, Connectors & Slots

Floppy Disk Connector: FDD1

The motherboard provides a standard floppy disk connector that supports 360K, 720K, 1.2M, 1.44M and 2.88M floppy disk types. This connector supports the provided floppy drive ribbon cables.

Hard Disk Connectors: IDE1/ IDE2

The motherboard has a 32-bit Enhanced PCI IDE Controller that provides PIO Mode 0-4, Bus Master, and Ultra DMA 33/ 66/ 100/ 133 functionality. It has two HDD connectors IDE1 (primary) and IDE2 (secondary).

The IDE connectors can connect a master and a slave drive, so you can connect up to four hard disk drives. The first hard drive should always be connected to IDE1.

Peripheral Component Interconnect Slots: PCI 1-5

This motherboard is equipped with 5 standard PCI slots. PCI stands for Peripheral Component Interconnect, and it is a bus standard for expansion cards. This PCI slot is designated as 32 bits.

Accelerated Graphics Port Slot: JAGP1

Your monitor will attach directly to that video card. This motherboard supports video cards for PCI slots, but it is also equipped with an Accelerated Graphics Port (AGP). An AGP card will take advantage of AGP technology for improved video efficiency and performance, especially with 3D graphics.

Communication Network Riser Slot: CNR1

The CNR specification is an open Industry Standard Architecture, and it defines a hardware scalable riser card interface, which supports audio, network and modem only.

Power Connectors: JATXPWR1

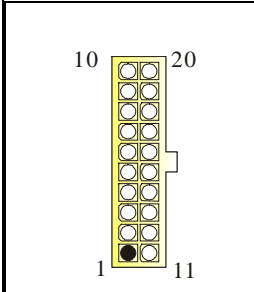

PIN	Assignment	PIN	Assignment
1	+3.3V	11	+3.3V
2	+3.3V	12	-12V
3	Ground	13	Ground
4	+5V	14	PS_ON
5	Ground	15	Ground
6	+5V	16	Ground
7	Ground	17	Ground
8	PW_OK	18	-5V
9	Standby Voltage +5V	19	+5V
10	+12V	20	+5V

Front Panel Connector: JPANEL1

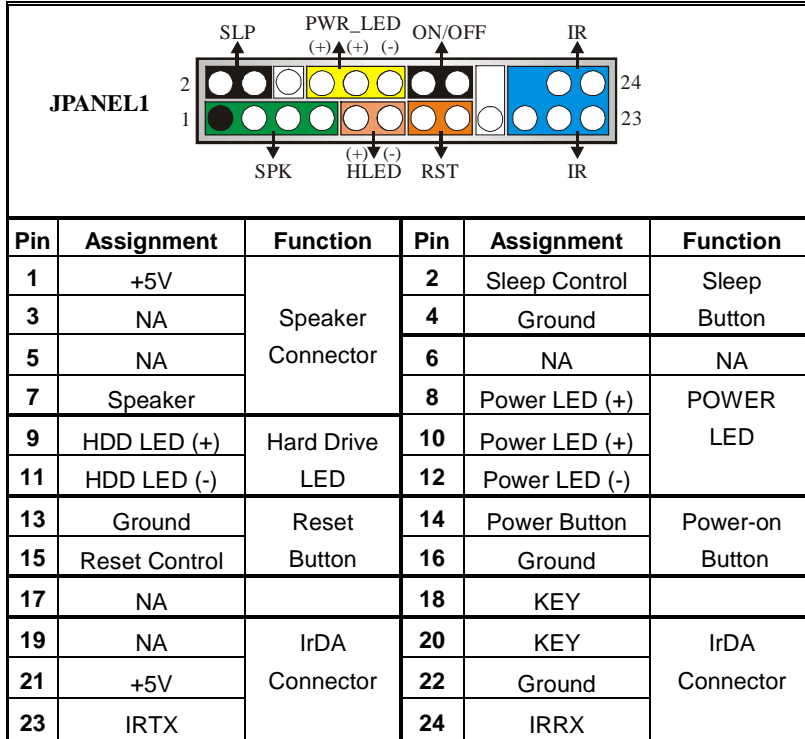

Front USB Header: JUSB3

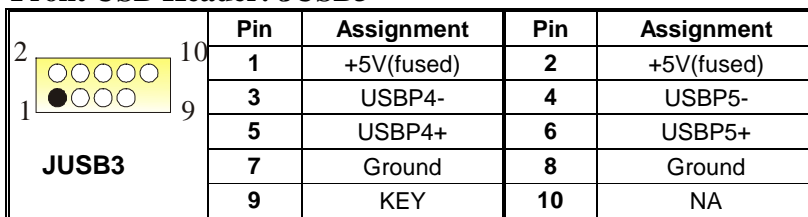

Wake On LAN Header: JWOL1

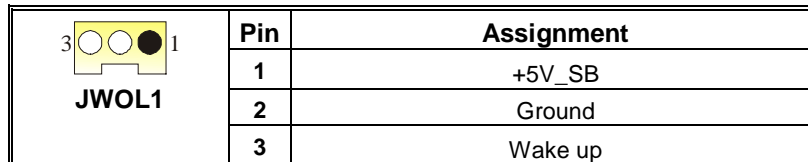

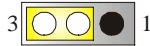

Power Source Selection for Keyboard and Mouse: JKBV1

JKBV1	Assignment	Description
 Pin 1-2 close	+5V	+5V for keyboard and mouse
 Pin 2-3 close	+5V Standby Voltage	PS/2 Mouse and PS/2 Keyboard are powered with +5V standby voltage



Note: In order to support this function "Power-on system via keyboard and mouse", "JKBV1" jumper cap should be placed on pin 2-3.

Power Source Selection for USB: JUSBV1/ JUSBV2/ JUSBV3

JUSBV1/JUSBV2/ JUSBV3	Assignment	Description
 Pin 1-2 close	+5V	JUSBV1: 5V for USB connector located at the J1394_USB1 port JUSBV2: 5V for USB connector located at the JUSBLAN1 port JUSBV3: 5V for USB connector located at the JUSB3 port
 Pin 2-3 close	+5V Standby Voltage	JUSBV1: J1394_USB1 port powered with standby voltage of 5V JUSBV2: JUSBLAN1 port powered with standby voltage of 5V JUSBV3: JUSB3 port powered with standby voltage of 5V

Note: In order to support this function "Power-on the system via USB device", "JUSBV1/JUSBV2/ JUSBV3" jumper cap should be placed on pin 2-3 respectively.

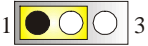
Clear CMOS Jumper: JCMOS

JCMOS	Assignment
 Pin 1-2 Close	Normal Operation (default)
 Pin 2-3 Close	Clear CMOS Data



The following procedures are for resetting the BIOS password. It is important to follow these instructions closely.

※ Clear CMOS Procedures:

1. Remove AC power line.
2. Set the jumper to "Pin 2-3 Close".
3. Wait for five seconds.
4. Set the jumper to "Pin 1-2 Close".
5. Power on the AC.
6. Reset your desired password or clear the CMOS data.

Case Open Connector: JC1

 JC1	Pin	Assignment
	1	Case Open Signal
	2	Ground

CD-ROM Audio-In Header: JCDIN1

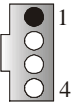

 JCDIN1	Pin	Assignment
	1	Left Channel Input
	2	Ground
	3	Ground
	4	Right Channel Input

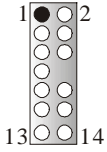
Front Panel Audio Header: JF_AUDIO1



Pin	Assignment	Pin	Assignment
1	Mic In/ Center	2	Ground
3	Mic Power/ Bass	4	Audio Power
5	Right Line Out/ Speaker Out Right	6	Right Line Out/ Speaker Out Right
7	Reserved	8	Key
9	Left Line Out/ Speaker Out Left	10	Left Line Out/ Speaker Out Left
11	Right Line In/ Right Rear Speaker	12	Right Line In/ Right Rear Speaker
13	Left Line In/ Left Rear Speaker	14	Left Line In/ Left Rear Speaker

Safe/ User Mode Selection: JCLK

JCLK	Assignment
 Pin 1-2 Close	Safe mode
 Pin 1-2 Open	User Mode (default) (133/ 166/ 200 MHz)

Note: When overclock function failed and system is unable to boot-up, please follow the instruction below:

1. Turn off the system.
2. Closed the JCLK jumper.
3. Turn on the system.
4. Enter CMOS setup menu and load defaults settings.
5. Turn off the system.
6. Open the JCLK jumper.
7. Turn on the system.

Digital Audio Connector: J_SPDIF1 (optional)

	Pin	Assignment
	1	+5V
	2	SPDIF_OUT
	3	Ground

Game Header: JGAME1 (optional)

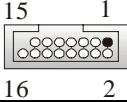
			
Pin	Assignment	Pin	Assignment
1	+5V	2	+5V
3	Joystick B Button 1	4	Joystick A Button 1
5	Joystick B Coordinate X	6	Joystick A Coordinate X
7	MIDI Output	8	Ground
9	Joystick B Coordinate Y	10	Ground
11	Joystick B Button 2	12	Joystick A Coordinate Y
13	MIDI Input	14	Joystick A Button 2
15	NA	16	+5V

Front 1394 Header: J1394A (optional)

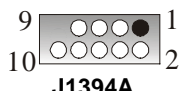
 <p>J1394A</p>	Pin	Assignment	Pin	Assignment
	1	A1+	2	A1-
	3	Ground	4	Ground
	5	B1+	6	B1-
	7	+12V	8	+12V
	9	KEY	10	NA

CNR Codec/ Onboard Selection: J_CODECSEL

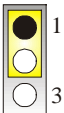
J_CODECSEL	Assignment
 <p>Pin 1-2 Close</p>	Onboard Codec is used (default)

Deutsch

Spezifikationen von M7NCD

A. Hardware

CPU

- Unterstützung für Sockel 462.
- Unterstützung für den AMD® Prozessor bis zu XP 3200+.
- FSB von 266/333/400 MHz.

Chipsatz

- Northbridge: nVIDIA nFORCE2 400.
- Southbridge: nVIDIA nFORCE2 MCP/ MCP-T.

Hauptspeicher

- Unterstützung für 2 DDR Geräte.
- Unterstützung für 266/333/400 MHz (ohne ECC) DDR Geräte.
- High-Performance 128-Bit DDR400 mit der Twin-Bank Architektur.
- Die maximale Speichergröße ist 2GB.

Super I/O

- Chip: Winbond W83627HF.

1394A Chip (optional)

- Chip: RTL8801B.
- Unterstützung für 2 1394-Ports mit der Datenübertragungsrate bis auf maximal 400Mbps.

LAN (optional)

- Chip: RTL8201BL.
- Dopplete Geschwindigkeit von 10/100 Mbps.
- Voll und Halb-Duplex.
- Auto-Negotiation: 10/ 100, Voll/Halb-Duplex

Slots

- Fünf 32-Bit PCI-Bus-Slots.
- Ein CNR-Slot.
- Ein AGP-Slot: ① AGP3.0 8X Interface bei 533Mb/s.
② Unterstützung für 2X/4X/8X AGP.

Onboard-IDE

- Unterstützung für vier IDE Diskettenlaufwerke.
- Unterstützung für PIO Modus 4, Master Modus und Ultra DMA 33/66/100/133 Bus Master Modus.

Onboard AC'97 Sound Codec

- Chip: ALC650.
- Entspricht der Spezifikation von AC'97.
- Unterstützung für AC97 2.2 Interface.
- Unterstützung für 6-Kanal Audio.

Onboard-Peripheriegeräte

a. Rückwand

- 2 serielle Schnittstellen.
- 1 parallele Schnittstelle. (SPP/EPP/ECP-Modus)
- Audio-Ports auf vertikale Position.
- 1 LAN-Port. (optional)
- Unterstützung für PS/2-Maus und PS/2-Tastatur.
- 4 USB2.0-Ports.
- 1 IEEE 1394A (FireWire) Anschluss. (optional)

b. Vorderseite

- 1 Floppy-Port mit Unterstützung für 2 Diskettenlaufwerke.(360KB, 720KB, 1.2MB, 1.44MB und 2.88MB).
- 2 USB2.0-Ports..
- 1 front audio header.
- 1 IEEE 1394A (FireWire) Anschluss. (optional)

Abmessungen

- ATX Form-Factor: 19.9cm X 30.4cm (W X L)

B. BIOS & Software

BIOS

- Award legal BIOS.
- Unterstützung für APM1.2.
- Unterstützung für ACPI.
- Unterstützung für die USB Funktion.

Software

- Unterstützung für CPU Savior™, 9th Touch™, FLASHER™, WinFlasher™, StudioFun!™ (optional) und Watchdog™.
- Unterstützung für die am meisten verbreiteten Betriebssysteme wie Windows 98SE, Windows 2000, Windows ME, Windows XP and SCO UNIX usw. .

Verpackungsinhalt

- HDD Kable X1
- FDD Kable X1
- Benutzer Handbuch X1
- USB Kable X1 (optional)
- I/O-Rückwand für ATX Gehäuse X1 (optional)

-
- Treiber CD für Installation X 1
 - StudioFun! Anwendung CD X 1 (optional)

Einstellung der Jumper

Die Abbildung verdeutlicht, wie Jumper eingestellt werden. Pins werden durch die Jumper-Kappe verdeckt, ist der Jumper **„geschlossen“**. Keine Pins werden durch die Jumper-Kappe verdeckt, ist der Jumper **„geöffnet“**. Die Abbildung zeigt einen 3-Pin Jumper dessen Pin1 und Pin2 **„geschlossen“** sind, bzw. es befindet sich eine Jumper-Kappe auf diesen beiden Pins.



Jumper geschlossen



Jumper geöffnet

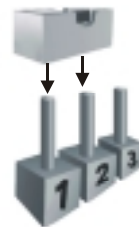

Pin1-2 geschlossen

Installation der CPU

Schritt 1: Ziehen Sie den Hebel seitlich vom Sockel weg. Heben Sie den Hebel dann in 90-Grad-Winkel nach oben.

Schritt 2: Suchen Sie nach der scharfen Kante, die auf Drehpunkt des Hebels weisen muss. Die CPU passt nur, wenn sie richtig ausgerichtet ist.

Schritt 3: Drücken Sie die CPU fest in den Sockel und schließen Sie den Hebel.

Schritt 4: Stecken Sie Ihren CPU-Lüfter auf die CPU. Schließen Sie die Stromversorgungsstecker für CPU-Lüfter an JCFAN1 an. Dann beenden Sie die Installation.



Schritt 1



Schritt 2



Schritt 3



Schritt 4

CPU-Lüfter Header: JCFAN1

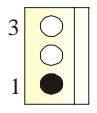
 JCFAN1	Pin	Beschreibung
	1	Masse
	2	+12V
	3	Lüfter RPM Geschwindigkeit Sensor

System-Lüfter Header: JSFAN1

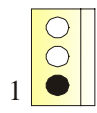
 JSFAN1	Pin	Beschreibung
	1	Masse
	2	+12V
	3	Lüfter RPM Geschwindigkeit Sensor e

DDR-DIMM-Modules: DIMMB1, DIMMB2

DRAM-Zugriffszeit: 2.5V Unbuffered DDR 266/333/400 MHz Typ erforderlich.

DRAM-Typ: 64MB/ 128MB/ 256MB/ 512MB/ 1GB DIMM-Module (184-Pin)

Gesamte Speichergröße von Unbuffered-DIMMs

DIMM-Sockel Standort	DDR-Module	Speichergröße (MB)
DIMMB1	64MB/128MB/256MB/512MB/1GB *1	Maximal ist 2GB
DIMMB2	64MB/128MB/256MB/512MB/1GB *1	

*** Nur als Referenz ***

Installation von DDR-Modul

1. Öffnen Sie einen DIMM-Slots, indem Sie die seitlich Chips nach außen drücken. Richten Sie das DIMM-Modul so über dem Slot aus, dass das Modul mit der Kerbe in den Slot passt.
2. Drücken Sie das DIMM-Modul in den Slot, bis die seitlichen Clips zuschnappen und das Modul fest sitzt.



Jumpers, Headers, Anschlüsse & Slots

Diskettenanschluss: FDD1

Das Motherboard enthält einen standardmäßigen Diskettenanschluss, der 360K-, 720K-, 1.2M-, 1.44M- und 2.88M-Disketten unterstützt. Dieser Anschluss unterstützt die mitgelieferte Bandkabel des Diskettenlaufwerks..

Festplattenanschlüsse: IDE1 und IDE2

Das Mainboard hat einen 32-bit Enhanced PCI IDE-Controller, der die Modi PIO0~4, Bus Master sowie die Ultra DMA/33/66/100/133- Funktion zur Verfügung stellt. Dieser ist mit zwei HDD-Anschlüssen versehen IDE1 (primär) und IDE2 (sekundär).

Die IDE-Anschlüsse können eine Master- und eine Slave-Festplatte verbinden, so dass bis zu 4 Festplatten angeschlossen werden können. Die erste Festplatte sollte immer an IDE1 angeschlossen werden.

Peripheral Component Interconnect Slots: PCI-5

Dieses Motherboard ist mit 5 standardmäßigen PCI-Slots ausgestattet. PCI steht für Peripheral Component Interconnect und bezieht sich auf einem Busstandard für Erweiterungskarten, der den älteren ISA-Busstandard in den meisten Schnittstellen ersetzt hat. Dieser PCI-Slot ist für 32 bits vorgesehen.

Accelerated Graphics Port Slot: JAGP1

Ihr Monitor wird direkt an die Grafikkarte angeschlossen. Dieses Motherboard unterstützt Grafikkarten für PCI-Slots, aber es ist auch mit einem Accelerated Graphics Port ausgestattet. AGP-Karten verwenden die AGP-Technologie, um die Wirksamkeit und Leistung von Videosignalen zu verbessern, besonders wenn es sich um 3D-Grafiken handelt.

Communication Network Riser Slot: CNR1

Die CNR-Angaben entsprechen einer offenen Industry Standard Architecture, und sie definieren eine Hardware-skalierbare Riser-Card-Schnittstelle, welche nur Audio, Netzwerk und Modem unterstützt.

Digital Audio Anschluss: J_SPDIF1 (optional)

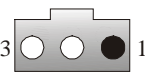
	Pin	Belegung
	1	+5V
	2	SPDIF_Ausgabe
	3	Masse

Stromversorgungsanschluss: JATXPWER1

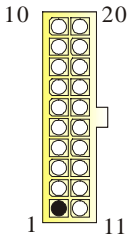
 <p>JATXPWER1</p>	PIN	Belegung	PIN	Belegung
	1	+3.3V	11	+3.3V
	2	+3.3V	12	-12V
	3	Masse	13	Masse
	4	+5V	14	PS_ON
	5	Masse	15	Masse
	6	+5V	16	Masse
	7	Masse	17	Masse
	8	PW_OK	18	-5V
	9	+5V reservierte Spannung	19	+5V
10	+12V	20	+5V	

Anschlüsse für die Vorderseite: JPANEL1

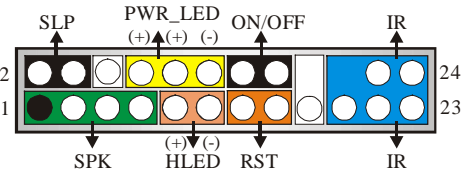
 <p>JPANEL1</p>	Pin	Belegung	Funktion	Pin	Belegung	Funktion
	1	+5V	Lautsprecher-Anschluss	2	Schlaf- Kontroll	Schlaf-Knopf
3	Kein	4		Masse		
5	Kein	6		Kein	Kein	
7	Lautsprecher	8		Power LED (+)	POWER LED	
9	HDD LED (+)	10	Power LED (+)			
11	HDD LED (-)	12	Power LED (-)			
13	Masse	Rückstell-knopf	14	Power-Knopf	Power-On Knopf	
15	Reset-Kontroll		16	Masse		
17	Kein	IrDA-Anschluss	18	Schlüsse	IrDA Anschluss	
19	Kein		20	Schlüsse		
21	+5V		22	Masse		
23	IRTX		24	IRRX		



Front USB Header: JUSB3

 <p>JUSB3</p>	Pin	Belegung	Pin	Belegung
	1	+5V(geschmelzt)	2	+5V(geschmelzt)
	3	USB-	4	USB-
	5	USB+	6	USB+
	7	Masse	8	Masse
	9	Kein Pin	10	Kein

Wake On LAN Header: JWOL1

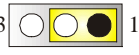

 <p>JWOL1</p>	Pin	Belegung
	1	+5V_SB
	2	Masse
	3	Aufwecken

Auswahl von Stromsmodi für Tastatur/ Maus: JKBV1

JKBV1	Pin-Belegung	Beschreibung
 <p>Pin 1-2 geschlossen</p>	+5V	+5V für Tastatur und Maus
 <p>Pin 2-3 geschlossen</p>	+5V reservierte Spannung	Durch +5V reservierte Spannung für PS/2-Maus und PS/2-Tastatur zum Erwecken vom System



Anmerkung: Um die Funktion —“Erwecken durch Tastatur/Maus“ — zu aktivieren, müssen Pins 2-3 von JKBV1 durch die Jumperkappe verdeckt werden.

Auswahl von Stromsmodi für USB: JUSBV1/ JUSBV2/JUSBV3

JUSBV1/JUSBV2/ JUSBV3	Pin-Belegung	Beschreibung
 Pin 1-2 geschlossen	+5V	JUSBV1: 5V für USB-Port von J1394_USB1 JUSBV2: 5V für USB-Port von JUSBLAN1 JUSBV3: 5V für USB-Port von JUSB3
 Pin 2-3 geschlossen	+5V reservierte Spannung	JUSBV1: 5V reservierte Spannung für J1394_USB1 zum Erwecken JUSBV2: 5V reservierte Spannung für JUSBLAN1 zum Erwecken JUSBV3: 5V reservierte Spannung für JUSB3 zum Erwecken

Anmerkung: Um die Funktion —“Erwecken durch USB-Geräte“— zu aktivieren, müssen Pins 2-3 von JUSBV1/JUSBV2/JUSBV3 durch die Jumperkappe verdeckt werden.

Jumper zum Löschen des CMOS: JCMOS

JCMOS	Beschreibung
 Pin 1-2 geschlossen	Normale Operation (Default)
 Pin 2-3 geschlossen	CMOS-Daten Löschen



Die folgende Schritte leiten Sie, das Kennwort für BIOS-System zurückzusetzen. Es ist wichtig, die Anweisung zu folgen.

※ **Prozeduren zum Löschen des CMOS:**

1. Ausschalten Sie das System.
2. Lassen Sie Pin 2-3 von JCOMS1 geschlossen sein.
3. Bitte warten Sie 15 Sekunden.
4. Lassen Sie Pin 1-2 von JCOMS1 geschlossen sein.
5. Einschalten Sie das System wieder.
6. Zurücksetzen Sie ihr gewünschtes Kennwort oder löschen Sie die CMOS-Daten.

Warnmeldung für Chassis-Öffnen Anschluss: JC1

 <p>JC1</p>	Pin	Belegung
	1	Gehäuse Öffnen Signal
	2	Masse

CD-ROM Audio-In Header: JCDIN1

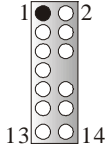

 <p>JCDIN1</p>	Pin	Belegung
	1	Link-Kanal Eingabe
	2	Masse
	3	Masse
	4	Recht-Kanal Eingabe

Front Panel Audio Header: JF_AUDIO1

 <p>JF_AUDIO1</p>			
Pin	Belegung	Pin	Belegung
1	Mikrofon-Eingang/ Zentrum	2	Masse
3	Mikrofon-Betriebsspannung/ Bass	4	Audio-Betriebsspannung
5	Audio-Signal des rechten Kanals zur Vorderseite / Lautsprecher-Signal des rechten Kanals zur Vorderseite	6	Audio-Signal des rechten Kanals zur Vorderseite / Lautsprecher-Signal des rechten Kanals zur Vorderseite

7	Reserviert für spät. Verwendung durch Kopfhörer-Verstärker	8	Schlüsse
9	Audio-Signal des linken Kanals zur Vorderseite / Lautsprecher-Signal des linken Kanals zur Vorderseite	10	Audio-Signal des linken Kanals zur Vorderseite / Lautsprecher-Signal des linken Kanals zur Vorderseite
11	Audio-Signal des rechten Kanals von der Vorderseite / Lautsprecher-Signal des rechten Kanals von der Vorderseite	12	Audio-Signal des rechten Kanals von der Vorderseite/ Lautsprecher-Signal des rechten Kanals von der Vorderseite
13	Audio-Signal des linken Kanals von der Vorderseite/ Lautsprecher-Signal des linken Kanals von der Vorderseite	14	Audio-Signal des linken Kanals von der Vorderseite/ Lautsprecher-Signal des linken Kanals von der Vorderseite

Safe/ User Modi Auswahl: JCLK

JCLK	Beschreibung
 Pin 1-2 geschlossen	Safe Mode
 Pin 1-2 geöffnet	User Mode (Default) (133/ 166/ 200 MHz)

Anmerkung: Wenn Übertakt Funktion nicht gelungen ist, und das System kann nicht arbeiten, folgen Sie bitte die untenstehende Bedienungsanleitung :

1. Ausschalten Sie das System.
2. Lassen Sie den Jumper JCLK geschlossen sein.
3. Anschalten Sie das System.
4. Eingeben Sie CMOS Setup Menü und wählen Sie das Default-Settings.
5. Ausschalten Sie das System wieder.
6. Lassen Sie den Jumper JCLK geöffnet sein.
7. Anschalten Sie das System.

Game Header: JGAME1 (optional)

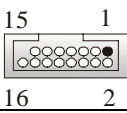

Pin	Belegung	Pin	Belegung
1	+5V	2	+5V
3	Joystick B Knopf 1	4	Joystick A Knopf 1
5	Joystick B Koordierung X	6	Joystick A Koordierung X
7	MIDI Ausgabe	8	Masse
9	Joystick B Koordierung Y	10	Masse
11	Joystick B Knopf 2	12	Joystick A Koordierung Y
13	MIDI Eingabe	14	Joystick A Knopf 2
15	Kein	16	+5V

Front 1394 Header: J1394A (optional)



Pin	Belegung	Pin	Belegung
1	A1+	2	A1-
3	Masse	4	Masse
5	B1+	6	B1-
7	+12V	8	+12V
9	Schlüsse	10	Kein

Auswahl CNR /Onboard-Codec: J_CODECSEL

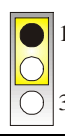
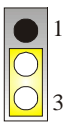
J_CODECSEL	Beschreibung
 Pin 1-2 geschlossen	Verwendung von Onboard-Codec (Default)
 Pin 2-3 geschlossen	Verwendung von CNR-Codec

Anschlüsse für die Rückwand

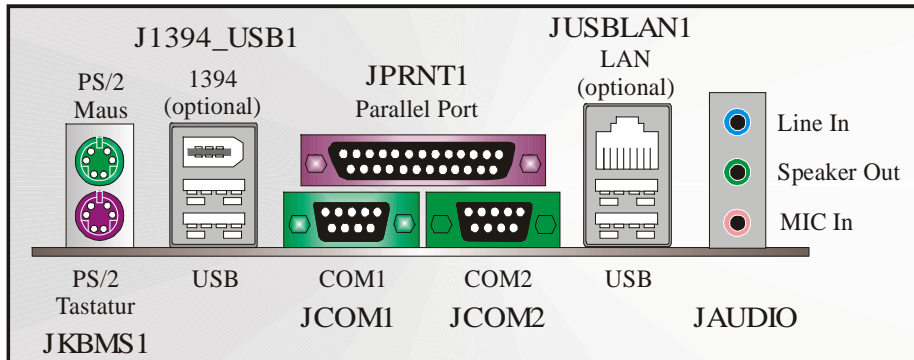

Watchdog Technology

It is important to know that when overclocking, the system can be at a vulnerable state. Therefore, the BIOSTAR Watchdog Technology was designed to protect your PC under dangerous over-clock situations. Any over-clocking that reaches the threshold settings, the Watchdog Technology will disable your system from rebooting in the BIOS setting. Under this circumstance, please power off your PC. After that, press <Insert> and power on your system simultaneously to restart your system. This user-friendly design can save you from squandering your time on opening the case just to clear the CMOS. In the end, thanks to the Watchdog Technology, everything is back at a safe and sound!

StudioFun!™

Introduction

StudioFun!™ is a media-player based on optimized GNU/Linux distribution to bring a “Room Theater” experience into life. It plays DVD, VCD, MP3, Audio CD and other multimedia. Furthermore, Users can take snapshots of video and customize the saved images as screensavers or photo slideshows. Of course, the images can be stored in USB mass storage devices like flash disks and USB floppy disks.

Hardware Requirements

The supported hardware list of StudioFun! updates regularly. So please check the “[hwreq.txt](#)” located in the root of StudioFun! Application Pack CD to get the latest supporting information.

Installation Procedure

Insert the “StudioFun! Application Pack CD” in a CD/DVD ROM drive and let the system boot through the CD. The disk will boot and bring up the grub boot loader installation menu. Two options are specified: “StudioFun Install” and “StudioFun Recover”.

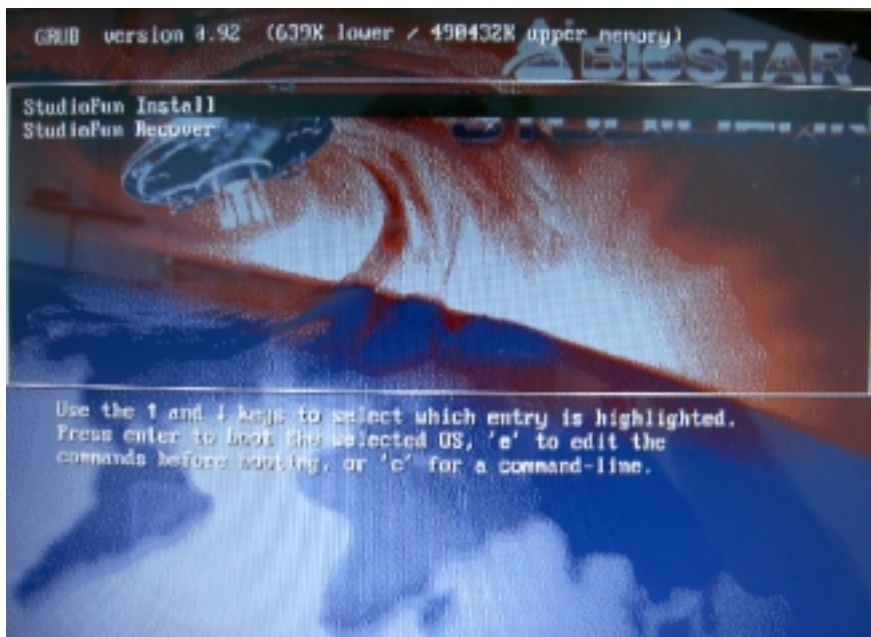

StudioFun! Install

This option will do the basic installation of the distribution. The installation works on pre-installed windows or GNU/Linux distribution.

On selecting the "StudioFun Install" option the installer boots and displays a dialog box indicating the space required and waits for a confirmation. Selecting "Ok" will continue the installation while selecting "Cancel" will terminate the installation and reboot the machine.

If Windows or GNU/Linux is the only OS installed on the hard disk with no free space, it will resize the partition, either NTFS or FAT32 or ext2, and install StudioFun!. *If the hard disk has a 128MB of free space available, the installation will use the free space.*

After installing the base system you will be prompted to select the resolution from the following choices

1. 1024x768 (recommended)
2. 800x600
3. 640x480

Select the desired resolution. The default is 1024x768 for high-end graphics.

Next you will be prompted to choose the DVD area/region selection code. Choose this based on the type of DVDs you will be playing.

The installation procedure will then probe for the type of mouse installed. The distribution currently supports PS/2, USB and Serial mice. In case of serial mouse you will have to move the mouse when prompted. The other two are probed and installed automatically.

The installation procedure will now finish, the CD is ejected and a dialog box prompting to reboot the machine is displayed. Press "OK" button and enjoy StudioFun!.

3.1.1 Error Messages

1. Media corrupted!! Please check the media! The CD-ROM is corrupted.
2. Extraction of base system failed!! Please try again later!! The CD-ROM is corrupted.
3. Unsupported hardware found, Aborting... If you try to install StudioFun! on an unsupported and undocumented hardware the above error message is popped.
4. No device found! This error message is given if there is no hard disk in the system.

StudioFun! Recover

Where there is a MBR (Master Boot record) corruption, the “StudioFun Recover” will automatically probe the hard disk master boot record and find out the installed operating system(s). Once success, it will re-install the boot loader with correct options in the MBR. Please be noted that the newly probed one will over write any custom boot loader option specified from other GNU/Linux installations.

Booting to StudioFun!

After the Installation, remove the CD from the CD-ROM and restart the system. After the rebooting, you will get the “GRUB boot loader menu screen”. Select the StudioFun! Option to boot to the StudioFun! Partition.



After executing the boot up, you will see the main Desktop screen. The following section is a complete description of the Desktop application.

Desktop



This is the main shell of the StudioFun! software. It illustrates two main categories, one is the main "Media Control" part and the other is the "Control Panel".

Media control

The Media Control consists of the following functionalities:

1. VCD

This control icon will glow whenever a VCD is detected in a DVD/CD-ROM drive. The VCD will be auto-played *only* when it is put in to the drive when the Desktop (StudioFun! shell) is up and running whereas the control will simply glow to inform the user about a VCD present in the DVD/CD-ROM drive when the Desktop is not launched.

2. DVD

This control will glow whenever a DVD is detected in a DVD drive. The DVD will be auto-played *only* when it is put in to the drive when the Desktop (StudioFun! shell) is up

and running, otherwise, the control will simply glow to inform the user about a DVD present in the DVD/CD-ROM.

3. MP3

This control will glow whenever a MP3 is detected in a DVD/CD-ROM drive. The MP3 will be auto-played *only* when it is put in to the drive when the Desktop (StudioFun! shell) is up and running, otherwise, the control will simply glow to inform the user about a MP3 present in the DVD/CD-ROM drive.

4. AUDIO

This control will glow whenever a AUDIO is detected in a DVD/CD-ROM drive. The AUDIO will be auto-played *only* when it is put in to the drive when the Desktop (StudioFun! shell) is up and running, otherwise, the control will simply glow to inform the user about a AUDIO present in the DVD/CD-ROM drive.

5. FILE

This control will glow whenever a File CD (CDs with other media type files) is detected in a DVD/CD-ROM drive. The File CD will be auto-played *only* when it is put in to the drive when the Desktop (StudioFun! shell) is up and running, otherwise, the control will simply glow to inform the user about a File CD present in the DVD/CD-ROM drive.

6. EJECT MEDIA

When clicked this control, the file disk from the DVD/CDROM drives will be ejected.

7. EXIT

This is the "Power on/off" control of the Desktop (StudioFun! shell).

Control Panel

The Control panel part has five icons, which are shortcuts to other applications present in the StudioFun!. Tool tips will pop up once the mouse is rolled to the icons

1. Select Region

Clicking this icon will invoke the application for selection DVD region settings. Refer to section 5.2 Select DVD Region application for more details.

2. Screensaver

Clicking this icon will invoke the screensaver application. Refer to section 5.3 **Screensaver** for more details.

3. Display Settings

Clicking this icon will invoke the application for changing the screen resolutions. Refer to section 5.4, **Display Settings** for more details.

4. File Manager

Clicking this icon will invoke the file manager. Refer to section 5.6 **File manager** for more details.

When user has a DVD and a CD-ROM Drive, DVD Drive has the priority:

If user has both DVD and a CD-ROM drive, DVD drive will be given the preference when both the drives hold valid media in them, i.e., if the CD-ROM drive has a media and a DVD drive also has a media, and the StudioFun! is started, the disk inside the DVD drive will be played.

Other general user scenarios

When a user clicks on any of the media-controls when it is not glowing, except the eject media and exit, the media-player will just come up and wait for user input.

Software Details

XINE



XINE is a multimedia player. It plays back Audio CD, DVD, and VCD. It also decodes multimedia files like AVI, MOV, WMV, and MP3 from local disk drives. It interprets most of the common multimedia formats.

- **Features of Xine**

- a. Skinnable GUI
- b. Navigation controls (seeking, pause, fast, slow, next chapter, etc)
- c. On Screen Display (OSD) features
- d. DVD and external subtitles
- e. DVD/VCD menus (requires external plug-in)
- f. Audio and subtitle channel selection
- g. Closed Caption support
- h. Brightness, contrast, audio volume, hue, saturation adjusting requires hardware/driver support)
- i. Playlist
- j. Image snapshot
- k. Audio re-sampling
- l. Software de-interlacing algorithms
- m. Configuration dialog
- n. Aspect ratio changing
- o. Full-screen display

- **Supported File Formats**

- a. Video CD
- b. MPEG program streams (.mpg, .mpeg)
- c. ogg (.ogg) avi (.avi)
- d. asf (.asf, .wmv)
- e. QuickTime (.mov)
- f. MPEG-Video (.mpv, .m2v)
- g. MPEG-Audio (.mp2, .mp3)
- h. WAV (.wav) Video CODEC
- i. MPEG 1/2
- j. MPEG 4 (aka OpenDivX)
- k. MS MPEG 4
- a. Chapter 5: Software Details 10
- l. Windows Media Video 7
- m. Motion JPEG

- **Remote Control Support.**

- a. Infrared interface
- b. User-friendly

- **Usage of StudioFun! with CelomaChrome skin**

- a. Select VCD button to play a VCD disc
- b. Select DVD button to play a DVD disc
- c. Select CDDA button to play a Audio CD
- d. Select next chapter or MRL (>>|) button to play next track in Audio CD, VCD and MP3 songs and to play next chapter in DVD
- e. Select previous chapter or MRL (|<<) button to play previous track in Audio CD, VCD and MP3 songs and to play previous chapter in DVD
- f. Select slow motion (<<) button to play the video / audio in slow motion (Select play button after reaching the required position)
- g. Select fast motion (>>) button to play the video / audio in fast motion (Select play button after reaching the required position)
- h. Select subs + / - button to select the appropriate subtitle (Usable while playing)
- i. Select audio + / - button to select the appropriate audio track (For example when
- j. The DVD contains one audio track in English and the other with some other language,
- k. Usable while playing DVD's)
- l. Select "hide button" to hide the control panel of the player
- m. Select "menu" button to use menu while playing DVD
- n. Select "control" button to adjust brightness / color
- o. Select "setup" button to modify the settings of the player
- p. Select "f.scr" button to show the video output of the player in full screen mode
- q. Select "snap" button to take a snapshot of the currently playing video
- r. Select "plist" button to add / remove / manage playlist
- s. Select "mrl" button to add new file to play

Select Region

Overview

Select region is a utility to set a DVD region. With the help of this application user can set or change a DVD region. Only one region can be set at a time.

About Select Region

With the help of this application you can set a region for DVD. Only one region can be set at a time. If you keep the mouse pointer on any region, you can view the countries, which comes under that region.

“Ok” - Click to set the selected region.

“Cancel” - Click to quit the application.

How to select DVD region

You can select only one region at a time. You can change your selection by clicking on any other region.

- A snapshot of the application is shown below:

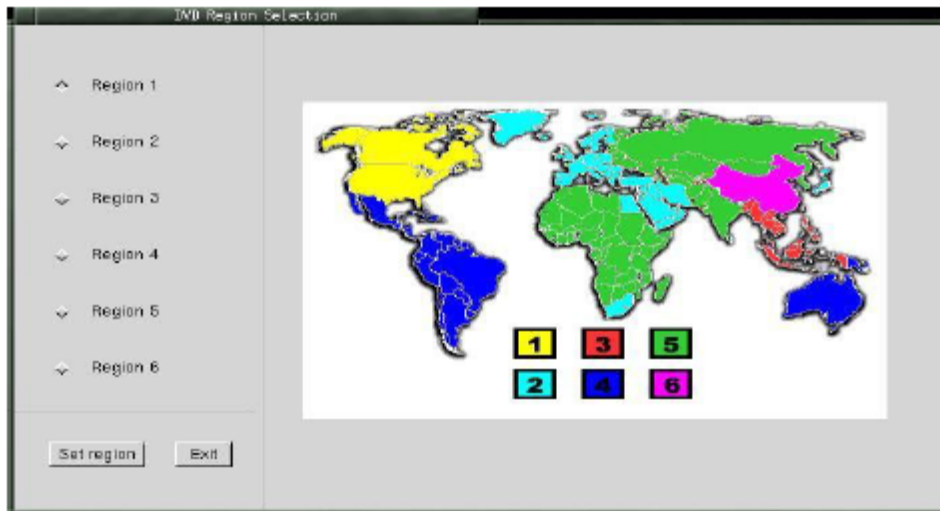

Screensaver

Screensaver

The xscreensaver daemon waits until the keyboard and mouse have been idle for a period, and then runs a graphics demo chosen at random. The demo is terminated as soon as there is any mouse or keyboard activity.

The xscreensaver-demo program is the graphical user interface to xscreensaver. It lets you tune the various parameters used by the xscreensaver daemon, and browse through the graphics demos.

StudioFun! comes with xscreensaver when you click on the screensaver icon the application comes up. Then user can choose various graphics demos like chbg,halo,hypercube or hyperball.

Screensaver comes with various options

- Preview Option: When a user selects a particular graphics demo and clicks on preview button the demo comes up.
- Blank After Option: The screensaver will blank the screen after the keyboard and mouse have been idle default time is 1minute and user can change the settings.
- Cycle After Option: When screensaver is running this cycle time defines the time limit for each screensaver.
- Mode Screensaver comes with various modes:
 1. Random Screen Saver: When user chooses this option, Screensaver cycles through various graphics demos randomly
 2. Only one Screen Saver: When user chooses this option, screensaver displays only one graphics demo.
 3. Blank Screen Only: When user chooses this option, screensaver only blanks the screen instead of displaying the graphics demo.
 4. Disable Screen Saver: When user chooses this option, screensaver is disabled.

- Various Graphics Demos

XScreensaver comes with various screensaver

Chbg: This screensaver displays the images stored in StudioFun! the time gap between images is 5 seconds.

Hyperball

Hypercube

Halo

Strange

- A snapshot of the application is shown below:

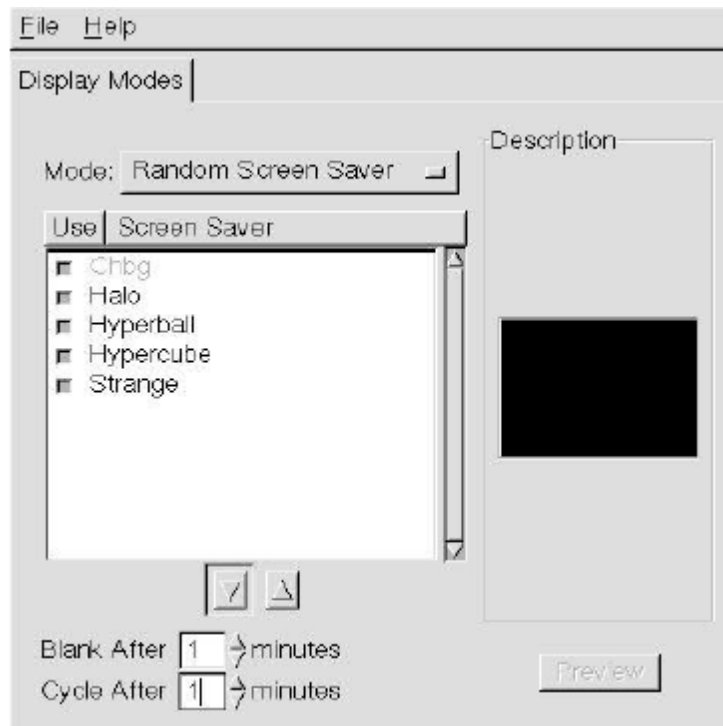

Display Settings

Display Settings

Display setting is a program to change the current resolution settings of the Display. By default user of StudioFun! will be given a choice to select between any of the following three resolutions.

- 640x480
- 800x600
- 1024x768

The current resolution of the Display will be selected by default. It requires restart of the StudioFun! to reflect the changes made.

File Manager

Overview

File manger is a utility to copy files from deferent devices to hard disk and vice versa. User can copy files from devices such as, floppy, CD-Rom and Flashdisk to hard disk and also from hard disk to floppy and Flashdisk.

About File manager

The hard disk files are stored in a directory called “/studiofun” on the hard disk. You can also delete files from hard disk, but you cannot delete files from any device.

- ✧ Select device - Contains the device names /floppy, /cdrom and /flashdisk. Select a device from/to which you want to copy files. **Please double click the device option twice to mount the device.**
- ✧ List Directories - Shows the list of directories of the selected device after double clicking it.
- ✧ Floppy/cdrom/Flashdisk - Shows the contents of the selected directory from the “List directories” field after double clicking it.
- ✧ Hard disk - Shows the contents of a directory called “/studiofun”.
- ✧ Add (>>) - Click to copy selected files from a device to hard disk.
- ✧ Add (<<) - Click to copy selected files from hard disk to a device.
- ✧ Remove - Click to delete files from hard disk.
- ✧ Exit - Click to quit the application.

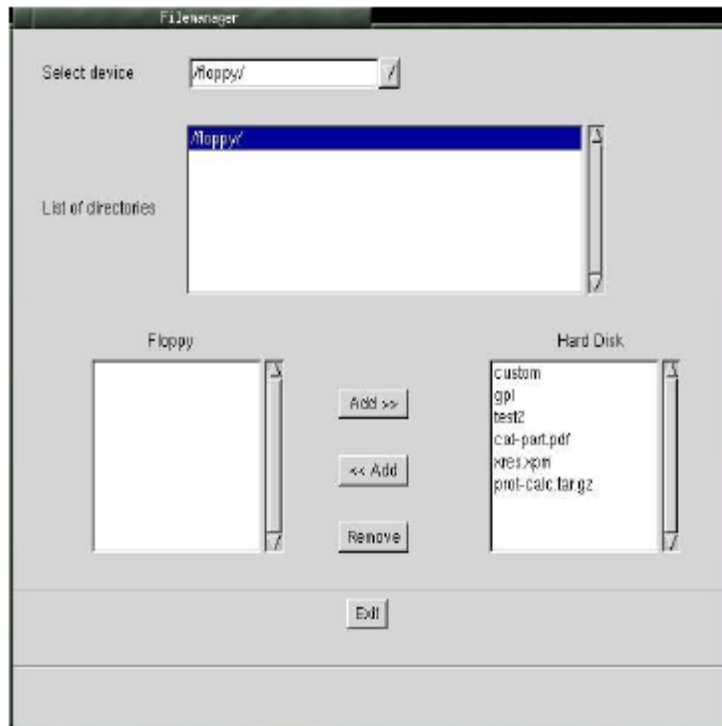

WarpSpeeder



Introduction

[WarpSpeeder™], a new powerful control utility, features three user-friendly functions including Overclock Manager, Overvoltage Manager, and Hardware Monitor.

With the Overclock Manager, users can easily adjust the frequency they prefer or they can get the best CPU performance with just one click. The Overvoltage Manager, on the other hand, helps to power up CPU core voltage and Memory voltage. The cool Hardware Monitor smartly indicates the temperatures, voltage and CPU fan speed as well as the chipset information. Also, in the About panel, you can get detail descriptions about BIOS model and chipsets. In addition, the frequency status of CPU, memory, AGP and PCI along with the CPU speed are synchronically shown on our main panel.

Moreover, to protect users' computer systems if the setting is not appropriate when testing and results in system fail or hang, [WarpSpeeder™] technology assures the system stability by automatically rebooting the computer and then restart to a speed that is either the original system speed or a suitable one.

System Requirement

OS Support: Windows 98 SE, Windows Me, Windows 2000, Windows XP

DirectX: DirectX 8.1 or above. (The Windows XP operating system includes DirectX 8.1. If you use Windows XP, you do not need to install DirectX 8.1.)

Installation

1. Execute the setup execution file, and then the following dialog will pop up. Please click "Next" button and follow the default procedure to install.

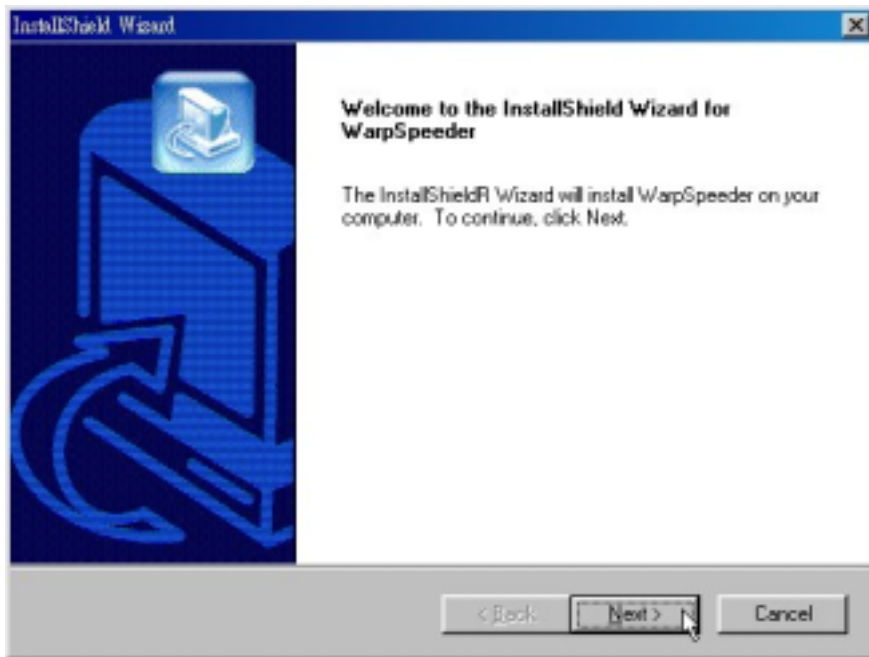

2. When you see the following dialog in setup procedure, it means setup is completed. If the "Launch the WarpSpeeder Tray Utility" checkbox is checked, the Tray Icon utility and [WarpSpeeder™] utility will be automatically and immediately launched after you click "Finish" button.

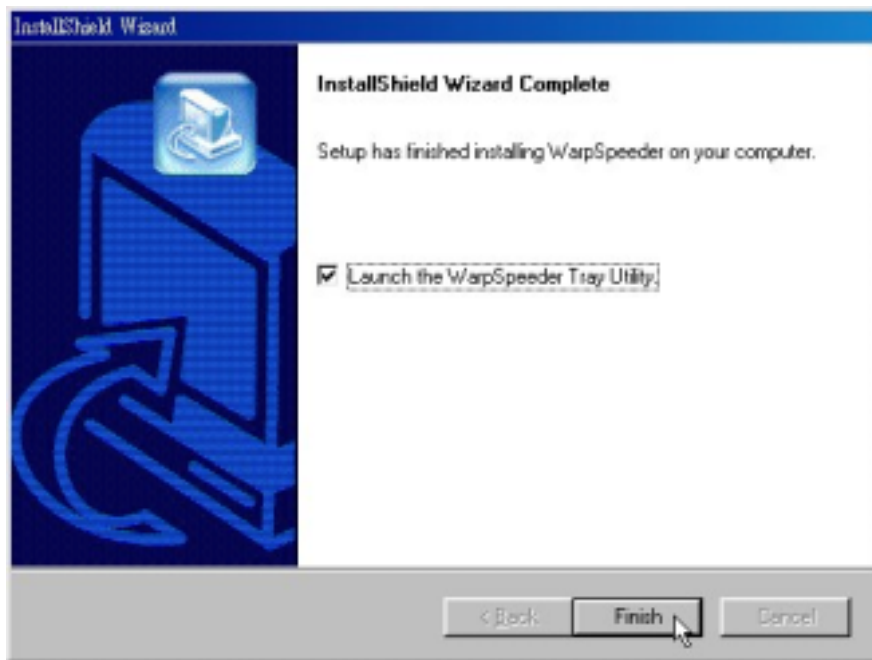

Usage

The following figures are just only for reference, the screen printed in this user manual will change according to your motherboard on hand.

[WarpSpeeder™] includes 1 tray icon and 5 panels:

1. Tray Icon:

Whenever the Tray Icon utility is launched, it will display a little tray icon on the right side of Windows Taskbar.

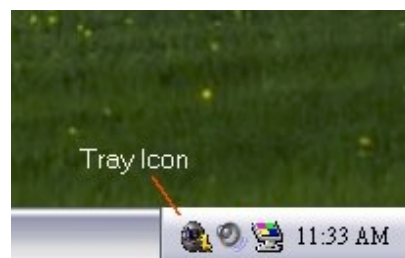

This utility is responsible for conveniently invoking [WarpSpeeder™] Utility. You can use the mouse by clicking the left button in order to invoke [WarpSpeeder™] directly from the little tray icon or you can right-click the little tray icon to pop up a popup menu as following figure. The “Launch Utility” item in the popup menu has the same function as mouse left-click on tray icon and “Exit” item will close Tray Icon utility if selected.

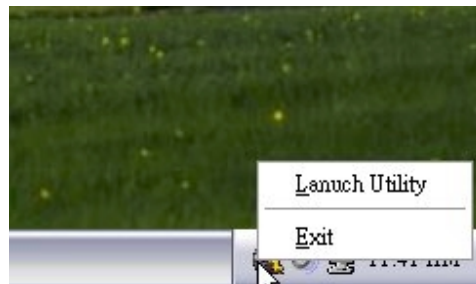

2. Main Panel

If you click the tray icon, [WarpSpeeder™] utility will be invoked. Please refer do the following figure; the utility's first window you will see is Main Panel.

Main Panel contains features as follows:

- a. Display the CPU Speed, CPU external clock, Memory clock, AGP clock, and PCI clock information.
- b. Contains About, Voltage, Overclock, and Hardware Monitor Buttons for invoking respective panels.
- c. With a user-friendly Status Animation, it can represent 3 overclock percentage stages:

Duck walking => overclock percentage from 100% ~ 110 %

Duck running => overclock percentage from 110% ~ 120%

Duck burning => overclock percentage from 120% ~ above

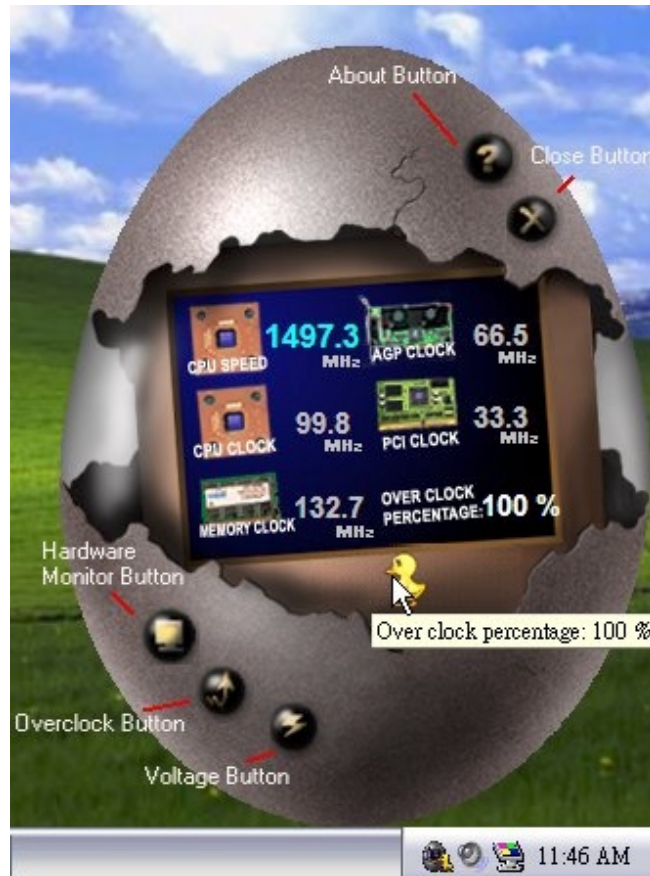

3. Voltage Panel

Click the Voltage button in Main Panel, the button will be highlighted and the Voltage Panel will slide out to up as the following figure.

In this panel, you can decide to increase CPU core voltage and Memory voltage or not. The default setting is "No". If you want to get the best performance of overclocking, we recommend you click the option "Yes".



4. Overclock Panel

Click the Overclock button in Main Panel, the button will be highlighted and the Overclock Panel will slide out to left as the following figure.





Overclock Panel contains these features:

- a. “-3MHz button”, “-1MHz button”, “+1MHz button”, and “+3MHz button”:
provide user the ability to do real-time overclock adjustment.

Warning: Manually overclock is potentially dangerous, especially when the overclocking percentage is over 110 %. We strongly recommend you verify every speed you overclock by click the Verify button. Or, you can just click Auto overclock button and let [WarpSpeeder™] automatically gets the best result for you.

- b. “Recovery Dialog button”:
Pop up the following dialog. Let user select a restoring way if system need to do a fail-safe reboot.

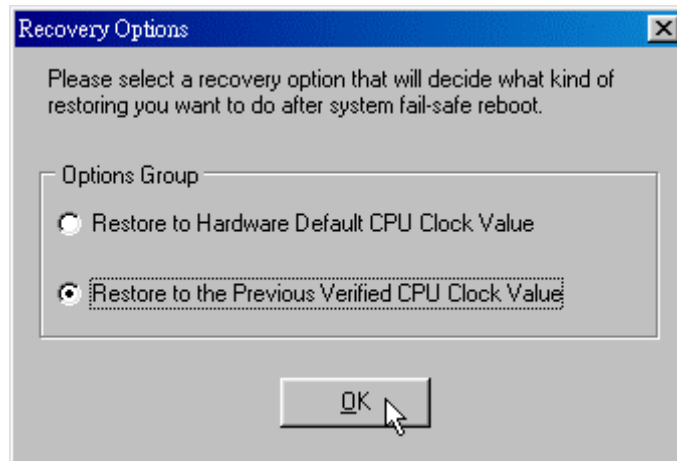

- c. "Auto-overclock button": User can click this button and [WarpSpeeder™] will set the best and stable performance and frequency automatically. [WarpSpeeder™] utility will execute a series of testing until system fail. Then system will do fail-safe reboot by using Watchdog function. After reboot, the [WarpSpeeder™] utility will restore to the hardware default setting or load the verified best and stable frequency according to the Recovery Dialog's setting.
- d. "Verify button": User can click this button and [WarpSpeeder™] will proceed a testing for current frequency. If the testing is ok, then the current frequency will be saved into system registry. If the testing fail, system will do a fail-safe rebooting. After reboot, the [WarpSpeeder™] utility will restore to the hardware default setting or load the verified best and stable frequency according to the Recovery Dialog's setting.

Note: Because the testing programs, invoked in Auto-overclock and Verify, include DirectDraw, Direct3D and DirectShow tests, the DirectX 8.1 or newer runtime library is required. And please make sure your display card's color depth is High color (16 bit) or True color(24/32 bit) that is required for Direct3D rendering.

5. Hardware Monitor Panel

Click the Hardware Monitor button in Main Panel, the button will be highlighted and the Hardware Monitor panel will slide out to left as the following figure.

In this panel, you can get the real-time status information of your system. The information will be refreshed every 1 second.



6. About Panel

Click the About button in Main Panel, the button will be highlighted and the About Panel will slide out to up as the following figure.

In this panel, you can get model name and detail information in hints of all the chipset that are related to overclocking. You can also get the mainboard's BIOS model and the Version number of [WarpSpeeder™] utility.

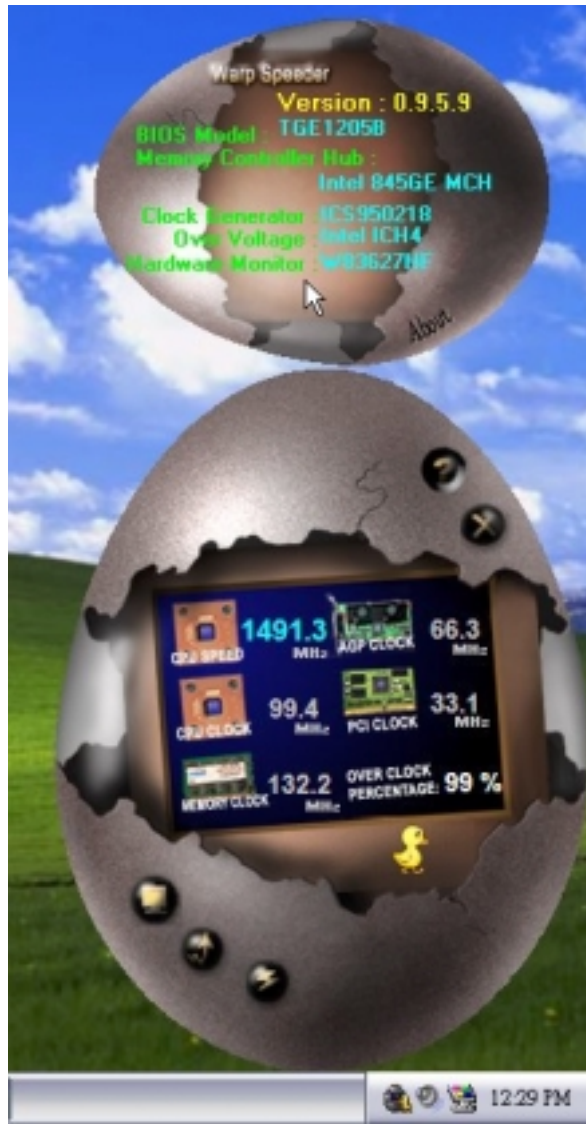

Note: Because the overclock, overvoltage, and hardware monitor features are controlled by several separate chipset, [WarpSpeeder™] divide these features to separate panels. If one chipset is not on board, the correlative button in Main panel will be disabled, but will not interfere other panels' functions. This property can make [WarpSpeeder™] utility more robust.

Trouble Shooting

PROBABLE	SOLUTION
No power to the system at all Power light don't illuminate, fan inside power supply does not turn on. Indicator light on keyboard does not turn on	<ul style="list-style-type: none"> * Make sure power cable is securely plugged in * Replace cable * Contact technical support
PROBABLE	SOLUTION
System inoperative. Keyboard lights are on, power indicator lights are lit, hard drive is spinning.	<ul style="list-style-type: none"> * Using even pressure on both ends of the DIMM, press down firmly until the module snaps into place.
PROBABLE	SOLUTION
System does not boot from hard disk drive, can be booted from CD-ROM drive.	<ul style="list-style-type: none"> * Check cable running from disk to disk controller board. Make sure both ends are securely plugged in; check the drive type in the standard CMOS setup. * Backing up the hard drive is extremely important. All hard disks are capable of breaking down at any time.
PROBABLE	SOLUTION
System only boots from CD-ROM. Hard disk can be read and applications can be used but booting from hard disk is impossible.	<ul style="list-style-type: none"> * Back up data and applications files. Reformat the hard drive. Re-install applications and data using backup disks.
PROBABLE	SOLUTION
Screen message says "Invalid Configuration" or "CMOS Failure."	<ul style="list-style-type: none"> * Review system's equipment . Make sure correct information is in setup.
PROBABLE	SOLUTION
Cannot boot system after installing second hard drive.	<ul style="list-style-type: none"> * Set master/slave jumpers correctly. * Run SETUP program and select correct drive types. Call drive manufacturers for compatibility with other drives.

Problemlösung

MÖGLICHE URSACHE	LÖSUNG
Das System hat keine Spannungsversorgung. Die Stromanzeige leuchtet nicht, der Lüfter im Inneren der Stromversorgung wird nicht eingeschaltet. Tastaturleuchten sind nicht an.	<ul style="list-style-type: none"> * Versichern Sie sich, dass das Stromkabel richtig angebracht ist * Ersetzen Sie das Stromkabel * Wenden Sie sich an Ihre Kundendienststelle
Das System funktioniert nicht. Die Tastaturleuchten sind an, die Stromanzeige leuchtet, die Festplatte dreht sich.	<ul style="list-style-type: none"> * Drücken Sie das DIMM-Modul bei gleichem Druck an beide Seiten, bis es einrastet.
Das System wird von der Festplatte nicht hochgefahren, vom CD-ROM-Treiber aber ja.	<ul style="list-style-type: none"> * Überprüfen Sie das Kabel zwischen Festplatte und Festplatten-Controller. Versichern Sie sich, dass beide Enden richtig angebracht sind; überprüfen Sie den Laufwerktyp in der standardmäßigen CMOS-Einrichtung. * Ein Backup der Festplatte ist sehr wichtig. Alle Festplatten können irgendwann beschädigt werden.
Das System wird nur von der CD-ROM hochgefahren. Die Festplatte wird gelesen und die Anwendungen sind funktionsfähig, aber es ist nicht möglich, das System von der Festplatte zu starten.	<ul style="list-style-type: none"> * Machen Sie eine Sicherungskopie von allen Daten und Anwendungsdateien. Formatieren Sie die Festplatte und reinstallieren Sie die Anwendungen und Daten mit Hilfe von Backup-Disks.
Auf dem Bildschirm erscheint die Meldung "Ungültige Konfiguration" oder "CMOS Fehler."	<ul style="list-style-type: none"> * Überprüfen Sie die Systemkomponenten und versichern Sie sich, dass diese richtig eingerichtet sind.
Das System kann nach der Installation einer zweiten Festplatte nicht hochgefahren werden.	<ul style="list-style-type: none"> * Setzen Sie die Master/Slave-Jumper richtig ein. * Führen Sie das SETUP-Programm aus und wählen Sie die richtigen Laufwerktypen. Wenden Sie sich an den Laufwerkhersteller, um die Kompatibilität mit anderen Laufwerken zu überprüfen.

07/22/2003