

Mainboard User's Manual

This publication, including all photographs, illustrations and software, is protected under international copyright laws, with all rights reserved. Neither this manual, nor any of the material contained herein, may be reproduced without the express written consent of the manufacturer.

The information in this document is subject to change without notice. The manufacturer makes no representations or warranties with respect to the contents hereof and specifically disclaims any implied warranties of merchantability or fitness for any particular purpose. Further, the manufacturer reserves the right to revise this publication and to make changes from time to time in the content hereof without obligation of the manufacturer to notify any person of such revision or changes.

Trademarks

IBM, VGA, and PS/2 are registered trademarks of International Business Machines.

AMD, Duron and Athlon are registered trademarks of Advanced Micro Devices Inc.

Microsoft, MS-DOS and Windows 98/ME/NT/2000/XP are registered trademarks of Microsoft Corporation.

PC-cillin is a registered trademark of Trend Micro Inc.

AMI is a registered trademark of American Megatrends Inc.

A3D is a registered trademark of Aureal Inc.

MediaRing Talk is a registered trademark of MediaRing Inc.

3Deep is a registered trademark of E-Color Inc.

Other names used in this publication may be trademarks and are acknowledged.

**Copyright © 2002
All Rights Reserved
M825 Series, V1.2B
VKM266/April 2002**

Mainboard User's Manual

Notice:

1. Owing to Microsoft's certifying schedule is various to every supplier, we might have some drivers not certified yet by Microsoft. Therefore, it might happen under Windows XP that a dialogue box (shown as below) pop out warning you this software has not passed Windows Logo testing to verify its compatibility with Windows XP. Please rest assured that our RD department has already tested and verified these drivers. Click the "Continue Anyway" button and go ahead the installation.

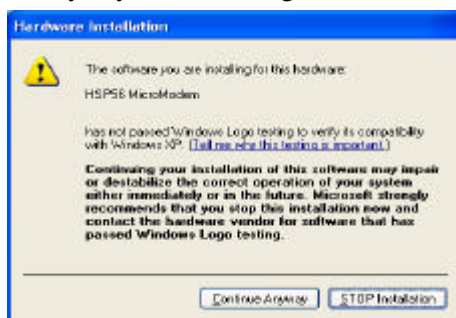

2. USB 2.0 Driver Limitations:
 - 2-1 After restarting Microsoft Windows XP operating system, USB device disappears or an exclamatory mark pops out (for example, SB HDD); please disconnect, and hot plug USB device again to get back normal function.
 - 2-2 While you are installing USB 2.0 driver under Windows XP, USB Keyboard and USB Mouse can't work out, but as the driver's installation is completed, they will resume working. Therefore, we strongly recommend you use PS2 Keyboard or PS2 Mouse while installing USB 2.0 driver.
 - 2-3 USB 2.0 port, under Microsoft operating systems, does neither support S1, S3, S4 (hibernate) Wake-Up nor S5 power-saving Sleeping modes while connecting any USB peripherals.
 - 2-4 If under DOS modes (DOS 6.x, Suspend To DOS and Window Return), USB 2.0 port doesn't support any USB peripherals.

Currently, we are working on such limitations' solution. As soon as the solution is done, the updated USB drive will be released to our website: www.pcchips.com.tw for your downloading.

Mainboard User's Manual

Table of Contents

Trademarks.....	I
Chapter 1: Introduction.....	1
Key Features.....	2
Package Contents.....	6
Static Electricity Precautions.....	7
Pre-Installation Inspection.....	7
Chapter 2: Mainboard Installation.....	9
Mainboard Components.....	10
I/O Ports.....	11
Install A CPU.....	11
Install Memory.....	13
Setting Jumper Switches.....	15
Install the Mainboard.....	16
Optional Extension Brackets.....	18
Install Other Devices.....	19
Expansion Slots.....	22
Chapter 3: BIOS Setup Utility.....	25
Introduction.....	25
Running the Setup Utility.....	26
Standard CMOS Setup Page.....	27
Advanced Setup Page.....	28
Power Management Setup Page.....	30
PCI / Plug and Play Setup Page.....	32
Load Optimal Settings.....	33
Load Best Performance Settings.....	33
Features Setup Page.....	34
CPU PnP Setup Page.....	36
Hardware Monitor Page.....	37
Change Password.....	37
Exit.....	38
Chapter 4: Software & Applications.....	39
Introduction.....	39
Installing Support Software.....	40
Bundled Software Installation.....	42

Mainboard User's Manual

Chapter 1

Introduction

This mainboard has a **Socket-A** support for the **AMD K7** processors. The Socket-A processor's front-side bus speed is **200/266MHz**.

This mainboard has a **KM266** chipset that supports a **4X AGP** slot for highly graphics display, **100/133 MHz DDR/SDR**, and **Ultra DMA ATA100** function to provide outstanding high system performance under all types of system operations. The mainboard has the built-in **AC97 Codec**, a **CNR** (Communications and Networking Riser) slot and a built-in **10BaseT/100BaseTX Network Interface**. This mainboard has the **128-bit 2D/3D AGP Graphics Accelerator** with 32MB frame buffer, supporting **AGP 4X 266MHz** mode up to 1GB/s bandwidth, which provides a direct connection between the graphics sub-system and memory so that the graphics do not have to compete for processor time with other devices on the PCI bus. There is a full set of **I/O Ports** including PS/2 keyboard and mouse ports, two back-panel USB ports, one parallel port, one serial port and one onboard VGA (S3). Connecting extended USB modules to the mainboard makes six extra USB ports (headers USB2, USB3 and USB5).

This mainboard has all the features you need to develop a powerful multimedia workstation that is network ready. The board is **Micro ATX size** and has power connectors for an **ATX** power supply.

Mainboard User's Manual

Key Features

The key features of this mainboard include:

Socket-A Processor Support

- Supports AMD **Athlon XP/Athlon/Duron** processors
- Supports 200/266 MHz Front-Side Bus

Chipset

There are **VIA KM266** Northbridge and VT8233 Southbridge in this chipset in accordance with an innovative and scalable architecture with proven reliability and performance. A few of the chipset's advanced features are:

- An advanced V-Link memory controller architecture that provides the bandwidth up to 266 MB/s and performance necessary for even the most demanding Internet and 2D/3D graphics
- Support for an 4xAGP interface providing vivid 2D/3D graphics and video performance

Memory Support

- Two 168-pin DIMM slots for SDRAM memory modules
- Two 184-pin DIMM slots for DDR memory modules
- Support for 100/133 MHz memory bus
- Maximum installed memory is 2GB

Notice: You can NOT use SDRAM and DDR simultaneously.

Expansion Slots

- One CNR slot
- One 4X AGP slot for AGP 2.0-compliant interface
- Two 32-bit PCI slots for PCI 2.2-compliant bus interface

1: Introduction

Onboard IDE channels

- Primary and Secondary PCI IDE channels
- Support for PIO (programmable input/output) modes
- Support for Multiword DMA modes
- Support for Bus Mastering and Ultra DMA ATA **100** 33/66/**100** modes

Power Supply and Power Management

- ATX power supply connector
- ACPI and previous PMU support, suspend switch, keyboard power on/off
- Supports Wake on LAN

VGA

- Single cycle 128-bit 3D architecture
- 128-bit 2D graphic engine
- 8/16/32 MB frame buffer using system memory
- Supports AGP 4X 266 MHz mode up to 1GB/s bandwidth
- Supports 250MHz RAMDAC
- 2D/3D resolutions up to 1920x1440
- Supports AGP Rev. 2.0 Spec. Compliant

AC97 Codec

- Compliant AC97 2.1 specification
- Supports 18-bit ADC (Analog Digital Converter) and DAC (Digital Analog Converter) as well as 18-bit stereo full-duplex codec

Onboard I/O Ports

- Provides PC99 Color Connectors for easy peripheral device connections
- Floppy disk drive connector with 1Mb/s transfer rate
- Two PS/2 ports for keyboard and mouse
- One serial port with 16C550-compatible fast UART
- One parallel port with ECP and EPP support
- One MIDI/Game port
- Two back-panel USB ports and optional six USB ports (onboard USB headers: header USB2, USB3 and USB5)
- One infrared port connector for optional module

Mainboard User's Manual

Built-in Ethernet LAN

- Built-in **10BaseT/100BaseTX Ethernet LAN**
- LAN controller integrates Fast Ethernet MAC and PHY compliant with IEEE802.3u 100BASE-TX, 10BASE-T and ANSI X3.263 TP-PMD standards
- Compliant with ACPI 1.0 and the Network Device Class Power Management 1.1
- High Performance provided by 100Mbps clock generator and data recovery circuit for 100Mbps receiver

USB 2.0(optional VT6202)

- Compliant with Universal Serial Bus Specification Revision 2.0
- Compliant with Intel's Enhanced Host Controller Interface Specification Revision 0.95
- Compliant with Universal Host Controller Interface Specification Revision 1.1
- PCI multi-function device consists of two **UHCI Host Controller** cores for full-/low-speed signaling and one **EHCI Host Controller** core for high-speed signaling
- Root hub consists 4 downstream facing ports with integrated physical layer transceivers shared by **UHCI** and **EHCI** Host Controller
- Support PCI-Bus Power Management Interface Specification release 1.1
- Legacy support for all downstream facing ports

1: Introduction

Hardware Monitoring

- Built-in hardware monitoring for CPU & System temperatures, fan speeds and mainboard voltages

Onboard Flash ROM

- Supports Plug and Play configuration of peripheral devices and expansion cards

Bundled Software

- **PC-Cillin2000** provides automatic virus protection under Windows 98/ME/NT/2000/XP
- **MediaRing Talk** provides PC to PC or PC to Phone internet phone communication
- **3Deep** delivers the precise imagery and displays accurate color in your monitor
- **Recovery Genius 21st V5.0** provides the function to recover, reserve and transfer hard disk data.
- **CD Ghost** is the software stimulating a real CD-ROM to perform equivalent function.
- **Language Genius 21st** is the software to provides learning tools of language and singing.
- **PC DJ** is a dual-MP3 player that enables users to actually mix music right on their own personal computers.
- **Adobe Acrobat Reader V5.0** is the software to help users read .PDF files.

Dimensions

- Micro ATX form factor (24.4cm x 24.4cm)

Mainboard User's Manual

Package Contents

Attention: This mainboard series has three models, M825LR(LAN Ready), M825 and M825ULR (USB 2.0, LAN Ready). Please contact your local supplier for more information about your purchased model. Each model will support different specification listed as below:

Model	Specification
M825LR	Onboard LAN PHY chip (U2), USB connector only.
M825	Support USB connector only
M825ULR	Onboard VT6202 USB 2.0 chipset (U18) and LAN PHY chip (U2), support USB + RJ-45 LAN connector

Your mainboard package ships with the following items:

- The mainboard
- This User's Guide
- 1 UDMA/66 IDE cable
- 1 Floppy disk drive cable
- Support software on CD-ROM disk

Optional Accessories

You can purchase the following optional accessories for this mainboard.

- Extended USB module

1: Introduction

Static Electricity Precautions

Components on this mainboard can be damaged by static electricity. Take the following precautions when unpacking the mainboard and installing it in a system.

1. Keep the mainboard and other components in their original static-proof packaging until you are ready to install them.
2. During installation, wear a grounded wrist strap if possible. If you don't have a wrist strap, discharge static electricity by touching the bare metal of the system chassis.
3. Handle the mainboard carefully by the edges. Avoid touching the components unless it is absolutely necessary. During installation put the mainboard on top of the static-protection packaging it came in with the component side facing up.

Pre-Installation Inspection

1. Inspect the mainboard for damage to the components and connectors on the board.
2. If you suspect that the mainboard has been damaged, do not connect power to the system. Contact your mainboard vendor and report the damage.

Mainboard User's Manual

Chapter 2

Mainboard Installation

To install this mainboard in a system, please follow these instructions in this chapter:

- ❑ Identify the mainboard components
- ❑ Install a CPU
- ❑ Install one or more system memory modules
- ❑ Make sure all jumpers and switches are set correctly
- ❑ Install this mainboard in a system chassis (case)
- ❑ Connect any extension brackets or cables to connecting headers on the mainboard
- ❑ Install other devices and make the appropriate connections to the mainboard connecting headers

Note:

1. Before installing this mainboard, make sure jumper JP2 is under Normal setting. See this chapter for information about locating JP2 and the setting options.
2. Never connect power to the system during installation; otherwise, it may damage the mainboard.

Mainboard User's Manual

Mainboard Components

This diagram below identifies major components on the mainboard.

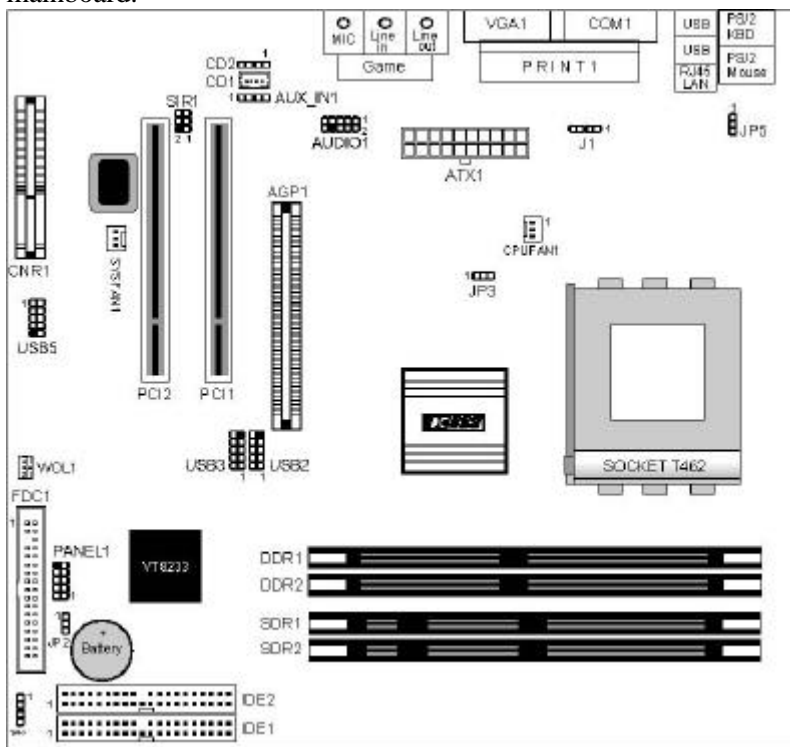

Note: Any jumpers on your mainboard that do not appear in the illustration above are for testing only.

2: Mainboard Installation

I/O Ports

The illustration below shows a side view of the built-in I/O ports on the mainboard.

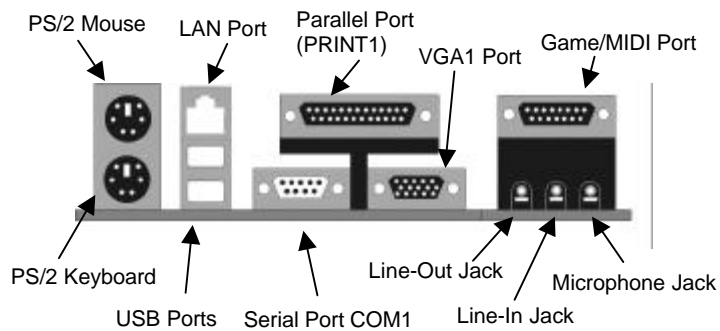

Install A CPU

This mainboard has a Socket-462 CPU socket for AMD K7 processors.

To ensure reliability, ensure that your processor has a heatsink/cooling fan assembly.

Do not try to install a Socket-370/Socket-7 processor in the Socket-462. A Socket-370/Socket-7 processor such as the PPGA Celeron, FCPGA Pentium-III, Pentium-MMX, or the AMD K5/K6 does not fit in the Socket-462.

The following list notes the processors that are currently supported by this mainboard.

Athlon XP: 1500+ ~ 2000+; FSB: 266 MHz

Athlon: 650 MHz~1.4 GHz, FSB: 200 MHz, 266 MHz

Duron: 550 MHz~1.2 GHz, FSB: 200 MHz

Mainboard User's Manual

Installing a Socket-462 Processor

A processor installs into the ZIF (Zero Insertion Force) Socket-462 on the mainboard.

1. Locate the Socket-462 and CPUFAN1. Pull the locking lever out slightly from the socket and raise it to the upright position.

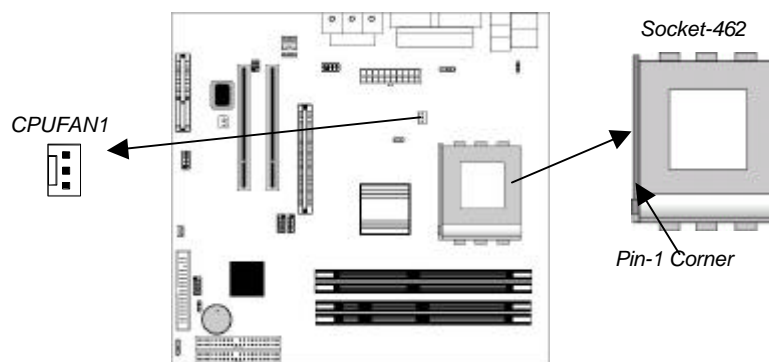

2. On the processor, identify the Pin-1 corner by its beveled edge.
3. On the Socket-462, identify the Pin-1 corner. The Pin-1 corner is at the top of the locking lever when it is locked.
4. Match the Pin-1 corners and insert the processor into the socket. No force is required and the processor should drop into place freely.
5. Swing the locking lever down and hook it under the catch on the side of the socket. This secures the CPU in the socket.
6. All processors should be installed with a combination heatsink/cooling fan (the original fan is recommended, the others' fan is not), connect the cable from the fan to the CPU fan power connector CPUFAN1.

See the Setting Jumper Switches section for detail information on CPU System Bus settings.

2: Mainboard Installation

Install Memory

This mainboard accommodates 168-pin 3.3V/184-pin 2.5V unbuffered SDRAM/DDR SDRAM (Double Data Rate SDRAM) memory modules. The memory chips must be standard or registered SDRAM (Synchronous Dynamic Random Access Memory).

You must install at least one memory module in order to work the mainboard, **either SDRAM or DDR SDRAM, but you cannot work them simultaneously.**

SDRAM provides 800 MB/s or 1 GB/s data transfer rate corresponding with the bus 100 MHz or 133 MHz. It doubles the rate to 1.6 GB/s and 2.1 GB/s by transferring data on both the rising and falling edges of the clock. DDR SDRAM uses additional power and ground lines and requires 184-pin 2.5V unbuffered DIMM module rather than the 168-pin 3.3V unbuffered DIMMs used by SDRAM.

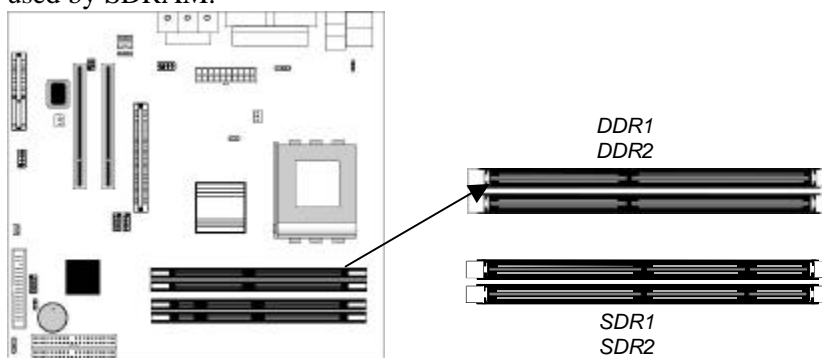

Mainboard User's Manual

Installation Procedure

The mainboard accommodates two memory modules. You must install at least one module of them. Each module can be installed with up to 2 GB system memory.

Install the memory modules as the following steps:

1. Push the latches on each side of the DIMM slot down.
2. Align the memory module with the slot. The DIMM slots are keyed with notches and the DIMMs are keyed with cutouts so that they can only be installed correctly.
3. Check that the cutouts on the DIMM module edge connector match the notches in the DIMM slot.
4. Install the DIMM module into the slot and press it firmly down until it seats correctly. The slot latches are levered upwards and latch on to the edges of the DIMM.
5. Install any remaining DIMM modules.

2: Mainboard Installation

Setting Jumper Switches

Jumpers are sets of pins connected together with jumper caps. The jumper caps change the mainboard's operation by changing the electronic circuits on the mainboard. If we connect two pins with a jumper cap, these pins are **SHORT**; if remove a jumper cap from these pins, they are **OPEN**.

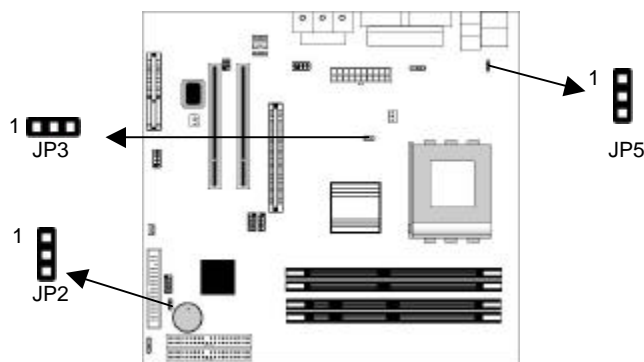

Jumper JP2: Clear CMOS Memory

This jumper can clear the CMOS memory. You may need to clear the CMOS memory if the settings in the Setup Utility are incorrect that your mainboard can't operate. To clear the CMOS memory, disconnect all the power cables, and then move the jumper cap into the **CLEAR** setting for a few seconds.

Function	Jumper Setting
Normal	Short Pins 1-2
Clear CMOS	Short Pins 2-3

Jumper JP3: CPU Clock Selector

This 3-pin jumper selects the processor 133 MHz or 100 MHz.

Function	Jumper Setting
100 MHz	Short Pins 1-2
133 MHz	Short Pins 2-3

Mainboard User's Manual

Jumper JP5: Keyboard Power On Selector

If you enable the Keyboard Power On feature, you can use hot keys on your keyboard as a power on/off switch for the system.

Note: The system must provide 1A on the +5VSB (+5V Standby) signal before using the Keyboard Power On function.

Function	Jumper Setting
Disable Keyboard Power On	Short Pins 1-2
Enable Keyboard Power On	Short Pins 2-3

Install the Mainboard

Install the mainboard in a system chassis (case). The board is an ATX size mainboard with a twin-tier of I/O ports. You can install this mainboard in an ATX case. Ensure that your case has an I/O cover plate that matches the ports on this mainboard.

Install the mainboard in a case. Follow the instructions provided by the case manufacturer using the hardware and internal mounting points on the chassis.

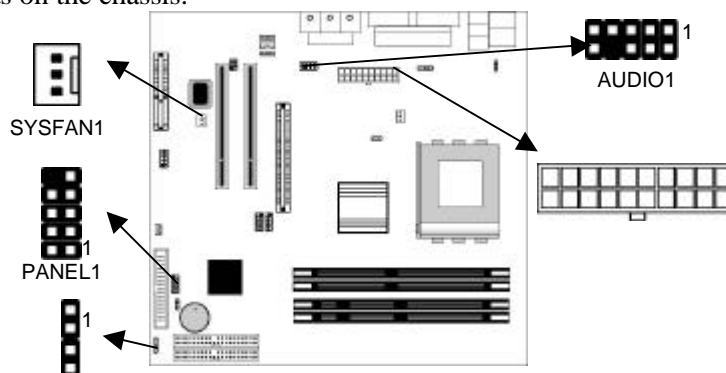

Connect the power connector from the power supply to the **ATX1** connector on the mainboard.

If there is a cooling fan installed in the system chassis, connect the cable from the cooling fan to the **SYSFAN1** fan power connector on the mainboard.

Connect the cable from the PC speaker to the **SPK1** header on the mainboard.

Pin	Signal	Pin	Signal
1	+5V	2	NC
3	GND	4	SPKR

2: Mainboard Installation

Connect the case switches and indicator LEDs to the **PANEL1** header.

Pin	Signal	Pin	Signal
1	HDD_LED_P	2	PWR/ACPI LED
3	HDD_LED_N	4	PWR/ACPI LED
5	RESET	6	POWER BUTTON
7	RESET	8	POWER BUTTON
9	KEY	10	KEY

If there are a headphone jack or/and a microphone jack on the front panel, connect the cables to the **AUDIO1** header on the mainboard.

Pin	Signal	Pin	Signal
1	MIC	2	GND
3	MIC-P	4	VCC
5	AUD_FPOUT_R	6	AUD_RFT_R
7	NC	8	KEY
9	AUD_FPOUT_L	10	AUD_RFT_L

Note: If you want to connect the front panel sound jack, you have to remove jumper caps of Pin(5-6) and Pin(9-10) from the AUDIO1 header.

Mainboard User's Manual

Optional Extension Brackets

For this mainboard, you can obtain some USB module extension brackets. You can use auxiliary USB connectors USB2 and USB3 for USB 1.1 without Chipset VT6202 on the mainboard; connector USB5 for USB 2.0 with Chipset VT6202. Following these steps

Note:

red stripe on the Pin- e.

Extended USB Module

(USB2 and USB3 for USB 1.1; USB5 for USB 2.0 only when the Chipset VT6202 is installed).

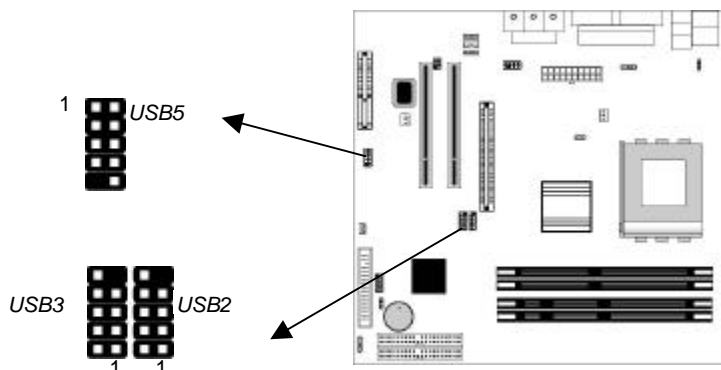

Pin	Signal	Pin	Signal
1	VERG_FP_USBPWR0	2	VERG_FP_USBPWR0
3	USB_FP_P0-	4	USB_FP_P1-
5	USB_FP_P0+	6	USB_FP_P1+
7	GROUND	8	GROUND
9	KEY	10	KEY

1. Locate the USB2/3/5 header on the mainboard.
2. Plug the bracket cable onto the USB2/3/5 header.
3. Remove a slot cover from one of the expansion slots on the system chassis. Install an extension bracket in the opening. Secure the extension bracket to the chassis with the screw that held the slot cover.

2: Mainboard Installation

Install Other Devices

Install and connect any other devices in the system following the steps below.

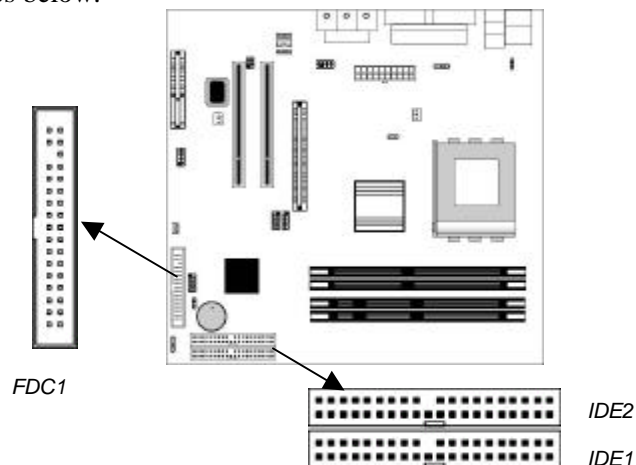

Floppy Disk Drive

support one or two drives. Drives can be 3.5" or 5.25" wide, with capacities of 360K, 720K, 1.2MB, 1.44MB, or 2.88MB.

Install your drives and connect power from the system power supply. Use the c disk drive connector **FDC1**

IDE devices include hard disk drives, high density diskette drives, and CD ROM or DVD-

The mainboard ships with an IDE cable that can support IDE devices. If you connect two devices to a single cable, you must configure one of the drives as Master and one of the drives as

configure the device as a Master or Slave device. The Master

Install the device(s) and connect power from the system power

Primary IDE channel connector **IDE1**

Mainboard User's Manual

If you want to install more IDE devices, you can purchase a second IDE cable and connect one or two devices to the Secondary IDE channel connector **IDE2** on the mainboard. If you have two devices on the cable, one must be Master and one must be Slave.

Internal Sound Connections

If you have installed a CD-ROM drive or DVD-ROM drive, you can connect the drive audio cable to the onboard sound system.

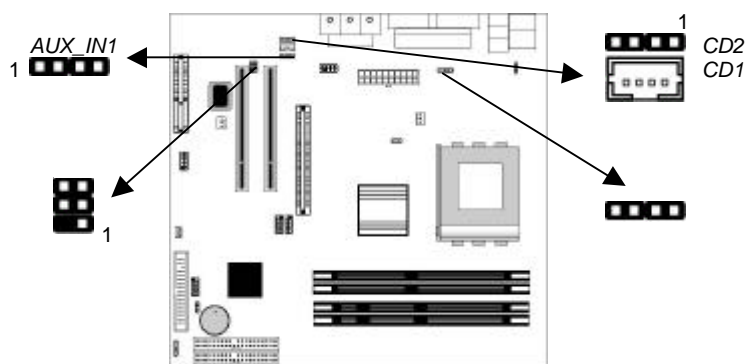

There are two kinds of connector because different brands of CD ROM drive have different kinds of audio cable connectors. Connect the cable to the appropriate connector.

CD1

	Signal
1	GND
2	CD IN L
3	GND
4	CD IN R

CD2

Pin	Signal
1	CD IN L
2	GND
3	GND
4	CD IN R

2: Mainboard Installation

Infrared Port

You can connect an infrared port to the mainboard. You can purchase this option from third-party vendors.

Pin	Signal	Pin	Signal
1	NC	2	KEY
3	+5V	4	GND
5	IRTX	6	IRRX

1. Locate the infrared port **SIR1** header on the mainboard.
2. If you are adding an infrared port, connect the ribbon cable from the port to the SIR1 header and then secure the port to an appropriate place in your system chassis.

Aux-In Connection

If you have installed a secondary CD-ROM drive or DVD-ROM drive, you can connect the drive audio cable to the onboard sound system. On the mainboard, locate the 4-pin auxiliary audio-in header **AUX_IN1**, and connect the cable to the connector.

Pin	Signal	Pin	Signal
1	AUX_L	2	AUD_GND
3	AUD_GND	4	AUX_R

Onboard LAN LED Connections

If you have a set indicator LEDs for the onboard LAN communication, you can connect the LED cable to the header **J1**. Pins 1-2 are for Link LED. Pins 3-4 are for 10/100 Mbps mode LED, the onboard LAN run in 100 Mbps mode when the LED lit.

Pin	Signal	Pin	Signal
1	Link LED	2	GND
3	GND	4	10/100 Mbps mode LED

Mainboard User's Manual

Expansion Slots

This mainboard has one AGP, one CNR and two 32-bit PCI slots.

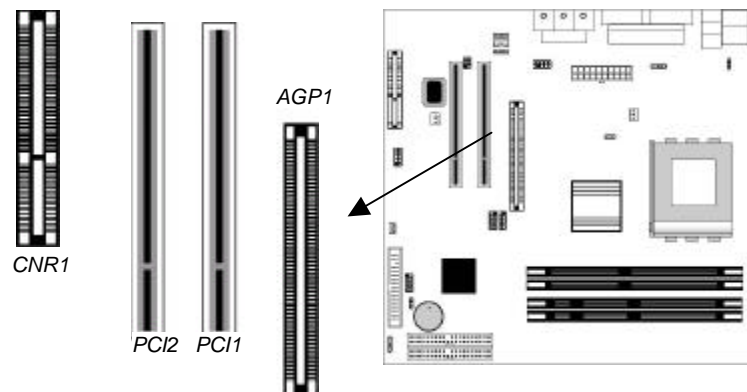

Follow the steps below to install a PCI/AGP/CNR expansion card.

1. Locate the CNR, AGP or PCI slots on the mainboard.
2. Remove the blanking plate of the slot from the system chassis.
3. Install the edge connector of the expansion card into the slot.
Ensure the edge connector is correctly seated in the slot.
4. Secure the metal bracket of the card to the system chassis with a screw.

2: Mainboard Installation

If you have installed a LAN adapter expansion card, connect the **WOL1**. This allows
down. You need to enable this feature in the BIOS setup utility.

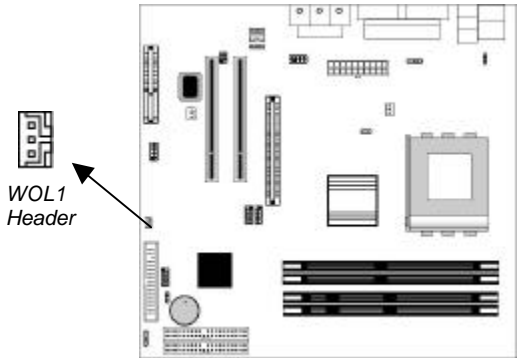

Pin	Signal
1	5VSB
2	GND
3	RIJ

Mainboard User's Manual

Chapter 3

BIOS Setup Utility

Introduction

The BIOS Setup Utility records settings and information of your computer, such as date and time, the type of hardware installed, and various configuration settings. Your computer applies the information to initialize all the components when booting up and basic functions of coordination between system components.

If the Setup Utility configuration is incorrect, it may cause the system to malfunction. It can even stop your computer booting properly. If it happens, you can use the clear CMOS jumper to clear the CMOS memory which has stored the configuration information; or you can hold down the **Page Up** key while rebooting your computer. Holding down the **Page Up** key also clears the setup information.

You can run the setup utility and manually change the configuration. You might need to do this to configure some hardware installed in or connected to the mainboard, such as the CPU, system memory, disk drives, etc.

Mainboard User's Manual

Running the Setup Utility

Every time you start your computer, a message appears on the screen before the operating system loading that prompts you to *Hit if you want to run SETUP*". Whenever you see this message, press the **Delete** key. The Setup Utility appears on your monitor.

AMIBIOS SIMPLE SETUP UTILITY - VERSION 1.21.10
(C) 2000 American Megatrends, Inc. All Rights Reserved

Standard CMOS Setup	Features Setup
Advanced Setup	CPU PnP Setup
Power Management Setup	Hardware Monitor
PCI / Plug and Play Setup	Change Password
Load Optimal Settings	Exit
Load Best Performance Settings	
Esc : Quit : Select Item (Shift)F2 : Change Color F5 : Old Values	
F6 : Optimal values F7 : Best performance values F10 : Save&Exit	
Standards CMOS setup for changing time, date, hard disk type, etc.	

You can use the cursor arrow keys to highlight any of the options on the main menu page. Press **Enter** to select the highlighted option. To leave the setup utility, press the **Escape** key. To cycle through the Setup Utility's optional color schemes hold down the **Shift** key and press **F2**.

Some of the options on the main menu page lead to tables of items with installed values. In these pages, use the cursor arrow keys to highlight the items, and then use the **PgUp** and **PgDn** keys to cycle through the alternate values for each of the items. Other options on the main menu page lead to dialog boxes which require you to answer Yes or No by hitting the **Y** or **N** keys.

If you have already made changes to the setup utility, press **F10** to save those changes and exit the utility. Press **F5** to reset the changes to the original values. Press **F6** to install the setup utility with a set of default values. Press **F7** to install the setup utility with a set of high-performance values.

3: BIOS Setup Utility

Standard CMOS Setup Page

Use this page to set basic information such as the date, the time, the IDE devices, and the diskette drives. If you press the F3 key, the system will automatically detect and configure the hard disks on the IDE channels.

AMBIOS SETUP - STANDARD CMOS SETUP										
(C) 2000 American Megatrends, Inc. All Rights Reserved										
Date (mm/dd/yy) : Tue Feb 19, 2002										
Time (hh/mm/ss) : 11:27:16										
	Type	Size	Cyln	Head	WPcom	Sec	LBA Mode	Bik Mode	PIO Mode	32Bit Mode
Pri Master	: Auto		On							
Pri Slave	: Auto									On
Sec Master	: Auto									On
Sec Slave	: Auto									On
Floppy Drive A : 1.44 MB 3 1/2										
Floppy Drive B : Not Installed										
Month : Jan - Dec					ESC : Exit					
Day : 01 - 31					: Select Item					
Year : 1901 - 2099					PU/PD/+/- : Modify					
					(Shift)F2 : Color					
					F3 : Detect All HDD					

Date & Time	Use these items to set the system date and time
Pri Master	Use these items to configure devices connected to the Primary and Secondary IDE channels. To configure an IDE hard disk drive, choose <i>Auto</i> . If the <i>Auto</i> setting fails to find a hard disk drive, set it to <i>User</i> , and then fill in the hard disk characteristics (Size, Cyls, etc.) manually. If you have a CD-ROM drive, select the setting <i>CDROM</i> . If you have an ATAPI device with removable media (e.g. a ZIP drive or an LS-120) select <i>Floptical</i> .
Pri Slave	
Sec Master	
Sec Slave	
Floppy Drive A	Use these items to set the size and capacity of the floppy diskette drive(s) installed in the system.
Floppy Drive B	

Mainboard User's Manual

Advanced Setup Page

Use this page to set more advanced information about your system. Take some care with this page. Making changes can affect the operation of your computer.

AMIBIOS SETUP – ADVANCED SETUP			
(C) 2000 American Megatrends, Inc. All Rights Reserved			
Quick Boot	Enabled	AGP Mode	4X
1 st Boot Device	IDE-0	AGP Comp. Driving	Auto
2 nd Boot Device	Floppy	Manual AGP Comp. Driving	CB
3 rd Boot Device	CDROM	AGP Aperture Size	64MB
Try Other Boot Devices	Yes	CLK Gen Spread Spectrum	Disabled
S.M.A.R.T. for Hard Disks	Disabled	Auto detect PCI Clk	Enabled
BootUp Num-Lock	On	Delay For Hard Drive (Sec.)	4
Floppy Drive Swap	Disabled		
Floppy Drive Seek	Disabled		
PS/2 Mouse Support	Enabled		
Primary Display	VGA/EGA		
Password Check	Setup		
Boot To OS/2>64MB	No	ESC : Quit	: Select Item
L1 Cache	WriteBack	F1 : Help	PU/PD/+/- : Modify
L2 Cache	Enabled	F5 : Old Values (Shift)F2	: Color
System BIOS Cacheable	Enabled	F6 : Load BIOS Defaults	
SDRAM Timing by SPD	Disables	F7 : Load Setup Defaults	
SDRAM Frequency	Auto		
SDRAM CAS# Latency	2.5		
SDRAM Bank Interleave	2-Way		

Quick Boot	If you enable this item, the system starts up more quickly by elimination some of the power on test routines.
1st Boot Device	Use these items to determine the device order the computer uses to look for an operating system to load at start-up time.
2nd Boot Device	
3rd Boot Device	
Try Other Boot Device	If you enable this item, the system will also search for other boot devices if it fails to find an operating system from the first two locations.
S.M.A.R.T. for Hard Disks	Enable this item if any IDE hard disks support the S.M.A.R.T. (Self-Monitoring, Analysis and Reporting Technology) feature.
BootUp Num-Lock	This item determines if the Num Lock key is active or inactive at system start-up time.
Floppy Drive Swap	If you have two diskette drives installed and you enable this item, drive A becomes drive B and drive B becomes drive A.

3: BIOS Setup Utility

Floppy Drive Seek	If you enable this item, your system will check all floppy disk drives at start up. Disable this item unless you are using an old 360KB drive.
PS/2 Mouse Support	If this item is set to Enabled, the onboard PS/2 Mouse port will work. Setting this to Disable turns off the port.
Primary Display	This item determines the display devices for the primary display of your computer.
Password Check	If you have entered a password for the system, use this item to determine, if the password is required to enter the Setup Utility (<i>Setup</i>) or required both at start-up and to enter the Setup Utility (<i>Always</i>).
Boot to OS/2 > 64MB	Enable this item if you are booting the OS/2 operating system and you have more than 64MB of system memory installed.
L1/L2 Cache	Leave these items enabled since all the processors that can be installed on this board have internal cache memory.
System BIOS Cacheable	If you enable this item, a segment of the system BIOS will be cached to main memory for faster execution.
SDRAM Timing by SPD	This item enables or disables the SDRAM timing defined by the Serial Presence Detect electrical.
SDRAM Frequency	This item determines frequency of SDRAM memory.
SDRAM CAS# Latency	This item determines the operation of SDRAM memory CAS (column address strobe). It is recommended that you leave this item at the default value. The 2T setting requires faster memory that specifically supports this mode.
SDRAM Bank Interleave	Enable this item to increase SDRAM memory speed. When enabled, separate memory banks are set for odd and even addresses, and upcoming byte of memory is accessible while refreshing the current byte.
AGP Mode	This item provides the OnBoard VGA mode with three options of 1,2, 4 multiplied frequency.
AGP Comp. Driving	This item signals the auto or manual driving current on AGP cards. Some AGP cards need stronger driving current for operation. We recommend you set this item to be default value.

Mainboard User's Manual

Manual AGP Comp. Driving	This item decides the AGP current driving value while AGP Driving is set to Manual.
AGP Aperture Size	This option determines the effective size of the AGP Graphic <i>Aperture</i> , where memory-mapped graphic data structures are located.
CLK Gen Spread Spectrum	This item enables the clock to generate spread spectrum.
Auto Detect PCI Clk	When this item is enabled, BIOS will disable the clock signal of free PCI slots.
Delay For Hard Drive (Sec.)	If you enable this item, your hard drive will be delayed for a preset period of time. We recommend that you leave this item at the default value

Power Management Setup Page

This page sets some of the parameters for system power management operation.

AMIBIOS SETUP - POWER MANAGEMENT SETUP (C) 2000 American Megatrends, Inc. All Rights Reserved		
ACPI Aware O/S	Yes	ESC : Quit : Select Item F1 : Help PU/PD/+/- : Modify F5 : Old Values (Shift)F2 : Color F6 : Load BIOS Defaults F7 : Load Setup Defaults
Power Management/APM	Enabled	
Video Power Down Mode	Suspend	
Hard Disk Power Down Mode	Stand By	
Standby Time Out (Minute)	Disabled	
Suspend Time Out (Minute)	Disabled	
Resume On PME#/LAN/Ring	Disabled	
PowerOn by KBC	Disabled	
Wake-Up Key	Any Key	
Wake-Up Password	N/A	
PowerOn by RTC Alarm	Disabled	
RTC Alarm Date	15	
RTC Alarm Hour	12	
RTC Alarm Minute	30	
RTC Alarm Second	30	

ACPI Aware O/S	This item supports ACPI (Advanced Configuration and Power management Interface). Use this item to enable or disable the ACPI feature.
Power Management/APM	This item enables or disables a power management scheme. If you enable power management, there are some options for you to decide the power management operation. Both APM and ACPI are supported.

3: BIOS Setup Utility

Video Power Down Mode	This item determines a required power-saving mode to power down the graphics sub-system. You can force the graphics to power down in Stand By or Suspend modes, or disable the powerdown.
Hard Disk Power Down Mode	This item determines a required power-saving mode to power down the hard disk drive(s). You can force the hard disk to power down in Stand By or Suspend modes, or disable the powerdown.
Standby Time Out (Minute)	This item sets up the timeout (minutes) for the Standby mode. The computer will be a power-saving Standby mode if the system has been inactive after the setup time.
Suspend Time Out (Minute)	This item sets up the timeout (minutes) for the Suspend mode. The computer will be a power-saving Suspend mode if the system has been inactive after the setup time.
ResumeOn PME#/LAN/Ring	The system can be turned off by a software command. If you enable this item, the system can automatically resume if there is traffic on the onboard network adapter or PCI LAN/Modem card. You must use an ATX power supply in order to perform this feature.
PowerOn by KBC Wake up key Wake up password	If you enable this item, system can automatically resume by pressing hot keys on the keyboard or typing in the password. You must enable the Keyboard Power On jumper and use an ATX power supply in order to use this feature.
PowerOn by RTC Alarm / Date / Hour / Minute / Second	The system can be turned off with a software command. If you enable this item, the system can automatically resume at a fixed time based on the system's RTC (realtime clock). Use the items below this one to set the date and time of the wake-up alarm. You must use an ATX power supply in order to use this feature.

3: BIOS Setup Utility

Load Optimal Settings

If you select this item and press **Enter** a dialog box appears. If you press **Y**, and then **Enter**, the Setup Utility loads a set of fail-safe default values. These default values are not very demanding and they should allow your system to function with most kinds of hardware and memory chips.

Note: It is highly recommend that users enter this option to load optimal values for accessing the best performance.

Load Best Performance Settings

If you select this item and press **Enter** a dialog box appears. If you press **Y**, and then **Enter**, the Setup Utility loads a set of best-performance default values. These default values are quite demanding and your system might not function properly if you are using slower memory chips or other low-performance components.

Mainboard User's Manual

Features Setup Page

This page sets some of the parameters for peripheral devices connected to the system.

AMIBIOS SETUP – FEATURES SETUP		
(C) 2000 American Megatrends, Inc. All Rights Reserved		
OnBoard FDC	Enabled	
OnBoard Serial PortA	3F8h/COM1	
OnBoard IR Port	Disabled	
OnBoard Parallel Port	378h	
Parallel Port Mode	SPP	
Parallel Port IRQ	7	
Parallel Port DMA	N/A	
OnBoard Game Port	201h	ESC : Quit : Select Item
OnBoard MIDI Port	300h	F1 : Help PU/PD/+/- : Modify
MIDI Port IRQ	10	F5 : Old Values (Shift)F2 : Color
OnBoard IDE	Both	F6 : Load BIOS Defaults
OnChip LAN	Disabled	F7 : Load Setup Defaults
OnBoard AC'97 Audio	Enabled	
OnBoard MC'97 Modem	Auto	
USB Controller	All USB Port	
USB Device Legacy Support	Disabled	
ThumbDrive Support For DOS	Disabled	

OnBoard FDC	This item enables or disables the onboard floppy disk drive interface.
OnBoard Serial PortA	These items enable or disable the onboard COM1 serial port, and assign a port address.
OnBoard IR Port	This item enables or disables the Infrared port, and assigns a port address. If you select a specific address, the resources are assigned to the IR port, and you can use the five items below to determine the operation of the IR port
Onboard Parallel Port	This item enables or disables the onboard LPT1 parallel port, and assigns a port address. The Auto setting will detect and available address.
Parallel Port Mode	This item decides the parallel port mode. You can select SPP (Standard Parallel Port), ECP (Extended Capabilities Port), EPP (Enhanced Parallel Port), or ECP + EPP.
Parallel Port IRQ	This item assigns either IRQ 5 or 7 to the parallel port.

3: BIOS Setup Utility

Parallel Port DMA	This item assigns a DMA channel to the parallel port. The options are 0, 1 and 3.
OnBoard Game Port	This item enables or disables the I/O address for the game port.
OnBoard MIDI Port/IRQ	This item enables or disables the onboard MIDI port, and assigns a port address.
MIDI Port IRQ	This item assigns IRQ 5 to the parallel port.
OnBoard IDE	This item enables or disables either or both of the onboard Primary and Secondary IDE channels.
OnChip LAN	This item enables or disables the OnChip LAN.
Onboard AC'97 Audio	This item enables or disables the onboard AC'97 audio chip.
Onboard AC'97 Modem	This item enables or disables the onboard AC'97 modem chip.
USB Controller	Enable this item to select the USB ports or disable.
USB Device Legacy Support	This item enables the USB device, if you have installed a USB device on the system board.
ThumbDrive Support for DOS	Enable this item to make a small portion of memory storage device for the USB ports.

3: BIOS Setup Utility

Hardware Monitor Page

This page sets some of the parameters for the hardware monitoring function of this mainboard.

AMIBIOS SETUP – HARDWARE MONITOR		
(C) 2000 American Megatrends, Inc. All Rights Reserved		
*** System Hardware ***		
Vcore	1.616 V	
Vcc 2.5V	2.496 V	
Vcc 3.3V	3.392 V	
Vcc 5 V	4.972 V	
+12V	11.968V	
-12V	-12.071V	ESC : Quit : Select Item
SB5V	5.026 V	F1 : Help PU/PD/+/- : Modify
VBAT	3.488 V	F5 : Old Values (Shift)F2 : Color
SYSTEM Fan Speed	0 RPM	F6 : Load BIOS Defaults
CPU Fan Speed	4560 RPM	F7 : Load Setup Defaults
SYSTEM Temperature		
38 C/100 F		
CPU Temperature	31 C/	
87 F		

System / CPU Temperature	These items display CPU and system temperature measurement.
FANS & Voltage Measurements	These items indicate cooling fan speeds in RPM and the various system voltage measurements.

Change Password

If you highlight this item and press **Enter**, a dialog box appears which lets you enter a Supervisor password. You can enter no more than six letters or numbers. Press **Enter** after you have typed in the password. A second dialog box asks you to retype the password for confirmation. Press **Enter** after you have retyped it correctly. The password is then required to access the Setup Utility or for that and at start-up, depending on the setting of the Password Check item in Advanced Setup.

Mainboard User's Manual

Change or Remove the Password

Highlight this item, press **Enter** and type in the current password. At the next dialog box, type in the new password, or just press **Enter** to disable password protection.

Exit

Highlight this item and press **Enter** to save the changes that you have made in the Setup Utility configuration and exit the program. When the Save and Exit dialog box appears, press **Y** to save and exit, or press **N** to exit without saving.

Chapter 4

Software & Applications

Introduction

This chapter describes the contents of the support CD-ROM that comes with the mainboard package.

The support CD-ROM contains all useful software, necessary drivers and utility programs to properly run our products. More program information is available in a README file, located in the same directory as the software.

To run the support CD, simply insert the CD into your CD-ROM drive. An Auto Setup screen automatically pops out, and then you can go on the auto-installing or manual installation depending on your operating system.

If your operating system is Windows 98/ME/2000/XP, it will automatically install all the drivers and utilities for your mainboard; if Windows NT or manual installation, please follow the instructions described as the Installing under Windows NT or Manual Installation section.

Mainboard User's Manual

Installing Support Software

1. Insert the support CD-ROM disc in the CD-ROM drive.
2. When you insert the CD-ROM disc in the system CD-ROM drive, the CD automatically displays an Auto Setup screen.
3. The screen displays three buttons of **Setup**, **Browse CD** and **Exit** on the right side, and three others **Setup**, **Application** and **ReadMe** at the bottom. Please see the following illustration.



The **Setup** button runs the software auto-installing program as explained in next section.

The **Browse CD** button is a standard Windows command that you can check the contents of the disc with the Windows 98 file browsing interface.

The **Exit** button closes the Auto Setup window. To run the program again, reinsert the CD-ROM disc in the drive; or click the CD-ROM driver from the Windows Explorer, and click the Setup icon.

The **Application** button brings up a software menu. It shows the bundled software that this mainboard supports.

The **ReadMe** brings you to the Install Path where you can find out path names of software driver.

Mainboard User's Manual

Installing under Windows NT or Manual Installation

If you are under Windows NT, the auto-installing program doesn't work out; or you have to do the manual installation, please follow this procedure while the Auto Setup screen pops out after inserting the support CD-ROM:

1. Click the **Browse CD** button to bring up a file browser window. You can find out the **PATH.HTML**; or click the **ReadMe** to bring up a screen, and then click the Install Path at the bottom of the screen to find out the **PATH.HTML**, too.
2. Find out your mainboard model name from the **PATH.HTML**. Click the model name and obtain its correct driver directory.
3. Install each software in accordance with the corresponding driver path.

Bundled Software Information

All bundled software available on the CD-ROM is for users' convenience. You can install bundled software as follows:

1. Click the **Application** button while the Auto Setup screen pops out after inserting the support CD-ROM.
2. A software menu appears. Click the software you want to install.
3. Follow onscreen instructions to install the software program step by step until finished.