

3WMV Series

User Manual V1.0

Copyright 1999 Publishing. All Rights Reserved.

This manual, software and firmware described in it are copyrighted by their respective owners and protected under the laws of the Universal Copyright Convention. You may not reproduce, transmit, transcribe, store in a retrieval system, or translate into any language, in any form or by any means, electronic, mechanical, magnetic, optical, chemical, biological, molecular, manual, or otherwise, any part of this publication without the express written permission of the publisher.

All products and trade names described within are mentioned for identification purpose only. No affiliation with or endorsement of the manufacturer is made or implied. Product names and brands appearing in this manual are registered trademarks of their respective companies.

The information published herein has been checked for accuracy as of publishing time. No representation or warranties regarding the fitness of this document for any use are made or implied by the publisher. We reserve the right to revise this document or make changes in the specifications of the product described therein at any time without notice and without obligation to notify any person of such revision or change.

Written, edited, and printed in the Republic of China in Taiwan.

Item Checklist

Before you begin installing your motherboard, please make sure that the following materials have been shipped:

- 1 **The 3WMV Series Motherboard
(including 3WMV & 3WDMV)**
- 1 **Serial COM2 connector with bracket**
- 1 **80-wire ribbon cable for internal UltraDMA/66 IDE drives.
Note that the 80-wire cable has a 40-pin connector.**
- 1 **Floppy cable**
- 1 **CD with drivers and utilites**
- 1 **This 3WMV Series Motherboard Manual**

If you discover damaged or missing items, please contact your retailer.

Table of Contents

Chapter 1: Introduction		5
1-1	Introduction	5
1-2	Specifications	5
1-3	Static Electricity Precautions	8
Chapter 2: Hardware Configuration		9
2-1	Power Precautions	9
2-2	Parts Locations	10
2-3	Setting jumpers	12
2-4	System Memory(DIMM)	14
2-5	Central Processing Unit(CPU)	15
2-6	Expansion Cards	16
2-7	External Connectors	17
2-8	Power Connection Procedures	23
Chapter 3: Award BIOS Setup		25
3-1	Award BIOS Setup	25
3-2	Main Menu Options	27
	Standard CMOS Setup	27
	Advanced BIOS Features	29
	Advanced Chipset Features	31
	Integrated Peripherals	33
	Power Management Setup	36
	PnP/PCI Slot Configuration	39
	PC Health Status	39
	Frequency/Voltage Control	40
	Load Setup Defaults	41
	Set User Password	41
	Save & Exit Setup	41

Chapter 4 : Software Installation	43
4-1 Intel INF Utility Installation	43
4-2 VGA driver installation	44
4-3 Audio Driver Installation	45
4-4 Anti-Virus software installation	48

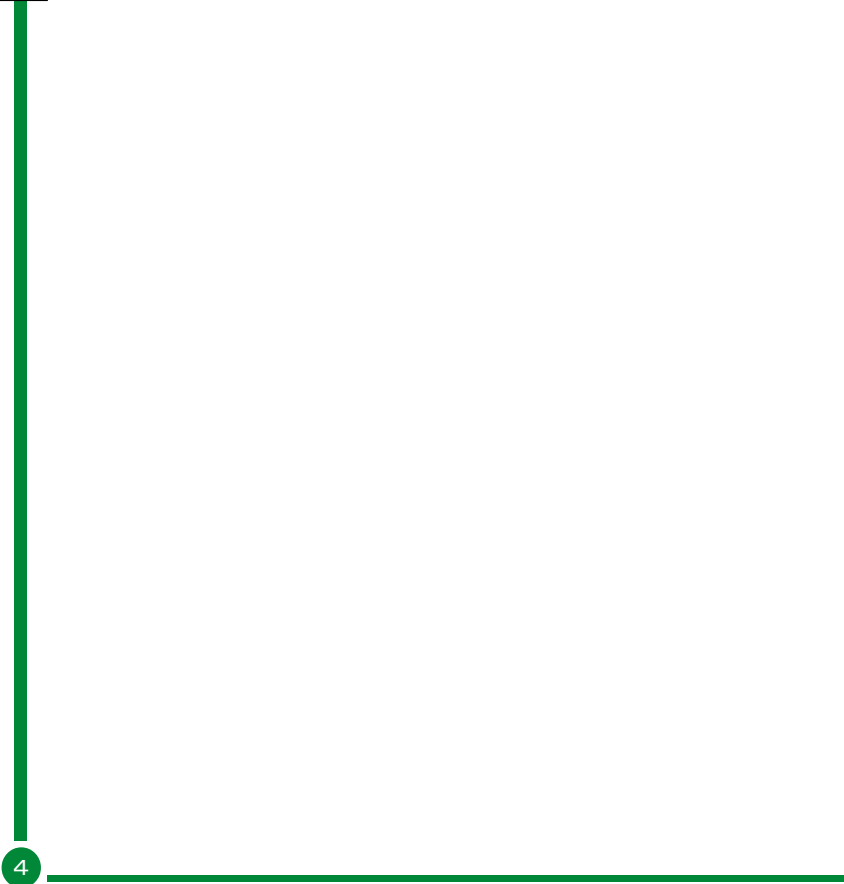

Chapter 1

Introduction

1-1 Introduction

The motherboard is a high-performance, low-cost motherboard which supports the Intel Socket 370 microprocessor and up to 512MB PC-100 SDRAM (2 DIMMs)

On-board features include 2X AGP, stereo sound, ATX power, super I/O, 2 UDMA/66 EIDE interfaces, 2 USB ports, 3 PCI expansion slots, and 1 AMR slot.

1-2 Specifications

- CPU and Chipset
 - Supports Intel Celeron processor designed for Socket 370 and packaged in Plastic Pin Grid Array (PPGA).
 - Intel 810 Chipset supports 66/100MHz Front Side Bus.
 - Use switching regulator to support CPU core voltage.
- Memory
 - 2 x 168-pin DIMM modules auto banking in multiple configuration up to 512MB.
- VGA
 - Integrated 2D/3D graphics chip(GMCH).
 - Integrated 24-bit 230MHz RAMDAC.
 - Optional 4MB display cache.

- Integrated H/W Motion compensation engine.

■ Audio

- Supports AC'97 CODEC (Analog Device AD1881/ALC100)
- Supports earphones, two channel speaker mode.
- MPU-401 game/MIDI port and Sound blaster® 16 compatible

■ Expansion Slot

- Three 32-bit PCI slots support Master mode.
- One Audio Modem Riser (AMR) slot

1

■ I/O Interface

- PCI Bus master IDE interface on board with two connectors support 4 IDE devices in 2 channel, the PCI IDE Controller supports PIO Mode 0 to Mode 4, Bus master IDE DMA Mode 2 and Ultra DMA 33/66.
- On board super Multi-I/O chip that support 2 serial port with 16550 Fast UART compatible, 1 parallel port with EPP and ECP capabilities, and a floppy disk drive interface.
- On board support PS/2 mouse Connector.
- On board support PS/2 Keyboard Connector.
- On board 2 USB ports.
- On board IrDA connector.
- Supports LS-120 floppy disk drive (120MB).

■ Other Function

- Over current protection for USB keyboard and mouse.
- Supports Password, Hot Key, PS/2 Mouse power on, and WOL (Wake On LAN).

■ Power Supply

- On board 3V, 5V and 12V 20-pins ATX

power connector.

- **Hardware Monitor** - Support CPU/System FAN status monitoring and alarm, CPU voltage, system temperature monitoring. 3 fan sensors, 9 voltage sensors, and 2 temperature sensors.

- **BIOS**
 - 4Mb Award Flash BIOS.
 - ACPI ready for PC98/Windows 98.
 - System BIOS supports ACPI function and Green feature function, DMI, Plug and Play Flash ROM.

- **Micro ATX Form Factor** -Dimensions: 210mm x 245mm

1-3 Static Electricity Precautions

Static electricity can easily damage your motherboard.

Observing a few basic precautions can help you safeguard against damage that could result in expensive repairs. Follow the measures below to protect your equipment from static discharge:

- Keep the motherboard and other system components in their antistatic packaging until you are ready to install them.
- Touch a grounded surface before you remove any system component from its protective antistatic packaging. A grounded surface within easy reach is the expansion slot covers at the rear of the system case, or any other unpainted portion of the system chassis.
- During configuration and installation, touch a ground surface frequently to discharge any static electric charge that may build up in your body. Another option is to wear a grounding wrist strap.
- When handling a motherboard or an adapter card, avoid touching its components. Handle the motherboard and adapter cards either by the edges or by the mounting bracket that attaches to the slot opening in the case.

1

Chapter 2

Hardware Configuration

This chapter tells how to setup the motherboard hardware, including instructions on setting jumpers and connecting peripherals, switches and indicators. Be sure to read all the safety precautions before you begin the installation procedure.

2-1 Power Precautions

Before you begin configuration, make sure you are working with an unplugged motherboard. Many components are powered by low-voltage current, but there still may be a dangerous electric current coming from the leads and power supply. You should take the following precautions:

- Turn off the power supply, and unplug the power cord before you begin.
- Unplug all cables that connect the motherboard to any external devices.

Note:

Before making connections to the board, make sure that power to the system is turned off.

2-2 Parts Locations

The following are parts descriptions for the motherboard shown on the next page.

1. PS/2 Mouse,PS/2 Keyboard Connectors
2. USB connectors
3. COM1
4. Parallel port
5. VGA Connector
6. Joystick/Midi,Line Out,Line In,Microphone In Connectors
7. COM2
8. AMR slot
9. AC'97 Audio CODEC
10. Internal Audio Connector AUX IN(JP12)
11. Internal Audio Connector CDIN2(JP11)
12. Internal Audio Connector CDIN1(JP10)
13. Wake-On-Modem connector
14. Wake-On-LAN Connector
15. Three PCI Slots
16. Intel810 Chipset
17. Intel I/O Controller Hub(ICH)
18. Chassis Fan Connector
19. 4Mb Firmware Hub
20. Optional 4MB Display Cache
21. Primary/Secondary IDE Connectors
22. Floppy Disk Drive Connector
23. DIMM Sockets
24. ATX Power Connector
25. Power Fan Connector
26. CPU Fan Connector
27. Socket 370 for Intel Celeron 370 processors

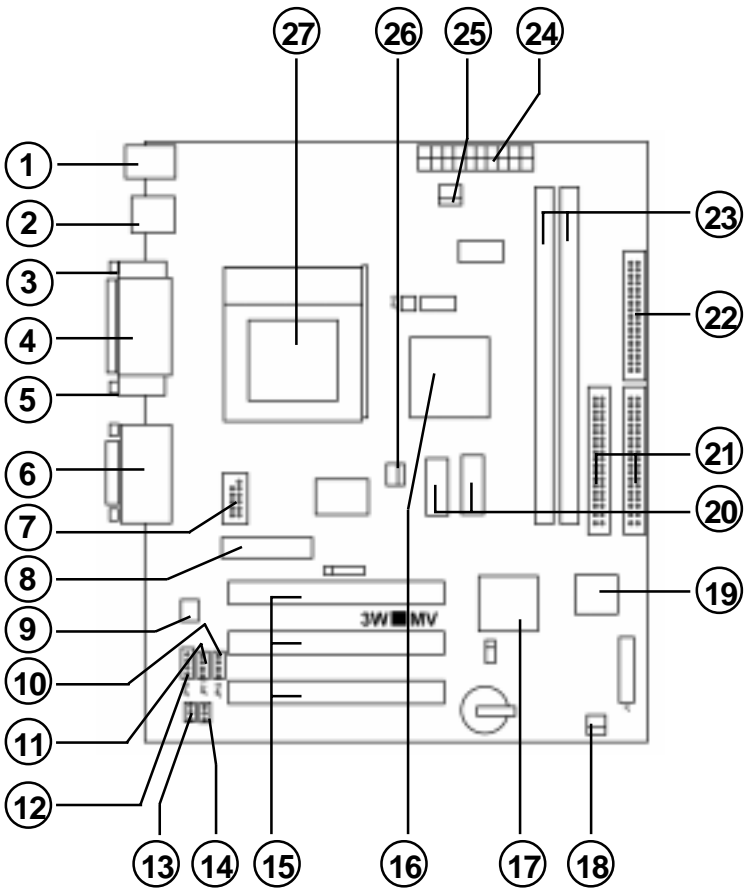

2.3 Setting jumpers

You may configure your motherboard to match the needs of your applications by setting jumpers. A jumper is the simplest kind of electrical switch. It consists of two metal pins and a small metal clip (often protected by a plastic cover) that slides over the pins to connect them. To “close” a jumper, you connect the pins with the clip. To “open” a jumper, you remove the clip. Sometimes a jumper will have three pins, labeled 1, 2, 3. In this case you would connect either pin 1 and 2 or 2 and 3.

2

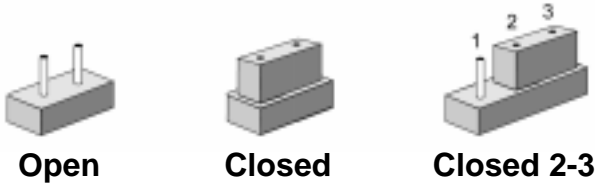

The jumper settings are schematically depicted in this manual as follows:



A pair of needle-nose pliers may be helpful when working with jumpers.

Note: When you open the jumper, attach the plastic jumper cap to one of the pins so you won't lose it.

Warning: Always completely disconnect the power cord from your board whenever you are working on it. Do not make connections while the power is on because sensitive electronic components can be damaged by the sudden rush of power.

Always ground yourself to remove any static charge before touching the board. Modern electronic devices are very sensitive to static electric charges. Use a grounding wrist strap at all times. Place all electronic components on a static-dissipative surface or in a static-shielded bag when they are not in the chassis.

■ CPU External Frequency Settings:(JP1,JP13)

The Motherboard supports Intel Socket 370 CPUs with 66MHz or 100MHz external frequency. Setting the jumper according to the external frequency of the CPU you are going to install on the motherboard.

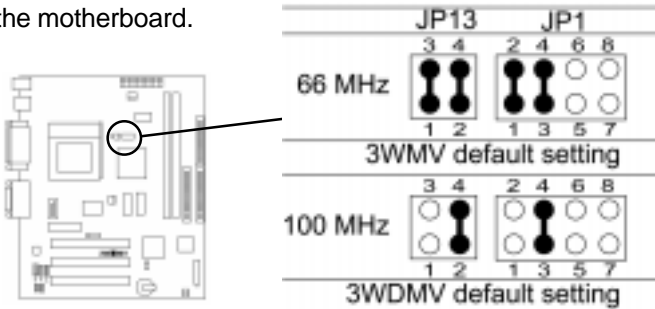

Note: This motherboard does not support 66MHz SDRAM. The PC-100 compliant SDRAM must be used because of the strict timing issues involved under this speed.

■ Clear CMOS:(JP4)

To clear the data stored in the CMOS, always turn off the computer first, then move this jumper to 2-3 pin to clear the CMOS. The jumper should be set to 1-2 pin (3V battery back up) before turn on the computer.

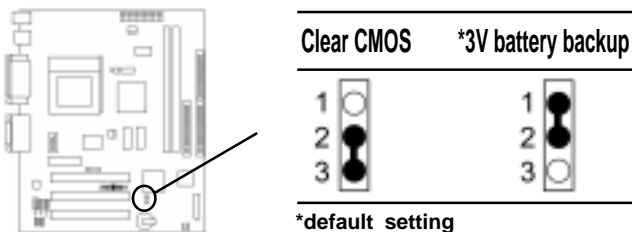

2.4 System Memory (DIMM)

The motherboard supports up to 512MB PC-100 SDRAM. No hardware or BIOS setup is required after adding or removing the system memory.

The Intel 810 chipset does not support ECC, However, ECC memory modules may still be used, but the ECC function will not be available.

Note:

2

- 1.The motherboard uses only Dual Inline Memory Modules (DIMMs). Sockets are available for 3.3Volt (power level) unbuffered Synchronous Dynamic Random Access Memory (SDRAM).
- 2.This motherboard does not support 66MHz SDRAM. The PC-100 compliant SDRAM must be used because of the strict timing issues involved under this speed.



Installing DIMM Memory

Insert the DIMM module(s) as shown. Because the number of pins are different on each side of the breaks, the module will be fitted only in the orientation shown.

The DIMM must be 3.3V Unbuffered for this motherboard.

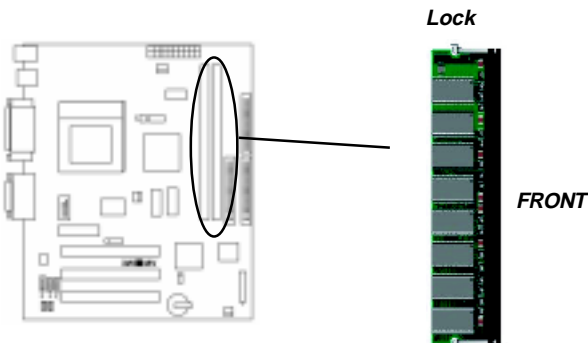

2.5 Central Processing Unit (CPU)

The Motherboard provides a ZIF Socket 370. The CPU that came with the motherboard should have a fan attached to it to prevent overheating. If this is not the case, then purchase a fan before you turn on your system. Be sure that there is sufficient air circulation across the processor's heat sink, or the processor could overheat and damage both the processor and the motherboard.

To install a CPU, first turn off your system and remove its cover. Locate the ZIF socket and open it by first pulling the lever sideways away from the socket then upwards to a 90-degree angle. Insert the CPU with the correct orientation as shown. The notched corner should point towards the end of the lever. Because the CPU has a corner pin for two of the four corners, the CPU will only be fitted in the orientation as shown. The picture is for reference only: you should have a CPU fan that covers the top side of the CPU. With the added weight of the CPU fan, no force is required to insert the CPU. Once completely inserted, close the socket's lever while holding down the CPU.

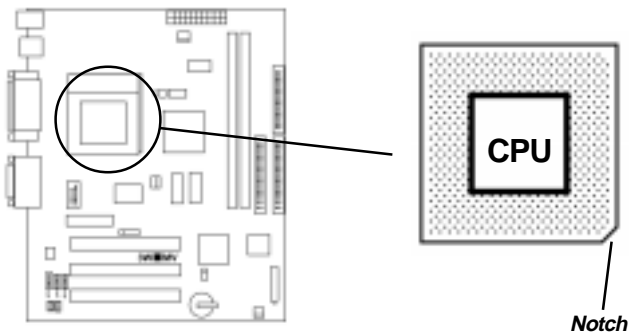

2.6 Expansion Cards

Always unplug the power supply when adding or removing expansion cards or other system components. Failure to do so may cause severe damage to both your motherboard and expansion cards.



Expansion Card Installation Procedure

The Motherboard has 3 PCI and 1 AMR expansion slots. You may install up to 3 PCI cards and 1 AMR card on this motherboard. To install the PCI cards or AMR card, please follow the following procedure:

1. Read the documentation for your expansion card and make any necessary hardware or software settings for your expansion card, such as jumpers or switches.
2. Remove your computer system's cover and the bracket plate with screw on the slot you intend to use. Keep the bracket for possible future use.
3. Carefully align the card's connectors and press firmly.
4. Secure the card on the slot with the screw you removed above.
5. Replace the computer system's cover.
6. Setup the BIOS if necessary.
7. Install the necessary software drivers for your expansion card.

Note: To install the AMR Card. You should set the "AC97 Modem" as "Auto" in the "INTEGRATED PERIPHERALS" of the BIOS Setup.

2.7 External Connectors

1. PS/2 Mouse Connector:

The motherboard provides a mini-DIN mouse connector, which supports a PS/2 style mouse.

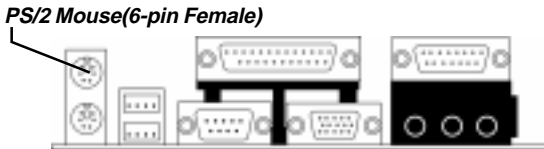

2. PS/2 Keyboard Connector:

This connector is for a standard keyboard using a PS/2 plug (mini DIN). This connector will not allow standard AT (large DIN) keyboard plugs. You may use a DIN to mini DIN adapter on standard AT keyboards. In some applications, the keyboard is not present, the standard BIOS will report an error or failure during the Power-On Self Test (POST) after resetting the PC. You may select “All, But Keyboard” under the “Halt On” in “Standard CMOS SETUP” of BIOS SETUP. This allows the system non-keyboard operation without the system halting during the POST.

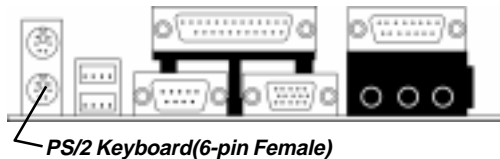

3. Universal Serial BUS (USB) Ports 1 & 2:

There are two USB ports on this motherboard for connecting USB devices.

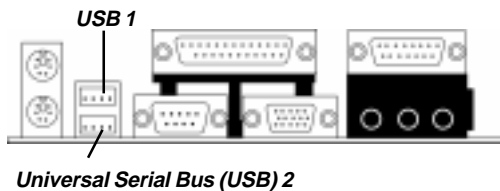

4. **Parallel Port Connector:**

Normally, the parallel port is used to connect the system to a printer.

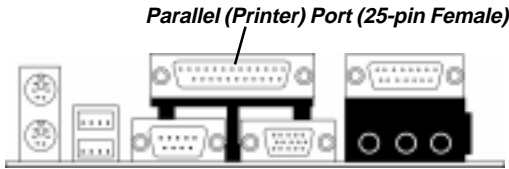

5. **Serial Port COM1 connector**

The COM1 port is ready for a mouse or other serial devices. A second serial port is available using a serial port bracket connected from the motherboard to an expansion slot opening.

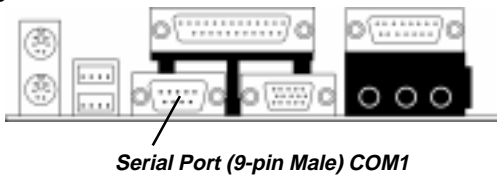

6. **Display connector**

This connector is for output to a VGA-compatible device, commonly used for conventional CRT displays.

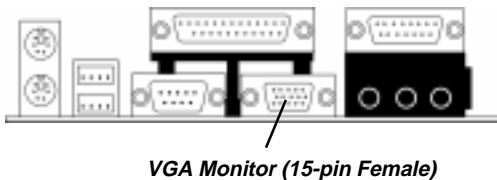

7. **Joystick/MIDI connector**

You may connect game joysticks or game pads to this connector for playing games. Connect MIDI devices for playing or editing audio.

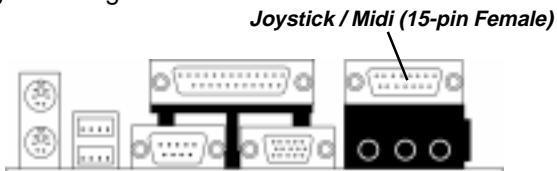

8. Audio Port connectors

The Audio Port Connectors on the motherboard are standard 1/8" GAME-AUDIO connectors.

Line Out (lime) can be connected to headphones or **POWERED** speakers. Line In (light blue) allows tape players or other audio sources to be recorded by your computer or played through the Line Out (lime). Mic (pink) allows microphones to be connected for inputting voice.

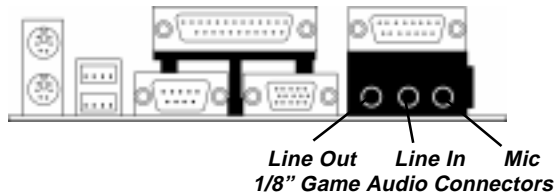

9. Primary/Secondary IDE Connectors

The motherboard supports up to four IDE devices, including CD-ROM drives, tape backup drives, Hard Disk Drives, and other IDE devices. After connecting the single end to the board, connect the two plugs at the other end to your hard disk(s). If you install two hard disks, you must configure the second drive to Slave mode by setting its jumper accordingly. Please refer to your hard disk documentation for the jumper settings. (Pin 20 is removed to prevent the users inserting the IDE devices in the wrong orientation when using ribbon cables with pin 20 plugged).

Note: Ultra DMA/66 IDE devices must use an 80-wire IDE cable or else devices will automatically be limited to Ultra DMA/33 mode.

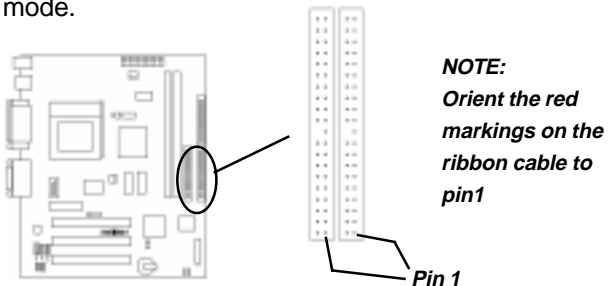

10. Floppy Disk Drive Connector

You can attach up to two floppy drives to the motherboard. After connecting the single end to the board, connect the two plugs on the other end to the floppy drives. The drive A: should be connected on the end and the drive B: in the middle.

Note: Pin 5 is removed to prevent the users inserting the Floppy Disk Drive in the wrong orientation when using ribbon cables with pin 5 plugged.

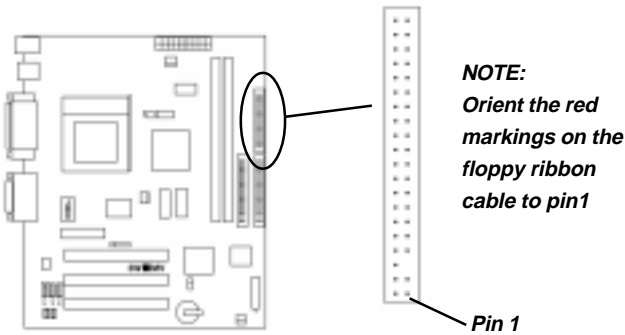

11. Wake-On-LAN(WOL)/Wake-On-Modem(WOM) connectors

The Wake-On-LAN and Wake-On-Modem connectors connect to a LAN card and Modem card respectively with a Wake-On-LAN/Wake-On-Modem output. The connectors power up the system when a wakeup packet or signal is received through the LAN card/Modem card.

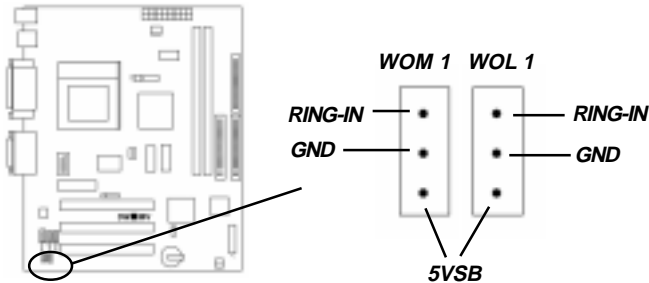

12. Serial Port COM2 Pin Header

The provided serial port bracket can be used to add an additional serial port for additional serial devices.

Note: Pin 10 is removed to prevent the users inserting in the wrong orientation when using ribbon cables with pin 10 plugged.

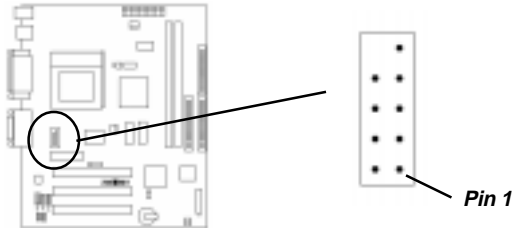

13. CPU/Power/Chassis Fan Connectors

This motherboard provides CPU, Power, and Chassis fan connectors. Orientate the fan so that the heat sink fins allow airflow to go across the onboard heat sink(s) instead of the expansion slots. Depending on the fan manufacturer, the wiring and plug may be different. The red wire should be positive, while the black should be ground. Connect the fan's plug to the board taking into consideration the polarity of the connector.

Note: The CPU and motherboard will overheat if there is no airflow across the CPU and onboard heatsinks. Damage may occur to the motherboard and the CPU fan if these pins are incorrectly used. These are not jumpers, do not place jumper caps over these pins.

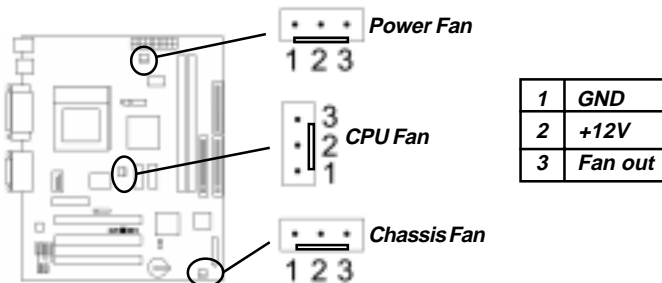

Refer to the following figure for item 14 to 18.

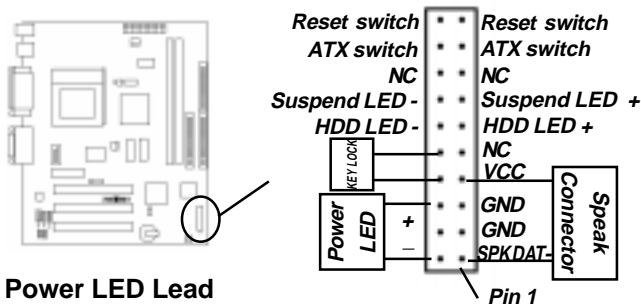

14. Power LED Lead

This indicates the status of the system power is turned “ON” or “OFF”. The LED will light when the system power is turned on and will go off when the system power is turned off.

2

15. System Warning Speaker Connector

This 4-pin connector connects to the case-mounted speaker.

16. ATX Power Switch Lead

The system power is controlled by a momentary switch connected to this lead. Pressing the button once will switch the system between ON and SOFT OFF. Pushing the switch while in the ON mode for more than 4 seconds will turn the system off. The Power LED shows the status of the system’s power.

17. HDD LED Lead

This connector supplies power to the cabinet’s IDE activity LED. Read and write activity by devices connected to the Primary or Secondary IDE connectors will cause the LED to light up.

18. Reset Switch Lead

This 2-pin connector connects to the case-mounted reset switch for rebooting your computer without having to turn off

your power switch. This is a preferred method of rebooting to extend the life of the system's power supply.

19. Internal Audio Connectors

These connectors allow you to receive stereo audio input from the sound sources such as CD-ROM, TV tuner, and MPEG card.

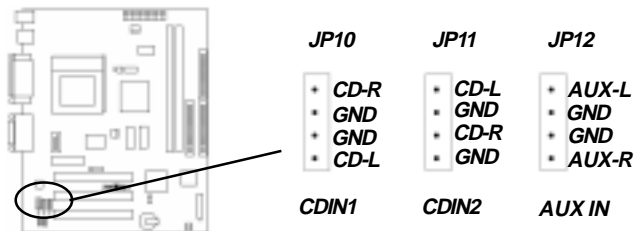

20. ATX Power Connector

This connector connects to an ATX power supply. The plug from the power supply will only insert in one orientation because of the different hole sizes. Find the proper orientation and push down firmly making sure that the pins are aligned.

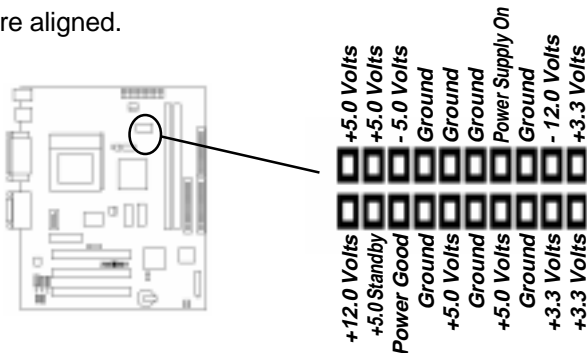

2.8 Power Connection Procedures

- After all connections are made, close the system case cover.
- Be sure that all switches are OFF.
- Connect the power supply cord to the power supply located

on the back of your system case according to your system user's manual.

- Connect the power cord to a power outlet that is equipped with a surge protector.
- You may then turn ON your devices in the following order:
 - (1) Your monitor
 - (2) External SCSI devices (starting with the last device on the chain)
 - (3) Your system power

For ATX power supplies, you need to switch ON the power supply if a switch is provided as well as press the ATX power switch on the front of the case.

2

- The power LED on the front panel of the system case will light. For ATX power supplies, the power LED will light when the ATX power switch is pressed. The system will then run power-On tests. While the tests are running, additional messages will appear on the screen. If you do not see anything within 30 seconds from the time you turn on the power, the system may have failed a power-on test. Check your jumper settings and connections again or call your retailer for assistance.

- During power-ON, hold down <Delete> to enter BIOS setup. Follow the instructions in chapter 3 BIOS Setup

- To power off your computer, you must first exit or shut down your operating system before switching OFF the power switch. For ATX power supplies, you can press the ATX power switch after exiting or shutting down your operating system. If you use Windows 95/98, click the start button, click shut down, and then click Shut down the computer. The power supply should turn OFF after Windows shuts down. For ATX power supplies, the message "You can now safely turn OFF your computer" will not appear when shutting down the computer.

Chapter

3

AWARD BIOS Setup

This chapter explains how to configure the motherboard's BIOS setup program.

After you have configured the motherboard, and have assembled the components, you can turn on the completed system. At this point, run the software setup to ensure that the system information is correct.

The software setup of the system board is achieved through Basic Input-Output System (BIOS) programming. You use the BIOS setup program to tell the operating system what types of devices are connected to your system board.

The system setup is also called CMOS setup. Normally, you need to run system setup if either the hardware is not identical with information contained in the CMOS RAM, or if the CMOS RAM has lost power.

3-1 Award BIOS Setup

Enter the Award Setup program's Main Menu as follows:

- Turn on or reboot the system. The following message appears at the bottom of the screen:
“Press to enter setup, ESC to skip memory test”
- Press the key to enter the Award BIOS setup program and the following screen appears:
- Choose an option and press <Enter>. Modify the system parameters to reflect the options installed in the system. (See the following sections for more information.)

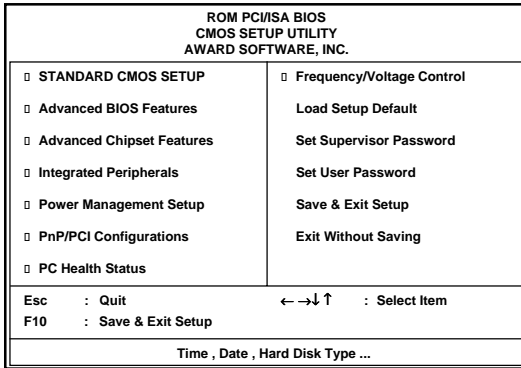

3

- Press <ESC> at anytime to return to the Main Menu.
- In the Main Menu, choose "SAVE AND EXIT SETUP" or <F10> to save your changes and reboot the system. Choosing "EXIT WITHOUT SAVING" or <ESC> ignores your changes and exits the program.

3-2 Main Menu Options

The Main Menu options of the Award BIOS are as below.

■ STANDARD CMOS SETUP

Run the Standard CMOS Set up as follows.

ROM PCI/ISA BIOS STANDARD CMOS SETUP AWARD SOFTWARE, INC.		
Date (mm:dd:yy)	Tue, May 20 1999	Item Help <input type="checkbox"/>
Time (hh:mm:ss)	14 : 59 : 44	Menu Level
<input type="checkbox"/> IDE Primary Master	Press Enter 6800 MB	Change the day, month, year and century
<input type="checkbox"/> IDE Primary Slave	Press Enter None	
<input type="checkbox"/> IDE Secondary Master	Press Enter None	
<input type="checkbox"/> IDE Secondary Slave:	Press Enter None	
Drive A	1.44M, 3.5 in	
Drive B	None	
Video	EGA/VGA	
Halt On	All, But Keyboard	
Base Memory	640K	
Extended Memory	97280K	
Total Memory	98304K	

↑↓ →← : Move Enter : Select +/-/PU/PD/: Value F10 : Save ESC : Exit F1 : General Help
F5 : Previous Values F6 : Fail-Safe Defaults F7 : Optimized Defaults

1. Choose “STANDARD CMOS SETUP” from the Main Menu and a screen with a list of items appears.

2. Use the arrow keys to move between items and to select values. Modify the selected fields using the PgUp/PgDn/+/- keys. Some fields let you enter numeric values directly.

Date (mm/dd/yy) Type the current date

Time (hh:mm:ss) Type the current time

IDE Primary/Secondary Master/Slave

IDE Primary Master
IDE HDD Auto-Detection
IDE Primary Master
Capacity
Access Mode
Cylinder
Head
Precomp
LandingZone
Sector

(1) If your system has an IDE hard drive, you can use this utility to detect its parameters and automatically enter them into

the Standard CMOS Setup.

- (2) For IDE hard disk driver, the BIOS provide three modes to support both normal IDE hard disk and also drives large than 528MB, a short description of three modes as follows:
- a. **Normal mode:** For drives small than 528MB
 - b. **Large Mode:** For drives larger than 528MB that do not use LBA. There can only be used with MS-Dos operating system.
 - c. **LBA mode:** For drives larger than 528MB and up to 8.4GB that use logic block addressing mode. Normally we recommend to select LBA Mode if your HDD drivers large than 528MB.

3

Select auto to detect the mode type automatically.

Capacity : The hard disk size. The unit is Mega Bytes.

Access Mode : Select "auto" to detect the mode type automatically. If your hard disk supports the LBA mode, select LBA or Large. However, if your hard disk cylinder is more than 1024 and does not support the LBA function, set at Large. Select Normal if your hard disk supporting cylinders is below 1024.

Cylinder : The Cylinder number of the hard disk.

Head : The read/write head number of hard disk.

Precomp : The cylinder number at which the disk drive changes the write timing.

Landing Zone : Landing zone.

Sector : Number of sectors

Note :

You can select Auto under the TYPE and MODE fields. This will enable auto detection of your IDE drives during bootup.

Drive A & B

Choose 360KB, 5.25 in 1.2MB, 5.25 in

720KB, 3.5 in	1.44MB, 3.5in
None	2.88MB, 3.5in

Video

Choose	Mono	CGA40
	EGA/VGA	CGA80

Halt On

The items determines whether the computer will stop if an error is detected during power up.

Choose	All Errors (Default)	No Errors
	All, But Keyboard	All, But Diskette
	All, But Disk/Key	

3. After you have finished with the Standard CMOS Setup program, press the <ESC> key to return to the Main Menu.

■ ADVANCED BIOS FEATURES

Run the BIOS Features Setup as follows.

1. Choose “ADVANCED BIOS FEATURES ” from the Main Menu and a screen with a list of items appears.

ROM PCI/ISA BIOS ADVANCED BIOS FEATURES AWARD SOFTWARE, INC.		
		Item Help
Virus Warning	Disabled	
CPU Internal Cache	Enabled	Menu Level □
External Cache	Enabled	Allows you to choose the VIRUS warning
CPU L2 Cache ECC Checking	Enabled	feature for IDE Hard
Quick Power On Self Test	Enabled	Disk boot sector
First Boot Device	Floppy	protection. If this
Second Boot Device	HDD-0	function is enabled
Third Boot Device	LS/ZIP	and someone attempt to
Boot Other Device	Enabled	write data into this
Swap Floppy Drive	Disabled	area, BIOS will show a
Boot Up Floppy Seek	Disabled	warning message on
Boot Up NumLock Status	On	screen and alarm beep
Typematic Rate Setting	Disabled	
Typematic Rate (Chars/Sec)	6	
Typematic Delay (Msec)	250	
Security Option	Setup	
OS Select for DRAM >64MB	Non-OS2	
Report no FDD for Win95	No	

↑↓←→ : Move Enter : Select ←-PU/PD/-Value F10 : Save ESC : Exit F1 : General

Help F5 : Previous Values F6 : Fail-Safe Defaults F7 : Optimized Defaults

Virus Warning

Choose Enabled or Disabled. Enable this option and a SYSTEM WARNING MESSAGE appears when the system detects a virus.

CPU Internal Cache

Choose Enabled or Disabled. This option lets you enable the CPU's internal cache memory.

External Cache

Choose Enabled or Disabled. This option lets you enable the external cache memory. For better performance, make sure you always choose "Enabled."

CPU L2 Cache ECC Checking

The defaults of item to check CPU L2 cache ECC function.

Enabled : ECC

Disabled : Non-ECC

3

Quick Power On Self Test

Choose Enabled or Disabled. Enabled provides a fast POST (Power On Self Test) and boot-up speed.

Swap Floppy Driver

Choose Enabled or Disabled. When Enabled Floppy drives A & B are swapped under DOS.

Boot Up Floppy Seek

Choose Enabled or Disabled. Enabled puts BIOS searches for floppy disk drive to determine it is 40 or 80 tracks(360K type is 40 tracks, 720K/1.2M/1.44M are all 80 tracks.)

Disabled provides a fast boot and reduces the possibility of damage to the heads.

Boot Up Num Lock Status

Choose On or Off. On puts numeric keypad in Num Lock mode at boot-up. Off puts this keypad in arrow key mode at boot-up.

Typematic Rate Setting

This determines the typematic rate.

Enabled : Enable typematic rate and typematic delay programming.

Disabled: Disable typematic rate and typematic delay programming. The system BIOS will use default value of these 2 items and the default is controlled by

keyboard.

Typematic Rate(Chars/Sec)

Choose the rate a character keeps repeating(6-30 Chars/Sec).

Typematic Delay (Msec)

Choose how long after you press a key that a character begins repeating. (250-1000)

Security Option

Choose Setup, or System. Use this feature to prevent unauthorized system boot-up or unauthorized use of BIOS Setup.

“System” - Each time the system boots the password prompt appears.

“Setup” - Password prompt only appears if you attempt to enter the Setup program.

OS/2 Select for DRAM >64M

When using OS/2 operating systems with installed DRAM of greater than 64MB, you need to set this option to Enabled otherwise leave this on Disabled.

2.After you have finished with the BIOS Features Setup program, press the <ESC> key and then follow screen instructions to save or disregard your settings.

■ ADVANCED CHIPSET FEATURES

ROM PCI/ISA BIOS ADVANCED CHIPSET FEATURES AWARD SOFTWARE, INC.		
SDRAM CAS Latency Time	3	Item Help
System BIOS Cacheable	Disabled	Menu Level ▾
Video BIOS Cacheable	Disabled	
Memory Hole At 15M-16M	Disabled	
On-Chip Video Window Size	64MB	
* Onboard Display Cache Setting*		
Initial Display Cache	Enabled	
CAS# Latency	3	

↑↓ →← : Move Enter : Select ←/PU/PD/: Value F10 : Save ESC : Exit F1 : General
 Help F5 : Previous Values F6 : Fail-Safe Defaults F7 : Optimized Defaults

The “ADVANCED CHIPSET FEATURES” is used to control the values of the chipset registers. These registers control most of the

system options in the computer.

Run the Chipset Features Setup as follows:

1. Choose “ADVANCED CHIPSET FEATURES” from the Main Menu and a screen with a list of items appears.

SDRAM CAS Latency Time

The SDRAM Timing type : 2, 3 (Default)

System BIOS Cacheable

When enabled, access to the system BIOS ROM addressed at F0000H-FFFFFFH are cached, provided that the cache controller is enabled.

3

Video BIOS Cacheable

Select enabled allows caching of the video RAM, resulting in better system performance. However, if any program writes to this memory area, system error may result.

Enabled : Video RAM access cached.

Disabled : Video RAM access not cached.

Memory Hole at 15M-16M

In order to improve performance, certain space in memory can be reserved for ISA cards. This field allows you to reserve 15MB to 16MB memory address space to ISA expansion cards. This makes memory from 15MB and up unavailable to the system. Expansion cards can only access memory up to 16MB. By default, this field is set to Disabled.

On-Chip Video Window Size

The on-chip Video window Size register allows the selection of an aperture size of 32MB, 64MB and None.

2. The items are optimal setting for this motherboard, you should not change them unless you are familiar with the chipset.

■ INTEGRATED PERIPHERALS

ROM PCI/ISA BIOS Integrated Peripherals AWARD SOFTWARE, INC.		
		Item Help
On-Chip Primary PCI IDE	Enabled	Menu Level ▾
On-Chip Secondary PCI IDE	Enabled	
IDE Primary Master PIO	Auto	
IDE Primary Slave PIO	Auto	
IDE Secondary Master PIO	Auto	
IDE Secondary Slave PIO	Auto	
IDE Primary Master UDMA	Auto	
IDE Primary Slave UDMA	Auto	
IDE Secondary Master UDMA	Auto	
IDE Secondary Slave UDMA	Auto	
USB Controller	Enabled	
USB Keyboard Support	Disabled	
Init Display First	Onboard	
AC97 Audio	Enabled	
AC97 Modem	Disabled	
Onboard Audio Device	Enabled	
IDE HDD Block Mode	Enabled	
POWER ON Function	BUTTON ONLY	
KB Power ON Password	Enter	
Hot Key Power ON	Ctrl-F1	
Onboard FDC Controller	Enabled	
Onboard Serial Port 1	3F8/IRQ4	
Onboard Serial Port 2	2F8/IRQ3	
UART Mode Select	Normal	
RxD, TxD Active	Hi, Lo	
IR Transmission delay	Enabled	
Onboard Parallel Port	378/IRQ7	
Parallel Port Mode	SPP	
EPP Mode Select	EPP1.7	
ECP Mode Use DMA	3	
PWRON After PWR-Fail	Off	
Game Port Address	201	
Midi Port Address	330	
Midi Port IRQ	5	

↑↓ ←→ : Move Enter : Select +/-/PU/PD/:Value F10 : Save ESC : Exit F1 : General

Help F5 : Previous Values F6 : Fail-Safe Defaults F7 : Optimized Defaults

The “INTEGRATED PERIPHERALS” is used to control the values of the I/O chipset registers. These registers control the mode of HDD type and I/O address port.

Run the Integrated Peripherals as follows:

1. Choose “INTEGRATED PERIPHERALS” from the Main Menu

and a screen with a list of items appears.

Note:

If you don't use the Onboard IDE connector, than use On-card (PCI or ISA card) IDE connector, you will set Onboard Primary PCI IDE : Disabled and Onboard Secondary PCI IDE : Disabled from CHIPSETFEATURES SETUP UTILITY.

The Onboard PCI IDE cable should be equal to or less than 18 inches (45cm).

On-Chip Primary PCI IDE/On-Chip Secondary PCI IDE

The chipset contains a PCI IDE interface with support for two IDE channels. Select disabled to deactivate an interface. If you install a primary and/or secondary add-in IDE interface.

3

IDE Primary Master PIO /IDE Primary Slave PIO

The default value is Auto.

Auto : BIOS will automatically detect the Onboard PCI IDE HDD Accessing mode.

Mode0-4 : Manually set the IDE Accessing mode.

IDE Primary Master UDMA/IDE Primary Slave UDMA

Allows you to select the first/second PCI IDE channel of the first/second master hard disk mode or to detect it by the BIOS if the hard disk supports UDMA (Ultra DMA, faster than DMA).

USB Controller

The default is set to disabled until support disks and Universal Serial Bus (USB) devices are available in which time you can set this function to enabled.

USB Keyboard Support

Enable : USB keyboard. Disable : AT keyboard.

AC97 Modem

Auto:Supports AMR Card

Disable:Does not Support AMR Card

IDE HDD Block Mode

The default value is Enabled.

Enabled : Enabled IDE HDD Block Mode. The HDD transfer rate is better than Disable.

Disabled :Disable IDE HDD Block Mode.

Power On Function

Choose the item and a screen with a list of items appears.

POWER ON Function
Password
Hot KEY
Mouse Left
Mouse Right
Any Key
Button only
Keyboard 98

Onboard FDC Controller

Choose disabled when you use an ISA card with FDD function, or choose enabled to use the onboard FDD connector.

Onboard Serial Port 1/2

Auto : The BIOS will automatically setup the port1/2 address

3F8/IRQ4 : Enable onboard serial port 1/2 and address is 3F8.

2F8/IRQ3 : Enable onboard serial port 1/2 and address is 2F8.

3E8/IRQ4 : Enable onboard serial port 1/2 and address is 3E8.

2E8/IRQ3 : Enable onboard serial port 1/2 and address is 2E8.

Onboard Parallel Port

Select from a given set of parameters if the parallel port uses the onboard I/O controller.

The options are : 278/IRQ5 , 3BC/IRQ7 , 378/IRQ7(Default).

Parallel Port Mode

Allows you to connect with an advanced printer. Select SPP for standard parallel port (SPP) used on IBM PC/XT, PC/AT and bi-directional parallel port found on PS/2 system.

POWER MANAGEMENT SETUP

3

ROM PCI/ISA BIOS POWER MANAGEMENT SETUP AWARD SOFTWARE, INC.		
		Item Help
ACPI Function	Enabled	
ACPI Suspend Type	S3 (STR)	Menu Level ▾
Power Management	User Define	
Video Off Method	DPMS	
Suspend Type	PwrOn Suspend	
MODEM Use IRQ	3	
Suspend Mode	Disable	
HDD Power Down	Disable	
Soft-Off by PWR-BTTN	Instant-Off	
Wake Up by PCI card	Disable	
CPU Thermal-Throttling	62.5%	
Resume by Alarm	Disable	
Date (of Month) Alarm	0	
Time (hh:mm:ss)	0 0 0	
** Reload Global Timer Events**		
Primary IDE 0	Disable	
Primary IDE 1	Disable	
Secondary IDE 0	Disable	
Secondary IDE 1	Disable	
FDD, COM, LPT Port	Disable	
PCI PIRQ [A-D]	Disable	
Power On by Ring	Enabled	

↑↓ →← : Move Enter : Select +/-/PU/PD : Value F10 : Save ESC : Exit F1 : General
 Help F5 : Previous Values F6 : Fail-Safe Defaults F7 : Optimized Defaults

The Power Management controls the motherboard’s “green” features that for the power saving Mode, Display turn off and HDD power down that together form the hardware power conservation scheme.

Run the Power Management Setup as follows:

1. Choose “POWER MANAGEMENT SETUP” from the Main Menu and a screen with a list of items appears.
2. A short description of the screen items follows:

"POWER MANAGEMENT" is the master control for the four power saving modes, doze, standby, suspend mode and HDD power down mode..

ACPI function

This item allows you to enable/disable the Advanced Configuration and Power Management(ACPI).

The choice:Enabled,Disabled.

Power Management :

Disabled : The system operates in NORMAL conditions (Non-GREEN), and the Power Management function is disabled.

Max.saving : This mode will maximize the power saving capability.

Min.saving : This mode will minimize the power saving capability.

User define : Allow user to define time out parameters to control power saving timing.

Video Off Method

The option "V/H SYNC+Blank" allows the BIOS to blank off screen display by turning off the V-Sync signals sent from add-on VGA card. "DPMS Supported" allows the BIOS to blank off screen display by your add-on VGA card which supports DPMS (Display Power Management Signaling Function.) "Blank Screen" allows the BIOS to blank screen display by turning off the red-green-blue signals.

MODEM use IRQ

When the system is in green function, modem wakes up the system through IRQ.

Suspend Mode

When disabled, the system will not enter Suspend mode. The specified time option defines the idle time the system takes before it enters Suspend mode.

HDD Power Down

Selecting Disabled "will turn off the hard disk drive (HDD) motor. Selecting "1 Min..15Min" allows you to define the HDD idle time before the HDD enters Power Saving Mode. The option "When Suspend" lets the BIOS turns the HDD motor off when the system is in Suspend mode.

The options "1Min..15Min" and "When Suspend" will not work concurrently. When HDD is in Power Saving Mode, any access to the HDD will wake the HDD up.

Soft-Off by PWR-BTTN

When enabled, turning the system off with the on/off button places the system in a very low-power-usage state, with only enough circuitry receiving power to detect power button activity or Resume by Ring activity.

Resume by Alarm

Set alarm to wake up the system by the date or time.

Enabled : Wake up by the alarm

Disabled :(default) The system ignores the alarm.

Power On by Ring

The system will resume active when the modem is ringing.

Enabled : Wake up the system from ring signal.

Disabled : (default) Ring signal can not wake up the system.

PNP/PCI CONFIGURATION

ROM PCI/ISA BIOS PnP/PCI Configurations AWARD SOFTWARE, INC.		
Reset Configuration Data	Disabled	Item Help
Resources Controlled By	Auto (ESCD)	Menu Level ▾
IRQ Resource	Press Enter	
Memory Resources	Press Enter	Default is Disabled. Select Enabled to Reset Extended System Configuration Data ESCD) when you exit Setup if you have installed a new add-on and the system reconfiguration has caused such a serious conflict that the OS cannot boot
PCI/VGA Palette Snoop	Disabled	

↑↓ →← : Move Enter : Select +/-PU/PD/ : Value F10 : Save ESC : Exit F1 : General

Help F5 : Previous Values F6 : Fail-Safe Defaults F7: Optimized Defaults

The “PNP/PCI CONFIGURATION” sets the system for use with PCI bus cards.

Run the PNP/PCI Configuration program as follows.

Choose “PNP/PCI CONFIGURATION” from the Main Menu and a screen with a list of items appears.

PC Health Status

ROM PCI/ISA BIOS PC Health Status AWARD SOFTWARE, INC.		
CPU Warning Temperature	Disabled	Item Help
Current System Temp.	39°C/102°F	Menu Level ▾
Current CPU Temperature	42°C/107°F	
Current CPUFAN1 Speed	0 RPM	
Current CPUFAN2 Speed	0 RPM	
Current CPUFAN3 Speed	0 RPM	
CPU (V)	2.09 V	
VGA(V)	1.84 V	
+3V	3.37 V	
+ 5V	5.05 V	
+12V	12.16 V	
-12V -	12.52 V	
-5V -	5.09 V	
Shoudown Temperature	60°C/140°F	

↑↓ →← : Move Enter : Select +/-PU/PD/ : Value F10 : Save ESC : Exit F1 : General

Help F5 : Previous Values F6 : Fail-Safe Defaults F7: Optimized Defaults

The “PC Health Status” provides fan rotations, Voltages, and temperatures of the system

Choose “PC Health Status” from the Main Menu and a screen with a list of items appears.

CPU Warning Temperature

When CPU temperature is over the setting value, the speaker will sound an alarm and the clock will drop until the temperature is within the temperature range.

Current CPU Temperature

Detect CPU temperature automatically.

3

Frequency/Voltage Control

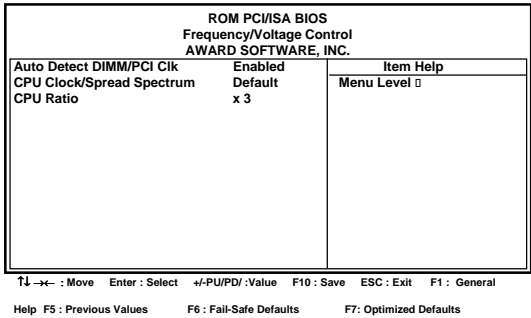

The “Frequency/Voltage Control” provides CPU clock, ratio.

Choose “Frequency/Voltage Control” from the Main Menu and a screen with a list of items appears.

CPU Clock/Spread Spectrum

This item lets you set external clock (bus clock). The possible settings are 66MHZ, 75MHZ and 83 MHZ....

CPU Ratio

This item lets you select the ratio of Core/Bus frequency. Have the following selection: 3x, 3.5x, 4x, 4.5x, 5x, 5.5x, 6x ..x8

■ LOAD SETUP DEFAULTS

This Main Menu item loads the default system values. These settings are recommended for optimum performance. If the CMOS is corrupted when enter BIOS setup utility you must load setup default again. Choose this item and the following message appears:

"Load SETUP Defaults (Y/N)? Y"

To use the Setup defaults, press "Y" and press <Enter>.

■ SET USER PASSWORD SETTING

This Main Menu item lets you configure the system so that a password is required every time the system boots or an attempt is made to enter the Setup program. The password can not be longer than 8 characters.

If CMOS is corrupted or the option was not used, a default pass word stored in the ROM will be used. The screen will display the following message:

Enter Password :

■ SAVE & EXIT SETUP

After you have made changes under Setup, press "Esc" to return to the main menu. Move cursor to "Save and Exit Setup" or press "F10" and then press "Y" to change the CMOS Setup. If you did not change anything, press "Esc" again or move cursor to Exit Without Saving and press "Y" to retain the Setup settings. The following message will appear at the center of the screen to allow you to save data to CMOS and exit the setup utility.

Save to CMOS and EXIT (Y/N)?

3

Chapter 4 Software

Installation

The CD provided in the package has installed InstallShield software inside. To install the utility and drivers from the CD, you just need to insert the CD into the CD-ROM drive. The computer will then show you the options and instructions to install the drivers/utility automatically. Follow the instructions, the InstallShield will help you to install the drivers/utility very easily.

However, if you need to install the drivers/utility manually, please read this chapter carefully.

4-1 Intel INF Utility Installation (810drv\infinst_autol\setup.exe)

- Enter My Computer\CD-ROM Drive icon\810drv\infinst_autol, double click "Setup"
- You will be prompted to the license agreement.
If you do not agree, the Installation program will be terminated without installing any Utility/drivers.
If you agree, select "YES", then you will be prompted to the "Readme information".
- In the "Readme information" click "next" button, the "setup complete" screen will appear. Select "Yes, I want to restart

my computer now” and click “finish” button to restart the computer. The INF installation is now complete.

4-2 VGA driver installation

Windows 95/98 VGA driver installation (810drv\VGA\win9xcd\graphics\setup.exe)

1. Enter My Computer\CD-ROM Drive icon\810drv\win9xcd\graphics and double-click “SETUP”
2. Click “Next” at the Welcome screen.
3. Read the license agreement and click “Yes” to continue
4. This screen indicates the directory where the End User Diagnostic Utility files will be stored. NOTE: the graphics driver is not installed here (it is installed in the appropriate Windows system directories), just the EUD utility files. If you wish to change the directory where the EUD will be stored, click “Browse” and change the directory. Click “Next” to continue.
5. The driver files will be installed. When finished installing, choose the “Yes, I want to restart my computer now” option and click “finish” button to restart your computer. The driver should now be loaded.

Windows NT4.0 VGA driver installation (810drv\VGA\WinNT4cd\graphics\setup.exe)

1. Select “My Computer” icon, “Control Panel” icon, and then

the “Display” icon.

2. You should now be in the “Display Properties” window. Select the “Settings” tab, and click on the “Display Type” button.

3. In the Display Type window, click the “Change” button under Adapter Type. This will bring up the Change Display window.

4. In the Change Display window, click on the “Have Disk” button. The “Install From Disk” window will appear.

5. Click the “Browse” button, enter My Computer\CD-ROM Drive\810drv\winnt4cd\Graphics\winnt4\181xnt4 and click “OK”

6. Once the installation is complete, the system must be shut down and restarted.

Windows 2000 Driver Installation

(810drv\VGA\Win2kcd\Graphics\I81XNT5.INF)

The installation is the same as that of Windows NT 4.0.

4-3 Audio Driver Installation

Win95/98/98SE Audio Driver Installation

(Win95: Driver\Audio\Als300Plus\Win95vxdQ3d\setup.exe)

(Win98/98SE: Driver\Audio\Als300plus\Win98vxdQ3d\setup.exe)

Driver/Application Removal & Installation:

1. To remove an existing driver/application and install with the

latest driver/application, please enter

My Computer\CD-ROM Drive\ audio\alc100 and double click "Setup" icon.

2. In selecting a setup type, please choose "Remove and Install Software.." and click on [Next]. When asked with "Do you want to install the bundled application?" Select "Yes, I do." to install ALSRACK Player or "No, I don't." if not. Click on [Next] and the program will install both the driver and application automatically.

Note: If you have not installed the bundled application (ALSRACK Player) in step 2 and wish to install later, you can run SETUP.EXE again and select "Install Application Only.." By doing so, setup will install the bundled application into you computer system.

Enter Audio\alc100\win9x\readme.txt file in the provided CD for full description of ALSRACK functions.

Driver/Application Removal ONLY:

1. If you want to remove an existing driver/application ONLY, you may do so by enter My Computer\CD-ROM Drive\ audio\alc100 and double click "Setup" icon.

2. In selecting a setup type, please choose "Remove Software.." and click on [Next]. The program will remove all existing and associated driver files automatically.

Windows NT 4.0 Audio Driver Installation

(Driver\Audio\Als300Plus\WinNT4\Oemsetup.inf)

1. Insert the provided CD in the package into the CD-ROM drive
2. enter CONTROL PANEL/DRIVERS/ADD/UNLISTED OR UPDATED DRIVER, choose "OK".
3. While installing, "Driver Exists" warning message will appear and will ask to keep the old "midimap.cfg" or re-install. Please choose re-install, or else midi will not function properly.

■ **For Winnt4.0 installation procedure:**

1. Insert the provided CD in the package into the CD-ROM drive
2. enter CONTROL PANEL/MULTIMEDIA/DEVICE/ADD, choose "OK".
3. While installing, "Driver Exists" warning message will appear and will ask to keep the old or re-install. Please choose re-install, or else it will not function properly.

■ **For NT 3.51 user:**

It is normal that some controls will be disappeared or invalid in "Volume Control" because of the OS's limitation.

Troubleshooting:

If no sound or device does not function properly, please check CONTROL PANEL|SYSTEM|DEVICE MANAGER. The list of audio related devices appear under the category of "SOUND, VIDEO & Game Controller.." should include the followings:

Avance ALC100(XX) Audio Device

Note: If any of the above devices has a yellow exclamation mark

next to it or appear to be missing, please run SETUP.EXE again and choose "Removal and Install Software.." to insure the above devices are properly installed.

The driver does not support playing DOS game under real-mode DOS.

4

4-3 Audio Driver Installation

Put CD title driver into CD ROM, then choose "Anti-Virus software" on the main menu, follow each instruction on the screen as the followings.



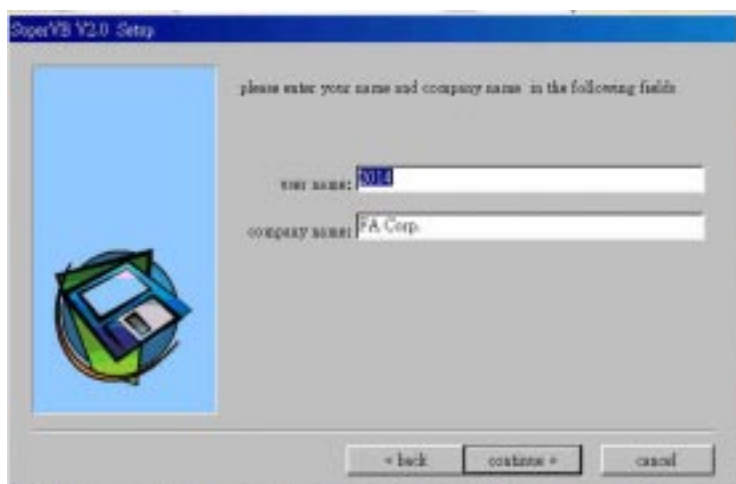
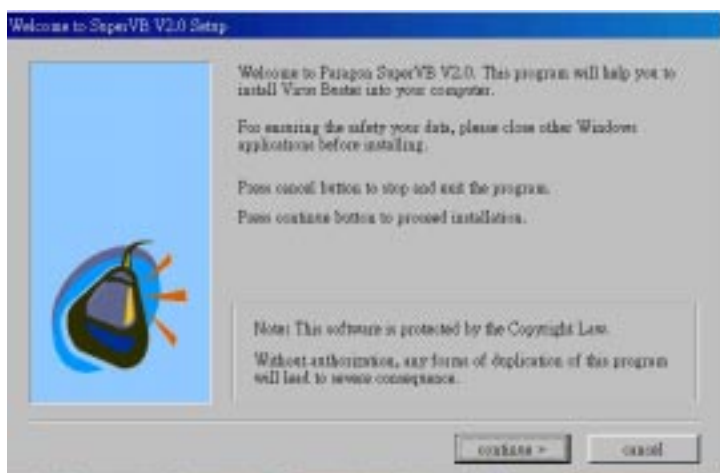

4

