

---

---

## **Copyright and Warranty Notice**

---

---

The information in this document is subject to change without notice and does not represent a commitment on part of the vendor, who assumes no liability or responsibility for any errors that may appear in this manual.

No warranty or representation, either expressed or implied, is made with respect to the quality, accuracy or fitness for any particular part of this document. In no event shall the manufacturer be liable for direct, indirect, special, incidental or consequential damages arising from any defect or error in this manual or product.

Product names appearing in this manual are for identification purpose only and trademarks and product names or brand names appearing in this document are property of their respective owners.

This document contains materials protected under International Copyright Laws. All rights reserved. No part of this manual may be reproduced, transmitted or transcribed without the expressed written permission of the manufacturer and authors of this manual.

If you do not properly set the motherboard settings causing the motherboard to malfunction or fail, we cannot guarantee any responsibility.

---

---



**This Page Is Intentionally Blank**



---

---

# WX6 Motherboard User's Manual

## Table of Contents

---

### CHAPTER 1. INTRODUCTION OF WX6 FEATURES

1-1. FEATURES OF THIS MOTHERBOARD	1-1
1-2. SPECIFICATIONS	1-5
1-3. LAYOUT DIAGRAM	1-9
1-4. THE SYSTEM BLOCK DIAGRAM	1-10

### CHAPTER 2. INSTALLING THE MOTHERBOARD

2-1. INSTALLING THE MOTHERBOARD TO THE CHASSIS	2-2
2-2. INSTALLATION OF THE CELERON™ PPGA PROCESSOR	2-3
2-3. INSTALLING SYSTEM MEMORY	2-4
2-4. CONNECTORS, HEADERS AND SWITCHES	2-6

### CHAPTER 3. INTRODUCTION OF THE BIOS

3-1. CPU SOFT MENU™ II	3-4
3-2. STANDARD CMOS FEATURES SETUP MENU	3-9
3-3. ADVANCED BIOS FEATURES SETUP MENU	3-14
3-4. ADVANCED CHIPSET FEATURES SETUP MENU	3-19
3-5. INTEGRATED PERIPHERALS	3-23
3-6. POWER MANAGEMENT SETUP MENU	3-29
3-7. PNP/PCI CONFIGURATIONS	3-37
3-8. PC HEALTH STATUS	3-40
3-9. LOAD FAIL-SAFE DEFAULTS	3-42
3-10. LOAD OPTIMIZED DEFAULTS	3-42
3-11. SET SUPERVISOR PASSWORD / SET USER PASSWORD	3-43
3-12. SAVE & EXIT SETUP	3-45
3-13. EXIT WITHOUT SAVING	3-46

### APPENDIX A IDE & USB DRIVERS INSTALLATION FOR WINDOWS® 98 SE

### APPENDIX B INSTALLING THE VGA DRIVER FOR WINDOWS® 98 SE

### APPENDIX C INSTALLING THE AUDIO DRIVER FOR WINDOWS® 98 SE

### APPENDIX D INSTALLING THE VGA DRIVERS FOR THE WINDOWS® NT 4.0 SERVER / WORKSTATION

---

**APPENDIX E INSTALLING THE AUDIO DRIVERS FOR THE WINDOWS® NT  
4.0 SERVER / WORKSTATION**

**APPENDIX F BIOS FLASHING USER INSTRUCTIONS**

**APPENDIX G INSTALLING THE HIGHPOINT XSTORE PRO UTILITY**

**APPENDIX H HARDWARE MONITORING FUNCTION (INSTALLING THE  
WINBOND HARDWARE DOCTOR UTILITY)**

**APPENDIX I INSTALLATION GUIDE FOR SUSPEND TO RAM**

**APPENDIX J TROUBLESHOOTING (NEED ASSISTANCE?)**

 TECHNICAL SUPPORT FORM

---

## Chapter 1. Introduction of WX6 Features

---

### 1-1.Features of This Motherboard

---

This motherboard is designed for Intel's new generation of Celeron™ processors. It supports the Intel® Celeron™ processor, with the PPGA (Plastic Pin Grid Array package) 370-pin design. Up to 256MB of memory (512MB using 128Mb technology), newer super I/O, and Green PC functions.

The WX6 has a built in 2D & 3D graphics engines, and the integrated 24-bit 230MHz RAMDAC can provide up to 1600\*1200 resolution in 8-bit color at an 85Hz refresh rate. The WX6 has 4MB SDRAM built in for graphic memory. The WX6 also has the Vortex® AU8808 PCI-Based AC'97 digital audio processor built in (Optional). The AU8808 offers a complete, professional-quality PC sound system that combines advanced wavetable and DirectSound features with legacy compatibility in real-mode DOS and DOS boxes. Employing Aureal's Vortex technology, the AU8808 combines AC'97 support with 300 MIPS of audio processing power in a single-chip. It can provide the high-quality sound with high SNR (Signal to Noise Ratio), of up to 120dB. It supports A3D interactive position sound, creates soundstreams that appear to be moving in the 3D space surrounding a listener using headphones or stereo speakers. The AU8808 uses a host-based A3D-I engine which is MMX-optimized to obtain higher processing efficiency than Microsoft's native DirectSound 3D, while providing superior sound quality.

Moving into the 21<sup>ST</sup> century, digital flat panel display (FPD) will be ubiquitous, linked to everyday electronic appliances from desktop computers to DVD players to set-top boxes. By the turn of this century, we'll either own a digital FPD monitor, or know someone that does. Inevitably, as prices drop far enough, large screen, all-digital TVs will be the display of choice to maximize the all-digital video viewing experience. But to make all this happen, the consumer electronics and PC industry must adopt a digital interface standard to link digital video/graphics sources to digital FPD. When the video is kept digital from source-to-FPD, the system is "all-digital".

For this all-digital trend, the WX6 can be equipped with the SiI 154 chipset (Optional). The SiI 154 uses PanelLink® Digital technology to support displays ranging from VGA (25MHz, 640\*480) to SXGA (112MHz, 1280\*1024) which are ideal for desktop and specialty applications. It supports VESA® P&D™ and DFP (Digital Flat Panel) Hot Plug Detection plus the RxDetect feature. The SiI 154 operates with all PanelLink® receivers and leads the way in promoting the digital display interface as a standard feature in all PCs by enabling all multimedia accelerators with a flexible 12 or 24-bit interface in a cost-effective package. Featuring a 12-bit dual-edge clock interface that supports resolutions up to SXGA, the SiI 154 is designed to work with feature-rich, high-end multimedia accelerators that typically

don't have enough pins available to support a 24-bit interface.

It's fully digital interface design to drive the Flat Panel Display (FPD), don't like analog interface, you can get best display quality than analog interface does. The figure 1-1 below shows difference between digital and analog interface display quality. You can see why we chosen this chipset.

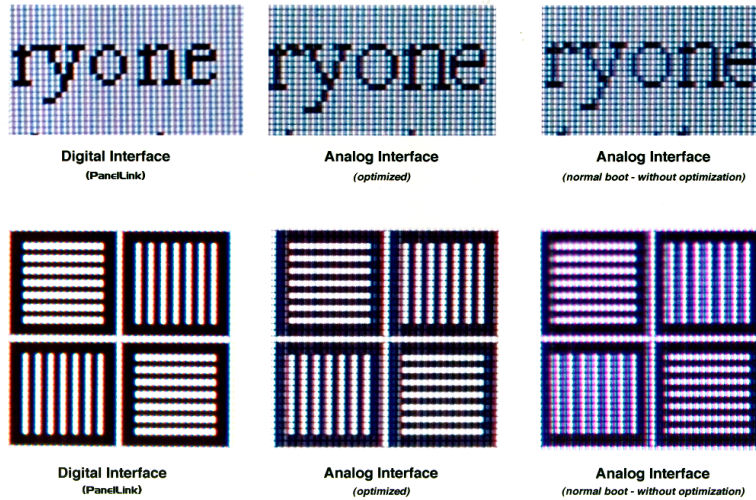

**Figure 1-1. Digital and analog interface display quality comparison**

The WX6 uses the new generation Intel® 810 chipset for more efficiency and high integration of the system. The WX6 will support Ultra ATA/66 IDE devices. Ultra ATA/66 is the new standard for IDE devices. It enhances existing Ultra ATA/33 technology by increasing both performance and data integrity. This new high-speed interface doubles the Ultra ATA/33 burst data transfer rate to 66.6 Mbytes/sec. The result is maximum disc performance using the current PCI local bus environment. You can connect either Ultra ATA/33 IDE devices or Ultra ATA/66 IDE devices to the IDE connectors on this motherboard. The motherboard has built-in hardware monitoring functions, that can monitor and protect your computer insuring a safe computing environment. The motherboard can provide high performance for workstations and meets the requirements for desktop systems for multimedia in the future.

What are the features of the Intel® 810 chipset? It's structure is shown in Figure 1-4. It is a combination of three chips: the FW82810, FW82801 and FW82802. The FW82810 is called the GMCH chip, **G**raphics and **M**emory **C**ontroller **H**ub. The GMCH functions and capabilities include:

---

**WX6**

- Support for a single Intel® Celeron™ processor configuration
- 64-bit GTL+ based system bus interface at 66MHz/100MHz
- 32-bit host address support
- 64-bit system memory interface with optimized support for SDRAM at 100MHz
- Integrated 2D & 3D graphics engines
- Integrated H/W motion compensation engine

The FW82801 is also called the ICH chipset, the **I/O Controller Hub**. The ICH is a highly integrated multifunctional component supporting the following functions and capabilities:

- PCI Rev. 2.2 compliant with support for 33MHz PCI operations
- Supports up to 6 Req/Gnt pairs (PCI Slots), WX6 already share one Req/Gnt signal for PCI audio chipset.
- Integrated IDE controller with Ultra DMA/66 support
- USB host interface with support for 2 USB ports
- AC '97 2.1 compliant link for audio and telephony CODECs
- Firmware Hub (FWH) interface support

The FW82802 is also called the FWH, **Firmware Hub**. The FWH component is part of several integrated Intel® chipsets. The FWH is key to enabling future security and manageability infrastructures for the PC platform. The device operates under the FWH interface/protocol. The hardware features of this device include a **Random Number Generator (RNG)**, five **General Purpose Inputs (GPIs)**, register-based block locking, and hardware-based locking. An integrated combination of logic features and non-volatile memory enables better protection for the storage/update of platform code/data, adds platform flexibility through additional GPIs and allows for quicker introduction of new security/manageability features into the current and future Intel® architecture platform. It's available in 8Mbit (82802AC), 4Mbit (82802AB), and 2Mbit (82802AA) densities. It uses the 32L PLCC or 40L TSOP industry standard packages.

The WX6 has one AMR slot onboard, it is called the **Audio/Modem Riser (AMR)** slot. The Audio/Modem Riser is an open industry-standard specification that defines a hardware scalable **Original Equipment Manufacturer (OEM)** motherboard riser board and interface, which supports both audio and modem functions. The specification's main objective is to reduce the baseline implementation cost of audio and modem functionality. In accordance with PC user's demands for feature-rich PCs, combined with the industry's current trend towards lower cost PCs, all of these functions are built into the motherboard. But motherboard integration of the modem subsystem has been problematic to date, in large part due to FCC and other international telecom certification processes that may delay the introduction of a motherboard. Resolving the homologation/certification issue for modems is one of the AMR specification's key objectives.

In the future, not only OEM motherboards will have an AMR design, the AMR card will appear in the market and you can make a choice in buying this kind of card according to your budget. But your motherboard must have an AMR slot to be able to plug an AMR card. The WX6 insures this expandibility for this issue.

As for the CPU, the PPGA processor is the newest addition to the Intel® Celeron™ processor product line, it implements a Dynamic Execution micro-architecture and executes MMX™ media technology instructions for enhanced media and communication performance. The PPGA processor also uses the same multi-transaction system bus used in the Pentium® II processor. The processor also supports multiple low-power states such as AutoHALT, Stop-Grant, and Deep Sleep to conserve power during idle times.

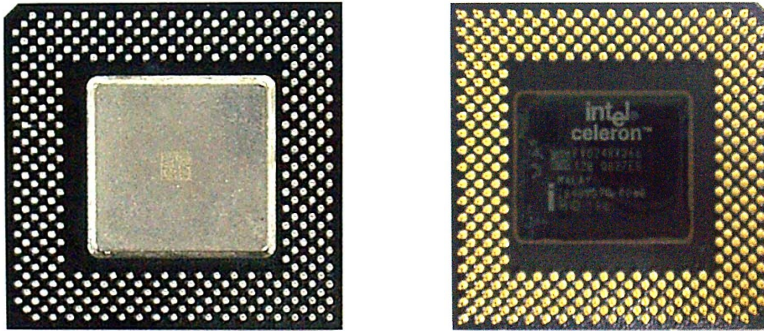

**Figure 1-2. Intel® Celeron™ PPGA package processor**

The PPGA processor includes an integrated 128K second level cache with separated 16K instruction and 16K data level one caches. The second level cache is capable of caching 4GB of system memory.

---

#### **Y2K Problem Free**

The potential threat of Year 2000 (Y2K) problems are making everyone very nervous. The Y2K issue applies to almost any device, firmware, or software that operates on or with year based dates. This problem is caused by a design flaw in the **Real Time Clock (RTC)** unit. The RTC only changes the last two digits of the year code, but not the century information. As a result, when it comes to 12:00 AM January 1, 2000 the RTC will switch from December 31 11:59 PM 1999 to 12:00 AM January 1 1900.

Y2K compliance deals with the date change over from 31 December 1999 to 1 January 2000, and with recording and reporting of all dates from the RTC including leap year dates. This



motherboard is free from the Y2K problem because its BIOS are Y2K compliant.

**Please Note**

If the operating system or application software cannot handle Year 2000 dates, you will still be facing the Y2K threat because it is not a hardware problem that relates to the motherboard itself. According to Award BIOS, it is BIOS source code released after 31 May 1995 complies with all known Y2K issues; however, it may still fail the 2000.exe test. Award has modified its BIOS source code to accommodate the requirements of 2000.exe. Award BIOS source code issued later than 18 November 1996 passes the NTSL 2000.exe test program.

---

## 1-2. Specifications

---

### 1. CPU

- Supports Intel® Celeron™ 300A~533MHz processors (Based on 66MHz PPGA package)
- Supports 66 and 100MHz CPU external clock speeds
- Employs switching type regulators to stabilize CPU operation

### 2. Chipset

- Intel® 810 chipset (FW82810, FW82801 and FW82802AB)
- Supports Ultra DMA 33/66 IDE protocol
- Supports Advanced Configuration and Power Management Interface (ACPI)

### 3. Cache Memory

- Level 1 and Level 2 cache built into Intel® Celeron™ processor (PPGA package)

### 4. Memory

#### System Memory:

- Two 168-pin DIMM sockets support SDRAM modules
- Supports up to 256MB (512MB using 128Mb technology)

#### Graphic Memory:

- 4MB SDRAM

## 5. Integrated Graphics Controller

### 2D Graphics:

- Up to 1600\*1200 in 8-bit color at 85Hz refresh rate
- Full hardware accelerated functions

### 3D Graphics:

- Flat & Gouraud shading
- Mip maps with bilinear and anisotropic filtering
- Fogging atmospheric effects
- Z buffering
- Backface culling
- Per pixel perspective correction texture mapping
- Texture compositing
- Texture color keying/chroma keying

### Others features:

- 85MHz flat monitor interface or digital video output for use with a external TV encoder
- Integrated 24-bit 230MHz RAMDAC
- DDC2B compliant
- Motion video acceleration

## 6. System BIOS

- CPU SOFT MENU™ II, can easily set the processor parameters
- AWARD BIOS
- Supports Plug-and-Play (PnP)
- Supports Advanced Configuration Power Interface (ACPI)
- Supports Desktop Management Interface (DMI)
- Year 2000 compliant

## 7. Multi I/O Functions

- Floppy port supports up to 2.88MB, and 3 mode floppies
- Ultra DMA/66 bus master IDE supports up to 4 IDE devices (Including LS-120 MB floppy drive)
- Built-in Standard/EPP/ECP parallel port connector
- One built-in 16550 fast UART compatible serial port connector
- One built-in 16550 fast UART compatible serial port header
- Built-in PS/2 keyboard and PS/2 mouse port connectors
- Built-in standard IrDA TX/RX header
- Two built-in USB connectors
- Built-in VGA connector

- Built-in Audio connector (Line-in, Line-out, MIC-in, Game port)
- Built-in Wake on LAN header
- Built-in Wake on Ring header

### **8. Audio chip features (Optional)**

- PCI bus master with integrated DMA controller, deep FIFO buffering, and scatter/gather support
- Patented Sound Blaster Pro<sup>®</sup> emulation
- 64-voice wavetable synthesis (32 H/W+32 S/W)
- Game port with DirectInput acceleration
- MPU-401 compatible MIDI
- ACPI-compliant power management
- 48-channel, 300 MIPS processor
- A3D Interactive audio (8-source, MMX-accelerated)
- 16-channel DirectSound acceleration
- Hardware sample rate converters (16 stream, 120dB Signal to Noise Rate)
- Digital mixer and volume control (32 inputs, 16 outputs)
- Windows 3.1/95/NT 4.0/NT 5.0 drivers ready

### **9. SiI 154 PanelLink<sup>®</sup> Transmitter features (Optional)**

- Supports high bandwidth from 25MHz (640\*480) to 112MHz (1280\*1024)
- 12-bit pixel/clock or 24-bit 1 pixel/clock input for true color (16.7 million) support.
- Supports VESA<sup>®</sup> P&D<sup>™</sup> and DFP (Digital Flat Panel) Hot Plug Detection plus RxDetect feature.

### **10. Miscellaneous**

- ATX form factor
- Five PCI slots and one AMR slots
- Supports PS/2 keyboard and PS/2 mouse wake-up functions
- Hardware monitoring : Included fan speed, voltages, CPU and system environment temperature
- Built-in two thermal sensors to detect CPU and system temperature
- Board size: 305 \* 190mm

- \* **Supports Wake Up on LAN, Keyboard or Mouse, but your ATX power supply 5V standby power must be able to provide at least a 720mA current capacity. Otherwise, the functions may not work normally.**
- \* Above 66MHz/100MHz bus speeds are supported but not guaranteed due to the PCI and chipset specifications.
- \* Specifications and information contained in this manual are subject to change without notice.

**Note**

All brand names and trademarks are the property of their respective owners.

### 1-3. Layout Diagram

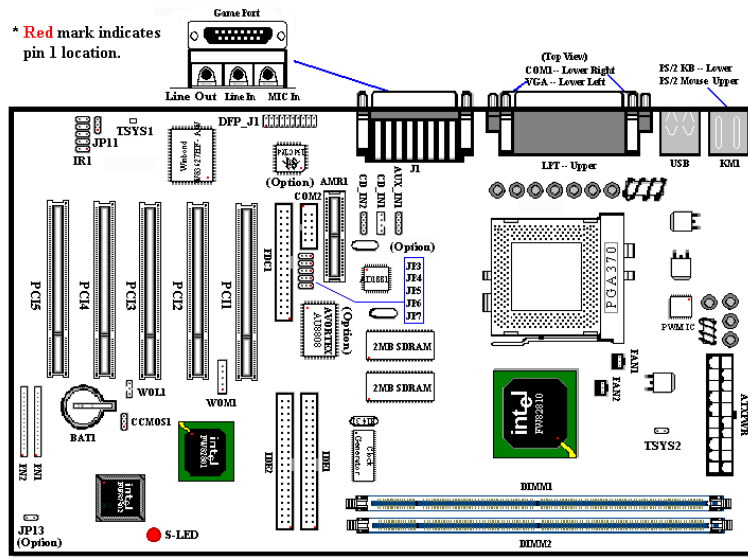

## AB-WX6

Figure 1-3. Motherboard component location



---

## Chapter 2. Installing the Motherboard

---

The WX6 motherboard not only provides all of the standard equipment for personal computers, but also provides great flexibility for meeting future upgrade demands. This chapter will introduce, step by step, all the standard equipment and will also present, as completely as possible, future upgrade capabilities. This motherboard is able to support all Intel® Celeron™ PPGA processors now on the market. (For details, see specifications in Chapter 1.)

This chapter is organized according to the following features:

- 2-1 Installing the Motherboard to the Chassis
- 2-2 Installation of the Celeron™ PPGA processor
- 2-3 Installing System Memory
- 2-4 Connectors, Headers and Switches



**Before Proceeding with the Installation**



Before you install or unplug any connectors or add-on cards, please remember to turn the ATX power supply switch off (fully turn the +5V standby power off), or take the power cord off. Otherwise, you may cause the motherboard components or add-on cards to malfunction or be damaged.



---

### User Friendly Instructions

Our objective is to enable the novice computer user to perform the installation by himself. We have attempted to write this document in a very clear, concise and descriptive manner to help overcome any obstacles you may face during installation. Please read our instructions carefully and follow them step-by-step.

## 2-1. Installing the Motherboard to the Chassis

Most computer chassis will have a base on which there will be many mounting holes that allows the motherboard to be securely attached and at the same time, prevents short circuits. There are two ways to attach the motherboard to the base of chassis:

- with studs
- or with spacers

Please refer to figure 2-1 that shows the studs and spacers, they may have several types, but all look similar to the figures below:

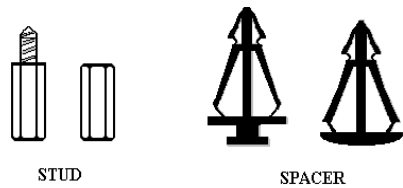

Figure 2-1. The outline of stub and spacer

In principle, the best way to attach the motherboard is with studs, and only if you are unable to do this should you attach the board with spacers. Take a careful look at the motherboard and you will see many mounting holes on it. Line these holes up with the mounting holes on the base. If the holes line up, and there are screw holes this means you can attach the motherboard with studs. If the holes line up and there are only slots, this means you can only attach the motherboard with spacers. Take the tip of the spacers and insert them into the slots. After doing this to all the slots, you can slide the motherboard into position aligned with the slots. After the motherboard has been positioned, check to make sure everything is OK before putting the casing back on.

Figure 2-2 shows you the way to affix the motherboard using studs or spacers:

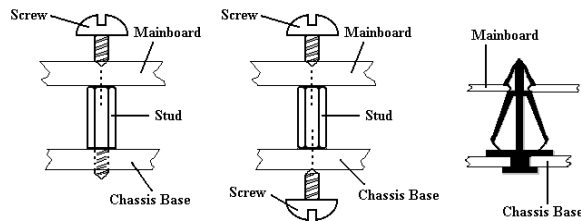

Figure 2-2. The way we fixed the motherboard



**Note**

If the motherboard has mounting holes, but they don't line up with the holes on the base and there are no slots to attach the spacers, don't worry, you can still attach the spacers to the mounting holes. Just cut the bottom portion of spacers (the spacer may be a little hard to cut off, so be careful of your hands). In this way you can still attach the motherboard to the base without worrying about short circuits. Sometimes you may need to use the plastic springs to isolate the screw from the motherboard PCB surface, because the circuit wire may be near by the hole. Be careful, don't let the screw contact any printed circuit wire or parts on the PCB that are near the fixing hole, otherwise it may damage the board or cause board malfunctioning.

## 2-2. Installation of the Celeron™ PPGA processor

The Intel® Celeron™ PPGA package processor installation, is easy, like Socket 7 Pentium® processors before. Because it uses the "Socket 370" ZIF (Zero Insertion Force) socket, it lets you easily fix the processor on to its position firmly.

Figure 2-3 shows you what the 370 socket looks like, and how to open the lever. Its pin count is more than socket 7. Therefore, a Pentium level processor cannot be inserted into socket 370.

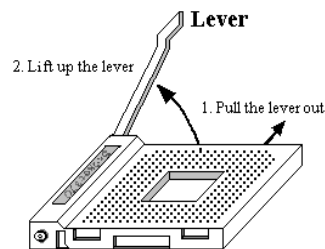

**Figure 2-3. Socket 370 and open its lever**

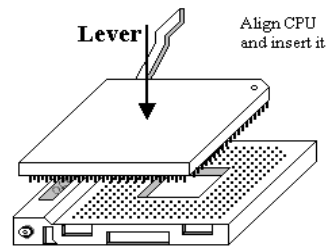

**Figure 2-4. Install the CPU into socket 370**

When you raise the lever, you have to loosen the socket lock. Please raise the lever to the end, and prepare to insert the processor. Next, you need to align the processor pin 1 to the socket pin 1. If you put it in the wrong direction, you will not be able to insert the processor easily, and processor pins will not fully go into the socket. If that is the case, please change the direction, until it easily and fully inserts into the 370 socket. See Figure 2-4.

When you finish the above, push the lever down to its original position, and you should feel the lever lock up the 370 socket. You have then finished the processor installation.

## 2-3. Installing System Memory

This motherboard provides two 168-pin DIMM sites for memory expansion. The DIMM sockets support 1Mx64 (8MB), 2Mx64 (16MB), 4Mx64 (32MB), 8Mx64 (64MB), 16Mx64 (128MB), and 32Mx64 (256MB) or double sided DIMM modules. Minimum memory size is 8MB and maximum memory size is 256MB SDRAM (512MB using 128Mb technology). There are two memory module sockets on the system board. (total four banks)

In order to create a memory array, certain rules must be followed. The following set of rules allows for optimum configurations.

- The memory array is 64 or 72 bits wide. (Depending on with or without parity)
- Those modules can be populated in any order.
- Supports single and double density DIMMS.

**Table 2-1. Valid Memory Configurations**

Bank	Memory Module	Total Memory
Bank 0, 1 (DIMM1)	8MB, 16MB, 32MB, 64MB, 128MB, 256MB	8MB ~ 256MB
Bank 2, 3 (DIMM2)	8MB, 16MB, 32MB, 64MB, 128MB, 256MB	8MB ~ 256MB
Total System Memory		8MB ~ 256MB

Generally, installing SDRAM modules to your motherboard is an easy thing to do. You can refer to figure 2-5 to see what a 168-pin PC100 SDRAM module looks like.

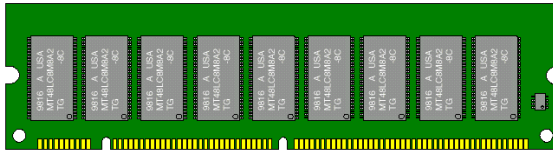

**Figure 2-5. PC100 Module and Component Mark**

Unlike installing SIMMs, DIMMs may be "snapped" directly into the socket. Note: Certain DIMM sockets have minor physical differences.

If your module doesn't seem to fit, please do not force it into the socket as you may damaged your memory module or DIMM socket.

The following procedure will show you how to install a DIMM module into a DIMM socket.

Step 1. Before you install the memory module, please place the computer power switch in the *off* position and disconnect the AC power cord from your computer.

Step 2. Remove the computer's chassis cover.

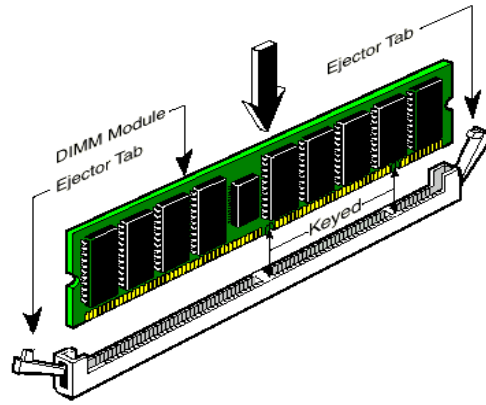

Figure 2-6. Memory module installation

You can refer to figure 2-6 for the details. ***This insures the DIMM module will be plugged into the socket in one way only.*** Firmly press the DIMM module into the DIMM socket, making certain the module is completely seated in the DIMM socket.

Step 6. Once the DIMM module has been installed, the installation is complete and the computer's cover can be replaced. Or you can continue to install other devices and add-on cards that are mentioned in the following section.

**Note**

When you install a DIMM module fully into the DIMM socket, the eject tab should be locked into the DIMM module very firmly and fit into its indentation on the both sides.

## 2-4. Connectors, Headers and Switches

Inside the case of any computer several cables and plugs have to be connected. These cables and plugs are usually connected one-by-one to connectors located on the motherboard. You need to carefully pay attention to any connection orientation the cables may have and, if any, notice the position of the first pin of the connector. In the explanations that follow, we will describe the significance of the first pin.

We will show you all connectors, headers and switches here, and tell you how to connect them. Please pay attention and read the whole section for necessary information before attempting to finish all of the hardware installation inside the computer chassis.

Figure 2-7 shows you all of the connectors and headers that we'll discuss in the next section, you can use this diagram to visually locate each connector and header we describe.

All connectors, headers and switches mentioned here, will depend on your system configuration. Some features you may (or may not) have and need to connect or configure depending on the peripheral. If your system doesn't have such add-on cards or switches you can ignore some special feature connectors.

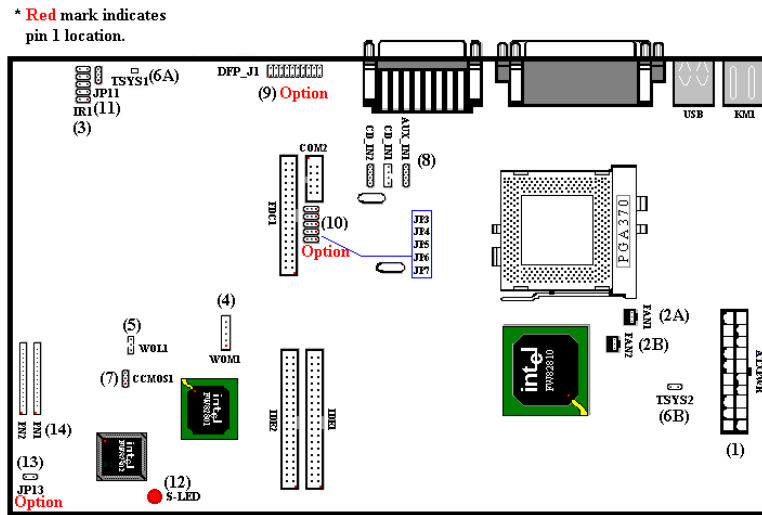

Figure 2-7. All Connectors and Headers for the WX6

First, Let's see the headers that the WX6 uses, and what their functions are.

**WX6**

**(1) ATXPWR: ATX Power Input Connector****Caution**

If the power supply connectors are not properly attached to the ATXPWR connector, the power supply or add-on cards may be damaged.

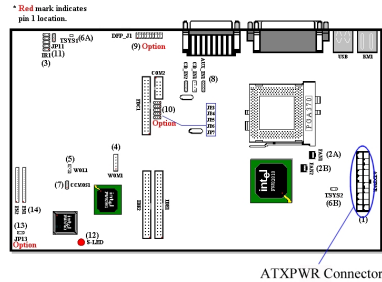

Attach the connector from the power supply to the ATXPWR connector here. Remember you have to push the connector from the ATX power supply firmly to the end with the ATXPWR connector, insuring that you have a good connection.

**Note:** Watch the pin position and the orientation

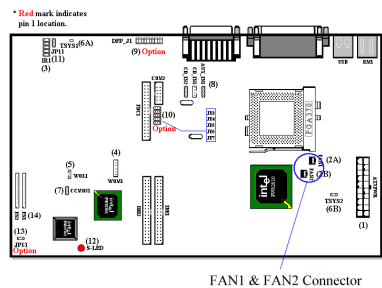
**(2A) and (2B) Headers: FAN1 and FAN2 Headers**

Attach the connector from the individual CPU fan to the header named FAN1, and attach the connector from the chassis fan to FAN2 header.

You must attach the CPU fan to the processor, or your processor will work abnormally or may be damaged by overheating. Also, if you want the computer case's internal temperature to be kept steady and not too high, you had better connect the chassis fan.

**Note:** Watch the pin position and the orientation

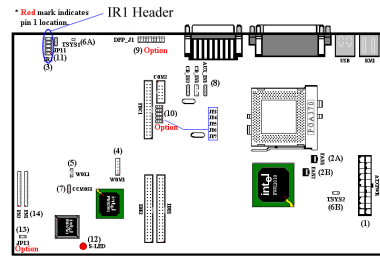
**(3) IRI1: IR Header (Infrared)**

There is a specific orientation for pins 1 through 10, attach the connector from the IR KIT or IR device to the IRI1 header. This motherboard supports standard IR transfer rates.

*Note: Watch the pin position and the orientation*

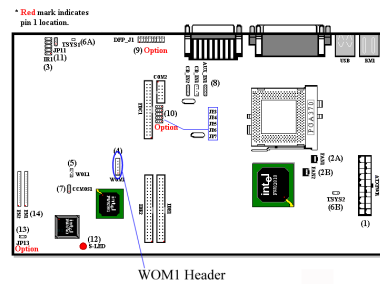
**(4) WOM1: Wake On Ring Header**

If you have an internal modem adapter that supports this feature, then you can connect the specific cable from the internal modem adapter to this header. This feature lets you wake up your computer via remote control through the modem.

*Note: Watch the pin position and the orientation*

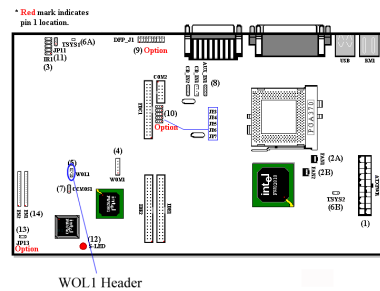
**(5) WOL1: Wake on LAN Header**

If you have a Network adapter that supports this feature, then you can connect the specific cable from the network adapter to this header. This feature lets you wake up your computer via remote control through a local area network. You may need a specific utility to control the wake up event, like using the Intel® LDCM® utility or other similar utilities.

*Note: Watch the pin position and the orientation*

**(6A) and (6B): TSYS1 and TSYS2 Header**

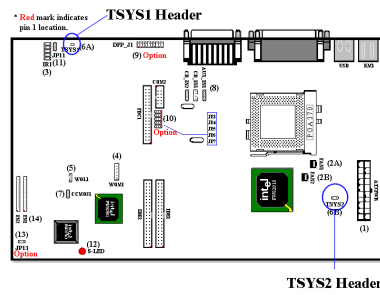

The TSYS1 thermistor is already onboard, and is used to detect the system environment temperature. The TSYS2 is for you to connect an additional thermistor to detect the temperature in the location of your choice. You can buy the thermistor at an electronics store, ask for a 10KΩ thermistor (NTC type) which should be OK. Please don't use too long of a lead wire for the thermistor.

**(7) CCMOS1: CMOS Discharge Jumper**

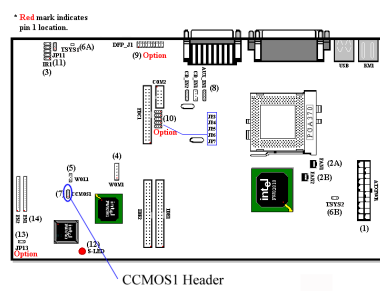

Jumper CCMOS1 discharges the CMOS memory. When you install the motherboard, make sure this jumper is set for normal operation (pin 1 and 2 shorted). See figure 2-8.

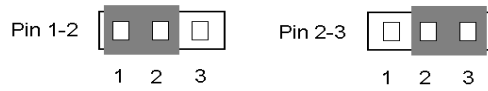

Normal Operation (Default)

Discharge CMOS

**Figure 2-8. CCMOS1 jumper setting**

**Note**

Before you clear the CMOS, you have to first turn off the power (including the +5V standby power), otherwise, your system may work abnormally or malfunction.

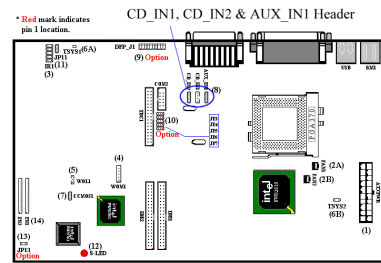
**(8) CD\_IN1, CD\_IN2 and AUX\_IN1:**

**CD\_IN1 & CD\_IN2:** These connectors are for the internal CD-ROM drive audio cable connection use, and these two connectors are used for different types of CD audio cable connectors. Please check your audio cable attached with the CD-ROM drive to see which type connector you have, then plug it to the appropriate connector on the motherboard.

**AUX\_IN1:** This connector is used for other internal audio cable connections. For example, if you have installed two internal CD-ROM drives in your computer system, you can connect a secondary CD-ROM drive audio cable to this connector.

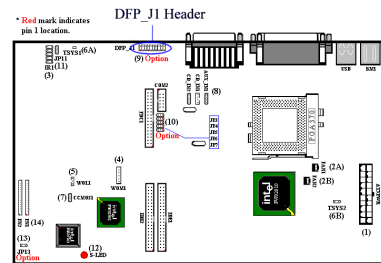
**(9) DFP\_J1: Digital Flat Panel Header (Option)**

This header is for Digital Flat Panel signal output use. You need to attach an additional 20-pin DFP connector and cable (with plate) to fix it on the back of the chassis. You can plug your digital flat panel connector to the DFP connector.

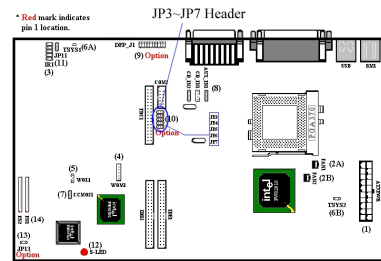
**(10) JP3~JP7: Audio Chipset Selector (Option)**

These jumper settings are used in selecting use of the built-in audio chip, AU8808 or using the Intel® ICH internal audio controller. The default settings is for the built-in audio chip, JP3~JP7 pin 1 and pin 2 shorted. The detailed settings are:

**JP3~JP7 pin 1 and pin 2 shorted:** This setting will choose the use of the ICH internal audio controller.

**JP3~JP7 pin 2 and pin 3 shorted:** This setting will choose the use of the AU8808 audio chip.



**(11) JP11: Audio CODEC Selector**

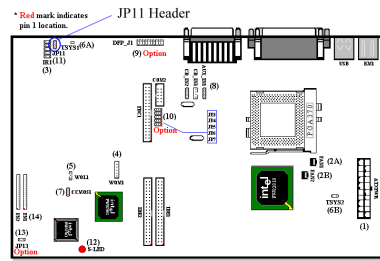

This jumper lets you select the CODEC mode on the AMR card. When pin 1 and pin 2 jumpers are shorted, the CODEC on the AMR card is set to secondary mode. If pin 2 and pin 3 jumpers are shorted, the onboard audio CODEC is disabled and CODEC on the AMR card is set to primary mode.

**(12) S-LED: Standby LED**

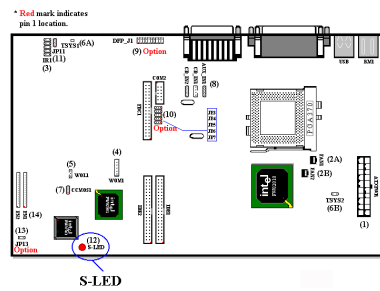

This LED is called the Stand-By LED. It shows if the motherboard is in the power on state, or is fully powered down. If this LED light is on, that means your motherboard is not fully powered down. You can't disassemble any components, add-on cards, CPU, or RAM modules in this state. You have to fully check and shutdown the system power, before this LED will turn off. Only then can you disassemble any components,

add-on cards, CPU, or RAM module.

**(13) JP13: PCI Audio Selector (Option)**

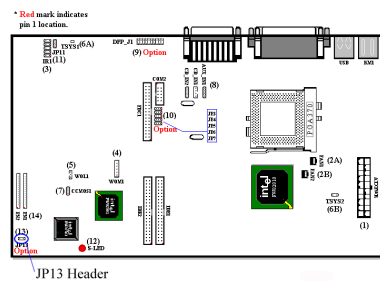

This jumper is used to disable or enable the PCI audio chip. When this jumper is shorted, the PCI audio chip will be disabled. If this jumper is opened, the PCI audio chip will be enabled. Because this motherboard has several audio solutions, please check table 2-2 to see the different options that you can have set up according your motherboard configuration to make the correspondent settings.

Table 2-2. Audio Jumper Settings Table

	JP3	JP4	JP5	JP6	JP7	JP11	JP13
Using the onboard PCI audio chip AU8808 with audio CODEC	2~3 pin shorted	2~3 pin shorted	2~3 pin shorted	2~3 pin shorted	2~3 pin shorted	2~3 pin shorted	Open
Using the ICH audio controller with audio CODEC	1~2 pin shorted	1~2 pin shorted	1~2 pin shorted	1~2 pin shorted	1~2 pin shorted	1~2 pin shorted	Shorted
Using the AMR audio card with audio CODEC	Doesn't Matter (Ignore)	Doesn't Matter (Ignore)	Doesn't Matter (Ignore)	Doesn't Matter (Ignore)	Doesn't Matter (Ignore)	2~3 pin shorted	Shorted
Using another PCI audio adapter with audio CODEC	Doesn't Matter (Ignore)	Doesn't Matter (Ignore)	Doesn't Matter (Ignore)	Doesn't Matter (Ignore)	Doesn't Matter (Ignore)	2~3 pin shorted	Shorted

**Note:** Please carefully check your audio settings on the motherboard, or you may have problems with no audio output from the PC speaker or external speakers.

**(14) PN1 and PN2 Headers**

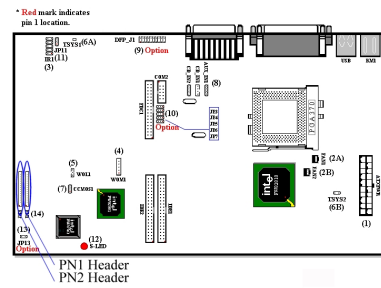

PN1 and PN2 are for switches and indicators for the chassis's front panel, there are several functions that come from these two headers. You have to watch the pin position and the orientation, or you may cause system malfunctions. Figure 2-9 shows you the functions of PN1 and PN2.

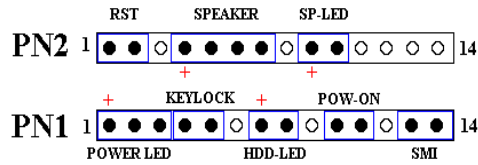
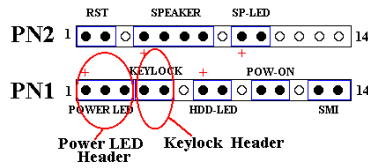

Figure 2-9. The Explanatory Diagram of PN1 and PN2

**PN1 (Pin 1-2-3-4-5): Power LED and Keylock Switch Headers**



There is a specific orientation for pins 1 through 3. Insert the three-threaded power LED cable to pins 1~3, and the two-threaded keylock cable into pins 4 and 5. Check to make sure the correct pins go to the correct connectors on the motherboard. If you install them with the wrong direction, the power LED light will not illuminate correctly.

*Note: Watch the power LED pin position and orientation.*

**PN1 (Pin 7-8): HDD LED Header**

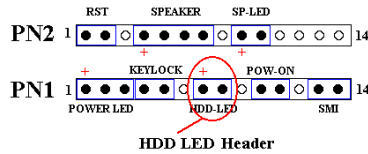

Attach the cable from the case's front panel HDD LED to this header. If you install it in the wrong direction, the LED light will not illuminate correctly.

*Note: Watch the HDD LED pin position and the orientation.*

**PN1 (Pin 10-11): Power on Switch Header**

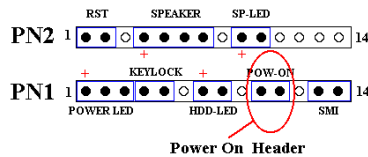

Attach the cable from the case's front panel power switch to this header.

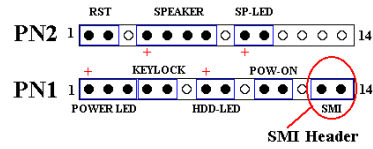
**PN1 (Pin 13-14): Hardware Suspend Switch (SMI Switch) Header**

Attach the cable from the case's front panel suspend switch (if there is one) to this header. Use this switch to enable/disable the power management function by hardware.

**Note:** If you enable the ACPI function in the BIOS setup, this function will not work.

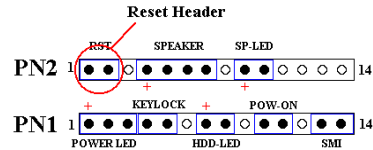
**PN2 (Pin 1-2): Hardware Reset Switch Header**

Attach the cable from the case's front panel Reset switch to this header. Press and hold the reset button for at least one second to reset the system.

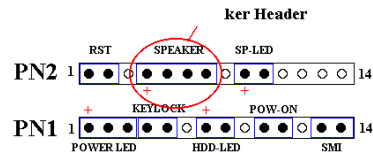
**PN2 (Pin 4-5-6-7): Speaker Header**

Attach the cable from the system speaker to this header.

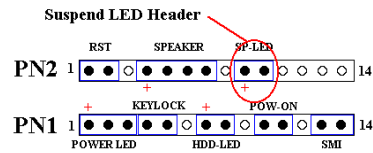
**PN2 (Pin 9-10): Suspend LED Header**

Insert the two-threaded suspend LED cable into pin 9 and pin 10. If you install it in the wrong direction, the LED light will not illuminate correctly.

**Note:** Watch the Suspend LED pin position and the orientation. For pin count-name list for PN1 and PN2, please refer to table 2-3.

Table 2-3. PN1 and PN2 pin count name list

PIN Name		Significance of signal	PIN Name		Significance of signal
PN1	PIN 1	VCC (+5VDC)	PN2	PIN 1	Ground
	PIN 2	No connection		PIN 2	Reset input
	PIN 3	Power LED (-)		PIN 3	No connection
	PIN 4	Keyboard inhibit Signal		PIN 4	VCC (+5VDC)
	PIN 5	Ground		PIN 5	Ground
	PIN 6	No connection		PIN 6	Ground
	PIN 7	VCC (+5VDC)		PIN 7	Speaker Signal
	PIN 8	HDD LED (-)		PIN 8	No connection
	PIN 9	No connection		PIN 9	VCC (+5VDC)
	PIN 10	5VSB		PIN 10	Suspend LED (-)
	PIN 11	Power On/Off		PIN 11	No connection
	PIN 12	No connection		PIN 12	No connection
	PIN 13	Ground		PIN 13	No connection
	PIN 14	Suspend signal		PIN 14	No connection

Let's now look at the I/O connectors that the WX6 uses, and what their functions are.

**FDC1 Connector**

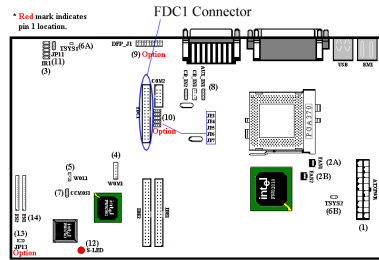

This 34-pin connector is called the “*floppy disk drive connector*”. You can connect a 360K, 5.25”, 1.2M, 5.25”, 720K, 3.5”, 1.44M, 3.5” or 2.88M, 3.5” floppy disk drive.

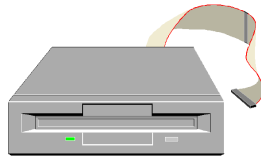

**3.5" Floppy Disk**

A floppy disk drive ribbon cable has 34 wires and two connectors to provide for the connection of two floppy disk drives. After connecting the single end to the FDC1, connect the two connectors on the other end to the floppy disk drives. In general, people only install one floppy disk drive on their computer system.

**Note**

A red mark on a wire typically designates the location of pin 1. You need to align the wire pin 1 to the FDC1 connector pin 1, then insert the wire connector into the FDC1 connector.

**IDE1 and IDE2 Connectors**

An IDE hard disk drive ribbon cable has 40 wires and two connectors to provide a connection for two IDE hard disk drives. After connecting the single end to the IDE1 (or IDE2), connect the two connectors on the other end to the IDE hard disk drives (or CD-ROM drive, LS-120, etc.).

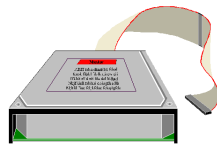
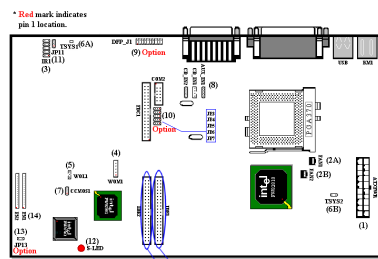

**Hard Disk Drive**

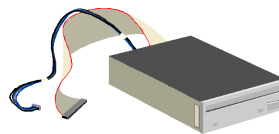

**Internal CD-ROM Drive**

Note: before you install a hard disk, there are some things you need to be aware of:

- ◆ “Primary” refers to the first connector on the motherboard, that is, the IDE1 connector on the motherboard.
- ◆ “Secondary” refers to the second connector on the motherboard, that is, the IDE2 connector on the motherboard.

- ◆ Two hard disks can be connected to each connector:  
The first HDD is referred to as the “Master”, The second HDD is referred to as the “Slave”.
- ◆ For performance issues, we strongly suggest you don’t install a CD-ROM drive on the same IDE channel as a hard disk. Otherwise, the system performance on this channel may drop. (How much drops depends on your CD-ROM drive performance)

**Note**

- The Master or Slave status of the hard disk drive is set on the hard disk itself. Please refer to the hard disk drive user’s manual.
- A red mark on a wire typically designates the location of pin 1. You need to align the wire pin 1 to the IDE1 (or IDE2) connector pin 1, then insert the wire connector into the IDC1 (or IDE2) connector.

The WX6 supports the Ultra ATA/66 (Also known as Ultra DMA/66) specification. It enhances existing Ultra ATA/33 technology by increasing both performance and data integrity. This new high-speed interface doubles the Ultra ATA/33 burst data transfer rate to 66.6 Mbytes/sec. The result is maximum disc performance using the current PCI local bus environment. Figure 2-10 shows you the different between the Ultra ATA/33 and Ultra ATA/66 Conductor Cable.

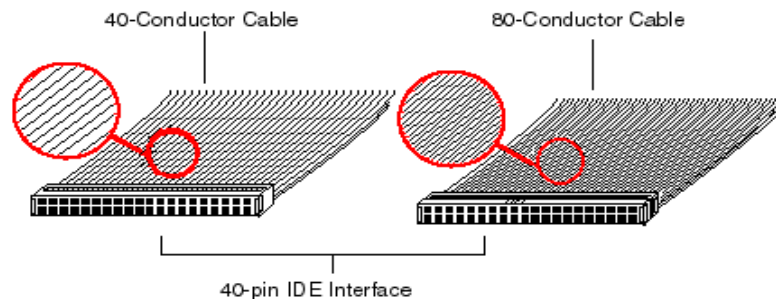

**Figure 2-10. The difference between Ultra ATA/33 and Ultra ATA/66 Conductor Cables**

Figure 2-11 shows you a photo of an Ultra ATA/66 Conductor Cable. An Ultra ATA/66-capable cable is a 40-pin, 80-conductor cable with a black connector on one end, a blue connector on the other end and a gray connector in the middle. In addition, line 34 on the cable should be notched or cut (this may be difficult to see).

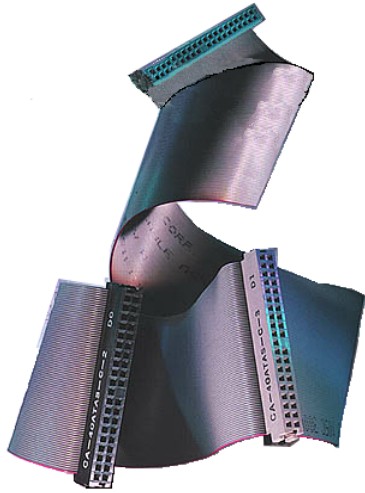

**Figure 2-11. Photo of an Ultra ATA/66 Conductor Cable**

Ultra ATA/66 is backwards compatible with all Ultra ATA/33 systems, but it will be limited in its transfer mode to the Ultra ATA/33 (Ultra DMA Mode 2 - 33 Mbytes/sec) or PIO Mode 4 (16.6 Mbytes/sec). Ultra ATA/66 hard drives are 100 percent backward compatible with both Ultra ATA/33 and DMA and with existing ATA (IDE) hard drives, CD-ROM drives, and host systems. The Ultra ATA/66 protocol and commands are designed to be compatible with existing ATA (IDE) devices and systems. Although a new 40-pin, 80-conductor cable is required for Ultra ATA/66, the chip set pin

connector remains the same at 40. Hard drives that support Ultra ATA/66 also support Ultra ATA/33 and legacy ATA (IDE) specifications.

There are four requirements for attaining Ultra ATA/66:

- \*The drive must support Ultra ATA/66.
- \*The motherboard and system BIOS (or an add-in controller) must support Ultra ATA/66.
- \*The operating system must support Direct Memory Access (DMA); Microsoft Windows 98 and Windows 95b (OSR2) support DMA.
- \*The cable must be 80-conductor; the length should not exceed 18 inches. If all the above requirements are met, you can enjoy the Ultra ATA/66 features of your computer system.

How to install the Ultra ATA/66 Cable Assembly:

- The **BLUE** connector **MUST** be plugged into the motherboard or your system will not work.
- Each connector on the Ultra ATA/66 cable assembly has a small polarization tab centrally located on the body of the plastic. This fits into the matching slot on the mating plugs on the motherboard and the drives, thus assuring positive mating (pin #1 to pin #1)
- The red line on the cable should be aligned with pin #1. On the drives this will result in the red line facing the power connector. Attach the BLUE connector to the appropriate 40 pin IDE plug on the motherboard.



- Attach the BLACK connector to the mating plug on the master hard drive. Attach the GREY connector to the mating plug on the slave drive (secondary hard drive, CD-ROM, or tape drive). Please refer figure 2-12.

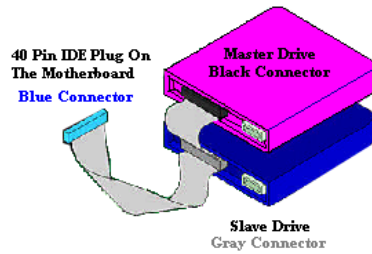

Figure 2-12. How to connect an ATA/66 Cable to the Motherboard

Figure 2-13 shows the WX6 back panel connectors, these connectors are for connections to outside devices to the motherboard. We will describe which devices will attach to these connectors below.

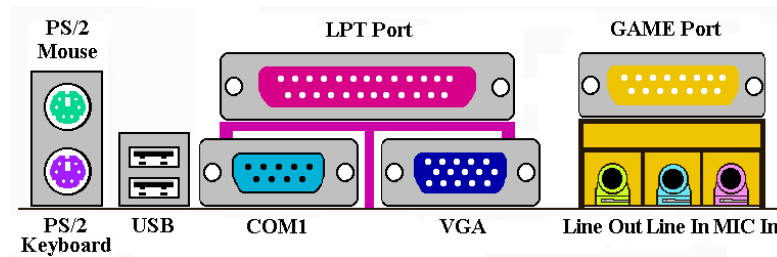
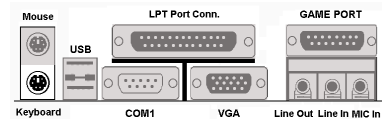

Figure 2-13. WX6 back panel connectors

**KM1 Lower: PS/2 Keyboard Connector**



Attach a PS/2 keyboard connector to this 6-pin Din-connector. If you use an AT keyboard, you can go to a computer store to purchase an AT to ATX converter adapter, then you can connect your AT keyboard to this connector. We suggest you use a PS/2 keyboard for best compatibility.

### **KM1 Upper: PS/2 Mouse Connector**

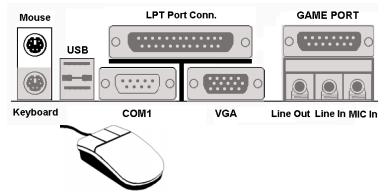

Attach a PS/2 mouse to this 6-pin Din-connector.

### **USB Port Connectors**

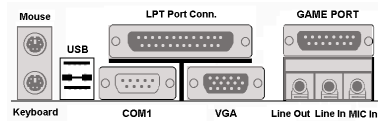

This motherboard provides two USB ports. Attach the USB connector from the individual device to these connectors.

You can attach USB devices such as a scanner, digital speakers, monitor, mouse, keyboard, hub, digital camera, joystick etc. to one of each USB connector. You must make sure your operating system supports this feature and you may need to install an additional driver for individual devices. In Please refer to your device user's manual for detailed information.

### **Serial Port COM1 & COM2 Port Connector**

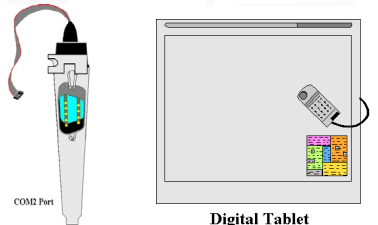
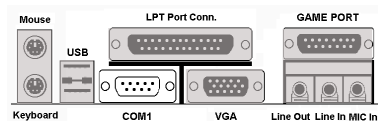

Digital Camera



External FAX/Modem

This motherboard provides two COM ports, you can connect an external modem, mouse or other devices that support this communication protocol to these connectors. The WX6 has one built-in COM1 port connector on the motherboard, the other COM2 port will be attached to the plate with the cable in your motherboard package. You can connect and fix it on the computer chassis's back panel.

You can decide which external devices you want to connect to COM1 and COM2. Each COM port can only have one device connected at a time.

**VGA Port Connector**

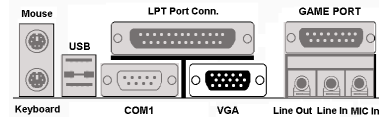

This DIN 15 pin Female connector is for VGA signal output to the monitor. You can connect the plug from the monitor to this connector. If you don't move your system often, we suggest you to fasten the two screws from the plug with this connector. It will assure your display quality.

**Parallel Port Connector**

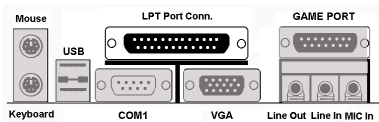

**Laser Printer**



**Inkjet Printer**

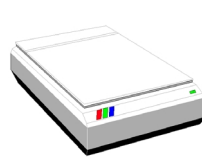

**EPP/ECP Scanner**

This parallel port is also called an “LPT” port, because it usually connects to the printer. You can connect other devices that support this communication protocol, like a EPP/ECP scanner, etc.

**Line Out, Line In and Mic In Connector**

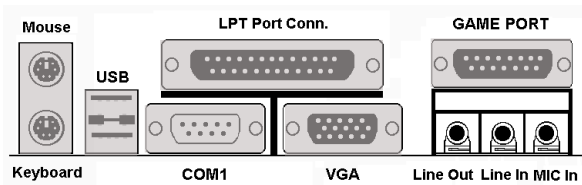

**Line Out connector:** You can connect an external stereo speaker signal input plug to this connector, or you can connect the plug from here to the stereo audio equipment AUX signal input socket. Remember, the motherboard does not have a built in amplifier to drive the speaker, you have to use a speaker that has a built in amplifier. Otherwise, you may not be able to hear any sound or only a small volume of sound from the speaker.



**Line In Connector:** You can connect the TV adapter audio output signal, or external audio sources, like a CD walkman, video camcorder, VHS recorder audio output signal plug to this connector. Your audio software can control the input level for the line-in signal.



CD Player



CAM Recorder



VHS Recorder

**Mic In Connector:** You can connect the plug from the microphone to this connector. Do not connect other audio (or signal) sources to this connector.



### GAME Port Connector

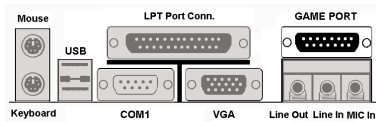

You can connect your joystick, game pad, or other simulation hardware device DIN 15-pin plugs to this connector. Please refer to the further connection notes of the device's user's manual for further detailed information.

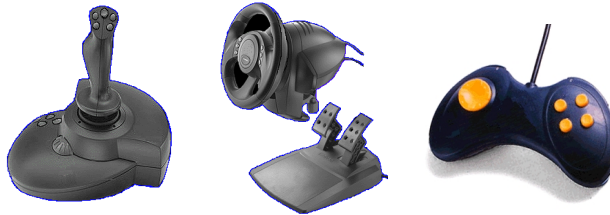

---

## Chapter 3. Introduction of The BIOS

---

The BIOS is a program located on a FWH (Firmware Hub) chip on the motherboard. This program will not be lost when you turn the computer off. This program is also referred to as the “boot” program. It is the only channel for the hardware circuit to communicate with the operating system. Its main function is to manage the setup of the motherboard and interface cards parameters, including simple parameters such as time, date, hard disk drive, as well as more complex parameters such as hardware synchronization, device operating mode, **CPU SOFT MENU™ II** features and setup of CPU speed. The computer will operate normally, or will operate at its best, only if all these parameters are correctly and optimally configured through the BIOS.



**Do not change the parameters inside the BIOS unless you fully understand their meanings and consequences.**

The parameters inside the BIOS are used to setup the hardware synchronization or a device’s operating mode. If the parameters are not correct, they will produce errors, the computer will crash, and sometimes you will even not be able to boot the computer after it has crashed. We recommend that you do not change the parameters inside the BIOS unless you are very familiar with them. If you are not able to boot your computer anymore, please refer to the “CMOS Discharge Jumper” in Section 2-4, Chapter 2.

When you start the computer, it is controlled by the BIOS program. The BIOS first operates an auto-diagnostic test called POST (Power On Self Test) for all the necessary hardware, it then configures the parameters of the hardware synchronization, and detects all the hardware. Only when these tasks are completed does it give up control of the computer to the program of the next level, which is the operating system (OS). Since the BIOS is the only channel for hardware and software to communicate, it is the key factor for system stability, and in insuring that your system performs at its best. After the BIOS has achieved the auto-diagnostic and auto-detection operations, it will display the following message:

**PRESS DEL TO ENTER SETUP**

The message will be displayed for three to five seconds, if you press the **Del** key, you will access the BIOS Setup menu. At that moment, the BIOS will display the following screen:

**Note**

- ❶ To improve stability and functions, BIOSes are constantly improving, therefore; the BIOS screens in this chapter may not fully match your current BIOS screen.
- ❷ All default setting is use the *Load Optimized Defaults* settings. If you use the *Load Fail-Safe Defaults*, some items default values will be changed.

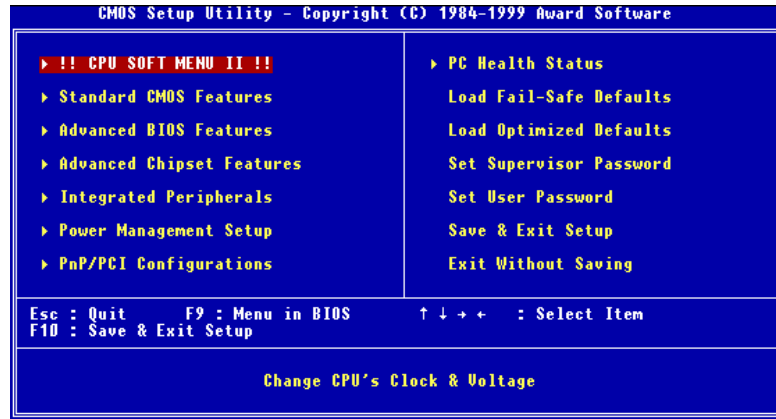

**Figure 3-1. CMOS Setup Utility Main Screen Shot**

This motherboard uses a totally different operating interface so the Award BIOS screens are different than in other versions. It provides more functions with increased user friendliness. In the BIOS Setup main menu in Figure 3-1, you can see several options. We will explain these options step by step in the following pages of this chapter, but let us first see a short description of the function keys you may use here:

- Press **↑↓→←** (up, down, and right) to choose the option you want to confirm or to modify in the main menu.
- Press the **Enter** key to select the item you want. Simply move the highlight to the field you want to select, and press Enter.
- Press **F10** when you have completed setting up the BIOS parameters to save them and exit the BIOS Setup menu.
- Press **Esc** to *Exit* the BIOS Setup.
- Press **F1** to display the General Help screen.

In addition to the **Item Help** window, more information can be provided for the alternate function by pressing the F1 key in any menu in the BIOS.

- Press **F5** to reset current screen settings to their Setup Default values.
- Press **F6** to return to the *Fail-Safe Default* setting i.e. if you use the wrong settings causing a system boot failure, use this function key to quickly return to the system default settings.
- Press **F7** to quickly set the system to the *Optimized Defaults* setting.

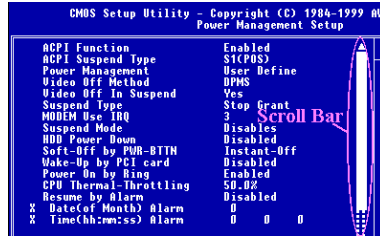

In some setup menu screens, you can see the scroll bar on the right side of the window. You can use the **↑** and **↓** keys or the up and down arrow keys to scroll the screen to view more help information or functions to select.



You may see the right cursor symbol appear on the left side of some items, indicating that additional information or options can be select in a Sub-Menu for this item.

**Note**

The item heading in the square outlet represents the default setting for that field

**Computer Knowledge: CMOS Data**

Maybe you have heard of someone losing CMOS DATA. What is the CMOS? Is it important? CMOS is the memory in which the BIOS parameters that you have configured are stored. This memory is passive, you can both read its data, and store data in it. But this memory has to be powered by a battery in order to avoid data loss when the computer is turned off. If the CMOS battery dies, you will loose all CMOS data. We therefore recommend that you write down all the parameters of your hardware, or you put a label with these parameters on your hard disk.

### 3-1. CPU Soft Menu™ II

The CPU can be setup through a programmable switch (**CPU SOFT MENU™ II**), that replaces the traditional manual hardware configuration. This feature allows the user to more easily complete the installation procedures. You can install the CPU without configuring any jumpers or switches. The CPU must be setup according its specifications.

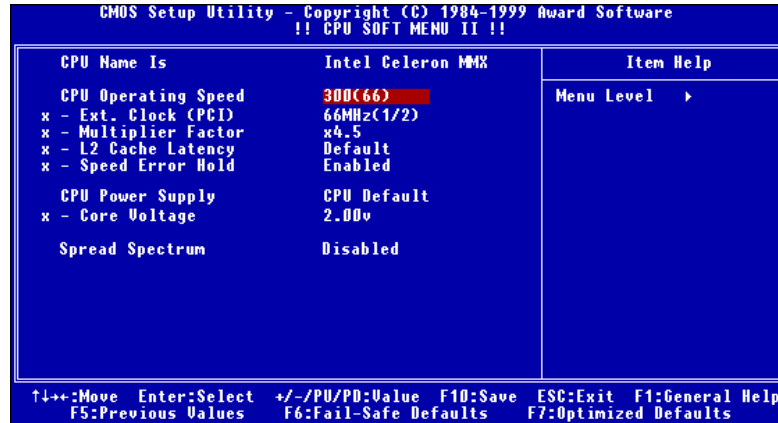

Figure 3-2. CPU Soft Menu II Screen Shot

#### CPU Name Is:

▶ Intel Celeron MMX

#### CPU Operating Speed:

This option sets the CPU speed.

In this field, the CPU speed is indicated like this:  $\text{CPU speed} = \text{External clock} * \text{Multiplier factor}$ , select the CPU speed according the type and the speed of your CPU.

For Intel Celeron™ PPGA MMX processors, you can choose the following settings:

- |  |            |            |              |
|--|------------|------------|--------------|
| ▶300 (66) <input checked="" type="radio"/> default | ▶333 (66)  | ▶366 (66)  | ▶400 (66)    |
| ▶400 (100)   | ▶433 (66)  | ▶450 (100) | ▶466 (66)    |
| ▶500 (66)  | ▶500 (100) | ▶533 (66)  | ▶User Define |





**Note**

CPU bus speed above 66MHz/100MHz supported but not guaranteed due to the PCI and chipset specs.

User defined external clock and multiplier factor:

► **User Defined:**

When you choose the *User Define*, you will be able to set the following five items.

 **Warning** 

The wrong settings of the multiplier and external clock in certain circumstances may cause CPU damage. Setting the working frequency higher than the PCI chipset or processor specs, may cause abnormal memory module functioning, system hangs, hard disk drive data lose, abnormal functioning of the VGA card, or abnormal functioning with other add-on cards. Using non-specification settings for your CPU is not the intention of this explanation. These should be used for engineering testing, not for normal applications.

If you use non-specification settings for normal operation, your system may not be stable, and may effect system reliability. Also, we do not guarantee the stability and compatibility for settings that are not within specification, and any damage of any elements on the motherboard or peripherals, is not our responsibility.

☐ **Ext. Clock (PCI):**

- |   |                 |                 |
|---|-----------------|-----------------|
| ► 66MHz (1/2) <input checked="" type="radio"/> <b>default</b> | ► 100MHz(1/3)   | ► 75MHz (1/2) * |
| ► 83MHz (1/2)*  | ► 90MHz (1/3)*  | ► 95MHz (1/3)*  |
| ► 105MHz (1/3)*   | ► 110MHz (1/3)* | ► 114MHz (1/3)* |
| ► 119MHz (1/3)*   | ► 124MHz (1/3)* | ► 129MHz (1/4)* |
| ► 133MHz (1/4)*   | ► 138MHz (1/4)* | ► 150MHz (1/4)* |

**Note**

CPU bus speed above 66MHz/100MHz supported but not guaranteed due to the PCI and chipset specs.

**☛ Multiplier Factor:**

You can choose the following multiplier factors:

▶ x2    ▶ x2.5    ▶ x3    ▶ x3.5    ▶ x4    ▶ x4.5    ▶ x5    ▶ x5.5    ▶ x6  
▶ x6.5    ▶ x7    ▶ x7.5    ▶ x8

The default setting is *x4.5*.

**☛ L2 Cache Latency:**

Sixteen setting are available, Default, and 1 to 15. This item can let you adjust the processor L2 cache speed, the larger the value, the faster the L2 cache will run. You have to be aware that if you set the L2 cache speed too fast, it will cause the L2 cache to fail. If the L2 cache fails it will cease to run until you reset the value, but the processor and L1 cache will still function, just not as well. To make sure your L2 cache functions properly please choose an appropriate setting. The default setting is *Default*.

**☛ Speed Error Hold:**

The default setting is *Enabled*. If you change the setting to Disabled, when the CPU speed setting is wrong, the system will not hold.

Normally, we do not recommend that you use the “User Define” option to setup CPU speed and multiplier factors. This option is for setup of future CPUs whose specifications are still unknown. The specifications of all present CPUs are included in the default settings. Unless you are very familiar with all CPU parameters, it is very easy to make mistakes when you define the external clock and the multiplier factor by yourself.

**Solution in case of booting problem due to invalid clock setup:**

Normally, if the CPU clock setup is wrong, you will not be able to boot. In this case, turn the system off then on again. The CPU will automatically use its standard parameters to boot. You can then enter the BIOS Setup again and set up the CPU clock. If you can't enter the BIOS setup, you must try turning the system on a few times (3~4 times) or press “INSERT” key when turning on and the system will automatically use its standard parameters to boot. You can then enter BIOS SETUP again and set up the new parameters.

**When you change your CPU:**

This motherboard has been designed in such a way that you can turn the system on after having inserted a CPU in the socket without having to configure any jumpers or DIP switches. But if you change your CPU, normally you just have to turn off the power supply, change the CPU and then, set up the CPU parameters through **SOFT MENU™ II**. However, if the new CPU is slower than the old one (and is same brand and type), we offer you two methods to successfully complete the CPU change operation.

Method 1: Setup up the CPU for the lowest speed for its brand. Turn the power supply off and change the CPU. Then turn the system on again, and set up the CPU parameters through **SOFT MENU™ II**.

Method 2: Since you have to open the computer case when you change the CPU, it could be a good idea to use the CCMOS jumper to erase the parameters of the original CPU and to enter BIOS Setup to set up CPU parameters again.

**Attention**

After setting up the parameters and leaving the BIOS SETUP, and having verified that the system can be booted, do not press the Reset button or turn off the power supply. Otherwise the BIOS will not read correctly, the parameters will fail and you must enter **SOFT MENU™ II** again to set up the parameters all over again.

**CPU Power Supply:**

This option allows you to switch between CPU default and User Define voltages.

► **CPU Default:** The system will detect the CPU type and select the proper voltage automatically. When it is enabled, the option “**Core Voltage**” will show the current voltage setting that is defined by the CPU and this will not be changeable. We recommend using this CPU default setting and not changing it unless the current CPU type and voltage setting can not be detected or is not correct.

► **User Define:** This option lets the user select the voltage manually. You can change values in the “**Core Voltage**” option lists by using the arrow up and down keys.

**⇒ Core Voltage:**

This voltage depends on which processor you use. When the processor is installed, the BIOS will automatically detect and provide the range that you can use to make the adjustment.

---

**Spread Spectrum:**

Two options are available: Disable→0.50%. The default setting is *Disabled*. For EMC (Electro-Magnetic Compatibility Test) testing you may need to adjust these options for optimal results, we do not recommend you change the default, except for special reasons. Some values you select may cause system instability under some situations, please be careful.

## 3-2. Standard CMOS Features Setup Menu

This contains the basic configuration parameters of the BIOS. These parameters include date, hour, VGA card, FDD and HDD settings.

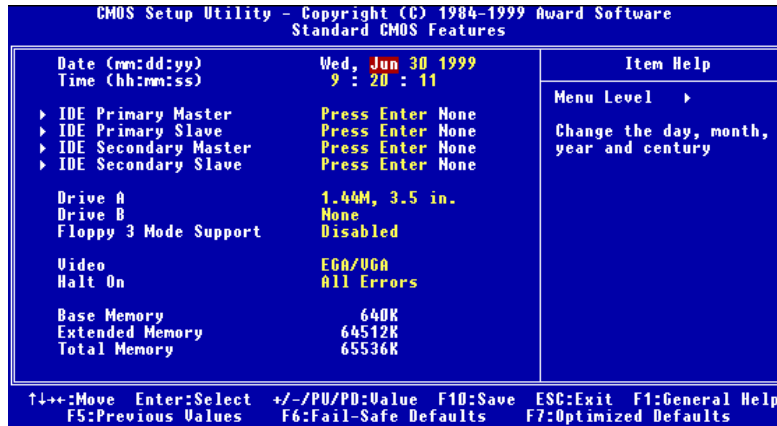

Figure 3-3. Standard CMOS Setup Screen Shot

### Date (mm:dd:yy):

You can set the date in this item: month (mm), date (dd) and year (yy).

### Time (hh:mm:ss):

You can set the time in this item: hour (hh), minute (mm) and second (ss).

### IDE Primary Master / Slave and IDE Secondary Master / Slave:

These items have a sub-menu to let you choose further options. You can refer to figure 3-4 to check what options are available.

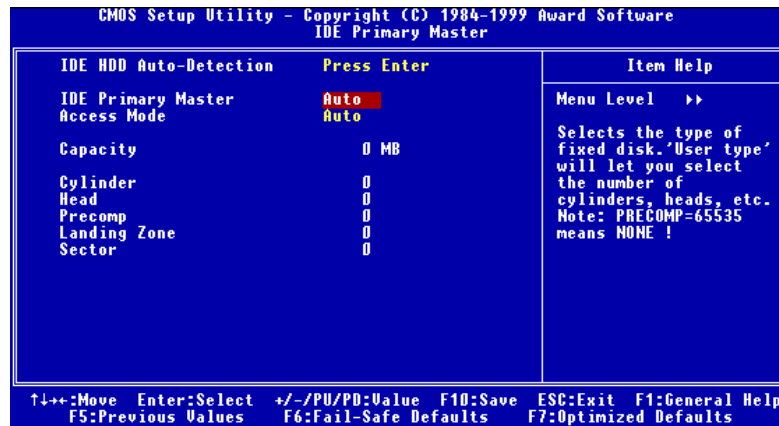

Figure 3-4. IDE Primary Master Setup Screen Shot

**IDE HDD Auto-Detection:**

Press the *Enter* key for the BIOS to auto detect all detailed parameters of the hard disk drivers (HDD). If auto detection is successful, the correct values will be shown in the remaining items of this menu.

**Note**

- ❶ A new IDE HDD must be first formatted, otherwise it can not read/write. The basic step in using a HDD is to make a **HDD low-level format**, then run FDISK, and then FORMAT the drive. Most current HDDs have already been subjected to low-level format at the factory, so you can probably skip this operation. Remember though, the primary IDE HDD must have its partition set to active within the FDISK procedure.
- ❷ If you are using an old HDD that is already formatted, auto detection can not detect the correct parameters. You may need to do a low-level format or set the parameters manually, and then check if the HDD is working.

**IDE Primary Master:**

Three settings are available: *Auto*, *Manual* and *None*. If you choose *Auto*, the BIOS will automatically check what kind hard disk you are using. If you want to set the HDD parameters yourself, make sure you fully understand the meaning of the parameters, and be sure to refer to the manual provided by the HDD manufacture to get the settings right.

**Access Mode:**

Since old operating systems were only able to support HDDs with capacities no bigger than 528MB, any hard disk with more than 528MB was unusable. AWARD BIOS features a solution to this problem: you can, according to your operating system, choose four operating modes: NORMAL → LBA → LARGE → Auto.

The HDD auto detection option in the sub-menu will automatically detect the parameters of your hard disk and the mode supported.

**► Auto:**

Just let the BIOS detect your HDD access mode and make the decisions.

**► Normal mode:**

Standard normal mode supports hard disks of up to 528MB or less. This mode directly uses positions indicated by Cylinders (CYLS), Heads, and Sectors to access data.

**► LBA (Logical Block Addressing) mode:**

The earlier LBA mode can support HDD capacities of up to 8.4GB, and this mode uses a different method to calculate the position of disk data to be accessed. It translates Cylinders (CYLS), Heads and Sectors into a logical address where data is located. The Cylinders, Heads, and Sectors displayed in this menu do not reflect the actual structure of the hard disk, they are just reference values used to calculate actual positions. Currently, all high capacity hard disks support this mode, that's why we recommend you use this mode. Currently, the BIOS can support the INT 13h extension function, enabling the LBA mode to support hard disk drive capacities exceeding 8.4GB.

**► Large Mode:**

When the number of cylinders (CYLs) of the hard disk exceeds 1024 and DOS is not able to support it, or if your operating system does not support LBA mode, you should select this mode.

**Capacity:**

This item auto displays your HDD size. Note that this size is usually slightly greater than the size given by a disk checking program of a formatted disk.

**Note**

All the items below are available when you set the item *Primary IDE Master* to *Manual*.

**Cylinder:**

When disks are placed directly above one another along the shaft, the circular vertical "slice" consisting of all the tracks located in a particular position is called a cylinder. You can set the number of cylinders for a HDD. The minimum number you can enter is 0, the maximum number you can enter is 65536.

**Head:**

This is the tiny electromagnetic coil and metal pole used to create and read back the magnetic patterns on the disk (also called the read/write head). You can configure the number of read/write heads. The minimum number you can enter is 0, the maximum number you can enter is 255.

**Precomp:**

The minimum number you can enter is 0, the maximum number you can enter is 65536.

**Warning**

Setting a value of 65536 means no hard disk exists.

**Landing Zone:**

This is a non-data area on the disk's inner cylinder where the heads can rest when the power is turned off. The minimum number you can enter is 0, the maximum number you can enter is 65536.

**Sector:**

The minimum segment of track length that can be assigned to stored data. Sectors usually are grouped into blocks or logical blocks that function as the smallest units of data permit. You can configure this item to sectors per track. The minimum number you can enter is 0, the maximum number you can enter is 255.

---

**Driver A & Driver B:**

If you have installed the floppy disk drive here, then you can select the type of floppy drive it can support. Six options are available: None → 360K, 5.25 in. → 1.2M, 5.25in. → 720K, 3.5 in. → 1.44M, 3.5 in. → 2.88M, 3.5 in.



**Floppy 3 Mode Support:**

Four options are available: Disabled → Driver A → Driver B → Both. The default setting is *Disabled*. 3 Mode floppy disk drives (FDD) are 3 1/2" drives used in Japanese computer systems. If you need to access data stored in this kind of floppy, you must select this mode, and of course you must have a 3 Mode floppy drive.

---

**Video:**

You can select the VGA modes for your video adapter, four options are available: EGA/VGA → CGA 40 → CGA 80 → MONO. The default setting is EGA/VGA.

---

**Halt On:**

You can select which type of error will cause the system to halt. Five options are available: All Errors → No Errors → All, But Keyboard → All, But Diskette → All, But Disk/Key.

You can see your system memory list in the lower right box, it shows the *Base Memory*, *Extended Memory* and *total Memory size* configurations in your system. It is detected by the system during boot-up procedure.

### 3-3. Advanced BIOS Features Setup Menu

In each item, you can press <Enter> at any time to display all the options for this item.

#### Attention

Advanced BIOS Features Setup Menu has already been set for maximum operation. If you do not really understand each of the options in this menu, we recommend you use the default values.

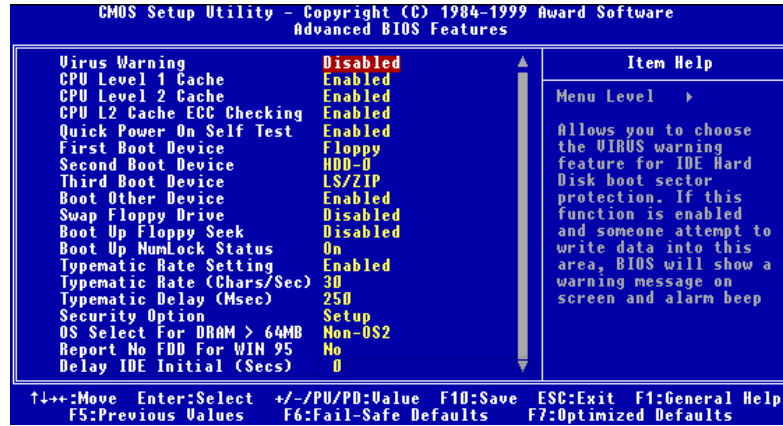

Figure 3-5. Advanced BIOS Features Setup Upper Screen Shot

#### Virus Warning:

This item can be set to Enabled or Disabled, the default setting being *Disabled*. When this feature is enabled, if there is any attempt from a software or an application to access the boot sector or the partition table, the BIOS will warn you that a boot virus is attempting to access the hard disk.

---

**CPU Level 1 Cache:**

This item is used to enable or to disable the CPU level 1 cache. When the cache is set to *Disabled* it is much slower, so the default setting for this item is *Enabled* since it will speed up memory access. Some old and very poorly written programs will make the computer malfunction or crash if the system speed is too high. In this case, you should disable this feature. The default setting is *Enabled*.

---

**CPU Level 2 Cache:**

This item is used to enable or to disable the CPU level 2 cache. When the external cache is *enable*, it will speed up memory access, and the system works faster. The default setting is *Enabled*.

---

**CPU L2 Cache ECC Checking:**

This item is used to enable or to disable the CPU level 2 cache ECC checking function. The default setting is *Enabled*.

---

**Quick Power On Self Test:**

After the computer has been powered on, the BIOS of the motherboard will run a series of tests in order to check the system and its peripherals. If the Quick Power on Self-Test feature is enable, the BIOS will simplify the test procedures in order to speed up the boot process. The default setting is *Enabled*.

---

**First Boot Device:**

When the computer boots up, the BIOS attempts to load the operating system from the devices in the sequence selected in these items: floppy disk drive A, LS/ZIP devices, hard drive C, SCSI hard disk drive or CD-ROM. There are ten options for the boot sequence that you can choose (The default setting is *Floppy*):

Floppy → LS/ZIP → HDD-0 → SCSI → CDROM → HDD-1 → HDD-2 → HDD-3 → LAN → Disabled.

---

**Second Boot Device:**

Description is the same as the *First Boot Device*, the default setting is *HDD-0*.

---

**Third Boot Device:**

Description is same as the *First Boot Device*, the default setting is *LS/ZIP*

---

**Boot Other Device:**

Two options are available: Enabled or Disabled. The default setting is *Enabled*. This setting allows the BIOS to try three kinds of boot devices that set from the above three items.

---

**Swap Floppy Drive:**

This item can be set as Enabled or Disabled. The default setting is *Disabled*. When this feature is enabled, you don't need to open the computer case to swap the position of floppy disk drive connectors. Drive A can be set as drive B and drive B can be set as drive A.

---

**Boot Up Floppy Seek:**

When the computer boots up, the BIOS detects if the system has a FDD or not. When this item is enable, if the BIOS detects no floppy drive, it will display a floppy disk drive error message. If this item is disabled, the BIOS will skip this test. The default setting is *Disabled*.

---

**Boot Up NumLock Status:**

- ▶ On: At boot up, the Numeric Keypad is in numeric mode. (Default Settings)
  - ▶ Off: At boot up, the Numeric Keypad is in cursor control mode.
- 

**Typematic Rate Setting:**

This item allows you to adjust the keystroke repeat rate. When set to *Enabled*, you can set the two keyboard typematic controls that follow (*Typematic Rate* and *Typematic Rate Delay*). If this item is set to *Disabled*, the BIOS will use the default setting. The default setting is *Enabled*.

---

**Typematic Rate (Chars/Sec):**

When you press a key continuously, the keyboard will repeat the keystroke according to the rate you have set (Unit: characters/second) . Eight options are available: 6 → 8 → 10 → 12 → 15 → 20 → 24 → 30 → Back to 6. The default setting is 30.

---

---

**Typematic Delay (Msec):**

When you press a key continuously, if you exceed the delay you have set here, the keyboard will automatically repeat the keystroke according to a certain rate (Unit: milliseconds). Four options are available: 250 → 500 → 750 → 1000 → Back to 250. The default setting is 250.

---

**Security Option:**

This option can be set to System or Setup. The default setting is *Setup*. After you have created a password through PASSWORD SETTING, this option will deny access to your system (System) or modification of computer setup (BIOS Setup) by unauthorized users.

►**SYSTEM:** When you choose System, a password is required each time the computer boots up. If the correct password is not given, the system will not start.

►**SETUP:** When you choose Setup, a password is required only when accessing the BIOS Setup. If you have not set a password in the PASSWORD SETTING option, this option is not available.

To disable security, select *Set Supervisor Password* at main menu and then you will be asked to enter password. Do not type anything and just press the *Enter* key and it will disable security. Once security is disabled, the system will boot and you can enter the *BIOS setup menu* freely

<b>Notice</b>
---------------

Don't forget your password. If you forget the password, you will have to open the computer case and clear all information in the CMOS before you can start up the system. But by doing this, you will have to reset all previously set options.
---

---

**OS Select For DRAM > 64MB:**

When the system memory is bigger than 64MB, the communication method between the BIOS and the operating system will differ from one operating system to another. If you use OS/2, select *OS2*; if you are using another operating system, select *Non-OS2*. The default setting is *Non-OS2*.

---

**Report No FDD For WIN 95:**

When using Windows® 95 without a floppy drive, please set this item to *Yes*. Otherwise, set it to *No*. The default setting is *No*.

---

**Delay IDE Initial (Secs):**

This item is used to support some old models or special types of hard disks or CD-ROMs. They may need a longer amount of time to initialize and prepare for activation. Since the BIOS may not detect those kinds of devices during system booting. You can adjust the value to fit such devices. Larger values will give more delay time to the device. The minimum number you can enter is 0, the maximum number you can enter is 15. The default setting is 0. For best system performance, we strongly suggest you to set it to 0.

### 3-4. Advanced Chipset Features Setup Menu

The Advanced Chipset Features Setup Menu is used to modify the contents of the buffers in the chipset on the motherboard. Since the parameters of the buffers are closely related to hardware, if the setup is not correct or is false, the motherboard will become unstable or you will not be able to boot up. If you don't know the hardware very well, use default values (i.e. use the *Load Optimized Defaults* option). The only time you might consider making any changes is if you discover that data is being lost while using your system.

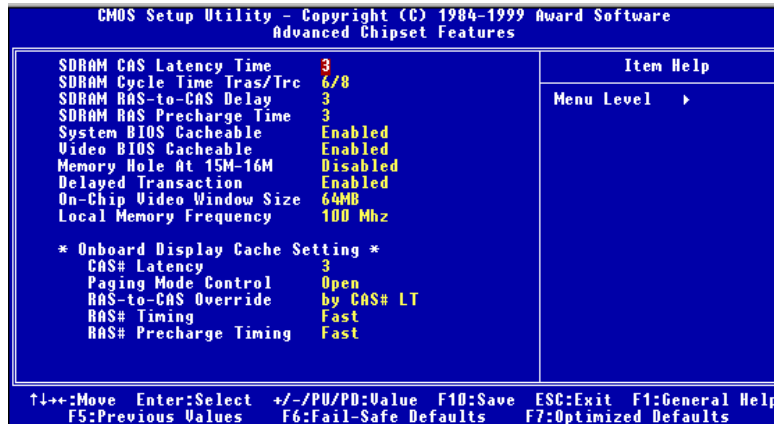

Figure 3-6. Advanced Chipset Features Setup Screen Shot

You can use the arrow keys to move between the items. Use ↑, ↓ and Enter key to change the values. When you have finished setting up the chipset, press **Esc** to go back to the main menu.

The first chipset settings deal with CPU access to DRAM. The default timings have been carefully chosen and should only be altered if data is being lost. Such a scenario might well occur if your system has mixed speed DRAM chips installed so that greater delays may be required to preserve the integrity of the data held in the slower memory chips.

#### SDRAM CAS Latency Time:

Two options are available: 2 and 3. The default setting is 3. You can select SDRAM CAS (Column Address Strobe) latency time according your SDRAM specification.

**SDRAM Cycle Time *Tras/Trc*:**

Two options are available: *5/7* and *6/8*. The default setting is *6/8*. This item controls the number of SDRAM clocks (SCLKs) used per access cycle.

---

**SDRAM RAS-to-CAS Delay**

Two options are available: *2* and *3*. The default setting is *3*. This item lets you insert a timing delay between the CAS and RAS strobe signals, used when DRAM is written to, read from, or refreshed. *Fast* gives faster performance; and *Slow* gives more stable performance. This item applies only when synchronous DRAM is installed in the system.

---

**SDRAM RAS Precharge Time:**

Two options are available: *2* and *3*. The default setting is *3*. This option lets you insert a timing delay between the CAS and RAS strobe signals, used when DRAM is written to, read from, or refreshed. *Fast* gives faster performance; and *Slow* gives more stable performance. This item applies only when synchronous DRAM is installed in the system.

---

**System BIOS Cacheable:**

You can select *Enabled* or *Disabled*. The default setting is *Enabled*. When you select *Enabled* allows caching of the system BIOS ROM at F0000h-FFFFFh, resulting in better system performance. However, if any program writes to this memory area, a system error may result.

---

**Video BIOS Cacheable:**

You can select *Enabled* or *Disabled*. The default setting is *Enabled*. When you select *Enabled* allows caching of the video BIOS, resulting in better system performance. However, if any program writes to this memory area, a system error may result.

---

**Memory Hole At 15M-16M:**

Two options are available: *Enabled* and *Disabled*. The default setting is *Disabled*. This option is used to reserve the memory block 15M-16M for ISA adapter ROM. Some special peripherals need to use a memory block located between 15M and 16M, and this memory block has a size of 1M. We recommend that you disable this option.

---

---



**Delayed Transaction:**

Two options are available: Enabled and Disabled. The default setting is *Enabled*. Set the option to enabled or disabled PCI 2.1 features including passive release and delayed transaction for the chipset. This function is used to meet the latency of PCI cycles to or from the ISA bus. This option must be enabled to provide PCI 2.1 compliance. If you have an ISA card compatibility problem, you can try to enable or disable this option for optimal results.

---

**On-Chip Video Window Size:**

Three options are available: 64MB → 32MB → Disabled → Back to 64MB. The default setting is 64MB. This option specifies the amount of system memory that can be used by the AGP graphic data.

---

**Local Memory Frequency:**

Two options are available: 100 Mhz and 133 Mhz. The default setting is *100 Mhz*. You can choose the running speed for local memory, but if your memory module does not support the speed you choose, it may cause a system boot failure or data loss problem.

---

**Onboard Display Cache Setting:**

When using the onboard VGA function, you had best use the default setting.

**CAS# Latency:**

Two options are available: 2 and 3. The default setting is 3. You can select the local memory clock periods.

**Paging Mode Control:**

Two options are available: Close and Open. The default setting is *Open*. You can select the paging mode control to open or close.

**RAS-to-CAS Override:**

Two options are available: by CAS# LT and Override (2). The default setting is *by CAS# LT*. This is the display cache clock period control.

**RAS# Timing:**

Two options are available: Slow and Fast. The default setting is *Fast*. This item controls RAS# active to Protegra, and refresh to RAS# active delay (in local memory area).

---

---

**RAS# Precharge Timing:**

Two options are available: Slow and Fast. The default setting is *Fast*. This item controls RAS# precharge (in local memory area).

### 3-5. Integrated Peripherals

In this menu, you can change the onboard I/O device and other hardware peripheral settings.

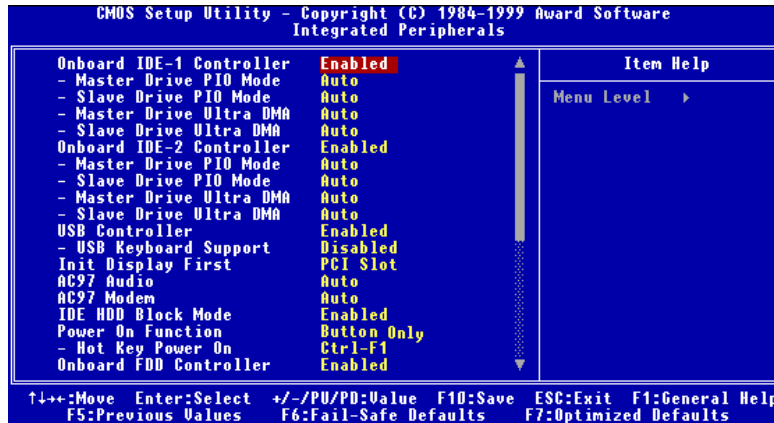

Figure 3-7. Integrated Peripherals Upper Setup Screen Shot

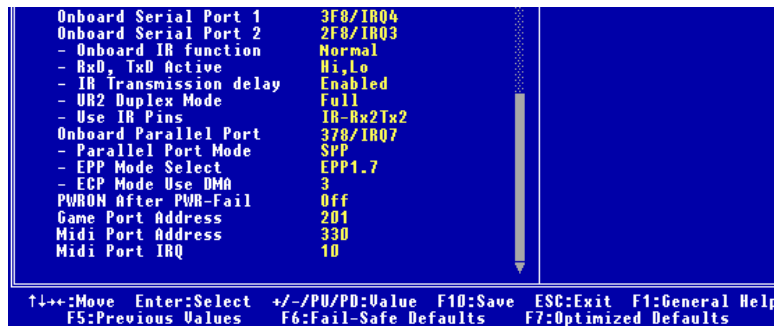

Figure 3-8. Integrated Peripherals Lower Setup Screen Shot

#### **Onboard IDE-1 Controller:**

The onboard IDE 1 controller can be set as Enabled or Disabled. The default setting is *Enabled*. The integrated peripheral controller contains an IDE interface with support for two IDE channels. If you choose *Disabled*, it will effect the settings of four items not available. For example, if you disabled the *Onboard IDE-1 Controller*, you will also disable the *Master/Slave Drive PIO Mode* and *Master/Slave Drive Ultra DMA*.

**Master/Slave Drive PIO Mode:**

Six options are available: Auto → Mode 0 → Mode 1 → Mode 2 → Mode 3 → Mode 4 → Back to Auto. The four IDE PIO (Programmed Input/Output) items let you set a PIO mode (0-4) for each of the four IDE devices that the onboard IDE interface supports. Modes 0 through 4 provide successively increased performance. In Auto mode (default setting), the system automatically determines the best mode for each device.

---

**Master/Slave Drive Ultra DMA:**

Two options are available: Auto and Disabled. The default setting is *Auto*. Ultra DMA is a DMA data transfer protocol that utilizes ATA commands and the ATA bus to allow DMA commands to transfer data at a maximum burst rate of 33 MB/sec.

Ultra DMA/33 or Ultra DMA/66 implementation is possible only if your IDE hard drive supports it and the operating environment includes a DMA driver (Windows® 95 OSR2 or a third-party IDE bus master driver).

- ▶ Auto: If your hard drive and your system software both support Ultra DMA/33, select *Auto* to enable BIOS support. For Ultra DMA/66 devices, please refer the requirements mentioned in page 2-18. (Default setting)
  - ▶ Disabled: If you encounter a problem in using Ultra DMA devices, you can try to disable this item.
- 

**Onboard IDE-2 Controller:**

Description is same as the *Onboard IDE-1 Controller*.

---

**USB Controller:**

Two options are available: Enabled and Disabled. The default setting is *Enabled*. This motherboard provide two Universal Serial Bus (USB) ports, can supports USB devices. If you don't want to use USB devices, set it to *Disabled*, then the item *USB Keyboard Support* will also be disabled.

**☞ USB Keyboard Support:**

Two options are available: Enabled and Disabled. The default setting is *Disabled*. If your system contains a USB keyboard, set it to *Enabled*.

---

---

**Init Display First:**

Two options are available: PCI Slot and Onboard. The default setting is *PCI Slot*. When you install additional PCI display cards, you can choose either a PCI display card or an onboard VGA chip to activate the display boot-up screen.

---

**AC97 Audio:**

Two options are available: Auto and Disabled. The default setting is *Auto*. If you set it to *Enabled*, it will allow the BIOS to detect audio device you use. If an audio device is detected, the onboard audio controller (810 chipset family) will be able to support it. If you want to use the other audio adapter card to connect the audio connectors, please set this item to *Disabled*.

---

**AC97 Modem:**

Two options are available: Auto and Disabled. The default setting is *Auto*. If you set it to *Enabled*, it will allow the BIOS to detect the modem device you use. If a modem device is detected, the onboard modem controller (Intel® 810 chipset family) will be able to support it. If you want to use the other modem adapter card to connect the modem signal connectors, please set this item to *Disabled*.

---

**IDE HDD Block Mode:**

Block mode is also called block transfer, multiple commands, or multiple sector read/write. If your IDE hard drive supports block mode (most new drives do), select *Enabled* for automatic detection of the optimal number of block read/writes per sector the drive can support. The default setting is *Enabled*.

---

**Power On Function:**

This item allows you to select which way you want your system to power on. Five items are available: Button Only → Keyboard 98 → Hot Key → Mouse Left → Mouse Right. Default setting is *Button Only*.

**Note**

The mouse wake up function can only be used with the PS/2 mouse, not with a mouse that uses the COM port and USB connection. *Mouse Left (Mouse Right)* means, you need to double click the mouse *left (right)* button, for the computer to power on. You also need to note the compatibility issue with your PS/2 mouse. Some PS/2 mice cannot wake up the system, because of compatibility problems. Also, if the specs of your keyboard are too old, it may fail to power on.

**☛ Hot Key Power On:**

There are twelve options available, Ctrl-F1 to Ctrl-F12. You can select this item and using the Ctrl plus the one of each function key (F1 to F12) to power on the computer. The default setting is *Ctrl-F1*.

**Onboard FDD Controller:**

Two options are available: Enabled and Disabled. The default setting is *Enabled*. You can enable or disable the onboard FDD controller.

**Onboard Serial Port 1:**

This is used to specify the I/O address and IRQ of Serial Port 1. Six options are available: Disabled → 3F8/IRQ4 → 2F8/IRQ3 → 3E8/IRQ4 → 2E8/IRQ3 → AUTO. The default setting is *3F8/IRQ4*.

**Onboard Serial Port 2:**

This is used to specify the I/O address and IRQ of Serial Port 1. Six options are available: Disabled → 3F8/IRQ4 → 2F8/IRQ3 → 3E8/IRQ4 → 2E8/IRQ3 → AUTO. The default setting is *2F8/IRQ3*.

**☛ Onboard IR Function:**

Three options are available: IrDA (HPSIR) mode → ASK IR (Amplitude Shift Keyed IR) mode → Normal. The default setting is *Normal*.

**☛ RxD , TxD Active:**

Four options are available: Hi, Hi → Hi, Lo → Lo, Hi → Lo, Lo. The default setting is *Hi, Lo*. Set IR transmission/reception polarity as High or Low.

---

**⇒ IR Transmission Delay:**

Two options are available: Enabled and Disabled. The default setting is *Enabled*. Set IR transmission delays 4 character-time (40 bit-time) when SIR is changed from RX mode to TX mode.

**⇒ UR2 Duplex Mode:**

Two options are available: Full and Half. The default setting is *Full*. This item lets you choose the operation mode for your IR KIT. Some IR device only can work at half duplex mode. Refer to your IR KIT user's guide to find out which setting is correct.

**⇒ Use IR Pins:**

Two options are available: RxD2, TxD2 and IR-Rx2Tx2. The default setting is *IR-Rx2Tx2*. If you choose *RxD2*, *TxD2*, your motherboard must support a COM port IR KIT connection. Otherwise, you can only choose the *IR-Rx2Tx2* to use the IR header on your motherboard to connect your IR KIT. Please use the default setting.

---

**Onboard Parallel Port:**

Sets the I/O address and IRQ of the onboard parallel port. Four options are available: Disable → 3BC/IRQ7 → 378/IRQ7 → 278/IRQ5. Default setting is *378/IRQ7*.

**⇒ Parallel Port Mode:**

Four options are available: SPP → EPP → ECP → ECP+EPP. The default setting is *SPP* mode.

**⇒ EPP Mode Select:**

Two options are available: EPP1.7 → EPP1.9. The default setting is *EPP 1.7*. When the mode selected for the parallel port mode is EPP, the two EPP version options are available.

**⇒ ECP Mode Use DMA:**

Two options are available: 1 → 3. The default setting is *3*. When the mode selected for the parallel port mode is ECP, the DMA channel selected can be Channel 1 or Channel 3.

---

**PWRON After PWR-Fail:**

This setting lets you set the system action after a power failure. Three options are available: On → Former-Sts → Off. The default setting is *Off*.

**Game Port Address:**

Three options are available: Disabled → 201 → 209. The default setting is 201. This item sets the address of the onboard game port connector.

---

**Midi Port Address:**

Four options are available: Disabled → 330 → 300 → 290. The default setting is 330. This item sets the address of the onboard midi port connector.

---

**Midi Port IRQ:**

Two options are available: 5 → 10. The default setting is 10. This item sets the IRQ of the onboard midi port connector. If you choose disable the *Midi Port Address*, then this field is not available.

**Note**

If you buy the audio adapter and want to replace the use of onboard audio solution, you have to disable three items in BIOS. Otherwise, your audio adapter may not working well. These three items are:

**AC 97 Audio** set to *Disabled*

**Game Port Address** set to *Disabled*

**Midi Port Address** set to *Disabled*



### 3-6. Power Management Setup Menu

The difference between Green PCs and traditional computers is that Green PCs have a power management feature. With this feature, when the computer is powered on but inactive, the power consumption is reduced in order to save energy. When the computer operates normally, it is in Normal mode. In this mode, the Power Management Program will control access to video, parallel ports, serial ports and drives, and the operating status of the keyboard, mouse and other device. These are referred to as Power Management Events. If none of these events occur, the system enters the power saving mode. When one of the controlled events occurs, the system immediately returns to normal mode and operates at its maximum speed. Power saving modes can be divided into three modes according to their power consumption: Doze Mode, Standby Mode, and Suspend Mode. The four modes proceed in the following sequence:

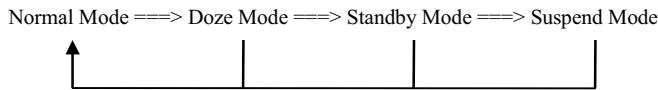

The system consumption is reduced according the following sequence:

Normal > Doze > Standby > Suspend

1. In the Main Menu, select "Power Management Setup" and press "Enter". The following screen is displayed:

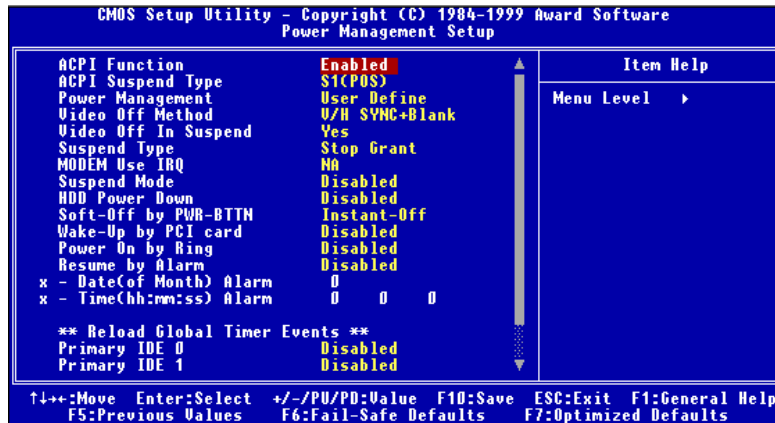

Figure 3-9. Power Management Setup Upper Screen Shot

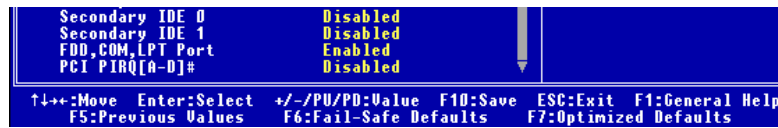

Figure 3-10. Power Management Setup Lower Screen Shot

- Use the arrow keys to go to the item you want to configure. To change the settings, use **↑**, **↓** and Enter key.
- After you have configured the power management feature, press **Esc** to go back to the Main Menu.

We are now going to briefly explain the options in this menu:

#### **ACPI Function (Advanced Configuration and Power Interface):**

ACPI gives the operating system direct control over the power management and Plug and Play functions of a computer.

There are two options that can be selected, “Enabled” and “Disabled”. You can select “Enabled” to enable ACPI functions. If you want ACPI functions to work normally, you should notice two things. One is your operating system must support ACPI, as of now only Microsoft® Windows® 98 supports these functions. The second thing is that all devices and add-on cards in your system must fully support ACPI, both hardware and software (drivers). If you want to know if your devices or add-on cards support ACPI or not, please contact the device or add-on card manufacture for more information. If you want to know more about ACPI specifications, please go to the address below for more detailed information:

<http://www.teleport.com/~acpi/acpihtml/home.htm>

**Note:** If you enable the ACPI function in the BIOS setup, the SMI function will not work.

ACPI requires an ACPI-aware operating system. ACPI features include:

- Plug and Play (including bus and device enumeration) and APM functionality normally contained in the BIOS.
- Power management control of individual devices, add-in cards (some add-in cards may require an ACPI-aware driver), video displays, and hard disk drives.
- A Soft-off feature that enables the operating system to power off the computer.
- Support for multiple wake-up events (see Table 3-6-1).
- Support for a front panel power and sleep mode switch. Table 3-6-2 describes the system states based on how long the power switch is pressed, depending on how ACPI is configured with an ACPI-aware operating system.

**Note**

If you enable the ACPI function in the BIOS setup, the SMI switch function will not work.

**System States and Power States**

Under ACPI, the operating system directs all system and device power state transitions. The operating system puts devices in and out of low-power states based on user preferences and knowledge of how devices are being used by applications. Devices that are not being used can be turned off. The operating system uses information from applications and user settings to put the system as a whole into a low-power state.

**Table 3-6-1: Wake Up Device and Events**

The table below describes which devices or specific events can wake the computer from specific states.

These device/events can wake up the computer.....	.....from this state
Power switch	Sleeping mode or power off mode
RTC alarm	Sleeping mode or power off mode
LAN	Sleeping mode or power off mode
Modem	Sleeping mode or power off mode
IR command	Sleeping mode
USB	Sleeping mode
PS/2 keyboard	Sleeping mode
PS/2 mouse	Sleeping mode

**Table 3-6-2: Effect of Pressing the Power Switch**

If the system is in this state.....	.....and the power switch is pressed for	.....the system enters this state
Off	Less than four seconds	Power on
On	More than four seconds	Soft off/Suspend
On	Less than four seconds	Fail safe power off
Sleep	Less than four seconds	Wake up

**ACPI Suspend Type:**

Two options are available: S1(POS) and S3(STR). The default setting is *S1(POS)*. Generally, ACPI has six states: System S0 state, S1, S2, S3, S4, S5. S1 and S3 states are described below:

**The S1 (POS) State (POS means Power On Suspend):**

While the system is in the S1 sleeping state, its behavior is as described below:

- The processor is not executing instructions. The processor's complex context is maintained.
- Dynamic RAM context is maintained.
- Power Resources are in a state compatible with the system S1 state. All Power Resources that supply a System Level reference of S0 are in the OFF state.
- Devices states are compatible with the current Power Resource states. Only devices which solely reference Power Resources which are in the ON state for a given device state can be in that device state. In all other cases, the device is in the D3 (off) state.
- Devices that are enabled to wake the system and that can do so from their current device state can initiate a hardware event which transitions the system state to S0. This transition causes the processor to continue execution where it left off.

To transition into the S1 state, the operating software does not have to flush the processor's cache.

**The S3 (STR) State (STR means Suspend to RAM):**

The S3 state is logically lower than the S2 state and is assumed to conserve more power. The behavior of this state is defined as follows:

- Processor is not executing instructions. The processor complex context is not maintained.
- Dynamic RAM context is maintained.
- Power Resources are in a state compatible with the system S3 state. All Power Resources that supply a System Level reference of S0, S1, or S2 are in the OFF state.
- Devices states are compatible with the current Power Resource states. Only devices which solely reference Power Resources which are in the ON state for a given device state can be in that device state. In all other cases, the device is in the D3 (off) state.
- Devices that are enabled to wake the system and that can do so from their current device state can initiate a hardware event which transitions the system state to S0. This transition causes the processor to begin execution at its boot location. The BIOS performs initialization of core functions as required to exit an S3 state and passes control to the firmware resume vector. Please see the ACPI Specification Rev. 1.0 book section 9.3.2 for more details on BIOS initialization.

From the software point of view, this state is functionally the same as the S2 state. The operational difference can be that some Power Resources that could be left ON in the S2 state might not be available to the S3 state. As such, additional devices can be required to be in logically lower D0, D1, D2, or D3 state for S3 than S2. Similarly, some device wake events can function in S2 but not S3.

Because the processor context can be lost while in the S3 state, the transition to the S3 state requires that the operating software flush all dirty cache to DRAM.

**\* Above information for system S0 & S3 were refer to ACPI Specification Rev. 1.0.**

---

### **Power Management:**

This item allows you to select the type (or degree) of power saving and is directly related to the following modes:

1. Suspend Mode
2. HDD Power Down

There are three options for power management, three of which have fixed mode settings:

➤ **User Define**

“User Define” defines the delay for accessing the power modes.

Suspend Mode: Disabled ➔ 1 Min ➔ 2 Min ➔ 4 Min ➔ 8 Min ➔ 12 Min ➔ 20 Min ➔ 30 Min ➔ 40 Min ➔ 1 Hour. The default setting is *Disabled*.

HDD Power Down: Disabled ➔ 1 Min ➔ 2 Min ➔ 3 Min ➔ 4 Min ➔ 5 Min ➔ 6 Min ➔ 7 Min ➔ 8 Min ➔ 9 Hour ➔ 10 Min ➔ 11 Min ➔ 12 Min ➔ 13 Min ➔ 14 Min ➔ 15 Min. The default setting is *Disabled*.

➤ **Min Saving**

When these two saving modes are enabled, the system is set up for minimum power savings.

Suspend Mode = 1 Hour

HDD Power Down = 15 Min

➤ **Max Saving**

When the two saving modes are enabled, the system is set up for maximum power savings.

Suspend Mode = 1 Min

HDD Power Down = 1 Min

**Video Off Method:**

Three video off methods are available: "Blank Screen", "V/H SYNC + Blank" and "DPMS". The default is " *V/H SYNC + Blank* ".

If this setting does not shut off the screen, select "Blank Screen". If your monitor and video card support DMPS standard, select "DPMS".

**Blank Screen:** This option only writes blanks to the video buffer.

**V/H SYNC + Blank:** This selection will cause the system to turn off the vertical and horizontal synchronization ports and write blanks to the video buffer.

**DPMS:** Initial display power management signaling.

**Video Off In Suspend:**

Two options are available: Yes or No. The default setting is *Yes*. This item determines the manner in which the monitor is blanked.

**Suspend Type:**

Two options are available: Stop Grant and PwrOn Suspend. The default setting is *Stop Grant*.

**Modem Use IRQ:**

You can specify the IRQ for modem use. Eight options are available: N/A → 3 → 4 → 5 → 7 → 9 → 10 → 11. The default setting is *N/A*.

**Suspend Mode/HDD Power Down:**

These two items will be enable to change setting when item *Power Management* is set to *User Define*, these two item will also changes as table 3-6-3 below.

**Table 3-6-3: Power Management Settings**

Items	Power Management Settings		
	User Define	Min Saving	Max Saving
Suspend Mode	Disabled → 1 Min → 2 Min → 4 Min → 8 Min → 12 Min → 20 Min → 30 Min → 40 Min → 1 Hour. The default setting is <i>Disabled</i> .	1 Hour	1 Min

<b>HDD Power Down</b>	Disabled → 1 Min → 2 Min → 3 Min → 4 Min → 5 Min → 6 Min → 7 Min → 8 Min → 9 Hour → 10 Min → 11 Min → 12 Min → 13 Min → 14 Min → 15 Min. The default setting is <i>Disabled</i> .	15 Min	1 Min
-----------------------	---	--------	-------

**Soft-Off by PWR-BTTN:**

Two options are available: Instant-Off and Delay 4 Sec.. The default setting is *Instant-Off*. Pressing the power button for more than four seconds forces the system to enter the Soft-Off state when the system has "hung".

**Wake-Up by PCI card:**

Two options are available: Enabled and Disabled. Default setting is *Disabled*. This item can let you wake-up your computer by PCI devices. For instance, if you had installed a PCI LAN card with Wake-Up on LAN capability, then you could wake-up your computer from another computer via a network by sending a wake-up frame signal. This feature also allows the PCI card built-in hardware function to support the wake up function without special cables connected to the motherboard.

**Note**

This feature needs a specific network interface, this is optional. Also your ATX power supply +5V standby power must with at least 720mA capability.

**Power On by Ring:**

Two options are available: Enabled and Disabled. Default setting is *Disabled*. If you connect an external modem to the onboard serial port, the system will be turned on when a telephone ring-up occurs.

**Resume by Alarm:**

Two options are available: Enabled and Disabled. Default setting is *Disabled*. The RTC alarm can turn on the system. You can set Date (of month) and Time (hour, minute, and second) when you set this item to *Enabled*.

**Reload Global Timer Events**

When one of the specified events occur, the count down made for entry in power saving mode goes back to zero. Since the computer will enter a power saving mode only after an inactivity delay specified (time specific for Doze, Standby and Suspend modes) and after it has no activity, during this time period, any event will cause the computer to re-count the time elapsed. Resume events are operations or signals that cause the computer to resume time counting.

**► Primary IDE 0/Primary IDE 1:**

Two options are available: Enabled and Disabled. The default setting is *Disabled*. If any primary IDE master/slave I/O activity occurs, it will cause the computer to re-count the time elapsed.

**► Secondary IDE 0/Secondary 1:**

Two options are available: Enabled and Disabled. Default setting is *Disabled*. If any secondary IDE master/slave I/O activity occurs, it will cause the computer to re-count the time elapsed.

**► FDD, COM, LPT Port:**

Two options are available: Enabled and Disabled. Default setting is *Enabled*. If any floppy disk, COM ports and Parallel port I/O activity occurs, it will cause the computer to re-count the time elapsed.

**► PCI PIRO[A-D]#:**

Two options are available: Enabled and Disabled. Default setting is *Disabled*. If any INTA~INTD signal activity occurs, it will cause the computer to re-count the time elapsed.



### 3-7. PnP/PCI Configurations

This section describes configuring the PCI bus system. PCI, or Personal Computer Interconnect, is a system which allows I/O devices to operate at speeds nearing the speed the CPU itself uses when communicating with its own special components. This section covers some very technical items and it is strongly recommended that only experienced users should make any changes to the default settings.

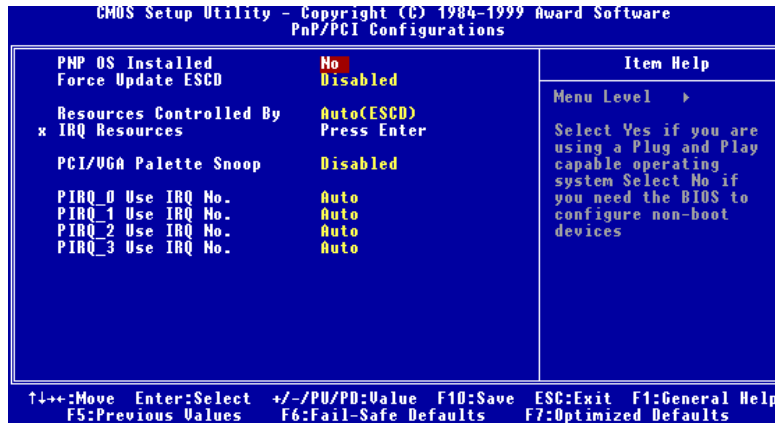

Figure 3-11. PnP/PCI Configurations Setup Screen Shot

**PNP OS Installed:**

Two options are available: No and Yes. Default setting is *No*. Device resource assigned by PnP OS or BIOS.

**Force Update ESCD:**

If you want to clear ESCD data next time you boot up, and ask the BIOS to reset the settings for the Plug & Play ISA Card and the PCI Card, select Enabled. But the next time you boot up, this option will automatically be set as Disabled.

**Computer Knowledge: ESCD (Extended System Configuration Data)**

The ESCD contains the IRQ, DMA, I/O port, memory information of the system. This is a specification and a feature specific to the Plug & Play BIOS.

**Resources Controlled By:**

Two options are available: Auto(ESCD) and Manual. Default setting is *Auto(ESCD)*. When the setting is Auto(ESCD), the *IRQ Resources* and *Memory Resources* can not be changed. When resources are controlled manually, the *IRQ Resources* and *Memory Resources* can then be changed.

*Legacy ISA* devices compliant with the original PC AT bus specification, requiring a specific interrupt (such as IRQ4 for serial port 1).

*PCI/ISA PnP* devices compliant with the Plug and Play standard, whether designed for the PCI or ISA bus architecture.

The Award Plug and Play BIOS has the capability to automatically configure all of the boot and Plug and Play compatible devices. If you select *Auto (ESCD)*, The IRQ Resources item will be disabled, as the BIOS automatically assigns them. But if you have trouble in assigning the interrupt resources automatically, you can select *Manual* to set which IRQ and DMA are assigned to PCI/ISA PnP or legacy ISA cards.

Figure 3-12 shows you the screen of IRQ resources. Each item has two options: PCI/ISA PnP and Legacy ISA. The default setting is *PCI/ISA PnP*.

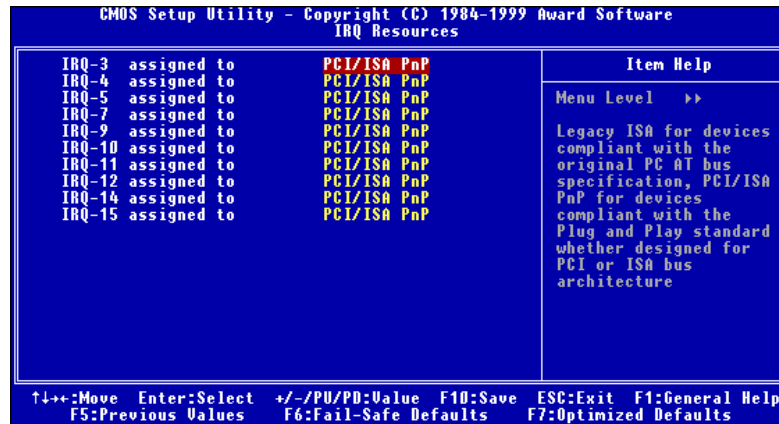

Figure 3-12. PnP/PCI Configurations - IRQ Resources Setup Screen Shot

**PCI/VGA Palette Snoop:**

This option allows the BIOS to preview VGA Status, and to modify the information delivered from the Feature Connector of the VGA card to the MPEG Card. This option can solve the display inversion to black after you have used the MPEG card.

**PIRQ\_0~PIRQ3:**

Eleven options are available: Auto, 3, 4, 5, 7, 9, 10, 11, 12, 14, 15. Default setting is *Auto*. This item allows the system to automatically specify the IRQ number for the device installed on PCI slots. Which means, the system can specify the fixed IRQ number for the device installed on the PCI slots (PCI slot 1 to PCI slot 5). This is a useful function when you want to fix the IRQ for a specific device.

For example, if you want to move your hard disk to another computer and don't want to re-install Windows® NT, then you can specify the IRQ for the device installed on the new computer to fit the original computer settings.

**Note**

If you specify the IRQ in this item, then you cannot specify the same IRQ to the ISA bus, otherwise, it will cause a hardware conflict.

This feature is for the operating system which will record and fix the PCI configuration status, if you want to change it.

For the relations between the hardware layout of PIRQ (the signals from the 810 chipset), INT# (means PCI slot IRQ signals) and devices, please refer to the table below:

Signals	PCI slot 1	PCI slot 2	PCI slot 3	PCI slot 4 PCI slot 5
PIRQ_0	INT A	INT B	INT C	INT D
PIRQ_1	INT B	INT C	INT D	INT A
PIRQ_2	INT C	INT D	INT A	INT B
PIRQ_3	INT D	INT A	INT B	INT C

- Each PCI slot has four INT#s (INT A~INT D).

### 3-8. PC Health Status

You can set the warning and shutdown temperatures for your computer system, and you can check the fan speeds and power supply voltages of your computer system. The features are useful for monitoring all the important parameters within your computer system. We call it the *PC Health Status*.

CMOS Setup Utility - Copyright (C) 1984-1999 AWARD SOFTWARE		Item Help
PC Health Status		Menu Level
Temperature Warning	75°C/167°F	
CPU Temperature	60°C/140°F	
System Temperature 1	60°C/140°F	
System Temperature 2	0°C/ 32°F	
CPU Fan Speed	4500 RPM	
Chassis Fan Speed	0 RPM	
Vcore	1.98 V	
Vtt	1.53 V	
Vio	3.39 V	
+ 5 V	5.05 V	
+12 V	12.16 V	
-12 V	-12.28 V	
- 5 V	- 4.99 V	
UBAT(V)	1.29 V	

↑↓:Move Enter:Select +/-/PU/PD=Value F10:Save ESC:Exit F1:General Help  
F5:Previous Values F6:Fail-Safe Defaults F7:Optimized Defaults

Figure 3-13. PC Health Status Screen Shot

#### Temperature Warning:

This item lets you select the temperature at which you want the system to send out a warning message to the PC speakers of when the temperature goes beyond either limit. You can select the temperatures you want. The ranges are from 30°C / 86°F to 120°C / 248°F, default setting is 75°C / 167°F.

#### All Voltages, Fans Speed and Thermal Monitoring:

These items list the current states of the CPU and environment (using RT1 and RT2 to detect them.) temperatures as well as fan speeds (CPU fan and chassis fan). It can not be changed by the user.

The following items list the voltage states of the system power. It is also unchangeable.

**Note**

The hardware monitoring features for temperatures, fans and voltages will occupy the I/O address from 294H to 297H. If you have a network adapter, sound card or other add-on cards that might use those I/O addresses, please adjust your add-on card I/O address, to avoid the use of those addresses.

### 3-9. Load Fail-Safe Defaults

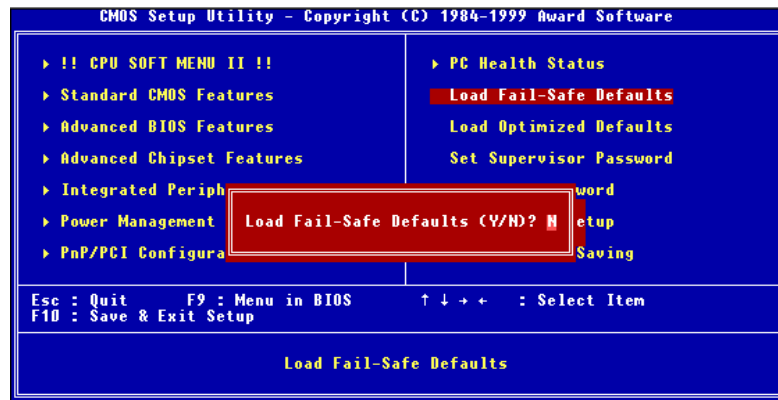

Figure 3-14. Load Fail-Safe Defaults Screen Shot

When you press <Enter> on this item you get a confirmation dialog box with a message similar to:

Load Fail-Safe Defaults (Y/N) ? **N**

Pressing 'Y' loads the BIOS default values for the most stable, minimal-performance system operations.

### 3-10. Load Optimized Defaults

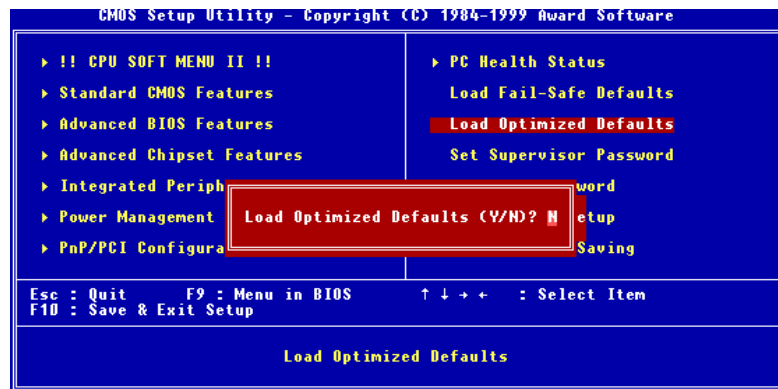

Figure 3-15. Load Optimized Defaults Screen Shot

When you press <Enter> on this item you get a confirmation dialog box with a message similar to:

**Load Optimized Defaults (Y/N) ? N**

Pressing 'Y' loads the default values that are factory settings for optimal performance system operations.

### 3-11. Set Supervisor Password / Set User Password

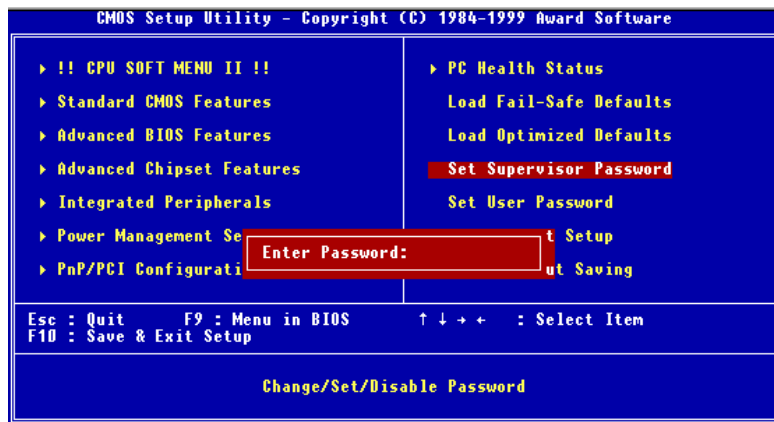
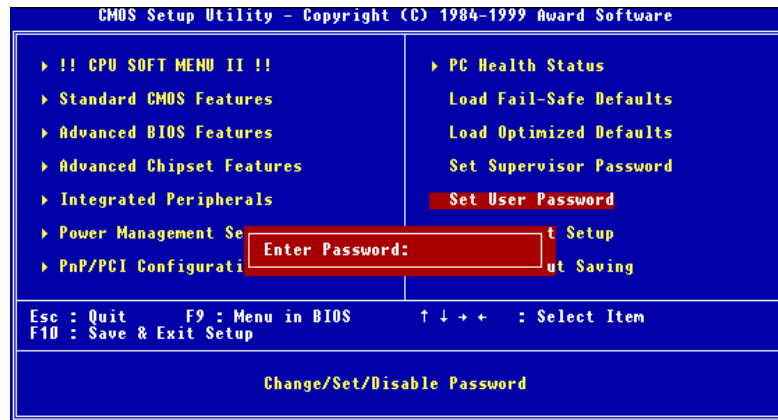

Figure 3-16. Set Supervisor Password Screen Shot

You can set either supervisor or user password, or both of them. The differences between are:

**Supervisor Password:** Can enter and change the options of the setup menus.



**Figure 3-17. Set User Password Screen Shot**

**User Password:** Can enter but do not have the right to change the options of the setup menus. When you select this function, the following message will appear at the center of the screen to assist you in creating a password.

**ENTER PASSWORD:**

Type the password, up to eight characters in length, and press <Enter>. The password typed now will clear any previously entered password from CMOS memory. You will be asked to confirm the password. Type the password again and press <Enter>. You may also press <Esc> to abort the selection and not enter a password.

To disable a password, just press <Enter> when you are prompted to enter the password. A message will confirm the password will be disabled. Once the password is disabled, the system will boot and you can enter Setup freely.

**PASSWORD DISABLED.**

When a password has been enabled, you will be prompted to enter it every time you try to enter Setup. This prevents an unauthorized person from changing any part of your system configuration.

Additionally, when a password is enabled, you can also require the BIOS to request a password every time your system is rebooted. This would prevent unauthorized use of your computer.



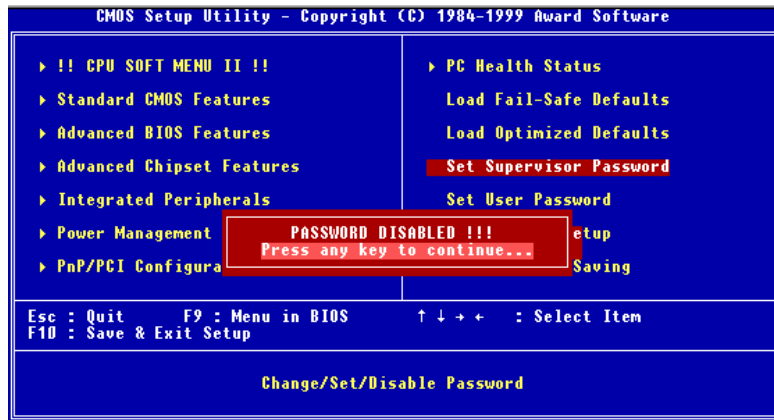

Figure 3-18. Password Disabled Screen Shot

You determine when the password is required within the BIOS Features Setup Menu and its Security option. If the Security option is set to “System”, the password will be required both at boot and at entry to Setup. If set to “Setup”, prompting only occurs when trying to enter Setup.

### 3-12. Save & Exit Setup

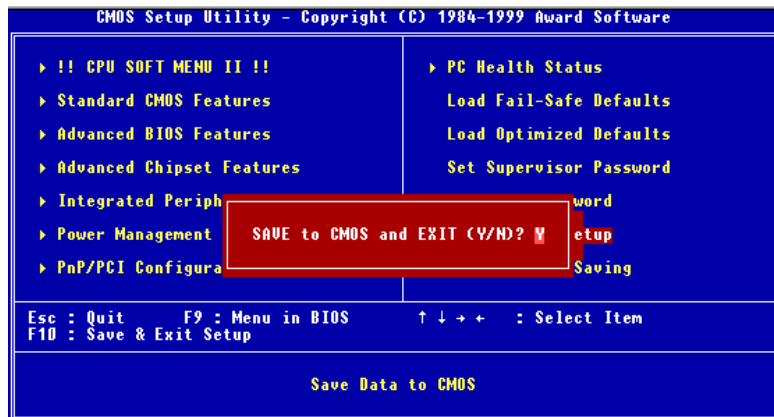

Figure 3-19. Save &amp; Exit Setup Screen Shot

Pressing <Enter> on this item asks for confirmation:

**Save to CMOS and EXIT (Y/N)? **Y****

Pressing “Y” stores the selections made in the menus in CMOS - a special section of memory that stays on after you turn your system off. The next time you boot your computer, the BIOS configures your system according to the Setup selections stored in CMOS. After saving the values the system is restarted again.

### 3-13. Exit Without Saving

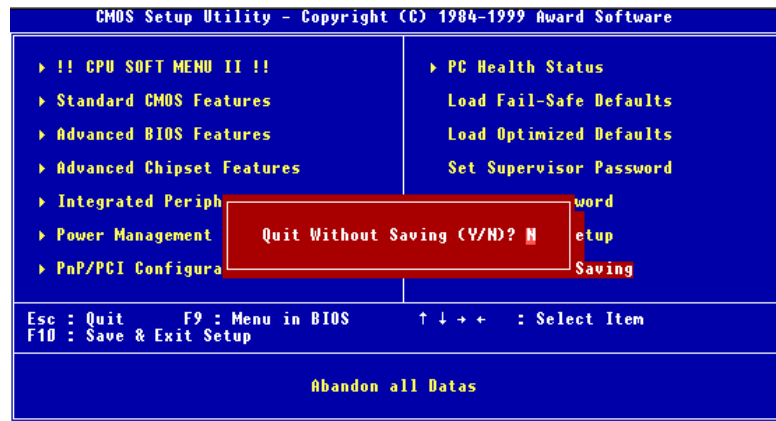

Figure 3-20. Exit Without Saving Screen Shot

Pressing <Enter> on this item asks for confirmation:

**Quit without saving (Y/N)? **Y****

This allows you to exit Setup without storing in CMOS any change. The previous selections remain in effect. This exits the Setup utility and restarts your computer.

## Appendix A IDE & USB Drivers Installation for Windows® 98 SE

After you've installed Windows® 98, you need to install the drivers for your IDE & USB devices. We will tell you step by step in the following section how to do this.

### Note A-1

You have to install the IDE & USB drivers before you install the VGA and audio drivers. After installing Windows the quality of your display will be poor because it will be set to 640\*480 and 16 color. For the best screen capture quality, install the VGA drivers and set the desktop to 800\*600 using True Color.

### Note A-2

Details of the Windows® 98 SE operating system will not be mentioned in this manual. If you have any problems with Windows® 98 SE installation, operations and settings, please refer to your Windows® 98 SE user's manual or other databases provided by Microsoft® Corporation.

First, check System Properties → Device Manager → Hard Disk Controller, you will see a device called "Intel 82801AA Bus Master IDE Controller". Also, check the item "Other Devices" you will find in the item "? Unknown Device" shows up.

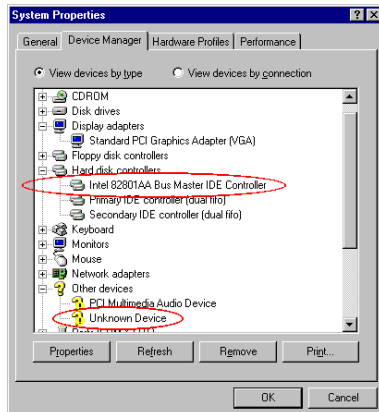

Exit the Device manager and insert the WX6 CD-Title into your CD-ROM drive. It should execute the program automatically. If not, you can go to the CD location and execute the execution file from the main directory of this CD-Title. After it is executed, the screen below will appear.

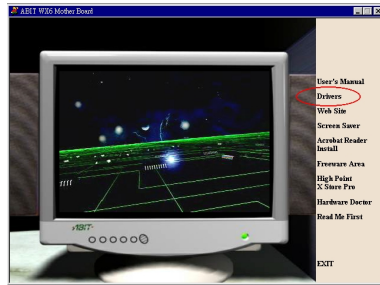

Move the cursor to "Drivers" and click on it. You will go to the next screen.



Move the cursor to "Intel 810 IDE-USB Driver" and click on it. Go to the next screen.



Move the cursor to "INF Installer For 95/98 Start Installation" and click on it. Go to the next screen.

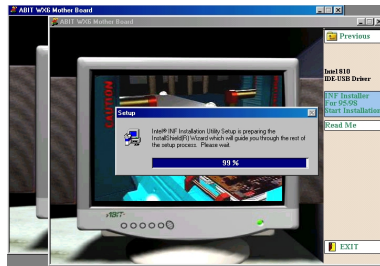

Now you will see the install shield loading.

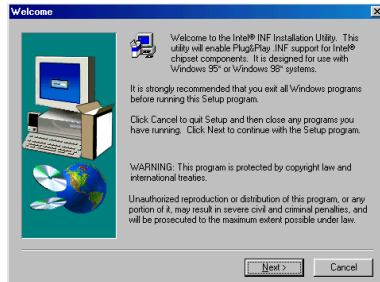

The "Welcome" screen and its dialogue box will appear. Click "Next" to go on.

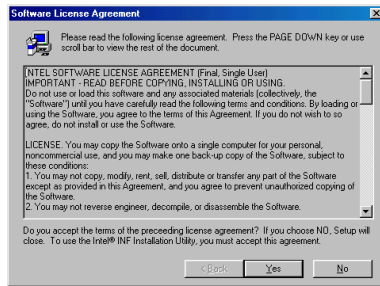

The License screen will show up. Read it and click the "Yes" to go on.

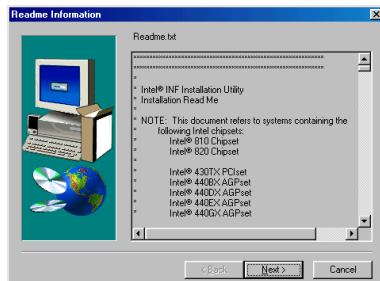

This screen will show you the Readme.txt information of this INF installation utility. When you have read it all, click "Next".

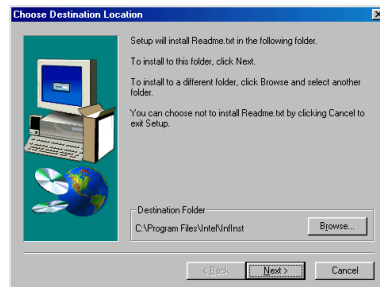

Now you can choose the folder for the destination location you want to install the drivers. We suggest you use the default folder as the destination location. After checking the folder click "Next".

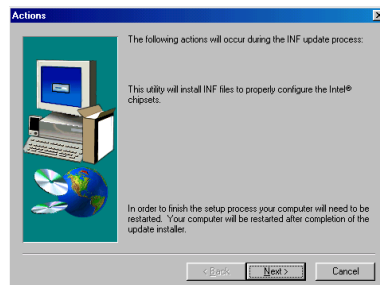

Now you are ready to start installation of the INF. To start the INF update processing, click the "Next".

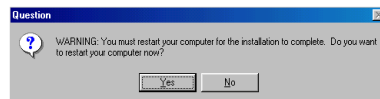

When installation is complete, the installer will ask you to restart your computer. We suggestion you click "Yes" to restart your computer to finish the system INF updating.

When your computer system restarts, will see Windows® 98 SE start the updating process and several new hardware devices will be found and updated. When restarting Windows® 98 SE, the CD-ROM drives will fail to be found in the updating process. If the prompt dialogue box asks you to put the Windows® 98 SE CD into the CD-ROM drive, just ignore this message and let it go to the next process. If the prompt dialogue box tells you that it can not find \*.cat file, you can select the path to "windows\catroot".

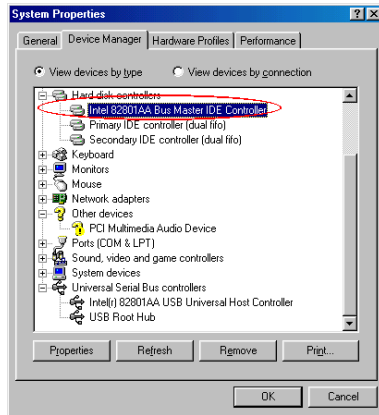

Then go to check the System Properties → Device Manager → Hard Disk Controller, you can see the device item "Intel 82801AA Bus Master IDE Controller" still not changed.

Therefore, you need to manually change the setting of this item. Click the cursor on the item "Intel 82801AA Bus Master IDE Controller", then move the cursor to the "Properties" button and click on it.



Choose "Driver" folder then choose "Update Driver..." button and click on it.



The "Update Device Driver Wizard" will show up, click the "Next" button to continue.

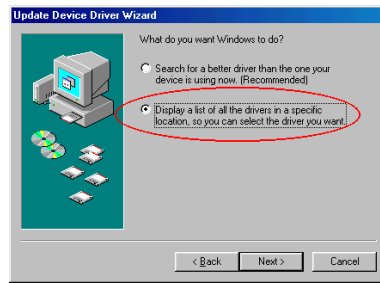

Choose the second item then click the "Next" button to go on.

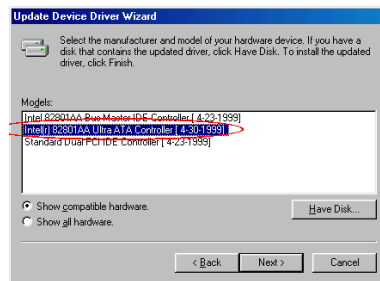

Choose the second item "Intel [r] 82801AA Ultra ATA Controller [4-30-1999]" then move the cursor to the "Next" button and click on it.

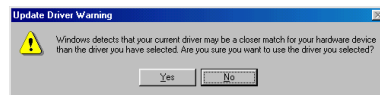

The system will ask if you really want to use the driver you selected. Click the "Yes".



The system will show the install path for INF file. Click the "Next" and then the system will start the updating action.



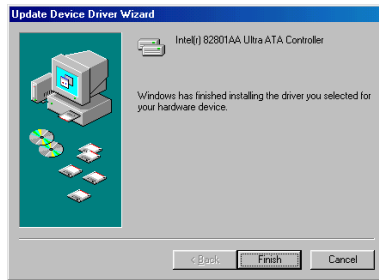

When update action finish, will show this screen. Click the "Finish" button.

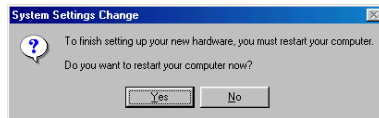

System will ask you if you want to restart your computer or not? Click the "Yes" button to restart your computer.

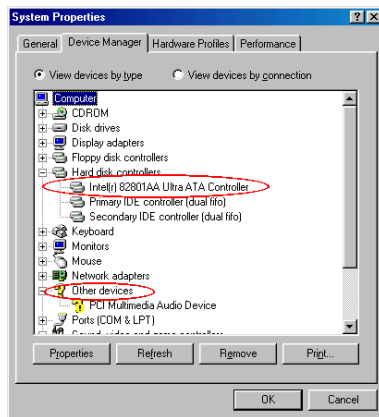

When your computer restarts and enters Windows again, go to check the System Properties → Device Manager → Hard Disk Controller. You should see the device changed to " Intel [r] 82801AA Ultra ATA Controller ". Also, check the item "Other Devices". You will find out that the item " ? Unknown Device" has disappeared. After you confirm this has changed, the update process is fully complete.

**This Page Is Intentionally Blank**

## Appendix B Installing the VGA Driver for Windows® 98 SE

Now we will show you how to install the VGA drive to your Windows® 98 SE operating system in this section.

### Note B-1

You have to install the IDE & USB drivers before you install the VGA and audio drivers. After installing Windows the quality of your display will be poor because it will be set to 640\*480 and 16 color. For the best screen capture quality, install the VGA drivers and set the desktop to 800\*600 using True Color.

### Note B-2

Details of the Windows® 98 SE operating system will not be mentioned in this manual. If you have any problems with Windows® 98 SE installation, operations and settings, please refer to your Windows® 98 SE user's manual or other databases provided by Microsoft® Corporation.

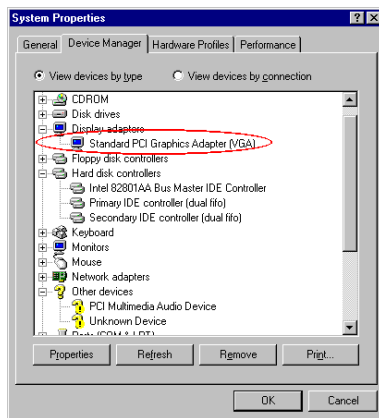

First, go to check the System Properties → Device Manager → Display Adapters,. Your system now shows the "Standard PCI Graphics Adapter [VGA]".

Exit the device manager and insert the WX6 CD-Title into your CD-ROM drive, it should execute the program automatically. If not, you can go to the CD location and execute the execution file at the main directory of this CD-Title. After it has been executed you will see the screen below. Move the cursor to the "Drivers" and click on it. This will take you to the next screen.

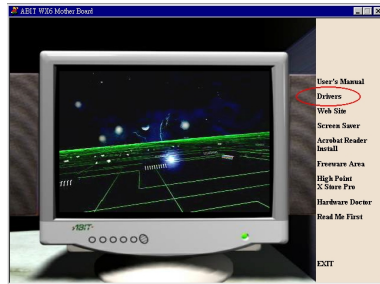

Move the cursor to "Drivers" and click on it. You will go to the next screen.

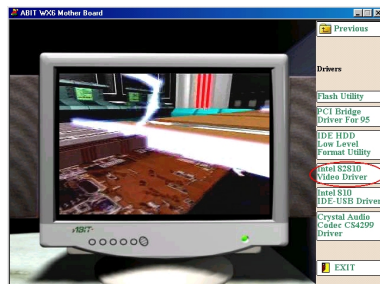

Move the cursor to "Intel 82810 Video Driver" and click on it. Go to the next screen.



Move the cursor to "For Windows 95/98 Start Installation" and click on it. Go to the next screen.

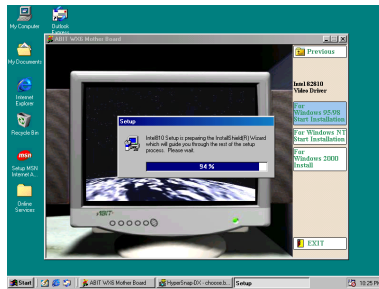

Now you will see the install shield loading.

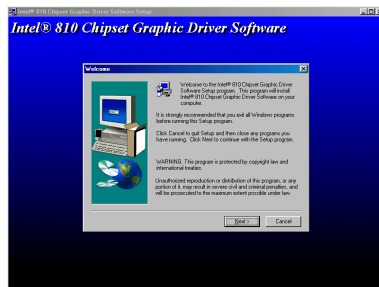

You will now see the welcome screen and its dialogue box. Click "Next" to go on.

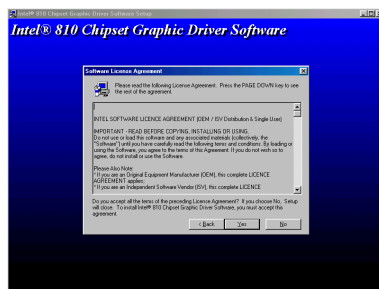

The License screen will appear. Click the "Yes" button to go on.

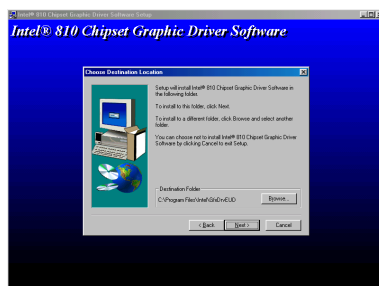

Now you can choose the folder for the destination location you want to install the driver. We suggest you use the default folder as the destination location. When you have made sure of the folder, click "Next".

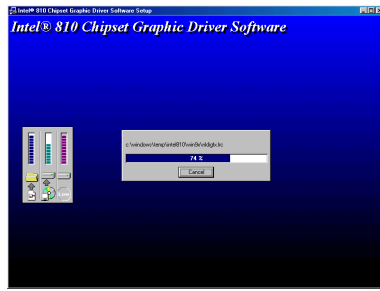

Now the system will install the VGA drivers. While doing so, the percentage of the driver installed will be displayed on the screen.

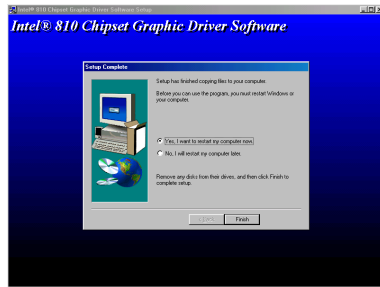

When the installation is complete, please choose the item: "Yes, I want to restart my computer now" and then click the "Finish" button.

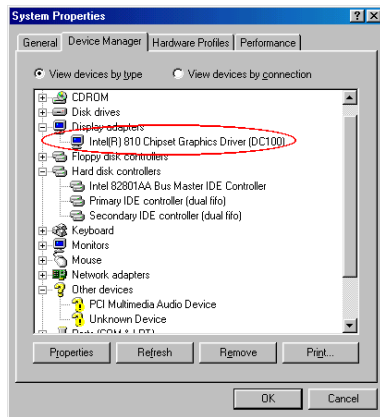

When the computer restarts and enters Windows, check System Properties → Device Manager → Display Adapters. You should see the device changed to "Intel [R] 810 Chipset Graphics Driver [DC100]". After you confirm this change, the update process is now fully complete. You can now choose the desktop size and resolution you want now.

## Appendix C Installing the Audio Driver for Windows® 98 SE

We will show you how to install the audio drivers for Windows® 98 SE operating system.

### Note C-1

Details of the Windows® 98 SE operating system will not be mentioned in this manual. If you have any problems with Windows® 98 SE installation, operations and settings, please refer to your Windows® 98 SE user's manual or other databases provided by Microsoft® Corporation.

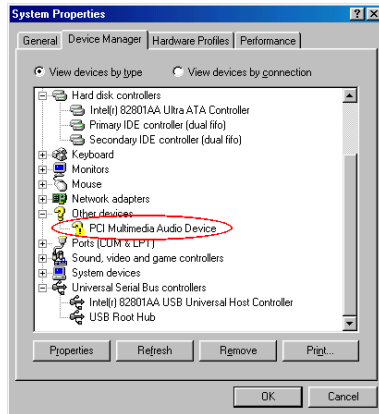

First check System Properties → Device Manager → Other Devices. Your system should now show " ? PCI Multimedia Audio Device".

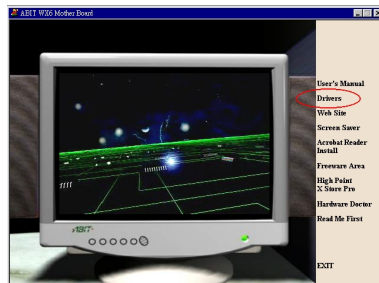

Exit the Device Manager and insert the WX6 CD-Title into your CD-ROM drive. It should execute the program automatically. If not, you can go to the CD location and execute the execution file from the main directory of this CD-Title. Once executed, you will see the screen below.

Move the cursor to "Drivers" and click on it. This will bring you to the next screen.

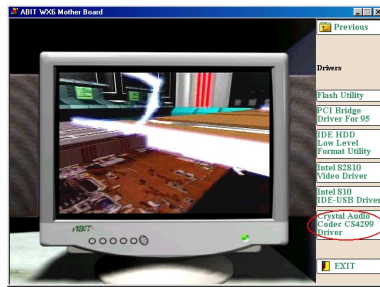

Move the cursor to "Crystal Audio Codec CS4299 Driver" and click on it. Go to the next screen.

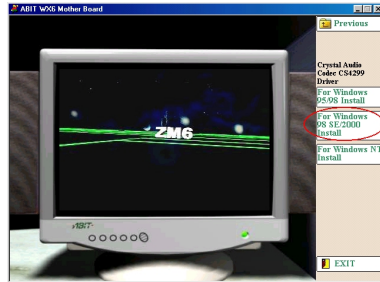

Move the cursor to "For Windows 98 SE/2000 Install" and click on it. Go to the next screen.

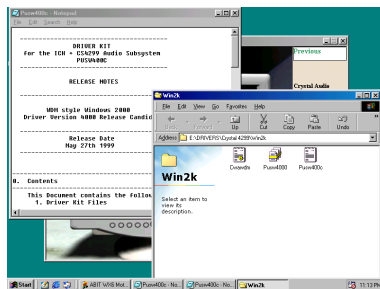

It will show you the two folders, one is "Release Notes", one is the drivers location in the WX6 CD-ROM. Read the notes and write down the location of drives on a piece of paper, then go to the next step.



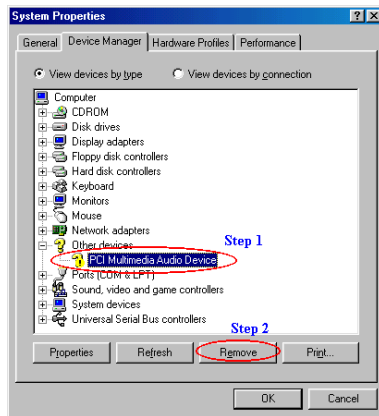

Go to the "System Properties" again, choose the "Device Manager". Choose the item "PCI Multimedia Audio Device". Then click the "Remove" button.



"Confirm Device Removal" message shows up, click the "OK" button.

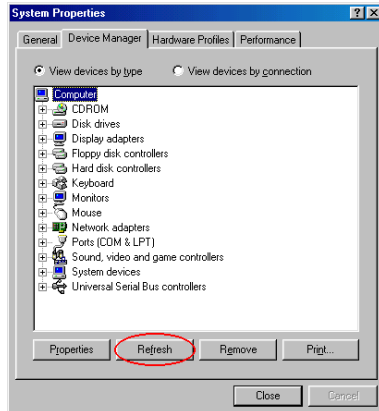

Now you can check the "PCI Multimedia Audio Device" already removed. Now you can move the cursor to the "Refresh" button, and click on it.



The wizard will search the new drivers for the PCI multimedia audio device. Click the "Next" button to go on.

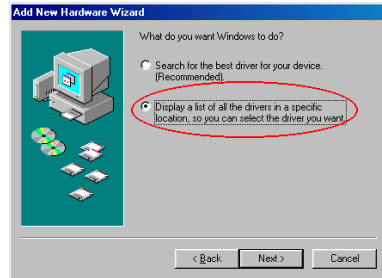

Select the second item and click the "Next" button to go on.

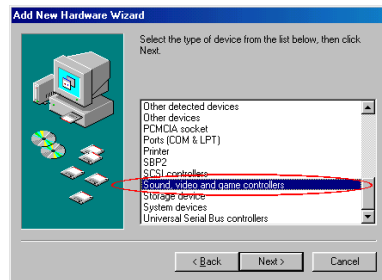

Choose the item "Sound video and game controllers" then click the "Next" button.

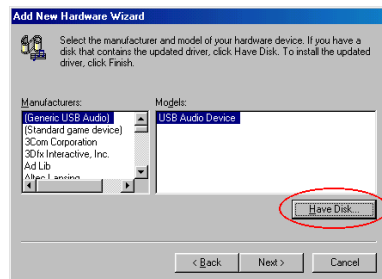

Click the "Have Disk..." button.

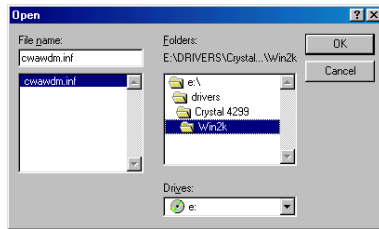

Choose the path from the WX6 CD-Title as "Drivers\Crystal 4299\Win2K". The device code name of the CD-ROM drive will depend on how many devices are installed on your computer system. Here it is shown as e:\.

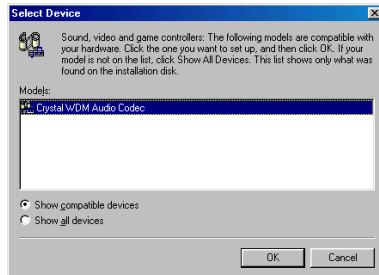

Your system will find the "Crystal WDM Audio Codec". Choose this item first then click the "OK" button.



Windows is now ready to install the selected driver of this device. Click the "Next" button.



Windows will ask you to insert the Windows® 98 SE CD-ROM into your CD-ROM drive. When this is done, click the "OK" button to go on.

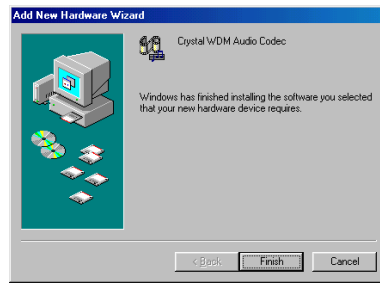

Windows has now completed the installation process. Click the "Finish" button to restart your computer.

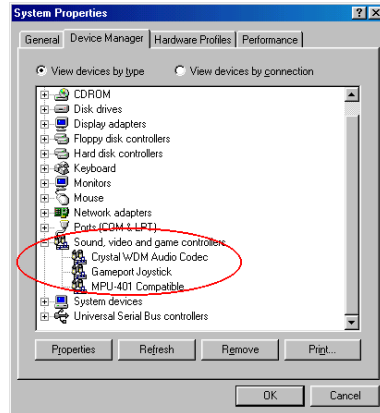

Once Windows has restarted, go to "System Properties" to double check. You should find the "? PCI Multimedia Audio Device" has disappeared, and Crystal WDM audio Codec is there instead.

---

## Appendix D Installing the VGA Drivers for the Windows® NT 4.0 Server / Workstation

---

In this section we will show you how to install the VGA drives to your Windows® NT 4.0 Server/Workstation operating system. All screen shots are from Windows® NT 4.0 server version. Before you install the VGA drivers, please install Windows® NT 4.0 Service Pack 4 (or latest version) first. Then you can install the VGA drivers.

### Note D-1

Details of the Windows® NT 4.0 Server/Workstation operating system are not mentioned in this manual. If you have any problems with the settings, operating or installing Windows® NT 4.0 Server/Workstation, please refer to your Windows® NT 4.0 Server/Workstation user's manual or other databases provided by Microsoft® Corporation.

### Note D-2

For Windows® NT 4.0 Server/Workstation operating system, you don't need to install the IDE-USB drivers. But you have to install the Windows® NT 4.0 Service Pack 4 (or latest version) first.

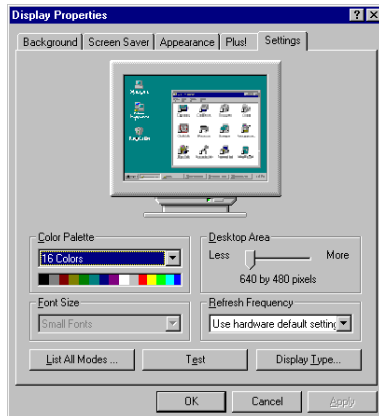

Go to check your "Display Properties". You will see the color palette is only set to 16 colors.

Leave "Display Properties" and insert the WX6 CD-Title into your CD-ROM drive. It should execute the program automatically. If not, you can go to the CD location and execute the execution file from the main directory of this CD-Title. After it is executed, you will see the screen below.

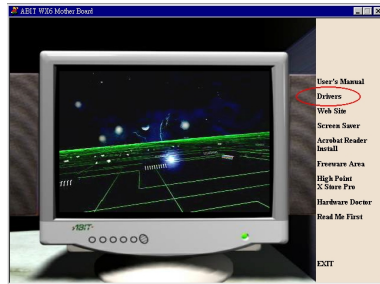

Move the cursor to "Drivers" and click on it. This will bring you to the next screen.

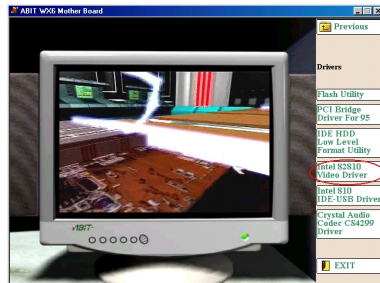

Move the cursor to "Intel 82810 Video Driver" and click on it. Go to the next screen.



Move the cursor to "For Windows NT Start Installation" and click on it. Go to the next screen.

You will now see the install shield is loading.



The "Welcome screen" and its dialogue box will appear. Click the "Next" button to go on.

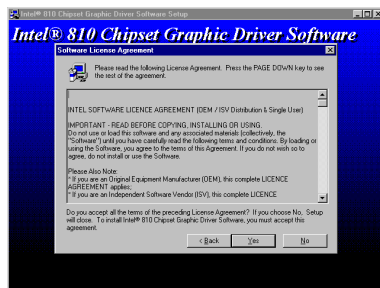

The License screen will appear next. Click the "Yes" button to continue.



Now you can choose the folder for the destination location you want. We suggest you use the default folder as the destination location. When you are sure of the folder, click "Next".

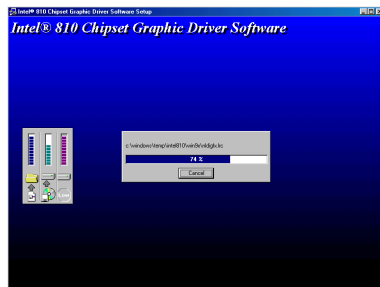

The system will now start to install the VGA drivers. While doing so, it will display the percentage installed on the screen.

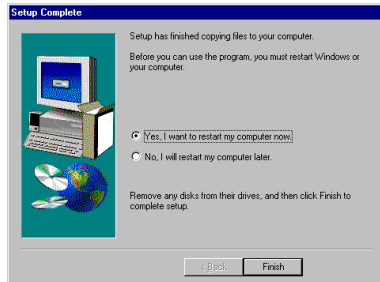

When installation is complete please choose the item: "Yes, I want to restart my computer now". Then click the "Finish" button to restart your computer.



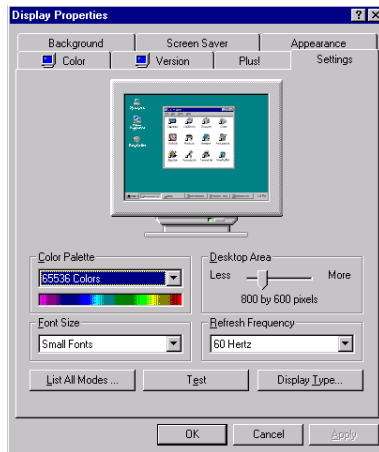

Go to check your "Display Properties" again. You will see the color palette is now set to 65536 colors.

Also the "Display Properties" will have two new folders "Color" and "Version" that let you adjust the additional display parameters.

**This Page Is Intentionally Blank**

## Appendix E Installing the Audio Drivers for the Windows® NT 4.0 Server / Workstation

In this section we will show you how to install the audio drives to your Windows® NT 4.0 Server/Workstation operating system. All screen shot are from Windows® NT 4.0 server version. Before you install the audio drivers, please install Windows® NT 4.0 Service Pack 4 (or the latest version) first. Then you can install the audio drivers.

### Note E-1

Details of the Windows® NT 4.0 Server/Workstation operating system are not mentioned in this manual. If you have any problems with the settings, operating or installing Windows® NT 4.0 Server/Workstation, please refer to your Windows® NT 4.0 Server/Workstation user's manual or other databases provided by Microsoft® Corporation.

### Note E-2

For Windows® NT 4.0 Server/Workstation operating system, you don't need to install the IDE-USB drivers. But you have to install the Windows® NT 4.0 Service Pack 4 (or latest version) first.

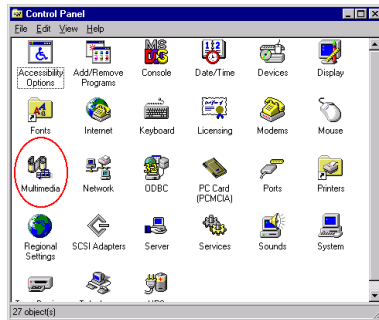

First you need go to the "Control Panel" and double click the item "Multimedia".

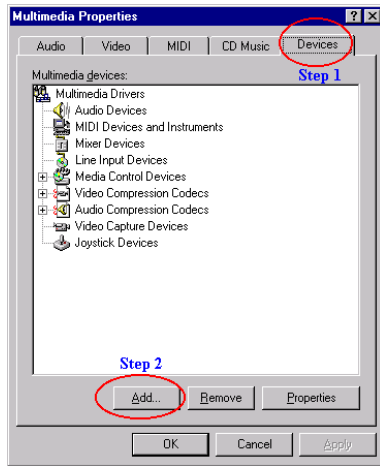

Choose the "Devices" folder then click the "Add..." button.

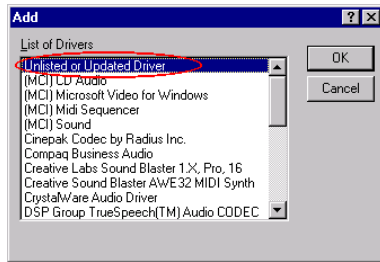

Then choose the "Unlisted or Updated Driver" and click the "OK" button.

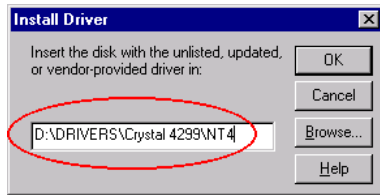

You have to specify and manually type the path of driver location. We've put the audio drivers under the "DRIVERS\Crystal 4299\NT4". The code name of the CD-ROM drive will depend on how many devices installed on your computer system. Here it is shown as D:\.

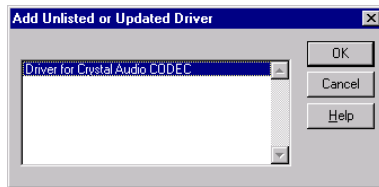

When Windows finds the driver you can choose the item "Driver for Crystal Audio CODEC" and click "OK" button.

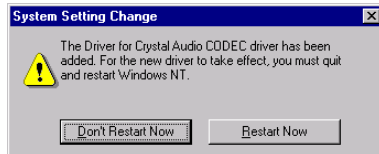

The screen shows the "System Setting Change" message. You need to restart your computer to complete the updating process. Click the "Restart Now" button to restart your computer.

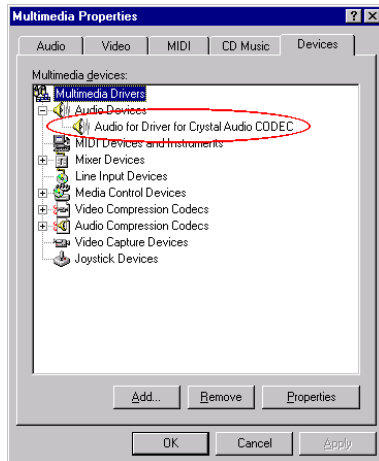

When Windows® NT restarts, check the "Multimedia Properties" again. You will see the Crystal audio CODEC had been identify.

#### Note E-3

For other device driver or utility installation under Windows® NT 4.0 Server/Workstation, please refer to there user's guide. If you have any problems, please contact the concerning manufacture for detailed information or assistant.

**This Page Is Intentionally Blank**

---

## Appendix F BIOS Flashing User Instructions

---

When your motherboard needs to be upgraded with new features or some compatibility problems in the BIOS need to be fixed, you will need to use this BIOS flash utility. This utility is provided by Award Software makes it easy to flash by yourself. However, please read all the information in this section before flashing.

Before you can flash the BIOS you need to go into the *pure DOS environment* by rebooting your system and going directly into DOS. Basically, there are two ways to flash your BIOS. One is to directly type the full line commands that are described in this section. The utility will then flash your BIOS. When you finish the flash operation, you will see the screen as in Figure F-2 <sup>Note F-1</sup>.

The other method is to just type *awdflash* (under Award flash BIOS utility directory) then press enter. The Flash Memory Writer V7.22 screen will appear. Please refer to Figure F-1 <sup>Note F-1</sup>. You need to type "NEWBIOS" (the file name or you can use another name if you choose) into the "File Name to Program", then press enter.

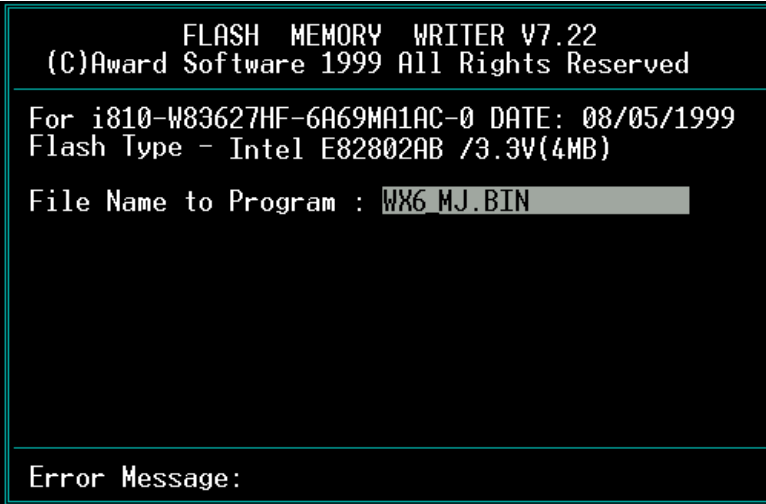

```
FLASH MEMORY WRITER V7.22
(C)Award Software 1999 All Rights Reserved

For i810-W83627HF-6A69MA1AC-0 DATE: 08/05/1999
Flash Type - Intel E82802AB /3.3V(4MB)

File Name to Program : WX6 MJ.BIN

Error Message:
```

Figure F-1. Award Flash Memory Writer V7.22 Start Screen

When you have finished updating your BIOS, you will see the screen as in Figure F-2. You then need to press the *F1* key to reset the system, or press the *F10* key to exit the writer.

```

FLASH MEMORY WRITER V7.22
(C)Award Software 1999 All Rights Reserved

For i810-W83627HF-6A69MA1AC-0 DATE: 08/05/1999
Flash Type - Intel E82802AB /3.3V(4MB)

File Name to Program : WX6 MJ.BIN
Checksum: 69B4H
Erase Flash Memory - 7FE000K

Write OK No Update Write Fail

F1 Reset F10 Exit

```

Figure F-2. Award Flash Memory Writer V7.22 Complete Screen

Figure F-3 shows you what commands you can use for the flashing program. You need to go into the pure DOS environment and type *awdf flash*. Figure F-3 will then appear.

```

Awdf flash 7.22 (C)Award Software 1999 All Rights Reserved
Usage: AWDFLASH [FileName1] [FileName2] [/<sw>[/<sw>...]]
      FileName1 : New BIOS Name For Flash Programming
      FileName2 : BIOS File For Backing-up the Original BIOS
<Switches>
? : Show Help Messages
py: Program Flash Memory          pn: No Flash Programming
sy: Backup Original BIOS To Disk File  sn: No Original BIOS Backup
Sb: Skip BootBlock programming      sd: Save DMI data to file
cp: Clear PnP(ESCD) Data After Programming
cd: Clear DMI Data After Programming
cc: Clear CMOS Data After Programming
R : RESET System After Programming   cks: Show update Binfile checksum
Tiny: Occupy lesser memory
E : Return to DOS When Programming is done
F : Use Flash Routines in Original BIOS For Flash Programming
LD: Destroy CHOS Checksum And No System Halt For First Reboot
    After Programming
cksXXXX: Compare Binfile CheckSum with XXXX
Example: AWDFLASH 2a59i000.bin /py/sn/cd/cp/cks2635

```

Figure F-3. Award Flash Memory Writer V7.22 Flash Commands Screen



**Note F-1**

The BIOS file name in the figure shown is only an example. You should check which .bin file is to be used with your motherboard. Don't flash with the wrong .bin file otherwise you may cause system malfunctions. Even the same model BIOS, according to their release dates and which problems have been fixed, have different .bin names. Please read the BIOS file description before you download it.

Example 1: To update the BIOS and create a backup of the current system BIOS execute this command:

```
AWDFLASH NEWBIOS /PY SAVEBIOS /SY
```

Example 2: To update the BIOS, create a backup of current system BIOS, and clear the CMOS, execute this command:

```
AWDFLASH NEWBIOS SAVEBIOS /CC
```

Example 3: To update the BIOS and clear PnP settings execute this command:

```
AWDFLASH NEWBIOS /SN /CP
```

Example 4: To make a backup of the current system BIOS execute the following command:

```
AWDFLASH NEWBIOS /PN SAVEBIOS
```

**Note F-2**

“NEWBIOS” indicates the file name for the new BIOS which can be downloaded from our web site at <http://www.abit.com.tw> (the user can choose a different file name in place of NEWBIOS). “SAVEBIOS” indicates the filename of the old system BIOS (the user can choose a different file name in place of SAVEBIOS).

Explanation of parameter names:

/CC: Clears CMOS data

/CP: Clears PnP data

/CD: Clears DMI data

/CKS: Compare Binfile Checksum

**Remarks:**

1. When executing AWDFLASH.EXE, do not run HIMEM.SYS and EMM386.EXE in the CONFIG.SYS.
2. Please take the following actions to solve problems caused by power shortages or other non-preventable malfunctions during BIOS updating that lead to update failures. First, it is strongly suggested that you format a disk that can boot your computer before you update your BIOS. If the above mentioned problem occurs during BIOS updating, you will be able to use this disk to automatically execute a BIOS update. The content of the disk should be as follows:

(1) Startup system files (COMMAND.COM, MSDOS.SYS, IO.SYS...)

(2) AWDFLASH.EXE

(3) The NEWBIOS file which can be download from ABIT web site.

(4) AUTOEXEC.BAT, which has the following content:

**A:\AWDFLASH NEWBIOS /PY /SN /CC /CD**

For example, to update the WX6 BIOS version to MJ (WX6\_MJ.BIN), you need to type:

**A:\AWDFLASH WX6\_FZ.BIN /PY /SN /CC /CD /CKS**

3. If you try to flash an incorrect version of a BIOS (i.e. for another motherboard) the following message will appear:

**“The program file’s part number does not match with your system!”**

**Note F-3**

Please do not use the Award flash memory writer version that earlier than Version 7.22 to flash your WX6 motherboard BIOS. Otherwise, it may cause flash fail or anticipate problems.

---

## Appendix G Installing the HighPoint XStore Pro Utility

---

We provide a useful and powerful utility on our product package, *HighPoint XStore Pro*. What does XStore do? The XStore Pro is a hard disk enhancement utility which improves system performance. The basic concept is to use a read-ahead caching algorithm to improve hard disk performance. With the market trend moving system's standard configurations towards 48 MBytes memory size or beyond, HighPoint's XStore Pro provides higher system performance. XStore Pro is the new generation of XStore MMX Accelerators for Storage.

XStore Pro utilizes the bigger system memory size to enhance memory management by working with Windows® 95 and 98. XStore Pro optimizes higher system performance by read ahead caching after seeking with large block sizes of hard disks. And best of all, XStore Pro supports several PCI Bus Master Controllers such as Intel, SiS, Ali, Via and others.

When you install XStore Pro, you can choose to install CD Xpress at the same time. Why do you need CD Xpress? We'll tell you more about it.

CD-ROM technology is growing fast, but its performance is still unacceptable compared to today's hard drives. The transfer rates of today's hard drives can exceed 18MB/sec with access times below 12ms. However, transfer rates for the fastest CD-ROM drives on the market are below 2MB/sec with access times over 100 ms.

CD Xpress was created to accelerate the accessing speed of the CD-ROM drive by utilizing the hard drive's high performance. CD Xpress reads and buffers data from the CD-ROM to an area in the hard drive. With CD Xpress, when you access CD-ROM data, you are actually accessing data from a swap file in the hard drive. This results in a tremendous increase in CD-ROM performance without penalties.

Before you install this utility, there are several things you need to know.

### Important Note

1. You can only install one Bus Master Driver at a time in your system, or the drivers will result in conflict and cause system hangs. Please make sure you don't have any Bus Master Drivers installed in your system before you install XStore Pro! You must remove all components of the previous Bus Master Driver before you install XStore Pro to your system. For example, you cannot install both the Intel® bus master driver and HighPoint XStore Pro in your system, otherwise it will cause system conflict when you install the second bus master driver!

2. This Windows® 95/98 driver does not support CD-ROM Changers. If you have an ATAPI CD-ROM Changer installed in your system, please do not install this driver!
3. We have found that the Windows® 95 OSR2/Windows® 98 version fails to load the driver on some systems using the Bus Master chipset after you install and restart the system. The following step could solve this problem if it happens:
  - (1) Go to My Computer and double click Control Panel.
  - (2) Double click System then go to Device Manger and View Devices by Type.
  - (3) Go to hard disk controllers.
  - (4) Double click PCI Bus Master IDE Controller (Ultra DMA supported). (There should be a yellow mark besides this item)
  - (5) Click Resources and you should see a box near the bottom of the screen that says "Set Configuration Manually".
  - (6) Click on "Set Configuration Manually" and you will see a check next to "Use automatic setting".
  - (7) Uncheck the box and when the system asks you to reboot click "yes".
  - (8) After the system restarts the yellow mark should be gone

#### 4. De-Installation:

To uninstall XStore Pro from your system, run "Uninstall" from the HighPoint XStore Pro program group. This uninstall utility will: deactivate CD Xpress, if CD Xpress is active, remove the buffer space, and uninstall XStore Pro and CD Xpress from the system. After uninstalling XStore Pro, the hard disk will return to its original status. We suggest users reboot the system after finishing uninstalling.

5. The ATAPI LS-120 device will be recognized as a removable device in retail Windows 95(4.00.95) and OSR1 Windows 95(4.00.95 A) after the XStore Pro driver is installed.
6. This driver might lock on certain motherboards. Please check HighPoint Technology first if you encounter problems.

For more detailed information, please check the read me file stored in the *XStore Pro Program Group*. If you want to upgrade to a new version of the driver or want to know more about XStore Pro products, please go to the HighPoint Technologies Inc's company WEB site, the URL is <http://www.highpoint-tech.com/>.

This CD-ROM (Or floppy diskette) has the HighPoint XStore Pro drivers. (Version 1.2) The following procedure describes how to install the HighPoint XStore to your system. If you

have a floppy diskette instead of the CD-ROM, just insert the diskette and run the **Setup.exe** file to start installation.

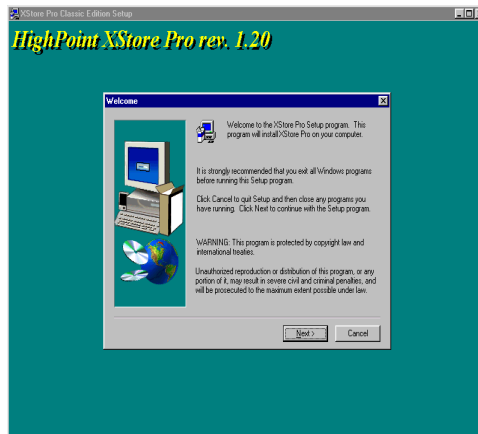

**Step 1:** In Windows® 95/98, place the CD-ROM into the computer. The main menu will show up. Click the **HighPoint XStore Pro Install** button and you will see the XStore Pro installer preparing the InstallShield® Wizard. When it is done, the *Welcome* screen will appear.

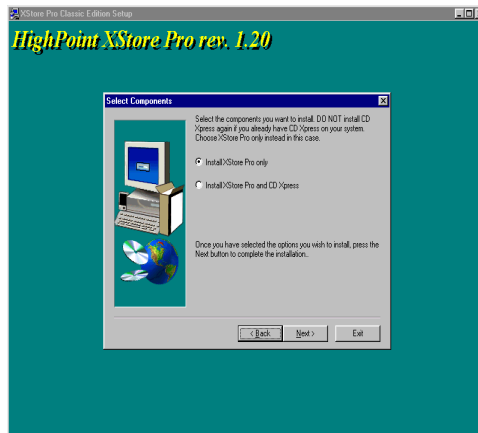

**Step 2:** Press the “Next” key, You will see the screen at left. You then need to choose whether you want to install XStore Pro only or if you want to install both XStore Pro and CD Xpress. Press the “Next” key to continue.

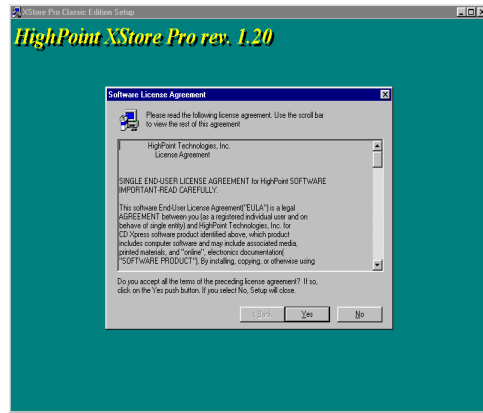

**Step 3:** Press the “Next” key, You will see the license screen.

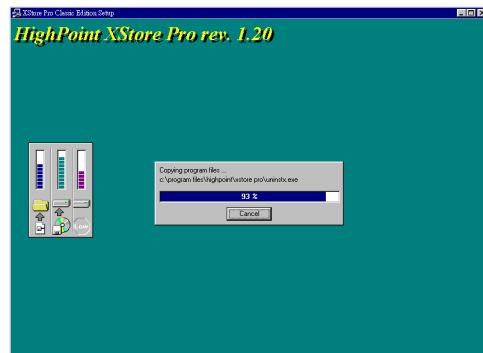

**Step 4:** Press “Yes” to continue.



**Step 5:** When the installation process is done, you will see the screen below. This screen will show up only when you install both XStore Pro and CD Xpress. If you want to see the ReadMe file, you can click on the circle.



**Step 6:** Choose the “Yes, I want to restart my computer now.” Button. Then system will restart. Or you can choose the “No, I will restart my computer later”.

#### Note

You must restart your computer after installing the XStore Pro utility. Otherwise, the software may not work not properly.

**This Page Is Intentionally Blank**



---

## Appendix H Hardware Monitoring Function (Installing the Winbond Hardware Doctor Utility)

---

Winbond Hardware Doctor is a self-diagnostic system for PCs and must be used with the Winbond chipset: W83627HF IC series products.

It protects PC hardware by monitoring several critical items including power supply voltages, CPU & system fan speeds and CPU and system temperatures. These items are important for the operation of the system. Errors may result in permanent damage to the PC. Once any item is out of its normal range, a warning message will pop up and remind the user to take the proper measures.

The following description will tell you how to install and use the Hardware Doctor. You should have the Winbond Hardware Doctor utility on a CD-ROM or floppy diskette. If you have a floppy diskette, just insert diskette 1 and execute the **Setup.exe** file to start installation.

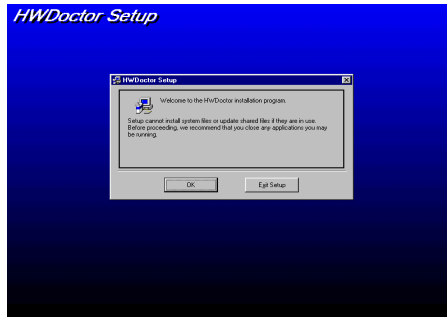

**Step 1.** In Windows® 95/98, place the CD-ROM into the computer. The main menu will appear. Click the **Hardware Doctor Install** button. The *HWDoctor Setup* screen will show up. Please refer the to figure below.

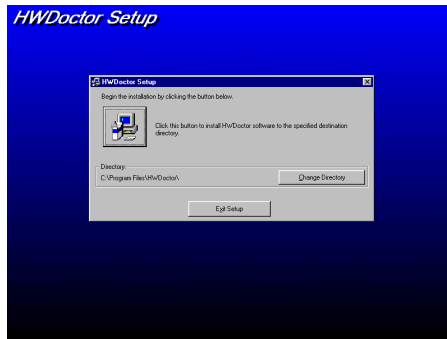

**Step 2.** Click the "OK" button and the screen below will appear.

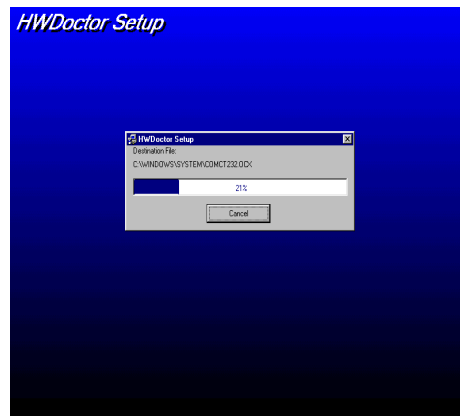

**Step 3.** You can specify the program install path by clicking the “Change Directory” button. Or if you want to use the default path, click the  icon to continue the install process. Now the screen will show you the percentage of installation progress.

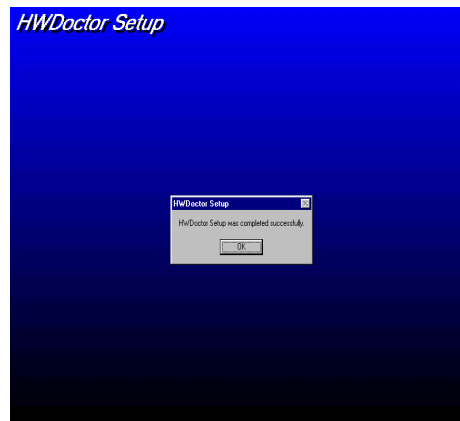

**Step 4.** When the process is finished, click the “OK” button.

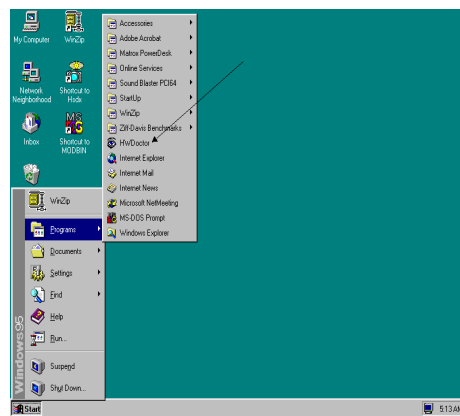

**Step 5.** Go to the Windows toolbar and click the “Start” button. Then choose the “program” → “HWDoctor” (See the arrow mark on figure below).

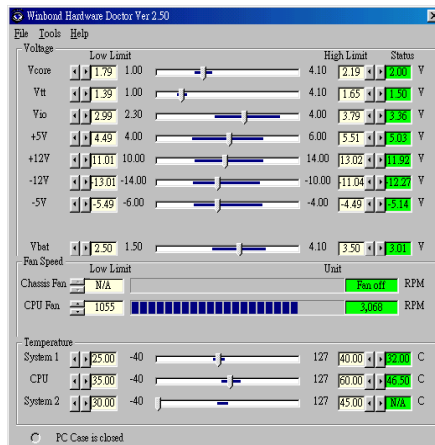

**Step 6.** This screen will appear. You will see voltages, fan speeds and temperature readings as well. If any item readings are critical or over their limitations, the reading will turn red. Also, a pop-up window will appear to warn you the system has a problem!

The figure below shows the warning message window.

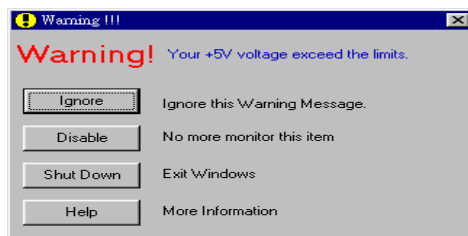

**Ignore:** You can ignore the warning message of the item, but it will pop up again when an error of the same item reoccurs.

**Disable:** The chosen item will be no longer monitored thereafter, unless you activate it in the "Configuration" page.

**Shutdown:** Choosing this button will shutdown the computer.

**Help:** You can read more information and self-diagnose simple problems.

If the warning message pops up due to the wrong warning limit, you can adjust it in the "Configuration" option. For example if you set the temperature high limit to 40°C, you will easily exceed the "proper" temperature.

Please pay attention to two things when you want to make any changes to the “Configuration” option. Firstly, you have to make sure your new setting is in the proper range. Secondly, after you finished the configuration, you have to save it. Otherwise, the program will start with the default value the next time.

If you encounter any problems or have any questions about the software settings and adjustments, please use the Winbond hardware doctor on-line help. It should give you enough information to answer your questions.

---

## Appendix I Installation Guide for Suspend to RAM

---

Suspend To RAM (STR) is a cost-effective, optimal implementation of the ACPI 1.0 specification. The ACPI specification defines the S3 sleep state, in which all system context is lost except system memory. CPU, cache, and chip set context are lost in this state. Hardware maintains memory context and restores some CPU and L2 configuration context.

The STR function enables a PC to achieve the S3 state during idle periods, then quick “wake up” and retrieve the last “state” of the system before it went to sleep. When idle, STR-enabled systems consume only a small fraction of the power used for full operation. Instead of shutting down the system to save power when not in use and then having to reboot later, users can let the STR function take over and not have to worry about using power to run all the electronics, fans and disks. When needed, a PC with STR function can restore all applications and features to an operational state within a few seconds.

The following description will tell you how to install the STR function and use it.

<b>Note</b>
-------------

<p>To get Windows® 98 to enable the ACPI BIOS function, you have to type the parameter after the setup command, for example, setup /p j. This command will let Windows® 98 automatically install the necessary elements for the ACPI BIOS. If you have already installed Windows® 98 without using this command, you have to re-install Windows® 98 and use the /p j command. Otherwise, your Windows® 98 ACPI function may not work.</p>
---

As above note mentioned, you have to use the parameter come with the setup command to install your Windows® 98. After you complete Windows® 98 installation and reboot your computer, you can see these items show up in the *System Properties* → *Device Manager*:

- ◆ ACPI System Button
- ◆ Advance Configuration and Power Interface (ACPI) BIOS
- ◆ SCI IRQ use by ACPI bus
- ◆ System board extension for ACPI BIOS

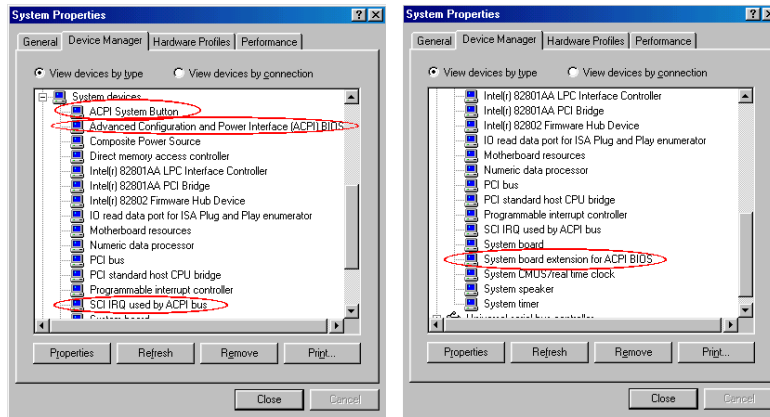

After these items show up, you can go to the next step for the STR function setting.

#### How to use the STR function:

There are two ways to put your system into STR mode:

Method 1: Select “Stand by” in the “Shut Down Windows” area.

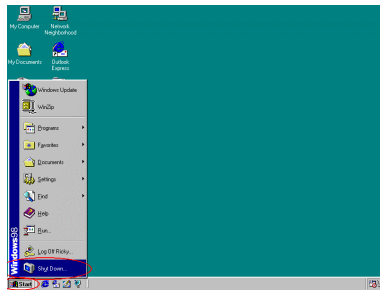

Step 1: Click “Start” in the Windows Tools Bar, and then select “Shut Down...”

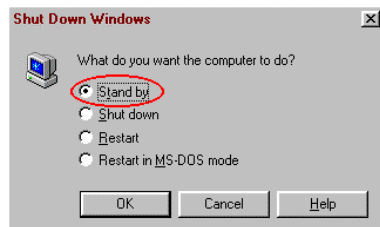

Step 2: Select “Stand by”, and then click “OK”.

Method 2: Define the case “Power” button to initiate STR sleep Mode

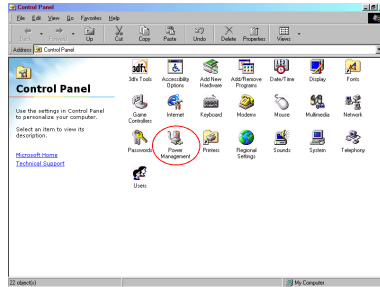

Step 1: Open “Control Panel”, and then enter “Power Management”.

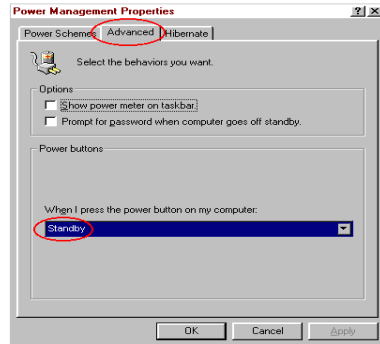

Step 2: Select “Advanced”, and then set the “Power Buttons” to “Standby”.

Step 3: Restart your computer to put these settings into effect. Now you will only need to press the “Power” button on the front panel of the chassis when you want to put your computer into STR sleep mode.

**This Page Is Intentionally Blank**



---

## Appendix J Troubleshooting (Need Assistance?)

---

If you have a problem during operation and in order to help our technical support personnel to quickly find out what the problem of your motherboard is and to give you the answers you need, before filling in the technical support form, eliminate any peripheral that is not related to the problem, and indicate on the form, the system's peripherals. Fax this form to your dealer or to the company where you bought the hardware or your nearest ABIT branch office in order to benefit from our technical support. (You can refer to the examples given below)



Example 1: With a system including: motherboard (with CPU, DRAM, COAST...) HDD, CD-ROM, FDD, MPEG CARD, SCSI CARD, SOUND CARD, etc. After the system is assembled, if you cannot boot up, check the key components of the system using the procedure described below. First remove all interface cards and try to reboot.

☛ If you still cannot boot up:

If it still does not start, note the motherboard model, BIOS identification number, CPU on the technical support form (refer to main instructions), and describe the problem in the problem description space provided.

☛ If you can boot up:

Reinsert the interface cards you have removed one by one and try to start the system each time you insert a card, until the system doesn't start anymore. Keep the interface card that causes the problem inserted on the motherboard, remove any other card or peripheral, and start again. If you still cannot start, note down the information related to both cards in the add-on Card space provided, and don't forget to indicate the motherboard model, version, BIOS identification number, CPU (refer to main instructions), and give a description of the problem.



Example 2: With a system including the motherboard (with CPU, DRAM, COAST...) HDD, CD-ROM, FDD, LAN CARD, MPEG CARD, SCSI CARD, SOUND CARD, after assembly and after having installed the Sound Card Driver, when you restart the system, when it runs the Sound Card Driver, it resets automatically. This problem may be due to the Sound Card Driver. During the Starting DOS... procedure, press SHIFT (BY-PASS) key, to skip CONFIG.SYS and AUTOEXEC.BAT; edit CONFIG.SYS with a text editor, and in function the

line that loads the Sound Card Driver, add a remark REM, in order to disable the Sound Card Driver. See the example below.

```
CONFIG.SYS:
DEVICE=C:\DOS\HIMEM.SYS
DEVICE=C:\DOS\EMM386.EXE HIGHSCAN
DOS=HIGH, UMB
FILES=40
BUFFERS=36
REM DEVICEHIGH=C:\PLUGPLAY\DWCFMG.SYS
LASTDRIVE=Z
```

Restart the system. If the system starts and does not reset, you can be sure that the problem is due to the Sound Card Driver. Note down the Sound Card model, motherboard model, BIOS identification number on the technical support file (refer to main instructions), and describe the problem in the space provided.

☺☺☺

---

### **Main instructions...**

To fill in this “Technical Support Form”, refer to the step-by-step instructions given below:

**1\* . MODEL:** Note the model number given in your user’s manual.

Example: WX6, BX6, BH6, etc...

**2\* . Motherboard model number (REV):** Note the motherboard model number labeled on the motherboard as “REV:\*.\*”.

Example: REV: 1.01

**3\* . BIOS ID and Part Number:** See next page example.

---

**WX6**

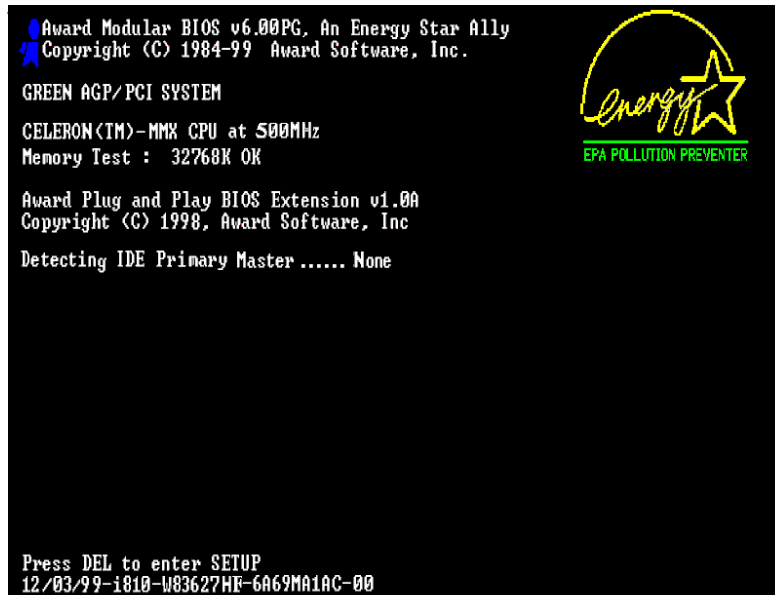

"00" is the BIOS ID number

"6A69MA1AC" is the BIOS part number

4. **DRIVER REV:** Note the driver version number indicated on the DEVICE DRIVER disk (if have) as "Release \*.\*". For example:

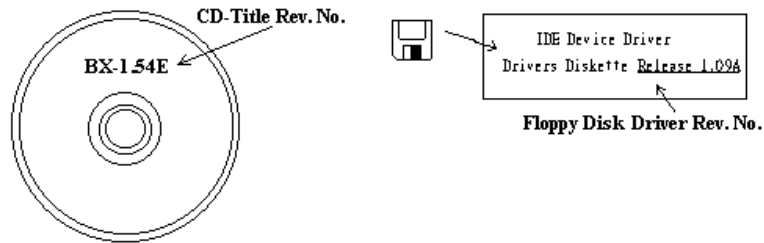

- 5°. **OS/APPLICATION:** Indicate the operating system and applications your are running on the system.

Example: MS-DOS® 6.22, Windows® 95, Windows® NT....

- 6°. **CPU:** Indicate the brand and the speed (MHz) of your CPU.

Example:(A) In the “Brand” space, write “Intel”, in the “Specifications” space, write “Pentium® II MMX 300MHz” °

7. **HDD:** Indicate the brand and specifications of your HDD(s), specify if the HDD is using  IDE1 or  IDE2. If you know the disk capacity, indicate it and check (“✓”) “”; in case you give no indication, we will consider that your HDD is “IDE1” Master.

Example: In the “HDD” space, check the box, in the Brand space, write “Seagate”, in the Specifications space, write “ST31621A (1.6GB)”.

8. **CD-ROM Drive:** Indicate the brand and specifications of your CD-ROM drive. Specify if it uses  IDE1 or  IDE2 ° and check (“✓”) “”; in case you give no indication, we will consider that your CD-ROM is “IDE2” Master.

Example: In the “CD-ROM drive” space, check the box, in the Brand space, write “Mitsumi”, in the Specifications space, write “FX-400D”.

9. **System Memory (DRAM):** Indicate the brand and specifications (SIMM / DIMM) of your system memory. For example:

In the Brand space, write “Panasonic”, in the Specifications space, write “SIMM-FP DRAM 4MB-06”.

Or, in the Brand, write “NPNX”, in the Specifications space, write “SIMM-EDO DRAM 8MB-06”.

Or, in the Brand space, write “SEC”, in the Specifications space, write “DIMM-S DRAM 8MB-G12”.

10. **ADD-ON CARD:** Indicate which add-on cards you are *absolutely sure* are related to the problem.

If you cannot identify the problem’s origin, indicate all the add-on cards inserted into your system.

**Note**

Items between the “\*” are absolutely necessary.

### Technical Support Form

Company name:

 Phone #:

 Contact:

 Fax #:

Model	*	BIOS ID #	*
Motherboard Model No.		DRIVER REV	
OS/Application	*		
Hardware name	Brand	Specifications	
CPU	*		
HDD	<input type="checkbox"/> IDE1 <input type="checkbox"/> IDE2		
CD-ROM Drive	<input type="checkbox"/> IDE1 <input type="checkbox"/> IDE2		
System Memory (DRAM)			
ADD-ON CARD			



Problem Description:

---



---



---



---



---



---



**This Page Is Intentionally Blank**