

FCC Information

Federal Communications Commission Radio Frequency Interference Statement

This equipment has been tested and found to comply with the limits for a Class B Digital Device, pursuant to Part 15 of the FCC Rules. These limits are designed to provide reasonable protection against harmful interference in a residential installation. This equipment generates, uses and can radiate radio frequency energy and, if not installed and used in accordance with the instructions, may cause harmful interference to radio communication. However, there is no guarantee that interference will not occur in a particular installation. If this equipment does cause harmful interference to radio or television reception, which can be determined by turning the equipment off and on, the user is encouraged to try to correct the interference by one or more of the following measures:

- Reorient or relocate the receiving antenna.
- Increase the distance between the equipment and receiver.
- Connect the equipment to an outlet on a circuit different from that to which the receiver is connected.
- Consult the dealer or an experienced radio/TV technician for help.

Changes or modifications not expressly approved by the mainboard manufacturer could void the user's authority to operate this equipment. To ensure compliance the subject device must use shielded interface cables.

Version 1.01

Copyright ©September 1996 All rights reserved

This publication may not be copied, reproduced, translated, transmitted or reduced to any printed or electronic medium or to any machine readable form, or stored in a retrieval system, either in whole or in part without the written consent of the copyright holders.

The contents of this publication are subject to change. The manufacturer reserves the right to alter the contents of this publication at any time and without notice. The contents of this publication may contain inaccuracies or typographical errors and is supplied for informational use only.

Products are noted in this publication for identification purposes only. Microsoft is a registered trademark and Windows is a trademark of Microsoft Corporation. Pentium is a trademark of Intel Corporation. All other product names or brands may be trademarks or registered trademarks of their respective holders.

Part No.: MN-083-B11-81

Contents

Introduction	1	-1
Manual Features	1	-1
Package Contents	1	-2
Feature Summary	1	-2
Static Electric Discharge Precautions	1	-4
Hardware Configuration	2	-1
Configuration Quick Reference	2	-1
CPU Configuration & Installation	2	-1
CPU Voltage	2	-1
External Clock Frequency & External Clock Factor	2	-3
DRAM Installation	2	-7
DIMM Voltage Settings	2	-8
Onboard Connectors	2	-9
Drive Controller & I/O Port Connectors	2	-9
System Enclosure Connectors	2	-12
Other Connectors	2	-14
Power Input Connector	2	-14
Keyboard & PS/2 Mouse Connectors	2	-14
IDE Activity LED Connector	2	-14
CPU Fan Power Connector	2	-14
PR5 Hardware Configuration	2	-16
CPU Options & Installation	2	-16
Related Terminology	2	-16
CPU Settings	2	-18
System Memory Configuration	2	-26
DIMM Voltage Settings	2	-29
Installing Memory Modules	2	-30
Level 2 Cache Options	2	-32
Onboard Connectors	2	-33
Disk Drive Controller & I/O Port Connectors	2	-33
System Enclosure Connectors	2	-35
Other Connectors	2	-35
Power Input Connector	2	-35
Keyboard & PS/2 Mouse Connectors	2	-35
IDE Activity LED Connector	2	-37
CPU Fan Power Connector	2	-37
DIP Switch & Jumper Summary	2	-38
Other Connectors	2	-38

JP3: Clear CMOS Memory	2	-39
JP8: Flash ROM Type	2	-40
Software Configuration	3	-1
The BIOS CMOS Setup Utility	3	-1
Accessing The CMOS Setup Utility	3	-1
Standard CMOS Setup	3	-4
BIOS Features Setup	3	-8
Chipset Features Setup	3	-13
Power Management Setup	3	-14
PCI & Onboard I/O Setup	3	-18
Load BIOS Defaults	3	-22
Load Setup Defaults	3	-23
Password Setting	3	-24
IDE HDD Auto Detection	3	-25
HDD Low Level Format	3	-25
Save And Exit Setup	3	-25
Exit Without Saving	3	-25
Updating The BIOS	3	-25
IDE Driver Disk	3	-25
Technical Information	4	-1
CPU Specifications	4	-1
Intel CPUs	4	-2
AMD K5 CPUs	4	-9
Cyrix CPUs	4	-10
IDE Installation Guide	4	-11
IDE Transfer Modes	4	-11
Installing IDE Devices	4	-12
IDE Cables	4	-12
Example IDE Configurations	4	-12
BIOS Setup	4	-17
IDE Hard Disk Formatting	4	-17
Technical Support	4	-18
Troubleshooting Guidelines	4	-18
The Troubleshooting Form	4	-19

Introduction

This manual has the information you will need to install, configure and use your PR5 mainboard. This section covers manual features, what is included in the PR5 package and a summary of the PR5's features.

Manual Features

This manual is designed to present information in both summary and detail so that whether you are unfamiliar with a topic or just need to get some specific information, you can find what you need with a minimum of effort. The summarized information is intended for experienced users. Please refer to the detailed explanations if you are unfamiliar with a topic.

A list of the main topics in each section appears in the sidebar on the first page. The manual is divided into four sections:

Section 1: Introduction

Section 2: Hardware Configuration

Section 3: Software Configuration

Section 4: Technical Information

Illustrations and tables identify locations and settings and sidebar notes and pointers are used to highlight important information.

Sidebar Notes

Summary information, tips and important points generally are in the sidebar on the left side of the page. If the information in the sidebar is not sufficient for you, check the main text nearby for additional information or refer to the component location noted in the sidebar.

Pointers

Cautions, important information, tips and key points are highlighted by the following icons:



Cautions & Important Information



Tips & Key Points

Section 1

Manual Features

Package Contents

Feature Summary

Package Contents

If your PR5 is already installed in a system you can skip this section. If you are installing the PR5 yourself, please check and make sure that all items listed are present and undamaged. If anything is missing or damaged, please contact your vendor for instructions.

The PR5 package contains the following items:

- PR5 mainboard
- Cable pack including:
 - 1 Parallel cable/port assembly
 - 1 Dual serial cable/port assembly
 - 1 Floppy controller ribbon cable
 - 2 IDE controller ribbon cables
 - 1 USB cable/port assembly (optional)
- Support Disk floppy disk
- User's Manual

The cables connect to the port and controller connector headers on the mainboard. This is explained in Section 2.

The Support Disk has drivers for use with various operating systems. These are covered in Section 3.

Feature Summary

The PR5 mainboard incorporates a variety of performance-enhancing features and is designed for use in File Server and Workstation computers and other high-end applications. It uses Intel's 430VX chipset, its PCI expansion bus supports the concurrent PCI 2.1 standard and it has two Universal Serial Bus (USB) ports.

The memory subsystem includes an upgradable 256KB Pipeline Burst Level 2 cache and support for both 72-pin Fast Page Mode (FPM) and EDO SIMM memory modules as well as 168-pin DIMM modules. This design supports both current memory standards and provides an upgrade path to future high-performance 64-bit memory.

The PR5' s feature list includes:

CPU Support – Socket 7 ZIF socket for Pentium and compatible CPUs as follows:

- Intel Pentium 75 – 200MHz CPUs
- AMD AMD-K5 75 – 100MHz CPUs
- Cyrix 6x86 P120+, 133+, 150+ and 166+ CPUs
- Future Pentium-class CPUs

Chipset – Intel 430VX:

- Incorporates concurrent PC Rev. 2.1 for enhanced interface card speed

L2 Cache – Pipeline Burst Level 2 cache:

- 256KB onboard
- Upgradable to 512KB using COAST module in upgrade socket

System DRAM – Expandable up to 128MB in multiple configurations (no DIMM sockets on PR5B):

- Four 72-pin sockets for Fast Page or EDO DRAM SIMM memory modules
- Two 168-pin sockets for Fast Page, EDO or SDRAM DIMM memory modules
- Supports Intel-specified 3.3V Unbuffered DRAM for DIMM modules

System BIOS – Award BIOS with support for:

- Plug and Play
- Advanced Power Management
- DMI (Desktop Management Interface) features including system suspend

Onboard Multi I/O – Onboard I/O ports and disk controllers including:

- Two Universal Serial Bus (USB) ports
- One EPP/ECP bidirectional parallel port
- Two high-speed 16550-compatible serial ports
- Floppy disk controller supports 360KB, 720KB, 1.2MB, 1.44MB and 2.88MB formats
- Enhanced IDE hard disk controller supports PIO Mode 0 – 4 and Bus Mastering

Additional Features – Other features include:

- “AT” dimensions for ease of installation
- Expansion bus with four ISA and three PCI slots
- Support for the 3-Mode floppy disk standard
- Can boot from either of two hard disk drives allowing support for dual operating systems

Static Electric Discharge Precautions

Static electric discharge can deliver a high-voltage shock to the mainboard sufficient to damage or destroy components on the board. Because of this, it is important to observe precautions when you handle the mainboard and any devices you install on it, including the CPU, memory modules and expansion cards.

There are several simple precautions you can take:

- Use an anti-static wrist strap, which can be purchased inexpensively from most computer stores. Connect the strap lead to a grounded metallic object and put on the strap before touching any components.
- Put components on an anti-static pad or keep them in their anti-static packaging until you install them.
- If you don't have a wrist strap or pad, make sure to touch a metallic object such as the system case to ground yourself before handling any components.

PR5 Mainboard Layout Key

1. ISA Bus Expansion Slots
2. PCI Bus Expansion Slots
3. USB Port Connector
4. Floppy Disk Drive Controller Connector
5. IDE Controller Connectors IDE1 (left) & IDE2 (right)
6. PS/2 Mouse (left) & Keyboard (right) Connectors
7. Power Input Connectors
8. COM1 (left) & COM2 (right) Serial, LPT Parallel Port Connectors
9. SIMM Memory module sockets 1 –4 (left to right)
10. DIMM Memory module sockets 1 & 2 (left to right)
11. DS DIP switches
12. CMOS Battery
13. VC DIP switches
14. Flash BIOS Chip
15. COAST PB SRAM cache module socket
16. Heat Sinks

AB-PR5 PCI Mainboard Layout

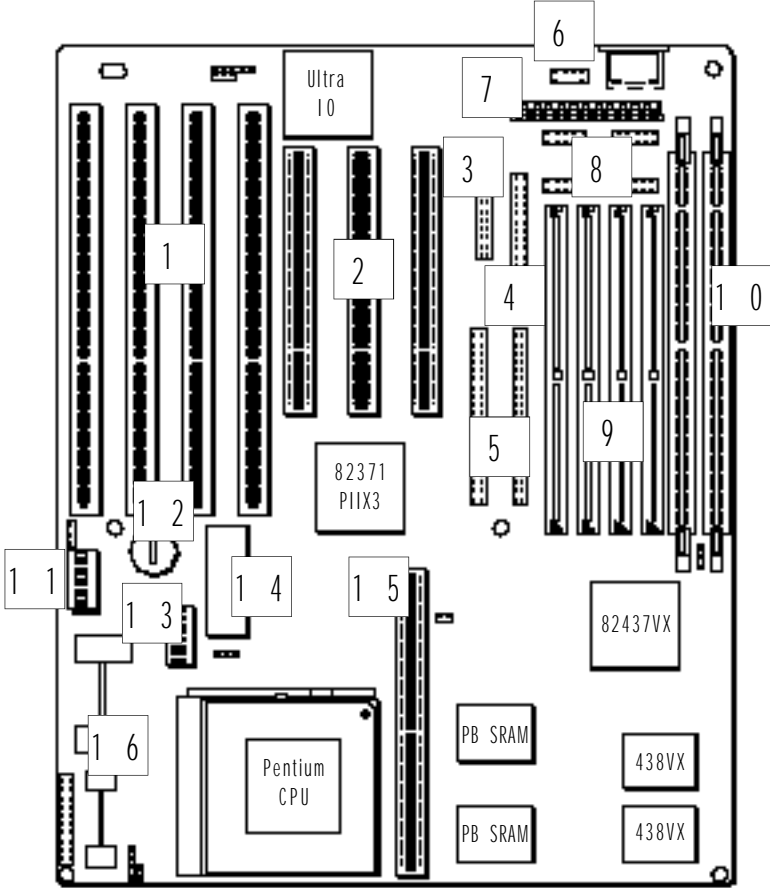

System Block Diagram

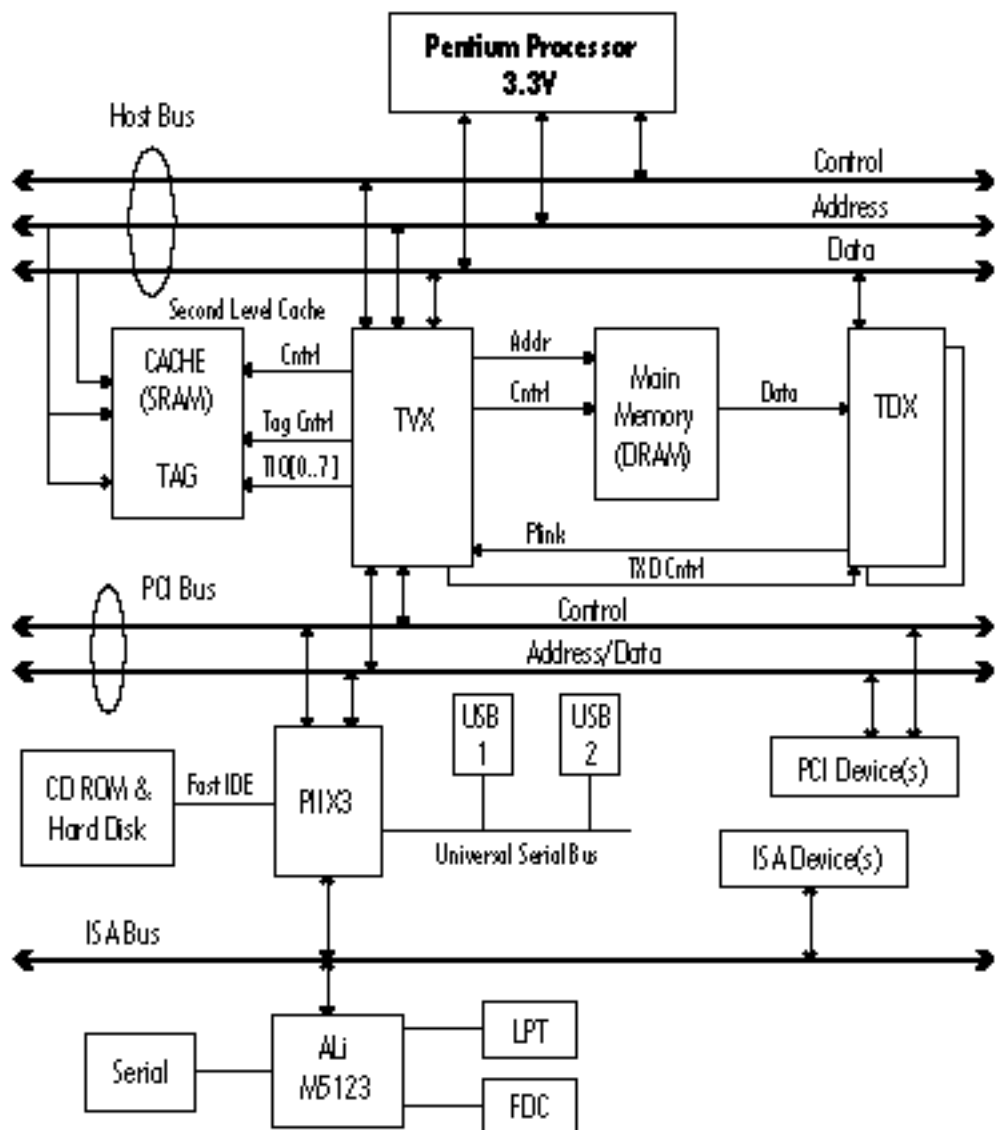

Hardware Configuration

This chapter is about how to configure the PR5. The first section is a summary for the experienced user. The second explains the same material in detail. If your PR5 is already installed in a system you can use this section if you need to reconfigure the mainboard.

Section 2

- Configuration Quick Reference
- PR5 Hardware Configuration:
- CPU Configuration
- Memory Configuration
- L2 Cache Configuration
- Onboard Connectors
- DIP & Jumper Summary

Configuration Quick Reference

This section provides a summary of the information needed to configure the PR5 mainboard for installation. Please refer to the section PR5 Hardware Configuration for detailed information.

CPU Configuration & Installation

The PR5 has a Socket 7 Zero Insertion Force (ZIF) socket. There are several CPU configuration settings required, including CPU voltage, External Clock Frequency and External Clock Factor. Detailed CPU reference information is in Section 4.

CPU Voltage

The following charts show the CPU voltage DIP switch settings for Intel, AMD and Cyrix CPUs. Reference information on required voltages is in Section 4.

VC DIP Switch Block Location

CPU Voltage Settings

You must set the CPU voltage using DIP switch block VC1-8. The switches are labeled on the block. The following charts list the settings.

Default Setting : 3.38V.

See Section 4 for detailed information on determining CPU voltage.

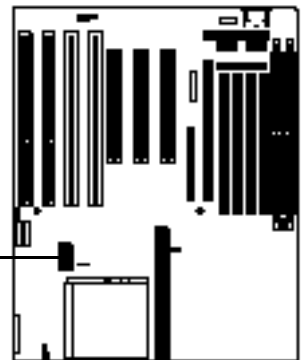
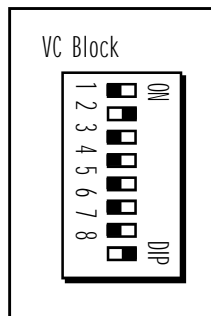

Intel Pentium CPU Vcore/Vio Settings

Vcore/Vio	VC1	VC2	VC3	VC4	VC5	VC6	VC7	VC8
2.7V/3.3V	OFF	OFF	OFF	OFF	0 N	OFF	OFF	0 N
2.8V/3.3V	OFF	OFF	OFF	0 N	OFF	OFF	OFF	0 N
2.93V/3.3V	OFF	OFF	0 N	OFF	OFF	OFF	OFF	0 N
3.38V/3.3V	OFF	0 N	OFF	OFF	OFF	OFF	OFF	0 N
3.52V/3.3V	0 N	OFF	OFF	OFF	OFF	OFF	OFF	0 N

Note: The factory default setting is 3.38V. (VRE=3.52V, STD/VR=3.38V)

AMD AMD-K5 CPU Vcore/Vio Settings

Vcore/Vio	VC1	VC2	VC3	VC4	VC5	VC6	VC7	VC8
2.7V/3.38V	OFF	OFF	OFF	OFF	0 N	OFF	0 N	OFF
2.8V/3.38V	OFF	OFF	OFF	0 N	OFF	OFF	0 N	OFF
2.93V/3.38V	OFF	OFF	0 N	OFF	OFF	OFF	0 N	OFF
3.38V/3.3V	OFF	0 N	OFF	OFF	OFF	OFF	OFF	0 N
3.52V/3.3V	0 N	OFF	OFF	OFF	OFF	OFF	OFF	0 N

Note: The factory default Vcore setting is 3.38V.

The voltage figures shown are the mid-point of a range, e.g. the range of 3.52V is 3.45V to 3.6V

Cyrix 6x86 CPU Vcore/Vio Settings

Vcore/Vio	VC1	VC2	VC3	VC4	VC5	VC6	VC7	VC8
2.7V/3.3V	OFF	OFF	OFF	OFF	0 N	OFF	OFF	0 N
2.8V/3.3V	OFF	OFF	OFF	0 N	OFF	OFF	OFF	0 N
2.93V/3.3V	OFF	OFF	0 N	OFF	OFF	OFF	OFF	0 N
3.38V/3.3V	OFF	0 N	OFF	OFF	OFF	OFF	OFF	0 N
3.52V/3.3V	0 N	OFF	OFF	OFF	OFF	OFF	OFF	0 N

Note: Recommended setting for 6x86 CPUs is 3.52V/3.3V.

The voltage figures shown are the mid-point of a range, e.g. the range of 3.52V is 3.45V to 3.6V

External Clock Frequency & External Clock Factor

The charts in this section show the DIP switch settings for both the CPU external clock frequency and clock factor. Only some of the switches in the DS block apply to these settings.

DS DIP Switch Block Location

External Clock Settings

You must set the correct external clock settings using DIP switch block DS1-8. The switches are labeled on the block. These charts list the settings.

Default Setting : Pentium 133.

See Section 4 for detailed CPU information.

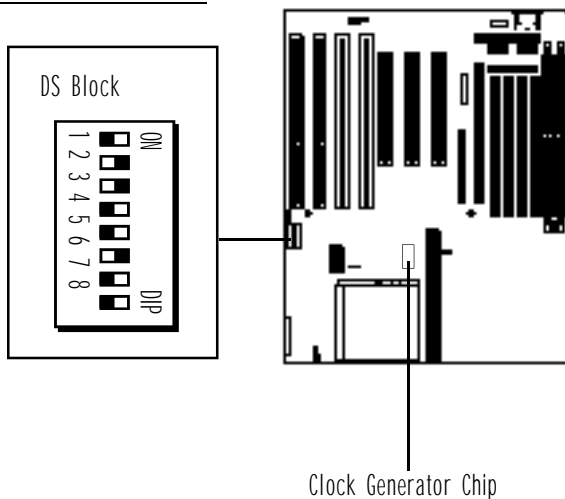

Important Note

The PR5 uses one of several clock generator chips. The DS DIP switch block settings vary depending on which chip is installed. To determine the correct settings you need to know which clock chip is installed. The position of the chip on the mainboard is noted above. The chip part information is printed on the top of the chip. The options are:

ICS:

ICS9159-14

PhaseLink:

PLL52C59-14T or PLL52C61-01 or PLL52C61-21

These clock generator chips support a "Normal" and a "Turbo" mode. Normal mode is the CPU manufacturer's rated clock speed. Turbo mode is an overclock mode that increases the CPU's clock speed by 2.5% over the Normal rating. For maximum stability and compatibility you should use the Normal mode for the CPU you are installing.

Intel Pentium CPUs

Clock Chip: PLL52C61-01 or PLL52C61-21

CPU:Ext/Int Clock	Ext. Clock Factor		Ext. Clock Freq.: Normal/Turbo			ISA Spd	Refresh
	DS1	DS2	DS3	DS4	DS7	DS5	DS6
P75:50/75MHz	OFF	OFF	ON/—	ON/—	ON/—	OFF	OFF
P90:60/90MHz	OFF	OFF	ON/OFF	ON/OFF	OFF/ON	ON	OFF
P100:66/100MHz	OFF	OFF	OFF/OFF	ON/OFF	ON/OFF	ON	OFF
P120:60/120MHz	OFF	ON	ON/OFF	ON/OFF	OFF/ON	ON	OFF
P133:66/133MHz	OFF	ON	OFF/OFF	ON/OFF	ON/OFF	ON	OFF
P150:60/150MHz	ON	ON	ON/OFF	ON/OFF	OFF/ON	ON	OFF
P166:66/166MHz	ON	ON	OFF/OFF	ON/OFF	ON/OFF	ON	OFF
P200:66/200MHz	ON	OFF	OFF/OFF	ON/OFF	ON/OFF	ON	OFF

Clock Chip: PLL52C59-14T or ICS9159-14

CPU:Ext/Int Clock	Ext. Clock Factor		Ext. Clock Freq. —(Norm/Turbo)			ISA Spd	Refresh
	DS1	DS2	DS3	DS4	DS7	DS5	DS6
P75:50/75MHz	OFF	OFF	ON	ON	OFF/ON	OFF	OFF
P90:60/90MHz	OFF	OFF	OFF	ON	OFF/ON	ON	OFF
P100:66/100MHz	OFF	OFF	ON	OFF	OFF/ON	ON	OFF
P120:60/120MHz	OFF	ON	OFF	ON	OFF/ON	ON	OFF
P133:66/133MHz	OFF	ON	ON	OFF	OFF/ON	ON	OFF
P150:60/150MHz	ON	ON	OFF	ON	OFF/ON	ON	OFF
P166:66/166MHz	ON	ON	ON	OFF	OFF/ON	ON	OFF
P200:66/200MHz	ON	OFF	ON	OFF	OFF/ON	ON	OFF

Note:

ICS9159-14 does not support Turbo mode at 75MHz

ISA Spd. —ISA Bus Clock speed, see page 2-19

Refresh —DRAM refresh [reserved for future use] always OFF

DS8 — reserved for future use, always OFF

AMD-K5 CPUs (AMD-SSA/5 & AMD-K5)

Clock Chip: PLL52C61-01 or PLL52C61-21

CPU:Ext/Int Clock	Ext. Clock Factor		Ext. Clock Freq.: Normal/Turbo			ISA Spd	Refresh
	DS1	DS2	DS3	DS4	DS7		
PR75:50/75MHz	OFF	OFF	0 N / -	0 N / -	0 N / -	OFF	OFF
PR90:60/90MHz	OFF	OFF	0N/OFF	0N/OFF	0FF/0N	0 N	OFF
PR100:66/100MHz	OFF	OFF	OFF/OFF	0N/OFF	0N/OFF	0 N	OFF
PR120:60/90MHz	OFF	OFF	0N/OFF	0N/OFF	0FF/0N	0 N	OFF
PR133:66/100MHz	OFF	OFF	OFF/OFF	0N/OFF	0N/OFF	0 N	OFF
PR150:60/120MHz	OFF	0 N	0N/OFF	0N/OFF	0FF/0N	0 N	OFF
PR166:66/133MHz	OFF	0 N	OFF/OFF	0N/OFF	0N/OFF	0 N	OFF

Clock Chip: PLL52C59-14T or ICS9159-14

CPU:Ext/Int Clock	Ext. Clock Factor		Ext. Clock Freq. -(Norm/Turbo)			ISA Spd	Refresh
	DS1	DS2	DS3	DS4	DS7		
PR75:50/75MHz	OFF	OFF	0 N	0 N	0FF/0N	OFF	OFF
PR90:60/90MHz	OFF	OFF	OFF	0 N	0FF/0N	0 N	OFF
PR100:66/100MHz	OFF	OFF	0 N	OFF	0FF/0N	0 N	OFF
PR120:60/90MHz	OFF	OFF	OFF	0 N	0FF/0N	0 N	OFF
PR133:66/100MHz	OFF	OFF	0 N	OFF	0FF/0N	0 N	OFF
PR150:60/120MHz	OFF	0 N	OFF	0 N	0FF/0N	0 N	OFF
PR166:66/133MHz	OFF	0 N	0 N	OFF	0FF/0N	0 N	OFF

Note:

ICS9159-14 does not support Turbo mode at 75MHz

ISA Spd. — ISA Bus Clock speed, see page 2-19

Refresh — DRAM refresh [reserved for future use] always OFF

DS8 — reserved for future use, always OFF

Cyrix 6x86 CPUs

Clock Chip: PLL52C61-01 or PLL52C61-21

CPU:Ext/Int Clock	Ext. Clock Factor		Ext. Clock Freq.: Normal/Turbo			ISA Spd	Refresh
	DS1	DS2	DS3	DS4	DS7	DS5	DS6
P120+:50/100MHz	OFF	0N	0N / -	0N / -	0N / -	OFF	OFF
P133+:55/110MHz	OFF	0N	0N / -	OFF / -	0N / -	0N	OFF
P150+:60/120MHz	OFF	0N	0N/OFF	0N/OFF	OFF/0N	0N	OFF
P166+:66/133MHz	OFF	0N	OFF/OFF	0N/OFF	0N/OFF	0N	OFF
P200+:75/150MHz	OFF	0N	0N / -	OFF / -	OFF / -	0N	OFF

Clock Chip: PLL52C59-14T or ICS9159-14

CPU:Ext/Int Clock	Ext. Clock Factor		Ext. Clock Freq. -(Norm/Turbo)			ISA Spd	Refresh
	DS1	DS2	DS3	DS4	DS7	DS5	DS6
P120+:50/100MHz	OFF	0N	0N	0N	OFF/0N	OFF	OFF
P133+:55/110MHz	OFF	0N	OFF	OFF	OFF / -	0N	OFF
P150+:60/120MHz	OFF	0N	OFF	0N	OFF/0N	0N	OFF
P166+:66/133MHz	OFF	0N	0N	OFF	OFF/0N	0N	OFF
P200+:75/150MHz	OFF	0N	OFF	OFF	0N / -	0N	OFF

Note:

ICS9159-14 does not support Turbo mode at 75MHz

ISA Spd. -ISA Bus Clock speed, see page 2-19

Refresh -DRAM refresh [reserved for future use] always OFF

DS8 - reserved for future use, always OFF

DRAM Installation

The PR5 has numerous possible system memory configurations using the four 72-pin SIMM sockets and the two 168-pin DIMM sockets. The SIMM sockets work in banks of two to provide a 64-bit data path. SIMM1/SIMM2 are one bank, SIMM3/SIMM4 are another. The DIMM sockets are each a bank, for a total of four banks. Please note the following.



Important Note: Double-sided Modules

There is an important limitation in using double-sided SIMM or DIMM modules. Double-sided modules in one bank prevents the use of a corresponding bank of the other type of module. For example:

- If bank SIMM1/2 has 2-sided modules installed, you can not use the DIMM2 socket.
- If bank SIMM3/4 has 2-sided modules installed, you can not use the DIMM1 socket.
- If bank DIMM1 has a 2-sided module installed, you can not use the SIMM3/4 sockets.
- If bank DIMM2 has a 2-sided module installed, you can not use the SIMM1/2 sockets.

Double-sided modules are modules with memory chips mounted on both sides.

- Installed memory is auto-detected by the BIOS
- Minimum installation 2 SIMMs or 1 DIMM module for a 64-bit data path
- Fast Page (FP), EDO and SDRAM are all supported, SDRAM only in DIMM modules
- SIMMs: single or double-sided modules of 4MB and up supported
- DIMMs: single or double-sided modules of 8MB and up supported
- DIMM sockets support both 5-volt (FP or EDO) and 3.3-volt (Unbuffered) DRAM; voltage for both sockets is set by jumper JP11 (see next page)
- Pairs of SIMMs must be the same memory type, size and speed but the type and size of a second pair can be different
- Memory Banks:
SIMM1 & SIMM2
SIMM3 & SIMM4
DIMM1
DIMM2
- Bank sequence doesn't matter, use any combination as long as other requirements are followed
- DRAM speed must be at least 70ns, can be faster
- Parity checking is not supported
- Maximum 128MB supported

There are numerous allowable memory configurations. Since bank sequence is not important, as long as you use SIMMs in pairs you can use any combination of banks. However, for maximum performance it best to use the same type of DRAM in all banks installed. SDRAM provides higher performance than EDO DRAM and EDO is faster than Fast Page Mode DRAM.

DIMM Voltage Settings

The DIMM sockets support both 5-volt and 3.3-volt unbuffered DRAM. The voltage setting for both DIMM sockets is controlled by jumper JP11. The socket voltage setting must match the voltage of the DRAM on any DIMM modules you install. The jumper settings are shown below.



DIMM Voltage Settings

Jumper JP11 sets the voltage supplied to the DIMM sockets. FP & EDO modules use the 5-Volt setting.

Default Setting : 3-Volt.

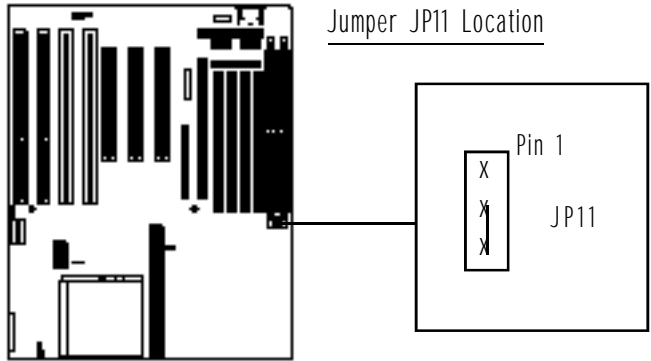

JP11: DIMM Voltage

	Pins 1-2	Pins 2-3
5-Volt DIMM	Short	NA
3-Volt DIMM	NA	Short [Default]

Note:

5-Volt = FP or EDO DRAM

3-Volt = 3.3-Volt Unbuffered DRAM

Onboard Connectors

The PR5 has onboard connector headers for the disk controllers, I/O ports, system enclosure connections and several other features. Pin 1 locations are noted for cable orientation.

Drive Controller & I/O Port Connectors

The PR5 has floppy disk drive, Enhanced IDE controller, serial, parallel and USB port connector headers onboard.

Drive Controller Connectors

The Floppy Disk Drive Controller connector is a 34-pin header. The two Enhanced IDE Controller connectors for Channel 1 and Channel 2 are 40-pin headers. Ribbon cables are supplied for each connector. When installing drives, make sure the colored edge of the drive's ribbon cable is at the Pin 1 end of the both the onboard connector and the drive. Their positions and Pin 1 locations are shown below.

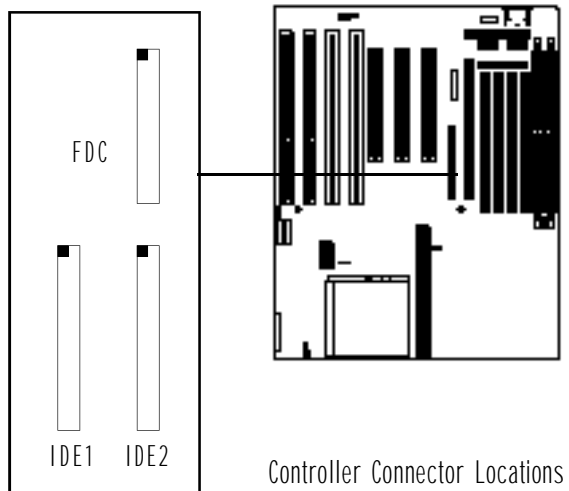

I/O Port Connectors

The PR5 has two serial, one parallel, a connector for an IrDA-compatible Infrared port and a dual-port USB connector onboard. Combination ribbon cable to external port cables are supplied for each connector except the Infrared port. When installing ports, make sure the colored edge of the ribbon cable is at the Pin 1 end of the onboard connector. Their positions and Pin 1 locations are shown below and the pin assignments for the Infrared and USB ports are shown in the table on page 2-11.

I/O Port Connector Locations

I/O Port Connectors

There are five connectors:

JP2: Infrared port (5-pin)

USB: USB ports (16-pin)

COM1: COM1 serial port (10-pin)

COM2: COM2 serial port (10-pin)

LPT: LPT1 printer port (26-pin)

Pin 1: Upper left-hand corner for USB, upper right-hand corner for COM & LPT as shown at right.

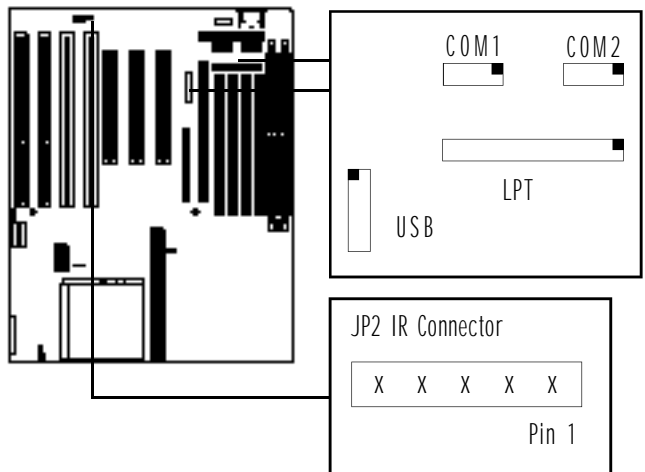

Connector Summary

Name	# Pins	Function
IDE1	4 0	IDE Channel 1 connector
IDE2	4 0	IDE Channel 2 connector
FDC	3 4	Floppy Disk connector
LPT	2 6	Parallel Port connector
COM1	1 0	Serial Port COM1 connector
COM2	1 0	Serial Port COM2 connector
USB	1 6	Universal Serial Bus connector

Infrared & USB Port Connectors

	Pin	Function
IR Port		
Pin 1		+5-Volts DC
Pin 2		Not used
Pin 3		Receive Data
Pin 4		Ground
Pin 5		Transmit Data
USB Ports: USB 1 – Pins 1-8, USB 2 – Pins 9-16		
Pin 1		+5-Volts
Pin 2		Ground
Pin 3		USBP0 -
Pin 4		Ground
Pin 5		USBP0 +
Pin 6		Ground
Pin 7		Ground
Pin 8		Ground
Pin 9		+5-Volts
Pin 10		Ground
Pin 11		USBP0 -
Pin 12		Ground
Pin 13		USBP0 +
Pin 14		Ground
Pin 15		Ground
Pin 16		Ground

Note: The USB connector is for two ports. Pins 1 through 8 are for the first port, and pins 9 through 16 are for the second.

System Enclosure Connectors

The system enclosure (case) connections are in a header block which includes the Hardware Reset, Suspend Switch, Turbo LED, Speaker and Keylock connectors. Your system case may or may not have all of these features. The location of the connector block and the pin assignments are shown below.

Enclosure Features Connectors

Enclosure Connectors

There are five connectors in the block, the other pins are unused:

Reset: Pins 1&2 [1]

Suspend Switch: Pins 6&7 [2]

Turbo LED: Pins 8&9 [3]

Speaker: Pins 11 – 14 [4]

Keylock: Pins 16 – 20 [5]

Connectors are labeled at right.

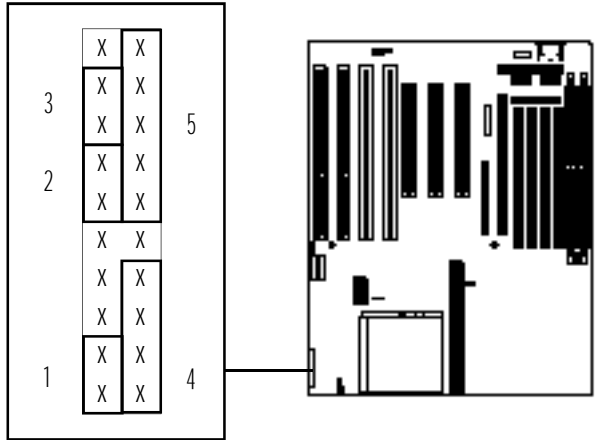



Enclosure Features Connectors

Not every pin in the connector block for system case features is used. Which features are used depends on the specific case design. If your case does not have a Keyboard Lock, you can still connect a Power LED lead to Pin 20 and either Pin 16 or 18. Refer to the chart at right for the pin assignments.

Enclosure Features Connector Block

Feature	Pin Function
Hardware Reset Connector	
Pin 1	Ground
Pin 2	Reset signal
Suspend Switch Connector	
Pin 6	Ground
Pin 7	Suspend
Turbo LED Connector	
Pin 8	- Negative (anode) pin
Pin 9	+ Positive (cathode) pin
Speaker Connector	
Pin 11	+5-Volts DC
Pin 12	Ground
Pin 13	Ground
Pin 14	Sound signal
Keylock & Power LED Connector	
Pin 16	Ground
Pin 17	Keyboard inhibit signal
Pin 18	Ground
Pin 19	Unused
Pin 20	+5-Volts DC (for Power LED)

Note:

Pins 3,4, 5, 10, 15 are unused

Other Connectors

There are several other connectors on the PR5, including the power input, keyboard, PS/2 mouse, IDE LED activity light and CPU fan connectors. Their locations and pin assignments are shown below and at right.

Power Input Connector

The system power supply connector is a 12-pin connector, divided into two sections, P8 and P9.

Keyboard & PS/2 Mouse Connectors

The external keyboard connector is a standard “AT” DIN keyboard connector. The PS/2 mouse connector is a 6-pin header block for a PS/2 mouse port.

IDE LED Activity Light Connector

The IDE LED activity light connector is a 4-pin connector header which will accept either a 2-pin or 4-pin IDE LED activity light connector lead.

CPU Fan Power Connector

The CPU fan power connector is a 3-pin connector header which will accept either a 2-pin or 3-pin CPU fan power lead connector.

Connector Locations

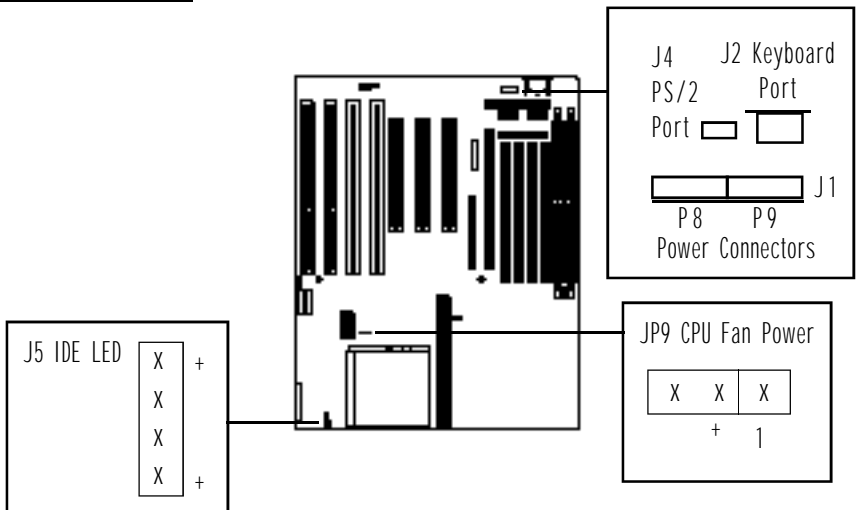



Power Supply Lead Connectors

Some system power supplies have two leads that connect to the J1 power input connector. If this is the case, you must connect the power supply leads so that the black wires are grouped together in the middle.

Other Onboard Connectors

	Pin Function
Power Input Connector J1	
Pin 1	Powergood
Pin 2	+5-Volts DC
Pin 3	+12-Volts DC
Pin 4	-12-Volts DC
Pin 5	Ground
Pin 6	Ground
Pin 7	Ground
Pin 8	Ground
Pin 9	-5-Volts DC
Pin 10	+5-Volts DC
Pin 11	+5-Volts DC
Pin 12	+5-Volts DC
IDE Activity LED Connector J5	
Pin 1	+ Positive (cathode) pin
Pin 2	- Negative (anode) pin
Pin 3	- Negative (anode) pin
Pin 4	+ Positive (cathode) pin
CPU Fan Power Connector JP9	
Pin 1	Ground
Pin 2	+12-Volts DC for fan power
Pin 3	Ground

PR5 Hardware Configuration

This section describes how to configure the PR5 main-board hardware in more detail than the Configuration Quick Reference at the beginning of this section. It is intended for users who are less familiar with computer hardware. If your PR5 is already installed in a system you will not need much of this information unless you need to reconfigure your system.

This section covers all the standard features on the board plus the upgrade options. Since you are more likely to need the upgrade options, they come first. The section is organized as follows

- CPU Options & Installation
- System Memory Configuration
- Level 2 Cache Options
- Onboard Connectors
- DIP Switch and Jumper Summary

The information in this section augments the Configuration Quick Reference. So these sections provide additional detail, with some review.

CPU Options & Installation

The PR5 supports a wide assortment of CPU chips from various manufacturers. It is also designed to provide as much upgradability as current information on future CPUs allows. We must note, however, that only the CPUs listed in the manual have been certified to work with the PR5.

Related Terminology

To make it easier to understand the information this section you may want to review the following terms.

Clock

You'll see this term used in several ways. Here it doesn't refer to keeping time and is not the clock that keeps the date and time setting for the system. The mainboard relies on the system clock to provide digital timing pulses at a constant frequency. The signal the clock generates synchronizes all operations on the board. This "clock frequency", or the number of signals per second is what we usually think of as the clock "speed" of the system.

In Pentium-based designs there is more than one clock speed. The mainboard components run at one speed and the CPU will run at the same speed in its external activity, but will run at some multiple of that speed internally.

External Clock

The External Clock, also sometimes referred to as the external CPU clock or bus clock, is the CPU's input clock. The CPU will interface with other components at this speed and its internal clock speed is a multiple of this external speed. The internal speed is set by the Clock Multiplier Factor. For example, the Intel Pentium P90, P120 and P150 CPUs all have the same external clock, 60MHz, but have different clock factors.

Internal Clock

The Internal Clock is a multiple of the external clock and is the speed used to list the processor's operating speed. The internal speed is set by the Clock Multiplier Factor. For example, the Intel Pentium P150 CPU has a 150MHz internal clock speed, a 2.5 multiple of the 60MHz external clock.

Clock Multiplier Factor

The clock multiplier factor is the factor by which the external clock is multiplied to set the CPU's internal clock speed. The PR5 has four options: 1.5, 2, 2.5, 3. For example, the Pentium P166 requires a 66MHz external clock and a 2.5 clock multiplier factor to establish its 166MHz internal clock speed. Note: The full clock frequencies are rounded off for convenience when listed, so while $66 \times 2.5 = 165$, the actual clock speed is 166MHz.

ISA Bus Clock

This is the clock speed of the ISA expansion bus and may also be referred to as the ISA speed, AT Bus Clock or AT clock. The original specification was 8MHz. The slower speed ensures compatibility with all ISA expansion cards. Newer ISA expansion cards may be able to operate at faster speeds, which provide increased performance. The PR5 can be set for slower or faster ISA Bus clock speeds. The slower speed ensures maximum compatibility.

CPU Voltage – Vcore & Vio

The CPU input voltage has two components, Vcore and Vio. Vcore provides the power for internal processing and Vio for the external interface. The two settings are linked, so the VC DIP settings cover both of them.

P-Rating

The “P-Rating” is a categorization used to rate the performance of some Pentium-compatible CPUs. The rating system was created because some CPUs perform at a higher effective speed than their internal clock speed indicates. For example, the Cyrix 6x86 P166+ has a clock speed of 133MHz, but performs at an effective speed equal to or greater than 166MHz. The P-rating indicates the effective, rather than the actual clock speed of the CPU.

CPU Settings

To configure the PR5 for the CPU you will install you have to set the switches on the two CPU configuration DIP switch blocks DS and VC. The procedure is as follows:



1. Set the Clock Multiplier Factor using switches DS1 and DS2 on the DS DIP switch block.
2. Set the External Clock configuration using switches DS3, DS4 and DS7 on the DS DIP switch block.
3. Set the ISA Bus Clock configuration using switch DS5 on the DS DIP switch block.
4. Make sure DS6 on the DS DIP switch block is OFF. This controls DRAM refresh and is reserved for use with future CPUs. The default setting is OFF.
5. Make sure DS8 on the DS DIP switch block is OFF. This is reserved for use with future CPUs. The default setting is OFF.
6. Set the Vcore/Vio configuration using the VC DIP switch block.
7. Make sure jumper JP10 is set to the default “Open” setting (no jumper cap connecting the two pins).

In order to give you more CPU configuration options we have included Turbo settings which increase system performance somewhat as well as the standard CPU configurations which maintain maximum stability and compatibility. The Turbo settings are labeled as such and all other settings are standard. The charts on the following pages show the settings for various CPUs.

DS & VC DIP Switch Block Locations

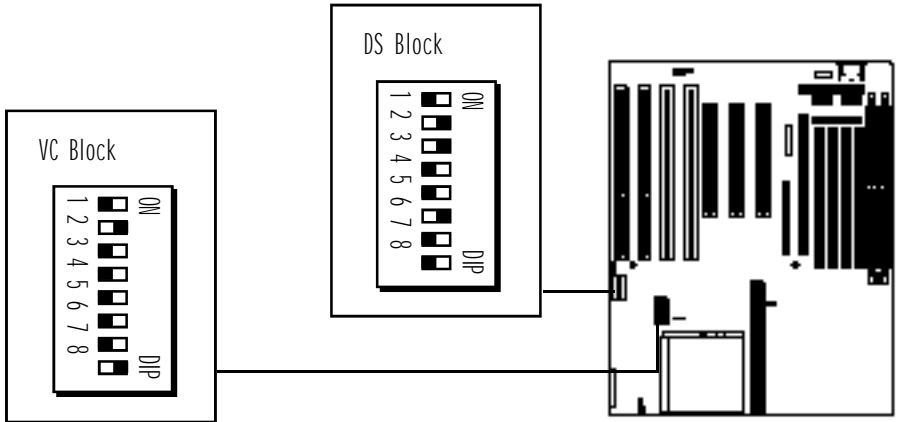

DS5 ISA Bus Clock Settings

External Clock	DS5	Bus Clock
50MHz	0 n	6.25MHz
	Off	8.33 MHz
60MHz	0 n	7.5 MHz
	Off	10MHz
66MHz	0 n	8.25 MHz
	Off	11 MHz

Note:

The suggested setting is highlighted in bold face type in the chart.

DS5 ON: ISA Bus Clock = External Clock \div 8

DS5 OFF: ISA Bus Clock = External Clock \div 6

Factory default setting is ON

Intel Pentium CPU Clock Multiplier Factor

Clock Factor	DS1	DS2	Clock Factor x External Clock=Internal Clock Speed (in MHz)
1.5	OFF	OFF	1.5x50=75; 1.5x60=90; 1.5x66=100
2	OFF	ON	2x60=120; 2x66=133
2.5	ON	ON	2.5x60=150; 2.5x66=166
3	ON	OFF	3x60=180; 3x66=200

Note: The factory default setting 2

*The internal clock speed also indicates which Pentium it is for e.g. "75" is for P75, "90" is for P90 etc.

Intel Pentium CPU Vcore/Vio Settings

Vcore/Vio	VC1	VC2	VC3	VC4	VC5	VC6	VC7	VC8
2.7V/3.3V	OFF	OFF	OFF	OFF	ON	OFF	OFF	ON
2.8V/3.3V	OFF	OFF	OFF	ON	OFF	OFF	OFF	ON
2.93V/3.3V	OFF	OFF	ON	OFF	OFF	OFF	OFF	ON
3.38V/3.3V	OFF	ON	OFF	OFF	OFF	OFF	OFF	ON
3.52V/3.3V	ON	OFF	OFF	OFF	OFF	OFF	OFF	ON

Note: The factory default setting is 3.38V. (VRE=3.52V, STD/VR=3.38V)

Intel Pentium CPUs

Clock Chip: PLL52C61-01 or PLL52C61-21

CPU:Ext/Int Clock	Ext. Clock Factor		Ext. Clock Freq.: Normal/Turbo			ISA Spd	Refresh
	DS1	DS2	DS3	DS4	DS7	DS5	DS6
P75:50/75MHz	OFF	OFF	0N/—	0N/—	0N/—	OFF	OFF
P90:60/90MHz	OFF	OFF	0N/OFF	0N/OFF	0FF/0N	0N	OFF
P100:66/100MHz	OFF	OFF	OFF/OFF	0N/OFF	0N/OFF	0N	OFF
P120:60/120MHz	OFF	0N	0N/OFF	0N/OFF	0FF/0N	0N	OFF
P133:66/133MHz	OFF	0N	OFF/OFF	0N/OFF	0N/OFF	0N	OFF
P150:60/150MHz	0N	0N	0N/OFF	0N/OFF	0FF/0N	0N	OFF
P166:66/166MHz	0N	0N	OFF/OFF	0N/OFF	0N/OFF	0N	OFF
P200:66/200MHz	0N	OFF	OFF/OFF	0N/OFF	0N/OFF	0N	OFF

Clock Chip: PLL52C59-14T or ICS9159-14

CPU:Ext/Int Clock	Ext. Clock Factor		Ext. Clock Freq. —(Norm/Turbo)			ISA Spd	Refresh
	DS1	DS2	DS3	DS4	DS7	DS5	DS6
P75:50/75MHz	OFF	OFF	0N	0N	0FF/0N	OFF	OFF
P90:60/90MHz	OFF	OFF	OFF	0N	0FF/0N	0N	OFF
P100:66/100MHz	OFF	OFF	0N	OFF	0FF/0N	0N	OFF
P120:60/120MHz	OFF	0N	OFF	0N	0FF/0N	0N	OFF
P133:66/133MHz	OFF	0N	0N	OFF	0FF/0N	0N	OFF
P150:60/150MHz	0N	0N	OFF	0N	0FF/0N	0N	OFF
P166:66/166MHz	0N	0N	0N	OFF	0FF/0N	0N	OFF
P200:66/200MHz	0N	OFF	0N	OFF	0FF/0N	0N	OFF

Note:

ICS9159-14 does not support Turbo mode at 75MHz

ISA Spd. —ISA Bus Clock speed, see page 2-19

Refresh —DRAM refresh [reserved for future use] always OFF

DS8 — reserved for future use, always OFF

AMD K5 CPU Clock Multiplier Factor

Clock Factor	DS1	DS2	Clock Factor x External Clock=Internal Clock Speed (in MHz)
1.5	OFF	OFF	1.5x50=75*; 1.5x60=90*; 1.5x66=100*
2	OFF	ON	2x60=120 (PR150); 2x66=133 (PR166)

Note: The factory default setting is 2.

*"75" is for PR75, "90" is for PR90 & PR120. "100" is for PR100 and PR133.

AMD AMD-K5 CPU Vcore/Vio Settings

Vcore/Vio	VC1	VC2	VC3	VC4	VC5	VC6	VC7	VC8
2.7V/3.38V	OFF	OFF	OFF	OFF	ON	OFF	ON	OFF
2.8V/3.38V	OFF	OFF	OFF	ON	OFF	OFF	ON	OFF
2.93V/3.38V	OFF	OFF	ON	OFF	OFF	OFF	ON	OFF
3.38V/3.3V	OFF	ON	OFF	OFF	OFF	OFF	OFF	ON
3.52V/3.3V	ON	OFF	OFF	OFF	OFF	OFF	OFF	ON

Note: The factory default Vcore setting is 3.38V.

The voltage figures shown are the mid-point of a range, e.g. the range of 3.52V is 3.45V to 3.6V

AMD-K5 CPUs (AMD-SSA/5 & AMD-K5)

Clock Chip: PLL52C61-01 or PLL52C61-21

CPU:Ext/Int Clock	Ext. Clock Factor		Ext. Clock Freq.: Normal/Turbo			ISA Spd	Refresh
	DS1	DS2	DS3	DS4	DS7	DS5	DS6
PR75:50/75MHz	OFF	OFF	0 N / -	0 N / -	0 N / -	OFF	OFF
PR90:60/90MHz	OFF	OFF	0N/OFF	0N/OFF	0FF/0N	0 N	OFF
PR100:66/100MHz	OFF	OFF	OFF/OFF	0N/OFF	0N/OFF	0 N	OFF
PR120:60/90MHz	OFF	OFF	0N/OFF	0N/OFF	0FF/0N	0 N	OFF
PR133:66/100MHz	OFF	OFF	OFF/OFF	0N/OFF	0N/OFF	0 N	OFF
PR150:60/120MHz	OFF	0 N	0N/OFF	0N/OFF	0FF/0N	0 N	OFF
PR166:66/133MHz	OFF	0 N	OFF/OFF	0N/OFF	0N/OFF	0 N	OFF

Clock Chip: PLL52C59-14T or ICS9159-14

CPU:Ext/Int Clock	Ext. Clock Factor		Ext. Clock Freq. -(Norm/Turbo)			ISA Spd	Refresh
	DS1	DS2	DS3	DS4	DS7	DS5	DS6
PR75:50/75MHz	OFF	OFF	0 N	0 N	0FF/0N	OFF	OFF
PR90:60/90MHz	OFF	OFF	OFF	0 N	0FF/0N	0 N	OFF
PR100:66/100MHz	OFF	OFF	0 N	OFF	0FF/0N	0 N	OFF
PR120:60/90MHz	OFF	OFF	OFF	0 N	0FF/0N	0 N	OFF
PR133:66/100MHz	OFF	OFF	0 N	OFF	0FF/0N	0 N	OFF
PR150:60/120MHz	OFF	0 N	OFF	0 N	0FF/0N	0 N	OFF
PR166:66/133MHz	OFF	0 N	0 N	OFF	0FF/0N	0 N	OFF

Note:

ICS9159-14 does not support Turbo mode at 75MHz

ISA Spd. — ISA Bus Clock speed, see page 2-19

Refresh — DRAM refresh [reserved for future use] always OFF

DS8 — reserved for future use, always OFF

Cyrix 6x86 CPU Clock Multiplier Factor

Clock Factor	DS1	DS2	Clock Factor x External Clock=Internal Clock Speed (in MHz)
2	OFF	0 N	2x50=100 (P120+); 2x55=110 (P133+); 2x60=120 (P150+); 2x66=132 (P166+); 2x75=150 (P200+)*
2.5	0 N	0 N	2.5x66=166 (Cyrix M2)
3	0 N	OFF	3x60=180; 3x66=200; 3x75=225 (Cyrix M2)
3.5	OFF	OFF	

Note: * P series are Cyrix 6x86 or 6x86L

Cyrix 6x86 CPU Vcore/Vio Settings

Vcore/Vio	VC1	VC2	VC3	VC4	VC5	VC6	VC7	VC8
2.7V/3.3V	OFF	OFF	OFF	OFF	0 N	OFF	OFF	0 N
2.8V/3.3V	OFF	OFF	OFF	0 N	OFF	OFF	OFF	0 N
2.93V/3.3V	OFF	OFF	0 N	OFF	OFF	OFF	OFF	0 N
3.38V/3.3V	OFF	0 N	OFF	OFF	OFF	OFF	OFF	0 N
3.52V/3.3V	0 N	OFF	OFF	OFF	OFF	OFF	OFF	0 N

Note: Recommended setting for 6x86 CPUs is 3.52V/3.3V.

The voltage figures shown are the mid-point of a range, e.g. the range of 3.52V is 3.45V to 3.6V

Cyrix 6x86 CPUs

Clock Chip: PLL52C61-01 or PLL52C61-21

CPU:Ext/Int Clock	Ext. Clock Factor		Ext. Clock Freq.: Normal/Turbo			ISA Spd	Refresh
	DS1	DS2	DS3	DS4	DS7	DS5	DS6
P120+:50/100MHz	OFF	0N	0N / -	0N / -	0N / -	OFF	OFF
P133+:55/110MHz	OFF	0N	0N / -	OFF / -	0N / -	0N	OFF
P150+:60/120MHz	OFF	0N	0N/OFF	0N/OFF	OFF/0N	0N	OFF
P166+:66/133MHz	OFF	0N	OFF/OFF	0N/OFF	0N/OFF	0N	OFF
P200+:75/150MHz	OFF	0N	0N / -	OFF / -	OFF / -	0N	OFF

Clock Chip: PLL52C59-14T or ICS9159-14

CPU:Ext/Int Clock	Ext. Clock Factor		Ext. Clock Freq. -(Norm/Turbo)			ISA Spd	Refresh
	DS1	DS2	DS3	DS4	DS7	DS5	DS6
P120+:50/100MHz	OFF	0N	0N	0N	OFF/0N	OFF	OFF
P133+:55/110MHz	OFF	0N	OFF	OFF	OFF / -	0N	OFF
P150+:60/120MHz	OFF	0N	OFF	0N	OFF/0N	0N	OFF
P166+:66/133MHz	OFF	0N	0N	OFF	OFF/0N	0N	OFF
P200+:75/150MHz	OFF	0N	OFF	OFF	0N / -	0N	OFF

Note:

ICS9159-14 does not support Turbo mode at 75MHz

ISA Spd. -ISA Bus Clock speed, see page 2-19

Refresh -DRAM refresh [reserved for future use] always OFF

DS8 - reserved for future use, always OFF

System Memory Configuration

The PR5 is designed to provide the broadest possible memory configuration options. The design includes four sockets for the currently most common form factor, 72-pin SIMM modules and also has two sockets for the future standard, 168-pin DIMM modules. The DRAM on the SIMM modules can be either Fast Page mode or EDO DRAM. DIMM modules can use these and can also use the newer SDRAM (Synchronous DRAM). You can install a combined total 128MB of all memory types on the PR5 mainboard.

Pentium-type CPUs are 64-bit CPUs. This has a direct effect on the memory design. Since 72-pin SIMM sockets are 32-bit, they have to be used in pairs to create a 64-bit data path. This means that SIMM modules have to be installed in pairs. The four SIMM sockets on the PR5 are therefore divided into “banks” of two sockets each, resulting in two banks. Because DIMM sockets are 64-bit, each DIMM functions as a bank, resulting in another two banks for a total of four banks on the mainboard. The SIMM banks are organized so that SIMM1/SIMM2 are one bank, SIMM3/SIMM4 are another. The figure below shows the socket numbering.

SIMM & DIMM memory sockets

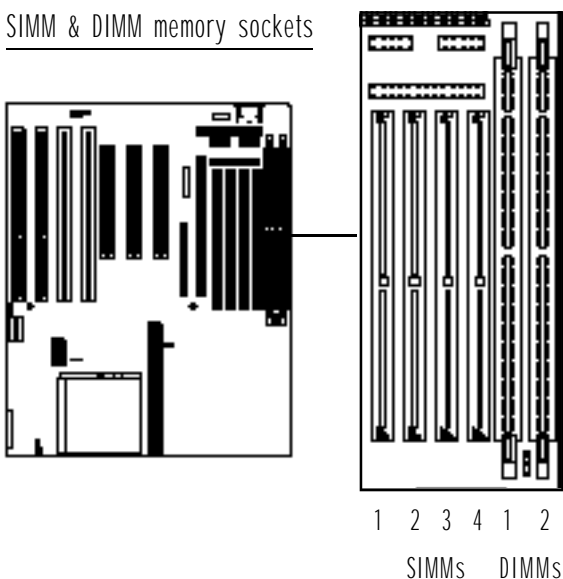



Important Note: Double-sided Modules

There is an important limitation in using double-sided SIMM or DIMM modules. Double-sided modules in one bank prevents the use of a corresponding bank of the other type of module. For example:

- If bank SIMM1/2 has 2-sided modules installed, you can not use the DIMM2 socket.
- If bank SIMM3/4 has 2-sided modules installed, you can not use the DIMM1 socket.
- If bank DIMM1 has a 2-sided module installed, you can not use the SIMM3/4 sockets.
- If bank DIMM2 has a 2-sided module installed, you can not use the SIMM1/2 sockets.

Double-sided modules are modules with memory chips mounted on both sides.

The PR5 has numerous possible system memory configurations using the four 72-pin SIMM sockets and the two 168-pin DIMM sockets. Please note these guidelines:

- Installed memory is auto-detected by the BIOS
- Minimum installation 2 SIMMs or 1 DIMM module for a 64-bit data path
- Fast Page (FP), EDO and SDRAM are all supported, SDRAM only supported on DIMM modules
- SIMMs: single or double-sided modules of 4MB and up supported
- DIMMs: single or double-sided modules of 8MB and up supported
- DIMM sockets support both 5-volt (FP or EDO) and 3.3-volt (Unbuffered) DRAM; voltage for both sockets is set by jumper JP11 (see below)
- Pairs of SIMMs must be the same memory type, size and speed but the type and size of a second pair, and any DIMMs can be different
- Memory Banks:
SIMM1 & SIMM2
SIMM3 & SIMM4
DIMM1
DIMM2
- Bank sequence doesn't matter, use any combination as long as other requirements are followed
- DRAM speed must be at least 70ns, can be faster
- Parity checking is not supported
- Maximum 128MB supported

There are numerous allowable memory configurations. Since bank sequence is not important, as long as you use SIMMs in pairs you can use any combination of banks.

However, for maximum performance it best to use the same type of DRAM in all banks. SDRAM provides higher performance than EDO DRAM and EDO is faster than Fast Page mode DRAM.

The chart on the next page gives examples of some of the possible configurations.

PR5 Memory Configuration Examples

SIMM Banks

You can install memory in bank SIMM1/2 only, SIMM2/3 only or both banks. The bank order doesn't matter. You must install two modules of the same size, type and speed in a bank.

You can mix different sizes between banks in any combination as long as the total doesn't exceed 128MB. You can even install different DRAM types in between banks (FP or EDO).

DIMM Banks

You can install memory in DIMM1 only, DIMM2 only or both. The order doesn't matter.

You can mix different sizes between banks in any combination as long as the total doesn't exceed 128MB

Mixed SIMMs & DIMMs

You can install memory in any bank combination, mixing SIMM and DIMM banks as long as the total doesn't exceed 128MB and you observe the limitation regarding 2-sided modules

SIMM1/2	SIMM3/4	Total		
4MB/4MB		8MB		
8MB/8MB		16MB		
16MB/16MB		32MB		
32MB/32MB		64MB		
64MB/64MB		128MB		
4MB/4MB	4MB/4MB	16MB		
8MB/8MB	16MB/16MB	48MB		
16MB/16MB	32MB/32MB	96MB		
32MB/32MB	4MB/4MB	72MB		
DIMM1	DIMM2	Total		
	8MB	8MB		
	16MB	16MB		
	32MB	32MB		
8MB	16MB	24MB		
16MB	32MB	48MB		
32MB	8MB	40MB		
32MB	32MB	64MB		
SIMM1/2	SIMM3/4	DIMM1	DIMM2	Total
8MB/8MB	8MB/8MB	16MB		48MB
8MB/8MB		16MB	16MB	48MB
8MB/8MB	16MB/16MB	16MB	32MB	96MB

Note: You can use mixed combinations as long as you follow the guidelines on page 2-27. Note the 2-sided module restriction.

DIMM Voltage Settings

The DIMM sockets support both 5-volt and 3.3-volt unbuffered DRAM. The voltage setting for both DIMM sockets is controlled by jumper JP11. The socket voltage setting must match the voltage of the DRAM on any DIMM modules you install. The jumper settings are shown below.

JP11: DIMM Voltage

	Pins 1-2	Pins 2-3
5-Volt DIMM	Short	N A
3-Volt DIMM	N A	Short [Default]

Note:

5-Volt = FP or EDO DRAM

3-Volt = 3.3-Volt Unbuffered DRAM



DIMM Voltage Settings

Jumper JP11 sets the voltage supplied to the DIMM sockets.

Default Setting : 3-Volt.



Jumper JP11 Location

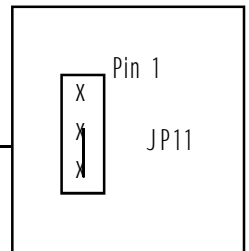

Installing Memory Modules

Installing memory modules is easy, but there are a few important precautions you should take whether you are installing SIMM or DIMM modules.

The most important is to guard against damage to the modules from static discharge. A strong enough discharge can make a module unusable and ruin your investment. If you're not familiar with static precautions, you may want to review the information on this in Section 1.

In addition to taking precautions against damage from static discharge, you should avoid touching a module's edge connector when you are handling it. The edge connector is the part of the module that inserts in the socket on the mainboard. Oil from your fingers can cause corrosion on the connector contacts as well as in the sockets, possibly resulting in an eventual malfunction.

Module Orientation

All memory modules must be oriented correctly before you can insert them in the socket. SIMM and DIMM modules have different designs for ensuring correct module orientation.

SIMM modules have one lower corner cut away to ensure they will only insert in a socket in the correct orientation. The SIMM sockets have an extension from one of the socket guide posts that prevents the module from inserting in the socket if it isn't oriented correctly.

DIMM modules have a long edge connector divided into sections, two longer and one shorter. The DIMM sockets are divided accordingly, so the orientation is obvious.

Installing SIMMs

To install any kind of SIMM module do as follows:

1. Orient the cut-away corner so that it is at the lower end of the socket.
2. Insert the module edge into the socket at about a 45° angle so that the contacts are as far in as they will go.
3. Push the module up into the retaining clips so that the clips clamp over the edge of the module. The holes at each end of the module should fit over the protrusion on the guide post.

It is a good idea to use the sockets from left to right to make installation easier.

Installing DIMMs

To install any kind of DIMM module do as follows:

1. Orient the short section of the edge connector so that it is at the upper end of the socket.
2. Insert the module edge into the socket at a 90° angle so that the contacts insert as far as they will go.
3. The retaining clamps at each end rotate upward to secure the module in the socket.

The figure below shows where the orientation features are located.

Memory Module Orientation

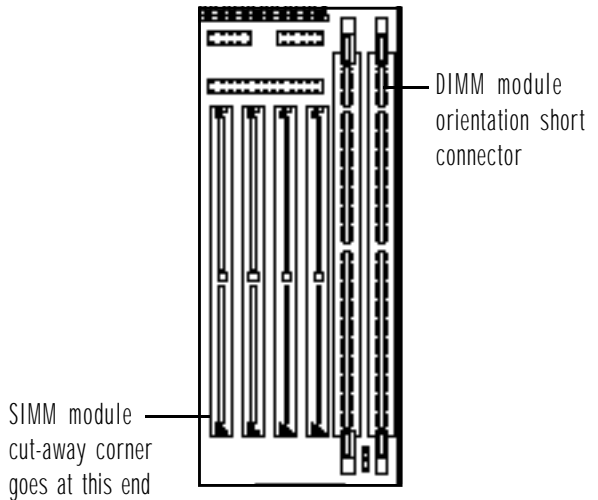

Level 2 Cache Options

The Level 2 cache on the PR5 greatly speeds up system operation. There will be at least 256KB of very fast Pipeline Burst Static RAM (SRAM) cache memory mounted either on the mainboard or on a cache module that installs in the cache socket. You can upgrade the Level 2 cache to a maximum of 512KB regardless of whether the memory is on the board or on a module.

If there is 256KB of cache memory mounted on the mainboard, you can use a 256KB cache module to upgrade the Level 2 cache to 512KB. See the cache options in the following table. Jumper JP1 sets the cache size.

PR5 Level 2 Cache Configuration Settings

Onboard	Module	Total	JP1 Setting
0KB	0KB	0KB	OFF
256KB		256KB	OFF
	256KB	256KB	OFF
256KB	256KB	512KB	ON
512KB		512KB	OFF
	512KB	512KB	ON

Note: Onboard 256KB uses 32K32 SRAM, 512KB uses 64K32 SRAM. JP1 settings, ON = Jumper cap installed, OFF = Cap on one pin only.

Jumper JP1 Location

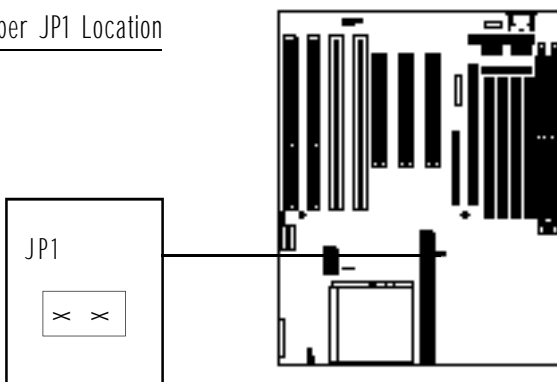

Onboard Connectors

There are several connectors for various features on the mainboard. If your PR5 is already installed in a system, you can skip this section. The PR5 has onboard connectors for the floppy and hard disk controllers, I/O ports, connections from your system case and several other features. Their locations are shown in the Configuration Quick Reference, so they are not repeated here. This section explains what the connectors are and how they work.

Disk Drive Controller & I/O Port Connectors

The PR5 has floppy disk drive and Enhanced IDE controllers built-in. The EIDE controller is for both hard disk drives and other devices which have an EIDE interface such as CD-ROM drives. You connect disk drives or other devices to the connectors on the mainboard using cables that come with it.

The PR5 also has I/O (Input/Output) ports built-in including serial, parallel and USB port connectors onboard. External ports connect to the onboard connectors via the cables attached to ports.

Drive Controller Connectors

The PR5 comes with ribbon cables to connect your system floppy disk and IDE drives to the mainboard. The cables are colored on one edge to show you how to orient the cable. That edge of the cable must be at the Pin 1 end of the onboard connector when connected.

The Floppy Disk Drive Controller connects to your system floppy drive or drives with the floppy drive ribbon cable that comes with the PR5. One end of the cable attaches to the FDC connector on the mainboard and the other attaches to the floppy disk drive. There are three connectors on the cable, one at each end and one in between, closer to one end than the other. Floppy drive A: attaches to the end of the cable and drive B:, if you have one, attaches to the connector in the middle. The connector at the other end connects to the mainboard.

The two Enhanced IDE Controller connectors are for the two IDE channels Channel 1 and Channel 2. Channel 1 is the Primary channel and is divided in two as the Primary Master and Primary Slave. Channel 2 is the Secondary channel and is organized the same way. There are ribbon cables for each channel. Enhanced IDE allows a total of four devices, two attached to each IDE channel. The first device in each channel attaches to the end of the cable. A second device attaches to the connector in the middle and the other end of the cable attaches to the mainboard.

Your start-up (boot) IDE hard disk drive must be connected as the Primary Master (end of the cable). You can attach a second hard drive in any of the other three available positions.

The location of the connectors and their Pin 1 positions are shown in the Configuration Quick Reference.

I/O Port Connectors

The PR5 has two serial ports, a parallel port, an infrared port and a dual-port USB connector onboard. Combination ribbon cable-to-external port cables are supplied for each connector except the infrared port. The I/O ports enable you to connect external devices such as modems and printers to your system. The serial ports are the COM1 and COM2 ports and the parallel port is the LPT1 printer port. There are also some other devices which have a parallel interface and can connect to the LPT port. An example of this kind of device is a parallel interface external tape backup drive.

The IR (InfraRed) and USB ports are both a new type of PC port. The IR port allows wireless two-way communication between your computer and other devices with IR capability. The Universal Serial Bus is a new specification for connecting external peripheral devices with the same interface.

The location of the connectors and their Pin 1 positions and the pin assignments for the Infrared and USB ports are shown in the Configuration Quick Reference.

System Enclosure Connectors

The system enclosure is your system case. There are usually several features built-in to the case that connect to the mainboard. The PR5 has connections for a number of these in a connector block which includes connectors for a Reset button, Suspend switch, Turbo LED, Speaker and Keyboard lock. Your system case may or may not have all of these features.

The location of the connector block and the pin assignments are shown in the Configuration Quick Reference.

Other Connectors

There are several other connectors on the PR5, including the power input, keyboard, PS/2 mouse, IDE activity LED and CPU fan connectors. Their locations and pin assignments are shown in the Configuration Quick Reference.

Power Input Connector

The system power supply connector is a 12-pin connector, divided into two sections, P8 and P9. The leads from the system power supply plug onto this connector and snap into place. If you connect the leads yourself make sure you plug them on so that the black wires on each lead are in the middle of the connector.

Keyboard & PS/2 Mouse Connectors

The external keyboard connector is a standard “AT” DIN keyboard connector. The PS/2 connector is a 6-pin block for the PS/2 mouse port cable.

The PR5 accepts two keyboard types, the AT keyboard with its larger jack fits the onboard keyboard connector directly. A PS/2 keyboard, which has a smaller jack, connects to the keyboard port with a PS/2-to-AT jack adapter. The onboard PS/2 connector is for the PS/2 mouse port. If you want to use this type of mouse in your system, you can connect it to the external PS/2 port.

The keyboard connector and PS/2 port pin assignments are shown in the following table.

AT Keyboard & PS/2 Port Pin Assignments

Pin Function

AT Keyboard

Pin 1 Keyboard Clock

Pin 2 Keyboard Data

Pin 3 Not used

Pin 4 Ground

Pin 5 +5-Volts DC

PS/2 Port

Pin 1 Mouse Data

Pin 2 Not used

Pin 3 Ground

Pin 4 +5-Volts DC

Pin 5 Mouse Clock

Pin 6 Not Used

IDE Activity LED Connector

The IDE activity LED connector is a 4-pin connector which will accept either a 2-pin or 4-pin IDE LED activity light connector. This light comes on when an IDE device in your system is being accessed. If you are connecting a lead from an LED activity light on your case, make sure you identify which wire is the positive wire and orient the lead's connector so that the positive wire connects to the positive pin on the onboard connector. The pin connector assignments are in the Configuration Quick Reference if you need them.

CPU Fan Power Connector

The CPU fan power connector is a 3-pin connector header which will accept either a 2-pin or 3-pin CPU fan power lead connector. Some CPU fans have a connector for a standard power lead from the system power supply. If your CPU fan is attached to the top of the CPU chip, as with some Intel Pentiums, the power lead connector should fit this onboard connector. If you are connecting a lead from a CPU cooling fan to this connector, make sure you identify which wire is the positive wire and orient the lead's connector so that the positive wire connects to the positive pin on the onboard connector. The pin connector assignments are in the Configuration Quick Reference if you need them.

DIP Switch & Jumper Summary

This section lists the function of all the DIP switches and jumpers on the board for your reference.

DIP Switch & Jumper Functions	
	Function
DS DIP Block	
Switch 1	External Clock Factor
Switch 2	External Clock Factor
Switch 3	External Clock Frequency
Switch 4	External Clock Frequency
Switch 5	ISA Bus Clock
Switch 6	DRAM Refresh
Switch 7	External Clock Frequency
Switch 8	Reserved
VC DIP Block	
Pin 1 – 8	Vcore/Vio voltage settings
Jumpers	
JP1	L2 Cache
JP3	Clear CMOS
JP8	Flash ROM Type
JP10	Reserved
JP11	DIMM Voltage

Other Jumper Functions

There are two other jumpers on the PR5 which have not been mentioned yet. One is JP3 (Clear CMOS Memory) and the other is JP8 (Flash ROM Type).

JP3: Clear CMOS Memory

The onboard CMOS memory is where the system configuration information set by the BIOS Setup program is stored. If you make entries in the Setup program that will prevent the computer from booting up or you set a password and then forget it, you will not be able to use the computer. If this happens, you must clear (erase) the CMOS memory and enter new configuration information in the BIOS Setup program. The BIOS Setup program is covered in Section 3.

To clear the CMOS memory do as follows:

1. Remove the jumper cap from Pins 1&2
2. Place the cap over Pins 2&3 for five seconds
3. Replace the cap over Pins 1&2

When you are done, you can start up your computer and run the Setup program to re-enter the system configuration information. The location of JP3 is shown below.

Jumper JP3 Location

JP3: Clear CMOS Memory

To clear CMOS memory, remove the jumper cap from pins 1&2 and place it over pins 2&3 for five seconds, then replace the cap over pins 1&2.

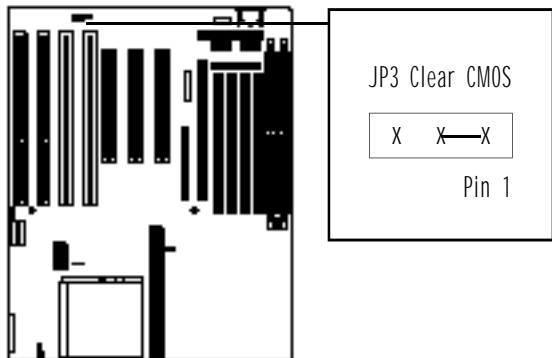

JP8: Flash ROM Type

This jumper is set at the factory for the type of Flash ROM chip installed. You should not change the setting and it is shown here for reference only. This jumper may be replaced by hardwiring directly onboard on some boards. There are two types of Flash ROM chip, 5-Volt and 12-Volt. The chip type has no functional effect. The settings and location are shown below.

Jumper JP8 Location

JP8: Flash Chip Type

This jumper is factory set for the type of Flash Memory Chip installed. The jumper may not be present on some boards, with the setting hardwired on the board instead.

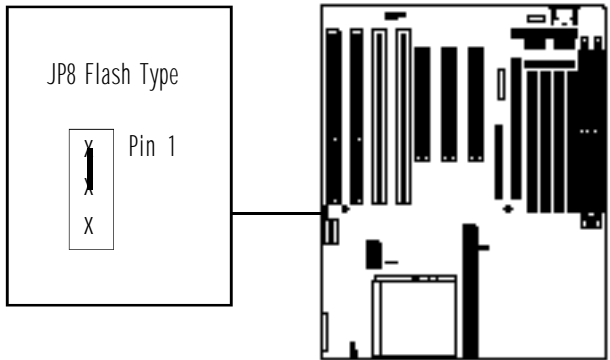

JP8: Flash Memory Chip Type

	Pins 1-2	Pins 2-3
5-Volt Chip	Short	
12-Volt Chip		Short

Note: Jumper may not be present and may be hardwired instead

Technical Information

This section covers three topics:

- CPU Specifications
Detailed information on CPU specifications to help you identify precisely the CPU you want to install, so that you can determine the correct configuration settings.
- IDE Installation Guide
A guide to installing IDE devices that connect to the onboard Enhanced IDE controller.
- Technical Support
Useful information to answer questions and help make solving problems easier.

Section 4

CPU Specifications

IDE Installation Guide

Technical Support

CPU Specifications

This section is made up of tables and diagrams designed to help you identify the CPU you want to install. You need to identify your CPU in order to determine the correct configuration settings.

CPU's from Intel, AMD, and Cyrix are covered here. CPUs vary within a specific type; a 120MHz Pentium for example, can have different power and timing specifications depending on which type and "Step" (version) it is.

To identify a CPU you'll need to examine the chip to obtain specification information that is printed on the chip. The diagrams for AMD and Cyrix CPUs explain how to interpret the information on the chip.

Intel CPUs

This section lists the specifications for Intel Pentium CPUs. The following tables use some abbreviations as follows:

Power

STD – 3.15V ~ 3.465V (Suggested setting 3.38V)

VR – 3.3V ~ 3.465V (Suggested setting 3.38V)

VRE – 3.45V ~ 3.6V (Suggested setting 3.52V)

Timing

STD – Standard Timing

MD – Minimum Delay (Shorter minimum valid delay AC timing for some signals)

KIT – Supports timing for C55/C88 cache chipsets

Also, please note the following:

P54C

Beginning with the P54C E-Step, Standard timing was replaced by existing Min Delay timing.

P54CS

P54CS PPGA UP:No DP, No APIC, No FRC

Beginning with the P54C E-Step, Standard timing was replaced by existing Min Delay timing.

P55C

P55C A-Step is NOT a production stepping.

A-1 Step: Vcc and timing on initial samples is 2.9V +/- 0.1V.

A-2 Step & B Step: Vcc and timing on production stepping is 2.8V +/- 0.1V.

Software Configuration

This section explains the information you need to know to establish your systems basic configuration and customized settings and also has information on software that comes with your PR5 mainboard.

The first part of this section is about the BIOS CMOS Setup Utility program. There is also some information on updating the BIOS and the IDE driver disk that comes with the PR5.

Section 3

BIOS CMOS Setup Utility

Updating the BIOS

IDE Driver Disk

The BIOS CMOS Setup Utility

The PR5 uses the Award system BIOS. The BIOS (Basic Input Output System) is the basic software the computer needs to enable the system hardware components to operate together. It is stored in a Flash ROM memory chip on the mainboard. The BIOS uses a software program, also stored on the same chip to create a system configuration record which is saved in a small amount of special "CMOS" memory which is also on the board.

This Setup program records information about the system hardware including the disk drives installed, system memory and video display. It also records system customization information and settings for the mainboard's chipset, power management and configurable hardware. In addition, the Setup program has a Password feature, automatic hard disk detection and a hard disk low level format command.

Accessing The CMOS Setup Utility

When you turn on your computer, a message appears on the screen saying you can call up the Setup program. The message appears after the POST (Power On Self Test):

TO ENTER SETUP BEFORE BOOT PRESS CTRL-ALT-ESC OR DEL KEY

If you want to run Setup but you don't respond in time before the message disappears, you can reset the system by pressing the Ctrl + Alt + Delete keys at the same time, or by pushing the system Reset button. The message will then reappear.



Warning

Please don't change any default settings unless you are sure you know what you are doing. It is possible to establish settings that will prevent the computer from booting up. If this happens, refer to Clearing CMOS Memory in Section 2.

After you press the Del key the program menu screen will appear, displaying the various sections of the Setup utility and some commands.

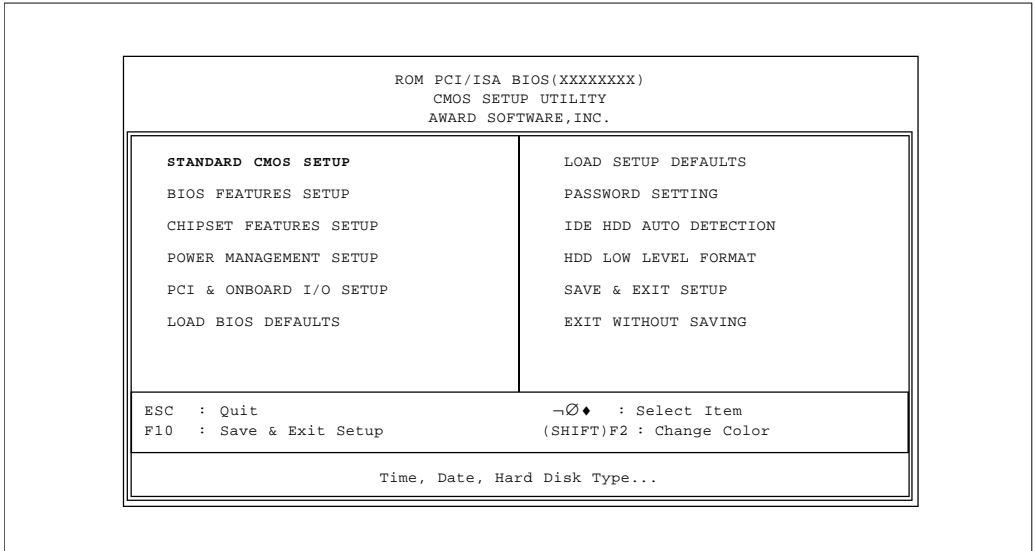

Award BIOS CMOS Setup Utility Main Menu

Menu Commands

If you look at the lower portion of the screen illustration you'll see a section that lists the control commands for this level of the program. You execute a command by pressing the key for that command. The program commands are :

Quit

This command will close the Setup program when you press the ESC key.

Save & Exit Setup

This will save the current settings and close the Setup program when you press the F10 key.

Select Item

You can use the arrow keys on your keyboard to move around the screen and select a menu item. An item is highlighted when it is selected.

Change Color

You can change the program color scheme by pressing Shift + F2.

The section at the bottom of the screen displays a brief explanation of the highlighted menu item's function.



CMOS Memory Battery Support

The Setup program's configuration record is stored in CMOS memory which is maintained by a battery backup. If the record is lost or corrupted, or if you change your system hardware configuration, you need to redo the record. The configuration record can be lost or corrupted if the onboard battery fails.

There are five main sections to the Setup program:

- **Standard CMOS Setup**
Date, time, disk drive, video display and error handling settings.
- **BIOS Features Setup**
System operation customization features and video display function settings.
- **Chipset Features Setup**
Automatic or required settings for the PR5's chipset. Memory configuration feature for specialized add-on cards requiring custom address space.
- **Power Management Setup**
Sets up the "green" power management features.
- **PCI & Onboard I/O Setup**
PCI expansion bus and drive controller settings; serial, parallel and IR port settings.

The other main menu items interact with these main sections:

- **Load BIOS Defaults**
Loads minimum settings from the BIOS ROM.
- **Load Setup Defaults**
Loads standard settings from the BIOS ROM.
- **Password Setting**
Sets system password which is configured by the Security Option item in BIOS Features Setup.
- **IDE HDD Auto Detection**
Automatically detects the drive parameters of any installed IDE hard disk drives and enters them automatically in the Standard CMOS Setup.
- **HDD Low Level Format**
Hard disk drive low level format program. See the warning in the section about using this.
- **Save & Exit Setup**
Saves the current settings and exits the program.
- **Exit Without Saving**
Discards any changes made during the current session and exits the program.

To enter a section of the Setup program, highlight the menu item and press the Enter key.

Standard CMOS Setup

To enter this section of the Setup program, highlight this menu item in the main menu and press the Enter key. The following screen will appear.

```
ROM PCI/ISA BIOS (XXXXXXXX)
STANDARD CMOS SETUP
AWARD SOFTWARE, INC.

Date (mm:dd:yy): Wed, Aug 21 1996
Time (hh:mm:ss): 10: 30: 00

HARD DISKS          TYPE      SIZE      CYLS  HEADS  PRECOMP  LANDZ  SECTOR  MODE
-----
Primary Master    : None      0          0      0      0        0      0      0  -----
Primary Slave     : None      0          0      0      0        0      0      0  -----
Secondary Master  : None      0          0      0      0        0      0      0  -----
Secondary Slave   : None      0          0      0      0        0      0      0  -----

Drive A : 1.44M, 3.5 in.
Drive B : None
Floppy 3Mode Support : Disable

Video : EGA/VGA
Halt On : All Errors

Base Memory: 640K
Extended Memory: 7168K
Other Memory: 384K
-----
Total Memory: 8192K

ESC :Quit          -∅♦ : Select Item      PU/PD/+/- : Modify
F1  :Help          (SHIFT)F2 : Change Color   F3: Toggle Calendar
```

Award BIOS Standard CMOS Setup

Menu Commands

If you look at the lower portion of the screen illustration you'll see a section that lists the control commands for this level of the program. You execute a command by pressing the key for that command. The program commands are :

Quit

This command will close the Setup program when you press the ESC key.

Help

This displays information about the highlighted item when you press the F10 key.

Select Item

You can use the arrow keys on your keyboard to move around the screen and select a menu item. An item is highlighted when it is selected.

Change Color

You can change the program color scheme by pressing Shift + F2.

Modify

To change the setting of a highlighted selection you can press either the Page Up (PU) and Page Down (PD) keys or the Plus (+) and Minus (–) keys. Pressing a key once will switch to the next setting option for the selected item.

Toggle Calendar

Pressing the F3 key toggles between the system memory list shown on the screen illustration and a calendar for the month set by the Date setting.

If your mainboard is already installed in a working system the proper entries are already entered on this screen and you shouldn't change them except for adjusting the Date and Time entries if necessary.

Date & Time

The first two lines on the screen are the date and time settings for the system clock.

Hard Disk Type & Parameters

Use the IDE HDD Auto Detection feature to automatically enter the drive parameters of IDE hard disk drives in these fields. If you have only SCSI hard disk drives installed in your system leave the settings here at None. Only hard disk information needs to be entered here. Other IDE devices do not use this.

For an IDE hard drive, you should set the entry to "Auto" and the BIOS will automatically detect all drive information needed. You can use the IDE HDD Auto Detection utility described later to supervise the auto-detection process. If you want to do this, leave the drive set to "None". You can also enter specifications manually by using the "User" option.

Large Hard Disk Modes

The last of the drive parameter entries – Mode – has three options, Normal, LBA and Large. The Mode settings are for IDE hard disks only, and it is important to understand their function.

Normal

For IDE hard disks of 528MB or less.

LBA

This stands for Logical Block Addressing, the current standard access mode for large IDE hard disk drives. It allows the use of hard disks larger than 528MB by causing the IDE controller to translate between the logical address it creates and the hard disk's actual physical address. The maximum drive size supported is 8.4GB.

Large

For 1GB or smaller drives with more than 1024 cylinders and no LBA support. This access mode causes the Operating System to treat the drive as if it has fewer than 1024 cylinders by dividing the cylinder total in half and doubling the number of heads. Drives needing this mode are less common.

Most large IDE hard disk drives currently available use the LBA mode.

Floppy Disk Drives

The two floppy disk drive items set the drive type for drives A and B, and must be entered manually. The options are

360KB, 5.25 in.

1.2MB, 5.25 in.

720KB, 3.5 in.

1.44MB, 3.5 in.

2.88MB, 3.5 in.

None

Highlight the listing after each drive name and select the appropriate entry.

Floppy 3Mode Support

3Mode is a Japanese 3.5-inch floppy disk drive specification. If this type of drive is installed you should enable this feature. The default setting is Disabled.

Video Display Types

You set this according to the type of display card in your system. This should normally be left on EGA/VGA. The options are:

EGA/VGA

Mono (for Hercules or MDA)

CGA 40

CGA 80

Error Handling

The last line – Halt On – sets when the system stops if an error occurs. The options are:

All Errors (Default)

No Errors

All, But Keyboard

All, But Diskette

All, But Disk/Key

When you are finished in this section, exit to the main menu screen by pressing the Esc key.

BIOS Features Setup

To enter this section of the Setup program, highlight this menu item in the main menu and press the Enter key. The following screen will appear.

ROM PCI/ISA BIOS (XXXXXXXX)	
BIOS FEATURES SETUP	
AWARD SOFTWARE INC.	
Virus Warning	:Disabled
CPU Internal Cache	:Enabled
External Cache	:Enabled
Quick Power On Self Test	:Enabled
Boot Sequence	:A,C
Swap Floppy Drive	:Disabled
Boot Up Floppy seek	:Disabled
Boot Up NumLock Status	:On
IDE HDD Block Mode	:Enabled
Typematic Rate Setting	:Enabled
Typematic Rate (Chars/Sec)	:30
Typematic Delay (Msec)	:250
Security Option	:Setup
PCI/VGA Palette Snoop	:Disabled
OS Select For DRAM >64MB	:Non-OS2
Video BIOS Shadow	:Enabled
C8000-CBFFF Shadow	:Disabled
CC000-CFFFF Shadow	:Disabled
D0000-D3FFF Shadow	:Disabled
D4000-D7FFF Shadow	:Disabled
D8000-DBFFF Shadow	:Disabled
DC000-DFFFF Shadow	:Disabled
ESC : Quit	-[O] : Select Item
F1 : Help	PU/PD/+/- : Modify
F5 : Old Values (SHIFT)	F2 : Color
F6	: Load BIOS Defaults
F7	: Load Setup Defaults

Award BIOS BIOS Features Setup

Menu Commands

If you look at the lower portion of the screen illustration you'll see a section that lists the control commands for this level of the program. You execute a command by pressing the key for that command. The program commands are :

Quit

This command will close the Setup program when you press the ESC key.

Help

This displays information about the highlighted item when you press the F10 key.

Select Item

You can use the arrow keys on your keyboard to move around the screen and select a menu item. An item is highlighted when it is selected.

Modify

To change the setting of a highlighted selection you can press either the Page Up (PU) and Page Down (PD) keys or the Plus (+) and Minus (–) keys. Pressing a key once will switch to the next setting option for the selected item.

Change Color

You can change the program color scheme by pressing Shift + F2.

Old Values

If you make changes during the current session and you don't want to keep them you can recall the last set of saved values for this page by pressing the F5 key.

Load BIOS Defaults

Pressing the F6 key loads the BIOS default settings for this page.

Load Setup Defaults

Pressing the F7 key loads the Setup default settings for this page.

If your mainboard is already installed in a working system the proper entries are already entered on this screen and you shouldn't change them.

Virus Warning

This protects the primary hard disk's boot sector and partition table from infection. Any attempt to write to them will halt the system and produce a warning message. If this happens, you can either allow the system to continue or stop it and boot from a virus-free bootable floppy disk. Use an anti-virus utility located on the floppy disk to check the hard disk. The default setting is Disabled.

CPU Internal Cache

This enables CPU's Level 1 built-in cache. Leave it enabled to maintain system performance. The default setting is Enabled.

External Cache

This is the Level 2 external cache of either 256KB or 512KB. Leave this enabled to maintain system performance. The default setting is Enabled.

Quick Power On Self Test

This feature speeds up the Power On Self Test (POST) by skipping some parts of the POST. If your system is functioning normally, you can enable this feature to speed the boot process. The default setting is Enabled.

Boot Sequence

This determines the order in which the computer checks drives for an operating system. This allows you to configure the system to boot from a CD-ROM drive as well as the drive A: floppy disk drive and the drive C: boot hard disk. The options are:

A, C

C,A

C, CD-ROM, A

CD-ROM, C, A

Swap Floppy Drive

This switches the floppy drive assignments so that drive A is treated as drive B: and drive B: as drive A: under DOS. The default setting is Disabled.

Boot Up Floppy Seek

When enabled, the BIOS checks the floppy disk drive(s) to see if they are 40-track (360KB floppy disk drive) or 80-track (all other types). Don't enable this unless your system has a 360KB floppy drive. The default setting is Disabled.

Boot Up NumLock Status

This item allows you to select which mode the numeric keypad on an IBM-compatible extended keyboard is set to when the computer boots up. The options are:

On – Numeric keypad mode (Default)

Off – Cursor control mode

IDE HDD Block Mode

This mode improves performance by making multi-sector transfers from the hard disk instead of one sector per transfer. Older IDE drives may not support this feature. The default setting is Enabled.

Typematic Rate Setting

When enabled, you can set the two keyboard typematic controls that follow. The default setting is Disabled.

Typematic Rate (Char/Sec)

Adjusts the keystroke repeat rate. The choices range from 6 to 30 characters per second. The default is 30.

Typematic Delay (Msec)

Adjusts the character display interval (the time between the display of one character and the next. There are four delay rate choices measured in milliseconds: 250, 500, 750 and 1000. The default is 250.

Security Option

This sets when password protection is used. The two options are:

System –Password required at boot up

Setup –Password controls access to Setup utility

You create a password using the Password Setting option in the main menu. If no password is set, the system ignores this item.

PCI/VGA Palette Snoop

If your video display card has an MPEG card attached to the feature connector, the display may invert to black on white while booting. If this happens with your system configuration, enable this feature to correct the problem. The default setting is Disabled.

OS Select For DRAM >64MB

If your system has more than 64MB of system memory installed and you are using the OS/2 operating system, set this to the OS2 setting. The default setting, Non-OS2, is for all other operating systems.

Video BIOS Shadow

This copies the video display card BIOS into system DRAM to increase display speed and is required for system performance. The default setting is Enabled.



The Shadow Feature

The term "Shadow" mentioned at right refers to a performance enhancement feature whereby the system BIOS and video display card BIOS are copied into system DRAM to speed up system operation. The system BIOS is always shadowed. It is highly advisable to shadow the video BIOS. The other address range options allow shadowing of any other expansion card installed in your system that has a BIOS.

Shadowing Address Ranges

The next six lines, from C8000-CBFFF Shadow to DC000-DFFFF Shadow are address ranges for shadowing other expansion card ROMs. If there are any expansion cards with ROMs installed in your system, you have to know the address range they use to shadow them specifically. The default setting for all of these is Disabled.

When you are done in this section press the Esc key to return to the main menu.

Chipset Features Setup

To enter this section of the Setup program, highlight this menu item in the main menu and press the Enter key. The following screen will appear.

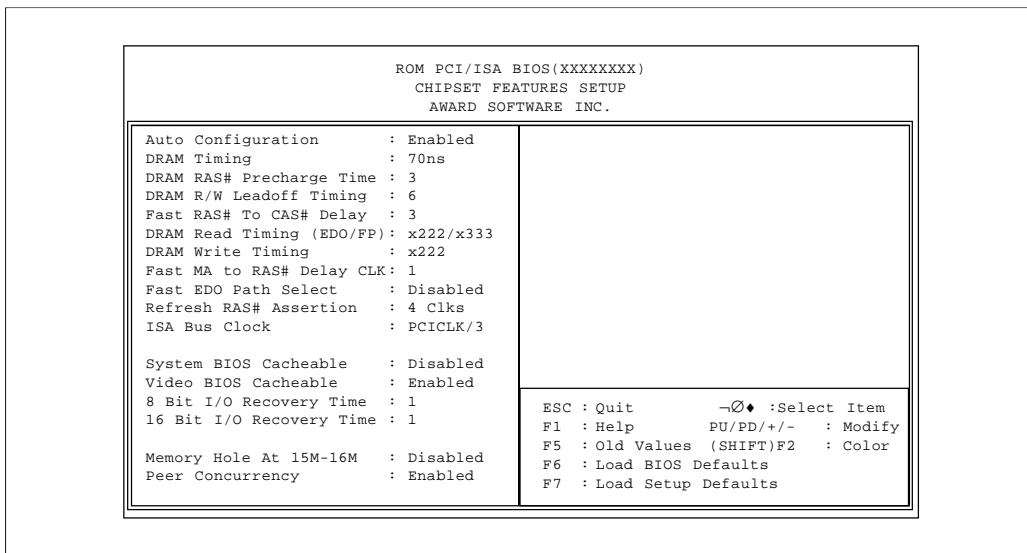

Award BIOS Chipset Features Setup

Menu Commands

The menu commands for this screen are the same as for the BIOS Features Setup screen.

Auto Configuration

Everything on this screen except for the Memory Hole item is set automatically when auto-configuration is active. If you disable it you can set the values manually, although we strongly recommend against this. Don't disable this unless you really know what you are doing. The default setting is Enabled.

Memory Hole At 15M-16M

Some special add-on cards require a 1MB address space between 15 and 16MB. The documentation for this type of card should tell you if it needs this. The default setting is Disabled.

To return to the main menu press the Esc key.

Power Management Setup

To enter this section of the Setup program, highlight this menu item in the main menu and press the Enter key. The following screen will appear.

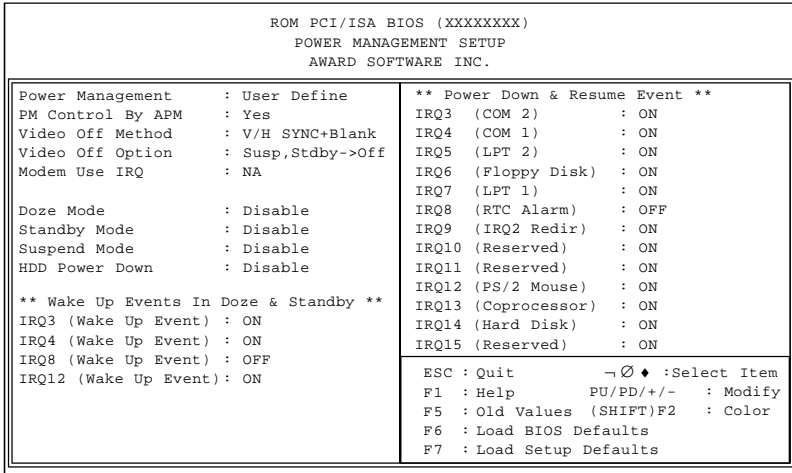

Award BIOS Power Management Setup

Menu Commands

The menu commands for this screen are the same as for the BIOS Features Setup screen.

What Power Management Does

Power management lets you set up your computer to save electricity when it is not actively in use by putting the system into progressively greater power saving modes. In the power management scheme there are four system states which proceed in the following sequence:



Power Management

This controls the entire power management scheme. There are four settings:

User Defined

You set the power saving options manually

Disable

Turns off all power management

Max Saving

Maximizes power saving by activating maximum power saving settings after one minute of system inactivity

Min Saving

Produces less power saving by activating moderate power saving settings after one hour of system inactivity

PM Control By APM

When this is set to Yes the Advanced Power Management feature in Microsoft Windows controls power management operation. The default setting is No.

Video Off Method

This governs monitor power saving by controlling how power management blanks the monitor screen. The default setting blanks the screen and turns off vertical and horizontal scanning and requires a monitor with “green” features. If you don’t have this type of monitor, use the Blank option. DPMS (Display Power Management System) allows the BIOS to control the video display card if the card has the DPMS feature.

V/H SYNC+Blank	(Default)
Blank	(Non-green monitor, less saving)
DPMS	(Display card must support DPMS)

Video Off Option

This governs in what modes the video display gets turned off. The options are:

Susp,Stby-> Off	(Off in Suspend & Standby)
Susp-> Off	(Off in Suspend)
All Modes Off	(Off in Doze, Suspend & Standby)
Always On	(No video shut off)

Modem Use IRQ

If you have a modem installed in your system you can enter which IRQ it is using so that APM can control it. The default setting is NA (Not Applicable).

Doze Mode

This sets the period of system inactivity after which the system goes into Doze mode, the most limited power saving state. The settings range from 1 minute to 1 hour and can be set manually when power management is in User Define mode. The default setting is Disabled. When the system goes into power saving mode, power management will skip to the next mode in the sequence if this is disabled.

Standby Mode

This sets the period of system inactivity after which the system goes into Standby mode, the intermediate power saving state. The settings range from 1 minute to 1 hour and can be set manually when power management is in User Define mode. The default setting is Disabled. When the system goes into power saving mode, power management will skip to the next mode in the sequence if this is disabled.

Suspend Mode

This sets the period of system inactivity after which the system goes into Suspend mode, the maximum power saving state. The settings range from 1 minute to 1 hour and can be set manually when power management is in User Define mode. The default setting is Disabled. When the system goes into power saving mode, power management will skip to the next mode in the sequence if this is disabled.

HDD Power Down

This shuts down IDE hard disks that support a power saving mode after a specified time period. The settings range from 1 to 15 minutes and can be set manually when power management is in User Define mode. HDD Power Down does not affect SCSI hard disks. The default setting is Disabled.

The system automatically resumes from any power saving mode when there is system activity such as keyboard activity or an IRQ wake-up event like mouse movement or a modem ring.

Wake Up Events In Doze & Standby

The system will resume from Doze or Standby mode if there is any activity by the parts of the system that use the IRQs listed in this section when they are set to ON. The system won't wake up from such activity if an item is set to OFF. The default settings are set so that the system will respond to mouse or modem activity. The default settings are:

IRQ3 (Wake-Up Event)	ON
IRQ4 (Wake-Up Event)	ON
IRQ8 (Wake-Up Event)	OFF
IRQ12 (Wake-Up Event)	ON

Power Down & Resume Event

This section allows setting the resume status of individual IRQs. When set to ON, activity will wake up the system. When set to OFF activity is ignored.

When you are finished you can press the Esc key to return to the main menu.

PCI & Onboard I/O Setup

To enter this section of the Setup program, highlight this menu item in the main menu and press the Enter key. The following screen will appear.

```
ROM PCI/ISA BIOS (XXXXXXXX)
PCI & ONBOARD I/O SETUP
AWARD SOFTWARE INC.

PCI PnP BIOS Auto-Config : Disable
PCI IRQ Activated By      : Level
1st Available IRQ        : 9
2nd Available IRQ        : 11
3rd Available IRQ        : 10
4th Available IRQ        : 5

PCI IDE Card 2nd Channel : Enabled
PCI IDE Card IRQ Map to  : PCI-AUTO
-Primary IDE INT#        : A
-Secondary IDE INT#      : B

PS/2 Mouse Function (IRQ12): Enable
Onboard IDE-1 Controller : Enable
-Master Drive PIO Mode   : AUTO
-Slave Drive PIO Mode    : AUTO
Onboard IDE-2 Controller : Enable
-Master Drive PIO Mode   : AUTO
-Slave Drive PIO Mode    : AUTO

Onboard FDD Controller   : Enable
Onboard Serial Port 1    : 3F8/IRQ4
Onboard Serial Port 2    : 2F8/IRQ3
-Onboard IR Function     : HPSIR
-IR Duplex Mode          : Half
-IR Tr/Re Polarity       : Hi/Hi
Onboard Parallel Port    : 378/IRQ7
-Parallel Port Mode      : ECP/EPPL.9
-ECP Mode Use DMA        : 3

ESC : Quit          -[F10] : Select Item
F1  : Help          PU/PD/+/- : Modify
F5  : Old Values   (SHIFT)F2  : Color
F6  : Load BIOS Defaults
F7  : Load Setup Defaults
```

Award BIOS PCI & Onboard I/O Setup

Menu Commands

The menu commands for this screen are the same as for the BIOS Features Setup screen.

PCI PnP BIOS Auto-Config

This function will automatically assign IRQs to PCI expansion slot INT#s as needed when enabled. If disabled, IRQs are assigned via the Available IRQ settings that follow after the next item. The default setting is Disabled.

PCI IRQ Activated By

The Level setting is required, don't change it.

Available IRQ

These four lines allow setting which IRQs will be assigned as needed to PCI expansion slot INT#s. The sequence controls the order in which the IRQs are assigned. The system looks at the PCI slots in the order Slot 1, 2, 3. The IRQ options are 3, 4, 5, 7, 9, 10, 11, 12, 14 and 15.

PCI IDE Card 2nd Channel

This turns the onboard IDE controller's second channel on and off. If you disable this it makes IRQ15 available to the ISA expansion bus. The default setting is Enabled.

PCI IDE Card IRQ Map To

This item sets how the system assigns IRQs to a PCI IDE controller card installed in one of the PCI expansion slots. There are four options for this item. The default setting is PCI-AUTO. The options are:

PCI-AUTO

Automatically assigns IRQ14 to the INT# for the slot the card is installed in.

PCI-slotX

If an installed PCI IDE card does not support auto-detection, you have to enter which slot it is installed in by selecting the slot number. IRQ14 will be assigned automatically.

ISA

This for PCI IDE cards that connect to IRQs 14 and 15 directly via a "paddleboard" installed in an ISA slot and connected to the card by a cable. No IRQ is assigned to the slot with the PCI IDE card in it.

The PCI Slot INT# specification options are:

Slot1-INT#A; Slot2-INT#B; Slot3-INT#C; Slot4-INT#D

Slot1-INT#B; Slot2-INT#C; Slot3-INT#D; Slot4-INT#A

Slot1-INT#C; Slot2-INT#D; Slot3-INT#A; Slot4-INT#B

Slot1-INT#D; Slot2-INT#A; Slot3-INT#B; Slot4-INT#C

In each case above the Slot/INT# associations are assigned the same IRQ. This means you can not install more than one PCI expansion card that uses an IRQ.

PS/2 Mouse Function (IRQ12)

This turns the PS/2 mouse port on and off. The default setting is Enabled.

Onboard IDE-1 Controller

This turns the onboard IDE controller's Primary channel on and off. The default is Enabled. The two sub-items set the PIO transfer modes for the Master and Slave devices. The Auto setting automatically determines the best mode for the device. Alternatively, you can set the mode manually to Mode 0, 1, 2, 3 or 4.



PIO Modes 0 ~ 4

The transfer mode settings for the IDE controller are best set automatically. If you want to set them manually, you must check which mode the hard disk in question supports. New IDE hard drives will provide this information, usually noting the fastest mode supported. Mode 0 is the slowest and Mode 4 the fastest. If a drive supports a faster mode, it also supports all modes slower than the one listed.

Onboard IDE-2 Controller

This turns the onboard IDE controller's Secondary channel on and off. The default is Enabled. The two sub-items set the PIO transfer modes for the Master and Slave devices. The Auto setting automatically determines the best mode for the device. Alternatively, you can set the mode manually to Mode 0, 1, 2, 3 or 4.

Onboard FDD Controller

This turns the onboard floppy disk drive controller on and off. The default setting is Enabled.

Onboard Serial Ports 1 & 2

These two lines set the address and IRQ assignment or disable the onboard serial ports. The default settings are the standard assignments for these ports. You can choose another option or disable them if you want. Don't use the same settings for both ports. The settings are as follows:

Serial Port 1	3F8/IRQ4	(Default)
Serial Port 2	2F8/IRQ3	(Default)
Other Options:	3E8/IRQ4	
	2E8/IRQ3	
	Disable	

All options are for either port.

IR Infrared Settings

The next three items configure Serial Port 2 as an Infrared port as follows:

Onboard IR Function

This sets the IR mode. The options are:

HPSIR – HP IrDA compatibility

ASKIR – Amplitude Shift Key IR

Disable – No IR

IR Duplex Mode

Sets the Duplex Mode to either Half or Full. The default is Half.

IR Tr/Re Polarity

Sets the IR transmit and receive polarity to either High or Low. The default setting is Hi/Hi.

Onboard Parallel Port

This sets the address and IRQ assignment or disables the onboard parallel port. The default setting is the standard assignment for parallel ports. You can choose another option if you want. The default setting is 378/IRQ7.

Parallel Port Mode

The onboard parallel port supports standard, EPP and ECP modes. The default setting is Normal(SPP). The options are as follows.

EPP 1.7

EPP 1.9

ECP

ECP+EPP 1.7

ECP+EPP 1.9

Normal (Default)

ECP Mode Use DMA

This sets the DMA assignment for the parallel port's ECP mode. The options are DMA1 or DMA3. The default setting is 3.

Load BIOS Defaults

To invoke this command highlight it in the main menu and press Enter. A message will appear asking if you want to load the BIOS defaults. Press the Y key and then the Enter key. The BIOS default settings will load. Press the N key if you want to cancel.

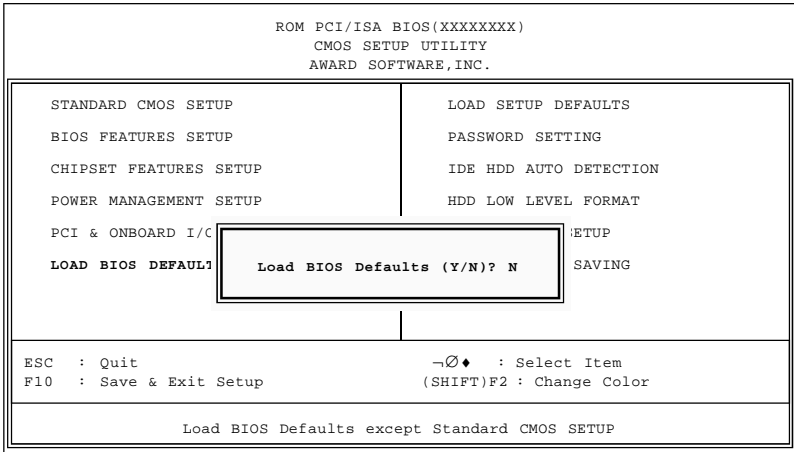

Award BIOS Load BIOS Defaults

This loads a set of troubleshooting default values permanently stored in the BIOS ROM. The settings are not optimal and turn off all the performance features. Standard CMOS Setup is not affected by this command.

Load Setup Defaults

To invoke this command highlight it in the main menu and press Enter. A message will appear asking if you want to load the Setup defaults. Press the Y key and then the Enter key. The Setup default settings will load. Press the N key if you want to cancel.

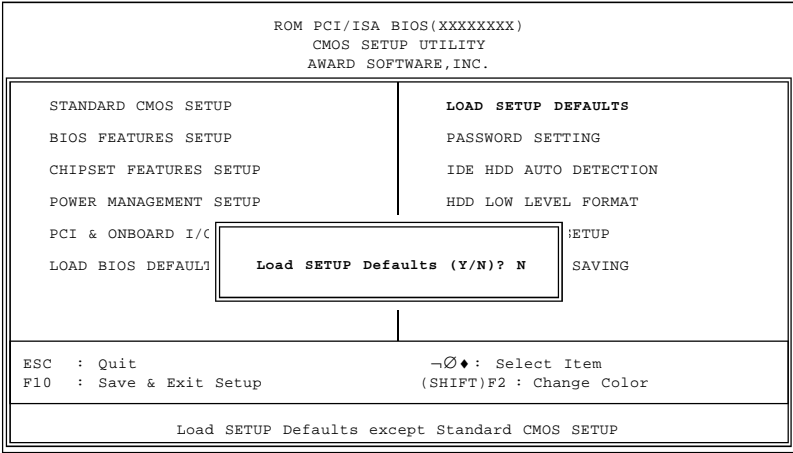

Award BIOS Load Setup Defaults

This loads a set of optimized default values permanently stored in the BIOS ROM. Use this command to load default settings for normal system operation. Standard CMOS Setup is not affected by this command.

Password Setting

To invoke this command highlight it in the main menu and press Enter. A message will appear prompting you to enter a password.

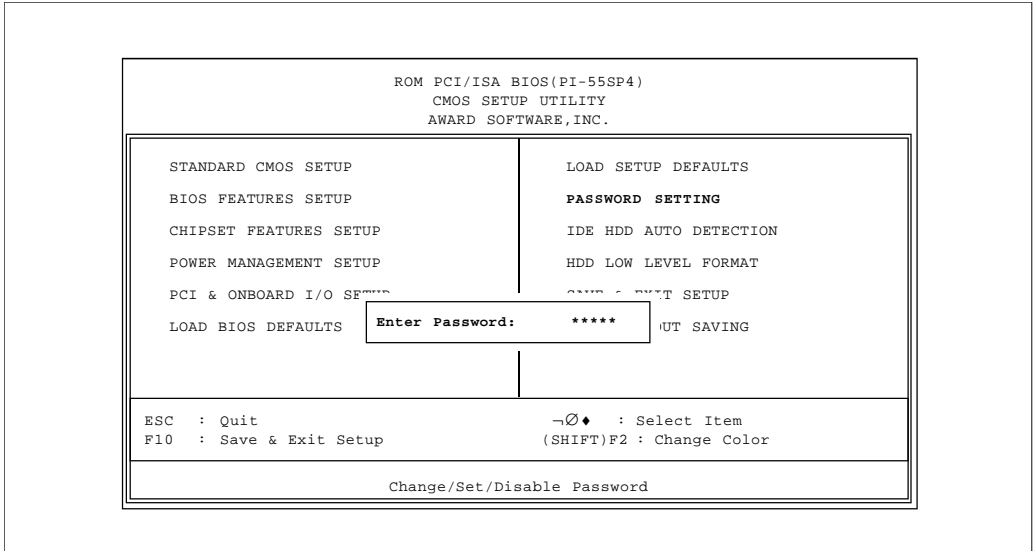

Award BIOS Password Setting

Type in a password. The password is case sensitive, and can be up to 8 alphanumeric characters. Press Enter when you finish typing in the password.

If you typed in a password, the message “Confirm Password” will appear. Confirm the password by typing it again and pressing Enter. The message box will close.

If you don't want to set a password after you invoke this command, or if you want to eliminate an existing password, press Enter without typing anything else. The message “Password Disabled” will appear and the message box will close.

When you set a password, the Security Option line in BIOS Features Setup controls when the password is required. You can set the option to require the password when the system boots up or when calling up the Setup utility. The mainboard ships with no password.

IDE HDD Auto Detection

When you install an IDE hard drive, you should use this feature to automatically detect the drive parameters and enter them in the appropriate Hard Disk section of Standard CMOS Setup. To use this feature, highlight it in the main menu and press the Enter key.

HDD Low Level Format

This is a low level format utility for IDE hard disk drives. Do not use it on any other kind of hard disk. Most IDE hard disk drive manufacturers use proprietary low level formatting schemes and format the drive at the factory. You should not need to use this program when you install an IDE drive and you should make sure that you can use this generic formatter on your drive in the unlikely event that it needs to be low level formatted again.

Low level formatting is not the same as the formatting you perform when installing an operating system.

In the event that you need to use this utility, the drive you use it on must be set to Normal mode in Standard CMOS Setup.

Save And Exit Setup

When you select this and press Enter the values entered during the current session are recorded in CMOS memory.

Exit Without Saving

When you select this and press Enter the Setup Utility closes without recording any changes made during the current session.

Updating The BIOS

The PR5's BIOS chip is programmable and can be updated when new BIOS versions are released.

IDE Driver Disk

The PR5 comes with a floppy disk of IDE Bus master drivers for the PIIX IDE controller. There are drivers for Windows95, Windows NT and OS/2. There are Readme text files for each version which explain how to use the drivers. They are on the floppy disk in the relevant directories for each operating system.