

# Notice

---

**The information in this document is subject to change without notice and does not represent a commitment on part of the vendor, who assumes no liability or responsibility for any errors that may appear in this manual.**

**No warranty or representation, either expressed or implied, is made with respect to the quality, accuracy or fitness for any particular part of this document. In no event shall the manufacturer be liable for direct, indirect, special, incidental or consequential damages arising from any defect or error in this manual or product.**

**Product names appearing in this manual are for identification purpose only and trademarks and product names or brand names appearing in this document are property of their respective owners.**

**This document contains materials protected under International Copyright Laws. All rights reserved. No part of this manual may be reproduced, transmitted or transcribed without the expressed written permission of the manufacturer and authors of this manual.**



# BX6 Motherboard

## USER'S MANUAL

### Table of Contents

---

<b>Chapter 1 Introduction of BX6 Features</b>	<b>1-1</b>
(1) Specifications	1-1
(2) Layout Diagram	1-3
(3) The System Block Diagram	1-4
<hr/>	
<b>Chapter 2 Installing the Motherboard</b>	<b>2-1</b>
(1) Installing the Motherboard to the Casing	2-2
(2) Standard External Connectors	2-3
(3) Jumper and Switches	2-9
(4) Installation of the Pentium® II/III, Celeron® CPU	2-11
(5) Installing System Memory	2-12
<hr/>	
<b>Chapter 3 Introduction of BIOS</b>	<b>3-1</b>
(1) CPU Setup <CPU SOFT MENU™II>	3-3
(2) Standard CMOS Setup Menu	3-8
(3) BIOS Features Setup Menu	3-11
(4) Chipset Features Setup Menu	3-17
(5) Power Management Setup Menu	3-21
(6) PnP/PCI Configuration	3-28
(7) Load Setup Defaults	3-31
(8) Integrated Peripherals	3-32
(9) Password Setting	3-37
(10) IDE Hard Disk Detection	3-37
(11) Save & Exit Setup	3-38
(12) Exit Without Saving	3-38

---

<b>Appendix A Quick Installation</b>	<b>A-1</b>
<b>Appendix B General Discussion About HDD Installation</b>	<b>B-1</b>
<b>Appendix C BIOS Flashing User Instructions</b>	<b>C-1</b>
<b>Appendix D How to install the IDE Bus Master driver</b>	<b>D-1</b>
<b>Appendix E How to install the PCI bridge driver for the 440BX chipset</b>	<b>E-1</b>
<b>Appendix F Install HighPoint XStore Pro Utility</b>	<b>F-1</b>
<b>Appendix G Install Winbond Hardware Doctor Utility</b>	<b>G-1</b>
<b>Appendix H Technical Support</b>	<b>H-1</b>

# Chapter 1 Introduction of BX6 Features

---

The motherboard is designed for a new generation CPUs. It supports the Intel SLOT1 structure (Pentium® II/III and Celeron® processors), up to 1GB of memory, super I/O, and Green PC functions. The motherboard provides high performance for server systems and meets the requirements for desktop system for multimedia in the future.

## (1) Specifications

---

### 1. CPU

- CPU SOFT MENU™ II eliminates the need for jumpers or DIP switches needed to set CPU parameters
- Employs switching type regulators to stabilize CPU operation
- Supports 66 and 100MHz MHz CPU external clock speeds
- Supports Intel® Pentium® III 450 ~ 500MHz processor cartridge (Based on 100MHz)
- Supports Intel® Pentium® II 350 ~ 450MHz processor cartridge (Based on 100MHz) and Pentium® II 233 ~ 333MHz processor cartridge (Based on 66MHz)
- Supports Intel® Celeron® 266~433MHz processor (Based on 66MHz)

### 2. Chipset

- Intel® 440BX chipset (82443BX and 82371EB)
- Supports Ultra DMA/33 IDE protocol
- Supports Advanced Configuration and Power Management Interface(ACPI)
- Accelerated Graphics Port connector supports AGP 1x and 2x mode (Sideband) 3.3V device

### 3. Cache Memory

- Level 1 and Level 2 cache built into Intel® Pentium® II/III processor cartridge
- Level 1 cache (without L2 cache) built into Intel® Celeron® processor<sup>o</sup>

### 4. Memory(System Memory)

- Four 168-pin DIMM sockets support SDRAM modules
- Supports up to 1GB
- ECC support
- 6 Data Buffers

### 5. System BIOS

- AWARD BIOS
- Supports Plug-and-Play (PnP)
- Supports Advanced Configuration Power Interface (ACPI)
- Supports Desktop Management Interface (DMI)
- Year 2000 compliant

**6. Multi I/O Functions**

- Floppy port supports up to 2.88MB, and 3 mode floppies
- Ultra DMA/33 bus master IDE supports up to 4 IDE devices ( Including LS-120 MB floppy drive )
- Built-in Standard/EPP/ECP parallel port connector
- Two built-in 16550 fast UART compatible serial port connectors
- Built-in PS/2 keyboard and PS/2 mouse port connectors
- Built-in standard IrDA TX/RX header
- Two built-in USB connectors

**7. Miscellaneous**

- ATX form factor
- One AGP slot, Five PCI slots and Two ISA slots
- Wake Up On LAN header
- SB-LINK header
- Hardware monitoring Included fan speed, voltages, CPU and system environment temperature
- Keyboard Wake Up or PS/2 Mouse Wake Up (need +5VSB at least 720mA)
- Board size: 305 \* 210mm

**Note:**

All brand names and trademarks are the property of their respective owners.

❶ The actual specs of Intel® Celeron® processor will depend on Intel's shipping specs.

\* Above 66MHz/100MHz bus speed supported but not guaranteed due to the PCI and chipset specs.

\* Sound Blaster™ is a registered trademark of Creative Technology Ltd. in the United States and certain other countries. Sound Blaster - LINK™ and SB-LINK™ are trademarks of Creative Technology Ltd.

\* Specifications and information contained in this manual are subject to change without notice.

## (2) Layout Diagram

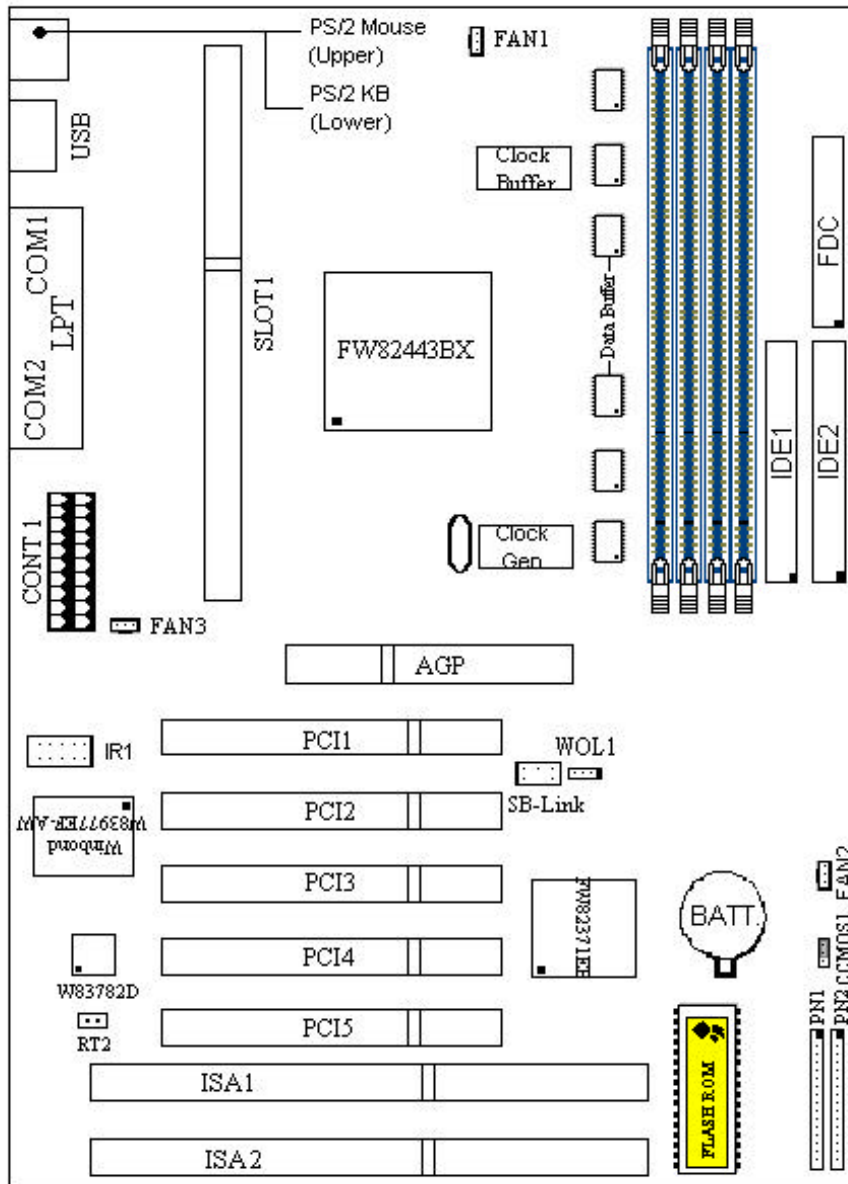

# AB-BX6

Figure 1-1 Motherboard Component Locations

### (3) The System Block Diagram

---

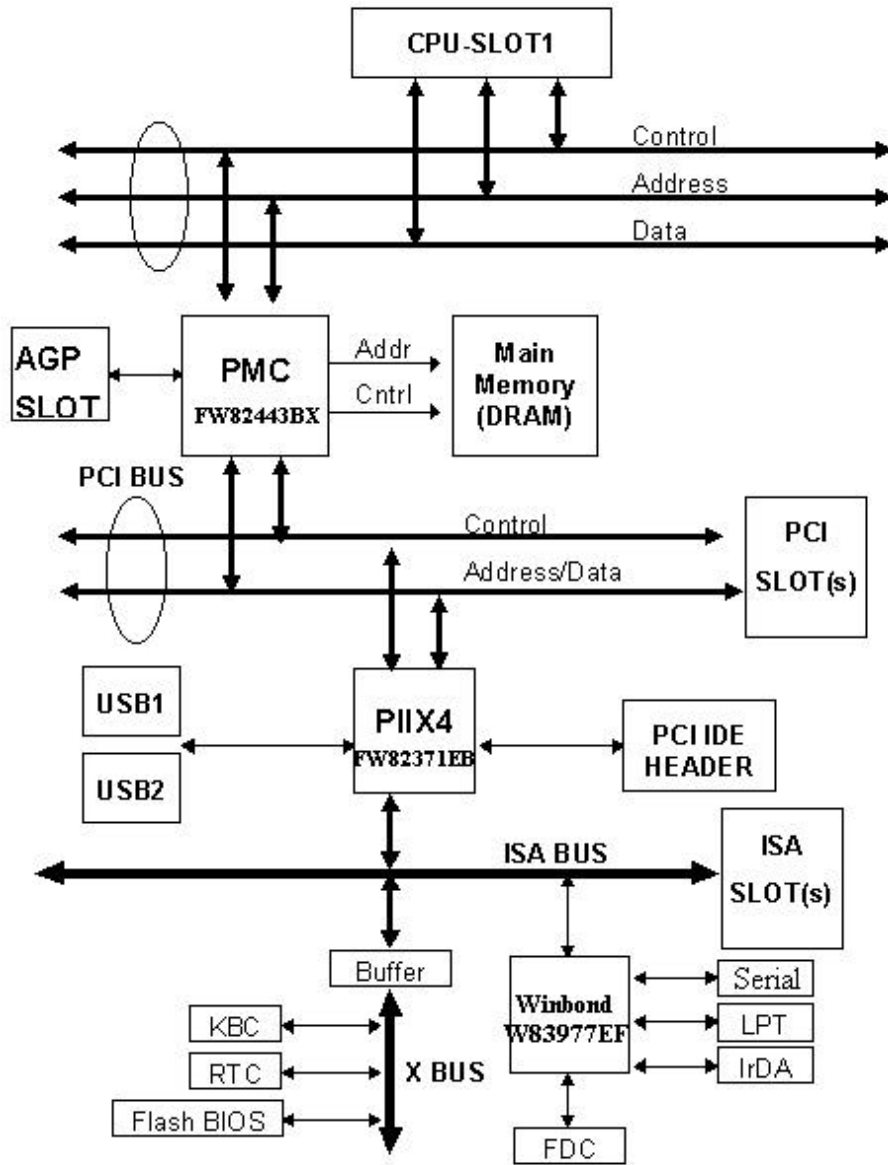



## Chapter 2 Installing the Motherboard

---

This BX6 motherboard not only provides all standard equipment for classic personal computers, but also provides great flexibility for meeting future upgrade demands. This chapter will introduce step by step all the standard equipment and will also present, as completely as possible, future upgrade capabilities. This motherboard is able to support all Intel® Pentium® II/III processors and Intel® Celeron® processor now on the market. (For details, see specifications in Chapter 1.)

This chapter is organized according the following features:

- (1) Installing the Motherboard to the Casing
- (2) Standard external connectors
- (3) Jumpers and switches
- (4) Installation of the Pentium® II/III, Celeron® CPU
- (5) Installing the system memory



### **Before proceeding with the installation**

---

Before installing the motherboard please be sure to turn off or disconnect the power supply unit. Before making any modifications to the hardware configuration of the motherboard, the power supply to any areas of the motherboard you plan to modify should be turned off to avoid unnecessary damage to the hardware.



### **User friendly instructions**

---

Our objective is to enable the novice computer user to perform the installation by themselves. We have attempted to write this document in a very clear, concise and descriptive manner to help overcome any obstacles you may face during installation. Please read our instructions carefully and follow them step-by-step.

## (1) Installing the Motherboard to the Casing

---

Most computer cases will have a base on which there will be many mounting holes that allows the motherboard to be securely attached and at the same time, prevents short circuits.

There are two ways to attach the motherboard to the base.

- with spacers
- or with bolts

Please refer to the figure below that shows the studs and spacers, they may have several types, but all look like the figures below:

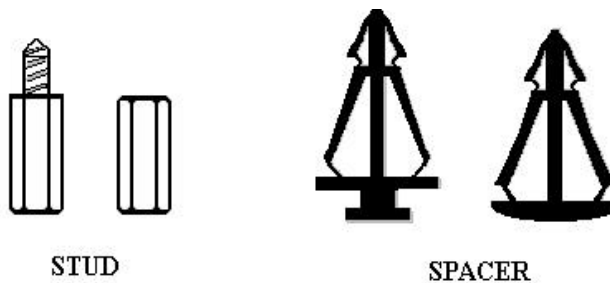

**Figure 2-1. The outline of stud and spacer**

In principle, the best way to attach the motherboard is with bolts, and only if you are unable to do this should you attach the board with spacers. Take a careful look at the motherboard and you will see many mounting holes on it. Line these holes up with the mounting holes on the base. If the holes line up, and there are screw holes this means you can attach the motherboard with bolts. If the holes line up and there are only slots, this means you can only attach the motherboard with spacers. Take the tip of the spacers and insert it into the slots. After doing this to all the slots, you can slide the motherboard into position aligned with the slots. After the motherboard has been positioned, check to make sure everything is OK before putting the casing back on.

**Note:** If the motherboard has mounting holes, but don't line up with the holes on the base and there are no slots to attach the spacers, don't worry, you can still attach the spacers to the mounting holes. Just cut the spacers (along the dotted line) (the spacer may be a little hard so be careful of our hands). In this way you can still attach the motherboard to the base without worrying about short circuits.

## **(2) Standard External Connectors**

---

Inside the case of any computer several cables and plugs have to be connected. These cables and plugs are usually connected one-by-one to connectors located on the motherboard. You need to carefully pay attention to any connection orientation the cables may have and, if any, notice the position of the first pin of the connector. In the explanations that follow, we will describe the significance of the first pin.

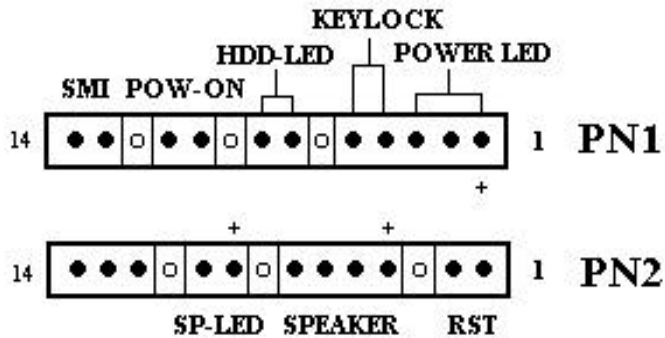

---

### **PN1(Pin 1-2-3-4-5): Keylock and Power LED Header**

There is a specific orientation for pin 1 through pin 5. Insert the two-threaded keylock cable into pin 4 and pin 5, and three-threaded power LED cable to Pin 1 ~ pin 3. Check to make sure the correct pins of connector on the motherboard.

Pin number	Name or significance of signal	Connector Name
1	+5VDC	Power LED
2	No connection	Power LED
3	Ground	Power LED
4	Keyboard inhibit Signal	Keylock
5	Ground	Keylock

---

### **PN1(Pin 7-8): HDD LED Header**

Attach the cable from the case's HDD LED to this connector.

Pin number	Name or significance of signal
7	LED power
8	HDD active

**PN1 (Pin 10-11): Power Switch Header**

Pin number	Name or significance of signal
10	Power On/Off switch
11	Ground

**PN1 (Pin 13-14): Hardware Suspend Switch (SMI Switch) Header**

Attach the cable from the case's suspend switch (if there is one) to this switch. Use this switch to enable/disable the power management function by hardware.

Pin number	Name or significance of signal
13	Vcc
14	Suspend signal

**PN2(Pin 1-2): Hardware Reset Header**

Attach the cable from the case's Reset switch to this connector. Press and hold the reset button for at least one second to reset the system.

Pin number	Name or significance of signal
1	Reset input
2	Ground

**PN2(Pin 4-5-6-7): Speaker Header**

Attach the system speaker to connector PN2.

Pin number	Name or significance of signal
4	+ 5VDC
5	Ground
6	Ground
7	Speaker data

**PN2(Pin 9-10): Suspend LED Header**

Pin number	Name or significance of signal
9	LED power
10	Suspend LED active

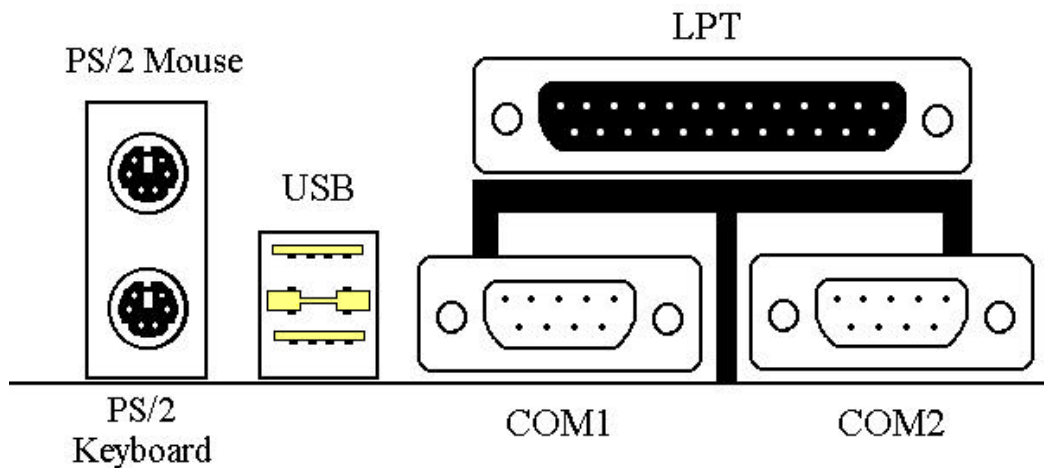

**KM1 MOUSE: PS/2 Mouse Connector**

Attach a PS/2 mouse to this 6-pin Din-connector.

Pin number	Name or significance of signal
1	Mouse data
2	No connection
3	Ground
4	+5VDC
5	Mouse clock
6	No connection

**KM1 KB: PS/2 Keyboard Connector**

Attach a keyboard to this 6-pin Din-connector.

Pin number	Name or significance of signal
1	Keyboard data
2	No connection
3	Ground
4	+5VDC
5	Keyboard clock
6	No connection

---

**CONT1: ATX Power Input Connector**

Caution: If power supply connectors are not properly attached to ATXPWR, the power supply or add-on cards may be damaged.

Attach the connectors from the power supply to CONT1.

Pin number	Name or significance of signal
1	+3.3VDC
2	+3.3VDC
3	Ground
4	+5VDC
5	Ground
6	+5VDC
7	Ground
8	Power Good
9	+5VSB
10	+12VDC
11	+3.3VDC
12	-12VDC
13	Ground
14	On/Off control signal
15	Ground
16	Ground
17	Ground
18	-5VDC
19	+5VDC
20	+5VDC

---

**FAN1, FAN2, FAN3 (CPU FAN)**

Pin number	Name of the signal or signification
1	Ground
2	+12V
3	Sense signal

---

**IR1: IR Header (Infra-red)**

Pin number	Name or significance of signal
1	+5V
2	No connection
3	IR_RX
4	Ground
5	IR_TX

---

**I/O Port Connectors**

Name	Pin number	Description
IDE1	40	IDE channel 1 connector
IDE2	40	IDE channel 2 connector
FDC	34	Floppy disk connector
LPT	25	Parallel port
COM1	9	Serial port COM1 connector
COM2	9	Serial port COM2 connector
USB	8	Universal serial Bus

**Notes:** \*IDE1, IDE2 are high performance PCI IDE connectors. Up to four IDE interface devices are supported.

---

**WOL1: Wake On LAN Header**

Pin number	Name or significance of signal
1	+5VSB
2	GND
3	Sense input

---

**SB1: SB-Link™ Header**

Pin number	Name or significance of signal
1	GNTA
2	Ground
3	KEY
4	REQA
5	Ground
6	SERIRQ

**RT2 Header (Optional)**

This header is for you to connect an additional thermistor to detect the CPU temperature. You can buy the thermistor at an electronics store, and ask for a 10K $\Omega$  thermistor which will be OK. Please don't use too long of a lead wire for the thermistor. You can see the detected temperature in the BIOS menu. (see Chipset Features Setup Menu)

According to ACPI specifications, CPU fan speed is relative to the CPU temperature. In order to avoid confusing ACPI functions, we strongly suggest that you connect the additional thermistor to the CPU.

<p><b>Note:</b> Before you install or unplug any connectors or add-on cards, please remember to turn the ATX power supply switch off (fully turn the +5V standby power off), or take power cord off. Otherwise, you may cause the motherboard components, add-on cards to malfunction or be damaged.</p>
--



### **(3) Jumper and Switches**

---

You can set jumper switches on the motherboard to configure various hardware options. See Figure 1-1 for jumper locations.

Throughout this section, the following symbols are used to indicate jumper settings.

For 3-pin jumpers, the symbols below are used:



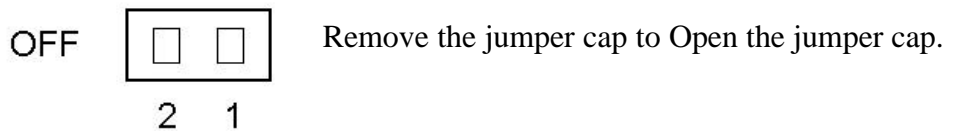
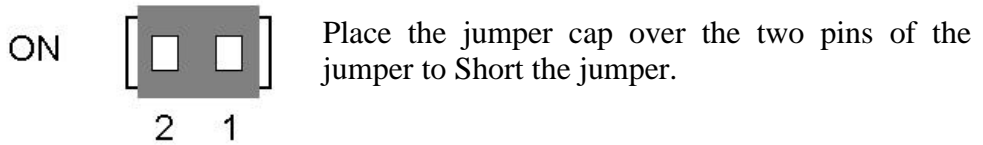

For 2-pins jumpers, the following symbols are used:



**Note:** To avoid losing jumper caps, attach the removed jumper cap to one of the jumper pins.

**CCMOS 1 : CMOS Discharge Jumper**

Jumper CCMOS discharge CMOS memory. When you install the motherboard, make sure this jumper is set for Normal Operation (1-2). See the jumper below.

Setting	CCMOS
Normal Operation (Default)	
Discharge CMOS	

**Note:** Before you clear the CMOS, you have to turn the power off first (including the +5V standby power). Otherwise, your system may work abnormally or malfunction.

## **(4) Installation of the Pentium<sup>®</sup> II/III, Celeron<sup>®</sup> CPU**

---

The installation method for the CPU is printed on the package of the retention mechanism that comes with the motherboard. You can refer to it while you install the CPU. This motherboard also supports the Celeron<sup>®</sup> PPGA processor. If you want to install the Celeron<sup>®</sup> PPGA processor, you have to use an additional adapter that allows you to use a Celeron<sup>®</sup> PPGA processor in a slot 1 board. For this ABIT makes the SlotKET<sup>®</sup> adapter.

**Note:**

- Installing a heat sink and cooling fan is necessary for proper heat dissipation from your CPU. Failing to install these items may result in overheating and damage of your CPU.
- Please refer to your boxed processor installation or other documentation attached with your CPU for detailed installing instructions.

## **(5) Installing System Memory**

---

The motherboard provides four 168-pin DIMM sites for memory expansion.. The DIMM socket supports 1Mx64(8MB), 2Mx64(16MB), 4Mx64(32MB), 8Mx64(64MB), 16Mx64(128MB), and 32Mx64(256MB) or double sided DIMM modules. Minimum memory size is 8MB and maximum memory size is 1GB SDRAM.

There are four Memory module sockets on the system board.(Total eight banks) In order to create a memory array, certain rules must be followed. The following set of rules allows for optimum configurations.

- The memory array is 64 or 72 bits wide. (Without parity or with parity)
- Those modules can be populated in any order.
- Support single and double density DIMMS.

The following is the valid memory configuration:

<b>Bank</b>	<b>Memory Module</b>	<b>Total Memory</b>
Bank 0, 1 (DIMM1)	8MB, 16MB,32MB, 64MB, 128MB, 256MB	8MB ~ 256MB
Bank 2, 3 (DIMM2)	8MB, 16MB,32MB, 64MB, 128MB, 256MB	8MB ~ 256MB
Bank 4, 5 (DIMM3)	8MB, 16MB,32MB, 64MB, 128MB, 256MB	8MB ~ 256MB
Bank 6, 7 (DIMM4)	8MB, 16MB,32MB, 64MB, 128MB, 256MB	8MB ~ 256MB
Total System Memory		8MB ~ 1GB

### Supported SDRAM Memory Configurations

DRAM Type	DRAM Tech	DRAM Depth	DRAM Width	DRAM DIMM		DRAM Addressing	MA			DARM Size	
				SS x64	DS x64		Row	Col	Banks	Min (1 row)	Max (2 row)
SDRAM	16M	1M	16	1M	2M	Asymmetric	12	8	2	8MB	16MB
		2M	8	2M	4M	Asymmetric	12	9	2	16MB	32MB
		2M	8	2M	4M	Asymmetric	13	8	2	16MB	32MB
		4M	4	4M	8M	Asymmetric	12	10	2	32MB	64MB
		4M	4	4M	8M	Asymmetric	14	8	2	32MB	64MB
SDRAM	64M 2 Bank	2M	32	2M	4M	Asymmetric	12	9	2	16MB	32MB
		2M	32	2M	4M	Asymmetric	13	8	2	16MB	32MB
		4M	16	4M	8M	Asymmetric	12	10	2	32MB	64MB
		4M	16	4M	8M	Asymmetric	14	8	2	32MB	64MB
		8M	8	8M	16M	Asymmetric	14	9	2	64MB	128MB
		16M	4	16M	32M	Asymmetric	14	10	2	128MB	256MB
SDRAM	64M 4 Bank	2M	32	2M	4M	Asymmetric	13	8	4	16MB	32MB
		4M	16	4M	8M	Asymmetric	14	8	4	32MB	64MB
		8M	8	8M	16M	Asymmetric	14	9	4	64MB	128MB
		16M	4	16M	32M	Asymmetric	14	10	4	128MB	256MB



## Chapter 3 Introduction of BIOS

---

The BIOS is a program located on a Flash Memory chip on the motherboard. This program will not be lost when you turn the computer off. This program is also referred to as the boot program. It is the only channel for the hardware circuit to communicate with the operating system. Its main function is to manage the setup of the motherboard and interface cards parameters, including simple parameters such as time, date, hard disk drive, as well as more complex parameters such as hardware synchronization, device operating mode, **CPU SOFT MENU™II** techniques, setup of CPU speed. The computer will operate normally, or will operate at its best, only if all these parameters are correctly configured through the BIOS.

**⚠ Don't change the parameters inside the BIOS unless you know what you are doing**

The parameters inside the BIOS are used to setup the hardware synchronization or the device operating mode. If the parameters are not correct, they will produce errors, the computer may crash, and sometimes you will even not be able to boot the computer after it has crashed. We recommend that you do not change the parameters inside the BIOS unless you are familiar with them. If you are not able to boot your computer anymore, please refer to the section “Erase CMOS data” in Chapter 2.

When you start the computer, it is controlled by the BIOS program. The BIOS first operates an auto-diagnostic for all the necessary hardware, configures the parameters of the hardware synchronization, and detects all the hardware. Only when these tasks are completed does it give up control of the computer to the program of the next level, which is the operating system. Since the BIOS is the only channel for hardware and software to communicate, it will be the key factor for system stability, and to ensure that your system performs at its best. After the BIOS has achieved the auto-diagnostic and auto-detection operations, it will display the following message:

**PRESS DEL TO ENTER SETUP**

Three to five seconds after the message is displayed, if you press the **Del** key, you will access the BIOS Setup menu. At that moment, the BIOS will display the following message:

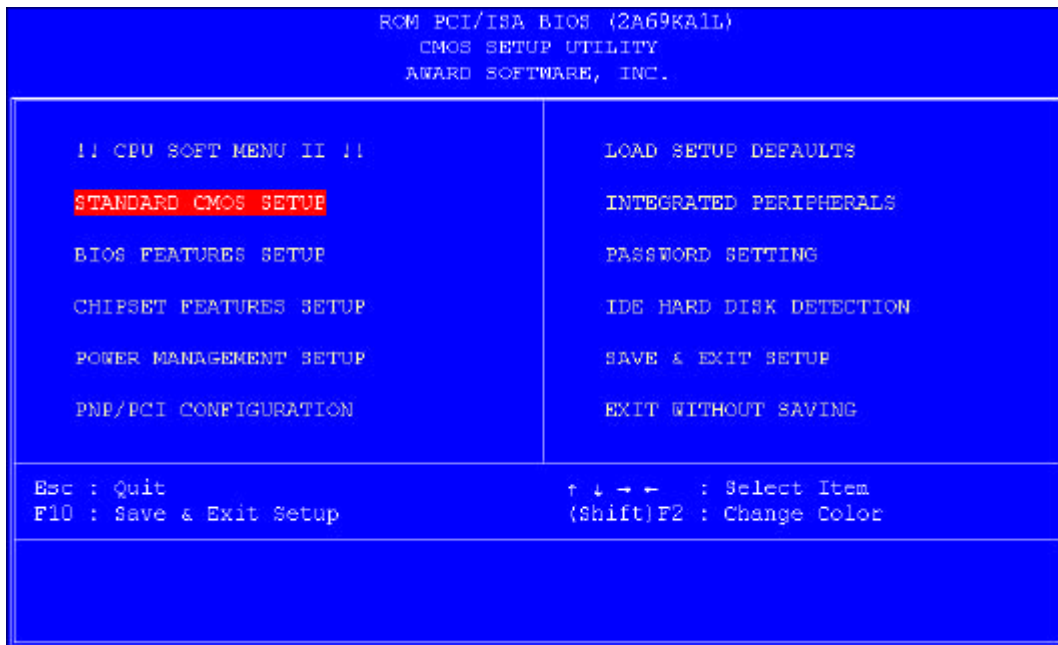

**Fig 3-1 CMOS Setup Utility**

In the BIOS Setup main menu of Figure 3-1, you can see several options. We will explain these options step by step in the following pages of this chapter, but let us first see a short description of the function keys you may use here:

- Press **Esc** to quit the BIOS Setup.
- Press **↑ ↓ → ←** (up, down, left, right) to choose, in the main menu, the option you want to confirm or to modify.
- Press **F10** when you have completed the setup of BIOS parameters to save these parameters and to exit the BIOS Setup menu.
- Press **Page Up/Page Down** or **+/-** keys when you want to modify the BIOS parameters for the active option.



## Computer Knowledge



### CMOS DATA

Maybe you have heard somebody saying that their CMOS DATA was lost. What is the CMOS? Is it important? The CMOS is the memory used to store the BIOS parameters that you have configured. This memory is passive. You can read its data, and you can also store data in it. But this memory has to be powered by a battery, in order to avoid any loss of its data when the computer is turned off. Since you may have to change the CMOS battery when it is out of power and if doing so, you will lose all CMOS data, therefore, we recommend that you write down all the parameters of your hardware, or to put a label with these parameters on your hard disk.



## **(1) CPU Setup ( CPU SOFT MENU™ II )**

---

The CPU can be setup through a programmable switch (**CPU SOFT MENU™ II**), that replaces traditional manual hardware configuration. This feature allows the user to complete the installation procedures easily. You can install the CPU without configuring any jumpers or switches. The CPU must be setup according its specifications.

In the first option, you can press <F1> at any time to display all the items that can be chosen for that option.

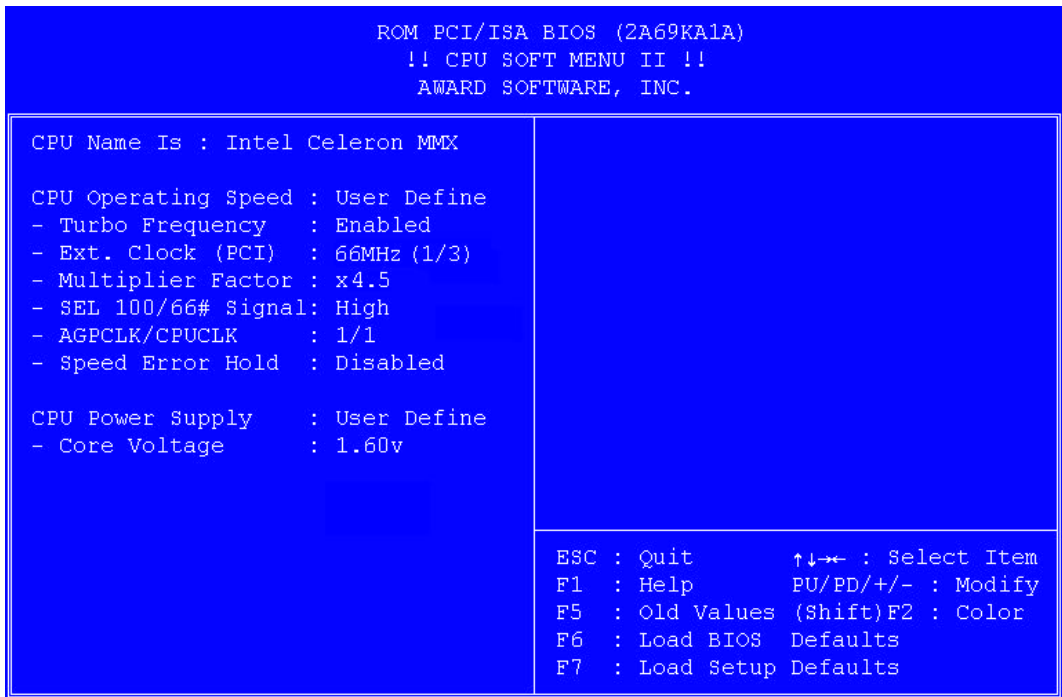

**Fig 3-2 CPU SOFT MENU™ II**

---

### **CPU Name Is:**

- Intel Pentium III MMX
- Intel Pentium II MMX
- Intel Celeron MMX

---

### **CPU Operating Speed:**

This option sets the CPU speed.

In this field, the CPU speed is indicated like this:

CPU speed = External clock \* Multiplier factor.

Select the CPU speed according the type and the speed of your CPU.

For Intel Pentium® II/III and Celeron® MMX processors, you can choose the following settings:

- |                 |                 |                |              |
|-----------------|-----------------|----------------|--------------|
| ➤ 233 (66*3.5)  | ➤ 266 (66*4)    | ➤ 300 (66*4.5) | ➤ 333 (66*5) |
| ➤ 350 (100*3.5) | ➤ 366 (66*5.5)  | ➤ 400 (100*4)  | ➤ 400(66*6)  |
| ➤ 433 (66*6.5)  | ➤ 450 (100*4.5) | ➤ 500 (100*5)  | .....        |

User define external clock and multiplier factor:

➤ **User Define**

⇒ **Turbo Frequency:**

This item will only be displayed if your CPU external clock supports Turbo mode.

The Turbo mode allows you to speed up the external clock by approximately 2.5%. This feature is used to verify the design flexibility. It is a very important tool for test units to verify CPU stability. Do not use this feature.

- Disabled: CPU external clock is operating within the normal limits.
- Enabled: CPU external clock is operating within the limits of the Turbo mode.

⇒ **Ext. Clock (PCI):**

- |                 |                 |                 |
|-----------------|-----------------|-----------------|
| ➤ 66MHz (1/2)   | ➤ 75MHz* (1/2)  | ➤ 83MHz* (1/2)  |
| ➤ 100MHz (1/3)  | ➤ 112MHz* (1/3) | ➤ 117MHz* (1/3) |
| ➤ 117MHz* (1/4) | ➤ 124MHz* (1/4) | ➤ 129MHz* (1/4) |
| ➤ 133MHz* (1/4) | ➤ 138MHz* (1/4) | ➤ 143MHz* (1/4) |
| ➤ 148MHz* (1/4) | ➤ 153MHz* (1/4) |                 |

**Note:**

1. \*Above 66MHz/100MHz bus speeds supported but not guaranteed due to the PCI and chipset specs.
2. PCI clock = External clock \* fraction. For example, when you select 117MHz (1/3), it means the PCI clock is 39MHz. If you set to 117MHz(1/4), the PCI clock is 29MHz.

⇒ **Multiplier Factor:**

You can choose the following multiplier factors:

- |       |       |       |
|-------|-------|-------|
| ➤ 2.0 | ➤ 2.5 | ➤ 3.0 |
| ➤ 3.5 | ➤ 4.0 | ➤ 4.5 |
| ➤ 5.0 | ➤ 5.5 | ➤ 6.0 |
| ➤ 6.5 | ➤ 7.0 | ➤ 7.5 |
| ➤ 8.0 | ..... |       |

However, differences will exist because of the various brands and types available.

⇒ **SEL100/66# Signal:**

This default setting is “High” at 100MHz, and “Low” at 66MHz. When you want to try a higher multiplier factor at 100MHz and cannot chose it in “High” state, then you can set it to “Low” state.

**Note:** Some Pentium®II/III processors have been locked the multiplier factor at manufacturing site. In this situation, there is no way to choose the higher multiplier factor.

⇒ **AGPCLK/CPUCLK:**

Default setting is “2/3”. In this state, AGP bus speed will be CPU bus speed divided by 3 and times 2. If you choose the setting to “1/1”, AGP bus speed will equal to CPU bus speed.

⇒ **Speed Error Hold:**

Default setting is “Disable”. If you choose the setting to “Enable”, when CPU speed setting is wrong, then system will hold.

Normally, we do not recommend that you use the “User Define” option to setup CPU speed and multiplier factor. This option is for the setup of future CPUs whose specifications are still unknown. The specifications of all present CPUs are included in the default settings. Unless you are very familiar with all CPU parameters, it is very easy to make mistakes when you define by yourself the external clock and the multiplier factor.

**Solution in case of booting problem due to invalid clock setup:**

Normally, if the CPU clock setup is wrong, you will not be able to boot. In this case, turn the system off than on again. The CPU will automatically use its standard parameters to boot. You can then enter BIOS Setup again and set up the CPU clock.

If you can't enter BIOS setup, you must try turning the system on a few times (3~4 times) or press “INSERT” key when turn the power on and the system will automatically use its standard parameters to boot. You can then enter BIOS

SETUP again and set up the new parameters.

**When you change your CPU:**

The motherboard have been designed in such a way that you can turn the system on after having inserted the CPU in the socket without having to configure any jumpers or DIP switches. But if you change your CPU, normally, you just have to turn off the power supply, change the CPU and then, set up the CPU parameters through **CPU SOFT MENU™II** However, if the CPU brand and type is the same, and if the new CPU is slower than the old one, we suggest you two methods to successfully complete the CPU change operation.

Method 1: Setup up the CPU for the lowest speed for its brand. Turn the power supply off and change the CPU. Then turn the system on again, and set up the CPU parameters through **CPU SOFT MENU™II**.

Method 2: Since you have to open the computer case when you change the CPU, it could be a good idea to use the CCMOS jumper to erase the parameters of the original CPU and to enter BIOS Setup to set up CPU parameters again.

**Note:** The increase by 2.5% of the CPU speed is not a standard feature of this product. It is only for use by our development department to verify that the CPU is able to work normally when CPU speed, operating temperature and power supply are 2.5% higher or lower than the standard values. This is to guarantee product stability. We require the manufacturer of the Clock Generator to meet the demands of our development department and to add a TURBO Frequency feature used for testing purposes by our R&D department. Of course, you can use this feature to test the stability of your own system, but after you have tested the product, we recommend that you set it back to its normal value in order to guarantee system stability.

**Attention:** After setting up the parameters and you leave the BIOS SETUP, and you have verified that the system can be booted, do not press the Reset button or turn off the power supply. Otherwise the BIOS will not read correctly, the parameters will not be saved properly and you must enter **CPU SOFT MENU™II** again to set up the parameters all over again.

---

**CPU Power Supply:**

This option allows you to switch between CPU Default and user define voltage.

- **CPU Default:** System will detect CPU type and select the proper voltage automatically. When it is enabled, the option “**Core Voltage**” will show the current voltage setting that is defined by the CPU and this can not be changed. We recommend using this CPU default setting and not changing it unless current CPU type and voltage setting can not be detected or not correct.
  
- **User define:** This option allows user to select the voltage manually. You can change values of the “**Core Voltage**” option list by using the Page Up and Page Down keys.

**Warning:** The wrong settings of the multiplier and external clock in certain circumstances may cause CPU damage. Setting the working frequency higher than the PCI chipset or processor specs, may cause abnormal memory module functioning; system hangs; hard disk drive data lose; VGA card abnormal functioning, or abnormal functioning in other add-on cards. Using non-specification settings for your CPU is not the intention of this explanation. These should be used for engineering testing, not for normal applications.

If you use non-specification settings for normal operation, your system may not be stable, and may effect system reliability. Also, we do not guarantee the stability and compatibility for settings that are not within specification, and any damage of any elements on the motherboard or peripherals, is not our responsibility.

## (2) Standard CMOS Setup Menu

This contains the basic configuration parameters of the BIOS. These parameters include the settings of date, hour, VGA card, FDD and HDD.

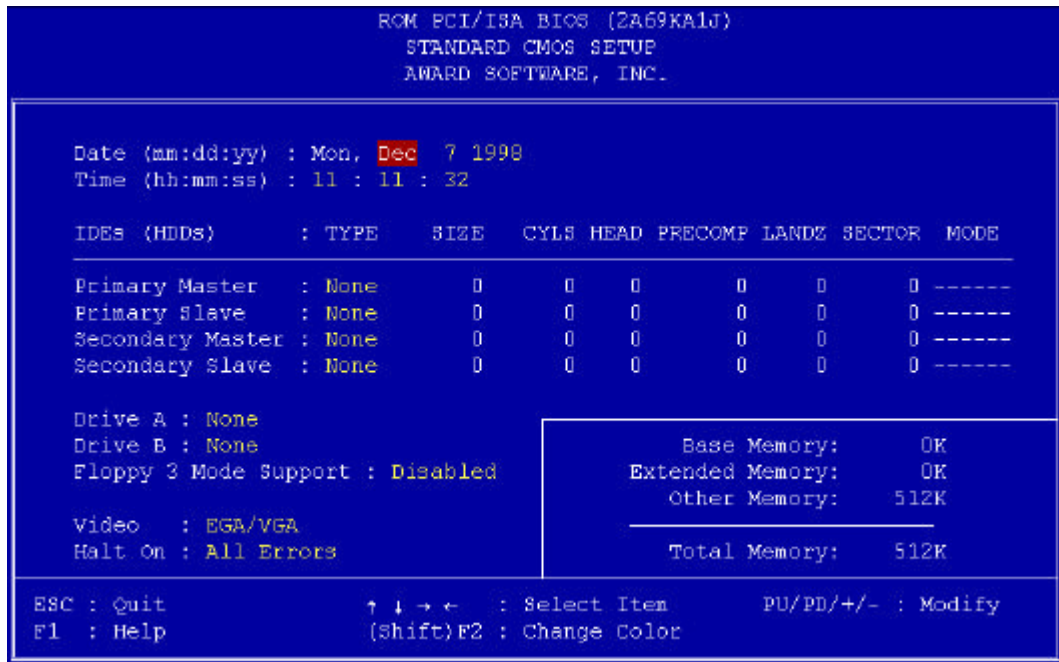

Fig 3-3 Standard CMOS Setup Menu

### Date (mm:dd:yyyy):

You can set the date information in this item, month (mm), date (dd) and year (yyyy).

### Time (hh:mm:ss):

You can set time information in this item, hour (hh), minute (mm) and second (ss).

### Setup of HDD operating mode NORMAL, LBA, LARGE<sub>j</sub> j

Since old operating systems were only able to support HDD whose capacity was not bigger than 528MB, any hard disk with more than 528MB was unusable. AWARD BIOS features a solution to this problem: you can, according to your operating system, choose three operating modes: NORMAL,

LBA or LARGE.

The HDD auto detection option in the Main Menu will automatically detect the parameters of your hard disk and the mode supported.

➤ **Normal mode:**

Standard normal mode supports hard disks of 528MB or less. This mode directly uses positions indicated by Cylinders (CYLS), Heads, and Sectors to access data.

➤ **LBA (Logical Block Addressing) mode:**

The earlier LBA mode can support HDDs capacity of up to 8.4GB, and this mode uses a different method to calculate the position of disk data to be accessed. It translates Cylinders (CYLS), Heads and Sectors into a logical address where data are located. The Cylinders, Heads, and Sectors displayed in this menu do not reflect the actual structure of the hard disk, they are just reference values used to calculate actual positions. Currently, all high capacity hard disks support this mode, that's why we recommend you use this mode. Currently, the BIOS can support INT 13h extension function, then the LBA mode supports hard disk drives capacity exceeding 8.4GB.

➤ **LARGE Mode:**

When the number of cylinders (CYLs) of the hard disk exceeds 1024 and DOS is not able to support it, or if your operating system does not support LBA mode, you should select this mode.

---

**Drive A:**

If you have installed the floppy disk drive here, then you can select the type of floppy drive it can support. Six options are available: None → 360K, 5.25 in. → 1.2M, 5.25 in. → 720K, 3.5 in. → 1.44M, 3.5 in. → 2.88M, 3.5 in. → *Back to None.*

---

**Drive B:**

If you have installed the floppy disk drive here, then you can select the type of floppy drive it can support. Six options are available: None → 360K, 5.25 in. → 1.2M, 5.25 in. → 720K, 3.5 in. → 1.44M, 3.5 in. → 2.88M, 3.5 in. → *Back to None.*

---

**FDD supporting 3 Mode:**

3 Mode floppy disk drives (FDD) are 3 1/2" drives used in Japanese computer systems. If you need to access data stored in this kind of floppy, you must select this mode, and of course you must have a 3 Mode floppy drive.

---

**Video:**

You can select the VGA modes for your video adapter, five options are available: MONO→EGA/VGA →CGA 40→CGA 80 →*Back to MONO*. The default setting is EGA/VGA.

---

**Halt On:**

You can select which type of error will cause the system to halt. Five options are available: All Errors→No Errors→All, But Keyboard→All, But Diskette→All, But Disk/Key→*Back to All Errors*.

You can see your system memory list in the lower right box, it shows the *Base Memory*, *Extended Memory* and *Other Memory* size in your system.

📄 For further information about HDD installation, refer to Appendix B.



### (3) BIOS Features Setup Menu

BIOS Features Setup Menu has already been set for maximum operation. If you do not really understand each of the options in this menu, we recommend you use default values.

In each item, you can press <F1> at any time to display all the options for this item.

```

ROM PCI/ISA BIOS (2A69KA1L)
  BIOS FEATURES SETUP
  AWARD SOFTWARE, INC.

Virus Warning           : Enabled
CPU Level 1 Cache      : Disabled
CPU Level 2 Cache      : Disabled
CPU L2 Cache ECC Checking : Enabled
Quick Power On Self Test : Disabled
Boot Sequence          : A,C,SCSI
Swap Floppy Drive      : Disabled
Boot Up Floppy Seek    : Disabled
Boot Up NumLock Status : Off
IDE HDD Block Mode     : Disabled
Typematic Rate Setting : Disabled
Typematic Rate (Chars/Sec) : 6
Typematic Delay (Msec) : 250
Security Option        : Setup
PCI/VGA Palette Snoop : Disabled
OS Select For DRAM > 64MB : Non-OS2
Report No FDD For WIN 95 : No
Delay For HDD (Secs)   : 0

Video BIOS Shadow      : Disabled
C8000-CBFFF Shadow    : Disabled
CC000-CFFFF Shadow    : Disabled
D0000-D3FFF Shadow    : Disabled
D4000-D7FFF Shadow    : Disabled
D8000-DBFFF Shadow    : Disabled
DC000-DEFFF Shadow    : Disabled

ESC : Quit           ↑↓←→ : Select Item
F1  : Help           PU/PD/+/- : Modify
F5  : Old Values    (Shift)F2 : Color
F7  : Load Setup Defaults
  
```

**Fig 3-4 BIOS Features Setup**

#### **Virus Warning:**

This item can be set as Enable or Disable.

When this feature is enabled, if there is any attempt from a software or an application to access the boot sector or the partition table, the BIOS will warn you that a boot virus is attempting to access to the hard disk.

#### **CPU Level 1 Cache:**

This item is used to Enable or to Disable the CPU level 1 cache. When the cache is set at Disable, it is much slower, so the default setting for this item is Enable. Some old and very bad programs will make the computer malfunction

or crash if the system speed is too high. In that case, you should Disable this feature.

---

### **CPU Level 2 Cache:**

This item is used to enable or to disable the CPU level 2 cache. When the external cache is enabled, the system works faster. The default is Enable.

---

### **CPU Level 2 Cache ECC Checking:**

This item is used to enable or to disable the CPU level 2 cache ECC checking function.

---

### **Quick Power On Self Test:**

After the computer has been powered on, the BIOS of the motherboard will run a series of tests in order to check the system and its peripherals. If the Quick power on self test feature is Enable, the BIOS will simplify the test procedures in order to speed up the boot process. The default is Enable.

---

### **Boot Sequence:**

When the computer boots up, it can load the operating system from floppy drive A:, hard disk drive C:, SCSI disk drive or CD-ROM. There are many options for the boot sequence:

- A, C, SCSI
  - C, A, SCSI
  - C, CD-ROM, A
  - CD-ROM, C, A
  - D, A, SCSI ( At least 2 IDE HDD can be used )
  - E, A, SCSI ( At least 3 IDE HDD can be used )
  - F, A, SCSI ( At least 4 IDE HDD can be used )
  - SCSI, A, C
  - SCSI, C, A
  - A, SCSI, C
  - LS/ZIP, C
- 

### **Swap Floppy Drive:**

This item can be set as Enable or Disable.

When this feature is enabled, you don't need to open the computer case to swap the position of floppy disk drive connectors. Drive A: can be set as drive

B, and drive B: can be set as drive A:.

---

**Boot Up Floppy Seek:**

When computer boots up, the BIOS detects if the system has FDD or not. When this item is enabled, if the BIOS detects no floppy drive, it will display a floppy disk drive error message. If this item is disabled, the BIOS will skip this test.

---

**Boot Up NumLock Status:**

- On: At boot up, the Numeric Keypad is in numeric mode.
  - Off: At boot up, the Numeric Keypad is in cursor control mode.
- 

**IDE HDD Block Mode:**

This item can be set as Enable or Disable

Most of new hard disk drives (IDE drives) support multi-sector transfers. This feature speeds up hard disk drive access performance and reduces the time necessary to access data. When this item is enabled, the BIOS will automatically detect if your hard disk drive supports this feature or not, and will choose the right settings for you. ( **The default is Disable** )

 For further details about hard disk drive installation, refer to appendix B.

---

**Typematic Rate Setting:**

This item allows you to adjust the keystroke repeat rate. When enabled, you can set the two keyboard typematic control that follow (Typematic Rate and Typematic Rate Delay). If this item is disabled, the BIOS will use the default setting.

---

**Typematic Rate (Chars/Sec):**

When you press a key continuously, the keyboard will repeat the keystroke according to the rate you have set. (Unit: characters/second; ^

---

**Typematic Rate Delay (Msec):**

When you press a key continuously, if you exceed the delay you have set here, the keyboard will automatically repeat the keystroke according a certain rate. (Unit: milliseconds)

---

**Security Option:**

This option can be set to System or to Setup.

After you have created a password through PASSWORD SETTING, this option will deny access to your system (System) or modification of computer setup (BIOS Setup) by unauthorized users.

- **SYSTEM:** When you choose System, a password is required each time the computer boots up. If the correct password is not given, the system will not start.
- **SETUP:** When you choose Setup, a password is required only when accessing the BIOS Setup. If you have not set a password in the PASSWORD SETTING option, this option is not available.

**Notice:** Don't forget your password. If you forget the password, you will have to open the computer case and clear all information in the CMOS before you can start up the system. But doing this, you have to reset all the options you had set up before.

---

**PCI /VGA Palette Snoop:**

This option allows the BIOS to preview VGA Status, and to modify the information delivered from the Feature Connector of the VGA card to the MPEG Card. This option can solve the display inversion to black after you have used the MPEG card.

---

**OS Select For DRAM > 64MB:**

When the system memory is bigger than 64MB, the communication method between the BIOS and the operating system will differ from one operating system to another. If you use OS/2, select OS2; if you choose another operating system, select Non-OS2.

---

**Report No FDD For WIN 95:**

When using Windows 95 without floppy drive , please set this item to Yes.

---

**Delay For HDD (Secs):**

This item is used to support some old model or special type of hard disks or CD-ROMs , since the BIOS may not detect those kinds of devices during system booting .

**Video BIOS Shadow:**

This option is used to define whether the BIOS on the video card uses shadow feature or not. You should set this option to Enabled, otherwise the display performance of the system will greatly decrease.

---

**Shadowing address ranges (C8000-CBFFF Shadow):**

This option allows you to decide if the memory block (BIOS) of an interface card at the address C8000-CBFFF uses the shadow feature or not. If you have no interface card using this memory block, don't enable this option.

---

**Shadowing address ranges (CC000-CFFFF Shadow):**

This option allows you to decide if the memory block (BIOS) of an interface card at the address CC000-CFFFF uses the shadow feature or not. If you have no interface card using this memory block, don't enable this option.

---

**Shadowing address ranges (D0000-D3FFF Shadow):**

This option allows you to decide if the memory block (BIOS) of an interface card at the address D0000-D3FFF uses the shadow feature or not. If you have no interface card using this memory block, don't enable this option.

---

**Shadowing address ranges (D4000-D7FFF Shadow):**

This option allows you to decide if the memory block (BIOS) of an interface card at the address D4000-D7FFF uses the shadow feature or not. If you have no interface card using this memory block, don't enable this option.

---

**Shadowing address ranges (D8000-DBFFF Shadow):**

This option allows you to decide if the memory block (BIOS) of an interface card at the address D8000-DBFFF uses the shadow feature or not. If you have no interface card using this memory block, don't enable this option.

---

**Shadowing address ranges (DC000-DFFFF Shadow):**

This option allows you to decide if the memory block (BIOS) of an interface card at the address DC000-DFFFF uses the shadow feature or not. If you have no interface card using this memory block, don't enable this option.



## Computer Knowledge



### **SHADOW**

What is the SHADOW? The BIOS of standard video or interface cards is stored in ROM, and it is often very slow. With the Shadow feature, the CPU reads the BIOS on the VGA card and copies it into RAM. When the CPU runs this BIOS, the operation is speeded up.

---

---

## (4) Chipset Features Setup Menu

The Chipset Features Setup Menu is used to modify the contents of the buffers in the chipset on the motherboard. Since the parameters of the buffers are closely related to hardware, if the setup is not correct or false, the motherboard will become unstable or you will not be able to boot up. If you don't know the hardware very well, use default values ( i.e. use the LOAD SETUP DEFAULTS option).

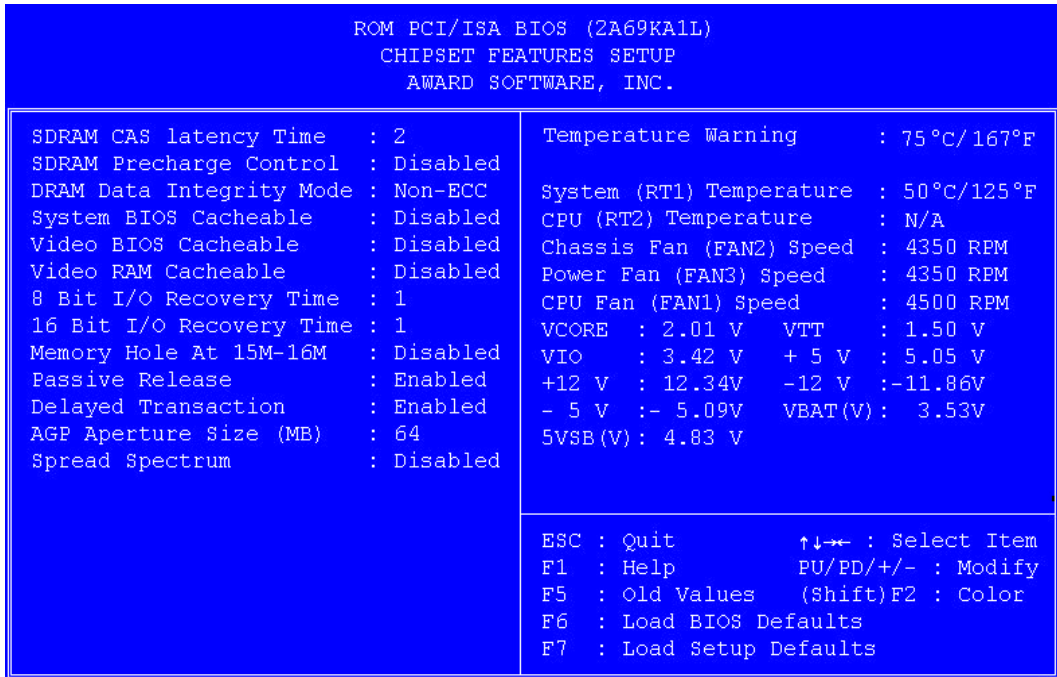

**Fig 3-5 Chipset Features Setup**

You can use the arrow keys to move between the items. Use **PgUP**, **PgDn**, **+** or **-** key to change the values. When you have finished setting up the chipset, press **ESC** to go back to the main menu.

### **SDRAM CAS latency:**

When synchronous DRAM is installed, you can control the numbers of CLKs between when the SDRAMs sample a read command and when the controller samples read data from SDRAMs. You can select SDRAM CAS (Column Address Strobe) latency time according to your SDRAM specification.

### **SDRAM precharge control**

When enabled, all CPU cycles to SDRAM result in an ALL Banks Precharge Command on the SDRAM interface.

**DRAM Data Integrity Mode:**

Two options are available: Non-ECC or ECC. This option use to configure the type of DRAM in your system. ECC is Error Checking and Correction, when your memory is ECC memory, choose the ECC option.

---

**System BIOS Cacheable:**

You can select Enable or Disable. When you select Enabled, you get faster system BIOS executing speed via the L2 cache.

---

**Video BIOS Cacheable:**

You can select Enable or Disable. When you select Enabled, you get faster video BIOS executing speed via the L2 cache.

---

**Video RAM Cacheable:**

You can select Enable or Disable. When you select Enabled, you get faster video RAM executing speed via the L2 cache. You must check your VGA adapter manual to find out if any compatibility problems will occur.

---

**8 Bit I/O Recovery Time:**

Nine options are available: NA → 8 → 1 → 2 → 3 → 4 → 5 → 6 → 7 → *Back to NA*. This option specifies the length of a delay inserted between consecutive 8 bit I/O operations. For an earlier 8 bit Add-on card, sometimes you need to adjust its recovery time to make it work normal.

---

**16 Bit I/O Recovery Time:**

Five options are available: NA → 4 → 1 → 2 → 3 → *Back to NA*. This option specifies the length of a delay inserted between consecutive 16 bit I/O operations. For an earlier 16 bit Add-on card, sometimes you need to adjust its recovery time to make it work normal.

---

**Memory Hole At 15M-16M:**

This option is used to free up the 15M-16M memory block. Some special peripherals need to use a memory block located between 15M and 16M, and this memory block has a size of 1M. We recommend that you disable this option.



---

**Passive Release :**

Two options are available: Enabled and Disabled. Set the option to enabled or disabled passive release for the Intel PIIX4 chip (Intel PCI to ISA bridge). This function is used to meet the latency of the ISA bus master, if you have an ISA card compatibility problem, you can try to enable or disable this option for optimal result.

---

**Delayed Transaction:**

Two options are available: Enabled and Disabled. Set the option to enabled or disabled delayed transaction for the Intel PIIX4 chip. This function is used to meet the latency of PCI cycles to or from the ISA bus. This option must be enabled to provide PCI 2.1 compliance. If you have ISA card compatibility problem, you can try to enable or disable this option for optimal result.

---

**AGP Aperture Size (MB):**

Seven options are available: 4 → 8 → 16 → 32 → 64 → 128 → 256 → *Back to 4*. This option specifies the amount of system memory that can be used by the AGP device. The aperture is a portion of the PCI memory address range dedicated for graphics memory address space.

---

**Spread Spectrum:**

Four options are available: Disable → 0.5%(CNTR) → 0.5%(DOWN). For EMC (Electro-Magnetic Compatibility Test) testing may need to adjust these options for optimal result, we do not recommend you change the default, except for special reasons. Some values you select may cause system instability under some situations, please be careful.

---

**Temperature Warning:**

This item lets you select the temperature that you want the system to send out a warning message of to the PC speakers when the temperature goes beyond either limit. You can select temperatures you want, they are any from 30°C / 86°F to 120°C / 248°F. It lets you increase by one step increments, 1°C / 33.8°F.

---

**Thermal, Fans Speed and Voltages Monitor:**

These items list current states of CPU and system temperature as well as fan speed. It can not be change by user.

The following items list the voltage states of the system power. Just like Thermal & Fan Monitor, it is unchangeable.

**Note:** The monitor features for temperature, fans and voltages will occupy the I/O address from 294H to 297H. If you have a network adapter, sound card or other add-on cards will use those I/O address, so please adjust your add-on card I/O address, to avoid the use of those address, because those addresses will occupied by the LM79, and cannot changed.

There are small differences in the chipset feature setup according to different motherboard models, but this has no influence upon performance. Our default setup should be the best one.

## (5) Power Management Setup Menu

The difference between Green PCs and traditional computers is that Green PCs have a power management feature. With this feature, when the computer is powered on but inactive, the power consumption is reduced in order to save energy. When the computer operates normally, it is in Normal mode. In this mode, the Power Management Program will control the access to video, parallel ports, serial ports and drives, and the operating status of the keyboard, mouse and other device. These are referred to as Power Management Events. In cases when none of these events occurs, the system enters the power saving mode. When one of the controlled events occurs, the system immediately returns to normal mode and operates at its maximum speed. Power saving modes can be divided into three modes according to their power consumption: Doze Mode, Standby Mode, and Suspend Mode. The four modes proceed in the following sequence:

**Normal Mode====> Doze Mode====> Standby Mode====> Suspend Mode**

The system consumption is reduced according the following sequence:

**Normal > Doze > Standby > Suspend**

In the Main Menu, select "Power Management Setup" and press "Enter". The following screen is displayed:

```

ROM PCI/ISA BIOS (2A69KA1E)
POWER MANAGEMENT SETUP
AWARD SOFTWARE, INC.

ACPI function      : Enabled
Power Management  : Disable
PM Control by APM : No
Video Off Method  : Blank Screen
Video Off After   : NA
CPU Fan Off Option : Always On
MODEM Use IRQ    : NA

Doze Mode         : Disable
Standby Mode      : Disable
Suspend Mode     : Disable
HDD Power Down   : Disable
Throttle Duty Cycle : 12.5%

Power Button Override: Disabled
Resume by LAN      : Disabled
Power On by Ring   : Disabled
Power on by Alarm  : Enabled
- Date(of Month)  : 20
- Time(hh:mm:ss)  : 12: 0: 0

** PM Timer Events **
IRQ[3-7,9-15],NMI : Disabled
VGA Active Monitor : Disabled
IRQ 8 Break Suspend : Disabled
IDE Primary Master : Disabled
IDE Primary Slave  : Disabled
IDE Secondary Master : Disabled
IDE Secondary Slave : Disabled
Floppy Disk        : Disabled
Serial Port        : Disabled
Parallel Port      : Disabled
Mouse Break Suspend : Yes

ESC : Quit          ↑↓←→ : Select Item
F1  : Help          PU/PD/+/- : Modify
F5  : Old Values   (Shift)F2 : Color
F6  : Load BIOS Defaults
F7  : Load Setup Defaults

```

**Fig 3-6 Power Management Setup Menu**

Use arrow keys to go to the item you want to configure. To change the settings, use **PgUP**, **PgDn**, + or - key.

After you have configured the Power Management feature, press **Esc** to go back to the Main Menu.

We are now going to briefly explain the options in this menu:

---

### **ACPI Function (Advanced Configuration and Power Interface):**

ACPI gives the operating system direct control over the power management and Plug and Play functions of a computer.

There are two options that can be select, “Enabled” and “Disabled”. You can select “Enabled” to enable ACPI functions. If you want ACPI functions to work normally, you should notice two things. One is your operating system must support ACPI, as of now only Microsoft® Windows® 98 supports these functions. The second thing is that all devices and add-on cards in your system, must fully support ACPI, both hardware and software (drivers). If you want to know whether your devices or add-on cards support ACPI or not, please contact the device or add-on card manufacture for more information. If you want to know more about ACPI specifications, please go to the address below for more detailed information:

<http://www.teleport.com/~acpi/acpihtml/home.htm>

ACPI requires an ACPI-aware operating system. ACPI features include:

- Plug and Play (including bus and device enumeration) and APM functionality normally contained in the BIOS.
- Power management control of individual devices, add-in boards (some add-in boards may require an ACPI-aware driver), video displays, and hard disk drives.
- A Soft-off feature that enables the operating system to power off the computer.
- Support for multiple wake up events (see Table 5-1).
- Support for a front panel power and sleep mode switch. Table 5-2 describes the system states based on how long the power switch is pressed, depending on how ACPI is configured with an ACPI-aware operating system.

### **System States and Power States**

Under ACPI, the operating system directs all system and device power state transitions. The operating system puts devices in and out of low-power states based on user preferences and knowledge of how devices are being used by applications. Devices that are not being used can be turned off. The

operating system uses information from applications and user settings to put the system as a whole into a low-power state.

**Table 5-1: Wake Up Device and Events**

The table below describes which devices or specific events can wake the computer from specific states.

<b>These device/events can wake up the computer</b>	<b>.....FROM THIS STATE</b>
Power switch	Sleeping mode or power off mode
RTC alarm	Sleeping mode or power off mode
LAN	Sleeping mode or power off mode
Modem	Sleeping mode or power off mode
IR command	Sleeping mode
USB	Sleeping mode
PS/2 keyboard	Sleeping mode
PS/2 mouse	Sleeping mode
Sleep button	Sleeping mode

**Table 5-2: Effect of Pressing the Power Switch**

<b>IF THE SYSTEM IS IN THIS STATE .....</b>	<b>.....AND THE POWER SWITCH IS PRESSED FOR</b>	<b>.....THE SYSTEM ENTERS THIS STATE</b>
Off	Less than four seconds	Power on
On	More than four seconds	Soft off/Suspend
On	Less than four seconds	Fail safe power off
Sleep	Less than four seconds	Wake up

---

**Power Management:**

Four options:

- User Define  
User Define defines the delay for accessing the power modes.
- Min Saving  
When the three saving modes are enabled, the system is set up for minimum power savings.  
Doze = 1 hour  
Standby = 1 hour  
Suspend = 1 hour
- Max Saving  
When the three saving modes are enabled, the system is set up for

maximum power savings.

Doze = 1 minute

Standby = 1 minute

Suspend = 1 minute

- Disable  
Disable the power management function.
- 

### **PM Control by APM:**

Power Management is completely controlled by the APM.

APM stands for Advanced Power Management, it is a power management standard set by Microsoft, Intel and other major manufacturers.

---

### **Video Off Method:**

Three video off methods are available: "Blank Screen", "V/H SYNC + Blank" and "DPMS". The default is "V/H SYNC + Blank".

If this setting does not shut off the screen, select "Blank Screen". If your monitor and video card support DMPS standard, select "DPMS".

---

### **Video Off After:**

Select the saving mode in which the video is switched off.

- NA  
The video will never be switched off in no power saving mode.
  - Suspend  
The video will only be switched off in Suspend mode.
  - Standby  
The video will only be switched off in Standby or Suspend mode.
  - Doze  
The video will be switched off in all power saving modes.
- 

### **CPU Fan Off Option:**

CPU fan can be turned off in suspend mode.

---

### **Modem Use IRQ:**

You can specify the IRQ for modem use.

**Doze Mode:**

When the setting selected for "Power Management" is "User Define", you can define for this mode any delay from 1 minute to 1 hour. If no power management event occurs during this time period, meaning that computer is inactive during this period, the system will enter the Doze power saving mode.

If this mode is disabled, the system will enter the next mode in the sequence (Standby or Suspend mode).

---

**Standby Mode:**

When the setting selected for "Power Management" is "User Define", you can define for this mode any delay from 1 minute to 1 hour. If no power management event occurs during this time period, meaning the computer is inactive during this period, the system will enter the Standby power saving mode.

If this mode is disabled, the system will enter the next mode in the sequence (Suspend mode).

---

**Suspend Mode:**

When the setting selected for "Power Management" is "User Define", you can define for this mode any delay from 1 minute to 1 hour. If no power management event occurs during this time period, meaning the computer is inactive during this period, the system will enter the Suspend power saving mode. The CPU stops working completely.

If this mode is disabled, the system will not enter the Suspend mode.

---

**Throttle Duty Cycle:**

This is used to specify the CPU speed in power saving mode. Seven options are available: 12.5%, 25.0%, 37.5%, 50.0%, 62.5% or 75.0%.

---

**HDD Power Down:**

If the system has not accessed data on the hard disk drive during the specified time period, the engine of the HDD will stop in order to save electricity.

You can set 1 to 15 minutes or select Disable according to your use of the HDD.

**Power Button Override:**

Support ACPI Power Button Over-ride. The user presses the power button for more than four seconds while the system is in the working state, then the system will transition to the soft-off (Power off by software). This is called the power button over-ride.

---

**Resume by LAN :**

To enable this feature, you must make sure your network software and network adapter (LAN card) support such a function. This function is also called “ Wake on LAN “ (WOL).

---

**Power on by Ring:**

If you connect an external modem to the onboard serial port, the system will be turned on when a telephone ring-up occurs.

---

**Power on by Alarm:**

RTC alarm can turn on the system. You can set date (of month) and time ( hour , minute , second ) .

---

**PM Timer Events:**

When one of the specifics occurs, the count down made for entry in power saving mode goes back to zero.

Since the computer will enter a power saving mode only after an inactivity delay specified (time specific for Doze, Standby and Suspend modes) and after it has no activity, during this time period, any event will cause the computer to re-count the time elapsed. Resume events are operations or signals that cause the computer to resume time counting.

**► *IRQ [3-7, 9-15], NMI:***

If any IRQ or NMI (Non-Mask Interrupt) activities occur, this will cause the computer to re-count the time elapsed.

**► *VGA Active Monitor:***

If there is any VGA data transfer or any I/O activities, this will cause the computer to re-count the time elapsed.

**► *IRQ8 Break Suspend :***

Supports the RTC alarm wake up from suspend function (via IRQ8).



➤ **IDE Primary Master:**

If any IDE primary master I/O activity occurs, it will cause the computer to re-count the time elapsed.

➤ **IDE Primary Slave:**

If any IDE primary slave I/O activity occurs, it will cause the computer to re-count the time elapsed.

➤ **IDE Secondary Master:**

If any IDE secondary master I/O activity occurs, it will cause the computer to re-count the time elapsed.

➤ **IDE Secondary Slave:**

If any IDE secondary slave I/O activity occurs, it will cause the computer to re-count the time elapsed.

➤ **Floppy Disk:**

If any floppy disk I/O activity occurs, it will cause the computer to re-count the time elapsed.

➤ **Serial Port:**

If any serial port I/O activity occurs, it will cause the computer to re-count the time elapsed.

➤ **Parallel Port:**

If any IDE secondary master I/O activity occurs, it will cause the computer to re-count the time elapsed.

➤ **Mouse Break Suspend:**

Four options are available: Yes → No (COM1) → No (COM2) → No (PS/2)  
→ *Back to Yes.*

## (6) PnP/PCI Configuration

In this menu, you can change the INT# and IRQ of the PCI bus and other hardware settings.

```

ROM PCI/ISA BIOS (2A69KA11)
PNP/PCI CONFIGURATION
AWARD SOFTWARE, INC.

PNP OS Installed      : No
Force Update ESCD    : Disabled
Resources Controlled By : Manual

IRQ-3 assigned to : PCI/ISA PnP
IRQ-4 assigned to : PCI/ISA PnP
IRQ-5 assigned to : PCI/ISA PnP
IRQ-7 assigned to : PCI/ISA PnP
IRQ-9 assigned to : PCI/ISA PnP
IRQ-10 assigned to : PCI/ISA PnP
IRQ-11 assigned to : PCI/ISA PnP
IRQ-12 assigned to : PCI/ISA PnP
IRQ-14 assigned to : PCI/ISA PnP
IRQ-15 assigned to : PCI/ISA PnP
DMA-0 assigned to : PCI/ISA PnP
DMA-1 assigned to : PCI/ISA PnP
DMA-3 assigned to : PCI/ISA PnP
DMA-5 assigned to : PCI/ISA PnP
DMA-6 assigned to : PCI/ISA PnP
DMA-7 assigned to : PCI/ISA PnP

Assign IRQ For VGA : Disabled
Assign IRQ For USB : Disabled

PIRQ_1 Use IRQ No. : Auto
PIRQ_2 Use IRQ No. : Auto
PIRQ_3 Use IRQ No. : Auto
PIRQ_4 Use IRQ No. : Auto

ESC : Quit      ↑↓←→ : Select Item
F1  : Help      PU/PD/+/- : Modify
F5  : Old Values (Shift)F2 : Color
F6  : Load BIOS Defaults
F7  : Load Setup Defaults

```

Figure 3-7. PNP/PCI Configuration Menu

### **PnP OS Installed:**

Device resource assigned by PnP OS or BIOS.

### **Force Update ESCD:**

If you want to clear ESCD data next time you boot up, and ask the BIOS to reset the settings for the Plug & Play ISA Card and the PCI Card, select Enabled. But the next time you boot up, this option will automatically be set as Disabled.



## Computer Knowledge



### **ESCD (Extended System Configuration Data)**

The ESCD contains the IRQ, DMA, I/O Port, Memory information of the system. This is a specification and a feature specific to the Plug & Play BIOS.

---

**Resources Controlled By:**

When resource are controlled manually, assign each system interrupt as one of the following types, depending on the type of device using the interrupt:

*Legacy ISA* devices compliant with the original PC AT bus specification, requiring a specific interrupt (such as IRQ4 for serial port 1).

*PCI/ISA* devices compliant with the Plug and Play standard, whether designed for PCI or ISA bus architecture.

Two options are available: Auto or Manual. The Award Plug and Play BIOS has the capability to automatically configure all of the boot and Plug and Play compatible devices. If you select Auto, all the interrupt request (IRQ) and DMA assignment fields disappear, as the BIOS automatically assigns them. But if you have trouble in assigning the interrupt resource automatically, you can select Manual to set which IRQ and DMA are assigned to PCI/ISA PnP or legacy ISA cards.

---

**Assign IRQ For VGA :**

You can assign an IRQ for the PCI VGA or Auto.

---

**Assign IRQ For USB:**

If you need another IRQ to be freed up, you can choose to disable this item, and you can get an IRQ. But in some situations in Windows® 95 it may cause the USB port to malfunction or other problems! Two options are available: Enable or Disable the assigned IRQ action.

---

**PIRQ 1 Use IRQ No. ~ PIRQ 4 Use IRQ No:**

This item allows you to specify the IRQ number for the device installed on PCI slots. Which means, you can specific the fixed IRQ number for the device installed on the PCI slots (PCI slot 1 to PCI slot 5, included AGP slot). This is a useful function when you want to fix the IRQ for a specific device.

For example, if you want to remove your hard disk to another computer and don't want to re-install the Windows® NT 4.0 (and lower versions), then you can specific the IRQ for device install on the new computer to fit original computer settings.

**Note:** If you specify the IRQ in this item, then you cannot specify the same IRQ to Legacy ISA. Otherwise, it will cause the hardware conflict.

You must be familiar with the PCI interrupt distribution mechanism to adjust this setting. This feature is for the OS which will record and fix the PCI configuration status, and you want to change it.

For the relations between the hardware layout of PIRQ (the signals from the PIIX4 chipset), INT# (means PCI slot IRQ signals) and devices, please refer to the table below:

Signals	PCI slot 1 AGP slot	PCI slot 2	PCI slot 3	PCI slot 4 PCI slot 5
<b>PIRQ_1</b>	INT A	INT B	INT C	INT D
<b>PIRQ_2</b>	INT B	INT C	INT D	INT A
<b>PIRQ_3</b>	INT C	INT D	INT A	INT B
<b>PIRQ_4</b>	INT D	INT A	INT B	INT C

- USB used PIRQ\_4.
- Each PCI slot has four INT#s (INT A~INT D), and the AGP slot has two INT# (INTA and INT B).

## **(7) Load Setup Defaults**

---

Setup defaults are the settings that allow your system to operate at its highest performance. When you choose this option, the following message is displayed:

“Load Setup Defaults (Y/N)? N”

If you want to use BIOS Setup default values, press “Y”, than <Enter> to complete the loading of the settings for best performance.

You should first load the best settings, than enter the CPU Soft Menu to set up CPU parameters, otherwise the BIOS will replace set parameters by default parameters.

## (8) Integrated Peripherals

In this menu, you can change the onboard I/O device, I/O port address and other hardware settings.

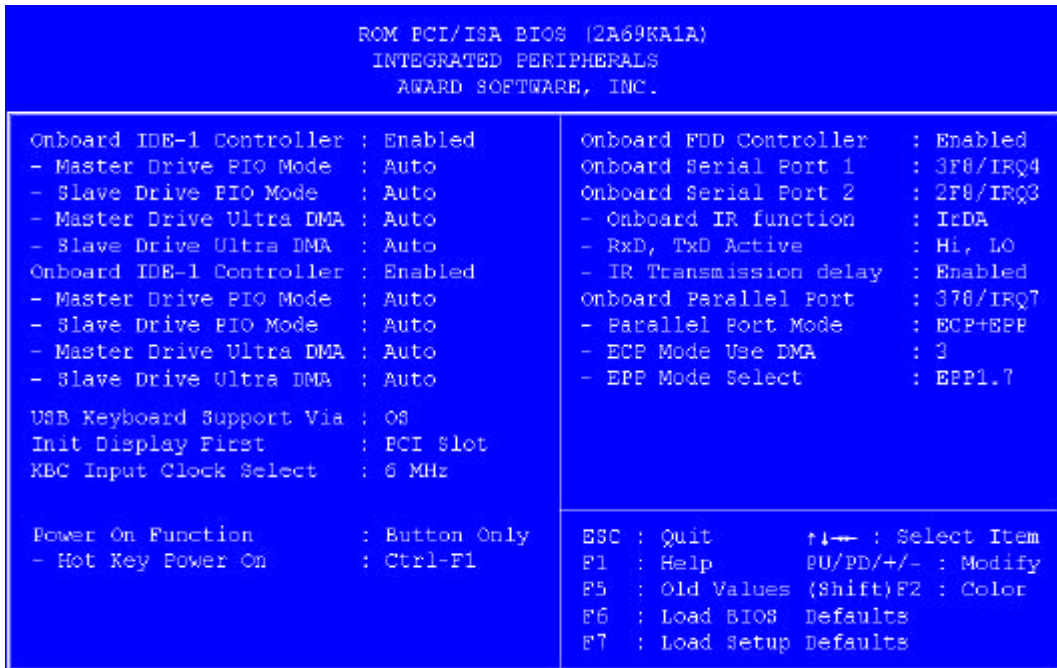

**Figure 3-8. Integrated Peripherals Menu**

### **Onboard IDE-1 Controller:**

The onboard IDE 1 controller can be set as Enabled or Disabled.

#### ⇒ Master Drive PIO Mode:

- Auto: the BIOS can auto-detect the transfer mode of the IDE devices in order to set its data transfer rate. (Default)

You can select the PIO mode from 0 to 4 of the IDE devices in order to set its data transfer rate.

#### ⇒ Slave Drive PIO Mode:

- Auto: the BIOS can auto-detect the transfer mode of the IDE devices in order to set its data transfer rate. (Default)

You can select the PIO mode from 0 to 4 of the IDE devices in order to set its data transfer rate.

⇒ Master Drive Ultra DMA:

Ultra DMA is a DMA data transfer protocol that utilizes ATA commands and the ATA bus to allow DMA commands to transfer data at a maximum burst rate of 33 MB/sec.

- Auto: When you select *Auto*, the system automatically determines the optimal data transfer rate for each IDE device. (Default)
- Disabled: If you meet the problem of using Ultra DMA devices, you can try to *Disabled* this item.

⇒ Slave Drive Ultra DMA:

- Auto: When you select *Auto*, the system automatically determines the optimal data transfer rate for each IDE device. (Default)
- Disabled: If you encounter the problem of using Ultra DMA devices, you can try to *Disabled* this item.

---

**Onboard IDE-2 Controller:**

The onboard IDE-2 controller can be set at Enabled or Disabled.

⇒ Master Drive PIO Mode:

- Auto: the BIOS can auto-detect the transfer mode of the IDE devices in order to set its data transfer rate. (Default)

You can select the PIO mode from 0 to 4 of the IDE devices in order to set its data transfer rate.

⇒ Slave Drive PIO Mode:

- Auto: the BIOS can auto-detect the transfer mode of the IDE devices in order to set its data transfer rate. (Default)

You can select the PIO mode from 0 to 4 of the IDE devices in order to set its data transfer rate.

⇒ Master Drive Ultra DMA:

Ultra DMA is a DMA data transfer protocol that utilizes ATA commands and the ATA bus to allow DMA commands to transfer data at a maximum burst rate of 33 MB/sec.

- Auto: When you select *Auto*, the system automatically determines the optimal data transfer rate for each IDE device. (Default)
- Disabled: If you meet the problem of using Ultra DMA devices, you can try to *Disabled* this item.

⇒ Slave Drive Ultra DMA:

- Auto: When you select *Auto*, the system automatically determines the optimal data transfer rate for each IDE device. (Default)
- Disabled: If you meet the problem of using Ultra DMA devices, you can try to *Disabled* this item.

PIO MODE 0~4 reflects the IDE device data transfer rate. The higher the MODE value is, the better is the IDE device data transfer rate. But it does not mean that you can select the highest MODE value just as you like, you first have to be sure that your IDE device supports this MODE, otherwise the hard disk will not be able to operate normally.

📖 For further information about HDD installation, refer to Appendix B.

---

### **USB Keyboard Support Via:**

You can choose either the OS or the BIOS to support the USB keyboard. Depending on the situation. Two options are available: *OS* or *BIOS*, *OS* is the default settings. With the *BIOS* option, you can use a USB keyboard under the MS-DOS environment but don't need to install a driver.

---

### **Init Display First:**

When you install more than one display cards, you can choose either a PCI display card or an AGP display card to activate the display boot-up screen. If you only installed one display card, the BIOS will detect which slot (AGP or PCI) you installed it, in then everything will be take care of by the BIOS.

---

### **KBC Input Clock Select:**

This item allows you to change keyboard clock, if you have keyboard problem, like keyboard failure, slow typing response time, etc. You may try to change the keyboard clock settings for optimal result.

---

### **Power On Function:**

This item allows you to select which way you want your system to power on. Four items are available: *BUTTON ONLY* → *Hot Key* → *Mouse Left* → *Mouse Right*. Default setting is *BUTTON ONLY*.

⇒ Hot Key Power On:

There are twelve options are available, Ctrl-F1 to Ctrl-F12. You can select this item and using the Ctrl plus the one of each function key (1 to 12) to power on the computer.



**Note:**

1. The mouse wake up function can only be used with the PS/2 mouse. *Mouse Left (Mouse Right)* means, you need to double click the mouse *left (right)* button, then computer will power on. If your PS/2 mouse compatibility is low, you may fail to power on.
2. If the spec. of your keyboard is too old, you may fail to power on.

---

**Onboard FDD Controller:**

This is to Enable or Disable the Onboard FDD Controller.

---

**Onboard Serial Port 1:**

This is used to specify the I/O address and IRQ of Serial Port 1. Ten options are available: Disable, 3F8h/IRQ4, 2F8h/IRQ3, 3E8h/IRQ4 or 2E8h/IRQ3, 3F8h/IRQ10, 2F8h/IRQ11, 3E8h/IRQ10, 2E8h/IRQ11, and AUTO.

---

**Onboard Serial Port 2:**

This is used to specify the I/O address and IRQ of Serial Port 2. Ten options are available: Disable, 3F8h/IRQ4, 2F8h/IRQ3, 3E8h/IRQ4 or 2E8h/IRQ3. 3F8h/IRQ10, 2F8h/IRQ11, 3E8h/IRQ10, 2E8h/IRQ11, and AUTO.

⇒ ***Onboard IR Function:***

Three options are available:

- IrDA (HPSIR)mode.
- ASK IR (Amplitude Shift Keyed IR)mode.
- Disabled.

⇒ ***RxD, TxD Active:***

Set IR transmission/reception polarity as High or Low.

⇒ ***IR Transmission Delay:***

Set IR transmission delays 4 character-time(40 bit-time) when SIR is changed form RX mode to TX mode.

---

**Onboard Parallel Port:**

Set the I/O address and IRQ of the onboard parallel port. Four options are available: Disable, 3BCh/IRQ7, 278h/IRQ5 and 378h/IRQ7. Default is 378h/IRQ7.

⇒ ***Parallel Port Mode:***

Can be set as ECP, EPP, ECP+EPP, or Normal (SPP) mode. Default is Normal (SPP) mode.

**⇒ ECP Mode Use DMA:**

When the mode selected for the onboard parallel port is ECP, the DMA channel selected can be Channel 1 or Channel 3.

**⇒ EPP Mode Select:**

When the mode selected for the onboard parallel port is EPP, two EPP version options are available: EPP1.7.

 For further information about HDD installation, refer to Appendix B.

## **(9) Password Setting**

---

This option allows you to set a password required to start the system (System) or to access to the BIOS (Setup).

After you have set a password through the PASSWORD SETTING option, you can enter the Security Option in the “BIOS Features Setup Menu” to select the security level in order to prevent any unauthorized access.

### **Password setting procedure:**

When you choose the Password setting option, the following message is displayed:

**“Enter Password:“**

Type your password. When complete, press <Enter>. The following message is displayed:

**“Confirm Password:“**

Type your password again. When complete, press <Enter>. The password setting is completed.

### **Password clearing procedure:**

When you select the Password setting option, the following message is displayed:

**“Enter Password:“**

Press <Enter>, the message “Password Disable” is displayed. Press a key. The password clearing procedure is completed.

**Notice:** Do not forget your password. If you forget it, you will have to open the computer case, clear the contents of the CMOS, and boot the system up again. By doing this, you must reset all your parameters.

## **(10) IDE Hard Disk Detection**

---

After you have installed the hard disk, in old systems, you had to know the hard disk specifications, such as the number of cylinders, heads and sectors, and to enter the relevant information into the hard disk information section. If the CMOS data was erased, and you had forgotten the hard disk specifications, it was a great problem. But now, you can use this option to auto detect the hard disk type and specifications, and the BIOS will automatically detect all the relevant information and place them in the Hard Disk data section of the Standard CMOS Setup Menu, in order to allow you to use your hard disk.

## (11) Save & Exit Setup

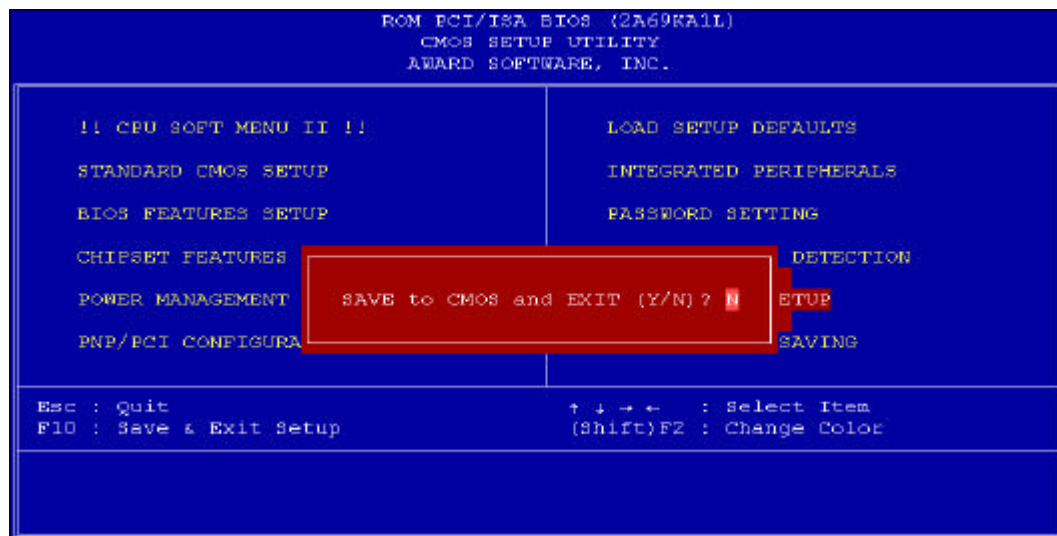

**Fig 3-9 Save & Exit Setup**

You can save all your selection to CMOS and exit BIOS to reboot your computer.

## (12) Exit Without Saving

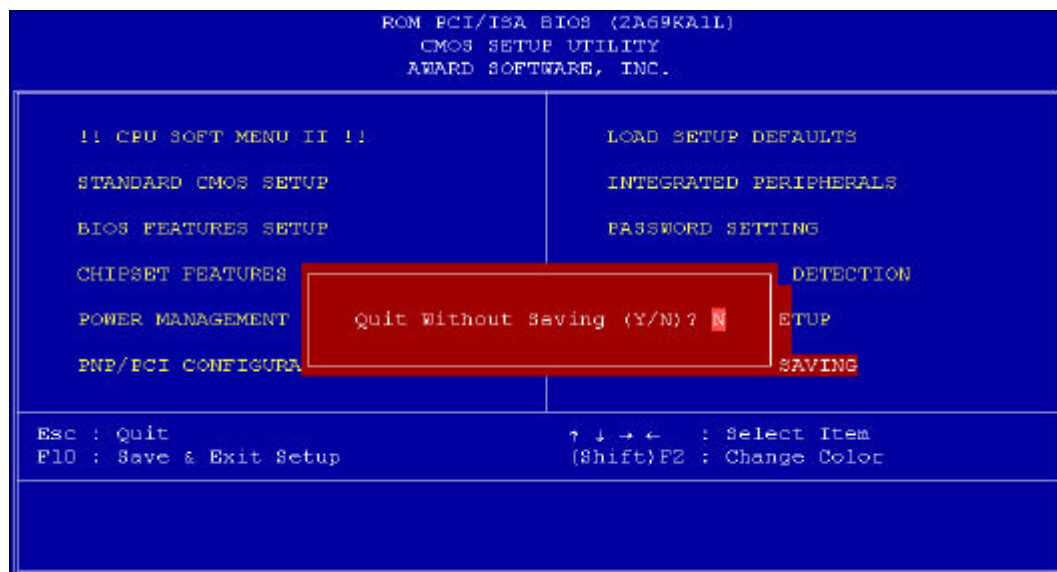

**Fig 3-10 Exit Without Saving**

You can exit and without saving all your selections to CMOS, then exit BIOS to reboot your computer.

# **Appendix A Quick Installation**

---

Appendix A will give you a simplified installation procedure, in order to allow you to install your motherboard quickly and correctly.

If you need further information or if you need to change some other settings, start reading from Chapter 1.

---

## **Installing the CPU**

Mount the retention mechanism onto Slot 1, then fix the screw on the four corners of the mechanism. Slightly and gently insert the Pentium® II/III processor into the retention base, make sure all the components are affixed securely.

---

## **Adjusting CPU speed**

According to your CPU speed, set up the CPU in the **CPU SOFT MENU™ II** of the BIOS SETUP.

---

## **Installing System Memory**

You can install the SDRAM module (168 pin DIMM module) to the DIMM sockets (DIMM 1~DIMM5), the maximum memory capacity of this motherboard is 1GB.

---

## **Installing FDD**

Watch the pin position and the orientation

**FDC:** Connect one end of the 34-pin cable that comes with the motherboard or the drive to the FDD connector, and the other end of the cable to the FDC pin connector on the motherboard.

<p><b>Note:</b> Be sure that the red line on the cable connects to the first pin of the connectors.</p>
---

---

## **Installing HDD**

Watch the pin position and the orientation

**IDE1 (Primary IDE):** Connect one end of the 40-pin cable that comes with the motherboard or the drive to the HDD connector, and the other end to IDE1 pin connector on the motherboard.

**Note:** Be sure that the red line on the cable connects to the first pin of the connectors.

### **Installing CD-ROM drive**

Watch the pin position and the orientation

**IDE2 (Secondary IDE):** Connect one end of the 40-pin cable that comes with the drive to the CD-ROM connector, and the other end to the IDE2 pin connector on the motherboard.

**Note:** Be sure that the red line on the cable connects to the first pin of the connectors.

### **Installing Keylock and power LED connectors**

Watch the pin position and the orientation

**PN1 Pin 1-5:** There is a specific orientation for pin 1 to pin 5. Insert the two-threads keylock cable into pin 4 and pin 5, and three-threads power LED cable to Pin 1 ~ pin 3. Correct pins of header on the motherboard.

Pin number	Name of the signal or signification
1	+5VDC
2	No connection
3	Ground
4	Keyboard inhibit Signal
5	Ground

### **Installing HDD LED connector**

Watch the pin position and the orientation

**PN1 Pin 7-8:** There is a specific orientation for pin 7 and pin 8. Connect the two-threads IDE HDD LED connector of the computer case to correct pins of header on the motherboard.

Pin number	Name of the signal or signification
7	LED power
8	HDD active

---

**Installing power On/Off switch connector**

**PN1 Pin 10-11 :** There is no specific orientation for pin 10 and pin 11. Connect the two-threads power switch cable to the PN1 header pins on the motherboard.

Pin number	Name of the signal or signification
10	Power On/Off switch
11	Ground

---

**Installing suspend switch connector**

**PN1 Pin 13-14:** There is no specific orientation for pin 13 and pin 14. Connect the two-threads suspend switch connector of the computer case to correct pins of header on the motherboard. You can ignore this connector since most of computer cases do not support this feature (the motherboard itself supports it).

Pin number	Name of the signal or signification
13	Vcc
14	Suspend signal

---

**Installing Hardware Reset Switch Connector**

**PN2 Pin 1-2:** Attach the cable from the case's Reset switch to this header. Press and hold the reset button for at least one second to reset the system.

Pin number	Name or significance of signal
1	Reset input
2	Ground

---

**Installing speaker connector**

**PN2 Pin 4-7:** There is no specific orientation for pin 4 and pin 7. Connect the four-threads speaker cable to the PN2 header pins on the motherboard.

Pin number	Name of the signal or signification
4	+5VDC
5	Ground
6	Ground
7	Speaker data

**Installing suspend LED connector**

Watch the pin position and the orientation

**PN2 Pin 9-10:** There is a specific orientation for pin 9 and pin 10. Connect the two-threads suspend LED switch connector of the computer case to correct pins of header on the motherboard.

Pin number	Name or significance of signal
9	LED Power
10	Suspend LED active

**Installing ATX Power input connector**

Watch the pin position and the orientation

**CONT1:** Connect the power supply unit to the correct connectors on the motherboard.

Pin number	Name of the signal or signification	Pin number	Name of the signal or signification
1	+3.3VDC	11	+3.3VDC
2	+3.3VDC	12	-12VDC
3	Ground	13	Ground
4	+5VDC	14	ON/OFF control signal
5	Ground	15	Ground
6	+5VDC	16	Ground
7	Ground	17	Ground
8	Power Good	18	-5VDC
9	+5VSB	19	+5VDC
10	+12VDC	20	+5VDC

**Installing Keyboard connector**

Watch the pin position and the orientation

**KM1 lower connector:** There is an orientation pin. Connect your PS/2 keyboard connector to the connector on back side of the motherboard.

**Installing PS2 Mouse**

Watch the pin position and the orientation



**KM1 upper connector:** There is an orientation pin. Connect your PS/2 mouse connector to the connector on the back side of the motherboard.

---

**Installing CPU fan power connector**

Watch the pin position and the orientation

**FAN:** There is a specific orientation. Connect the three-threads fan power cable to the fan header on the motherboard.

<b>FAN1, FAN2, FAN3 (CPU FAN)</b>	
Pin number	Name of the signal or signification
1	Ground
2	+12V
3	Sense signal

---

**Adjusting other jumpers**

Some jumpers are reserved for future functions or are not to be adjusted in normal operation. Adjust them according to the following recommendations.

**CCMOS j** Always put jumper on pin 1 and pin 2, this is default setting.

---

**BIOS Setup**

Parameters and CPU settings After you have followed the steps described above and completed the installation, when you power the computer on, you will see the following message displayed

**PRESS DEL TO ENTER SETUP**

Press immediately Del key to enter BIOS Setup. Select Load Setup Defaults, than enter CPU Soft Menu to set CPU parameters.



## **Appendix B General Discussion About HDD Installation**

---

Most of the present HDDs use IDE interface. Installing an IDE hard disk does not require a lot of knowledge like installing the driver for a SCSI hard disk, but this means that the user often must install the hard disk by himself and cope with all the problems they may encounter. Here, we will try to help you solve these potential problems.

The data stored in the hard disk are accessed through the chipset located on the motherboard. You might often hear about the PIO mode, Master mode or DMA mode of HDD. These modes reflect the way data is transferred from and to the IDE drive and the motherboard.

What is the PIO mode? When the system needs to access hard disk data, the CPU delivers input/output (I/O) orders through the chipset on the motherboard to the hard disk drive, and then puts this data into the system memory. This is the PIO mode.

What is the Master mode? When the system needs to access hard disk data, this data is directly accessed from the hard disk by the chipset on the motherboard (using a DMA or a PIO mode), and then the data is put into the memory. In this case, the CPU does not participate in the data transfer.

What is the DMA mode? Usually, DMA mode refers to accessing the hard disk data by the chipset, it does not refer to the data transfer mode. Here are some examples of data transfer rates for IDE HDD with PIO interface:

- PIO Mode 0: The fastest data transfer rate reaches 3.3Mbyte/sec
- PIO Mode 1: The fastest data transfer rate reaches 5.2Mbyte/sec
- PIO Mode 2: The fastest data transfer rate reaches 8.3Mbyte/sec
- PIO Mode 3: The fastest data transfer rate reaches 11.1Mbyte/sec
- PIO Mode 4: The fastest data transfer rate reaches 16.6Mbyte/sec

The higher the MODE value is, the best is the hard disk data transfer rate. But this does not mean that you can select the highest mode value as you like. You must be sure that your hard disk supports that type of fast data transfer, otherwise your hard disk will not be able to operate correctly.

Here are some examples of data transfer rates for IDE HDD with DMA mode:

- DMA Mode 0: The fastest data transfer rate reaches 4.16Mbyte/sec
- DMA Mode 1: The fastest data transfer rate reaches 13.3Mbyte/sec
- DMA Mode 2: The fastest data transfer rate reaches 16.6Mbyte/sec

Usually, PIO mode means that the hard disk data are accessed by the CPU through the chipset and placed into memory, and the chipset is using PIO mode to access hard disk data.

MASTER mode means that hard disk data are accessed by the chipset, and that the chipset places the data into memory. The chipset is using DMA or PIO mode to access data stored in the hard disk drive. The Master mode can reduce the CPU load, especially in a Multi-task environment. This can help system performance.

### **Installing a hard disk:**

In the Standard CMOS Setup Menu,

- ◆ Primary means the first connector on the motherboard, that is, connector IDE1 on our motherboard.
- ◆ Secondary means the second connector on the motherboard, that is, connector IDE2 on our motherboard.
- ◆ Two HDDs can be connected to the each connector:

The first HDD is referred to as Master, The second HDD is referred to as Slave.

**Note:** The Master or Slave status of the hard disk drive is set on the hard disk itself. Refer to the hard disk drive manual.

### **Installing one HDD:**

*The red line on the connection cable must be lined up with pin 1 on the connector.*

Be sure that your hard disk drive is set at Master. Actually, most hard disk drives are set at Master as a default, so you don't need to adjust any setting. Just connect one end of the 40 pin cable on the drive connector, and the other end to connector IDE1 on the motherboard.

### **Installing one HDD + one CD-ROM drive:**

*The red line on the connection cable must be lined up with pin 1 on the connector.*

Method 1: Set the HDD at Master, and the CD-ROM drive at Slave. Connect one connector of the 40-pin cable to the hard disk, another one to the CD-ROM drive, and the other end to connector IDE1 on the motherboard.

Method 2: Set the HDD as Master and connect one end of the 40-pin cable to the HDD, and the other end to connector IDE1 on the motherboard.

You can ignore the setting of the CD-ROM drive, just

connect one end of the 40-pin cable to the CD-ROM drive, and the other end to connector IDE2 on the motherboard. We recommend you use this kind of connection, since it has no influence on HDD speed.

### **Installing two HDDs:**

***The red line on the connection cable must be lined up with pin 1 on the connector.***

Method 1: Set the hard disk drive used for boot up at Master, and the other drive at Slave. Connect one of the connectors of the 40-pin cable to the first drive, another connector to the second drive, and the other end of the cable to connector IDE1 on the motherboard.

Method 2: Set the hard disk drive used for boot up at Master, connect one end of the 40-pin cable to the drive, and the other end to connector IDE1 on the motherboard.

Set the other hard disk drive at Master, connect one end of the 40-pin cable to the drive, and the other end to connector IDE2 on the motherboard.

### **Installing two HDDs + one CD-ROM drive:**

***The red line on the connection cable must be lined up with pin 1 on the connector.***

Method 1: Set the hard disk drive used for boot up as Master, set the other HDD at Slave, connect one connector of the 40-pin cable to the first drive, another connector to the second drive, and the other end of the cable to connector IDE1 on the motherboard. You can ignore the setting of the CD-ROM drive. Connect one end of the 40-pin cable to the drive, and the other end to connector IDE2 on the motherboard. We recommend you use this method, since it has no influence on HDD speed.

Method 2: Set the hard disk drive used for boot up at Master, connect one end of the 40-pin cable to the drive, and the other end to connector IDE1 on the motherboard. Set the other hard disk drive at Master, and be sure that the CD-ROM drive is set at Slave. Most of CD-ROM drives are set at Slave as a default, so you will normally not have to set the CD-ROM drive. After you have verified the settings, connect one connector of the 40-pin cable to the HDD, another connector to the CD-ROM drive, and the other end of the cable to connector IDE2 on the motherboard.

## Installing three HDDs:

*The red line on the connection cable must be lined up with pin 1 on the connector.*

Method 1: Set the hard disk drive used for boot up at Master, set the second drive at Slave. Connect one connector of the 40-pin cable to the first drive, another connector to the second drive, and the other end of the cable to connector IDE1 on the motherboard.

Set the other (the third) drive at Master, and connect one end of the 40-pin cable to the drive, and the other end to connector IDE2 on the motherboard.

Method 2: Set the hard disk drive used for boot up at Master, and connect one end of the 40-pin cable to the drive and the other end to connector IDE1 on the motherboard. Set another drive (the second drive) at Master and the third drive at Slave, connect one connector of the 40-pin cable to the second drive, another connector to the third drive, and the other end of the cable to connector IDE2 on the motherboard.

## Installing three HDDs + one CD-ROM drive:

*The red line on the connection cable must be lined up with pin 1 on the connector.*

Set the hard disk drive used for boot up at Master, set another HDD (the second) at Slave, connect one connector of the 40-pin cable to the first drive, another connector to the second drive, and the other end of the cable to connector IDE1 on the motherboard.

Set the third hard disk drive at Master, set the CD-ROM drive at Slave, connect one connector of the 40-pin cable to the third HDD, another connector to the CD-ROM drive, and the other end of the cable to connector IDE2 on the motherboard.

## BIOS Setup:

- ◆ If all your HDDs are new, you can use the **IDE HDD Auto Detection** option in the CMOS to auto detect the parameters of all your drives. You don't need to set any hard disk parameter.
- ◆ If one or several of your HDDs are old, and if you don't know their parameters, and you want to reconfigure your drives, you can still use the **IDE HDD Auto Detection** option in the CMOS to auto detect the drives parameters.

- ◆ If one or several of your HDD are old, and if you don't want to erase the data stored in your drives, you will have to remember the parameters (Type, Cylinders, Heads, Sectors, Mode) of the drive(s) you don't want to erase. After you have used the **IDE HDD Auto Detection** option in the CMOS, enter the **Standard CMOS Setup Menu** to change the settings of the related hard disk drive.

### **Software use:**

The basic step in using a hard disk drive is to make a **HDD Low Level Format**, than run **FDISK**, and than **FORMAT** the drive. Most of present HDD have already been subjected to low level format at the factory, so you probably can skip this operation.

Boot with a bootable floppy disk, then enter:

#### **FDISK**

✳Using **FDISK**: (DOS command)

This command is found in the DOS disks.

**FDISK** is a tool used to organize and to partition the hard disk. The hard disk must have been partitioned before use. You can create one unique partition on the hard disk, or create several partition and use a different Operating System on each partition. Just don't forget that you have to specify an Active partition, otherwise your hard disk will not be bootable. For further information about **FDISK**, refer to the **FDISK** section in the DOS user's manual.

After you have partitioned the hard disk with **FDISK**, the system will reboot automatically. Boot from a system floppy disk, and type

#### **FORMAT C: /S**

✳Using **FORMAT**: (DOS command)

This command is found in the DOS disks.

**FORMAT** is used to format the hard disk. The HDD have to be formatted before use. Don't forget to add **/S** after **C:**, otherwise the hard disk will not be bootable after formatting.





## Appendix C BIOS Flashing User Instructions

---

When your motherboard needs to be upgraded with new features or to fix some compatibility problems of a BIOS, you will need to use this BIOS flash utility. This utility is provided by Award Software, and it's easy to flash by yourself. But you have to read all the information within this section before flashing.

Before you can flash the BIOS you need to first go into the *pure DOS environment* by rebooting your system and going directly into DOS. Basically, there are two ways to flash your BIOS. One is to directly type the full line commands that are described in this section. The utility will then flash your BIOS. When you finish the flash operation, you will see the screen as in Figure C-2.

The other method is to just type `awdf flash` then press enter, the Flash Memory Writer V6.66 screen will show up, please refer to Figure C-1. You need to type "NEWBIOS" (the file name or you can use another name if you choose) into the "File Name to Program", then press enter. When you finish the flash operation, you will see the screen as in Figure C-2.

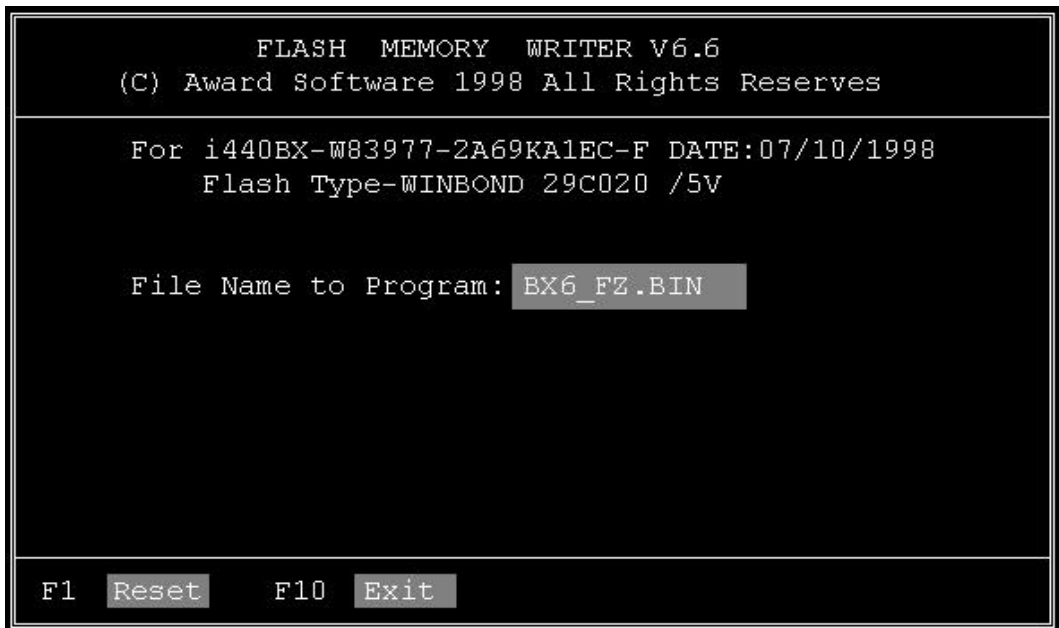

**Figure C-1. Award Flash Memory Writer V6.66 Start Screen**

When you have finished updating your BIOS, you will see the screen as in Figure C-2. You then need to press the “F1” key to reset the system, or press the “F10” key to exit the writer.

```

FLASH MEMORY WRITER V6.6
(C) Award Software 1998 All Rights Reserves

For i440BX-W83977-2A69KA1EC-F DATE:07/10/1998
Flash Type-WINBOND 29C020 /5V

File Name to Program: BX6_FZ.BIN

Checksum:A7F0H

Reset System or power off to
accomplish update process!

F1 Reset F10 Exit

```

**Figure C-2. Award Flash Memory Writer V6.66 Complete Screen**

Figure C-3 shows you what commands you can use for the flashing program, you need to go into the pure DOS environment and type awdf flash /?, then you will see Figure C-3.

```

Awdflash 6.6 (C)Award Software 1998 All Rights Reserved

Usage: AWDFLASH [FileName] [FileName] [/<sw>[/<sw>...]]

FileName1 : New BIOS Name For Flash Programming
FileName2 : BIOS File For Backing-up the Original BIOS
<Switches>
  ?: Show Help Messages
  py: Program Flash Memory           pn: No Flash Programming
  sy: Backup Original BIOS To Disk File  sn: No Original BIOS Backup
  sb: Skip BootBlock programming       sd: Save DMI date to file
  cp: Clear PnP(ESCD) Data After Programming
  cc: Clear CMOS Data After Programming
  R: RESET System After Programming
  E: Return to DOS When Programming is done
  F: Use Flash Routines in Original BIOS For Flash Programming
  LD: Destory CMOS Checksum And No System Halt For First Reboot
      After Programming

Example:AWDFLASH 2a59i000.bin /py/sn/cp

A:\>

```

**Figure C-3. Flash Commands Screen**

Example 1 To update the BIOS and create a backup of the current system BIOS execute this command:

**AWDFLASH NEWBIOS /PY SAVEBIOS /SY**

Example 2 To update the BIOS, create a backup of current system BIOS, and clear the CMOS, execute this command:

**AWDFLASH NEWBIOS SAVEBIOS /CC**

Example 3 To update the BIOS and clear PnP settings execute this command:

**AWDFLASH NEWBIOS /SN /CP**

Example 4 To make a backup of the current system BIOS execute the following command:

**AWDFLASH NEWBIOS /PN SAVEBIOS**

**Notes:** “NEWBIOS” indicates the file name for the new BIOS which can be downloaded from our website at <http://www.abit.com.tw> (the user can choose a different file name in place of NEWBIOS).  
“SAVEBIOS” indicates the filename of the old system BIOS (the user can choose a different file name in place of SAVEBIOS).

Explanation of parameter names:

- /CC: Clears CMOS data
- /CP: Clears PnP data

Remarks:

- ① When executing AWDFLASH.EXE, do not run HIMEM.SYS and EMM386.EXE in the CONFIG.SYS.
- ② Please take the following actions to solve problems caused by power shortage or other non preventable malfunctions during BIOS updating that lead to update failure. First, it is strongly suggested that you format a disk that can boot your computer before you update your BIOS. If the above mentioned problem occurs during BIOS update you will be able to use this disk to automatically execute a BIOS updating. The content of the disk should be the following:
  - a. Startup system files (COMMAND.COM, MSDOS.SYS, IO.SYS...)
  - b. AWDFLASH.EXE
  - c. The NEWBIOS file which can be downloaded from ABIT’s website.
  - d. AUTOEXEC.BAT, which has the following content:  
A:\AWDFLASH NEWBIOS /PY /SN /CCFor example, to update the IT6B BIOS version to FZ (it6b\_fz.bin),

you need to type:

**A:\AWDFLASH IT6B\_FZ.bin /PY /SN /CC**

- ③ If you try to flash a version of BIOS that is for the incorrect motherboard model the following message will appear:  
**“The program file’s part number does not match with your system!”**

## Appendix D How to install the IDE Bus Master driver

---

This motherboard not only supports the IDE Bus Master, it also supports the Ultra DMA/33 HDD . If your hard disk drive supports this function you need to install the Ultra DMA driver software on the CD-ROM included with this motherboard for better performance (Some model's packaging may only have a floppy diskette). If your HDD does not support Ultra DMA/33 specs, you can still install this driver with no harm! Complete the installation process exactly as below:

In Windows 95, place the CD-ROM into the computer. The main menu will show up. Click the **Drivers** button, then select the **IDE Master** button, again select the OS in which you want to install the driver. We have provided the OS/2, Windows® 95 and Windows® NT Bus Master driver for you. Direct clicking the OS button will automatically install the Bus Master driver to your system.

If you have a floppy diskette instead of the CD-ROM, you need to place the diskette into your floppy disk drive, and go into the proper OS directory. When you get in the OS directory, for example Windows® 95, you can double click the **Setup.exe** icon, this will start the drivers installation. Please follow the procedure below:

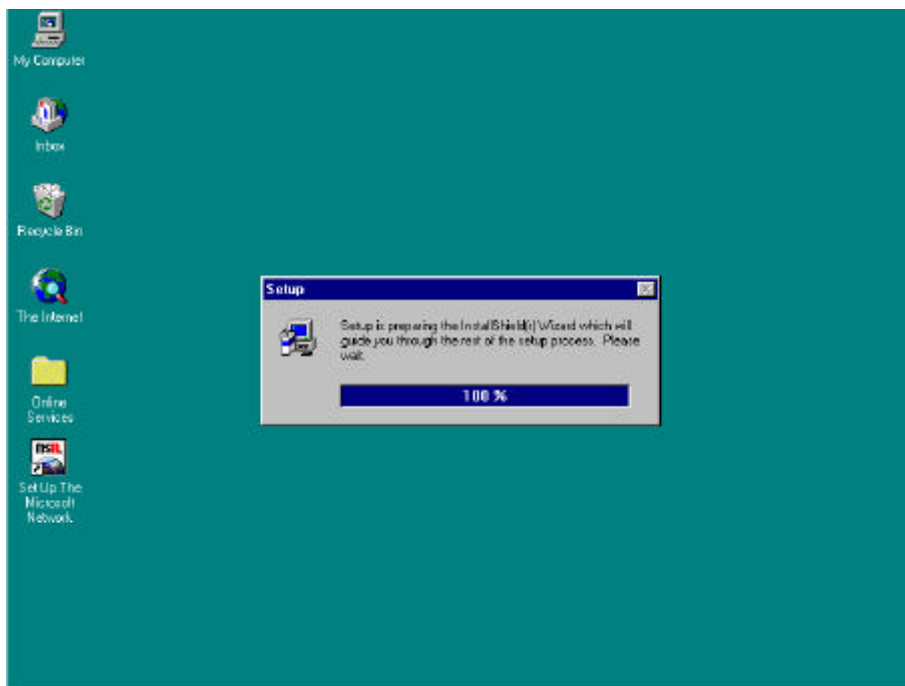

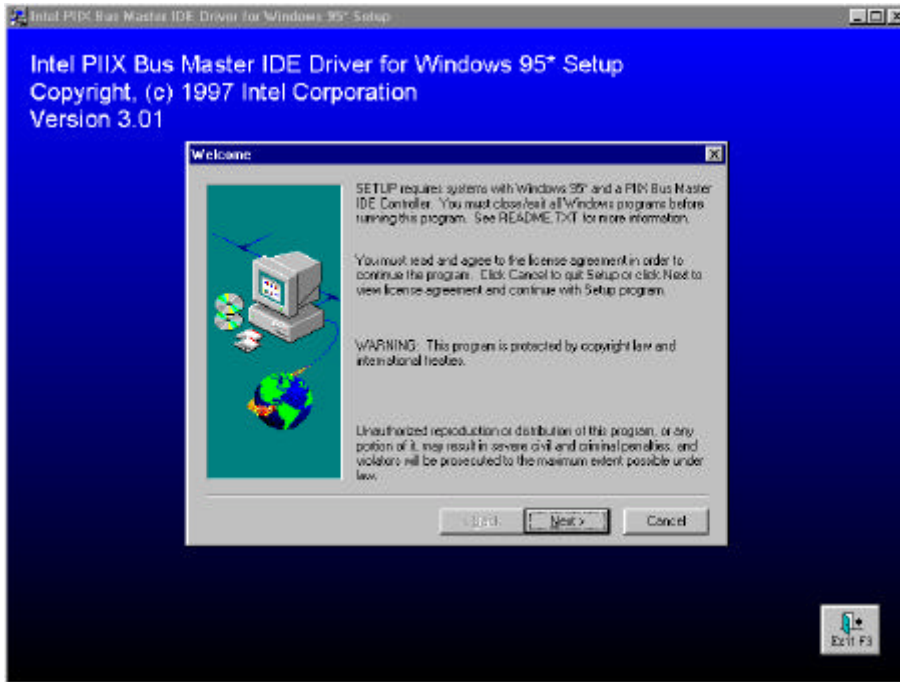
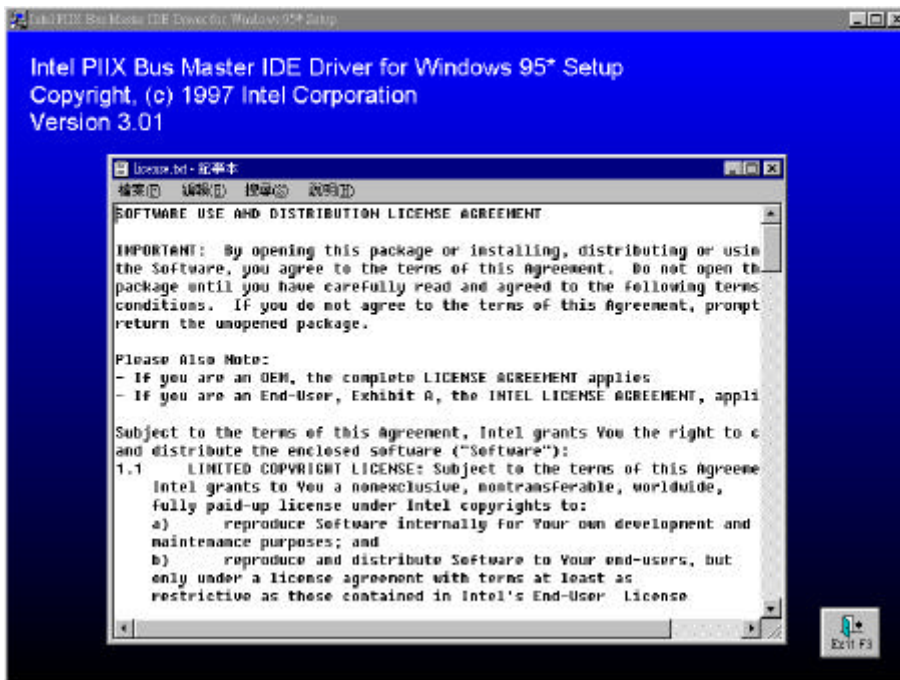
**Step1:** Welcome: Click 'NEXT'**Step2:** License screen: Notepad will show the content, close the notepad to continue.

**Step3:** Question: Click 'Yes'

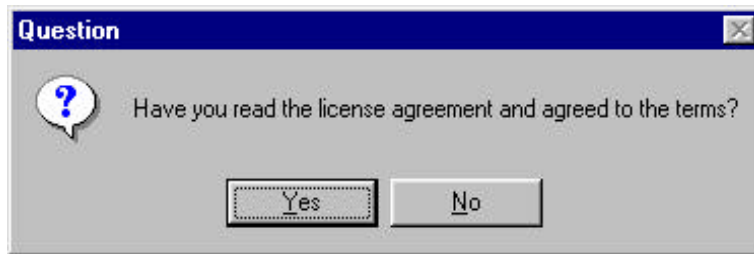

**Step4:** Select Components: Click 'INSTALL'

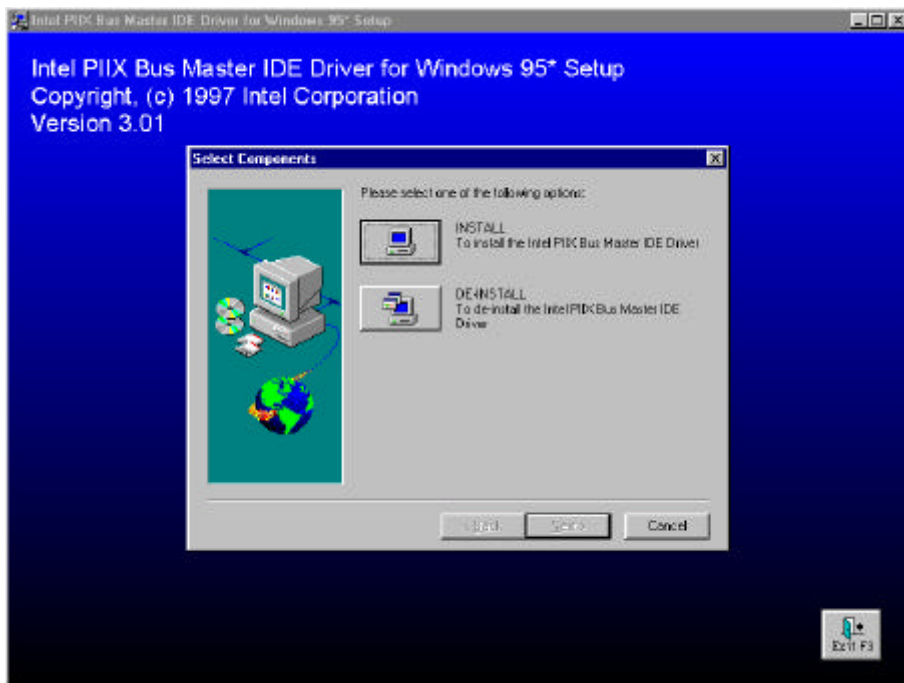

**Step5:** Question: Click 'Yes'

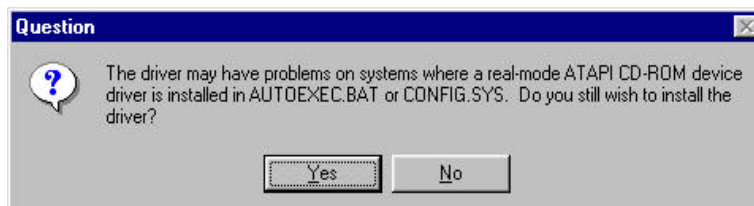

**Step6:** Information: Click 'OK'

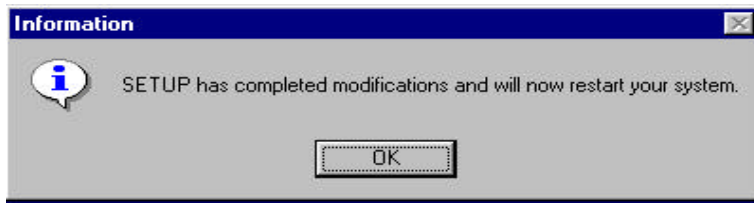

After previous instructions have been followed, the driver will automatically install. It will automatically restart the computer after it has finished installing.

**Step7:** When you restart your Windows® 95, just follow the step shows on the screens. After you see the screen below, please set the path to C:\WINDOWS\SYSTEM\IOSUBSYS then finish the following steps. You will need to restart Windows, then Windows will find several I/O devices, when finished with this procedure, you will need to restart Windows® 95 yet again. This will fully complete the installation of the IDE Bus Master drivers.

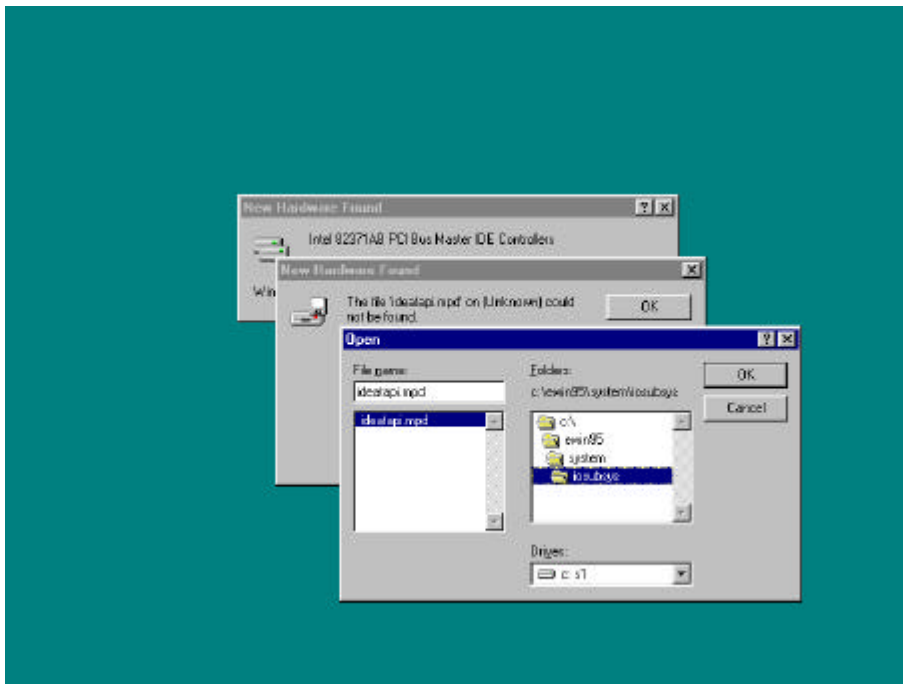



## Appendix E How to install the PCI bridge driver for the 440BX chipset

---

This CD-ROM (Or floppy diskette) has the Intel's 82371xB INF update 3.2.2 drives version. It can be used to update the 440BX chipset motherboard. The following procedure describes how to install and update the PCI bridge. If you have a floppy diskette and not the CD-ROM, just insert the diskette and execute the **Setup.exe** file to start installation of the INF update files.

**Step 1:** Check your Windows® 95 *Device Manager*, and find the question mark showing the PCI Bridge.

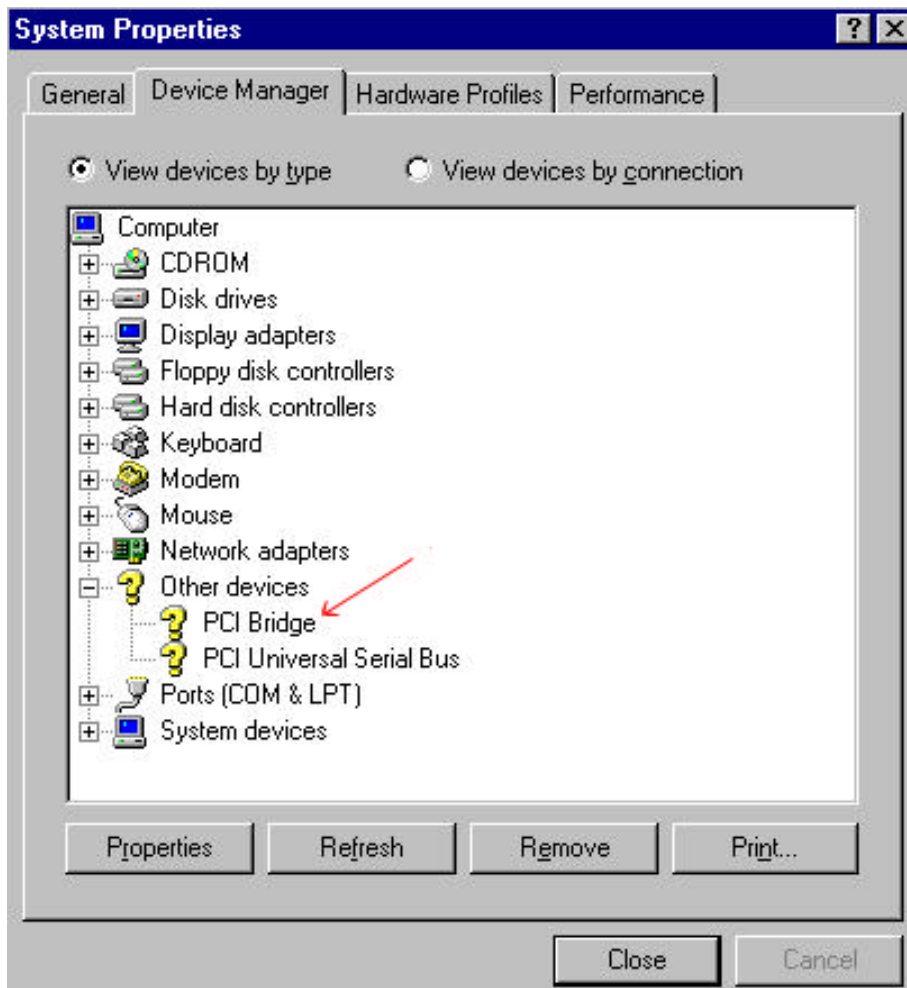

**Step 2:** Execute the Product CD-Title *ABITCD.EXE* and choice *Driver* → *PCI Bridge Driver for Windows 95*, then you will see the screen below:

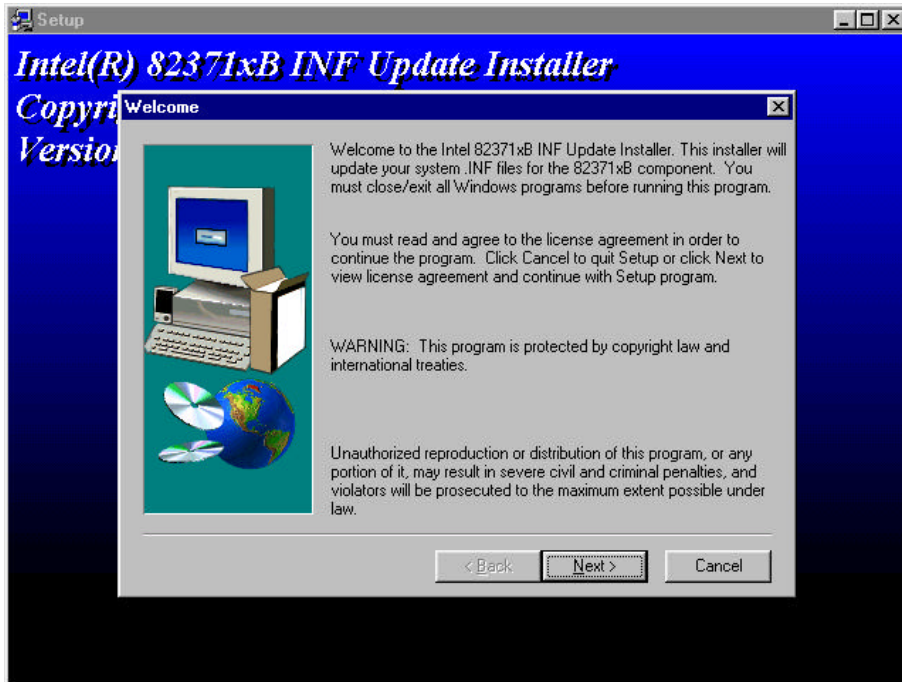

**Step 3:** Click *NEXT*

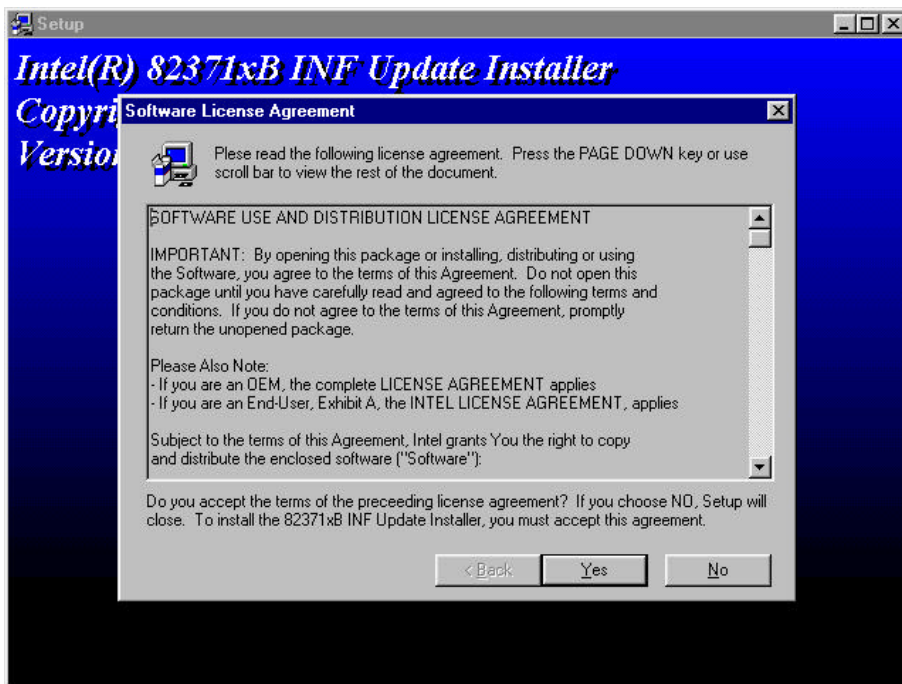

**Step 4:** You will see the license agreement dialog screen, click *Yes*.



**Step 5:** Click *Next*, then wait a while, until you see the installation complete screen.

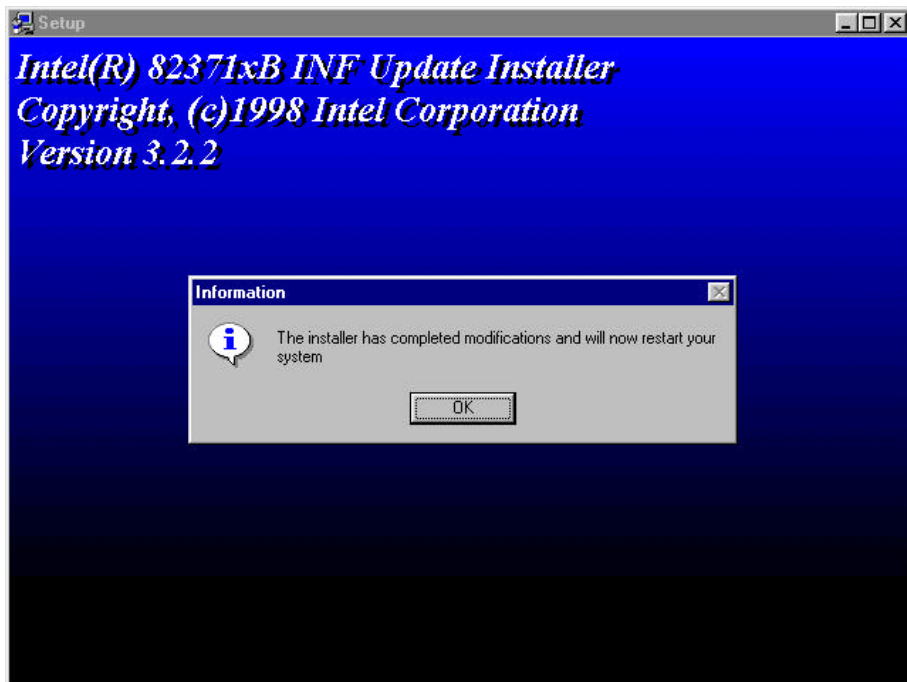

**Step 6:** Click *OK*, the system will restart.

**Step 7:** Restart your computer, then check the *Device Manager* again. First, you can check *Hard Disk Controller*, then take a look to see if the Bus Master driver is already recognized.

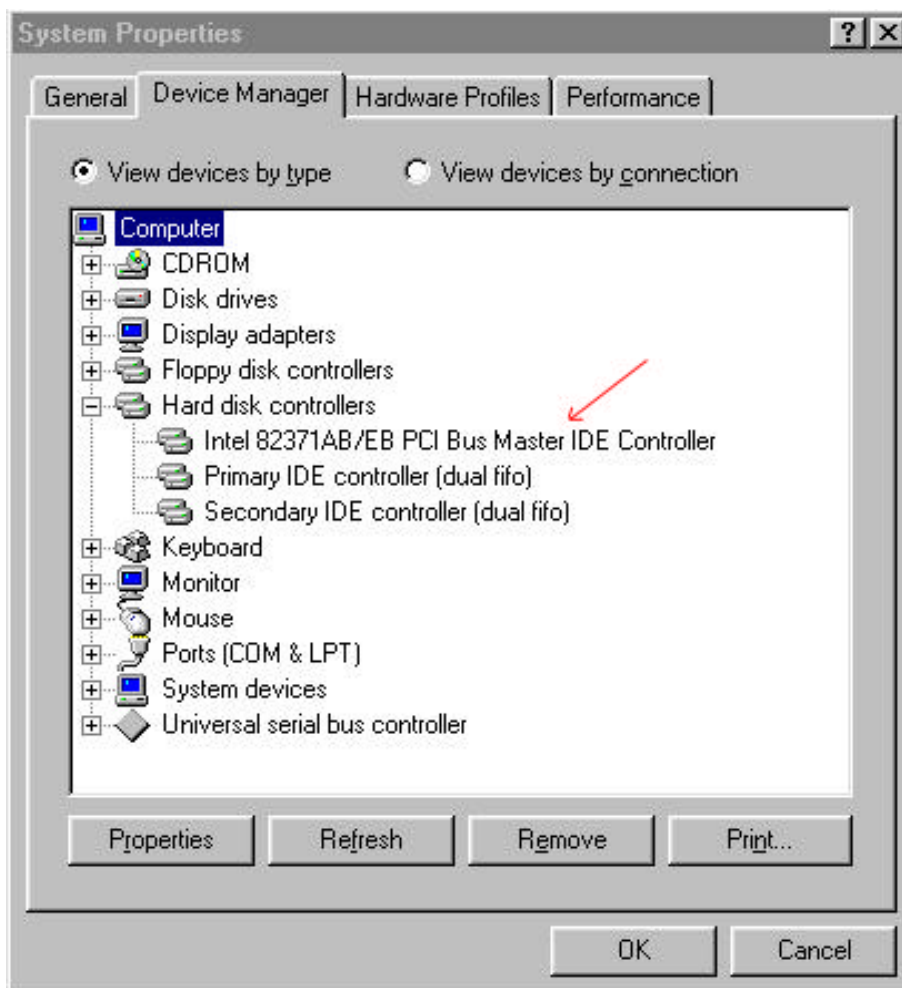

**Step 8:** Also check *System Device*, to find out if four devices are identified as well. ( Please see the arrows below) You have completed all things now.

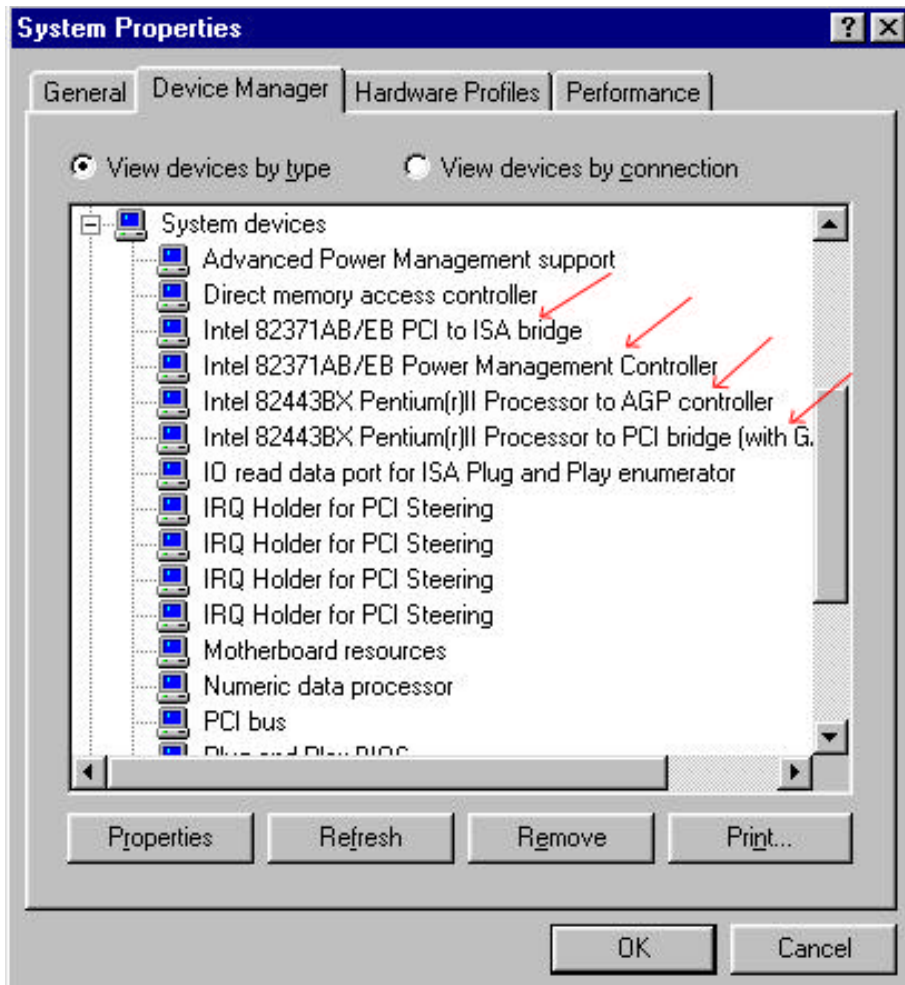



# Appendix F Install HighPoint XStore Pro Utility

---

We provide a useful and powerful utility in our product package, the *HighPoint XStore Pro*. What does XStore do? The XStore Pro is a hard disk enhancement utility which can improve the system performance. The basic concept is using read-ahead caching algorithm to improve the hard disk performance. With a market trend where most systems standard configurations are moving towards 48 MBytes memory size or beyond, the HighPoint XStore Pro provides higher system performance. XStore Pro is a new generation of XStore MMX Accelerator for Storage.

XStore Pro utilizes the bigger system memory size to enhance memory management by working with Windows<sup>®</sup> 95 and 98. XStore Pro optimizes higher system performance by read ahead caching after seeking with large block size of hard disk. And best of all, XStore Pro supports several PCI Bus Master Controllers such as Intel, SiS, Ali, Via and others.

When you install the XStore Pro, you can choose to install the CD Xpress at same time. Why you need the CD Xpress? We'll tell you more about it.

CD-ROM technology is growing fast, but its performance is still unacceptable compared to today's hard drives. The transfer rates of today's hard drives can exceed 18MB/sec with access times below 12ms. However, transfer rates for the fastest CD-ROM drives on the market are below 2MB/sec with access times over 100ms.

CD Xpress was created to accelerate the accessing speed of the CD-ROM drive by utilizing the hard drive's high performance. CD Xpress reads and buffers data from the CD-ROM to an area in the hard drive. With CD Xpress, when you access CD-ROM data, you are actually accessing data from a swap file in the hard drive. This results in a tremendous increase in CD-ROM performance without penalties.

Before you install this utility, there are several things you need to know.

## **Important Note**

1. You can only install one Bus Master Driver at a time in your system, or the drivers will result in conflict and cause system hangs. Please make sure you don't have any Bus Master Driver installed in your system before you install XStore Pro! You must remove all components of the previous Bus Master Driver before you install XStore Pro to your system. For example, you cannot install both Intel<sup>®</sup> bus master driver and HighPoint XStore Pro in your system,

otherwise it will cause system conflict when you install the second bus master driver!

2. This Windows® 95/98 driver does not support CD-ROM Changers. If you have an ATAPI CD-ROM Changer installed in your system, please do not install this driver!
3. We have found that the Windows® 95 OSR2/Windows® 98 version would fail to load the driver on some systems using the Bus Master chipset after you install and restart the system. The following step could solve this problem if it happens:
  - (1) Go to My Computer and double click Control Panel.
  - (2) Double click System then go to Device Manger and View Devices by Type.
  - (3) Go to hard disk controllers.
  - (4) Double click PCI Bus Master IDE Controller (Ultra DMA supported). (There should be a yellow mark besides this item)
  - (5) Click Resources and you should see a box near the bottom of the screen that says "Set Configuration Manually".
  - (6) Click on "Set Configuration Manually" and you will see a check next to "Use automatic setting".
  - (7) Uncheck the box and when the system asks you to reboot click "yes".
  - (8) After the system restarts the yellow mark should be gone

#### 4. De-Installation:

To uninstall XStore Pro from your system, run "Uninstall" from the HighPoint XStore Pro program group. This uninstall utility will: deactivate CD Xpress, if CD Xpress is active, remove the buffer space, and uninstall XStore Pro and CD Xpress from the system. After the uninstallation of XStore Pro, the hard disk will return to its original status. We suggest users to reboot the system after finishing uninstallation.

5. The ATAPI LS-120 device will be recognized as a removable device in retail Windows 95(4.00.95) and OSR1 Windows 95(4.00.95 A) after XStore Pro driver is installed.
6. This driver might lock on certain motherboards. Please check HighPoint Technology first if you encounter problems.

For more detailed information, please check the readme file stored in the *XStore Pro Program Group*. If you want to upgrade to a new version of driver or want to know more about XStore Pro products, please go to the HighPoint Technologies Inc's company WEB site, the URL is <http://www.highpoint-tech.com/>.



This CD-ROM (Or floppy diskette) has the HighPoint XStore Pro drivers. (version 1.2) The following procedure describes how to install the HighPoint XStore to your system. If you have a floppy diskette but not the CD-ROM, just insert the diskette and run the **Setup.exe** file to start installation.

**Step 1:** In Windows® 95/98, place the CD-ROM into the computer. The main menu will show up. Click the **HighPoint XStore Pro Install** button, then you will see the XStore Pro installer is preparing the InstallShield® Wizard. When it is done, the *Welcome* screen will show up.



**Step 2:** Press the “Next” key, you will see the screen below. You then need to choose you want to install XStore Pro only, or you want to install both of XStore Pro and CD Xpress. Then you can press the “Next” key to continue.

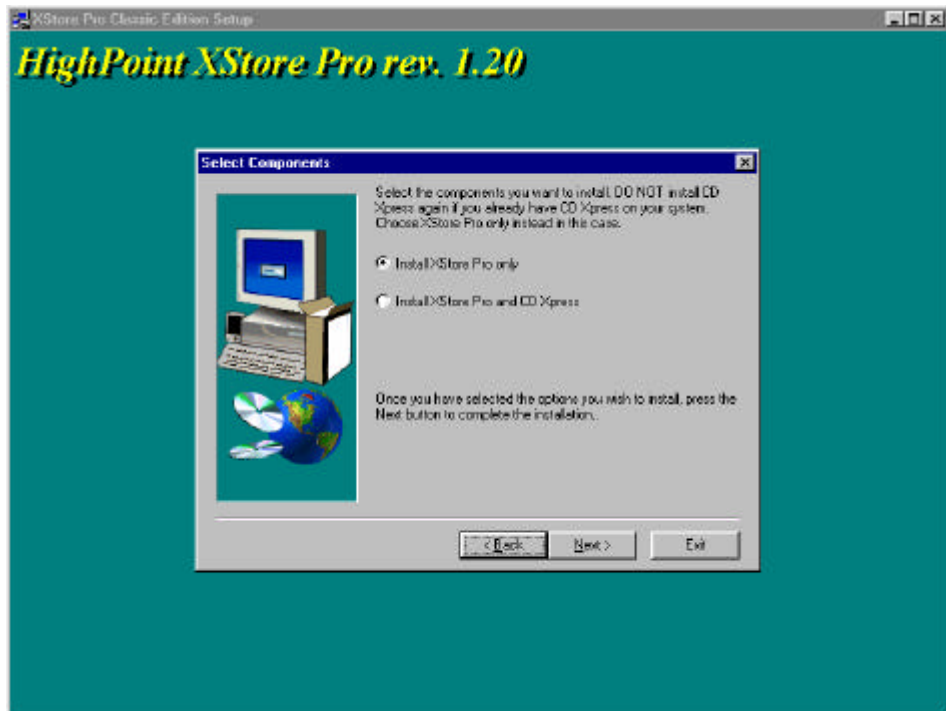

**Step 3:** Press the “Next” key, you will see the license screen.

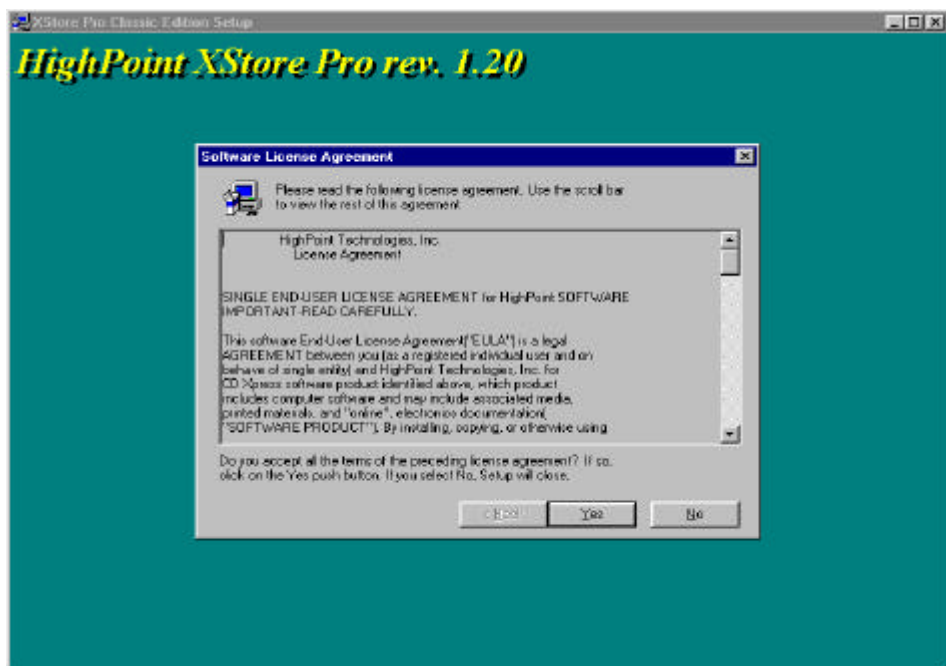

**Step 4:** Press the “Yes” to continue screen below.

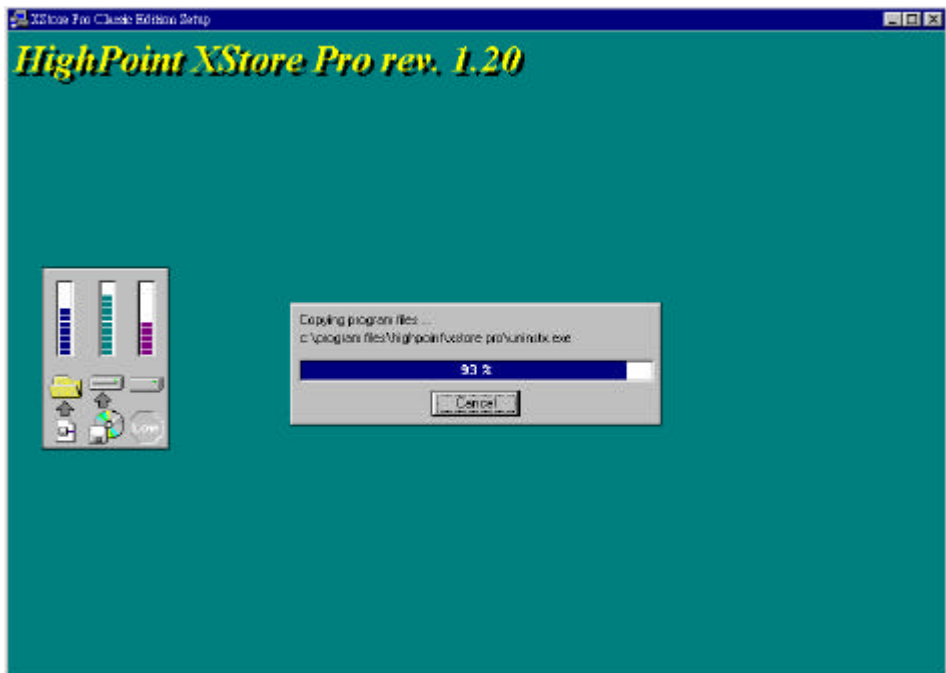

**Step 5:** When install process done, you will see the screen below. This screen will show up only when you select install both XStore Pro and CD Xpress. If you want to see the ReadMe file, you can click on to the circle.

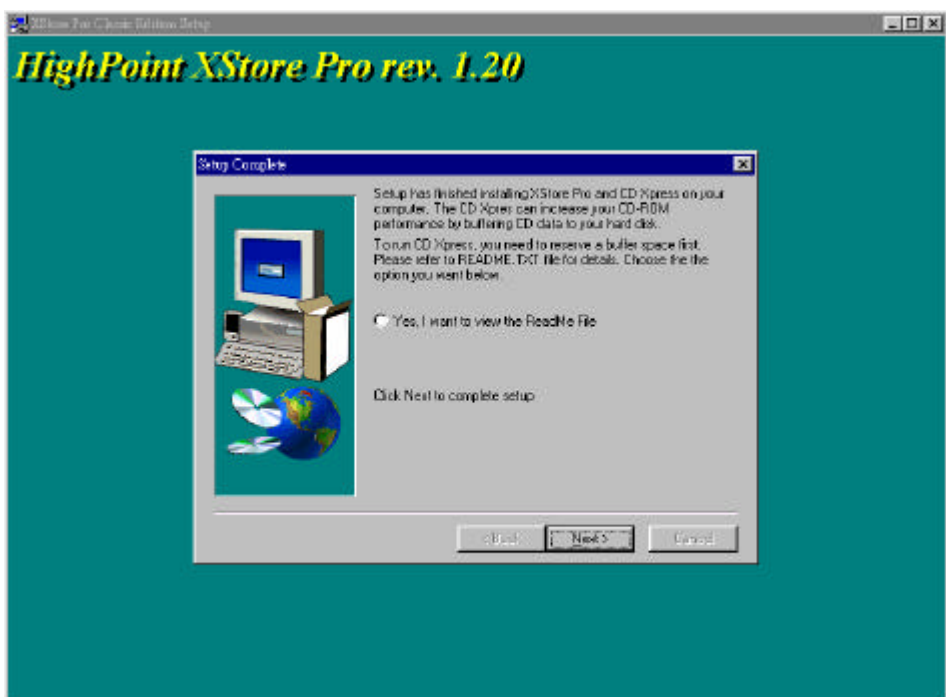

**Step 6:** Choose the “Yes, I want to restart my computer now.” button, then system will restart. Or you can choose the “No, I will restart my computer later.”

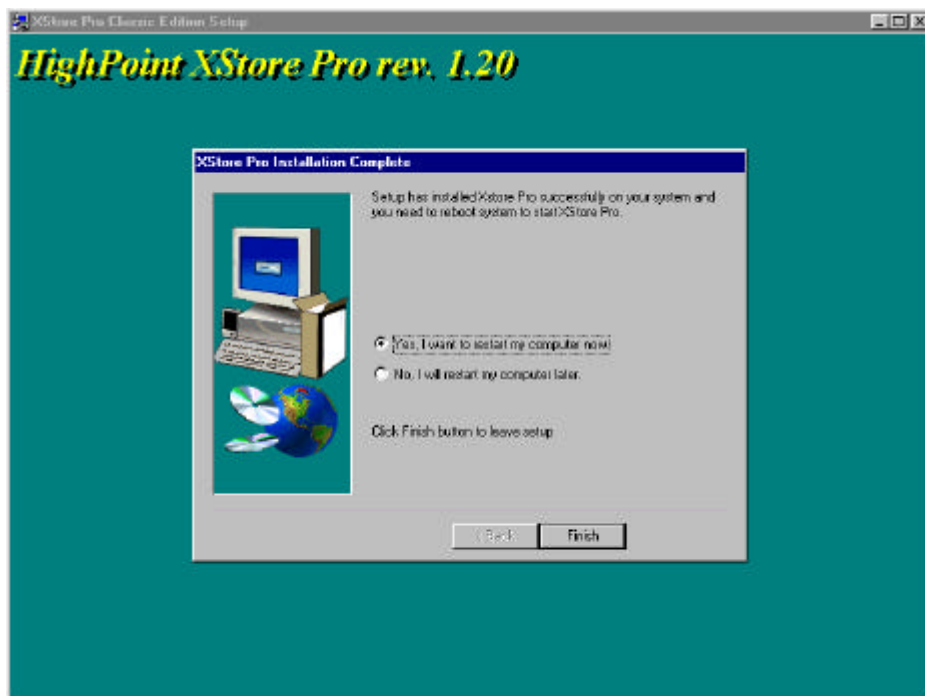

## Appendix G Install Winbond Hardware Doctor Utility

---

Winbond Hardware Doctor is a self-diagnostic system for PCs and must be used with the Winbond chipset: W83781D/W83782D/W83783S IC series products.

It will protect PC hardware by monitoring several critical items including power supply voltages, CPU & system fans speed, and CPU and system temperature. These items are important for the operation of the system, errors may result in permanent damage of the PC. Once any item is out of its normal range, a warning message will pop up and remind the user to take proper measures.

It will protect PC hardware by monitoring several critical items including power supply voltages, CPU & system fans speed, and CPU and system temperature. These items are important for the operation of the system, errors may result in permanent damage of the PC. Once any item is out of its normal range, a warning message will pop up and remind the user to take proper measures.

The following description will tell you how to install the Hardware Doctor (Version 2.2) and use it. This CD-ROM (Or floppy diskette) has the Winbond Hardware Doctor utility. The following procedure describes how to install the Hardware Doctor to your system. If you have a floppy diskette and not the CD-ROM, just insert diskette 1 and execute the **Setup.exe** file to start installation.

**Step 1:** In Windows® 95/98, place the CD-ROM into the computer. The main menu will show up. Click the **Hardware Doctor Install** button, then the *HWDoctor Setup* screen will show up, please refer the to figure below.



**Step 2:** Press the “OK” button, then see the screen below.

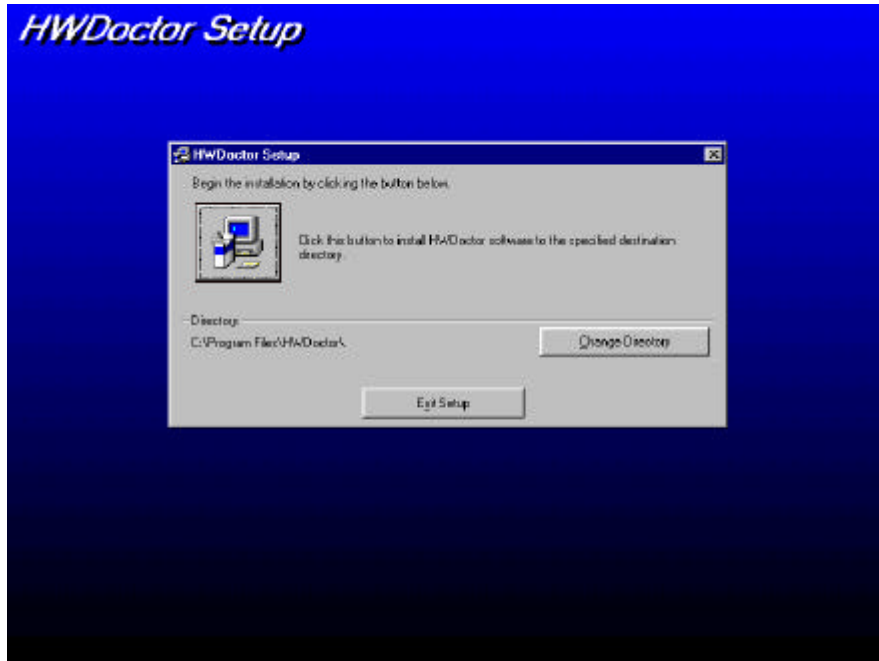

**Step 3:** You can specify the program install path by clicking “Change Directory” button. Or if you want to use the default path, click the icon  to continue the install process. Now the screen will show you the percentage of install progress.

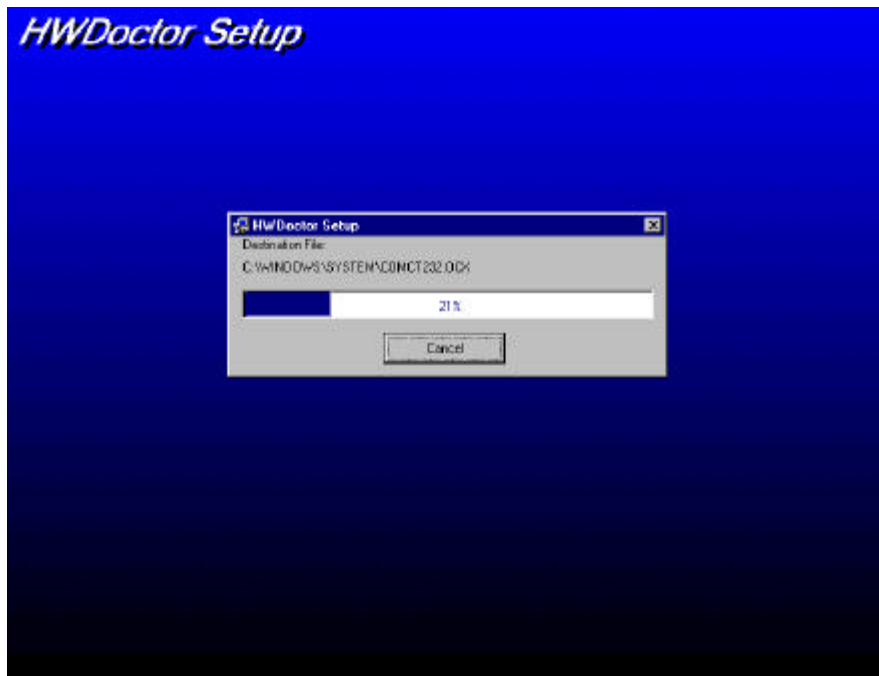

**Step 4:** When the progress finishes, click the “OK” button.



**Step 5:** Go to the Windows toolbar and click the “Start” button, then choose the “program” → “HWDiector” (See the arrow mark on figure below).

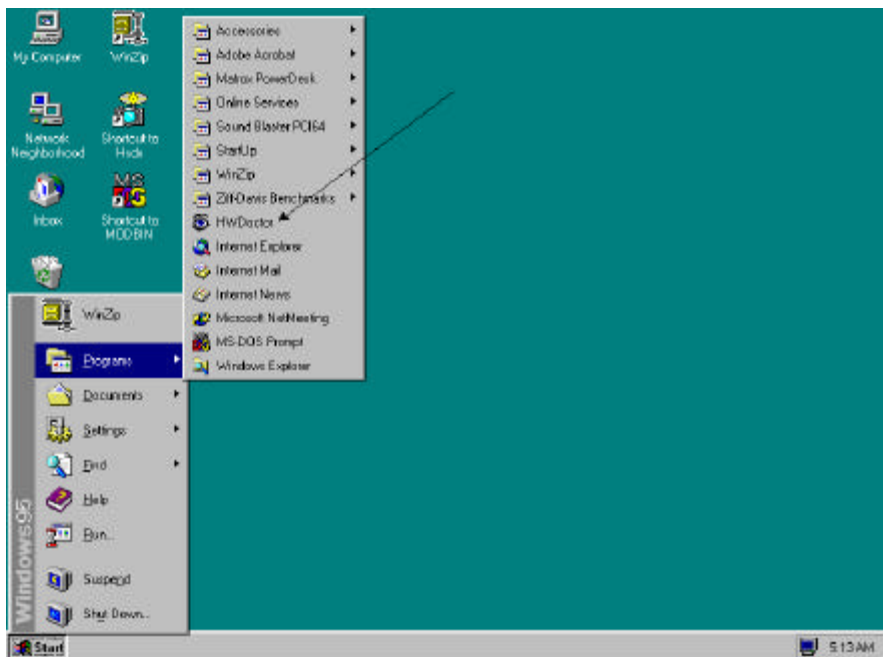

**Step 6:** Then you will see the screen like the figure below. You will see voltages, fans speed and temperature readings as well. If any item reading is critical or less than the limitation, the reading will turn red. Also, it will show the pop-up windows to warn you the system has a problem!

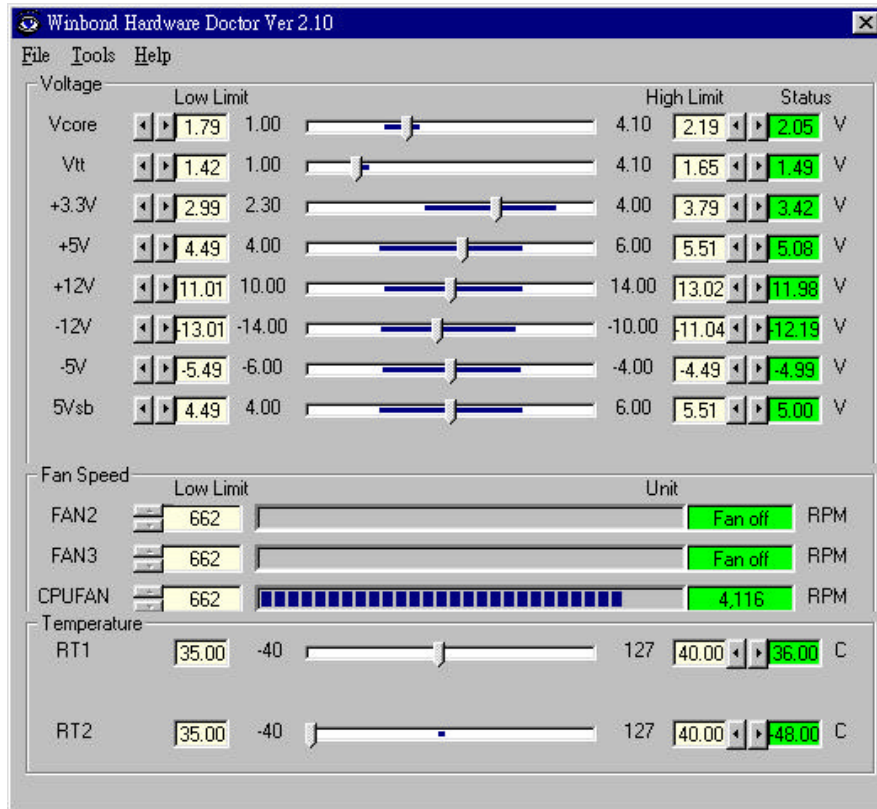



The figure below shows the warning message windows.

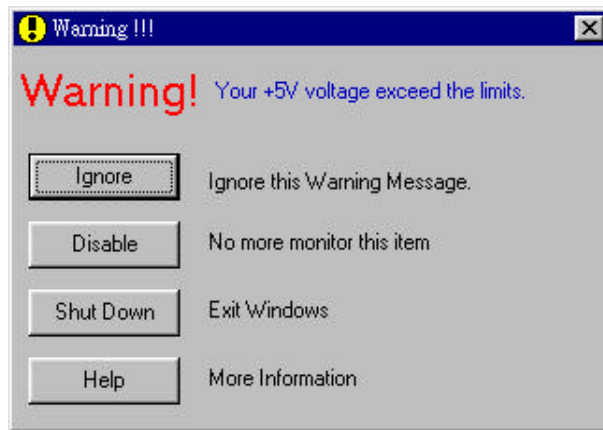

**Ignore:** You can ignore the warning message of the item this time, but it will still pop up when the error of the same item happens again.

**Disable:** The chosen item will be no longer monitored thereafter, unless you activate it in the "configuration" page.

**Shutdown:** Choosing this button will shutdown the computer.

**Help:** You can read more information and self-diagnose simple problems.

If the warning message pops up due to the wrong warning limit, you can adjust it in the "Configuration" option. For example if you set the temperature high limit to 40°C, you are easy to exceed proper temperature.

Please pay attention to two things when you want to make any changes in the "Configuration" option. Firstly, you have to make sure your new setting is in the proper range. Secondly, after you finished the configuration, you have to save it. Otherwise, the program will start with the default value the next time.



## Appendix H Technical Support

---



If you have a problem during operation & In order to help our technical support personnel to quickly find out what is the problem of your motherboard and to give you the answers you need, before filling in the technical support form, eliminate any peripheral that is not related to the problem, and indicate on the form the key peripherals. Fax this form to your dealer or to the company where you bought the hardware in order to benefit from our technical support. (You can refer to the examples given below.)



**Example 1:** With a system including: motherboard (with CPU, DRAM, COAST...) HDD, CD-ROM, FDD, VGA CARD, MPEG CARD, SCSI CARD, SOUND CARD..., after the system is assembled, if you cannot boot up, check the key components of the system using the procedure described below.

First remove all interface cards except the VGA card and try to reboot.

☞ If you still cannot boot up:

Try installing another brand/model VGA card and see if the system will start. If it still does not start, note the VGA card model, motherboard model, Bios identification number, CPU on the technical support form (refer to main instructions), and describe the problem in the problem description space provided.

☞ If you can boot up:

Insert back the interface cards you have removed one by one and try to start the system each time you insert a card, until the system doesn't start anymore. Keep the VGA card and the interface card that causes the problem inserted on the motherboard, remove any other card or peripheral, and start again. If you still cannot start, note down the information related to both cards in the add-on Card space provided, and don't forget to indicate the motherboard model, version, BIOS identification number, CPU (refer to main instructions), and give a description of the problem.



**Example 2:** With a system including the motherboard (with CPU, DRAM, COAST...) HDD, CD-ROM, FDD, VGA CARD, LAN CARD, MPEG CARD, SCSI CARD, SOUND CARD, after assembly and after having installed the Sound Card Driver, when you restart the system, when it runs the Sound Card Driver, it resets automatically. This problem may be due to the Sound Card Driver. During the Starting DOS ...procedure, press SHIFT (BY-PASS) key, to skip CONFIG.SYS and AUTOEXEC.BAT; edit CONFIG.SYS with a text editor, and in function the line that loads the Sound Card Driver, add a remark REM, in order to disable the Sound Card Driver. See the example below.

CONFIG.SYS:

DEVICE=C:\DOS\HIMEM.SYS

DEVICE=C:\DOS\EMM386.EXE HIGHSCAN

DOS=HIGH,UMB

FILES=40

BUFFERS=36

***REM DEVICEHIGH=C:\PLUGPLAY\DWCFGMG.SYS***

LASTDRIVE=Z

Restart the system. If the system starts and does not reset, you can be sure that the problem is due to the Sound Card Driver. Note down the Sound Card model, motherboard model, BIOS identification number on the technical support file (refer to main instructions), and describe the problem in the space provided.



**Main instructions...**

To fill in this “Technical Support Form”, refer to the step-by-step instructions given below:

**1\*. MODEL:** Note the model number given in your user’s manual.

Example: BX6, BH6, etc ...

**2\*. Motherboard model number (REV):** Note the motherboard model number labeled on the motherboard as “REV:\*.\*\*\*”.

Example: REV: 1.01

**3\*.BIOS ID and Part Number :** See below:

Example:

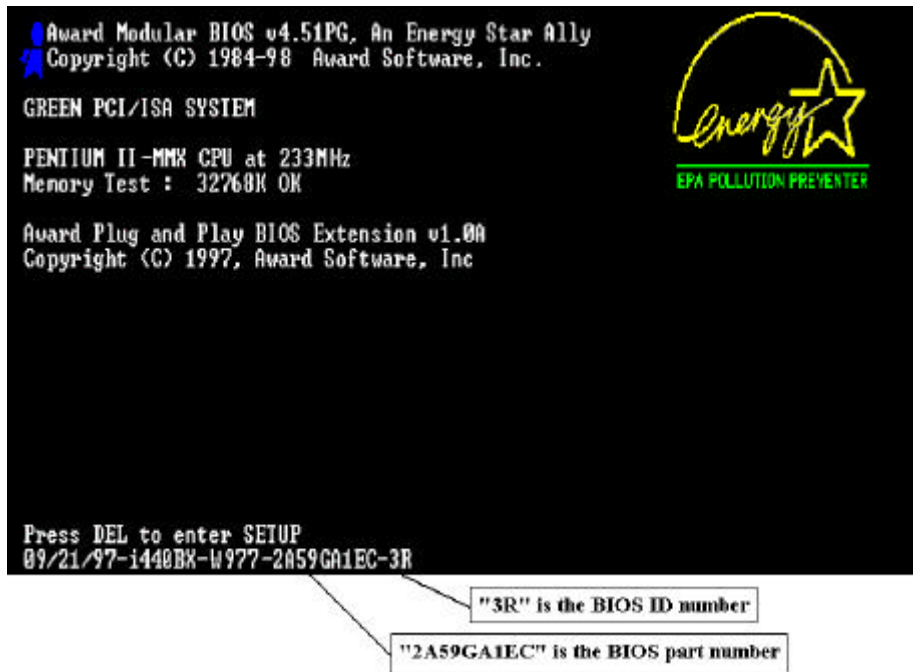

**4. DRIVER REV:** Note the driver version number indicated on the DEVICE DRIVER disk (if have) as “Release \*.\*\*\*”.

Example:

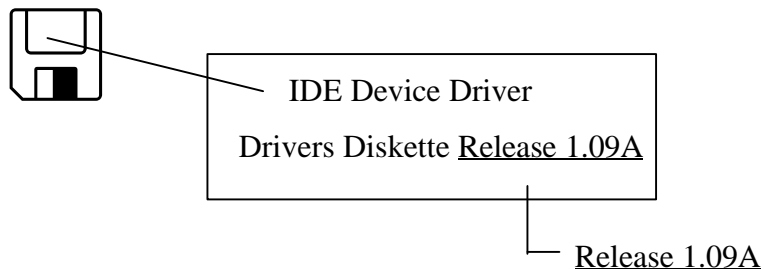

- 5\*. OS/APPLICATION:** Indicate what are the operating system and the applications your are running on the system.  
Example: MS-DOS® 6.22, Windows® 95, Windows® NT....
- 6\*. CPU:** Indicate the brand and the speed (MHz) of your CPU.  
Example:(A) In the “Brand” space, write “Intel”, in the “Specifications” space, write “ Pentium® II MMX 233MHz” C
- 7. HDD:** Indicate the brand and specifications of your HDD(s), specify if the HDD is using  IDE1 or  IDE2. If you know the disk capacity, indicate it and check (“✓”) “”; in case you give no indication, we will consider that your HDD is “IDE1” Master.  
Example: In the “HDD” space, check the box, in the Brand space, write “Seagate”, in the Specifications space, write “ST31621A (1.6GB)”.
- 8. CD-ROM Drive:** Indicate the brand and specifications of your CD-ROM drive, specify if it uses  IDE1 or  IDE2 And check (“✓”) “”; in case you give no indication, we will consider that your CD-ROM is “IDE2” Master.  
Example: In the “CD-ROM drive” space, check the box, in the Brand space, write “Mitsumi”, in the Specifications space, write “FX-400D”.
- 9. System Memory (DRAM):** Indicate the brand and specifications (SIMM / DIMM) of your system memory.  
Examples:  
In the Brand space, write “Panasonic”, in the Specifications space, write “SIMM-FP DRAM 4MB-06”.  
Or, in the Brand, write “NPNX”, in the Specifications space, write “SIMM-EDO DRAM 8MB-06”.  
Or, in the Brand space, write “SEC”, in the Specifications space, write “DIMM-S DRAM 8MB-G12”.
- 10. ADD-ON CARD:** Indicate which add-on cards you are “absolutely sure” are related to the problem.  
If you cannot identify the problem origin, indicate all the add-on cards inserted into your system.

<p><b>Note:</b> Items between the “*” are absolutely necessary.</p>
---



**Technical Support Form**

Company name:

Phone #:

Contact:

Fax #:

Model	*	BIOS ID #	*
Motherboard model no.		DRIVER REV	
OS/Application	*		
Hardware name	Brand	Specifications	
C.P.U	*		
HDD <input type="checkbox"/> IDE1 <input type="checkbox"/> IDE2			
CD-ROM Drive <input type="checkbox"/> IDE1 <input type="checkbox"/> IDE2			
System Memory (DRAM)			
ADD-ON CARD			

Problem Description: \_\_\_\_\_  
\_\_\_\_\_  
\_\_\_\_\_

