



## Electronic Emission Notices

### Federal Communications Commission (FCC) Statement

This equipment has been tested and found to comply with the limits for a Class B digital device, pursuant to Part 15 of FCC Rules. These limits are designed to provide reasonable protection against harmful interference in a residential installation. This equipment generates, uses and can radiate radio frequency energy and, if not installed and used in accordance with instructions contained in this manual, may cause harmful interference to radio and television communications. However, there is no guarantee that interference will not occur in a particular installation.

If this equipment does cause harmful interference to radio or television reception, which can be determined by turning the equipment off and on, the user is encouraged to try to correct the interference by one or more of the following measures:

- REORIENT OR RELOCATE THE RECEIVING ANTENNA
- INCREASE THE SEPARATION BETWEEN THE EQUIPMENT AND THE RECEIVER
- CONNECT THE EQUIPMENT INTO AN OUTLET ON A CIRCUIT DIFFERENT FROM THAT OF THE RECEIVER
- CONSULT THE DEALER OR AN EXPERIENCED AUDIO/TELEVISION TECHNICIAN

**NOTE:** Connecting this device to peripheral devices that do not comply with Class B requirements, or using an unshielded peripheral data cable, could also result in harmful interference to radio or television reception.

The user is cautioned that any changes or modifications not expressly approved by the party responsible for compliance could void the user's authority to operate this equipment.

To ensure that the use of this product does not contribute to interference, it is necessary to use shielded I/O cables.

### Copyright

This manual is copyrighted with all rights reserved. No portion of this manual may be copied or reproduced by any means.

While every precaution has been taken in the preparation of this manual, no responsibility for errors or omissions is assumed. Neither is any liability assumed for damages resulting from the use of the information contained herein.

### Trademarks

All brand names, logos and registered trademarks mentioned are property of their respective owners.

---

## Table of Contents

HARDWARE CONFIGURATION .....	4
Key Features .....	4
MOTHERBOARD LAYOUT .....	6
REARPANEL .....	7
AUDIO CONFIGURATION .....	9
SPEAKER CONFIGURATION .....	9
Method 1: 4/6 Surround audio output of back panel only .....	9
Method 2: Using S-Bracket connectors .....	11
JACK-SENSING INSTRUCTION .....	14
JUMPER SETTING .....	17
JBAT1 - CMOS Clear .....	17
JP1-Keyboard/Mouse/Rear USB2.0 Connectors	
Power Select Jumper .....	17
CONNECTORS .....	18
Floppy Disk Drive Connector:CN3 .....	18
Hard Disk Connectors:CN1/CN2 .....	18
Serial ATA Hard Disk Connectors:SATA-1&SATA-2 .....	19
USB Connectors :USB1/USB2/USB3 .....	21
Fan Power Connectors:CPU FAN/SYS FAN/WOL .....	22
CD-IN Connector:CDS1 .....	23
Front Panel Audio Header:FPS1 .....	24
S-Bracket (SPDIF)/LEN/LFE/Surround Output Connector:	
CN5(optional).....	25
Front Panel Header:FP1 .....	27
SLOTS .....	28
CPU INSTALLATION .....	29

---

HARDWARE SETUP .....	31
To Install DDR DIMMs .....	31
BIOS SETUP .....	32
Starting Setup .....	32
Main Menu .....	33
Standard CMOS Features .....	34
Advanced BIOS Features .....	35
Advanced Chipset Features .....	35
Integrated Peripherals .....	35
Power Management Setup .....	35
PNP/PCI Configurations .....	35
PC Health Status .....	35
Frequency/Voltage Control .....	36
Set Supervisor/User Password .....	36
Flash Update Procedure .....	37
VT8237 SATA RAID USER MANUAL.....	38
Enter BIOS Configuration Utility .....	38
Create Disk Array .....	39
Delete Disk Array .....	41
Select Boot Array .....	41
Duplicate Critical RAID 1 Array .....	42
Rebuild Broken RAID 1 Array .....	43
DRIVER AND RAID SOFTWARE INSTALLATION.....	45
Microsoft Windows Driver Installation .....	45
INSTALL OPERATING SYSTEM INTO SATA HDD OF VT8237 .....	47
Install Windows 98SE or Me .....	47
Install Windows NT4.0,2000,XP .....	47
APPENDIX.....	48

---

## HARDWARE CONFIGURATION

### Key Features :

#### Chipset

- VIA PT800/P4X533+VT8237/VT8235 chipset.

#### Processor

- Supports the Intel® Celeron® , Pentium® 4 processors in the 478-pin package.
- Supports 64-bit PSB (Processor System Bus) frequency of 400MHz (100MHz bus clock), 533MHz (133MHz bus clock)
- Supports 64-bit PSB frequency of 800MHz (200MHz bus clock) (Overclock up to 800MHz PSB for P4X533 Chipset).

#### System Memory

- A total of two 184-pin DDR SDRAM sockets.
- Support up to 2GB DRAMs for unbuffered DDR SDRAM module.
- Support DDR400/333/266 DDR SDRAM (Overclock up to DDR400 for P4X533 Chipset).

#### System BIOS

- PnP, APM, ATAPI and Windows® 98/2000/XP.
- Full support of ACPI & DMI.
- Auto detects and supports LBA harddisks with capacities over 160GB.
- Easy to upgrade BIOS by end-user.

#### On-board I/O

- On board two PCI fast IDE ports supporting up to 4 ATA, ATA2 , Ultra ATA33/66/100/133 IDE HDDs, CD-ROMs, ZIP drives and LS-120 drives as boot drive.
- One ECP/EPP parallel port.
- Two 16550 Compatible UART serial ports.
- One floppy port supports two FDD of 360KB, 720KB, 1.2MB , 1.44MB and 2.88MB capacity.
- Six USB2.0 ports (for VT8235 Chipset).
- Eight USB2.0 ports (for VT8237 Chipset).
- PS/2 keyboard connector.
- PS/2 mouse is supported.
- One Front Panel Sound Connector.
- Infrared (IrDA) is supported via a header.

#### Expanded USB Support

- Eight external ports for VT8237, six for VT8235 chipset.
- Supports USB2.0, bandwidth shared between all external ports.

## Plug-and-Play

- Supports Plug and Play specification 1.1.
- Plug and Play for Windows® 98, Windows® 2000 as well as Windows® XP.
- Fully steerable PCI interrupts.

## On-board AC97 Sound

- Integrated AC97 controller with standard AC97 Codec.
- Direct Sound and Sound Blaster compatible.
- Full-Duplex 16-bit record and play back.
- PnP and APM 1.2 support.
- Windows® 98/2000/XP drivers ready.
- Line-in, Line-out, Mic-in and MIDI/Game port.
- Supports ALC650/ALC655 AC97 Code for six sound channel output (optional).

## Integrated serial ATA Controller (optional)

- Independent DMA operation on two ports.
- Data transfer rate 150MB/s.

## On-board VT6103 LAN (optional)

- High performance PCI master interface with scatter / gather and bursting capability.
- Standard MII interface to external PHYceiver.
- 10/100MHz full and half duplex operation.

## Power Management

- Supports SMM, APM and ACPI.
- Break switch for instant suspend/resume on system operations.
- Energy star "Green PC" compliant.
- Hardware monitoring circuit is supported, provide voltage, temperature, fan speed, etc. monitoring (optional).
- WOL (Wake-On-Lan) header support.
- Support suspend-to-RAM(STR)(optional).

## Expansion Slots

- 1 AGP slot (support AGP 4X/8X).
- 5 PCI bus master slots - ver. 2.1 compliant.



Static electricity can harm delicate components of the motherboard. To prevent damage caused by static electricity, discharge the static electricity from your body before you touch any of the computers electronic components.

# Motherboard Layout

The following diagrams show the relative positions of the jumpers, connectors, major components and memory banks on the motherboard.

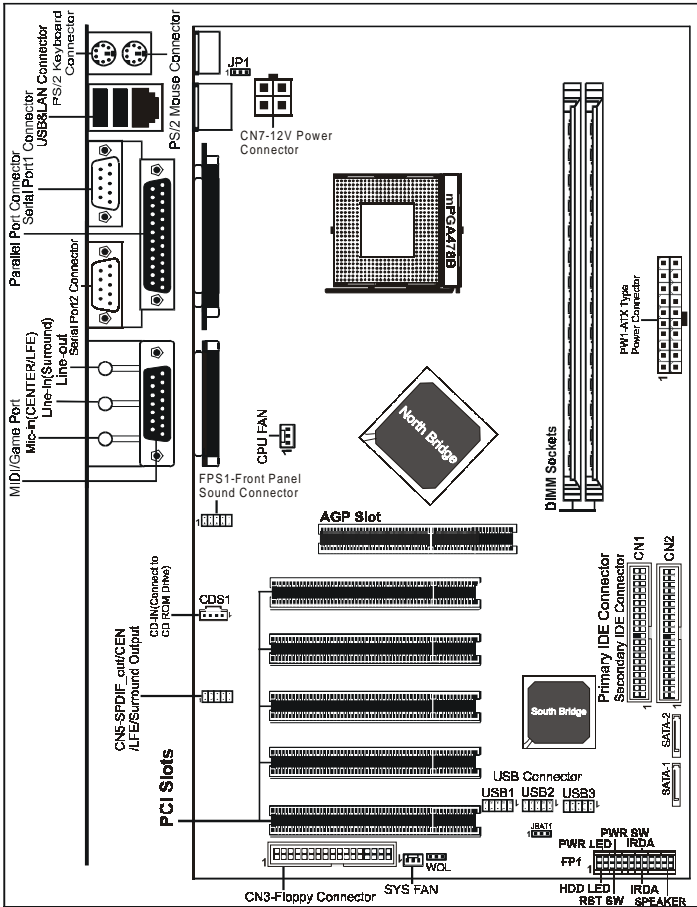

# The LAN and CN5 Connectors are optional.

# The ALC650/ALC655 embeds an internal analog switch (by driver software) to share LINE input with Surround output, and share MIC input with CENTER /LFE output.

**NOTE**

- 1) Be sure to check the cable orientation in order to match the colored strip to the pin 1 end of the connector.
- 2) Be sure to connect PW1 and CN7 to power supply correctly, otherwise, the motherboard can't work normally.
- 3) When you start up the system, please wait for 5 seconds after you power on AC.
- 4) It is not recommended to add a metal spacer plate on the back of the Socket478. Otherwise, some components will be short and damaged.

## Rear Panel

The back panel provides the following connectors:

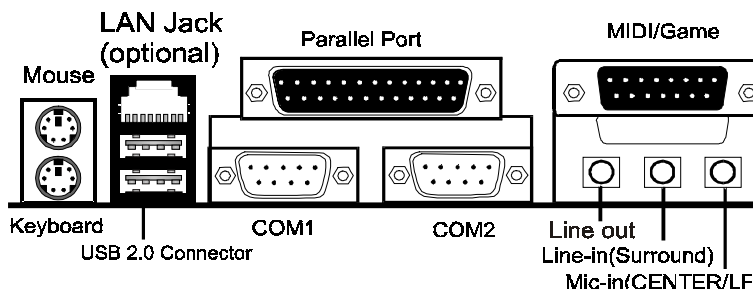

### Mouse Connector

The mainboard provides a standard PS/2<sup>®</sup> mouse mini DIN connector for attaching a PS/2<sup>®</sup> mouse. You can plug a PS/2<sup>®</sup> mouse directly into this connector.

### Keyboard Connector

The mainboard provides a standard PS/2<sup>®</sup> keyboard mini DIN connector for attaching a PS/2<sup>®</sup> keyboard. You can plug a PS/2<sup>®</sup> keyboard directly into this connector.

### USB 2.0 Connector

The mainboard provides a UHCI (Universal Host Controller Interface) Universal Serial Bus root for attaching USB devices such as keyboard, mouse or other USB-compatible devices. You can plug the USB device directly into the connector.

#### USB 2.0 Connector

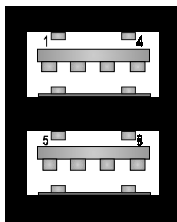

#### USB 2.0 Connector Description

PIN	SIGNAL	DESCRIPTION
1	VCC	+5V/5VSB (optional)
2	-Data 0	Negative Data Channel 0
3	+Data0	Positive Data Channel 0
4	GND	Ground
5	VCC	+5V/5VSB (optional)
6	-Data 1	Negative Data Channel 1
7	+Data 1	Positive Data Channel 1
8	GND	Ground

### Serial Port Connector: COM1&COM2

The Ports are 16550A high speed communication ports that send/receive 16bytes FIFOs. You can attach a serial mouse or other serial devices directly to the connectors.

### LAN Jack (Optional)

The mainboard provides one standard RJ-45 jack for connection to Local Area Network(LAN).You can connect a network cable to the LAN jack.

### Parallel Port Connector:LPT

The mainboard provides a 25-pin female centronic connector as LPT. A parallel port is a standard printer port that supports Enhanced Parallel Port (EPP) and Extended Capabilities Parallel Port (ECP) mode.

### MIDI/Game Connector

The mainboard provides the game port to connect a joystick or a MIDI device.

### Audio Port Connector

**Line\_Out** is a connector for Speakers or Headphones. **Line In** is used for external CD player, Tape player, or other audio devices. **Mic In** is a connector for microphones. The ALC650/655 embeds an internal analog switch (by driver software) to share LINE input with Surround output, and share MIC input with CENTER/LFE output.

The ALC655 embeds the jack sensing function.When you plug an audio device into the corresponding connector, the system will show you what you plugged into the motherboard.



## Audio Configuration

ALC650/655 support 6 channel output, after installing the audio driver, you can select 4/6 channel surround audio output in software utility and then connect surround speakers to appropriate audio ports.

There are two ways to obtain 4/6 channel surround audio output:

1. 4/6 surround audio output of back panel only. All surround speaker connect to audio connector.
2. S-Bracket (optional cable). You have installed S-Bracket into the computer, and then connect two front speakers to back panel's "Line-out" port, and the rest of speakers to S-Bracket. Detail connection is refer to Page 26.

## Speaker Configuration

### Method 1: 4/6 Surround audio output of back panel only.

After installing the audio drivers, you can attach the speakers for 2-/4-/6-channel audio output. Always connect the speakers to the LINE OUT connectors. Different connector configurations for 2-/4-/6-channel operations are listed below:

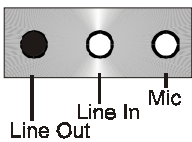

#### 2-Channel

In 2-channel configuration, Line Out, Line In and MIC functions all exist.

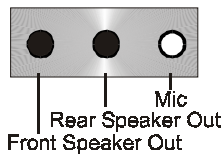

#### 4-Channel

When set to 4-channel configuration, Line In is replaced by Rear Speaker Out. Line in function does not exist.

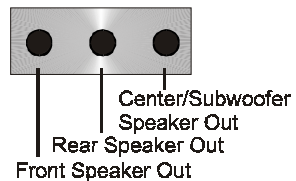

#### 6-Channel

When set to 6-channel configuration, Line In is replaced by Rear Speaker Out. Mic is replaced by Center/Subwoofer Speaker Out. Line in and Mic do not exist function.

In utility, double click “AC97 Audio configuration” icon  from the window tray on the right bottom.

Then the “AC97 Audio Configuration” will appear. Click on the **Speaker Configuration** tab to select the audio mode.

A. When you choose 4-channel mode for 4 speaker output, the selected item is showed as below (Figure1)

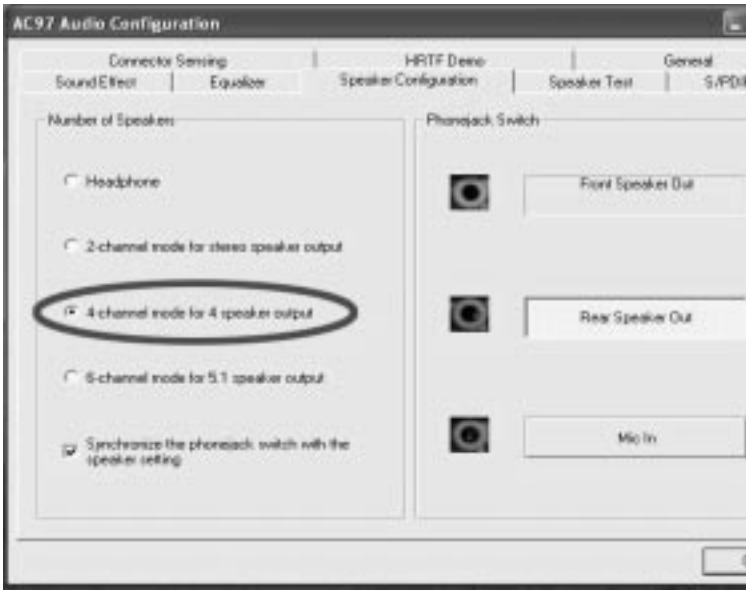

(Figure1)

B. When you choose 6-channel mode for 5.1 speaker output, the selected item is showed as below (Figure2)

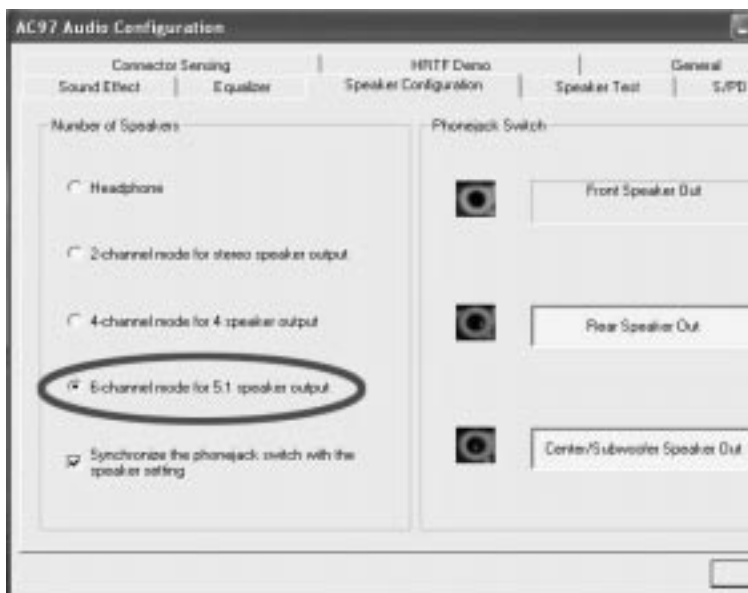

(Figure2)

### Method 2: Using S-BRACKET connectors:

S-Bracket (The S-Bracket is showed in page 26) is an optional accessory. It gives access to analog and digital audio output by integrating both SPDIF and analog LINE OUT connectors. To use the S-Bracket, you should select correct setting in the software utility. For information about the setting, refer to selecting 4- or 6- Channel Setting later in the section.

Connector configurations for 4- and 6- channel using S-Bracket are described below:

## 4-Channel Analog Audio Output

### Back Panel

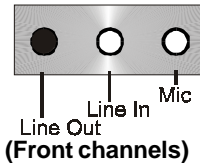

### S-Bracket

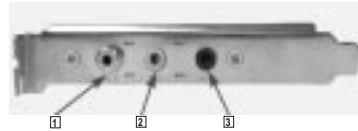

- 1 SPDIF jack (coaxial)
- 2 Rear Speaker Out
- 3 No function

*Description:*

Connect two speakers to back panel's Line Out connector and two speakers to one Line Out connector of S-Bracket. If you want to use **Line In** function, please click the **Rear Speaker Out** button (showed as below)

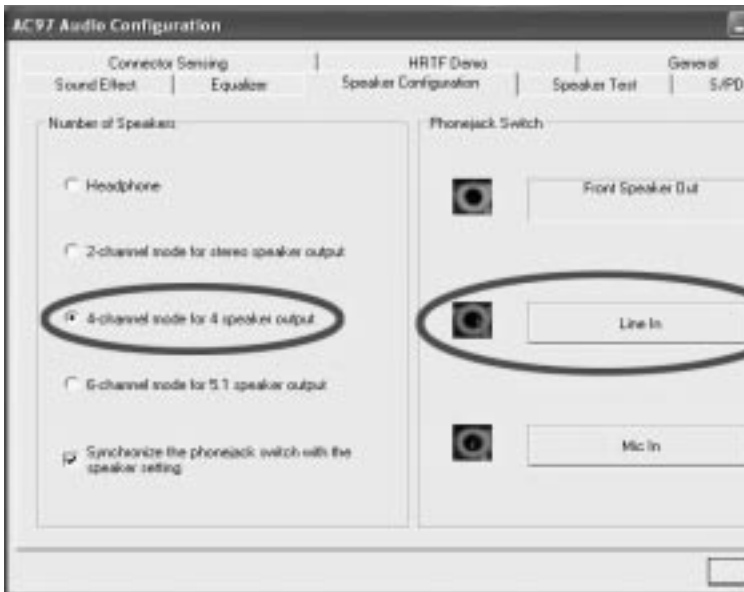

## 6-Channel Analog Audio Output

### Back Panel

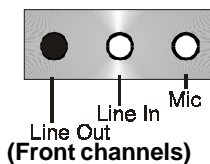

### S-Bracket

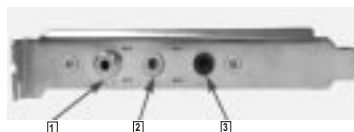

- 1 SPDIF jack (coaxial)
- 2 Rear Speaker Out
- 3 Center and Subwoofer Out

#### *Description:*

Connect two speakers to back panel's Line Out connector and four speakers to both Line Out connectors of S-Bracket. If you want to use **Line In** and **MIC** function at the same time, please click the **Rear Speaker Out** and **Center/Subwoofer Speaker Out** buttons. (shown as below)

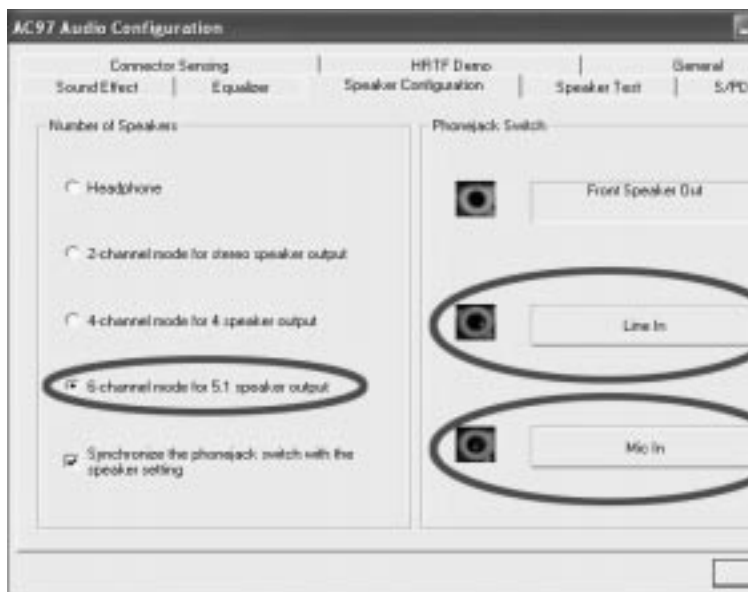

## Jack-Sensing Instruction

ALC655 has a Jack-Sensing function, it provides audio connectors error-detection function.



Install Microsoft DirectX8.1 before to enable Jack-Sensing support for Windows 98/98SE/2000/ME.

Jack-Sensing includes 2 parts:AUTO and MANUAL. Following is an example for 2 channels (Windows XP):

### Introduction of audio connectors

You may connect CDROM, Walkman or others audio input devices to Line In jack. speakers, earphone or others output devices to Line Out jack. and microphone to MIC In jack.



## Auto-detecting:

Please connect the devices to the right jacks as above. A window will appear as below picture if you setup the devices properly.



If you set wrong with the connectors, the warning message will come out as following picture.

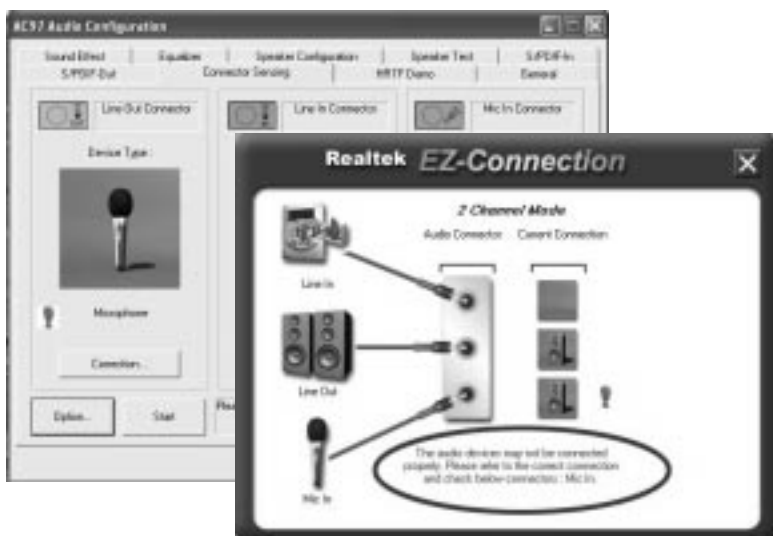

**Manual setting:**

If the device picture shows different from what you set, please press “Correction...” to set.

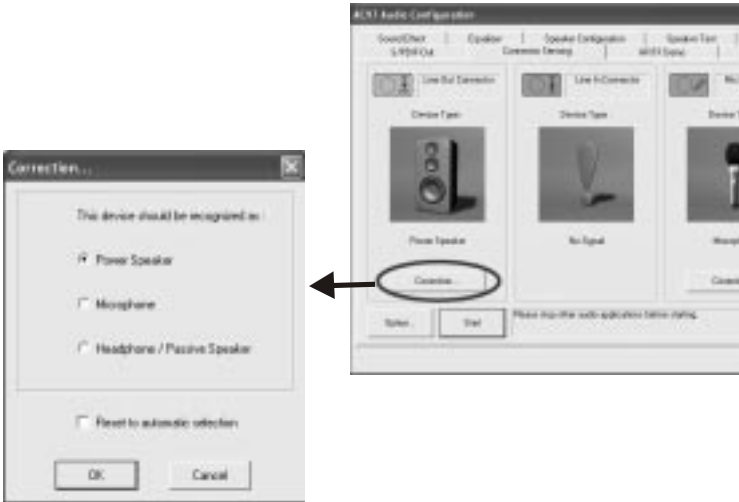



## Jumper Settings

This chapter explains how to configure the motherboard's hardware. Before using your computer, make sure all jumpers and DRAM modules are set correctly. Refer to this chapter whenever in doubt.

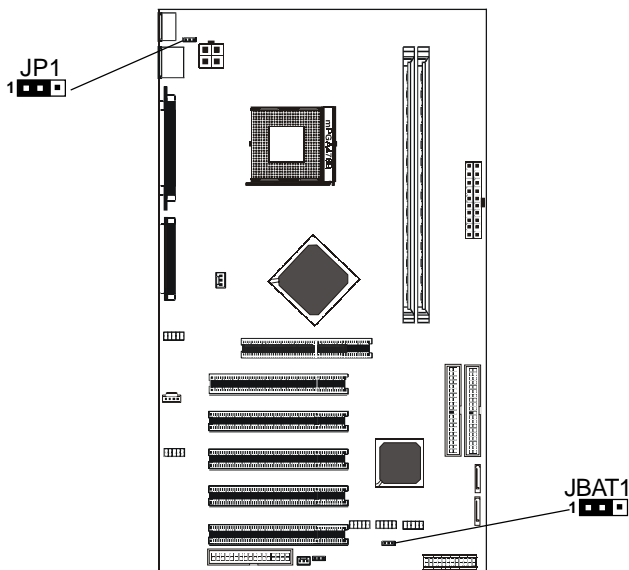

### JBAT1 - CMOS Clear

JBAT1	Selection
1-2*	Normal*
2-3	CMOS Clear

### JP1-Keyboard/Mouse/Rear USB2.0 Connectors Power Select Jumper

JP1	Select
1-2*	Powered by +5V*
2-3	Powered by +5V Standby

#### Note:

*If you want to use PS/2 mouse, Keyboard, devices plugged in rear USB2.0 connectors to power on computer or wake up from STR, you must set jumper JP1 to pin 2-3.*



Close



Open

\* = Default setting.

---

## Connectors

The mainboard provides connectors to connect to FDD, IDE HDD, Serial ATA Hard Disk, USB devices, CPU/SYS FAN/WOL, etc.

### Floppy Disk Drive Connector: CN3

The mainboard provides a standard floppy disk drive connector that supports 360K, 720K, 1.2M, 1.44M and 2.88M floppy disk types.

### Hard Disk Connectors: CN1 / CN2

The mainboard has a 32-bit Enhanced PCI IDE and Ultra DMA 33/66/100/133 controller that provides PIO mode 0~4, Bus Master, and Ultra DMA 33/66/100/133 function. You can connect up to four hard disk drives, CD-ROM, 120MB Floppy (reserved for future BIOS) and other devices.

#### CN1 (Primary IDE Connector)

The first hard drive should always be connected to CN1. CN1 can connect a Master and a Slave drive. You must configure second hard drive to Slave mode by setting the jumper accordingly.

#### CN2 (Secondary IDE Connector)

CN2 can also connect a Master and a Slave drive.

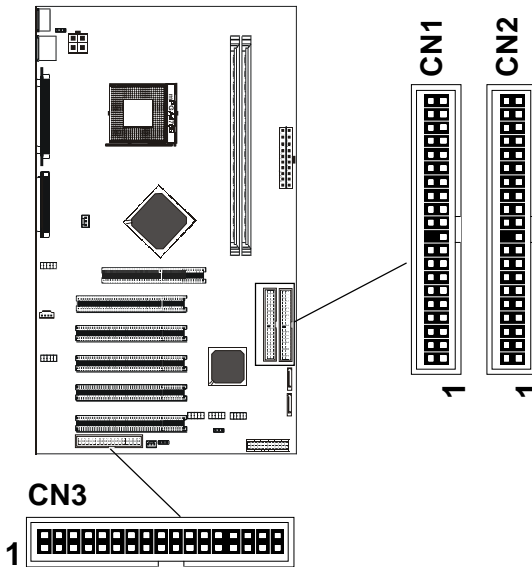

## Serial ATA Hard Disk Connectors: SATA-1/SATA-2 (optional)

The mainboard has 2 SATA connectors. The mainboard provides dual high-speed Serial ATA interface ports, SATA-1, SATA-2. Each supports 1<sup>st</sup> generation serial ATA data rates of 150 MB/s. Both connectors are fully compliant with Serial ATA 1.0 specifications. Each Serial ATA connector can connect to 1 hard disk device. Please refer to Serial ATA Raid manual for detail software installation procedure.

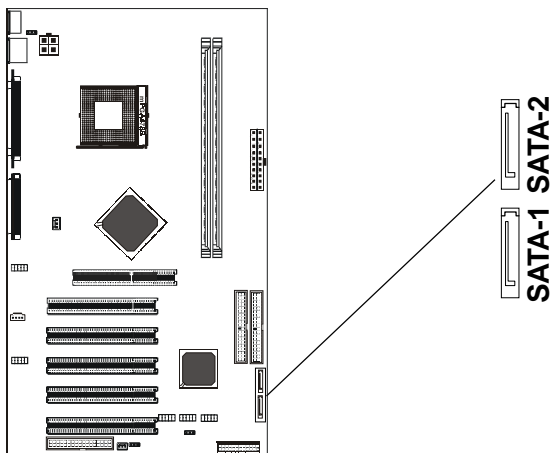

SATA-1&SATA-2

PIN	SIGNAL
1	GND
2	TXP
3	TXN
4	GND
5	RXN
6	RXP
7	GND

## Serial ATA Cable



Connect one end of the SATA cable to the mainboard, and connect another end to the SATA Hard Disk.



Please do not fold the serial ATA cable in a 90-degree angle, which will cause the loss of data during the transmission.

## Serial ATA Hard Disk Devices Power Cable(optional)



## USB Connectors: USB1/USB2/USB3 (USB3 is optional)

This mainboard has USB ports. Some computer cases have a special module that mounts USB ports at the front of the case. If you have this kind of case, use auxiliary USB connector USB1/USB2/USB3 to connect the front mounted ports to the mainboard.

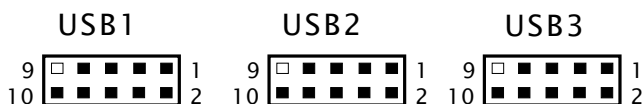
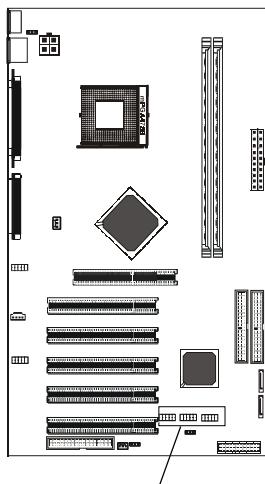

### USB Connector

PIN	Assignment
1	VCC
2	VCC
3	USBP0-
4	USBP1-
5	USBP0+
6	USBP1+
7	GND
8	GND
9	KEY
10	OC#

## Fan Power Connectors: CPU FAN/SYS FAN

The CPU FAN (processor fan), SYS FAN (power fan) support system cooling fan with +12V. It supports three-pin head connector. When connecting the wire to the connectors, always take note that the red wire is the positive and should be connected to the +12V, the black wire is Ground and should be connected to GND. If the mainboard has a System Hardware Monitor chipset on-board, you must use a specially designed fan with speed sensor to take advantage of the CPU fan control.

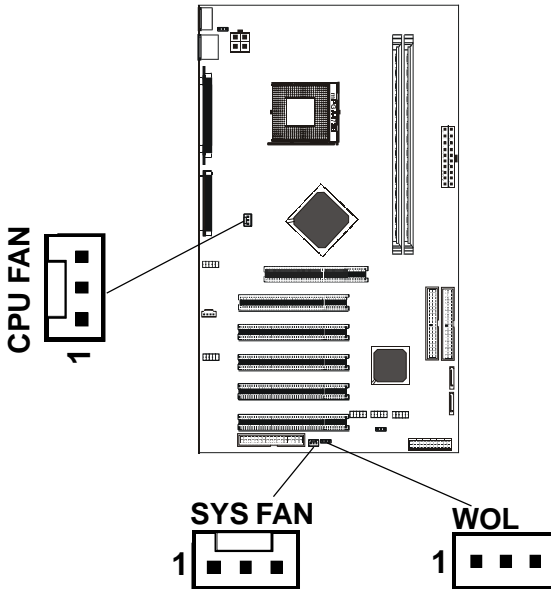

## WOL: Wake On LAN

If you have installed a LAN card, use the cable provided with the card to plug into the mainboard WOL connector. This enables the Wake On LAN (WOL) feature. When your system is in a power-saving mode, any LAN signal automatically resumes the system. You must enable this item using the Power Management page of the Setup Utility.

## CD-IN Connector:CDS1

The connector is for CD-ROM Drive.

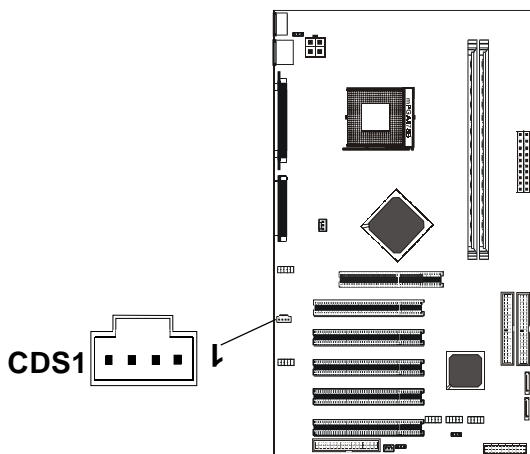

CDS1

PIN	Assignment
1	CD-L
2	GND
3	GND
4	CD-R

## Front Panel Audio Header: FPS1

This mainboard supports front panel microphone and speaker out ports. If your computer case has these ports, connect them to FPS1.

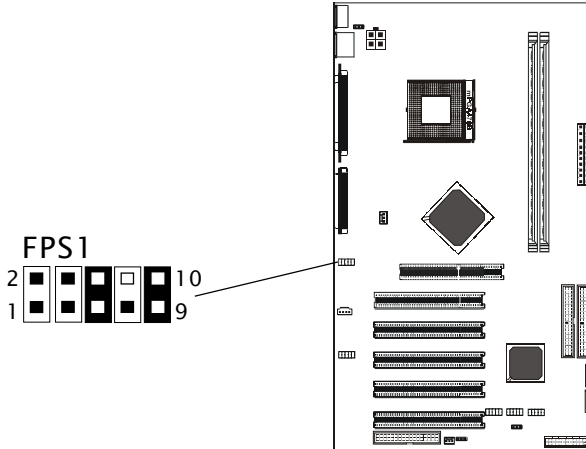

### FPS1

PIN	Assignment
1	MIC
2	GND
3	REF
4	POWER
5	Front Audio(R)
6	Rear Audio(R)
7	Reserved
8	Key(No pin)
9	Front Audio(L)
10	Rear Audio(L)

**Note:**

*If you want to use "Front Audio" connector, you must remove 5-6,9-10 jumper. In order to utilize the front audio header, your chassis must have front audio connector. Also please make sure the pin assignment on the cable is the same as the pin assignment on the MB header. To find out if the chassis you are buying support front audio connector, please contract your dealer.*



## S-Bracket(SPDIF)/CEN/LFE/Surround Output Connector: CN5 (optional)

The connector allows you to connect a S-Bracket for a Digital Interface (SPDIF). The S-Bracket offers 1 SPDIF jacks for digital audio transmission and 2 analog Line-Out jacks for other 4-channel audio output. So you can use Line in, Mic in and 6 channel audio output features at the same time.

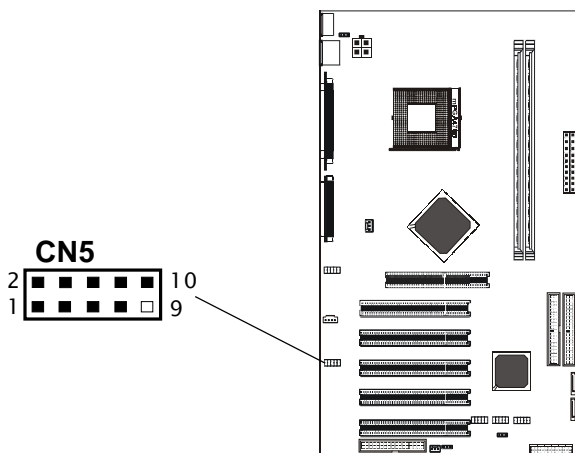

## CN5-S-Bracket

PIN	SIGNAL	DESCRIPTION
1	SOUT-L	Audio left surrounding output
2	SOUT-R	Audio right surrounding output
3	GND	Ground
4	GND	Ground
5	CET-OUT	Audio center output
6	LFE-OUT	Audio bass output
7	GND	Ground
8	SPDIF	S/PDIF input
9	(No Pin)	Key
10	SPDFO	S/PDIF output

### S-Bracket Cable (optional)

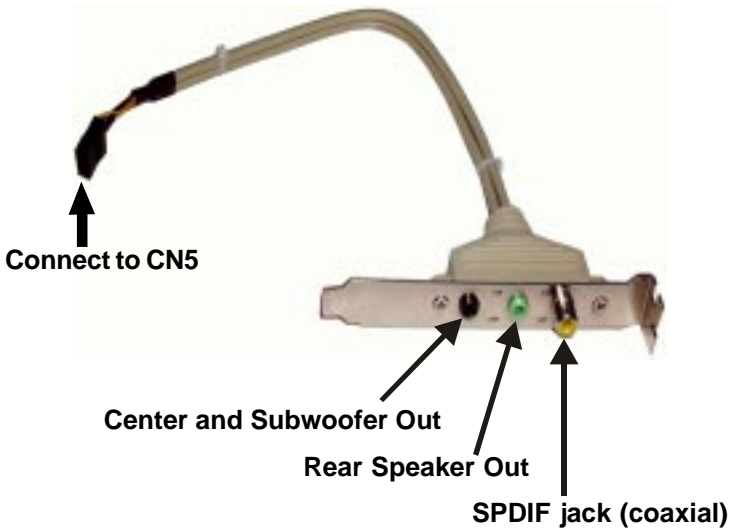

## Front Panel Header: FP1

The mainboard provides one front panel connector for electrical connection to the front panel switches and LEDs.

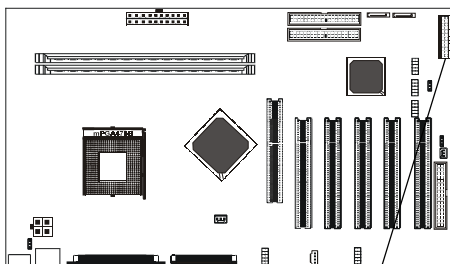

FP1

24	■	23	VCC
GND	■	21	GND
NC	■	19	NC
KEY	□	17	SPEAKER
KEY	□	15	IRTX
IRRX	■	13	VCC
GND	■	11	NC
KEY	□	9	NC
KEY	□	7	RESET
GND	■	5	GND
PWR_SW	■	3	HDD_LED-
PW_LED-	■	1	HDD_LED+
PW_LED+	■		

## Slots

The motherboard provides one AGP slot, five 32-bit PCI bus slots.

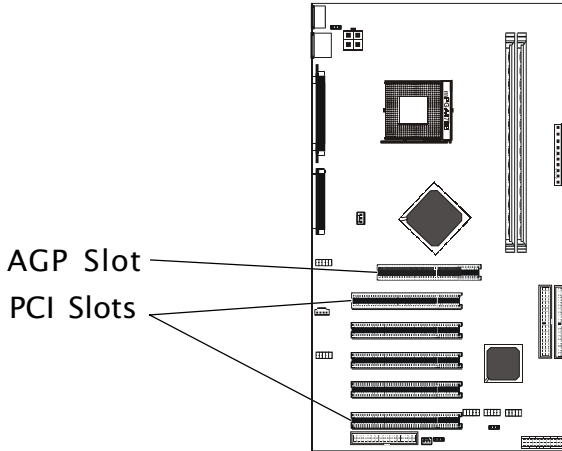

### AGP (Accelerated Graphics Port) Slot

The AGP slot allows you to insert the AGP graphics card. AGP is an interface specification designed for the throughput demands of 3D graphics. It introduces a 66MHz, 32-bit channel for the graphics controller.

### PCI (Peripheral Component Interconnect) Slots

The PCI slots allow you to insert the expansion cards to meet your needs. When adding or removing expansion cards, make sure that you unplug the power supply first. Meanwhile, read the documentation for the expansion card to make any necessary hardware or software settings for the expansion card, such as jumpers, switches or BIOS configuration.

## CPU Installation

Please refer to the following steps to install the CPU.

1. Please turn off the power and unplug the power cord before installing the CPU. Pull the lever sideways away from the socket. Make sure to raise the lever up to a 90 degree angle.

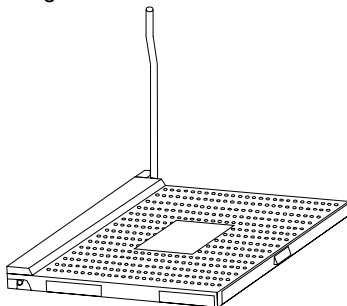

2. Look for the gold arrow. The gold arrow should point towards the lever pivot. The CPU can only fit in the correct orientation.

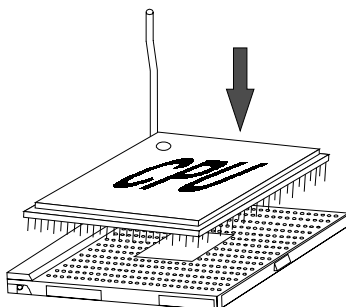

2. If the CPU is correctly installed, the pins should be completely embedded into the socket and can not be seen. Please note that any violation of the correct installation procedures may cause permanent damages to your mainboard.

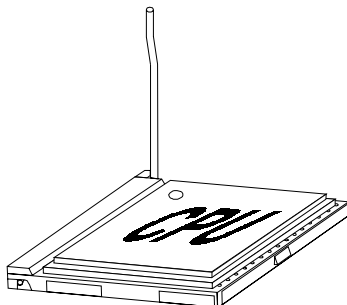

4. Press the CPU down firmly into the socket and close the lever. As the CPU is likely to move while the lever is being closed, always close the lever with your fingers pressing tightly on top of the CPU to make sure the CPU is properly and completely embedded into the socket.

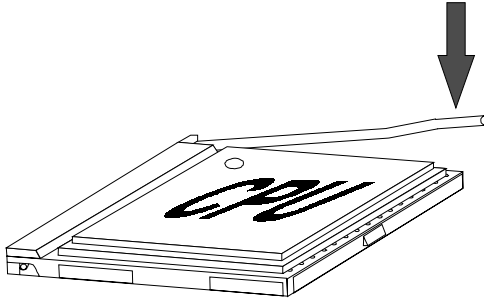

5. Position the CPU cooler set onto the CPU.

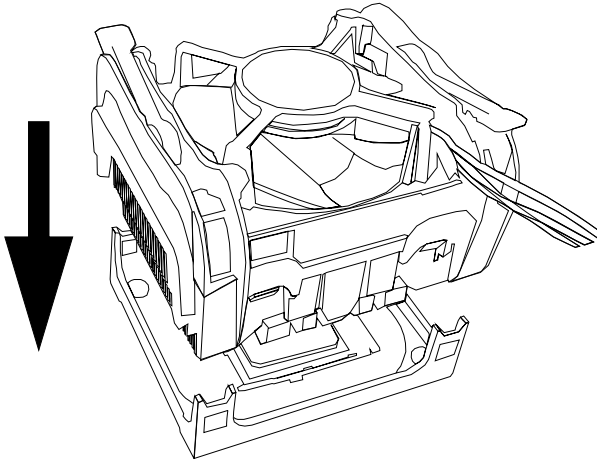

6. Use one end of the clip to hook the latch of the CPU sliding plate and then hook the other three latch to fix the cooling fan set. At last, connect the fan to the power supply connector provided on your mainboard.

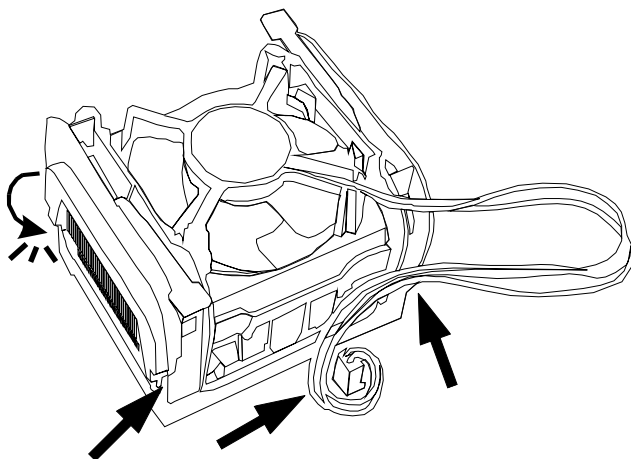

## Hardware Setup

### To Install DDR DIMMs

1. Locate the DDR DIMM sockets.
2. Holding the DDR DIMM by the edges, remove it from its antistatic package.
3. Make sure the clips at either end of the socket are pushed away from the socket.

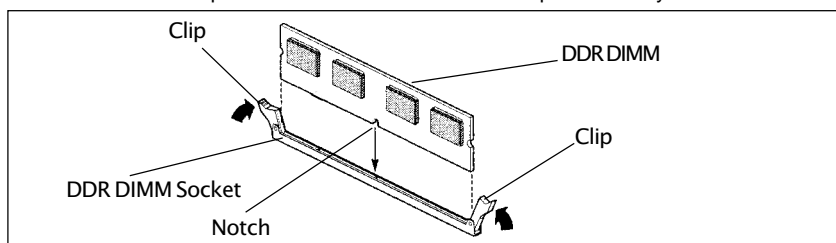

4. Position the DDR DIMM above the socket. Align the notch in the bottom edge of the DDR DIMM with the keys in the socket.
5. Insert the bottom edge of the DDR DIMM into the socket.
6. When the DDR DIMM is seated, push down on the top edge of the DDR DIMM until the retaining clips at the ends of the socket snap into place. Make sure the clips are firmly in place.



**Please turn off system before installing and removing any device, otherwise you'll cause the system damage.**

## BIOS Setup

This chapter discusses Award's Setup Program built into the ROM BIOS. The Setup Program allows users to modify the basic system configuration. This special information is then stored in battery-backed RAM, which retains the setup information when the power is turned off.

### Starting Setup

The Award BIOS is immediately activated when you turn on the computer. The BIOS reads the system information contained in the CMOS and begins the process of checking out the system and configuring it. When it finishes, the BIOS will seek an operating system on one of the disks and then launch and turn control over to the operating system.

While the BIOS is in control, the Setup Program can be activated :

1. By pressing <Del> immediately after switching the system on, or
2. By pressing the <Del> key when the following message appears briefly at the bottom of the screen during the POST (Power On Self Test )

*Press DEL to enter SETUP*

If the message disappears before you can respond and you still wish to enter Setup, restart the system to try again by turning it OFF then ON or pressing the "RESET" button on the system case. You may also restart by simultaneously pressing the <Ctrl>, <Alt>, and <Delete> keys. If you do not press the keys at the correct time and the system does not reset, an error message will be displayed and you will again be asked to ...

*PRESS F1 TO CONTINUE, DEL TO ENTER SETUP*

### Getting Help

Press F1 to pop up a small help window that describes the appropriate keys to use and the possible selections for the highlighted item. To exit the Help Window press <Esc> or the F1 key again.

### In Case of Problems

If, after making and saving system changes with the Setup Program, you discover that your computer does not reset, use the Award BIOS defaults to override the CMOS settings.



## Main Menu

Once you enter the Award BIOS CMOS Setup Utility, the Main Menu will appear on the screen. The Main Menu allows you to select from various setup functions and two exit choices. Use the arrow keys to select among the items and press <Enter> to accept and enter the sub-menu.

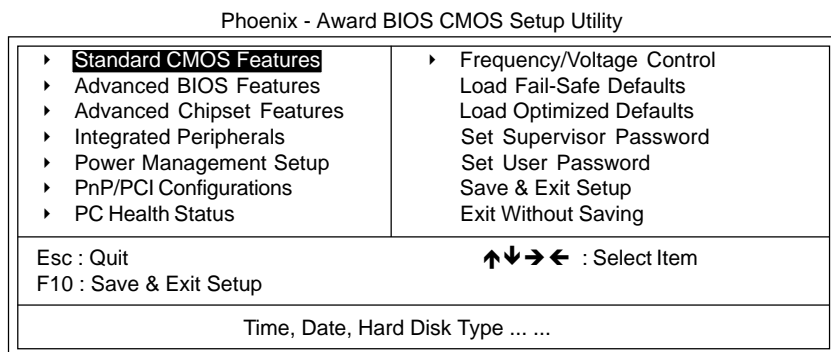

**(Note : The figures of BIOS Setup Menu included here only show a typical case, and may not be exactly the same as the one on your unit.)**

Note that a brief description of each highlighted item will appear at the bottom of the screen.

**Standard CMOS Features** This setup page includes all the items of Award™ special standard features.

**Advanced BIOS Features** This setup page includes all the items of Award™ special enhanced features.

**Advanced Chipset Features** This setup page includes all the items of chipset special features.

**Integrated Peripherals** This section page includes all the items of IDE hard drive and Programmed Input / Output features.

**Power Management Setup** This entry only appears if your system supports Power Management "Green PC" standards.

**PnP/PCI Configurations** This entry appears if your system supports PNP/PCI.

**PC Health Status** Display CPU and Case Fan Speed, etc.

**Frequency/Voltage Control** CPU speed setting are settings of CPU speed. You should refer to your CPU marking.

**Load Fail-Safe Defaults** The BIOS defaults have been set by the manufacturer and represent settings which provide the minimum requirements for your system to operate.

- Load Optimized Defaults**      The chipset defaults are settings which provide for maximum system performance. While Award has designed the custom BIOS to maximize performance, the manufacturer has the right to change these defaults to meet its needs.
- Set Supervisor/User Password**      Changes, sets, or disables password. It allows you to limit access to the system and the Setup Program.
- Save & Exit Setup**      Saves value changes to CMOS and exits setup.
- Exit Without Saving**      Abandons all CMOS value changes and exits setup.

**Standard CMOS Features**

The items in Standard CMOS Setup Menu are divided into 10 categories. Each category includes one or more setup items. Use the arrow keys to highlight the item and then use the <PgUp> or <PgDn> key to select the desired value in each item.

Phoenix - Award BIOS CMOS Setup Utility  
Standard CMOS Features

Date (mm :dd :yy)	Thu, Jan 01 2004	ItemHelp  Menu Level ▶  Change the day, month, year and century
Time (hh :mm :ss)	11 : 1 : 35	
▶ IDE Channel 0 Master	[Press Enter 4303 MB]	
▶ IDE Channel 0 Slave	[None]	
▶ IDE Channel 1 Master	[None]	
▶ IDE Channel 1 Slave	[None]	
Drive A	[1.44M, 3.5 in.]	
Drive B	[None]	
Video	[EGA/VGA]	
Hard on	[All, But Keyboard]	
Base Memory	640K	
Extended Memory	30720K	
Total Memory	31744K	

↑↓→←: Move    Enter : Select +/-/PU/PD : Value    F10 : Save    ESC : Exit    F1 : General Help  
 F5 : Previous Values      F6 : Fail-Safe Defaults      F7 : Optimized Defaults

**(Note : The figures of BIOS Setup Menu included here only show a typical case, and may not be exactly the same as the one on your unit.)**

- Date**      The date format is <day-of-the-week>. <month> <day> <year>.
- Time**      The time format is <hour> <Minute> <second> displayed in 24-hour military-time clock. For example, 1 p. m. is displayed as 13:00:00.

---

<b>IDE Channel 0/1</b>	<p>These categories identify the types of the two channels that have been installed in the computer.</p> <p>If the controller of the HDD interface is SCSI, the selection shall be "None".</p>
<b>Drive A / Drive B</b>	<p>This category identifies the types of floppy disk drive A or drive B that has been installed in the computer.</p>
<b>Video</b>	<p>The default setting is EGA/VGA.</p>
<b>Halt on</b>	<p>You can select which type of error will cause the system to halt.</p>

### Advanced BIOS Features

This section allows you to configure your system for basic operation. You have the opportunity to select the system's default speed, boot-up sequence, keyboard operation, shadowing and security.

### Advanced Chipset Features

The Chipset Features Setup option is used to change the values of the chipset registers. These registers control most of the system options in the computer.

This section allows you to configure the system based on the specific features of the installed chipset. This chipset manages bus speeds and access to system memory resources, such as DRAM and the external cache. It must be stated that these items should not be altered. The default settings have been chosen because they provide the best operating conditions for your system.

### Integrated Peripherals

The Integrated Peripherals Setup allows the user to configure the onboard IDE controller, floppy disk controller, the printer port and the serial ports.

### Power Management Setup

The Power Management Setup Menu allows you to configure your system to most save energy while operating in a manner consistent with your own style of computer use.

### PnP/PCI Configurations

This section describes how to configure the PCI bus system. This section covers some very technical items and it is recommended that only experienced users should make any changes to the default settings.

### PC Health Status

The PC Health Status display CPU and Case Fan Speed etc.

## Frequency/Voltage Control

This section allows you to set CPU Speed.

## Set Supervisor/User Password

You can set either supervisor or user password, or both of them. The difference between them are:

**Supervisor Password :** You can enter the Setup Program and change the options of the setup menus.

**User Password :** You can enter the Setup Program but can not change the options of the setup menus.

When you select this function, the following message will appear at the center of the screen to assist you in creating a password.

### *ENTER PASSWORD:*

Type the password, up to eight characters in length, and press<Enter>. The new password will clear the previously entered password from the CMOS memory. You will be asked to confirm the password. Type the password again and press <Enter>. You may also press <Esc> to abort the selection and operate without a password.

To disable a password, just press <Enter> when you are prompted to enter the password. A message will be displayed to confirm that the password is disabled.

### *PASSWORD DISABLED.*

Once the password is disabled, the system will reset and you can enter the Setup Program freely.

When a password is enabled, you will be prompted to enter it every time you try to enter setup. This prevents an unauthorized person from changing any setting of your system configuration.

In addition, when a password is enabled, you can require the BIOS to request a password every time your system is rebooted. This would further prevent unauthorized use of your computer.

The password requirement is defined by the Security Option of the BIOS Features Setup Menu. If the Security Option is set to "System", the password will be required both at resetting and at entering setup. If the option is set to "Setup", the prompt only appears when you try to enter setup.

---

## Flash Update Procedure

A program AWDFLASH.EXE is included in the utility diskette or CD (X:\Utility\AWDFLASH.EXE). The user is recommended to follow the procedure below to update the flash BIOS.

(X: your CD driver letter).

1. Create a DOS-bootable floppy diskette. Copy the new BIOS file (just obtained or downloaded) and the utility program AWDFLASH.EXE to the diskette.
2. Allow the PC system to boot from the DOS diskette.
3. At the DOS prompt, key in

*AWDFLASH*  
*and hit <ENTER>*

4. Enter the file name of the new BIOS.
5. The question: "Do you want to save BIOS (Y/N)?" is displayed.

*Key in "N" if there is no need to save the existing BIOS content..*  
*Key in "Y" if a backup copy of the existing BIOS is needed.*  
*(A file name has to be assigned to the existing BIOS binary file.)*

6. The message:press "Y" to program or "N" to exit is displayed.

*Key in "Y"*

7. Wait until the flash-update is completed.
8. Power down the PC system.
9. Restart the PC.

### **Warning:**

DO not turn off or RESET the computer during the flash process. If you are unsure how to upgrade the BIOS, it is best to take your computer to an Authorized Service Center and have a trained technician do the work for you.

## VT8237 SATA RAID User Manual

### Enter BIOS Configuration Utility

When the system powers on, the following information will appear on screen. Press the 'Tab' key to enter BIOS configuration utility.

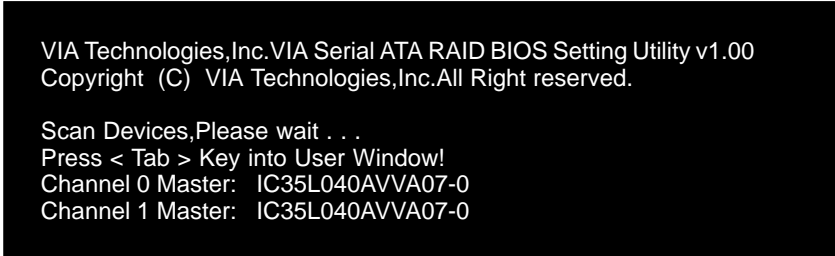

The main interface of BIOS configuration utility is as below:

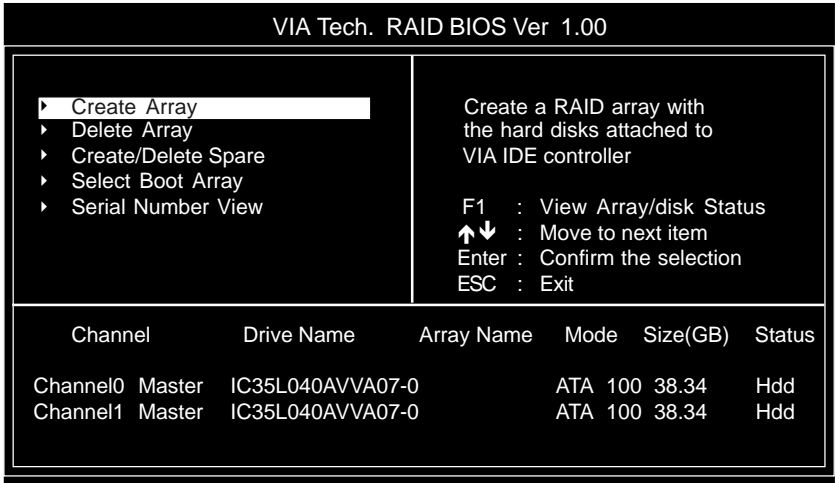

## Create Disk Array

1. Use the arrow keys to navigate the main menu. Use the up and down arrow keys to select the **Create Array** command and press <Enter> to call out the list of creation steps.

VIA Tech. RAID BIOS Ver 1.00

<ul style="list-style-type: none"> <li>▶ Auto Setup For Data Security</li> <li>▶ Array Mode RAID 1 (Mirroring)</li> <li>▶ Select Disk Drives</li> <li>▶ Start Create Process</li> </ul>	<p>Create a RAID array with the hard disks attached to VIA IDE controller</p> <p>F1 : View Array/disk Status            ↑↓ : Move to next item            Enter : Confirm the selection            ESC : Exit</p>																		
<table border="1" style="width: 100%; border-collapse: collapse;"> <thead> <tr> <th style="text-align: left;">Channel</th> <th style="text-align: left;">Drive Name</th> <th style="text-align: left;">Array Name</th> <th style="text-align: left;">Mode</th> <th style="text-align: left;">Size(GB)</th> <th style="text-align: left;">Status</th> </tr> </thead> <tbody> <tr> <td>Channel0</td> <td>Master</td> <td>IC35L040AVVA07-0</td> <td>ATA</td> <td>100 38.34</td> <td>Hdd</td> </tr> <tr> <td>Channel1</td> <td>Master</td> <td>IC35L040AVVA07-0</td> <td>ATA</td> <td>100 38.34</td> <td>Hdd</td> </tr> </tbody> </table>		Channel	Drive Name	Array Name	Mode	Size(GB)	Status	Channel0	Master	IC35L040AVVA07-0	ATA	100 38.34	Hdd	Channel1	Master	IC35L040AVVA07-0	ATA	100 38.34	Hdd
Channel	Drive Name	Array Name	Mode	Size(GB)	Status														
Channel0	Master	IC35L040AVVA07-0	ATA	100 38.34	Hdd														
Channel1	Master	IC35L040AVVA07-0	ATA	100 38.34	Hdd														

2. Highlight the **Array Mode** and press <Enter>, then a list of array modes will appear. Just highlight the target array mode that you want to create, and press <Enter> to confirm the selection.

VIA Tech. RAID BIOS Ver 1.00

<ul style="list-style-type: none"> <li>▶ RAID 0 for performance</li> <li>▶ RAID 1 for data protection</li> <li>▶ RAID SPAN for capacity</li> </ul>	<p>Create a RAID array with the hard disks attached to VIA IDE controller</p> <p>F1 : View Array/disk Status            ↑↓ : Move to next item            Enter : Confirm the selection            ESC : Exit</p>																		
<table border="1" style="width: 100%; border-collapse: collapse;"> <thead> <tr> <th style="text-align: left;">Channel</th> <th style="text-align: left;">Drive Name</th> <th style="text-align: left;">Array Name</th> <th style="text-align: left;">Mode</th> <th style="text-align: left;">Size(GB)</th> <th style="text-align: left;">Status</th> </tr> </thead> <tbody> <tr> <td>Channel0</td> <td>Master</td> <td>IC35L040AVVA07-0</td> <td>ATA</td> <td>100 38.34</td> <td>Hdd</td> </tr> <tr> <td>Channel1</td> <td>Master</td> <td>IC35L040AVVA07-0</td> <td>ATA</td> <td>100 38.34</td> <td>Hdd</td> </tr> </tbody> </table>		Channel	Drive Name	Array Name	Mode	Size(GB)	Status	Channel0	Master	IC35L040AVVA07-0	ATA	100 38.34	Hdd	Channel1	Master	IC35L040AVVA07-0	ATA	100 38.34	Hdd
Channel	Drive Name	Array Name	Mode	Size(GB)	Status														
Channel0	Master	IC35L040AVVA07-0	ATA	100 38.34	Hdd														
Channel1	Master	IC35L040AVVA07-0	ATA	100 38.34	Hdd														

3. After selected array mode, there are two methods to create a disk array. One method is “**Auto Setup**” another is “**Select Disk Drives**”. **Auto Setup** let BIOS select the disk drives and create array automatically. **Select Disk Drives** let user select the array drives by required. When using **Select Disk Drives** method, the channel column will be activated. Just highlight the target drives that you want to use and press <Enter> to select them respectively. After all drives have been selected, press <Esc> to go back to the creation steps menu.

VIA Tech. RAID BIOS Ver 1.00

<ul style="list-style-type: none"><li>▶ Auto Setup For Performance</li><li>▶ Array Mode RAID 0 (Striping)</li><li>▶ Select Disk Drives</li><li>▶ Block Size 64K</li><li>▶ Start Create Process</li></ul>	Create a RAID array with the hard disks attached to VIA IDE controller  F1 : View Array/disk Status ↑↓ : Move to next item Enter : Confirm the selection ESC : Exit
--	--

Channel	Drive Name	Array Name	Mode	Size(GB)	Status
[ * ]Channel0 Master	IC35L040AVVA07-0		ATA 100	38.34	Stripe0
[ ]Channel1 Master	IC35L040AVVA07-0		ATA 100	38.34	Hdd

4. If user selected a RAID 0 array in step 2, user also can select a block size for the array. Use the arrow key to highlight the Block Size and press <Enter>, then select a block size from will popup. The block size can be selected from 4K to 64K Bytes.

VIA Tech. RAID BIOS Ver 1.00

<ul style="list-style-type: none"><li>▶ Auto Setup For</li><li>▶ Array Mode RAID</li><li>▶ Select Disk Dri</li><li>▶ Block Size 64K</li><li>▶ Start Create Pr</li></ul>	<div style="border: 1px solid black; padding: 5px; display: inline-block;">4K 8K 16K 32K 64K</div>	Create a RAID array with the hard disks attached to VIA IDE controller  F1 : View Array/disk Status ↑↓ : Move to next item Enter : Confirm the selection ESC : Exit
---	--	--

Channel	Drive Name	Array Name	Mode	Size(GB)	Status
[ * ]Channel0 Master	IC35L040AVVA07-0		ATA 100	38.34	Stripe0
[ * ]Channel1 Master	IC35L040AVVA07-0		ATA 100	38.34	Stripe1



5. Use the arrow key to highlight **Start Create Process** and press <Enter>. A warning message will appear, press **Y** to finish the creation, or press **N** to cancel the creation.
6. Please note that all existing content in the hard drive will be destroyed after the array creation.

## Delete Disk Array

A specific RAID can be deleted after it has been created. To delete a created RAID, please use the following steps:

1. Select **Delete Array** in the main menu and press <Enter>. The channel column will be activated.
2. Select the member of an array that is to be deleted and press <Enter>. A warning message will show up, press **Y** to delete or press **N** to cancel.

VIA Tech. RAID BIOS Ver 1.00

<ul style="list-style-type: none"> <li>▶ Create Array</li> <li>▶ Delete Array</li> <li>▶ Create/Delete Spare</li> <li>▶ Select Boot Array</li> <li>▶ Serial Number View</li> </ul> <p>The selected array will be destroyed Are you sure? Continue? Press Y/N</p>	<p>Delete a RAID array contain the hard disks attached to VIA IDE controller</p> <p>F1 : View Array/disk Status            ↑↓ : Move to next item            Enter : Confirm the selection            ESC : Exit</p>
--	--

Channel	Drive Name	Array Name	Mode	Size(GB)	Status
[*] Channel0 Master	IC35L040AVVA07-0	ARRAY 0	ATA 100	38.34	Stripe0
[*] Channel1 Master	IC35L040AVVA07-0	ARRAY 0	ATA 100	38.34	Stripe1

Deleting a disk array will destroy all the data on the disk array except RAID 1 arrays. When a RAID 1 is deleted, the data on these two hard disk drives will be reserved and become two normal disk drives.

## Select Boot Array

User can select a disk array as boot device if user wants to boot operating system from an array. Boot disk array can be not selected if user does not boot operating system from disk array. Use the arrow key to highlight the Select Boot Disk item then press <Enter>. The channel column will be activated. Just use arrow key to highlight the target disk array then press <Enter>. If user select a disk array that has a boot mark and press <Enter>, then its boot setting will be canceled.

VIA Tech. RAID BIOS Ver 1.00

<ul style="list-style-type: none"> <li>▶ Create Array</li> <li>▶ Delete Array</li> <li>▶ Create/Delete Spare</li> <li>▶ Select Boot Array</li> <li>▶ Serial Number View</li> </ul>	<p>Sct/Clear bootable array</p> <p>F1 : View Array/disk Status            ↑↓ : Move to next item            Enter : Confirm the selection            ESC : Exit</p>
--	---

Channel	Drive Name	Array Name	Mode	Size(GB)	Status
[*] Channel0 Master	IC35L040AVVA07-0	ARRAY 0	ATA	100 38.34	Boot
[*] Channel1 Master	IC35L040AVVA07-0	ARRAY 0	ATA	100 38.34	Boot

### Duplicate Critical RAID 1 Array

When booting up the system, BIOS will detect if the RAID 1 array has any inconsistencies between user data and backup data. If BIOS detects any inconsistencies, the status of the disk array will be marked as critical, and BIOS will prompt the user to duplicate the RAID 1 in order to ensure the backup data consistency with the user data.

<p style="text-align: center;">Critical RAID 1</p> <p style="margin-top: 20px;">Duplicate now Continue to boot</p>	<p style="text-align: center;">Critical Status</p> <p style="margin-top: 20px;">the RAID 1 array needs to be duplicated to ensure data consistency.</p> <p style="margin-top: 10px;">Fault Hdd Found: Channel 1 Device 0 Fault</p>
--	--

Remaining members of the failed array					
Channel	Drive Name	Array Name	Mode	Size(GB)	Status
Channel1 Device0	IC35L040AVVA07-0	Array0	ATA	100 38.34	Mirror
Channel0 Device0	IC35L040AVVA07-0	Array0	ATA	100 38.34	Source

Note:  
 1) Press <ESC> to Exit.  
 2) After Execute, Press <TAB> immediately can into Utility Window!

If user selects Continue to boot, it will enable duplicating the array after booting into OS.

## Rebuild Broken RAID 1 Array

When booting up the system, BIOS will detect if any member disk drives of RAID has failed or is absent. If BIOS detects any disk drive failures or missing disk drives, the status of the array will be marked as broken.

If BIOS detects a broken RAID 1 array but there is a spare hard drive available for rebuilding the broken array, the spare hard drive will automatically become the mirroring drive. BIOS will show a main interface just like a duplicated RAID 1. Selecting **Continue to boot** enables the user to duplicate the array after booting into operating system.

Broken RAID 1		Critical Status			
<p>Power off and check the failed drive            Destroy the Mirroring Relationship            Choose replacement drive and rebuild            Continue to boot</p>		<p>A disk member of a mirroring array has failed or is not responding. The array is still functional, but fault tolerance is disabled.</p>			
Remaining members of the failed array					
Channel	Drive Name	Array Name	Mode	Size(GB)	Status
Channel0	Device0	IC35L040AVVA07-0	Array0	ATA 100	38.34 Broken
<p>Note:            1) Press &lt;ESC&gt; to Exit.            2) After Execute, Press &lt;TAB&gt; immediately can into Utility Window!</p>					

### 1. Power off and Check the Failed Drive:

This item enables users to turn off the computer and replace the failed hard drive with a good one. If users' computer does not support APM, the computer would need to be turned off manually. After the replacement, users can boot into BIOS and select **3 Choose replacement drive and rebuild** to rebuild the broken array.

### 2. Destroy the Mirroring Relationship:

This item enables users to cancel the data mirroring relationship of the broken array. For broken RAID 1 array, the data on the surviving disk will remain after the destroy operation.

However, **Destroy the Mirroring Relationship** is not recommend because the data on the remaining disk will be lost when the hard drive is used to create another RAID 1 array.

### 3. Choose Replacement Drive and Rebuild:

This item enables users to select an already-connected hard drive to rebuild the broken array and replace the data to that particular hard drive. After choosing the item, the channel column will be activated.

Broken RAID 1						Critical Status
Power off and check the failed drive Destroy the Mirroring Relationship Choose replacement drive and rebuild Continue to boot						The contents on the disk you have selected will be deleted.
Remaining members of the failed array						
Channel	Drive Name	Array Name	Mode	Size(GB)	Status	
( ) Channel1	Device0	IC35L040AVVA07-0	ATA	100	38.34	Hdd
Note: 1) Press <ESC> to Exit. 2) After Execute, Press <TAB> immediately can into Utility Window!						

Highlight the target hard drive and press <Enter>, a warning message will appear. Press **Y** to use that hard drive to rebuild, or press **N** to cancel. Please note by selecting option **Y**, all the data on the selected hard drive will be destroyed.

### 4. Continue to boot:

This item enables BIOS to skip the problem and continue booting into OS.

---

## DRIVER AND RAID SOFTWARE INSTALLATION

### Microsoft Windows Driver Installation

1. After Windows has finished booting up, the system will automatically find the newly installed adapter and prompt the **Found New Hardware Wizard** window. Click **Cancel** to skip it.



2. Insert the bundled driver CD DISC into your CD-ROM drive, select "**Serial ATA RAID Driver**" installation bar on the dialogue Window to begin the driver and software installation.

3. Confirm the follow-up dialogue windows to finish the installation.



4. When installation is completed, click **Finish** to restart the system.



---

## Install Operating System into SATA HDD of VT8237

### Install Windows 98SE or Me

1. Make sure the HDD wanted for installing the OS is in the first hard disk drive(C:\).
2. Install OS.
3. Install driver after OS is installed.

### Install Windows NT 4.0,2000,XP

1. Insert the bundled driver CD DISC into CD-ROM(G:). Copy all files and directories of G:\VIA chipset\SATA\_Raid\DriverDisk\SATA folder to a floppy disk. Make sure following directories and files are copied into floppy disk.

A:\

\Win2000

    VIAsraid.inf

    VIAsraid.sys

    VIAsraid.cat

\Winnt40

    VIAsraid.inf

    VIAsraid.sys

\WinXP

    VIAsraid.inf

    VIAsraid.sys

    VIAsraid.cat

Txtsetup.oem

VT8237

2. Install OS from CD-ROM.
  3. Press "**F6**" when display "Press **F6** if you need to install a third party SCSI or RAID driver..."
  4. Insert floppy disk.
  5. Choose the OS device driver wanted for loading.
  6. Install OS.
  7. Install driver after OS is installed.
-

## APPENDIX

### Note to User:

1.The bundled driver CD attached an Auto-Run feature for all the drivers that the motherboard need. Please select the drivers that you want to install and click the button on the installation panel.

2.When you have DDR400 RAM on P4X533 chipset, you can manually set DRAM Clock to “200MHz” (at CMOS Setup Utility---Advanced Chipset Features---DRAM Clock/Drive Control) for higher performance. But if the system unstable running at 200MHz, please set DRAM Clock back to “By SPD” or “166MHz” for more stable performance.