



Electronic Emission Notices

Federal Communications Commission (FCC) Statement

This equipment has been tested and found to comply with the limits for a Class B digital device, pursuant to Part 15 of FCC Rules. These limits are designed to provide reasonable protection against harmful interference in a residential installation. This equipment generates, uses and can radiate radio frequency energy and, if not installed and used in accordance with instructions contained in this manual, may cause harmful interference to radio and television communications. However, there is no guarantee that interference will not occur in a particular installation.

If this equipment does cause harmful interference to radio or television reception, which can be determined by turning the equipment off and on, the user is encouraged to try to correct the interference by one or more of the following measures:

- REORIENT OR RELOCATE THE RECEIVING ANTENNA
- INCREASE THE SEPARATION BETWEEN THE EQUIPMENT AND THE RECEIVER
- CONNECT THE EQUIPMENT INTO AN OUTLET ON A CIRCUIT DIFFERENT FROM THAT OF THE RECEIVER
- CONSULT THE DEALER OR AN EXPERIENCED AUDIO/TELEVISION TECHNICIAN

NOTE: Connecting this device to peripheral devices that do not comply with Class B requirements, or using an unshielded peripheral data cable, could also result in harmful interference to radio or television reception.

The user is cautioned that any changes or modifications not expressly approved by the party responsible for compliance could void the user's authority to operate this equipment.

To ensure that the use of this product does not contribute to interference, it is necessary to use shielded I/O cables.

Copyright

This manual is copyrighted with all rights reserved. No portion of this manual may be copied or reproduced by any means.

While every precaution has been taken in the preparation of this manual, no responsibility for errors or omissions is assumed. Neither is any liability assumed for damages resulting from the use of the information contained herein.

Trademarks

All brand names, logos and registered trademarks mentioned are property of their respective owners.

Table of Contents

HARDWARE CONFIGURATION	4
Key Features	4
MOTHERBOARD LAYOUT	6
REAR PANEL	7
CONNECTORS	9
Floppy Disk Drive Connector:CN3	9
Hard Disk Connector:CN1&CN2	9
Serial ATA Hard Disk Connector:SATA-1/SATA-2	10
S-Bracket (SPDIF)/LEN/LFE/Surround Output Connector: CN4(optional).....	12
Fan Power Connectors: CPUFAN/SYSFAN	14
CD-IN Connector:CDS1	15
Front Panel Audio Header:FPS1	16
USB Connectors:USB2/USB3/USB4	17
Front Panel Headers:FP1	18
JUMPER SETTING	19
J1,J2 - CPU Speed Select	19
JBAT1 - CMOS Clear	19
JP1-Keyboard Power Select Jumper	19
SLOTS	20
CPU INSTALLATION	21
INSTALL DDR DIMMs	24

BIOS SETUP	25
Starting Setup	25
Main Menu	26
Standard CMOS Features	27
Advanced BIOS Features	28
Advanced Chipset Features	28
Integrated Peripherals	28
Power Management Setup	28
PNP/PCI Configurations	28
PC Health Status	28
Frequency/Voltage Control	28
Set Supervisor/User Password	29
Flash Update Procedure	30
VT8237 SATA RAID USER MANUAL	31
Enter BIOS Configuration Utility	31
Create Disk Array	32
Delete Disk Array	34
Select Boot Array	34
Duplicate Critical RAID 1 Array	35
Rebuild Broken RAID 1 Array	36
DRIVER AND RAID SOFTWARE INSTALLATION	38
Microsoft Windows Driver Installation	38
INSTALL OPERATING SYSTEM INTO SATA HDD OF VT8237	40
Install Windows 98SE or Me	40
Install Windows NT4.0,2000,XP	40
APPENDIX	40

HARDWARE CONFIGURATION

Key Features :

Chipset

- VIA® KT600 Chipset.

Processor

- Full supports AMD Athlon™, Athlon XP and Duron™ processors use Socket A.
- Supports bus speed of 100/133/166/200MHz processors.

VRM 9.0 (Voltage Regulator Modules) on Board

- Flexible motherboard design with on board VRM 9.0.

System Memory

- A total of two 184pin DDR SDRAM sockets.
- Supports PC3200/PC2700/PC2100/PC1600 DDR DRAM.
- Supports 4 banks up to 2GB DRAMs (512Mb x8/x16 DRAM technology) for register and unbuffered DDR SDRAM module.
- Supports DDR SDRAM memory types.
- 2.5V DRAM interface for DDR SDRAM.

System BIOS

- PnP, APM, ATAPI and Windows® 98/2000/XP.
- Full support of ACPI & DMI.
- Auto detects and supports LBA harddisk with capacities over 160GB.
- Easy to upgrade BIOS by end user.

On-board I/O

- On board two PCI fast IDE ports supporting up to 4 ATA, ATA2 and Ultra DMA33/66/100/133 IDE devices.
- One ECP/EPP parallel port.
- Two 16550 Compatible UART serial ports.
- One floppy port supports two FDD of 360KB, 720KB, 1.2MB , 1.44MB and 2.88MB capacity.
- Six USB ports (four ports via two headers for VT8235CE only).
- Eight USB ports (six ports via three headers for VT8237 only).
- PS/2 mouse is supported.
- PS/2 keyboard is supported.
- Infrared (IrDA) is supported via a header.
- One Line/speaker out, one Mic in, one line in and MIDI/Gameport (optional).
- One Front Panel Sound Connector (via a header).
- Two on board SATA ports (optional).

Plug-and-Play

- Supports Plug and Play specification 1.1.
- Plug and Play for Windows® 98/2000 as well as Windows® XP.
- Fully steerable PCI interrupts.

Expanded USB Support

- Includes 3/4 UHCI host controllers, increasing the number of external ports to six/eight.
- Includes 1 EHCI USB2.0 Host Controller that supports six/eight ports (Bandwidth shared between six/eight ports).
[Six USB ports are for VT8235CE, eight USB ports are for VT8237]

Full Featured Accelerated Graphics Port (AGP)

- Supports AGP 2.0/3.0 including 4x/8x AGP data transfers and 4x/8x Fast Write protocol.
- AGP 1.5V connector support only, No support for 3.3V or Universal AGP connectors.

On-board VT6103 LAN (optional)

- Standard MII interface to external PHYceiver.
- 10/100MHz full and half duplex operation.
- Supports Wake-On-LAN function and remote wake-up (optional).

On-board AC97 Sound (optional)

- Dual full-duplex Direct Sound channels between system memory and AC97 link.
- PCI master interface with scatter / gather and bursting capability.
- Host based sample rate converter and mixer.
- Hardware SoundBlaster Pro for Windows DOS box and real-mode DOS legacy compatibility.
- Complete software driver support for Windows98/2000/XP.
- Supports ALC650/655 AC97 Code for six sound channel output (optional).

Power Management

- Supports SMM, APM and ACPI.
- Break switch for instant suspend/resume on system operations.
- Energy star "Green PC" compliant.
- External modem Ring-in Wake-up support.
- Supports suspend-to-RAM(STR) (optional).

Dual channel Serial ATA/RAID Controller (optional)

- Complies with Serial ATA Specification Revision 1.0.
- Two ports supported two S-ATA devices.
- Support RAID Configuration.
- S-ATA drive transfer rate is capable of up to 150MB/S per channel.

Expansion Slots

- 1 AGP slot (AGP 3.0 compliant).
- 5 PCI bus master slots - ver. 2.1 compliant.



Static electricity can harm delicate components of the motherboard. To prevent damage caused by static electricity, discharge the static electricity from your body before you touch any of the computers electronic components.

Motherboard Layout

The following diagrams show the relative positions of the jumpers, connectors, major components and memory banks on the motherboard.

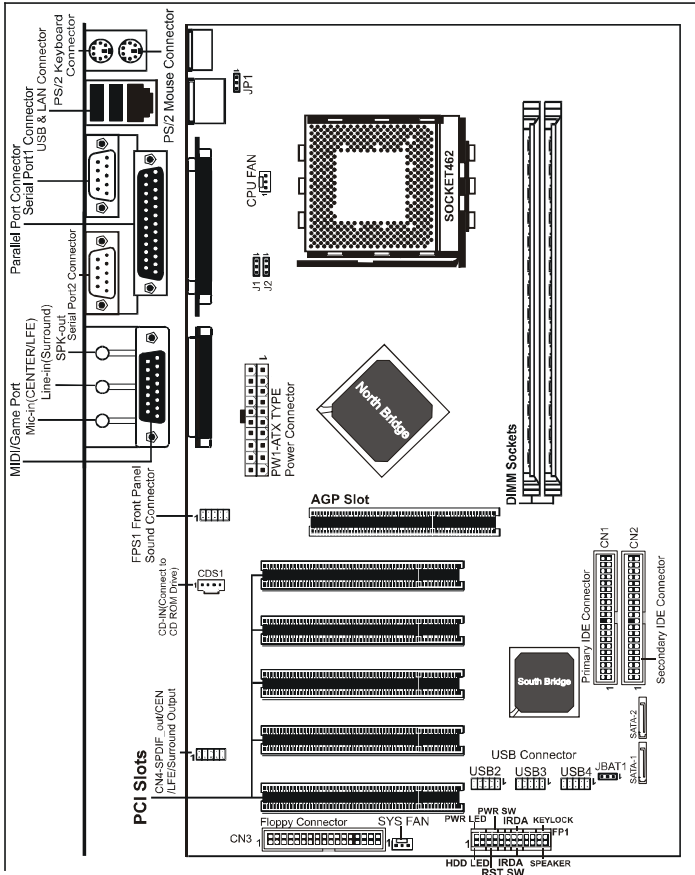

The LAN, SATA-1 and SATA-2 connectors are optional.

The ALC650/ALC655 embeds an internal analog switch (by driver software) to share LINE input with Surround output, and share MIC input with CENTER/LFE output.

NOTE

- 1) Be sure to check the cable orientation in order to match the colored strip to the pin1 end of the connector.
- 2) When you start up the system, please wait for 5 seconds after you power on AC.
- 3) It is not recommended to add a metal spacer plate on the back of the Socket462. Otherwise, some components will be short and damaged.

Rear Panel

The back panel provides the following connectors:

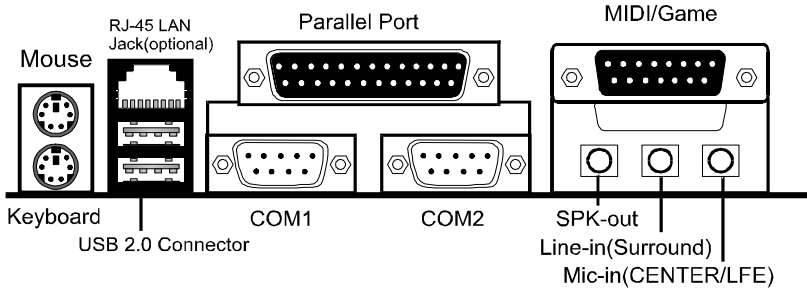

Mouse Connector

The mainboard provides a standard PS/2[®] mouse mini DIN connector for attaching a PS/2[®] mouse. You can plug a PS/2[®] mouse directly into this connector.

Keyboard Connector

The mainboard provides a standard PS/2[®] keyboard mini DIN connector for attaching a PS/2[®] keyboard. You can plug a PS/2[®] keyboard directly into this connector.

USB 2.0 Connector

The mainboard provides a UHCI (Universal Host Controller Interface) Universal Serial Bus root for attaching USB devices such as keyboard, mouse or other USB-compatible devices. You can plug the USB device directly into the connector.

USB 2.0 Connector

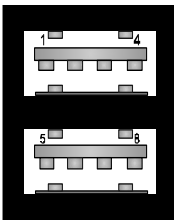

USB 2.0 Connector Description

PIN	SIGNAL	DESCRIPTION
1	VCC	+5V/5VSB (optional)
2	-Data 0	Negative Data Channel 0
3	+Data0	Positive Data Channel 0
4	GND	Ground
5	VCC	+5V/5VSB (optional)
6	-Data 1	Negative Data Channel 1
7	+Data 1	Positive Data Channel 1
8	GND	Ground

Serial Port Connector: COM1 & COM2

The Ports are 16550A high speed communication ports that send/receive 16 bytes FIFOs. You can attach a serial mouse or other serial devices directly to the connectors.

RJ-45 LAN Jack (Optional)

The mainboard provides one standard RJ-45 jack for connection to Local Area Network(LAN). You can connect a network cable to the LAN jack.

Parallel Port Connector:LPT1

The mainboard provides a 25-pin female centronic connector as LPT. A parallel port is a standard printer port that supports Enhanced Parallel Port (EPP) and Extended Capabilities Parallel Port (ECP) mode.

Audio Port Connector

SPK_Out is a connector for Speakers or Headphones. **Line In** is used for external CD player, Tape player, or other audio devices. **Mic In** is a connector for microphones. The ALC650/655 embeds an internal analog switch (by driver software) to share LINE input with Surround output, and share MIC input with CENTER/LFE output.

Connectors

The mainboard provides connectors to connect to FDD, IDE HDD, USB Ports and CPU/System FAN etc.

Floppy Disk Drive Connector:CN3

The mainboard provides a standard floppy disk drive connector that supports 360K, 720K, 1.2M, 1.44M and 2.88M floppy disk types.

Hard Disk Connectors:CN1&CN2

The mainboard has a 32-bit Enhanced PCI IDE and Ultra DMA 33/66/100 controller that provides PIO mode 0~4, Bus Master, and Ultra DMA 33/66/100 function. You can connect up to four hard disk drives, CD-ROM, 120MB Floppy (reserved for future BIOS) and other devices.

CN1 (Primary IDE Connector)

The first hard drive should always be connected to CN1. CN1 can connect a Master and a Slave drive. You must configure second hard drive to Slave mode by setting the jumper accordingly.

CN2 (Secondary IDE Connector)

CN2 can also connect a Master and a Slave drive.

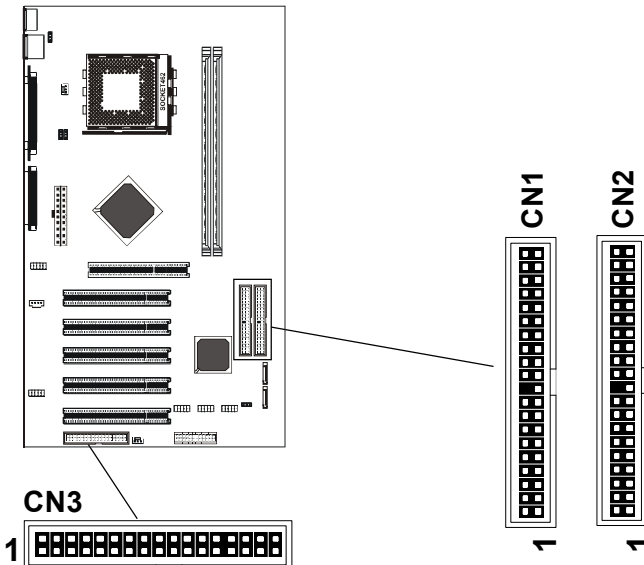

Serial ATA Hard Disk Connectors: SATA-1/SATA-2

The mainboard has 2 SATA connectors. The mainboard provides optional dual high-speed Serial ATA interface ports, SATA-1 & SATA-2. Each supports 1st generation serial ATA data rates of 150 MB/s. Both connectors are fully compliant with Serial ATA 1.0 specifications. Each Serial ATA connector can connect to 1 hard disk device. Please refer to Serial ATA Raid manual for detail software installation procedure.

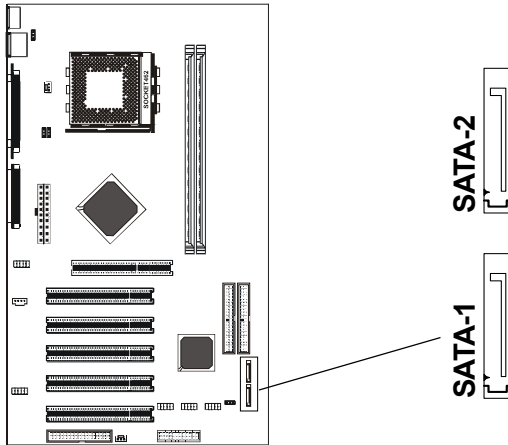

SATA-1 & SATA-2

PIN	SIGNAL
1	GND
2	TXP
3	TXN
4	GND
5	RXN
6	RXP
7	GND

Serial ATA Cable



Connect one end of the SATA cable to the mainboard, and connect another end to the SATA Hard Disk.



Please do not fold the serial ATA cable in a 90-degree angle, which will cause the loss of data during the transmission.

Serial ATA Hard Disk Devices Power Cable

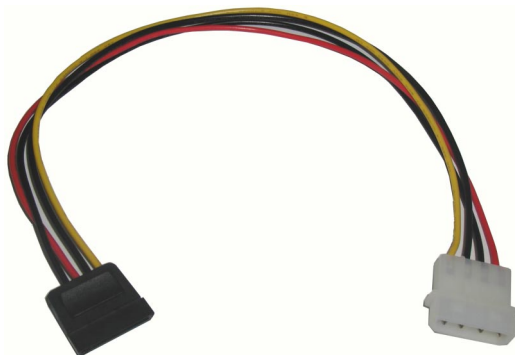

S-Bracket(SPDIF)/CEN/LFE/Surround Output Connector: CN4 (optional)

The connector allows you to connect a S-Bracket for a Digital Interface (SPDIF). The S-Bracket offers 1 SPDIF jacks for digital audio transmission and 2 analog Line-Out jacks for other 4-channel audio output. So you can use Line in, Mic in and 6 channel audio output features at the same time.

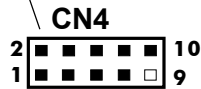
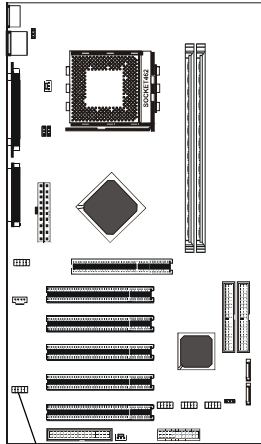

CN4-S-Bracket

PIN	SIGNAL	DESCRIPTION
1	SOUT-L	Audio left surrounding output
2	SOUT-R	Audio right surrounding output
3	GND	Ground
4	GND	Ground
5	CET-OUT	Audio center output
6	LFE-OUT	Audio bass output
7	GND	Ground
8	SPDIF	S/PDIF input
9	(No Pin)	Key
10	SPDFO	S/PDIF output

S-Bracket Cable (optional)

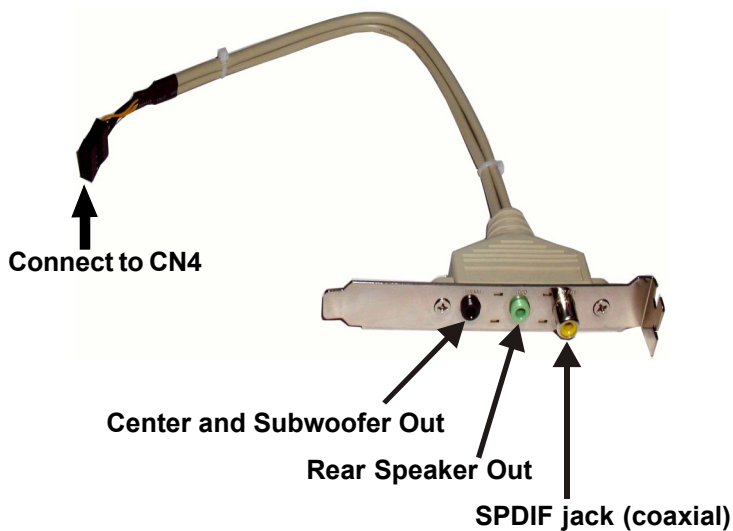

Fan Power Connectors: CPUFAN/SYSFAN

The CPUFAN (processor fan), SYSFAN (system fan) support system cooling fan with +12V. It supports three-pin head connector. When connecting the wire to the connectors, always take note that the red wire is the positive and should be connected to the +12V, the black wire is Ground and should be connected to GND. If the motherboard has a System Hardware Monitor chipset on-board, you must use a specially designed fan with speed sensor to take advantage of the CPU fan control.

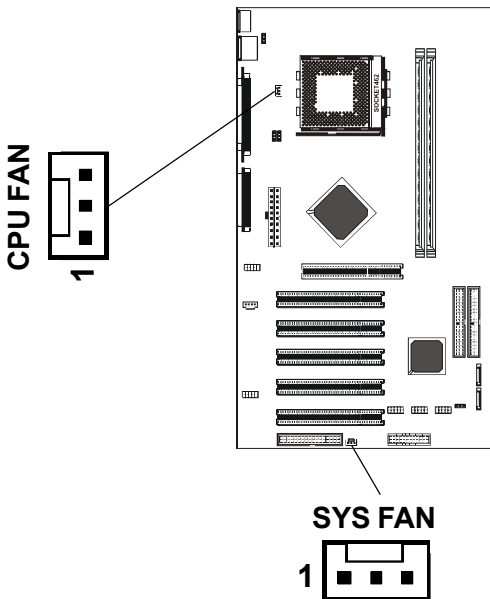

CD-IN Connector: CDS1

The connector is for CD-ROM Drive.

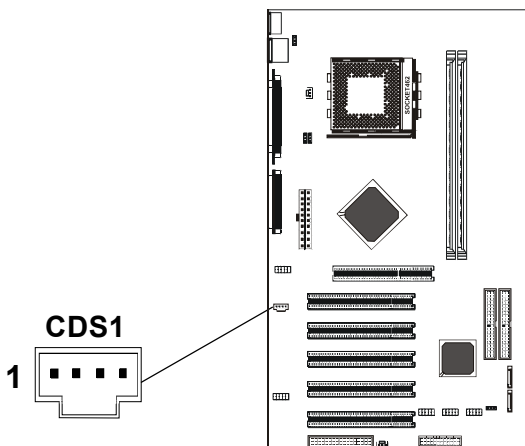

CDS1 : CD-IN

PIN	Assignment
1	CD-L
2	GND
3	GND
4	CD-R

Front Panel Audio Header: FPS1

This mainboard supports front panel microphone and speaker out ports. If your computer case has these ports, connect them to FPS1.

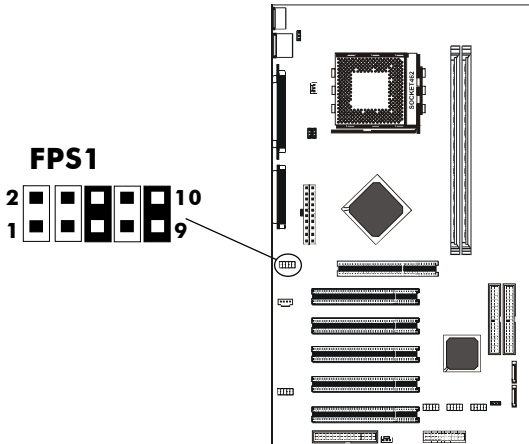

FPS1

PIN	Assignment
1	MIC
2	GND
3	REF
4	POWER
5	Front Audio(R)
6	Rear Audio(R)
7	Reserved
8	Key(No pin)
9	Front Audio(L)
10	Rear Audio(L)

Note:

If you want to use "Front Audio" connector, you must move 5,6,9,10 jumper. In order to utilize the front audio header, your chassis must have front audio connector. Also please make sure the pin assignment on the cable is the same as the pin assignment on the MB header. To find out if the chassis you are buying support front audio connector, please contract your dealer.

USB Connectors: USB2/USB3/USB4 (USB4 is optional)

This mainboard has USB ports. Some computer cases have a special module that mounts USB ports at the front of the case. If you have this kind of case, use auxiliary USB connector USB2/USB3/USB4(USB4 is for VT8237 only) to connect the front mounted ports to the mainboard.

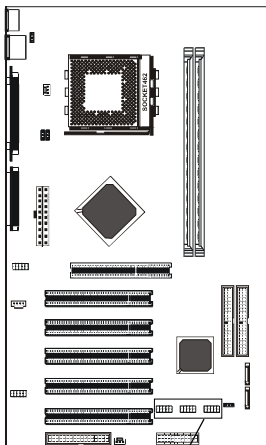

USB Connector

PIN	Assignment
1	VCC
2	VCC
3	USBP0-
4	USBP1-
5	USBP0+
6	USBP1+
7	GND
8	GND
9	KEY
10	OC#

Front Panel Header:FP1

The mainboard provides one front panel connector.

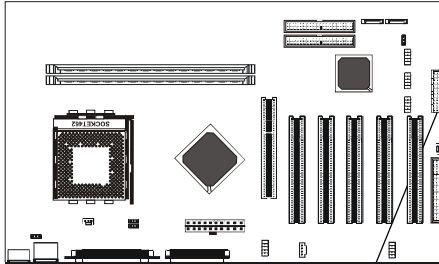

FP1

GND	24	■	■	23	VCC
KEYLOCK	22	■	■	21	GND
KEY	20	□	■	19	NC
KEY	18	□	■	17	SPEAKER
IRRX	16	■	■	15	IRTX
GND	14	■	■	13	VCC
KEY	12	□	■	11	NC
KEY	10	□	■	9	NC
GND	8	■	■	7	RESET
PWR_SW	6	■	■	5	GND
PW_LED-	4	■	■	3	HDD_LED-
PW_LED+	2	■	■	1	HDD_LED+

Jumper Setting

This chapter explains how to configure the motherboard's hardware. Before using your computer, make sure all jumpers and DRAM modules are set correctly. Refer to this chapter whenever in doubt.

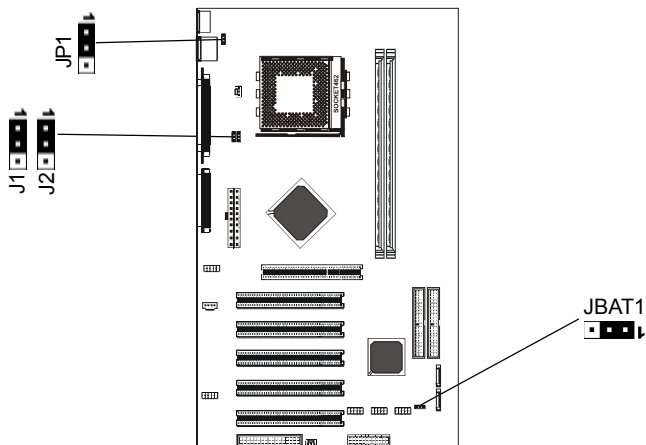

J1,J2-CPU Speed Select

J1	J2	CPU Speed
1 [●] [●] 2-3	1 [●] [●] 2-3	100MHz
1 [●] [●] 2-3	1 [□] [□] Open	133MHz
1 [□] [□] Open	1 [□] [□] Open	166MHz
1 [□] [□] Open	1 [●] [●] 2-3	200MHz
1 [●] [●] 1-2*	1 [●] [●] 1-2*	Auto*



NOTE: J1, J2 can't auto detect 100MHz CPU.

JBAT1 - Clear CMOS

JBAT1	Selection
1 [●] [●] 1-2*	Normal*
1 [●] [●] 2-3	CMOS Clear

JP1-Keyboard Power Select Jumper (optional)

JP1	Select
1 [●] [●] 1-2*	Powered by +5V*
1 [●] [●] 2-3	Powered by +5V Standby(Allows Keyboard Power On)

 Close
  Open
 * = Default setting.

Slots

The motherboard provides one AGP slot and five 32-bit PCI bus slots.

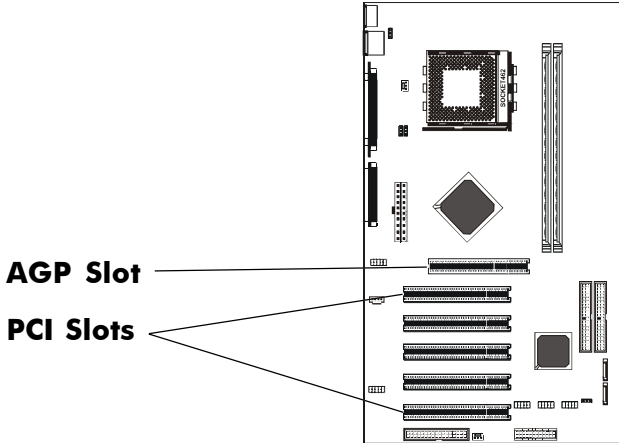

AGP (Accelerated Graphics Port) Slot

The AGP slot allows you to insert the AGP graphics card. AGP is an interface specification designed for the throughput demands of 3D graphics. It introduces a 66MHz, 32-bit channel for the graphics controller.

PCI (Peripheral Component Interconnect) Slots

The PCI slots allow you to insert the expansion cards to meet your needs. When adding or removing expansion cards, make sure that you unplug the power supply first. Meanwhile, read the documentation for the expansion card to make any necessary hardware or software settings for the expansion card, such as jumpers, switches or BIOS configuration.

CPU Installation

Please refer to the following steps to install the CPU.

1. Please turn off the power and unplug the power cord before installing the CPU. Pull the lever sideways away from the socket. Make sure to raise the lever up to a 90 degree angle.

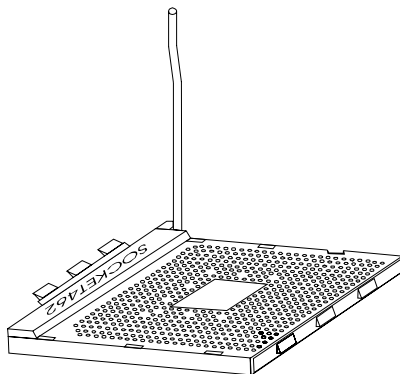

2. Look for the gold arrow. The gold arrow should point towards the lever pivot. The CPU can only fit in the correct orientation.

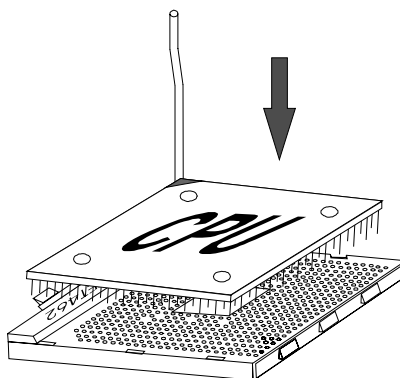

3. If the CPU is correctly installed, the pins should be completely embedded into the socket and can not be seen. Please note that any violation of the correct installation procedures may cause permanent damages to your mainboard.

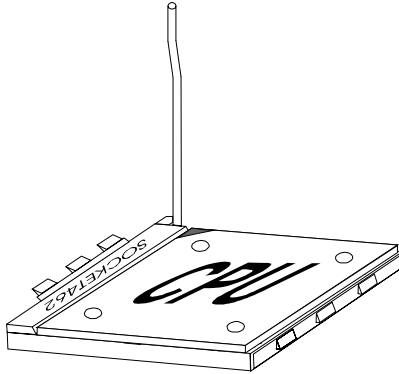

4. Press the CPU down firmly into the socket and close the lever. As the CPU is likely to move while the lever is being closed, always close the lever with your fingers pressing tightly on top of the CPU to make sure the CPU is properly and completely embedded into the socket.

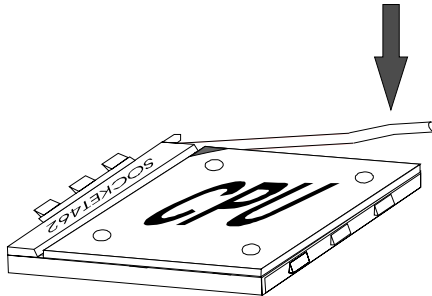

5. Position the CPU cooler set onto the CPU. Use one end of the clip to hook the latch of the CPU sliding plate.

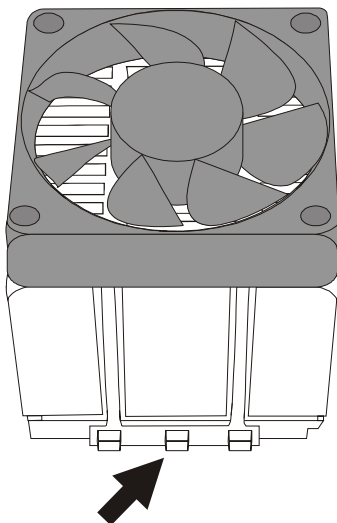

6. And then hook the other latch to fix the cooling fan set.

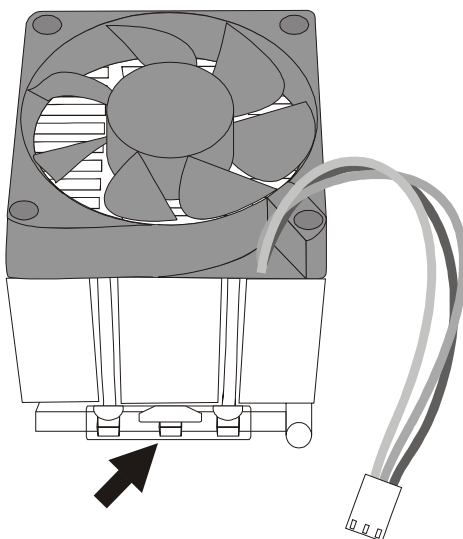

7. At last, connect the fan to the power supply connector provided on your mainboard.

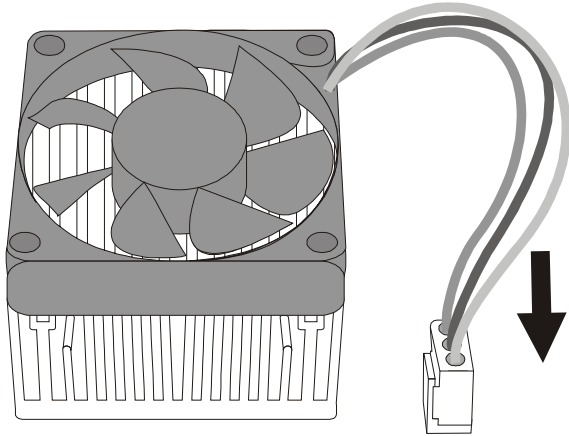

Install DDR DIMMs

Please follow the following step to install DDR DIMMs.

1. Locate the DDR DIMM sockets.
2. Holding the DDR DIMM by the edges, remove it from its antistatic package.
3. Make sure the clips at either end of the socket are pushed away from the socket.

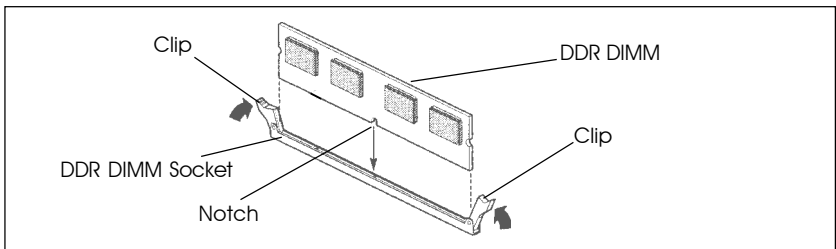

4. Position the DDR DIMM above the socket. Align the two small notches in the bottom edge of the DDR DIMM with the keys in the socket.
5. Insert the bottom edge of the DDR DIMM into the socket.
6. When the DDR DIMM is seated, push down on the top edge of the DDR DIMM until the retaining clips at the ends of the socket snap into place. Make sure the clips are firmly in place.



Please turn off system before installing and removing any device, otherwise you'll cause the system damage.

BIOS Setup

This chapter discusses Award's Setup Program built into the ROM BIOS. The Setup Program allows users to modify the basic system configuration. This special information is then stored in battery-backed RAM, which retains the setup information when the power is turned off.

Starting Setup

The Award BIOS is immediately activated when you turn on the computer. The BIOS reads the system information contained in the CMOS and begins the process of checking out the system and configuring it. When it finishes, the BIOS will seek an operating system on one of the disks and then launch and turn control over to the operating system.

While the BIOS is in control, the Setup Program can be activated :

1. By pressing immediately after switching the system on, or
2. By pressing the key when the following message appears briefly at the bottom of the screen during the POST (Power On Self Test)

Press DEL to enter SETUP

If the message disappears before you can respond and you still wish to enter Setup, restart the system to try again by turning it OFF then ON or pressing the "RESET" button on the system case. You may also restart by simultaneously pressing the <Ctrl>, <Alt>, and <Delete> keys. If you do not press the keys at the correct time and the system does not reset, an error message will be displayed and you will again be asked to ...

PRESS F1 TO CONTINUE, DEL TO ENTER SETUP

Getting Help

Press F1 to pop up a small help window that describes the appropriate keys to use and the possible selections for the highlighted item. To exit the Help Window press <Esc> or the F1 key again.

In Case of Problems

If, after making and saving system changes with the Setup Program, you discover that your computer does not reset, use the Award BIOS defaults to override the CMOS settings.

Main Menu

Once you enter the Award BIOS CMOS Setup Utility, the Main Menu will appear on the screen. The Main Menu allows you to select from various setup functions and two exit choices. Use the arrow keys to select among the items and press <Enter> to accept and enter the sub-menu.

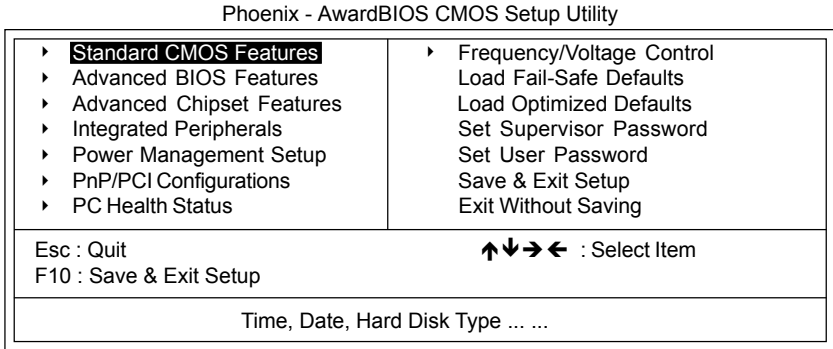

(Note : The figures of BIOS Setup Menu included here only show a typical case, and may not be exactly the same as the one on your unit.)

Note that a brief description of each highlighted item will appear at the bottom of the screen.

Standard CMOS Features This setup page includes all the items of Award™ special standard features.

Advanced BIOS Features This setup page includes all the items of Award™ special enhanced features.

Advanced Chipset Features This setup page includes all the items of chipset special features.

Integrated Peripherals This section page includes all the items of IDE hard drive and Programmed Input / Output features.

Power Management Setup This entry only appears if your system supports Power Management “Green PC” standards.

PNP/PCI Configurations This entry appears if your system supports PNP/PCI.

PC Health Status Display CPU and Case Fan Speed etc.

Frequency/Voltage Control CPU speed setting are settings of CPU speed. You should refer to your CPU marking.

Load Fail-Safe Defaults The BIOS defaults have been set by the manufacturer and represent settings which provide the minimum requirements for your system to operate.

Load Optimized Defaults The chipset defaults are settings which provide for maximum system performance. While Award has designed the custom BIOS to maximize performance, the manufacturer has the right to change these defaults to meet its needs.

Set Supervisor/ User Password Changes, sets, or disables password. It allows you to limit access to the system and the Setup Program.

Save & Exit Setup Saves value changes to CMOS and exits setup.

Exit Without Saving Abandons all CMOS value changes and exits setup.

Standard CMOS Features

The items in Standard CMOS Setup Menu are divided into 10 categories. Each category includes one or more setup items. Use the arrow keys to highlight the item and then use the <PgUp> or <PgDn> key to select the desired value in each item.

Phoenix - AwardBIOS CMOS Setup Utility Standard CMOS Features

Date (mm :d :yy)	Time (h h :mm:ss)	Item Help
Thu. Jan 01 2004	11 : 1 : 35	
▶ IDE Channel 0 Master	[Press Enter 4303 MB]	Menu Level ▶
▶ IDE Channel 0 Slave	[None]	Change the day, month, year and century
▶ IDE Channel 1 Master	[None]	
▶ IDE Channel 1 Slave	[None]	
▶ IDE Channel 2 Master	[None]	
▶ IDE Channel 3 Master	[None]	
Drive A	[1.44M, 3.5 in.]	
Drive B	[None]	
Video	[EGA/VGA]	
Halt on	[All, but keyboard]	
Base Memory	640K	
Extended Memory	30720K	
Total Memory	31744K	

↑↓→←Move Enter: Select +/-/PU/PD : Value F10 : Save ESC : Exit F1 :General Help
F5 : Previous Values F6 : Fail-Safe Defaults F7 : Optimized Defaults

(Note : The figures of BIOS Setup Menu included here only show a typical case, and may not be exactly the same as the one on your unit.)

Date	The date format is <day-of-the-week>. <month> <day> <year>.
Time	The time format is <hour> <Minute> <second> displayed in 24-hour military-time clock. For example, 1 p. m. is displayed as 13:00:00.
IDE Channel 0/1/2/3	These categories identify the types of the four channels that have been installed in the computer. If the controller of the HDD interface is SCSI, the selection shall be "None".
Drive A Type / Drive B Type	This category identifies the types of floppy disk drive A or drive B that has been installed in the computer.
Video	The default setting is EGA/VGA.
Halt on	You can select which type of error will cause the system to halt.

Advanced BIOS Features

This section allows you to configure your system for basic operation. You have the opportunity to select the system's default speed, boot-up sequence, keyboard operation, shadowing and security.

Advanced Chipset Features

The Chipset Features Setup option is used to change the values of the chipset registers. These registers control most of the system options in the computer.

This section allows you to configure the system based on the specific features of the installed chipset. This chipset manages bus speeds and access to system memory resources, such as DRAM and the external cache. It must be stated that these items should not be altered. The default settings have been chosen because they provide the best operating conditions for your system.

Integrated Peripherals

The Integrated Peripherals Setup allows the user to configure the onboard IDE controller, floppy disk controller, the printer port and the serial ports.

Power Management Setup

The Power Management Setup Menu allows you to configure your system to most save energy while operating in a manner consistent with your own style of computer use.

PNP/PCI Configurations

This section describes how to configure the PCI bus system. This section covers some very technical items and it is recommended that only experienced users should make any changes to the default settings.

PC Health Status

The PC Health Status display CPU and Case Fan Speed.

Frequency/Voltage Control

This section allows you to set CPU Speed.

Set Supervisor/User Password

You can set either supervisor or user password, or both of them. The difference between them are:

- Supervisor Password :** You can enter the Setup Program and change the options of the setup menus.
- User Password :** You can enter the Setup Program but can not change the options of the setup menus.

When you select this function, the following message will appear at the center of the screen to assist you in creating a password.

ENTER PASSWORD:

Type the password, up to eight characters in length, and press<Enter>. The new password will clear the previously entered password from the CMOS memory. You will be asked to confirm the password. Type the password again and press <Enter>. You may also press <Esc> to abort the selection and operate without a password.

To disable a password, just press <Enter> when you are prompted to enter the password. A message will be displayed to confirm that the password is disabled.

PASSWORD DISABLED.

Once the password is disabled, the system will reset and you can enter the Setup Program freely.

When a password is enabled, you will be prompted to enter it every time you try to enter setup. This prevents an unauthorized person from changing any setting of your system configuration.

In addition, when a password is enabled, you can require the BIOS to request a password every time your system is rebooted. This would further prevent unauthorized use of your computer.

The password requirement is defined by the Security Option of the BIOS Features Setup Menu. If the Security Option is set to "System", the password will be required both at resetting and at entering setup. If the option is set to "Setup", the prompt only appears when you try to enter setup.

Flash Update Procedure

A program AWDFLASH.EXE is included in the utility diskette or CD (X:\Utility\AWDFLASH.EXE). The user is recommended to follow the procedure below to update the flash BIOS.

(X: your CD driver letter).

1. Create a DOS-bootable floppy diskette. Copy the new BIOS file (just obtained or downloaded) and the utility program AWDFLASH.EXE to the diskette.
2. Allow the PC system to boot from the DOS diskette.
3. At the DOS prompt, key in

AWDFLASH
and hit <ENTER>

4. Enter the file name of the new BIOS.
5. The question: "Do you want to save BIOS (Y/N)?" is displayed.

***Key in "N" if there is no need to save the existing BIOS content.
Key in "Y" if a backup copy of the existing BIOS is needed.
(A file name has to be assigned to the existing BIOS binary file.)***

6. The question : "Press "Y" to program or "N" to exit" is displayed.

Key in "Y"

7. Wait until the flash-update is completed.
8. Power down the PC system.
9. Restart the PC.

Warning:

DO not turn off or RESET the computer during the flash process.
If you are unsure how to upgrade the BIOS, it is best to take your computer to an Authorized Service Center and have a trained technician do the work for you.

VT8237 SATA RAID User Manual

Enter BIOS Configuration Utility

When the system powers on, the following information will appear on screen. Press the 'Tab' key to enter BIOS configuration utility.

```
VIA Technologies,Inc.VIA Serial ATA RAID BIOS Setting Utility v1.00
Copyright (C) VIA Technologies,Inc.All Right reserved.
```

```
Scan Devices,Please wait . . .
Press < Tab > Key into User Window!
Channel 0 Master: IC35L040AVVA07-0
Channel 1 Master: IC35L040AVVA07-0
```

The main interface of BIOS configuration utility is as below:

VIA Tech. RAID BIOS Ver 1.00						
<ul style="list-style-type: none"> ▶ Create Array ▶ Delete Array ▶ Create/Delete Spare ▶ Select Boot Array ▶ Serial Number View 		Create a RAID array with the hard disks attached to VIA IDE controller F1 : View Array/disk Status ↑↓ : Move to next item Enter : Confirm the selection ESC : Exit				
Channel	Master	Drive Name	Array Name	Mode	Size(GB)	Status
Channel0	Master	IC35L040AVVA07-0		ATA 100	38.34	Hdd
Channel1	Master	IC35L040AVVA07-0		ATA 100	38.34	Hdd

Create Disk Array

1. Use the arrow keys to navigate the main menu. Use the up and down arrow keys to select the **Create Array** command and press <Enter> to call out the list of creation steps.

VIA Tech. RAID BIOS Ver 1.00

<ul style="list-style-type: none"> ▶ Auto Setup For Data Security ▶ Array Mode RAID 1 (Mirroring) ▶ Select Disk Drives ▶ Start Create Process 	<p>Create a RAID array with the hard disks attached to VIA IDE controller</p> <p>F1 : View Array/disk Status ↑↓ : Move to next item Enter : Confirm the selection ESC : Exit</p>																		
<table border="1" style="width: 100%; border-collapse: collapse;"> <thead> <tr> <th>Channel</th> <th>Drive Name</th> <th>Array Name</th> <th>Mode</th> <th>Size(GB)</th> <th>Status</th> </tr> </thead> <tbody> <tr> <td>Channel0</td> <td>Master</td> <td>IC35L040AVVA07-0</td> <td>ATA 100</td> <td>38.34</td> <td>Hdd</td> </tr> <tr> <td>Channel1</td> <td>Master</td> <td>IC35L040AVVA07-0</td> <td>ATA 100</td> <td>38.34</td> <td>Hdd</td> </tr> </tbody> </table>		Channel	Drive Name	Array Name	Mode	Size(GB)	Status	Channel0	Master	IC35L040AVVA07-0	ATA 100	38.34	Hdd	Channel1	Master	IC35L040AVVA07-0	ATA 100	38.34	Hdd
Channel	Drive Name	Array Name	Mode	Size(GB)	Status														
Channel0	Master	IC35L040AVVA07-0	ATA 100	38.34	Hdd														
Channel1	Master	IC35L040AVVA07-0	ATA 100	38.34	Hdd														

2. Highlight the **Array Mode** and press <Enter>, then a list of array modes will appear. Just highlight the target array mode that you want to create, and press <Enter> to confirm the selection.

VIA Tech. RAID BIOS Ver 1.00

<ul style="list-style-type: none"> ▶ RAID 0 for performance ▶ RAID 1 for data protection ▶ RAID SPAN for capacity 	<p>Create a RAID array with the hard disks attached to VIA IDE controller</p> <p>F1 : View Array/disk Status ↑↓ : Move to next item Enter : Confirm the selection ESC : Exit</p>																		
<table border="1" style="width: 100%; border-collapse: collapse;"> <thead> <tr> <th>Channel</th> <th>Drive Name</th> <th>Array Name</th> <th>Mode</th> <th>Size(GB)</th> <th>Status</th> </tr> </thead> <tbody> <tr> <td>Channel0</td> <td>Master</td> <td>IC35L040AVVA07-0</td> <td>ATA 100</td> <td>38.34</td> <td>Hdd</td> </tr> <tr> <td>Channel1</td> <td>Master</td> <td>IC35L040AVVA07-0</td> <td>ATA 100</td> <td>38.34</td> <td>Hdd</td> </tr> </tbody> </table>		Channel	Drive Name	Array Name	Mode	Size(GB)	Status	Channel0	Master	IC35L040AVVA07-0	ATA 100	38.34	Hdd	Channel1	Master	IC35L040AVVA07-0	ATA 100	38.34	Hdd
Channel	Drive Name	Array Name	Mode	Size(GB)	Status														
Channel0	Master	IC35L040AVVA07-0	ATA 100	38.34	Hdd														
Channel1	Master	IC35L040AVVA07-0	ATA 100	38.34	Hdd														

3. After selected array mode, there are two methods to create a disk array. One method is “**Auto Setup**” another is “**Select Disk Drives**”. **Auto Setup** let BIOS select the disk drives and create array automatically. **Select Disk Drives** let user select the array drives by required. When using **Select Disk Drives** method, the channel column will be activated. Just highlight the target drives that you want to use and press <Enter> to select them respectively. After all drives have been selected, press <Esc> to go back to the creation steps menu.

VIA Tech. RAID BIOS Ver 1.00

<ul style="list-style-type: none"> ▶ Auto Setup For Performance ▶ Array Mode RAID 0 (Striping) ▶ Select Disk Drives ▶ Block Size 64K ▶ Start Create Process 	<p>Create a RAID array with the hard disks attached to VIA IDE controller</p> <p>F1 : View Array/disk Status ↑↓ : Move to next item Enter : Confirm the selection ESC : Exit</p>
--	---

Channel	Drive Name	Array Name	Mode	Size(GB)	Status
[*]Channel0 Master	IC35L040AVVA07-0		ATA 100	38.34	Stripe0
[]Channel1 Master	IC35L040AVVA07-0		ATA 100	38.34	Hdd

4. If user selected a RAID 0 array in step 2, user also can select a block size for the array. Use the arrow key to highlight the Block Size and press <Enter>, then select a block size from will popup. The block size can be selected from 4K to 64K Bytes.

VIA Tech. RAID BIOS Ver 1.00

<ul style="list-style-type: none"> ▶ Auto Setup For ▶ Array Mode RAID ▶ Select Disk Dri ▶ Block Size 64K ▶ Start Create Pr 	<div style="border: 1px solid black; padding: 5px; text-align: center;"> <p>4K</p> <p>8K</p> <p>16K</p> <p>32K</p> <p>64K</p> </div>	<p>Create a RAID array with the hard disks attached to VIA IDE controller</p> <p>F1 : View Array/disk Status ↑↓ : Move to next item Enter : Confirm the selection ESC : Exit</p>
---	--	---

Channel	Drive Name	Array Name	Mode	Size(GB)	Status
[*]Channel0 Master	IC35L040AVVA07-0		ATA 100	38.34	Stripe0
[*]Channel1 Master	IC35L040AVVA07-0		ATA 100	38.34	Stripe1

5. Use the arrow key to highlight **Start Create Process** and press <Enter>. A warning message will appear, press **Y** to finish the creation, or press **N** to cancel the creation.
6. Please note that all existing content in the hard drive will be destroyed after the array creation.

Delete Disk Array

A specific RAID can be deleted after it has been created. To delete a created RAID, please use the following steps:

1. Select **Delete Array** in the main menu and press <Enter>. The channel column will be activated.
2. Select the member of an array that is to be deleted and press <Enter>. A warning message will show up, press **Y** to delete or press **N** to cancel.

VIA Tech. RAID BIOS Ver 1.00

<ul style="list-style-type: none"> ▶ Create Array ▶ Delete Array ▶ Create/Delete Spare ▶ Select Boot Array ▶ Serial Number View <p style="margin-top: 10px;">The selected array will be destroyed Are you sure? Continue? Press Y/N</p>	<p>Delete a RAID array contain the hard disks attached to VIA IDE controller</p> <p>F1 : View Array/disk Status ↑↓ : Move to next item Enter : Confirm the selection ESC : Exit</p>
--	--

Channel	Drive Name	Array Name	Mode	Size(GB)	Status
[*] Channel0 Master	IC35L040AVVA07-0	ARRAY 0	ATA	100 38.34	Stripe0
[*] Channel1 Master	IC35L040AVVA07-0	ARRAY 0	ATA	100 38.34	Stripe1

Deleting a disk array will destroy all the data on the disk array except RAID 1 arrays. When a RAID 1 is deleted, the data on these two hard disk drives will be reserved and become two normal disk drives.

Select Boot Array

User can select a disk array as boot device if user wants to boot operating system from an array. Boot disk array can be not selected if user does not boot operating system from disk array. Use the arrow key to highlight the Select Boot Disk item then press <Enter>. The channel column will be activated. Just use arrow key to highlight the target disk array then press <Enter>. If user select a disk array that has a boot mark and press <Enter>, then its boot setting will be canceled.

VIA Tech. RAID BIOS Ver 1.00

<ul style="list-style-type: none"> ▶ Create Array ▶ Delete Array ▶ Create/Delete Spare ▶ Select Boot Array ▶ Serial Number View 	<p style="text-align: center;">Sct/Clear bootable array</p> <p>F1 : View Array/disk Status ↑↓ : Move to next item Enter : Confirm the selection ESC : Exit</p>																		
<table border="1" style="width: 100%; border-collapse: collapse;"> <thead> <tr> <th style="text-align: left;">Channel</th> <th style="text-align: left;">Drive Name</th> <th style="text-align: left;">Array Name</th> <th style="text-align: left;">Mode</th> <th style="text-align: left;">Size(GB)</th> <th style="text-align: left;">Status</th> </tr> </thead> <tbody> <tr> <td>[*] Channel0 Master</td> <td>IC35L040AVVA07-0</td> <td>ARRAY 0</td> <td>ATA 100</td> <td>38.34</td> <td>Boot</td> </tr> <tr> <td>[*] Channel1 Master</td> <td>IC35L040AVVA07-0</td> <td>ARRAY 0</td> <td>ATA 100</td> <td>38.34</td> <td>Boot</td> </tr> </tbody> </table>		Channel	Drive Name	Array Name	Mode	Size(GB)	Status	[*] Channel0 Master	IC35L040AVVA07-0	ARRAY 0	ATA 100	38.34	Boot	[*] Channel1 Master	IC35L040AVVA07-0	ARRAY 0	ATA 100	38.34	Boot
Channel	Drive Name	Array Name	Mode	Size(GB)	Status														
[*] Channel0 Master	IC35L040AVVA07-0	ARRAY 0	ATA 100	38.34	Boot														
[*] Channel1 Master	IC35L040AVVA07-0	ARRAY 0	ATA 100	38.34	Boot														

Duplicate Critical RAID 1 Array

When booting up the system, BIOS will detect if the RAID 1 array has any inconsistencies between user data and backup data. If BIOS detects any inconsistencies, the status of the disk array will be marked as critical, and BIOS will prompt the user to duplicate the RAID 1 in order to ensure the backup data consistency with the user data.

Critical RAID 1	Critical Status																		
<p style="text-align: center;">Duplicate now Continue to boot</p>	<p>the RAID 1 array needs to be duplicated to ensure data consistency.</p> <p>Fault Hdd Found: Channel 1 Device 0 Fault</p>																		
Remaining members of the failed array																			
<table border="1" style="width: 100%; border-collapse: collapse;"> <thead> <tr> <th style="text-align: left;">Channel</th> <th style="text-align: left;">Drive Name</th> <th style="text-align: left;">Array Name</th> <th style="text-align: left;">Mode</th> <th style="text-align: left;">Size(GB)</th> <th style="text-align: left;">Status</th> </tr> </thead> <tbody> <tr> <td>Channel1 Device0</td> <td>IC35L040AVVA07-0</td> <td>Array0</td> <td>ATA 100</td> <td>38.34</td> <td>Mirror</td> </tr> <tr> <td>Channel0 Device0</td> <td>IC35L040AVVA07-0</td> <td>Array0</td> <td>ATA 100</td> <td>38.34</td> <td>Source</td> </tr> </tbody> </table>		Channel	Drive Name	Array Name	Mode	Size(GB)	Status	Channel1 Device0	IC35L040AVVA07-0	Array0	ATA 100	38.34	Mirror	Channel0 Device0	IC35L040AVVA07-0	Array0	ATA 100	38.34	Source
Channel	Drive Name	Array Name	Mode	Size(GB)	Status														
Channel1 Device0	IC35L040AVVA07-0	Array0	ATA 100	38.34	Mirror														
Channel0 Device0	IC35L040AVVA07-0	Array0	ATA 100	38.34	Source														
<p>Note: 1) Press <ESC> to Exit. 2) After Execute, Press <TAB> immediately can into Utility Window!</p>																			

If user selects Continue to boot, it will enable duplicating the array after booting into OS.

Rebuild Broken RAID 1 Array

When booting up the system, BIOS will detect if any member disk drives of RAID has failed or is absent. If BIOS detects any disk drive failures or missing disk drives, the status of the array will be marked as broken.

If BIOS detects a broken RAID 1 array but there is a spare hard drive available for rebuilding the broken array, the spare hard drive will automatically become the mirroring drive. BIOS will show a main interface just like a duplicated RAID 1. Selecting **Continue to boot** enables the user to duplicate the array after booting into operating system.

Broken RAID 1		Critical Status			
<p>Power off and check the failed drive Destroy the Mirroring Relationship Choose replacement drive and rebuild Continue to boot</p>		<p>A disk member of a mirroring array has failed or is not responding. The array is stilling functional, but fault tolerance is disabled.</p>			
Remaining members of the failed array					
Channel	Drive Name	Array Name	Mode	Size(GB)	Status
Channel0	Device0	IC35L040AVVA07-0	Array0	ATA 100	38.34 Broken
<p>Note: 1) Press <ESC> to Exit. 2) After Execute, Press <TAB> immediately can into Utility Window!</p>					

1. Power off and Check the Failed Drive:

This item enables users to turn off the computer and replace the failed hard drive with a good one. If users' computer does not support APM, the computer would need to be turned off manually. After the replacement, users can boot into BIOS and select **3 Choose replacement drive and rebuild** to rebuild the broken array.

2. Destroy the Mirroring Relationship:

This item enables users to cancel the data mirroring relationship of the broken array. For broken RAID 1 array, the data on the surviving disk will remain after the destroy operation.

However, **Destroy the Mirroring Relationship** is not recommend because the data on the remaining disk will be lost when the hard drive is used to create another RAID 1 array.

3. Choose Replacement Drive and Rebuild:

This item enables users to select an already-connected hard drive to rebuild the broken array and replace the data to that particular hard drive. After choosing the item, the channel column will be activated.

Broken RAID 1					Critical Status	
Power off and check the failed drive Destroy the Mirroring Relationship Choose replacement drive and rebuild Continue to boot					The contents on the disk you have selected will be deleted.	
Remaining members of the failed array						
Channel	Drive Name	Array Name	Mode	Size(GB)	Status	
() Channel1	Device0	IC35L040AVVA07-0	ATA	100	38.34	Hdd
Note: 1) Press <ESC> to Exit. 2) After Execute, Press <TAB> immediately can into Utility Window!						

Highlight the target hard drive and press <Enter>, a warning message will appear. Press **Y** to use that hard drive to rebuild, or press **N** to cancel. Please note by selecting option **Y**, all the data on the selected hard drive will be destroyed.

4. Continue to boot:

This item enables BIOS to skip the problem and continue booting into OS.

DRIVER AND RAID SOFTWARE INSTALLATION

Microsoft Windows Driver Installation

1. After Windows has finished booting up, the system will automatically find the newly installed adapter and prompt the **Found New Hardware Wizard** window. Click **Cancel** to skip it.



2. Insert the bundled driver CD DISC into your CD-ROM drive, select “**Serial ATA RAID Driver**” installation bar on the dialogue Window to begin the driver and software installation.

3. Confirm the follow-up dialogue windows to finish the installation.



4. When installation is completed, click **Finish** to restart the system.



Install Operating System into SATA HDD of VT8237

Install Windows 98SE or Me

1. Make sure the HDD wanted for installing the OS is in the first hard disk drive (C:\).
2. Install OS.
3. Install driver after OS is installed.

Install Windows NT 4.0, 2000, XP

1. Insert the bundled driver CD DISC into CD-ROM (G:). Copy all files and directories of G:\VIA chipset\SATA_Raid\DriverDisk\SATA folder to a floppy disk. Make sure following directories and files are copied into floppy disk.

A:\

\Win2000

VIAsraid.inf

VIAsraid.sys

VIAsraid.cat

\Winnt40

VIAsraid.inf

VIAsraid.sys

\WinXP

VIAsraid.inf

VIAsraid.sys

VIAsraid.cat

Txtsetup.oem

VT8237

2. Install OS from CD-ROM.
3. Press "**F6**" when display "Press **F6** if you need to install a third party SCSI or RAID driver..."
4. Insert floppy disk.
5. Choose the OS device driver wanted for loading.
6. Install OS.
7. Install driver after OS is installed.

APPENDIX

Note to User:

The bundled driver CD attached an Auto-Run feature for all the drivers that the motherboard need. Please select the drivers that you want to install and click the button on the installation panel.