



Electronic Emission Notices

Federal Communications Commission (FCC) Statement

This equipment has been tested and found to comply with the limits for a Class B digital device, pursuant to Part 15 of FCC Rules. These limits are designed to provide reasonable protection against harmful interference in a residential installation. This equipment generates, uses and can radiate radio frequency energy and, if not installed and used in accordance with instructions contained in this manual, may cause harmful interference to radio and television communications. However, there is no guarantee that interference will not occur in a particular installation.

If this equipment does cause harmful interference to radio or television reception, which can be determined by turning the equipment off and on, the user is encouraged to try to correct the interference by one or more of the following measures:

- REORIENT OR RELOCATE THE RECEIVING ANTENNA
- INCREASE THE SEPARATION BETWEEN THE EQUIPMENT AND THE RECEIVER
- CONNECT THE EQUIPMENT INTO AN OUTLET ON A CIRCUIT DIFFERENT FROM THAT OF THE RECEIVER
- CONSULT THE DEALER OR AN EXPERIENCED AUDIO/TELEVISION TECHNICIAN

NOTE: Connecting this device to peripheral devices that do not comply with Class B requirements, or using an unshielded peripheral data cable, could also result in harmful interference to radio or television reception.

The user is cautioned that any changes or modifications not expressly approved by the party responsible for compliance could void the user's authority to operate this equipment.

To ensure that the use of this product does not contribute to interference, it is necessary to use shielded I/O cables.

Copyright

This manual is copyrighted with all rights reserved. No portion of this manual may be copied or reproduced by any means.

While every precaution has been taken in the preparation of this manual, no responsibility for errors or omissions is assumed. Neither is any liability assumed for damages resulting from the use of the information contained herein.

Trademarks

All brand names, logos and registered trademarks mentioned are property of their respective owners.

Table of Contents

HARDWARE CONFIGURATION	4
Key Features	4
MOTHERBOARD LAYOUT	6
REAR PANEL	7
CONNECTORS	9
Floppy Disk Drive Connector:CN3	9
Hard Disk Connectors:IDE1&IDE2	9
S-Bracket (SPDIF)/LEN/LFE/Surround Output Connector: CN63(optional).....	10
Fan Power Connectors: CPUFAN/SYSFAN/WOL.....	12
CD-IN Connector:CDS1	13
AUX-IN Connector:AUX1	13
Front Panel Audio Header:J10	14
USB Connectors:USB2/USB3	15
Front Panel Headers:FP1	16
JUMPER SETTING	17
JBAT1 - CMOS Clear	17
JP1 - CPU Frequency Select	17

SLOTS	18
CPU INSTALLATION	19
INSTALL DDR DIMMs	22
BIOS SETUP	23
Starting Setup	23
Main Menu	24
Standard CMOS Features	25
Advanced BIOS Features	26
Advanced Chipset Features	26
Integrated Peripherals	26
Power Management Setup	26
PNP/PCI Configurations	26
PC Health Status	26
Frequency/Voltage Control	26
Set Supervisor/User Password	27
Flash Update Procedure	28
APPENDIX	28

HARDWARE CONFIGURATION

Key Features :

Chipset

- VIA P4X400 chipset.

Processor

- Support Intel® Pentium® 4 processors and the Northwood processors in the 478-pin package.
- Support Intel® Pentium® 4 processors system bus at 533/400MHz.

VRM 9.0 (Voltage Regulator Modules) on Board

- Flexible motherboard design with on board VRM 9.0.

System Memory

- A total of two 184-pin DDR SDRAM sockets.
- Support up to 2GB DRAMs for register and unbuffered DDR SDRAM module.
- Support PC2700/PC2100/PC1600 DDR SDRAM.
- 2.5V DRAM interface for DDR SDRAM.

System BIOS

- PnP, APM, ATAPI and Windows® 98/2000/XP.
- Full support of ACPI & DMI.
- Auto detects and supports LBA harddisks with capacities over 8.4GB.
- Easy to upgrade BIOS by end-user.

On-board I/O

- On board two PCI fast IDE ports supporting up to 4 ATA, ATA2 , Ultra ATA33/66/100/133 IDE HDDs, CD-ROMs, ZIP drives and LS-120 drives as boot drive.
- One ECP/EPP parallel port.
- Two 16550 Compatible UART serial ports.
- One floppy port supports two FDD of 360KB, 720KB, 1.2MB , 1.44MB and 2.88MB capacity.
- Six USB ports (four ports via two headers) (USB 2.0).
- PS/2 keyboard connector.
- PS/2 mouse is supported.
- One Front Panel Sound Connector.
- Infrared (IrDA) is supported via a header.

Plug-and-Play

- Supports Plug and Play specification 1.1.
- Plug and Play for Windows® 98/2000 as well as Windows® XP.
- Fully steerable PCI interrupts.

On-board VT6103 LAN (optional)

- The VT6103 is a physical Layer device for Ethernet 10 BASE-T and 100 BASE-TX using category 5 Unshielded, Type 1 shielded and Fiber Optic cables.
- Support LEDs for various network activity indications.

On-board AC97 Sound

- Integrated AC97 controller with standard AC97 Codec.
- Direct Sound and Sound Blaster compatible.
- Full-Duplex 16-bit record and play back.
- PnP and APM 1.2 support.
- Windows® 98/2000/XP drivers ready.
- Line-in, Line-out, Mic-in and MIDI/Game port.
- Supports ALC650 AC97 Code for six sound channel output (optional).

Power Management

- Supports SMM, APM and ACPI.
- Break switch for instant suspend/resume on system operations.
- Energy star “Green PC” compliant.
- Hardware monitoring circuit is supported, provide voltage, temperature, fan speed, etc. monitoring (optional).
- WOL (Wake-On-Lan) header support.
- External Modem Ring-in Wake-up support.
- Supports suspend-to-RAM(STR) (optional).

Expansion Slots

- 1 AGP slot (support AGP 3.0-8X).
- 4 PCI bus master slots - ver. 2.1 compliant.



Static electricity can harm delicate components of the motherboard. To prevent damage caused by static electricity, discharge the static electricity from your body before you touch any of the computers electronic components.

Motherboard Layout (35-AA05-X0-XX)

The following diagrams show the relative positions of the jumpers, connectors, major components and memory banks on the motherboard.

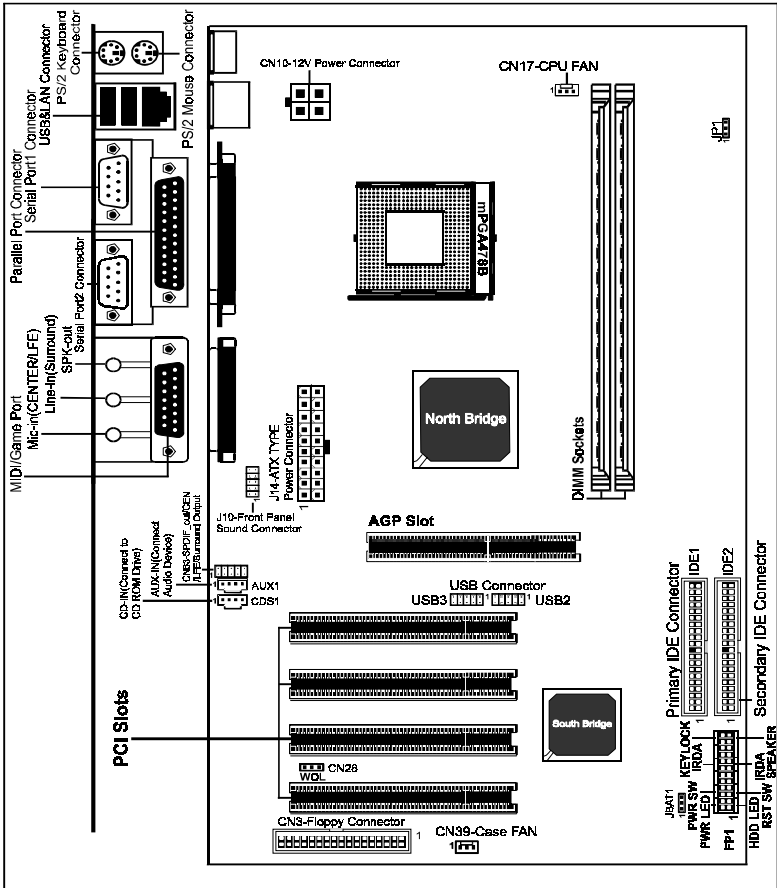

- # The LAN connector and CN63 are optional.
- # The ALC650 embeds an internal analog switch (by driver software) to share LINE input with Surround output, and share MIC input with CENTER/LFE output.

NOTE

- 1) Be sure to check the cable orientation in order to match the colored strip to the pin1 end of the connector.
- 2) When you start up the system, please wait for 5 seconds after you power on AC.
- 3) It is not recommended to add a metal spacer plate on the back of the Socket478. Otherwise, some components will be short and damaged.

Rear Panel

The back panel provides the following connectors:

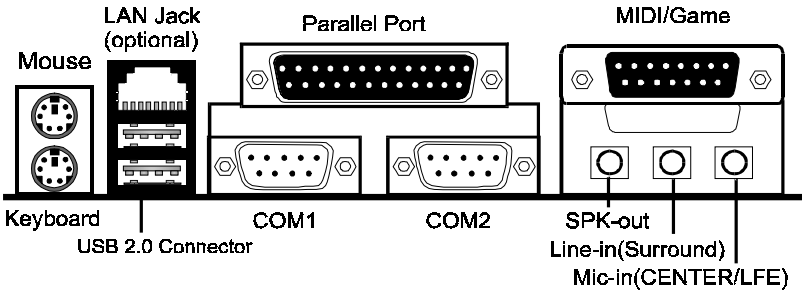

Mouse Connector

The mainboard provides a standard PS/2[®] mouse mini DIN connector for attaching a PS/2[®] mouse. You can plug a PS/2[®] mouse directly into this connector.

Keyboard Connector

The mainboard provides a standard PS/2[®] keyboard mini DIN connector for attaching a PS/2[®] keyboard. You can plug a PS/2[®] keyboard directly into this connector.

USB 2.0 Connector

The mainboard provides a UHCI (Universal Host Controller Interface) Universal Serial Bus root for attaching USB devices such as keyboard, mouse or other USB-compatible devices. You can plug the USB device directly into the connector.

USB 2.0 Connector

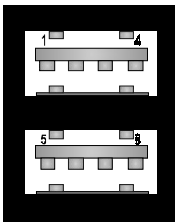

USB 2.0 Connector Description

PIN	SIGNAL	DESCRIPTION
1	VCC	+5V
2	-Data 0	Negative Data Channel 0
3	+Data0	Positive Data Channel 0
4	GND	Ground
5	VCC	+5V
6	-Data 1	Negative Data Channel 1
7	+Data 1	Positive Data Channel 1
8	GND	Ground

Serial Port Connector: COM1 & COM2

The Ports are 16550A high speed communication ports that send/receive 16bytes FIFOs. You can attach a serial mouse or other serial devices directly to the connectors.

LAN Jack (Optional)

The mainboard provides one standard jack for connection to Local Area Network(LAN). You can connect a network cable to the LAN jack.

Parallel Port Connector:LPT1

The mainboard provides a 25-pin female centronic connector as LPT. A parallel port is a standard printer port that supports Enhanced Parallel Port (EPP) and Extended Capabilities Parallel Port (ECP) mode.

MIDI/Game Connector

The mainboard provides the game port to connect a joystick or a MIDI device.

Audio Port Connector

SPK_Out is a connector for Speakers or Headphones. **Line In** is used for external CD player, Tape player, or other audio devices. **Mic In** is a connector for microphones. The ALC650 embeds an internal analog switch (by driver software) to share LINE input with Surround output, and share MIC input with CENTER/LFE output.

Connectors

The mainboard provides connectors to connect to FDD, IDE HDD, USB Ports and CPU/System FAN etc.

Floppy Disk Drive Connector:CN3

The mainboard provides a standard floppy disk drive connector that supports 360K, 720K, 1.2M, 1.44M and 2.88M floppy disk types.

Hard Disk Connectors:IDE1&IDE2

The mainboard has a 32-bit Enhanced PCI IDE and Ultra DMA 33/66/100/133 controller that provides PIO mode 0~4, Bus Master, and Ultra DMA 33/66/100/133 function. You can connect up to four hard disk drives, CD-ROM, 120MB Floppy (reserved for future BIOS) and other devices.

IDE1 (Primary IDE Connector)

The first hard drive should always be connected to IDE1. IDE1 can connect a Master and a Slave drive. You must configure second hard drive to Slave mode by setting the jumper accordingly.

IDE2 (Secondary IDE Connector)

IDE2 can also connect a Master and a Slave drive.

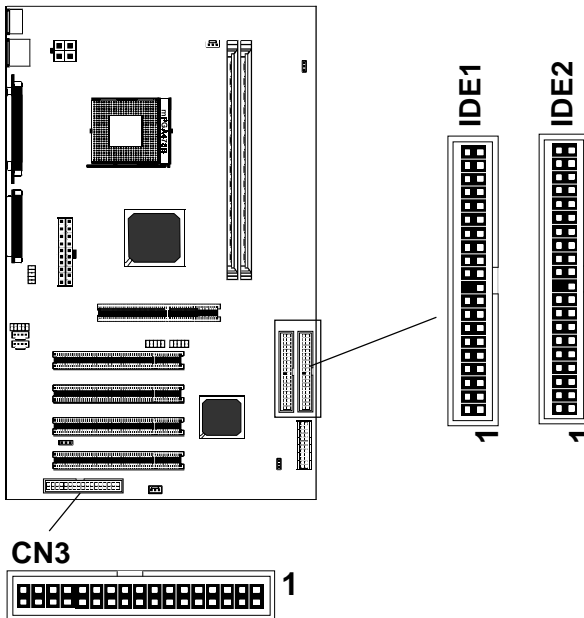

S-Bracket(SPDIF)/CEN/LFE/Surround Output Connector: CN63 (optional)

The connector allows you to connect a S-Bracket for a Digital Interface (SPDIF). The S-Bracket offers 1 SPDIF jacks for digital audio transmission and 2 analog Line-Out jacks for other 4-channel audio output. So you can use Line in, Mic in and 6 channel audio output features at the same time.

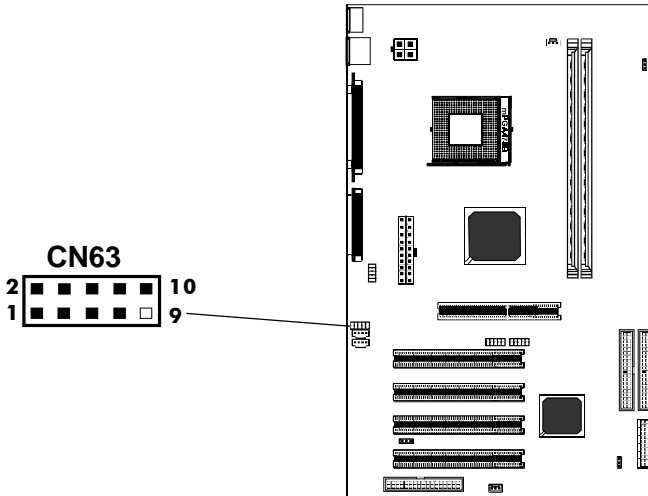

CN63-S-Bracket

PIN	SIGNAL	DESCRIPTION
1	SOUT-L	Audio left surrounding output
2	SOUT-R	Audio right surrounding output
3	GND	Ground
4	GND	Ground
5	CET-OUT	Audio center output
6	LFE-OUT	Audio bass output
7	GND	Ground
8	SPDIF	S/PDIF input
9	(No Pin)	Key
10	SPDFO	S/PDIF output

S-Bracket Cable (optional)

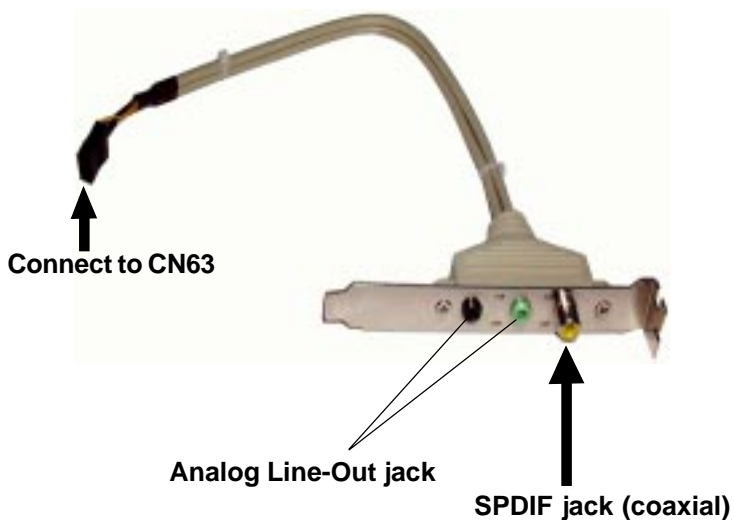

Fan Power Connectors:CPUFAN/SYSFAN

The CPUFAN (processor fan), SYSFAN (system fan) support system cooling fan with +12V.It supports three-pin head connector. When connecting the wire to the connectors, always take note that the red wire is the positive and should be connected to the +12V, the black wire is Ground and should be connected to GND. If the mainboard has a System Hardware Monitor chipset on-board, you must use a specially designed fan with speed sensor to take advantage of the CPU fan control.

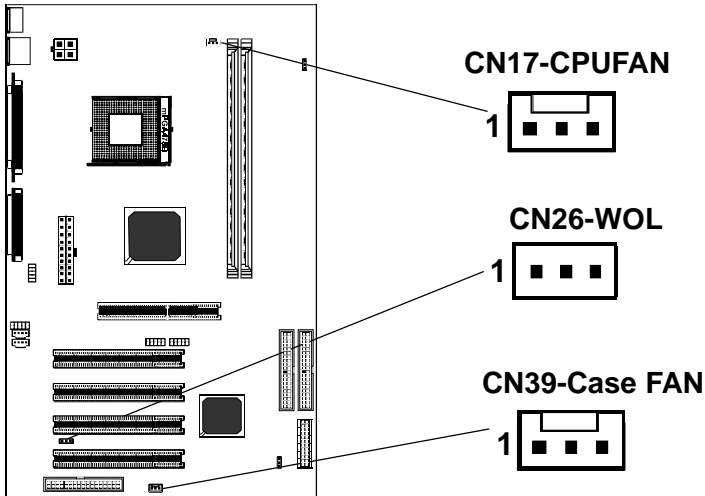

WOL: Wake On LAN

If you have installed a LAN card, use the cable provided with the card to plug into the mainboard WOL connector. This enables the Wake On LAN (WOL) feature. When your system is in a power-saving mode, any LAN signal automatically resumes the system. You must enable this item using the Power Management page of the Setup Utility.

CD-IN Connector:CDS1

The connector is for CD-ROM Drive.

AUX-IN Connector:AUX1

The connector is for Audio Device.

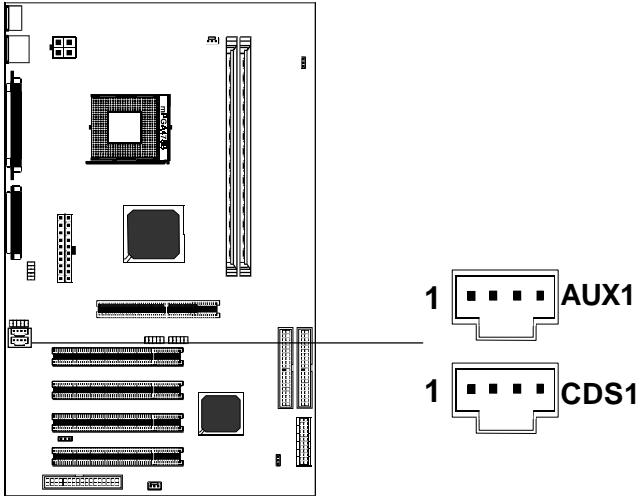

CDS1 : CD-IN

PIN	Assignment
1	CD-L
2	GND
3	GND
4	CD-R

AUX1 : AUX-IN

PIN	Assignment
1	AUX-L
2	GND
3	GND
4	AUX-R

Front Panel Audio Header: J10

This mainboard supports front panel microphone and speaker out ports. If your computer case has these ports, connect them to J10.

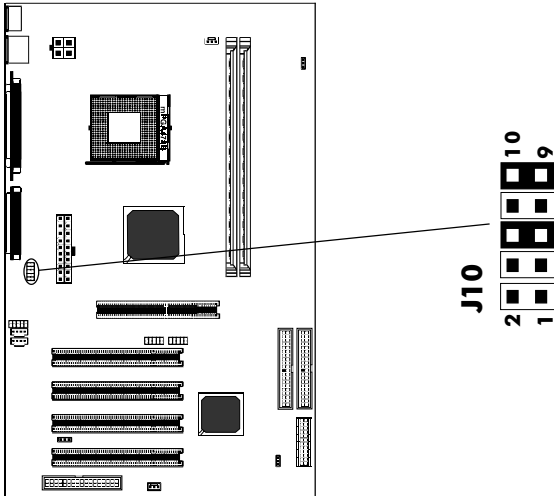

J10

PIN	Assignment
1	MIC
2	GND
3	REF
4	POWER
5	Front Audio(R)
6	Rear Audio(R)
7	Reserved
8	Key(No pin)
9	Front Audio(L)
10	Rear Audio(L)

Note:

If you want to use “Front Audio” connector, you must move 5,6,9,10 jumper. In order to utilize the front audio header, your chassis must have front audio connector. Also please make sure the pin assignment on the cable is the same as the pin assignment on the MB header. To find out if the chassis you are buying support front audio connector, please contract your dealer.

USB Connectors: USB2/USB3

This mainboard has USB ports. Some computer cases have a special module that mounts USB ports at the front of the case. If you have this kind of case, use auxiliary USB connector USB2/USB3 to connect the front mounted ports to the mainboard.

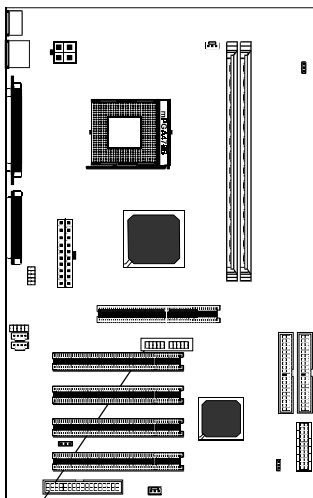

USB3

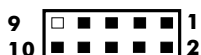

USB2

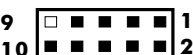

USB Connector

PIN	Assignment
1	VCC
2	VCC
3	USBP0-
4	USBP1-
5	USBP0+
6	USBP1+
7	GND
8	GND
9	KEY
10	OC#

Front Panel Header: FP1

The mainboard provides one front panel connector for electrical connect-on to the front panel switches and LEDs.

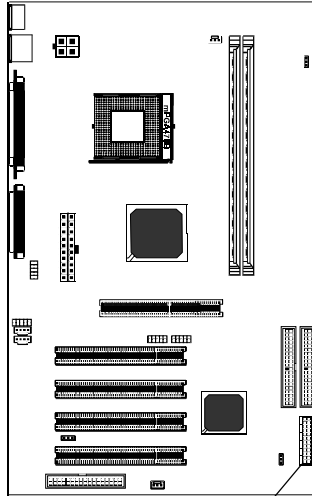

FP1

24	GND	23	VCC
22	KEYLOCK	21	GND
20	KEY	19	NC
18	KEY	17	SPEAKER
16	IRRX	15	IRTX
14	GND	13	VCC
12	KEY	11	NC
10	KEY	9	NC
8	GND	7	RESET
6	PWR_SW	5	GND
4	PW_LED-	3	HDD_LED-
2	PW_LED+	1	HDD_LED+

Jumper Setting

This chapter explains how to configure the motherboard's hardware. Before using your computer, make sure all jumpers and DRAM modules are set correctly. Refer to this chapter whenever in doubt.

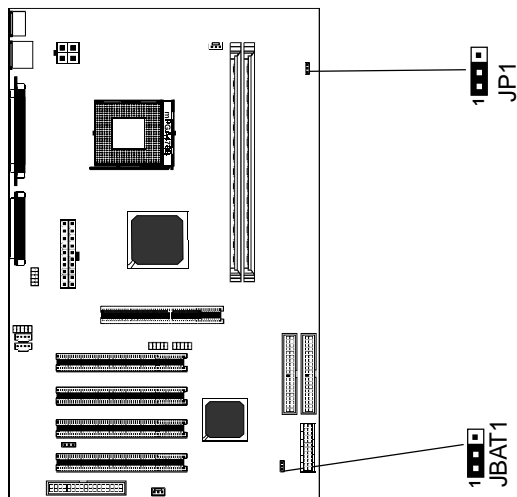

JBAT1 - CMOS Clear

JBAT1	Selection
1-2*	Normal*
2-3	CMOS Clear

JP1 - CPU Frequency Select

JP1	CPU Frequency (PSB)
1-2*	Auto*
2-3	400MHz
1 Open	533MHz



Close



Open

* = Default setting.

Slots

The motherboard provides one AGP slot, and four 32-bit PCI bus slots.

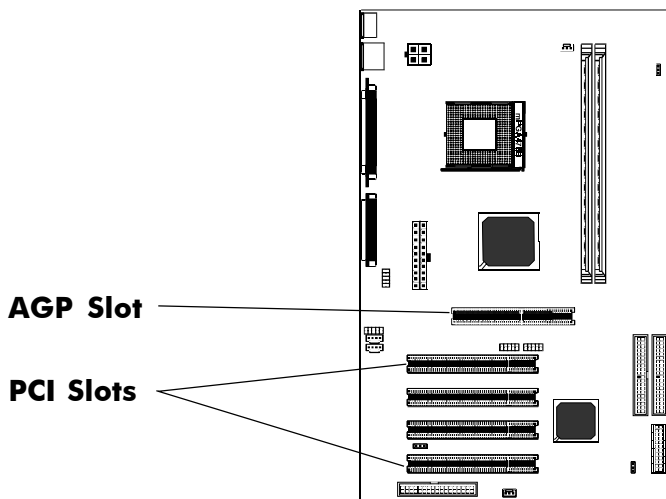

AGP (Accelerated Graphics Port) Slot

The AGP slot allows you to insert the AGP graphics card. AGP is an interface specification designed for the throughput demands of 3D graphics. It introduces a 66MHz, 32-bit channel for the graphics controller.

PCI (Peripheral Component Interconnect) Slots

The PCI slots allow you to insert the expansion cards to meet your needs. When adding or removing expansion cards, make sure that you unplug the power supply first. Meanwhile, read the documentation for the expansion card to make any necessary hardware or software settings for the expansion card, such as jumpers, switches or BIOS configuration.

CPU Installation

Please refer to the following steps to install the CPU.

1. Please turn off the power and unplug the power cord before installing the CPU. Pull the lever sideways away from the socket. Make sure to raise the lever up to a 90 degree angle.

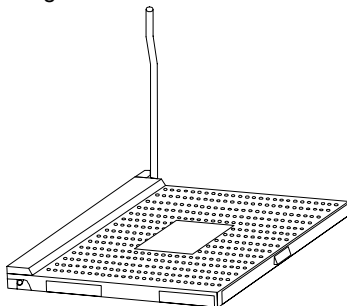

2. Look for the gold arrow. The gold arrow should point towards the lever pivot. The CPU can only fit in the correct orientation.

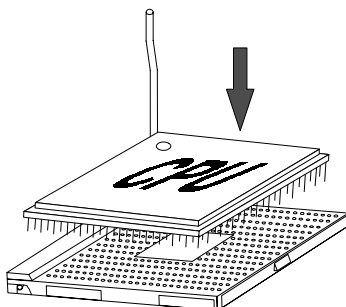

2. If the CPU is correctly installed, the pins should be completely embedded into the socket and can not be seen. Please note that any violation of the correct installation procedures may cause permanent damages to your mainboard.

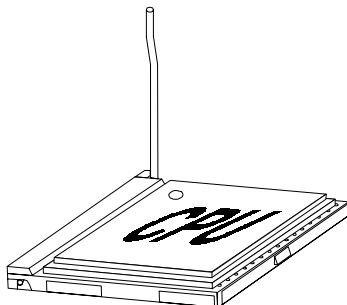

4. Press the CPU down firmly into the socket and close the lever. As the CPU is likely to move while the lever is being closed, always close the lever with your fingers pressing tightly on top of the CPU to make sure the CPU is properly and completely embedded into the socket.

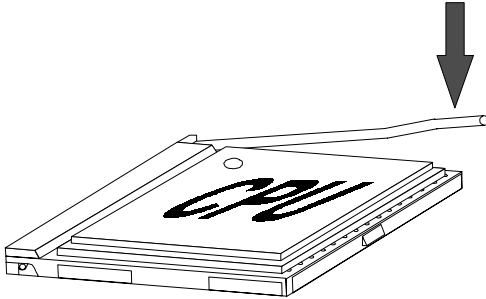

5. Position the CPU cooler set onto the CPU.

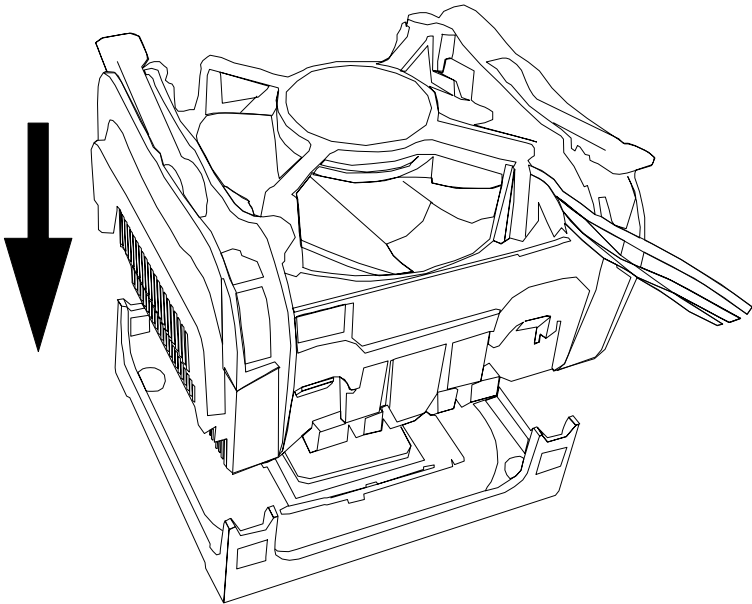

6. Use one end of the clip to hook the latch of the CPU sliding plate and then hook the other three latch to fix the cooling fan set. At last, connect the fan to the power supply connector provided on your mainboard.

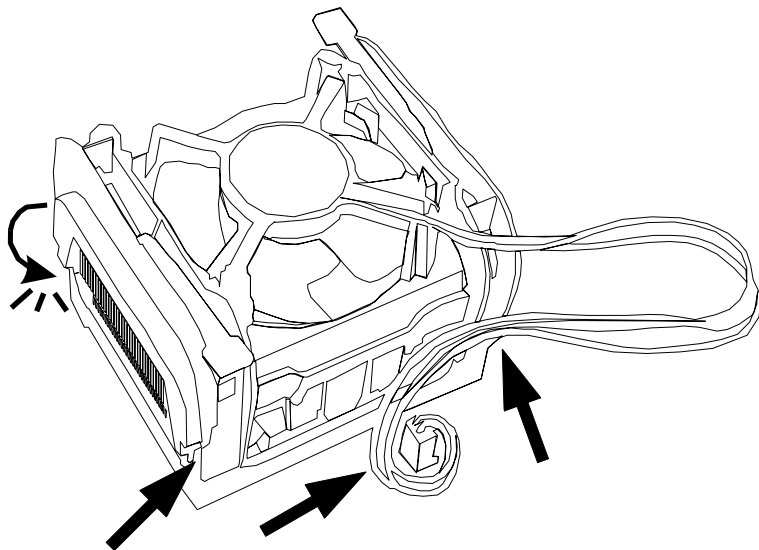

Install DDR DIMMs

Please follow the following step to install DDR DIMMs.

1. Locate the DDR DIMM sockets.
2. Holding the DDR DIMM by the edges, remove it from its antistatic package.
3. Make sure the clips at either end of the socket are pushed away from the socket.

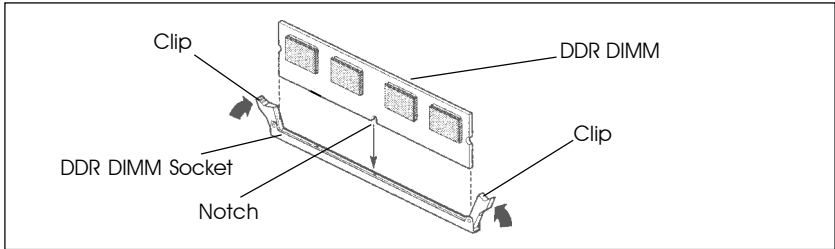

4. Position the DDR DIMM above the socket. Align the two small notches in the bottom edge of the DDR DIMM with the keys in the socket.
5. Insert the bottom edge of the DDR DIMM into the socket.
6. When the DDR DIMM is seated, push down on the top edge of the DDR DIMM until the retaining clips at the ends of the socket snap into place. Make sure the clips are firmly in place.



Please turn off system before installing and removing any device, otherwise you'll cause the system damage.

BIOS Setup

This chapter discusses Award's Setup Program built into the ROM BIOS. The Setup Program allows users to modify the basic system configuration. This special information is then stored in battery-backed RAM, which retains the setup information when the power is turned off.

Starting Setup

The Award BIOS is immediately activated when you turn on the computer. The BIOS reads the system information contained in the CMOS and begins the process of checking out the system and configuring it. When it finishes, the BIOS will seek an operating system on one of the disks and then launch and turn control over to the operating system.

While the BIOS is in control, the Setup Program can be activated :

1. By pressing immediately after switching the system on, or
2. By pressing the key when the following message appears briefly at the bottom of the screen during the POST (Power On Self Test)

Press DEL to enter SETUP

If the message disappears before you can respond and you still wish to enter Setup, restart the system to try again by turning it OFF then ON or pressing the "RESET" button on the system case. You may also restart by simultaneously pressing the <Ctrl>, <Alt>, and <Delete> keys. If you do not press the keys at the correct time and the system does not reset, an error message will be displayed and you will again be asked to ...

PRESS F1 TO CONTINUE, DEL TO ENTER SETUP

Getting Help

Press F1 to pop up a small help window that describes the appropriate keys to use and the possible selections for the highlighted item. To exit the Help Window press <Esc> or the F1 key again.

In Case of Problems

If, after making and saving system changes with the Setup Program, you discover that your computer does not reset, use the Award BIOS defaults to override the CMOS settings.

Main Menu

Once you enter the Award BIOS CMOS Setup Utility, the Main Menu will appear on the screen. The Main Menu allows you to select from various setup functions and two exit choices. Use the arrow keys to select among the items and press <Enter> to accept and enter the sub-menu.

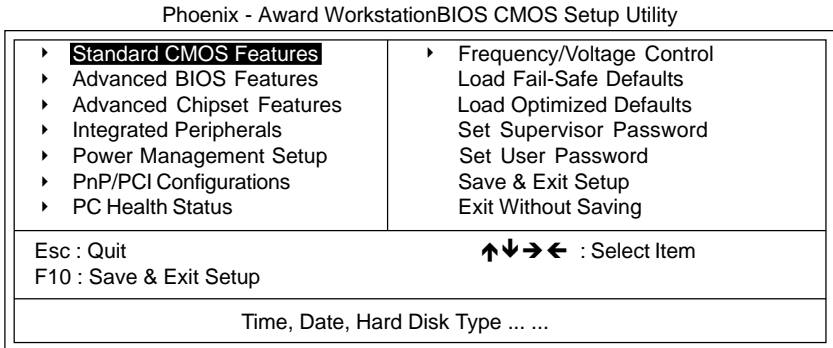

(Note : The figures of BIOS Setup Menu included here only show a typical case, and may not be exactly the same as the one on your unit.)

Note that a brief description of each highlighted item will appear at the bottom of the screen.

Standard CMOS Features This setup page includes all the items of Award™ special standard features.

Advanced BIOS Features This setup page includes all the items of Award™ special enhanced features.

Advanced Chipset Features This setup page includes all the items of chipset special features.

Integrated Peripherals This section page includes all the items of IDE hard drive and Programmed Input / Output features.

Power Management Setup This entry only appears if your system supports Power Management “Green PC” standards.

PNP/PCI Configurations This entry appears if your system supports PNP/PCI.

PC Health Status Display CPU and Case Fan Speed etc.

Frequency/Voltage Control CPU speed setting are settings of CPU speed. You should refer to your CPU marking.

Load Fail-Safe Defaults The BIOS defaults have been set by the manufacturer and represent settings which provide the minimum requirements for your system to operate.

Load Optimized Defaults The chipset defaults are settings which provide for maximum system performance. While Award has designed the custom BIOS to maximize performance, the manufacturer has the right to change these defaults to meet its needs.

Set Supervisor/ User Password Changes, sets, or disables password. It allows you to limit access to the system and the Setup Program.

Save & Exit Setup Saves value changes to CMOS and exits setup.

Exit Without Saving Abandons all CMOS value changes and exits setup.

Standard CMOS Features

The items in Standard CMOS Setup Menu are divided into 10 categories. Each category includes one or more setup items. Use the arrow keys to highlight the item and then use the <PgUp> or <PgDn> key to select the desired value in each item.

Phoenix - Award WorkstationBIOS CMOS Setup Utility Standard CMOS Features

		Item Help
Date (mm :dd :yy)	Wed. Jan 01 2003	Menu Level ▶ Change the day, month, year and century
Time (hh :mm:ss)	11 : 1 : 35	
▶ IDE Primary Master	[Press Enter 4303 MB]	
▶ IDE Primary Slave	[None]	
▶ IDE Secondary Master	[None]	
▶ IDE Secondary Slave	[None]	
Drive A	[1.44M, 3.5 in.]	
Drive B	[None]	
Video	[EGA/VGA]	
Halt on	[All, but keyboard]	
Base Memory	640K	
Extended Memory	30720K	
Total Memory	31744K	

↑↓→←Move Enter: Select +/-PU/PD : Value F10 : Save ESC : Exit F1 :General Help
F5 : Previous Values F6 : Fail-Safe Defaults F7 : Optimized Defaults

(Note : The figures of BIOS Setup Menu included here only show a typical case, and may not be exactly the same as the one on your unit.)

Date	The date format is <day-of-the-week>. <month> <day> <year>.
Time	The time format is <hour> <Minute> <second> displayed in 24-hour military-time clock. For example, 1 p. m. is displayed as 13:00:00.
Primary Master/Primary Slave/Secondary Master/Secondary	These categories identify the types of the two channels that have been installed in the computer. If the controller of the HDD interface is SCSI, the selection shall be "None".
Drive A Type / Drive B Type	This category identifies the types of floppy disk drive A or drive B that has been installed in the computer.
Video	The default setting is EGA/VGA.
Halt on	You can select which type of error will cause the system to halt.

Advanced BIOS Features

This section allows you to configure your system for basic operation. You have the opportunity to select the system's default speed, boot-up sequence, keyboard operation, shadowing and security.

Advanced Chipset Features

The Chipset Features Setup option is used to change the values of the chipset registers. These registers control most of the system options in the computer.

This section allows you to configure the system based on the specific features of the installed chipset. This chipset manages bus speeds and access to system memory resources, such as DRAM and the external cache. It must be stated that these items should not be altered. The default settings have been chosen because they provide the best operating conditions for your system.

Integrated Peripherals

The Integrated Peripherals Setup allows the user to configure the onboard IDE controller, floppy disk controller, the printer port and the serial ports.

Power Management Setup

The Power Management Setup Menu allows you to configure your system to most save energy while operating in a manner consistent with your own style of computer use.

PNP/PCI Configurations

This section describes how to configure the PCI bus system. This section covers some very technical items and it is recommended that only experienced users should make any changes to the default settings.

PC Health Status

The PC Health Status display CPU and Case Fan Speed.

Frequency/Voltage Control

This section allows you to set CPU Speed.

Set Supervisor/User Password

You can set either supervisor or user password, or both of them. The difference between them are:

- Supervisor Password :** You can enter the Setup Program and change the options of the setup menus.
- User Password :** You can enter the Setup Program but can not change the options of the setup menus.

When you select this function, the following message will appear at the center of the screen to assist you in creating a password.

ENTER PASSWORD:

Type the password, up to eight characters in length, and press<Enter>. The new password will clear the previously entered password from the CMOS memory. You will be asked to confirm the password. Type the password again and press <Enter>. You may also press <Esc> to abort the selection and operate without a password.

To disable a password, just press <Enter> when you are prompted to enter the password. A message will be displayed to confirm that the password is disabled.

PASSWORD DISABLED.

Once the password is disabled, the system will reset and you can enter the Setup Program freely.

When a password is enabled, you will be prompted to enter it every time you try to enter setup. This prevents an unauthorized person from changing any setting of your system configuration.

In addition, when a password is enabled, you can require the BIOS to request a password every time your system is rebooted. This would further prevent unauthorized use of your computer.

The password requirement is defined by the Security Option of the BIOS Features Setup Menu. If the Security Option is set to "System", the password will be required both at resetting and at entering setup. If the option is set to "Setup", the prompt only appears when you try to enter setup.

Flash Update Procedure

A program AWDFLASH.EXE is included in the utility diskette or CD (X:\Utility\AWDFLASH.EXE). The user is recommended to follow the procedure below to update the flash BIOS.

(X: your CD driver letter).

1. Create a DOS-bootable floppy diskette. Copy the new BIOS file (just obtained or downloaded) and the utility program AWDFLASH.EXE to the diskette.
2. Allow the PC system to boot from the DOS diskette.
3. At the DOS prompt, key in

AWDFLASH
and hit <ENTER>

4. Enter the file name of the new BIOS.
5. The question: "Do you want to save BIOS (Y/N)?" is displayed.

*Key in "N" if there is no need to save the existing BIOS content.
Key in "Y" if a backup copy of the existing BIOS is needed.
(A file name has to be assigned to the existing BIOS binary file.)*

6. The message : "Press"Y" to program or "N" to exit." is displayed.

Key in "Y"

7. Wait until the flash-update is completed.
8. Power down the PC system.
9. Restart the PC.

Warning:

DO not turn off or RESET the computer during the flash process.

If you are unsure how to upgrade the BIOS, it is best to take your computer to an Authorized Service Center and have a trained technician do the work for you.

APPENDIX

Note to User:

The bundled driver CD attached an Auto-Run feature for all the drivers that the motherboard need. Please select the drivers that you want to install and click the button on the installation panel.